

NIST Construction Automation Program
Report No. 3
**Electromagnetic Signal Attenuation
in Construction Materials**

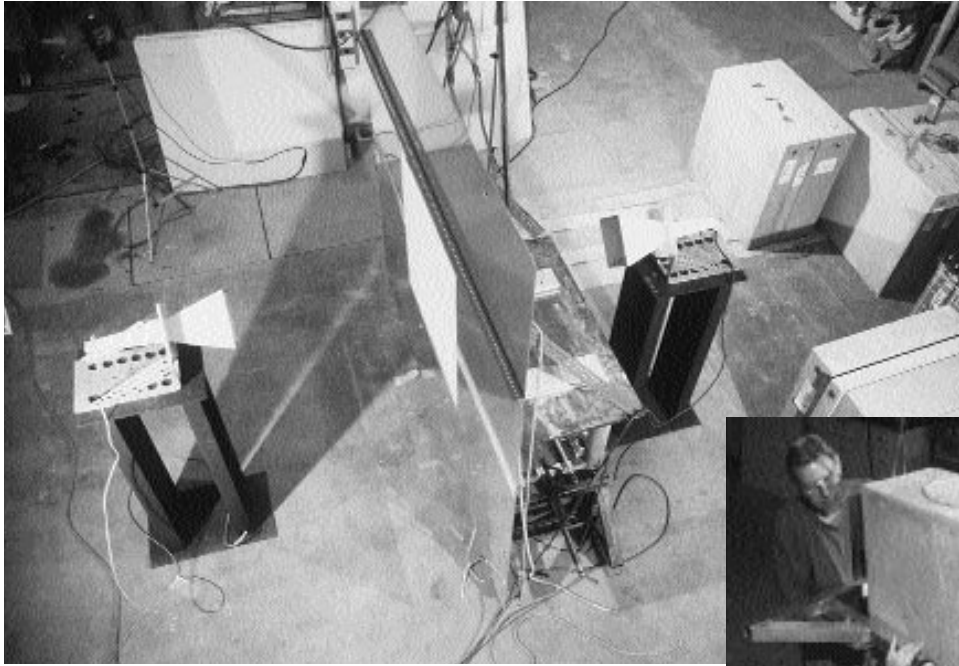

Building and Fire Research Laboratory
Gaithersburg, Maryland 20899



United States Department of Commerce
Technology Administration
National Institute of Standards and Technology



NIST Construction Automation Program
Report No. 3
**Electromagnetic Signal Attenuation
in Construction Materials**

William C. Stone

October 1997
Building and Fire Research Laboratory
National Institute of Standards and Technology
Gaithersburg, Maryland 20899



U.S. Department of Commerce
William M. Daley, *Secretary*
Technology Administration
Gary R. Bachula, *Acting Under Secretary for Technology*
National Institute of Standards and Technology
Robert E. Hebner, *Acting Director*

**Other Titles in the NIST
Construction Automation Series**

Non-Line-of-Sight Construction Metrology
NISTIR-5825, February 1996, 230 pp
Author: William C. Stone

Proceedings of the NIST Construction Automation Workshop
March 30-31, 1995
NISTIR-5856, May 1996, 158 pp.
Editor: William C. Stone

To order any of these, you may contact the National Technical
Information Service or write NIST directly at

Construction Automation Group
Building 226/B168
NIST
Gaithersburg, MD 20899
Tel: 301-975-6048
Fax: 301-869-6275

or via email to
william.stone@nist.gov
lawrence.pfeffer@nist.gov

ABSTRACT

Laboratory studies of electromagnetic (EM) signal propagation through construction materials were carried out as part of the NIST initiative in Non-Line-of-Sight surveying technology. From these data it is possible to determine several important material-specific characteristics needed for the design of engineering systems which make use of EM signal propagation through matter: 1) the power attenuation as a function of the material thickness and 2) the values of the electrical permittivity and dielectric constants for a particular material as a function of frequency. The latter can be used to calculate the propagation delay time associated with an EM pulse penetrating through a specified thickness of a given material. This information is essential for error compensation for time-of-flight metrology instrumentation systems. In this report, only the power attenuation aspects are discussed; dielectric and permittivity constants will be discussed in a future volume. The materials investigated included brick, masonry block, eight different concrete mixes, glass, plywood, lumber (spruce-pine-fir), drywall, reinforced concrete, steel reinforcing bar grids, variations of the plywood and lumber tests in which the specimens were soaked with water, and composite specimens involving brick-faced masonry block and brick-faced concrete. For each material, varying thickness specimens were fabricated in order to measure attenuation as a function of penetration distance. Each specimen was placed in a special test range consisting of spread spectrum transmission and reception horns spaced 2 meters apart with a metal RF isolation barrier located midway between the antennas to eliminate multipath signals. The isolation barrier contained a window at its center against which the specimens were fit. Measurements of power loss were taken at 2 MHz intervals from 0.5 to 2 GHz and from 3 to 8 GHz. Frequency power spectra were discretely generated for each material as a function of thickness and fit with closed-form predictor equations. Coefficients for the predictor equations are provided.

KEYWORDS: building technology; construction materials; electromagnetic wave propagation; metrology, non-line-of-sight metrology, signal attenuation, spread spectrum radar, surveying, wireless communications.

Table of Contents

Abstract	iii
Table of Contents	v
Acknowledgement	vii
1.0 Introduction	1
1.1 Background	1
1.2 Approach	2
1.3 Objectives and Scope	3
2.0 Experiment Description	5
2.1 RF Transmission System	5
2.2 Antenna Descriptions	14
2.2.1 “Low” Frequency Bandwidth (0.5 to 2.0 GHz)	15
2.2.2 “High” Frequency Bandwidth (3.0 to 8.0 GHz)	19
2.3 Test Fixtures	21
2.4 Specimen Design	24
2.5 Test Protocol	24
2.6 Post-Processing Procedures	26
3.0 Material Properties and Specimen Geometry	29
3.1 Brick	32
3.2 Masonry Block	37
3.3 Plain Concrete	42
3.4 Reinforced Concrete and Rebar Grid	47
3.5 Glass	49
3.6 Lumber	52
3.7 Plywood	56
3.8 Drywall	59
4.0 Frequency Power Spectra	61
4.1 Brick	63
4.2 Brick-Faced Concrete Wall	69
4.3 Brick-Faced Masonry Block	75
4.4 Plain Concrete: Mixture 1	81
4.5 Plain Concrete: Mixture 2	87
4.6 Plain Concrete: Mixture 3	93
4.7 Plain Concrete: Mixture	99

4.8 Plain Concrete: Mixture 5	105
4.9 Plain Concrete: Mixture 6	111
4.10 Plain Concrete: Mixture 7	117
4.11 Plain Concrete: Mixture 8	123
4.12 Masonry Block	129
4.13 Drywall	135
4.14 Glass	141
4.15 Lumber (Dry)	147
4.16 Lumber (Wet)	153
4.17 Plywood (Dry)	159
4.18 Plywood (Wet)	165
4.19 Reinforced Concrete	171
4.20 Rebar Grid	177
5.0 Summary	182
6.0 References	185
Appendix A: MatLab Scripts	A.1

Acknowledgement

The author would like to thank several researchers at M.I.T. Lincoln Lab, including Dennis Blejer, Steven Scarborough, and Carl Frost, for their assistance with this project. Their patience, and willingness to discuss at the chalk board, and via endless faxes and email correspondences, fundamental theory and general “rules of thumb” relating to radar and electromagnetic wave propagation through matter have contributed significantly to the present document. Thanks are also due to Thomas F. Rogers, a distinguished electrical engineer and communications pioneer, for his thoughts on the subject of EM penetration of matter. Lastly, the author thanks NIST technician Erik Anderson and visiting summer researcher Jose Ortiz for their invaluable assistance in the laboratory.



Left to Right: NLS Phase 2 Research Team: Carl Frost, Bill Stone, Steve Scarborough, and Dennis Blejer.

1.0 Introduction

1.1 Background

The NIST program in Construction Automation seeks to develop, integrate, and implement new technologies which will permit generalized automation at the construction job site. Research is presently focused on methods and standards for closing the information loop from the job site to a central dynamic, evolving project database, and returning information from that database in an on-demand, real-time format to a wide variety of users at the construction site. Current research includes the development of a real-time, non-line-of-sight surveying system that can “see through walls;” the development of the National Construction Automation Test Bed for testing various automation mechanisms, standards, and software; the development of kinematic representation standards for construction machinery and components; and the development of standards for wireless data telemetry packets for transmission of information from the active job site to a high bandwidth trunk line which links the various project participants.

Each of the above research areas leverage upon the rapid advance of information technology and infrastructure that has occurred during the last decade and is still continuing. The emergence of high speed computer communication networks (the “information superhighway”) and real-time, immersive, computer graphics (virtual reality) technologies presage the imminent ability to manage remote con-

struction sites from central offices; to automate certain portions of the tasks performed by common construction machines; and to provide information on the state of such machines to operators (on-site or remote) that would greatly enhance their productivity.

In order to achieve real automation in the construction industry, a standard means of rapidly interfacing any piece of machinery to a construction-site database must be developed. The development of this standard is highly unlikely to be addressed by the construction industry itself, where corporate research budgets are small in the United States. Nor will it be developed by equipment manufacturers who, left to their own devices, tend to develop closed, proprietary systems which by their very nature inhibit the free exchange of data with other systems that might be operational at a construction site. In this respect, NIST has been uniquely positioned, as a neutral entity, to establish the framework for the integration of construction machinery into emerging global database standards. The underpinning to the above technology is the ability to know the real-time position of any piece of equipment and component on the construction site. Present surveying tools suffer from many shortcomings in this regard, the most important of which is that they must operate under line-of-sight conditions. The development of a non-line-of-sight surveying system, which can in effect “see through walls”, represents the pinnacle

of construction site metrology and has guided the focus of NIST research in Non-Line-of-Sight (NLS) metrology.

Tests conducted at NIST from 1994 through 1997 proved the potential of NLS technology to meet the above objectives [1, 2, 3]. If the technology can be brought to practical implementation the implications are profound. Briefly summarized, the technology involves the use of ultra-wide bandwidth spread spectrum radio signals which are beamed through non-metallic construction materials as a series of sequential, discrete frequencies. The same approach applies equally well to an impulse baseband transmission. A time-domain response is reconstructed from the frequency power spectrum and the time of flight from transmitter to receiver is calculated by comparing the measured response to a free-space calibration between two or more known points. Problems arise, however, due to reduced propagation velocities when penetrating solid media. This leads to a delayed arrival of the straight-line (true distance) transmission pulse, thereby producing error in the calculated range relative to free space propagation.

Other errors arise from scattering (dispersion) of the beam, refraction, and multipath reflections as well as instrumental error. However, it was demonstrated, by means of qualitative tests in 1994 [1] and by extensive quantitative tests in 1996 [2], that most common construction materials behave as non-conductors and can therefore be successfully penetrated for substantial distances, thereby allowing range measurement. To be more emphatic, unless the building is constructed with

seamless metal walls distance measurements are feasible (see [1] for further details).

1.2: Approach

Although proof-of-concept data obtained in 1995 was very encouraging, the accuracies obtained were far from those needed to be practical for machine automation purposes. They were, however, sufficient for other applications, such as personnel tracking in unstructured environments.

Typical propagation delay errors when penetrating a 500 mm thick slab of concrete were on the order of 800 mm. The measured distance was thus 800 mm longer than the true distance between the transmitter and receiver. This error was not affected by the range between the transmitter and receiver, thus confirming that most of the error was attributed to the slower phase velocity of the signal as it propagated through the concrete. Thus, a clear path was identified by which the phase propagation error could be compensated. Briefly the approach involves:

- 1) The development of empirically based statistical models of the electromagnetic characteristics for a large class of construction materials at varying frequencies of transmission and
- 2) A method by which a real-time mathematical model of the construction site (in the form of CAD solid model elements) can be updated with sufficient robustness to reflect the as-built condition of the site and the material specification of the various components.

Given this foundation it is possible to develop a software algorithm which takes into account the site geometry and material properties and predicts the delay in the arrival of the transmitted pulse due to propagation through engineering materials between the transmitter and receiver. In a more sophisticated variant of this approach all of the physical phenomena associated with wave propagation (including scattering, constructive and destructive interference, reflection, and diffraction) may be taken into account and the result used to correct the initial measurement. With sufficient local processing power (in the form of a low power parallel processor array) such compensations could be made in a kinematic sense with update rates in excess of the 10 to 20 Hz commonly associated with real-time machine control.

Work in 1996 and 1997, which forms the basis of this paper, concentrated on defining propagation and error characteristics of spread spectrum signal penetration through construction materials as a function of the type of material (e.g. glass, concrete, wood etc.), frequency bandwidth, power, signal-to-noise ratio (and techniques, both physical and analytical for improving same), and obstacle geometry.

The resulting experimental data -- which encompass behavior across 8 GHz of bandwidth and comprise one of the most complete sets of information concerning electromagnetic (EM) attenuation in construction materials -- form the basis for the development of auto-compensation algorithms which will account for propagation delays as the signal passes through different materials. It is the

propagation delay component that accounts for most of the range error.

Ongoing research is being directed to developing a range-error compensation model based on non-dispersive ray tracing techniques, which heretofore have largely been used for computer graphics rendering and intra-building cellular phone base station coverage simulators. In this work, CAD models of simulated construction sites are being developed and material characteristics, based on the extensive empirical EM material data reported herein, are being attached to entities in the CAD model. This model will be used to estimate range error in calculated position determined using the NLS system. It will thus allow conclusions to be drawn concerning the accuracy achievable through NLS, and its limitations and possibly will identify avenues for further resolution enhancement. The more complex phenomenon of EM wave propagation in dispersive media will be addressed in future research.

1.3 Objectives and Scope

From the data presented in this report it is possible to determine several important material-specific characteristics needed for the design of engineering systems which make use of EM signal propagation through matter: 1) the power attenuation as a function of the material thickness and 2) the values of the electrical permittivity and dielectric constants for a particular material as a function of frequency. The latter can be used to calculate the propagation delay time associated with an EM pulse penetrating through a specified thickness of a given material. This information is essential for

error compensation for time-of-flight metrology instrumentation systems. In this report, only the power attenuation aspects are discussed; dielectric and permittivity constants will be discussed in a future volume.

Because of the unique fashion in which the spread spectrum signal was constructed -- using discrete 2 MHz continuous wave (CW) response steps -- data were able to be acquired which represent the affect on the transmitted signal when it penetrates and is re-transmitted beyond a broad sampling of materials and thicknesses for a very wide range of frequencies. The bandwidth investigated extends from 500 MHz through 8 GHz. Because this amply covers, and extends both well beyond and below, the frequencies allocated for use in mobile and personal communications equipment, as well as for certain RF based positioning equipment (most notably GPS), it was felt that this data would be of wide use to engineers designing such communications systems.

As such, efforts have been made to limit the theory and background derivations related to non-line-of-sight metrology in this report. For those interested in further information on the NIST programs in construction automation, and NLS metrology in particular, please refer to [Stone, 1996[1], and Stone, 1996[2]]. The data acquired from the tests described in Chapter 2 was in the form of calibrated frequency voltage spectra, that is, complex data in the frequency domain containing both in-phase and quadrature components of the received signal for each discrete step in frequency. There are many ways of presenting these data. For

purposes of illustration and trend we have included in this report plots of signal attenuation (in dB) relative to free space propagation as a function of frequency for all of the materials and thicknesses investigated. The manner in which these were developed is discussed in Chapter 2. Simplified closed-form regression equations are provided as a means of quickly categorizing the response of a particular material over a wide range of frequencies.

These power spectra can also be used to derive empirical values for range error (propagation delay time), and the material constants of permittivity and conductivity as a function of both frequency and material thickness. The derivation and presentation of these latter values will be discussed in a future paper.

A large amount of data was acquired in this experimental program. A total of 1220 tests were conducted (610 in the band between 0.5 and 2.0 GHz and 610 in the band between 3 to 8 GHz). The frequency domain and time domain data (resulting from a chirp-Z transform of the frequency data) comprise approximately 600 megabytes on digital media. Various post-processing techniques (gating in the time domain to reduce multipath phenomena, and averaging of the results both while sampling in the frequency domain and between ten duplicate tests conducted at slightly different spatial positions on the same specimen) were used to produce the smoothed frequency spectra provided in this report. The smoothed data (both time and frequency) can be compressed into 59 Mbytes. Requests for digital copies of this data should be sent to the internet address listed at the beginning of this document.

2.0 Experiment Description

2.1 RF Transmission System

The NLS measurement system was based on a modification of an ultra-wideband synthetic aperture radar. The modification made to the radar used for these tests was to operate the radar in bistatic mode and to collect one-way transmission data. The radar used separate transmit and receive antennas that were directed at each other at a distance of 2 m [Blejer, 1995 (2)].

In this study the receiving antenna comprised a roving unit that was located on the opposite side of the material target. In this sense, it was “cooperatively” working with the system, receiving the transmitted signal as opposed to the reflected signal. The microwave transmission system was based on a Hewlett-Packard HP8530* network analyzer/microwave receiver combined with an HP 83623A frequency synthesizer, HP 8511A frequency converter, and an HP 85330A multiple channel controller. A 486 PC-based computer network performed radar control functions, while data calibration and data management were handled with a Pentium PC.

The wideband pulse modulators used for hardware gating and the computer software for system control and data process-

* Any mention of commercial products is for information only; it does not imply recommendation or endorsement by the National Institute of Standards and Technology nor does it imply that the products mentioned are necessarily the best available for the purpose.

ing were custom developed by Flam and Russell, Inc. of Horsham, PA. MIT Lincoln Lab developed the SAR imaging system (detailed in Figure 2.1.1) and processing software and cooperated with NIST researchers on all aspects of the laboratory research. The radar was field-portable with the electronics and computational hardware based in a mid-size van. Table 2.1.1 lists characteristics of this system. The unit is fully polarimetric and operates over two frequency bands (0.1-2 GHz and 2-18 GHz).

In order to measure distance through an obstruction (e.g. a concrete wall), two separate antennas are used, as shown in Figures 2.1.2, 2.1.3, and 2.1.5. The receiver becomes a “roving” unit whose position is to be determined. For the situation depicted in Figure 2.1.5 it is important to recognize that it is the time of flight, determined by performing a chirp-Z transform on the in-phase and quadrature components of the received frequency spectrum, that is being measured.

Table 2.1.1: RF Transmission System Characteristics

Frequencies	0.5-2 GHz, 2-18 GHz
Bandwidth	Antenna limited
Waveform	Gated CW
Pulse Width	10 ns to 500 ns
PRF	50 kHz to 5 MHz
Polarization	Fully polarimetric
Output Power	20 dBm
Dynamic Range	80 dB
Noise Floor	-100 dBm

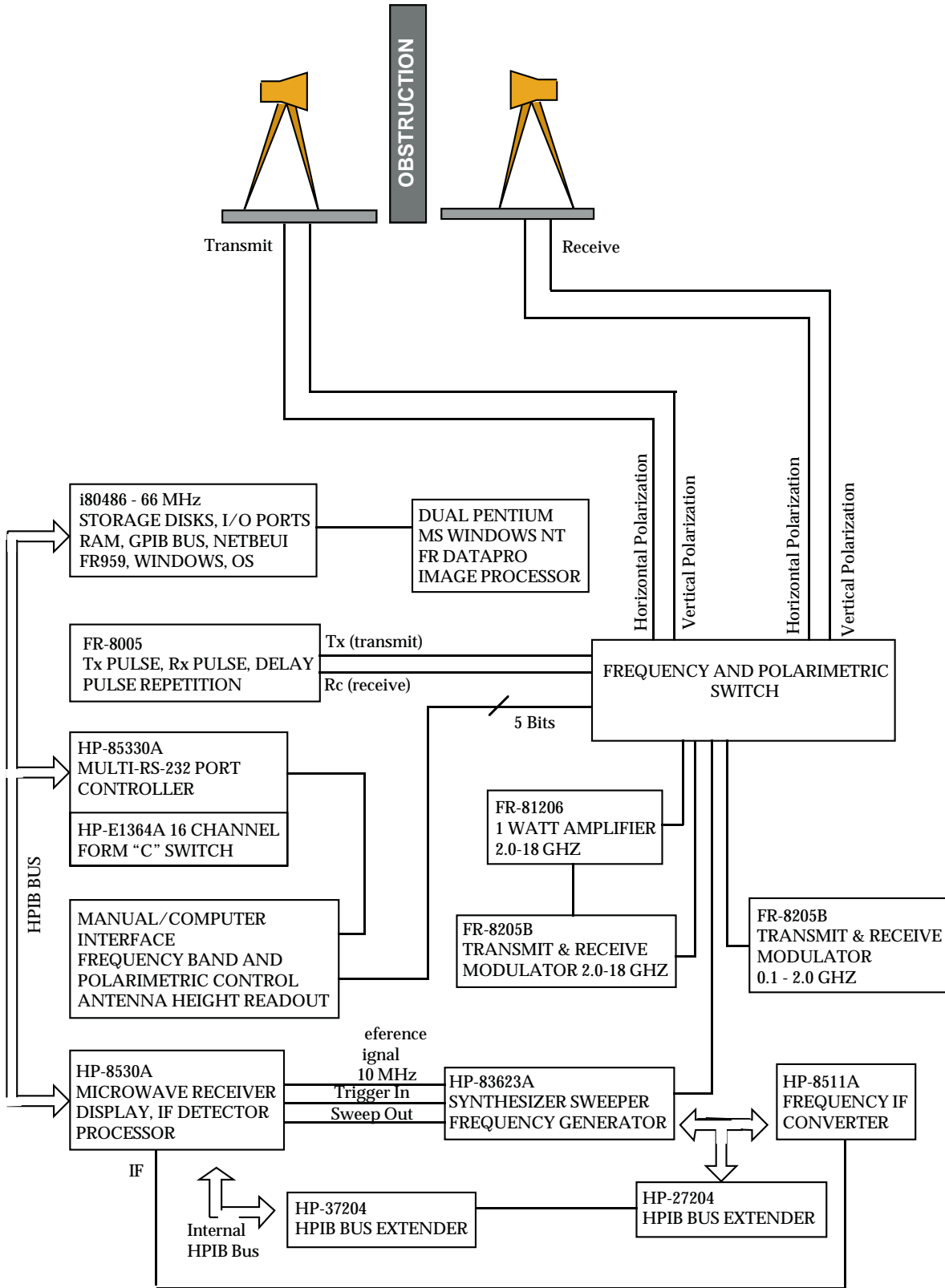

Figure 2.1.1: Schematic of the spread spectrum transmission system used for NLS research.

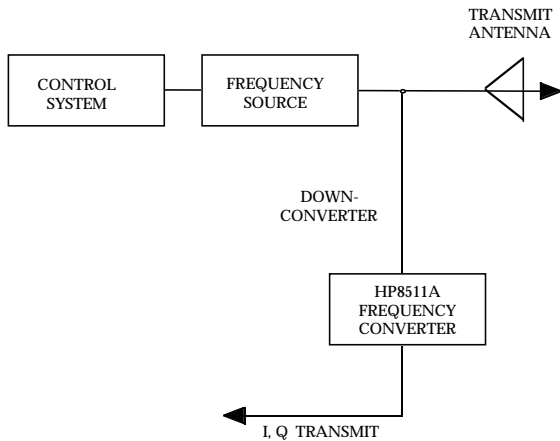

Figure 2.1.2: Simplified schematic of the transmission system and means for characterizing the transmitted signal.

The measured time of flight then converts directly to a straight line distance between the transmitter and receiver following the equality given by eq (2.1.1).

$$x = c \cdot \delta t \quad \text{eq(2.1.1)}$$

x = straight line distance (m)

c = speed of light in a vacuum, 3×10^8 m/s

δt = time of flight (s)

Equation (2.1.1) can determine only the straight line distance from the transmitting antenna to the roving antenna. In order to acquire a unique three dimensional position of the receiver at least three transmitters are required. The position can then be determined based on three dimensional triangulation. In such calculations it is assumed that precision (mm level) surveys will have been made to establish the benchmark positions of the transmitting antennas.

Returning now to the determination of time of flight, the following simplified summary will assist in helping to understand the NLS concept. Since accuracy is

of primary concern in the design of a precision surveying instrument it is discussed first. Position update rate is also of importance for those items requiring real-time feedback (e.g. automated operation of construction machinery). However, as will become evident, speed is primarily controlled by processor speed, which improves every year. Therefore, the approach discussed below, while designed primarily for accuracy, will nonetheless provide the algorithmic basis for real-time processing as local embedded microprocessors become faster.

Traditional imaging radars and scatterometers [4] make use of a swept frequency for the generation of a response spectrum. An alternative, discrete approach [5] was used for the NIST NLS studies. In this approach, the response of the system is obtained at individual continuous wave frequencies. The discrete step size is user-definable, but for the

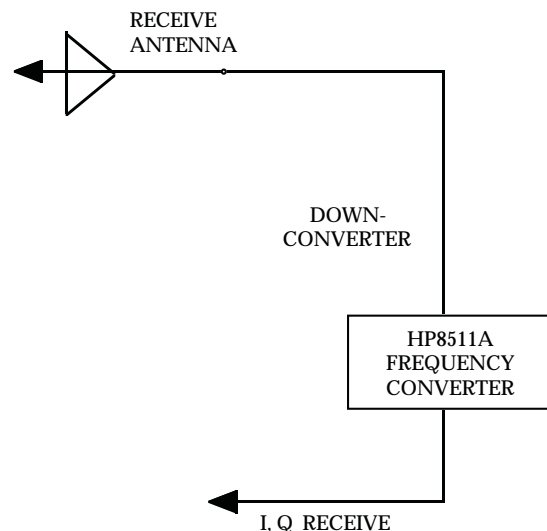

Figure 2.1.3: Simplified schematic of the receiver system and means for characterizing the received signal.

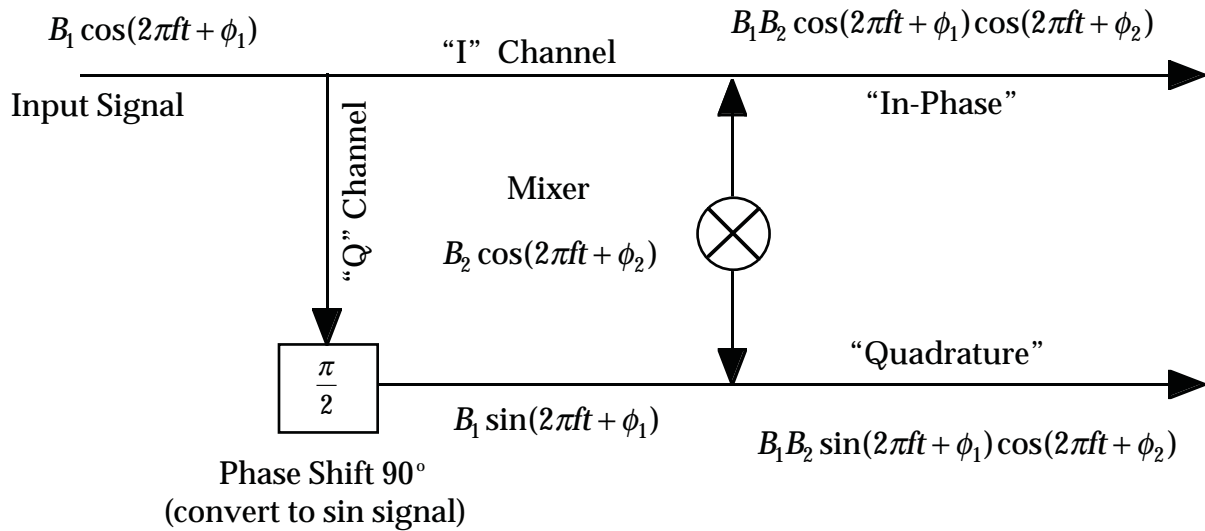

Figure 2.1.4: Schematic representation of a down conversion “mixer” used for quadrature detection in both the transmitted and received signals. In the NIST NLS tests, a common mixer oscillator was used as the reference for both signals.

NIST tests, 401 points were used for the 0.5 to 2.0 GHz experiments and 801 points for the 3.0 to 8.0 GHz experiments. This produced a frequency step size of approximately 3.74 MHz and 6.24 MHz, respectively.

Figure 2.1.2 is a schematic of the transmitter subsystem. In the actual system, the computer directs the HP-83623A to generate the specified frequency which is then amplified and sent to the transmission antenna. This same signal is also tapped to an RF-to-IF converter (HP-8511A) where the IF signal is sent to the network analyzer (HP-8530A) for signal detection. The magnitude and phase of the transmitted signal are extracted in a fashion following that depicted in Figure 2.1.4. This procedure is known as “quadrature” detection and can be thought of as a mixing operation that translates the received (tapped) signal to baseband to

recover amplitude and phase in the form of quadrature components.

The in-phase component (or “I” component) is created by multiplying the transmitted signal by a reference signal generated by the mixer oscillator. The input signal is defined as:

$$B_1 \cos(2\pi ft + \phi_1) \quad \text{Eq(2.1.2)}$$

The mixer reference signal, generated at the same frequency, but different amplitude and phase, is:

$$B_2 \cos(2\pi ft + \phi_2) \quad \text{Eq(2.1.3)}$$

The result of multiplying the two signals is:

$$B_1 B_2 \cos(2\pi ft + \phi_1) \cos(2\pi ft + \phi_2) \quad \text{Eq(2.1.4)}$$

Eq (2.1.4) can be expanded by means of standard trigonometric identities to yield:

$$B_1 B_2 \left(\begin{array}{l} \frac{1}{2} \cos(\omega t + \phi_1 - (\omega t + \phi_2)) \\ + \\ \frac{1}{2} \cos(\omega t + \phi_1 + (\omega t + \phi_2)) \end{array} \right) \quad \text{Eq (2.1.5)}$$

where the term ω , the circular frequency, is used interchangeably with the term $2\pi f$. By collecting terms this can be rewritten as Eq(2.1.6):

$$B_1 B_2 \left(\frac{1}{2} \cos(\phi_1 - \phi_2) + \frac{1}{2} \cos(2\omega t + \phi_1 + \phi_2) \right)$$

The first component in Eq(2.1.6) represents the DC signal or “bias” component and does not depend on frequency. It does, however, contain information relating to the phase difference between the input (transmitted) and reference signals.

In order to extract the first part, the composite signal is typically run through a low pass filter. The output from the low pass filter, for the in-phase component is:

$$\frac{B_1 B_2}{2} \cos(\phi_1 - \phi_2) \equiv I \quad \text{Eq (2.1.7)}$$

where the “I” is used to indicate that this term characterizes the real or “in-phase” component of the input signal. In a similar fashion the quadrature (or imaginary) component of the complex input signal

can be generated by phase shifting the input signal by $\pi/2$ radians. The resulting “quadrature” signal (after multiplication) is:

$$B_1 B_2 \left(\frac{1}{2} \sin(\phi_1 - \phi_2) + \frac{1}{2} \cos(2\omega t + \phi_1 + \phi_2) \right) \quad \text{Eq (2.1.8)}$$

Passing this signal through a low-pass filter yields the “quadrature” (or imaginary) component of the input signal as:

$$\frac{B_1 B_2}{2} \sin(\phi_1 - \phi_2) \equiv Q \quad \text{Eq (2.1.9)}$$

The transmitted signal, at the discrete frequency, f_0 , can now be completely characterized as:

$$S_T = I_T + jQ_T \quad \text{Eq(2.1.10)}$$

where

$$j = \sqrt{-1}$$

The transmit signal amplitude is:

$$A_T = \sqrt{I_T^2 + Q_T^2} \quad \text{Eq (2.1.11)}$$

The same procedure (quadrature detection) is applied to the received signal, as depicted in Figure 2.1.3. In this situation there is an important additional consideration in that, although we are transmitting continuously at the selected discrete frequency, f_0 , there may (and almost always will) be other components of the signal, with different phases, resulting from multipath reflections, refraction and

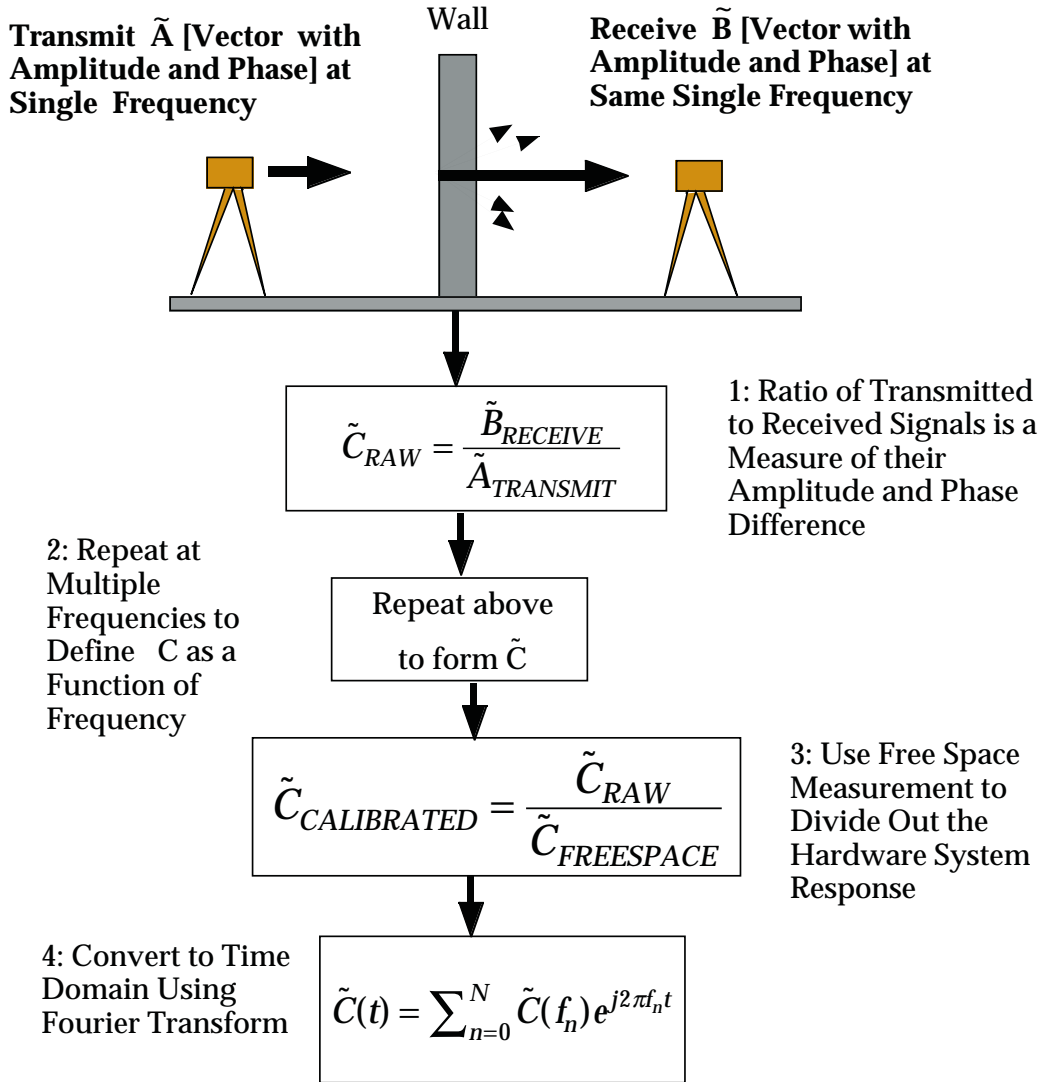

Figure 2.1.5: Impulse synthesis approach used in the NIST NLS tests. Composite signal with a bandwidth of 1.5 and 5 GHz, respectively, was achieved by recording the response for discrete single frequency transmissions. The composite time domain response was synthesized via chirp-Z transform from the discrete frequency response spectrum.

other dispersive phenomena. In order to reject out-of-band signals, the receiver is tuned to listen at the specified frequency, f_0 , by means of a narrow band pass filter. The band width typical of the NIST tests was ± 20 KHz. In the particular implementation described in Figure 2.1.3, the same mixer reference signal is used for quadrature detection as that shown in

Figure 2.1.2. The resulting complex description of the received signal is given by:

$$S_R = I_R + jQ_R \quad \text{Eq(2.1.12)}$$

At this point it will be useful to switch to phasor notation to describe the process by which the attenuation and phase

angle are derived. Phasor notation is based on the equality:

$$e^{j\theta} = \cos\theta + j\sin\theta \quad \text{Eq (2.1.13)}$$

Using this notation, the received signal is:

$$\begin{aligned} \tilde{B} &= B \cos(2\pi f_0 t + \phi_B) \\ &= \text{Real}\left(B e^{j(2\pi f_0 t + \phi_B)}\right) \\ &= \text{Real}\left(B e^{j\phi_B} e^{j(2\pi f_0 t)}\right) \end{aligned} \quad \text{Eq (2.1.14)}$$

and the transmitted signal is:

$$\begin{aligned} \tilde{A} &= A \cos(2\pi f_0 t + \phi_A) \\ &= \text{Real}\left(A e^{j(2\pi f_0 t + \phi_A)}\right) \\ &= \text{Real}\left(A e^{j\phi_A} e^{j(2\pi f_0 t)}\right) \end{aligned} \quad \text{Eq (2.1.15)}$$

The ratio of the received to transmitted signals, as depicted in Figure 2.1.5, is:

$$\tilde{C}_{\text{RAW}} = \frac{\tilde{B}}{\tilde{A}} = \frac{\text{received}}{\text{transmitted}} \quad \text{Eq (2.1.16)}$$

If we substitute Eqs(2.1.14 and 2.1.15) into Eq(2.1.16) we obtain:

$$\begin{aligned} \frac{\tilde{B}}{\tilde{A}} &= \frac{B e^{j\phi_B}}{A e^{j\phi_A}} \\ &= \frac{B}{A} e^{j(\phi_B - \phi_A)} \end{aligned} \quad \text{Eq (2.1.17)}$$

The amplitude ratio, B/A , in the above equation represents the attenuation of the signal as a result of propagation through a lossy medium. The ratio varies from 0.0 to 1.0 with 1.0 representing transmis-

sion in a vacuum (ideal transmission) and 0.0 representing complete attenuation (absorption and reflection) by the medium. The phase angle difference in the exponent is a measure of the time of flight between the transmitter and receiver, including dispersion-related group velocity effects as the signal propagates through engineering materials.

The mechanics needed to perform the division described in Eq(2.1.16) require the use of the following definitions, which make use of Eqs(2.1.13 and 2.1.17):

$$\begin{aligned} \frac{\tilde{B}}{\tilde{A}} &= \frac{B \cos\phi_B + jB \sin\phi_B}{A \cos\phi_A + jA \sin\phi_A} \\ I_R &= B \cos\phi_B \\ Q_R &= jB \sin\phi_B \\ I_T &= A \cos\phi_A \\ Q_A &= jA \sin\phi_A \end{aligned} \quad \text{Eq (2.1.18)}$$

From Eq(2.1.18) it is apparent that the values for I_R , Q_R , I_T , and Q_T can be determined via quadrature detection as expressed in Eqs(2.1.10 and 2.1.12) above. We can thus proceed directly to write that the ratio of received to transmitted signals is given by:

$$\frac{S_R}{S_T} = \frac{\tilde{B}}{\tilde{A}} = \frac{I_R + jQ_R}{I_T + jQ_T} \quad \text{Eq (2.1.19)}$$

Eq(2.1.19) represents a complex division of the form [6]:

$$\begin{aligned}\frac{A}{C} &= \frac{a + jb}{c + jd} \\ &= \frac{(ac + bd) + j(bc - ad)}{a^2 + b^2} \quad \text{Eq (2.1.20)} \\ &= \frac{(ac + bd)}{a^2 + b^2} + j\frac{(bc - ad)}{a^2 + b^2}\end{aligned}$$

The solution for the ratio of the received to transmitted signals, at the discrete frequency, f_0 , being investigated is:

$$\tilde{C}_{RAW} = \frac{S_R}{S_T} = \frac{\tilde{B}}{\tilde{A}} \quad \text{Eq (2.1.21)}$$

$$\begin{aligned}&\frac{(I_R I_T + Q_R Q_T)}{I_R^2 + Q_R^2} + j\frac{(Q_R I_T - I_R Q_T)}{I_R^2 + Q_R^2} \\ &= I_{RAW} + jQ_{RAW}\end{aligned}$$

As shown in Figure 2.1.5, this procedure is carried out for each discrete frequency of interest with the ultimate objective of building a discrete frequency response spectrum for a given bandwidth of interest. However, the results presented in Eq(2.1.21) represent **uncalibrated**, or “raw” data. There are a number of factors which need to be taken into account.

For free space measurements, the most important of the corrections involves deviations in the signal propagation velocity through the atmosphere. As previously discussed, the objective is to determine the time of flight of the signal from the transmitting antenna to the receiving antenna. The conversion to dis-

tance involves the velocity of electromagnetic radiation in the atmosphere, as given by Eq(2.1.1). Small errors in the determination of the propagation velocity can lead to measurable errors in the straight line distance estimate. Empirical correction factors have been derived for propagation of radio waves through the atmosphere as follows:

$$\begin{aligned}N &= \frac{77.6p}{T} + \frac{373000e}{T^2} \\ n &= 1 + \frac{N}{10^6} \quad \text{Eq (2.1.22)}\end{aligned}$$

$$c_{atmosphere} = \frac{c_{vacuum}}{n}$$

where

N=	scaled-up refractivity
p=	total pressure in millibars
e=	partial pressure of water vapor in millibars
T=	absolute temperature in degrees Kelvin
c_{vacuum} =	speed of light in a vacuum

In addition there are also errors which result from the internal electrical nature of the radar instrument. For example, the length and efficiency of the coaxial cables which connect the antennas to the system and the efficiency with which signals are propagated through the various electrical subsystems.

Fortunately, there is an elegant, and simple method for accounting for instrumental error, by means of a calibration procedure [5]. This involves the generation of

a point for point discrete response spectrum, using the same techniques outlined above, but with the important difference that the setup be a line of sight test over a known, precision surveyed bench. The bench consists of two benchmarks whose positions have been established relative to one another using standard total station surveying equipment. The resulting “freespace” response is used to calibrate the raw data by dividing the raw signal, at each discrete frequency, by the freespace result, as shown in Figure 2.1.5, following equation 2.1.23:

The freespace signal is defined as

$$\tilde{C}_{CALIBRATED} = \frac{\tilde{C}_{RAW}}{\tilde{C}_{FREESPACE}} \quad \text{Eq (2.1.23)}$$

where the notation is the same as previously used to describe the normalized in-

$$S_F = \tilde{C}_{FREESPACE} = I_F + jQ_F \quad \text{Eq (2.1.24)}$$

phase and quadrature components for the raw signal defined in Eq (2.1.21). The F subscripts in Eq(2.1.24) denote the freespace calibration. Equation 2.1.23 can now be re-written as Eq (2.1.25).

For the NLS tests conducted at NIST, the above calculations were performed in a post-processing mode since the data acquisition system was only designed to write one file at a time. Thus, the freespace response was always acquired prior to the commencement of any day’s testing. A second freespace measurement was made at the end of each day to determine any changes that might have

$$\tilde{C}_{CALIBRATED} = \frac{\tilde{C}_{RAW}}{\tilde{C}_{FREESPACE}} = \quad \text{Eq (2.1.25)}$$

$$\begin{aligned} & \frac{I_{RAW} + jQ_{RAW}}{I_{FREESPACE} + jQ_{FREESPACE}} = \\ & \frac{(I_{RAW}I_{FREE} + Q_{RAW}Q_{FREE})}{I_{RAW}^2 + Q_{RAW}^2} + \\ & j \frac{(Q_{RAW}I_{FREE} - I_{RAW}Q_{FREE})}{I_{RAW}^2 + Q_{RAW}^2} \\ & = I_{CALIBRATED} + jQ_{CALIBRATED} \end{aligned}$$

where

$$I_{RAW} = \left(\frac{(I_R I_T + Q_R Q_T)}{I_R^2 + Q_R^2} \right)_{RAW}$$

$$Q_{RAW} = \left(\frac{(Q_R I_T - I_R Q_T)}{I_R^2 + Q_R^2} \right)_{RAW}$$

$$I_{FREE} = \left(\frac{(I_R I_T + Q_R Q_T)}{I_R^2 + Q_R^2} \right)_{FREE}$$

$$Q_{FREE} = \left(\frac{(Q_R I_T - I_R Q_T)}{I_R^2 + Q_R^2} \right)_{FREE}$$

occurred during the day. Subsequent to the freespace measurement, raw experimental data files were created for each material test following Eq(2.1.21). The final calibration, following Eq(2.1.25), was performed as part of an automated MatLab post-processing script that operated on all data files. The MatLab scripts

used for this process are listed in Appendix A and were written for a PC running Windows95.

The calibrated response spectra were stored as a 5 x n matrix, where n was the number of discrete frequencies sampled. As previously described, 401 evenly spaced points were acquired for the 0.5 to 0.9 GHz tests and 801 points were acquired for the 3.0 to 8.0 GHz tests. For each frequency, the I and Q values ($I_{CALIBRATED}$ and $Q_{CALIBRATED}$ as per Eq.2.1.25) are stored in the second and third columns respectively. The fourth column contains the derived calibrated, which is calculated as:

This is a decimal value between 0.0 and 1.0, with 1.0 meaning that there was no attenuation observed during the test for which a material specimen was placed

$$A_{CALIBRATED} = \quad \text{Eq (2.1.26)}$$

$$\sqrt{I_{CALIBRATED}^2 + Q_{CALIBRATED}^2}$$

between the transmitter and receiver, relative to the same freespace test. The decimal amplitude may easily be converted to decibels (dB):

$$A(\text{dB})=20*\log_{10}(A[\text{decimal}]) \quad \text{Eq(2.1.27)}$$

In addition, the phase angle (radians) for the calibrated response signal is stored in the fifth column in each calibrated data file. The phase angle is:

In the attenuation versus frequency plots presented later in the report the frequency (in GHz) is plotted on the x-axis while both the decimal and dB versions of

$$\phi_{CALIBRATED} = \tan^{-1}\left(\frac{Q_{CALIBRATED}}{I_{CALIBRATED}}\right) \quad \text{Eq (2.1.28)}$$

Eq(2.1.26) are plotted on the y-axis. Efforts have been made to fit simplified polynomial functions to these curves for the purposes of characterizing the attenuation characteristics of a broad range of materials over a wide frequency bandwidth while maintaining a manageable and compact means for accessing that data. For those who desire the original digital record sets, see the earlier instructions regarding request submissions to NIST.

2.2 Antenna Descriptions

Two antenna geometries were used for this test program. The first, originally manufactured by Watkins-Johnson and now fabricated by Condor Systems, had a bandwidth of 1.5 GHz between 0.5 and 2.0 GHz. The second, manufactured by Flam and Russell, had a bandwidth of 5 GHz from 3.0 to 8.0 GHz. Where polarization capability existed, the V-V polarization configuration was employed for the NIST tests, as initial studies [1] clearly indicated that multipath distortion due to ground bounce was minimized through the use of a vertically polarized plane wave transmission. This polarization setting was not important to the tests described herein because of the presence of a multipath shield (see Figure 2.3.1).

2.2.1 “Low” Frequency Bandwidth (0.5 to 2.0 GHz)

A dual-polarized Quad-Ridged Horn antenna, model WJ-48450 from Watkins-Johnson (Table 2.2.1 and Figures 2.2.1 through 2.2.2), was used for the NIST experiments. This unit has a frequency coverage of 0.5-2 GHz. These antennas provide high-gain directional patterns over multi-octave bandwidths. Each pyramical horn has two orthogonally placed input feeds which provide the capability for horizontal and vertical polarization. For the attenuation tests reported herein, only the vertical polarization was used. A typical implementation is shown in Figure 2.2.3, where attenuation and distance measurements are being taken for a composite specimen consisting of three back-to-back brick walls.

Typical radiation patterns for the WJ-48450 are provided in Figures 2.2.4 through 2.2.7. Figures 2.2.4 and 2.2.5 present the measured magnitude (in dB) as a



Figure 2.2.1: Quadridged 0.5 to 2.0 GHz . Vertical polarization, used for NIST tests, used only the two central vertical ridges.

function of the azimuth angle (zero degrees = straight ahead) for the E-plane and H-plane, respectively, at a reference frequency of 0.5 GHz, that is, the limiting lower frequency of the horn. Similar data are given in Figures 2.2.7 and 2.2.8 for the upper, 2.0 GHz design limit of the horn.

Table 2.2.1: Specifications for 0.5 to 2.0 GHz antenna use for “Low” Bandwidth Tests.

Product Specification	AS-48450
Frequency	0.5 to 2.0 GHz
Polarization	Simultaneous horizontal and vertical
Gain	6 to 12 dBi
Beamwidth, 3dB(BW)	70° to 25°, nominal
Beam squint (3 dB bisector)	5°, maximum
Cross polarization	-15 dB, maximum
Isolation between ports	20 dB, minimum
Maximum input power, each connector	70W CW, 3kW peak
RF connectors	Type N female
Impedance	50W reference
VSWR	3:1, maximum
Size	444 mm square,
	533 mm long (maximum)
Weight	15 kg

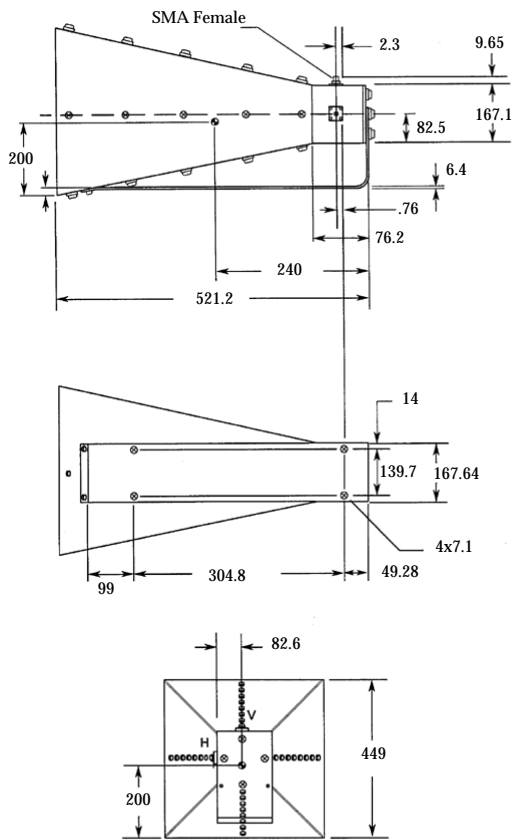

Figure 2.2.2: Side, Bottom, and End Views, top to bottom, respectively, for the WJ-48450, 0.5 to 2.0 GHz antenna (Condor Systems, 1996).

These figures demonstrate the relatively broad area illumination provided by this design. Although signal power is reduced by approximately one half (3dB) by an azimuth angle of 30 degrees to either side of center, considerable signal strength can still be measured at azimuth angles of 90-degrees. Because of the relatively different radiation pattern geometry for this antenna, as contrasted with that for the 3.0 to 8.0 GHz diagonal horn described below, results presented later in this report will be antenna specific. Researchers wishing to draw general conclusions over the entire frequency band investigated in this report should take into account both the test geometry (also described below) as well as these radiation patterns.

2.2.2 “High” Frequency Bandwidth (3.0 to 8.0 GHz)

For tests in the range of 3.0 to 8.0 GHz FR6400 class range illumination horns from Flam & Russell, Inc. were used. These horn antennas produce radiation patterns with low sidelobe structure, nearly circularly symmetric beam, and nominally constant gain and beamwidth.

Figure 2.2.3 (Right): Experimental calibration of a composite wall consisting of three back-to-back 76 mm brick walls. The wall sections measure 1 meter square. Three millimeter aluminum panel in background served as a multi-path signal shield.

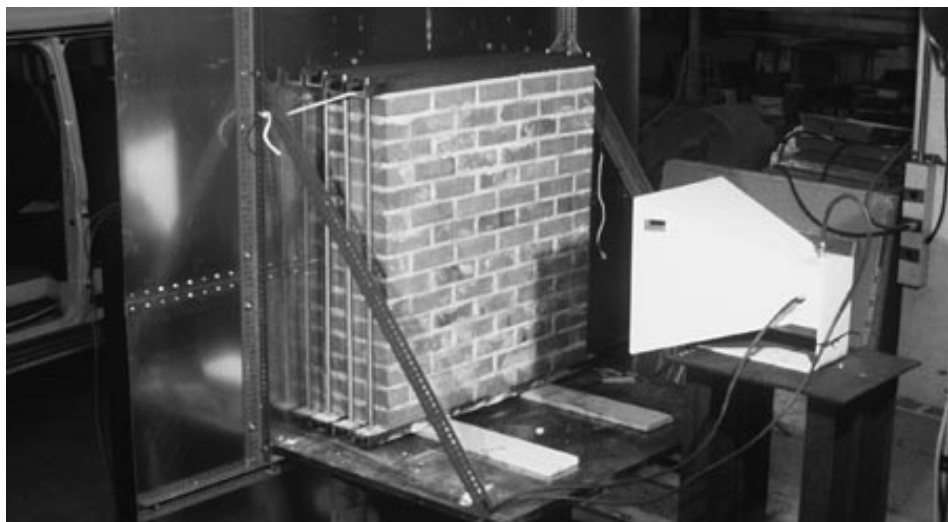

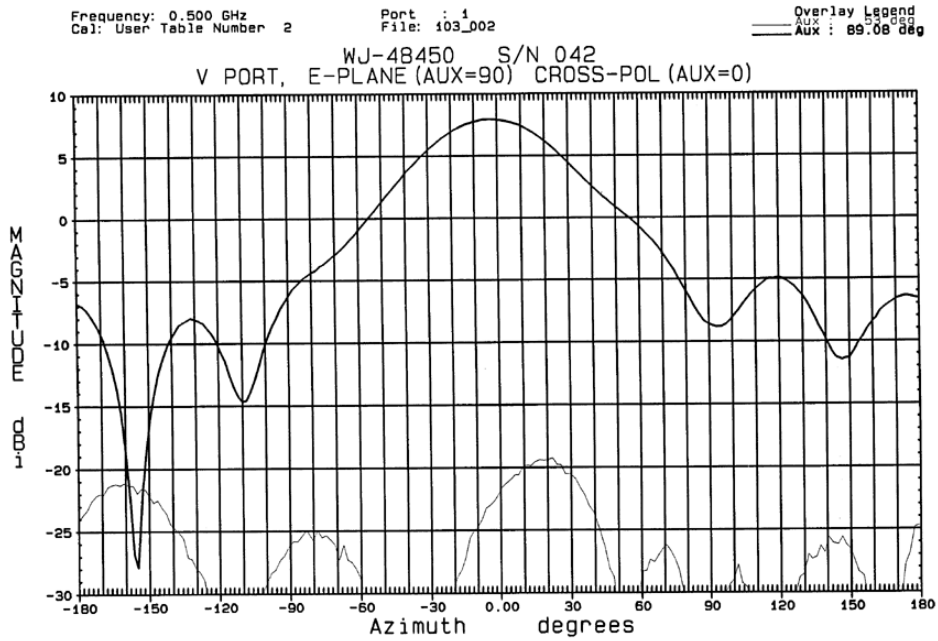

Figure 2.2.4: Typical E-Plane radiation pattern (Magnitude in dBi as a function of azimuth angle in degrees) for a WJ-48450 horn operating at the lower, 0.5 GHz, limit of its design spectrum (Condor Systems, 1996).

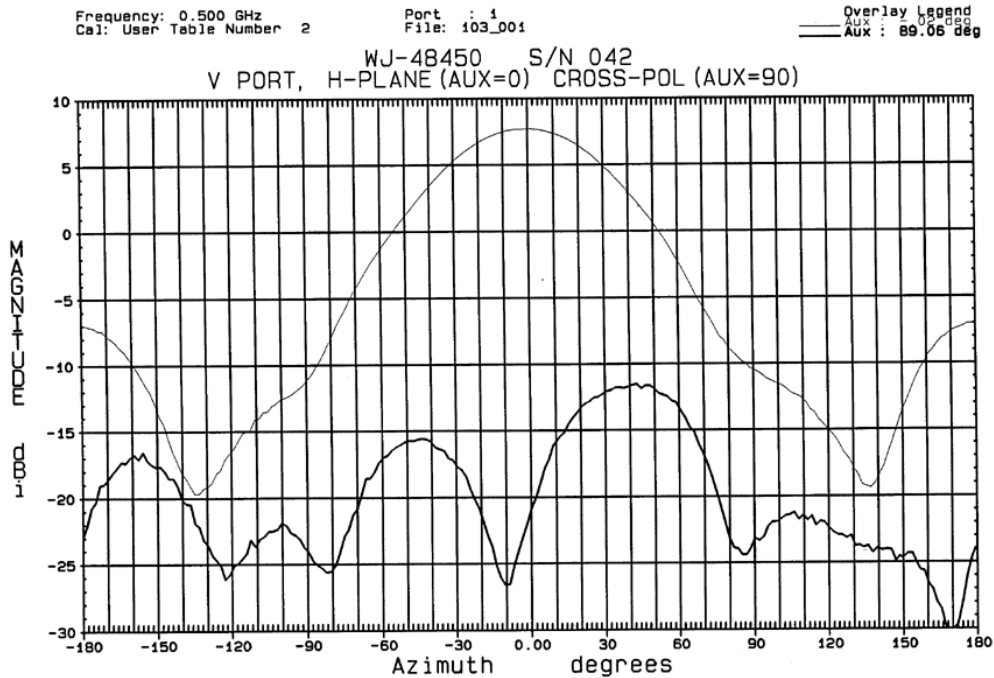

Figure 2.2.5: Typical H-plane radiation pattern (Magnitude in dBi as a function of azimuth angle in degrees) for a WJ-48450 horn operating at the lower, 0.5 GHz, limit of its design spectrum (Condor Systems, 1996).

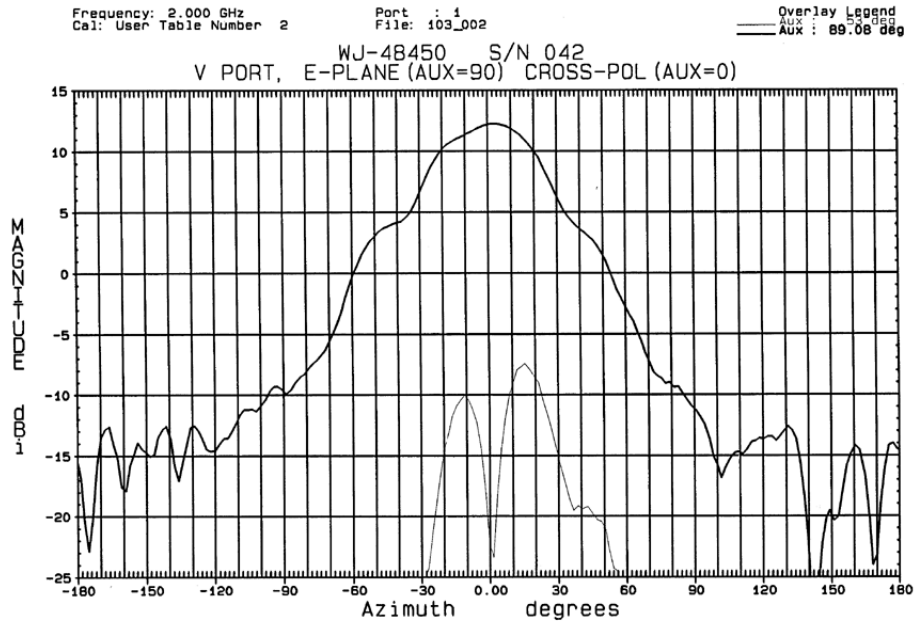

Figure 2.2.6: Typical E-plane radiation pattern (Magnitude in dBi as a function of azimuth angle in degrees) for a WJ-48450 horn operating at the high, 2.0 GHz, limit of its design spectrum (Condor Systems, 1996).

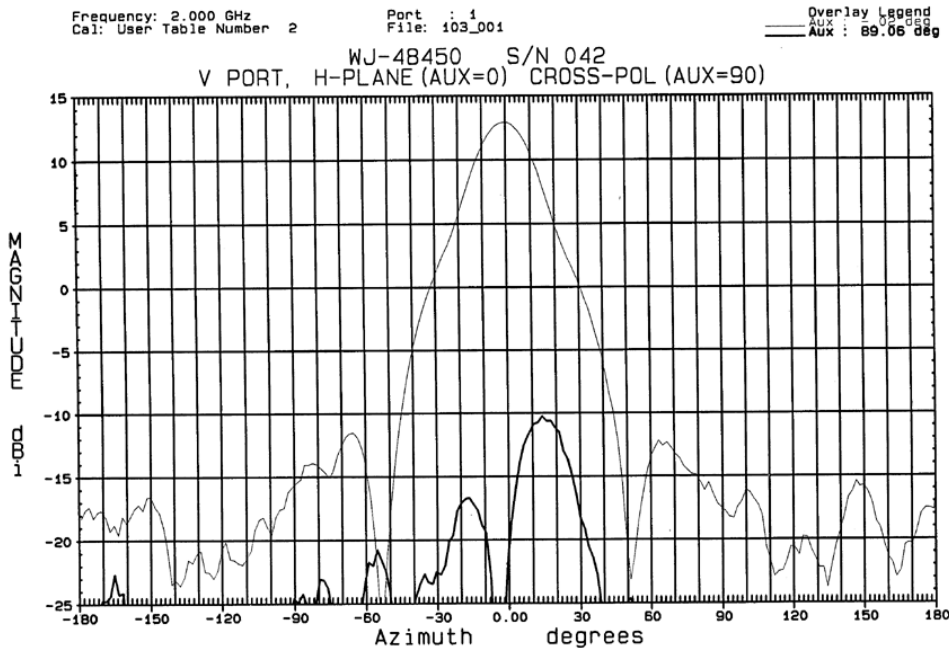

Figure 2.2.7: Typical H-plane radiation pattern (Magnitude in dBi as a function of azimuth angle in degrees) for a WJ-48450 horn operating at the higher, 2.0 GHz, limit of its design spectrum (Condor Systems, 1996).

The particular model used for the NLS tests was the FR-6415 3.0 to 8.0 GHz horn, which was designed to serve as a source antenna in the measurement of antenna radiation patterns or as transmit and receive antennas in the measurement of radar cross-section data. These antennas exhibit significantly reduced E-plane sidelobes typically associated with horn antennas. The FR-6415 incorporates aperture defocusing to produce minimal variations in gain and beamwidth over a frequency range of 2.5:1. Table 2.2.2 lists the pertinent manufacturer's specifications for this horn. Dimensions are given in Figure 2.2.2.1.

Table 2.2.2: Characteristics of Flam & Russell FR-6415 Diagonal Range Illumination Horn

Model Specification	FR-6415
Frequency (GHz)	3.0 to 8.0
Gain	1.7 dBi (nominal)
Beamwidth Level	17 degrees nominal
Sidelobe	-30 dB nominal
VSWR	2:1 maximum
Isolation	60 dB minimum
Aperture Width	261 mm
Overall Length	627 mm
Weight	4.77 kg
Input	SMA Female

FR-6415 at an operating frequency of 3.0 GHz. Similar data are presented in Figures 2.2.2.5 and 2.2.2.6 at 8 GHz.

Figure 2.2.2.2 shows a typical laboratory setup involving the FR-6415 in which the effect of a reinforcing bar grid on time-of-flight distance measurement is being conducted. A frequency response spectrum was generated from 3.0 to 8.0 GHz with this system.

2.3 Test Fixtures

Because of the large number of test specimens, and the representative full-size thicknesses used for the various materials, a test set-up was designed that made use of an indoor laboratory at NIST equipped with an overhead crane. The set-up is shown in isometric view in Figures 2.3.1 and 2.3.2 and in dimen

Figures 2.2.2.3 and 2.2.2.4 present E-Plane and H-Plane radiation patterns for the

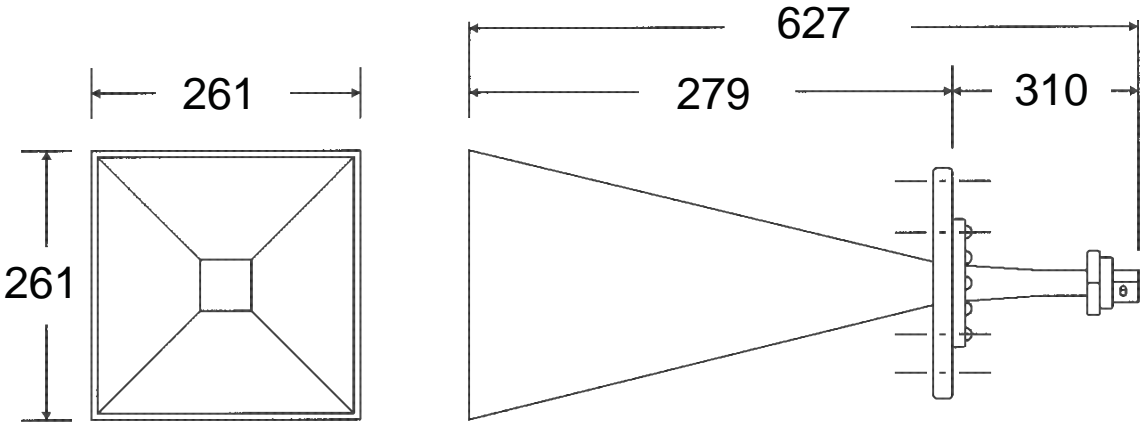

Figure 2.2.2.1: Dimensions of FR-6415 Diagonal Range Illumination Horn. All dimensions are in millimeters.

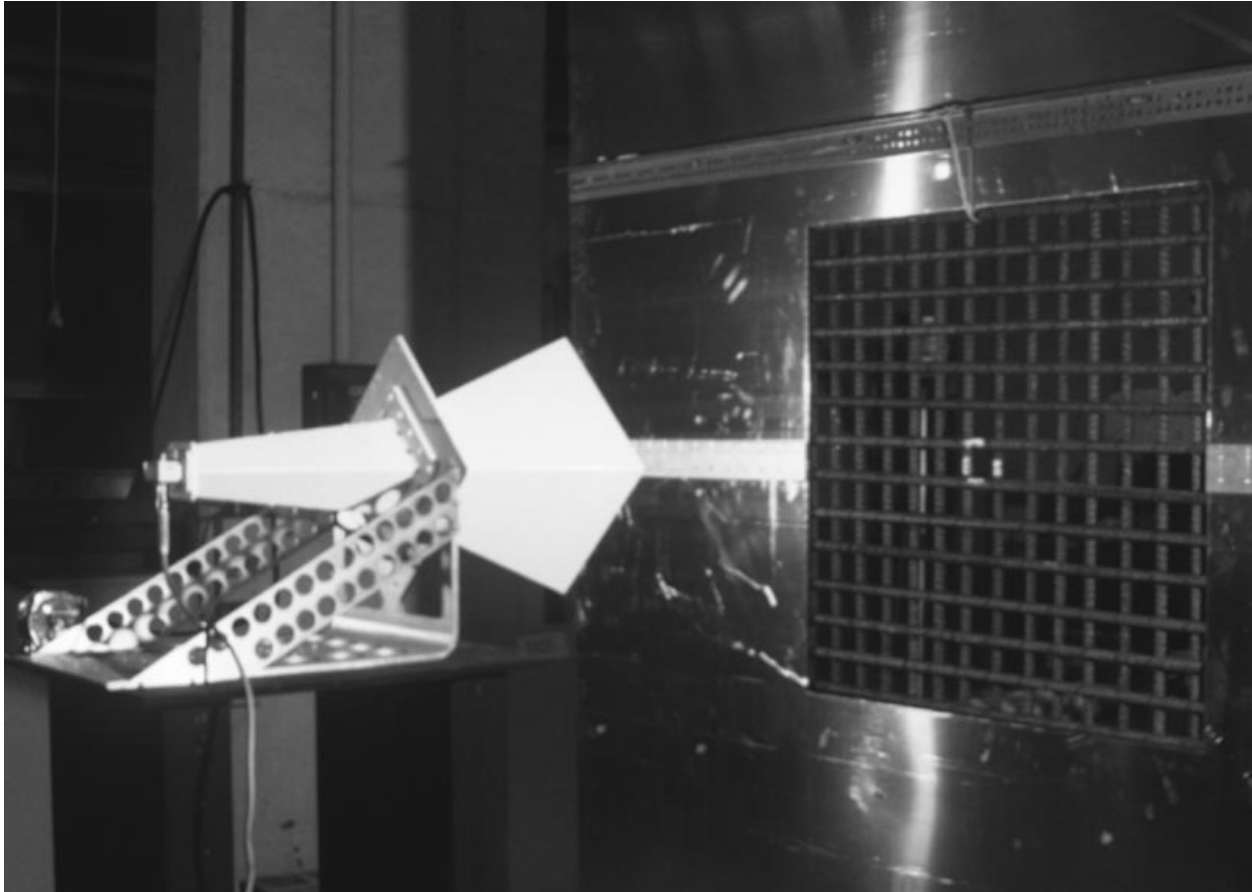

Figure 2.2.2.2: Flam & Russell Diagonal Range Illumination Horn (3.0 to 8.0 GHz) in use with concrete reinforcement grid specimen.

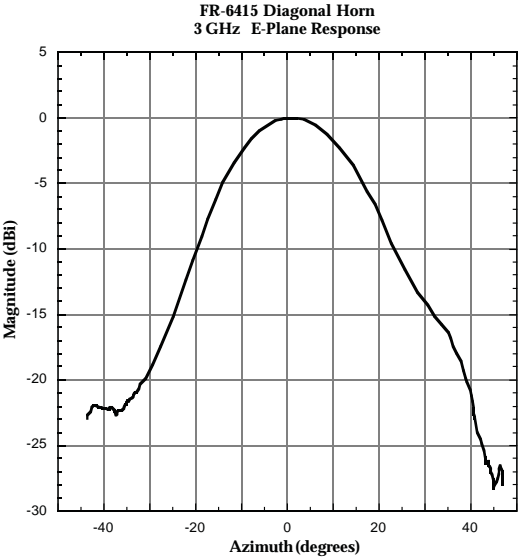

Figure 2.2.2.3: E-Plane radiation pattern for FR-6415 at 3.0 GHz.

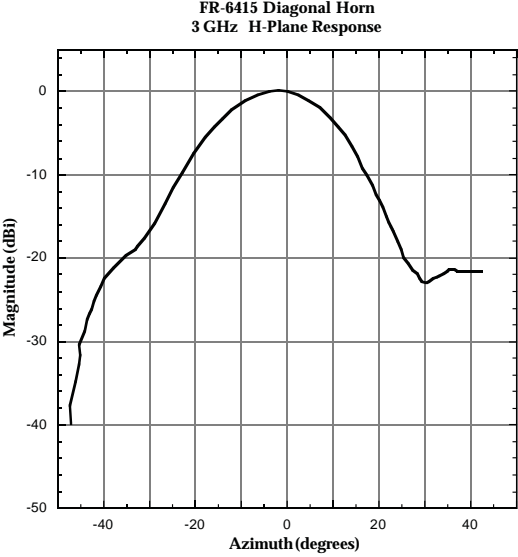

Figure 2.2.2.4: H-Plane radiation pattern for FR-6415 at 3.0 GHz.

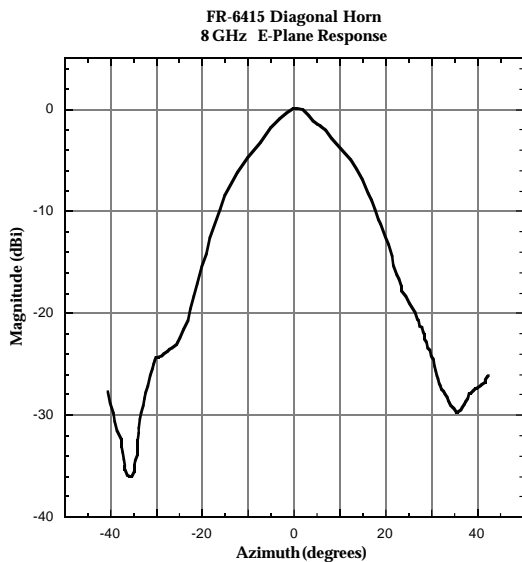

Figure 2.2.2.5: E-Plane radiation pattern for FR-6415 at 8.0 GHz.

sioned orthographic views in Figures 2.3.3 through 2.3.5.

Previous tests with the radar system [1] had shown the problematic nature of multipath signals reaching, and distorting, the straight line (through the specimen) transmission signal. Calculations showed that an electromagnetic shield, in the form of a roughly 2.5 m square, 3 mm thick aluminum panel would effectively block any multipath signals from the data except for those due to internal reflections within the specimen thickness. This was accurate provided the transmitting and receiving horns were relatively close to the test article. The distance selected was 1 m from the backplane of the EM shield to the aperture of each antenna. This meant that the distance from the receiving horn to the back side of the specimen varied, depending on the specimen thickness.

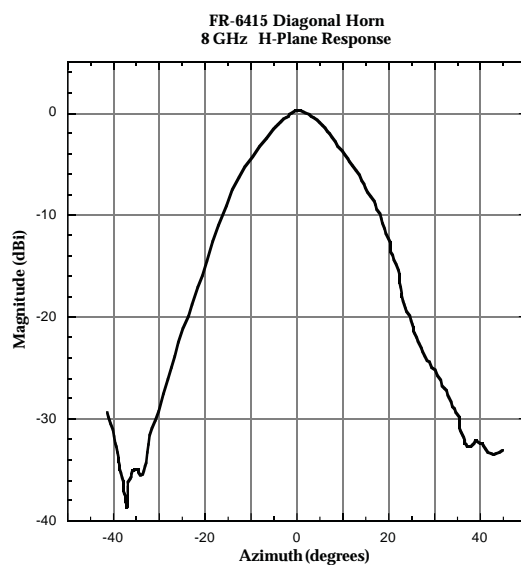

Figure 2.2.2.6: H-Plane radiation pattern for FR-6415 at 8.0 GHz.

The EM shield contained a 914 mm square “window” on centerline through which the transmitted signals could pass unobstructed, as shown in Figures 2.3.2 and 2.3.4. Multipath signals diffracting around the edges of the shield arrived significantly later (in the time domain) and were thus easily eliminated using gating windows (see section 2.6).

In order to gain statistical data concerning the variability of the measured distance with respect to the spatial and compositional variability of the various materials, the entire specimen carrier platform was mounted to a rail system that permitted translation of the specimen perpendicular to the line of signal transmission. In this manner, several duplicate sets of tests could be conducted for a single specimen, but with different sections of the specimen being located on the centerline of the transmission path.

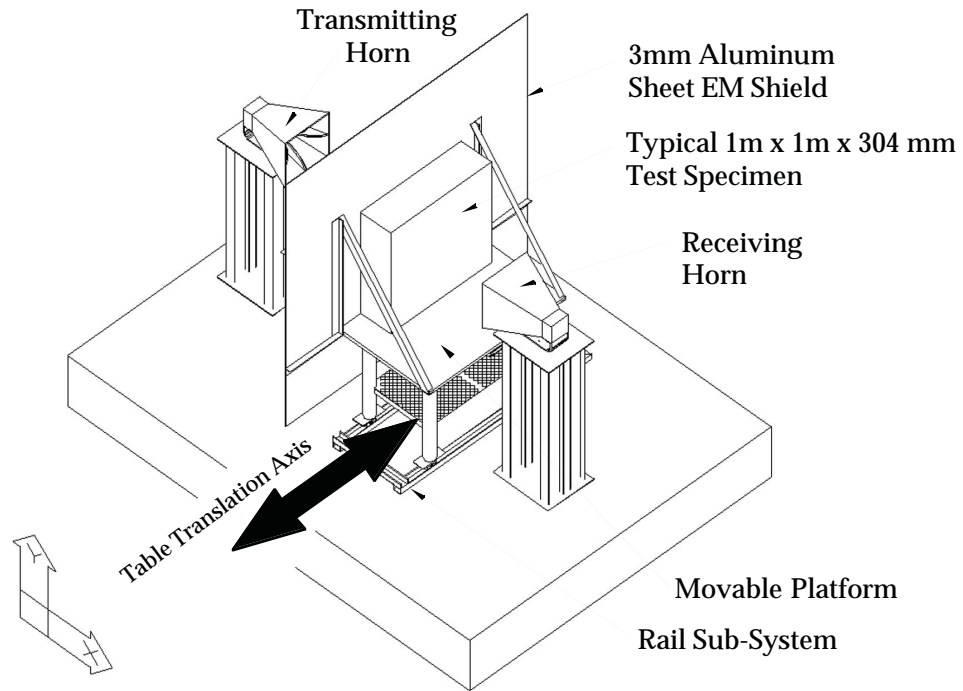

Figure 2.3.1: Isometric view of test stand for Phase 2 NLS tests. Mobile table is shown with specimen in place on opposite side of EM shield from transmitting horn.

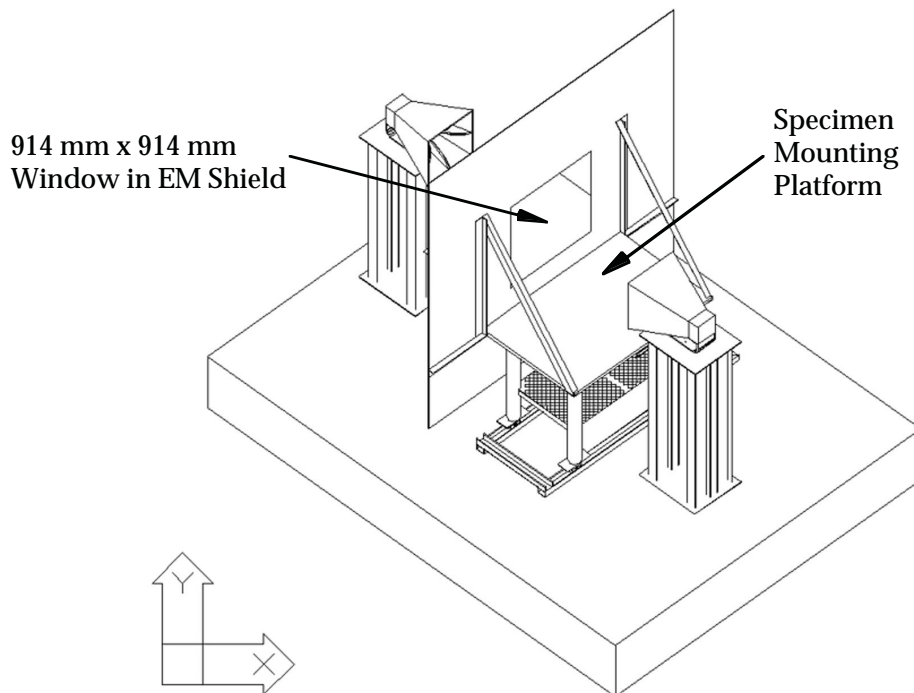

Figure 2.3.2: Isometric view of test stand for Phase 2 NLS tests showing central square window in EM shield.

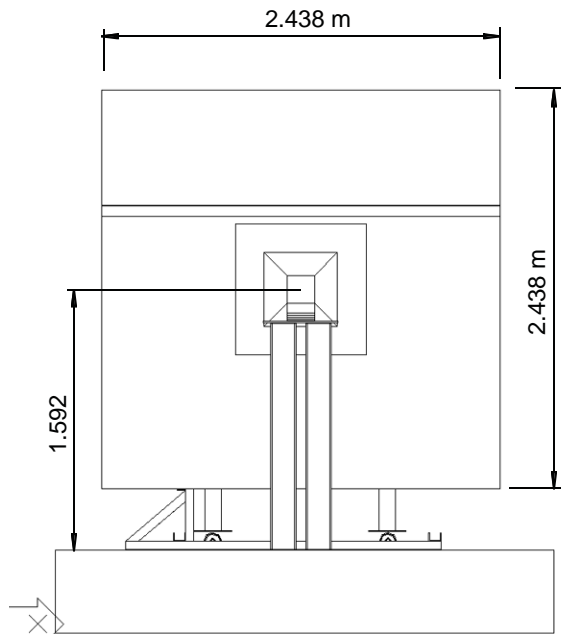

Figure 2.3.3: End view of test stand for Phase 2 NLS tests.

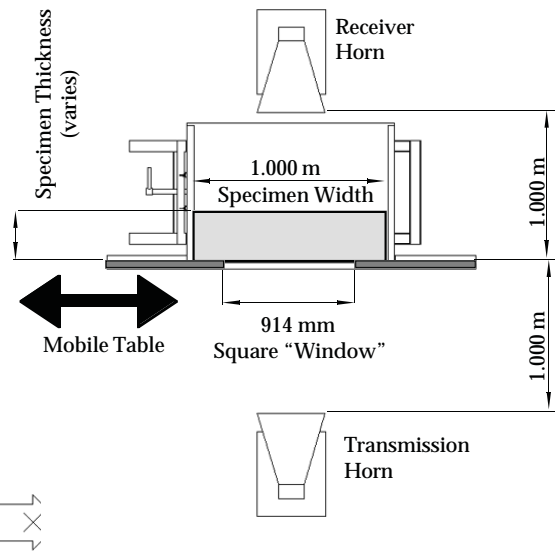

Figure 2.3.4: Plan view of test stand for Phase 2 NLS tests showing central square window in EM shield.

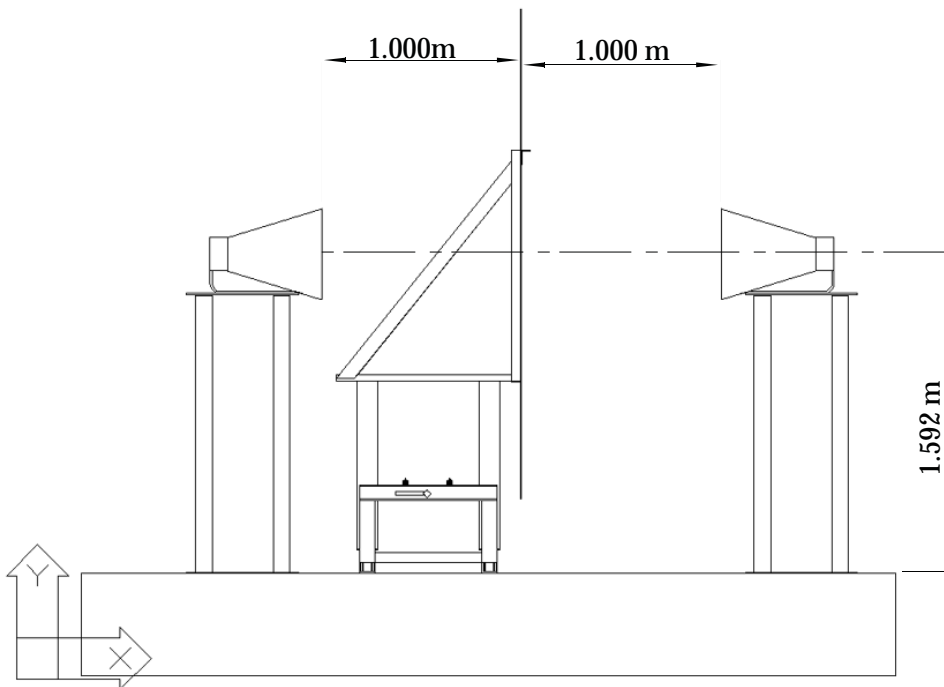

Figure 2.3.5: Elevation view of test stand for Phase 2 NLS tests

2.4 Specimen Design

A total of 9 different materials were tested in this series. A summary of these is presented in Table 2.4. More detailed statistics are given in Chapters 3 and 4. The test articles included common construction materials such as brick, masonry block, plain concrete, reinforced concrete, glass, lumber, plywood, drywall, and reinforcing bars. At least three different thicknesses, and in some cases four, were tested for each of the above materials. In addition, the lumber and plywood specimens were tested in both a wet and dry state.

Of particular note is the list of plain concrete specimens in Table 2.4. Because of the widely varying nature of this common composite, efforts were made to construct an experiment matrix that captured some of the most important variables. These included aggregate size, water/cement ratio, and slump. The full material design matrix included high and low values for each of the above three parameters plus three panel thicknesses for a total of 24 plain concrete specimens. Cylinder strengths and other data reported in Chapter 3 are for standard 28-day water-cured cylinders.

All specimens had a 1 m by 1 m cross section. Design thicknesses varied from as little as 6 mm to as great as 600 mm depending on the material and typical usage values at commercial and residential construction sites.

The values listed in Table 2.4 are design values. The actual values differed as a result of batch processing errors and tolerances, material availability, and work-

manship errors and tolerancing. Because of this, detailed measurements were taken of both the actual geometry and material properties at the time of testing. These more detailed data are presented in Chapters 3 and 4. Since significant variations existed in some situations (notably batch processing weights for the plain concrete) the numbers presented in Table 2.4 should only be used as an approximate reference.

Units in Table 2.4 are kilograms per cubic meter for concrete density and millimeters for all thickness specifications.

2.5 Test Protocol

The data for each test consisted of a calibrated response spectrum. The theory and hardware instrumentation which allows for the generation of these spectra were presented in Section 2.1 and these techniques were implemented in an automatic fashion via computer control.

The protocol for testing any specimen, however, consisted of the following steps:

Step 1: Acquire freespace response spectra. At the start and finish of each day of testing a response spectrum was acquired using the test setup configured as shown in Figure 2.3.2, with no specimen loaded. This was used to provide the denominator of Eq. 2.1.23.

Step 2: Acquire response spectrum for the test specimen. This step follows the previously described theoretical protocol for discrete construction of the response spectrum but with one important variation. Instead of a single measurement

Table 2.4: Design Material Properties for Phase 2 NLS Tests

**BFRL/Construction Automation Program
NLS Phase II Test Specimen Matrix**

- * All specimens to be 1m x 1m square.
- * Receiver Unit to be electromagnetically isolated from multipath by means of an aluminum plate shield (3mm thick sheet, extending 1m minimum about a central 914 mm x 914 mm square hole)
- * Transmission and receiver antennas located 1m from the specimen front face (2.0 m spacing between antennas)
- * All tests are conducted using both frequency bandwidths available: 0.500-2.0 Ghz (set 1); 3-8 Ghz (set 2).
- * For concrete specimens the following properties apply:

Volumetric Analysis

Properties	Batch 1	Batch 2	Batch 3	Batch 4	Batch 5	Batch 6	Batch 7	Batch 8
MSA, mm	12.7	12.7	12.7	12.7	25.4	25.4	25.4	25.4
w/c	0.4	0.4	0.6	0.6	0.4	0.4	0.6	0.6
Slump	low	high	low	high	low	high	low	high
% Cement	15.8	18.2	10.5	12.1	14.1	16.0	9.4	10.7
% Water	19.9	22.9	19.9	22.9	17.8	20.2	17.8	20.2
% CA	29.9	29.9	29.9	29.9	37.9	37.9	37.9	37.9
% FA	31.9	26.5	37.2	32.6	28.6	24.3	33.3	29.7
% Paste	35.7	41.1	30.4	35.0	31.9	36.2	27.2	30.9

Theoretical Batch weights, SSD Basis, kilograms per cubic meter (kg/m³)

Cement	497.6	572.5	331.7	381.7	445.3	504.7	296.7	336.5
Water	199.2	228.9	199.2	228.9	177.8	202.1	177.8	202.1
CA	813.3	813.3	813.3	813.3	1032.1	1032.1	1032.1	1032.1
FA	835.9	695.0	973.8	853.7	750.3	637.3	873.9	777.6
Density (kg/m ³)	2345.9	2309.6	2318.0	2277.5	2405.3	2376.2	2380.4	2348.3
Density (g/cc)	2.35	2.31	2.32	2.28	2.41	2.38	2.38	2.35

MSA = Maximum Size Aggregate (mm)
Coarse Aggregate: ASTM C33 #7 (Batch 1-4), ASTM C33 #57 (Batch 5-8)

For each bath there were 3 thickness: 102 mm, 203 mm, and 305 mm

For the remaining engineering materials the following nominal specifications apply:

Material	Thickness	Thickness	Thickness	Thickness
Reinf. Concrete # 1 1% Mesh, Grade 60	203.2	N/A	N/A	N/A
Reinf. Concrete #2 2% Mesh, Grade 60	203.2	N/A	N/A	N/A
Glass(Plain)	6.4	12.7	19.1	
Drywall	6.4	9.5	12.7	
Plywood	6.4	12.7	19.1	31.8
Masonry Block	203.2	406.4	609.6	
Lumber	38.1	76.2	114.3	152.4
Brick	88.9	177.8	266.7	

being made at each frequency, the average of 128 samples of the response at each frequency was recorded. This was performed automatically and was done to increase the accuracy of each individual frequency response measurement. The same procedure was used for the

freespace measurements.

Step 3: Spatial variation tests. Ten separate tests were performed for each physical specimen. After each test the specimen platform was moved in 6 mm increments perpendicular to the signal trans-

mission line between the two horns and the test repeated until a maximum displacement of 60 mm had been achieved. Each individual test was calibrated during the post processing cycle as described in Section 2.1. Using these ten separate tests, mean and standard deviation of the frequency response spectra for a particular specimen could be determined. It was this averaged frequency response spectrum that was used for subsequent time domain analyses.

2.6 Post-Processing Procedures

Several post-processing techniques were used to improve the utility of the attenuation spectra presented in Chapters 5 and 6. First, the averaged spectrum for a given test specimen was converted to time domain using a chirp-Z transform [7]. The implementation used for the tests reported here was an embedded function in DATAPRO (a proprietary code developed by Flam & Russell) which was part of the experimental instrumentation. This transform can also be implemented using standalone post-processors such as Matlab [8] and other digital signal processing packages. The chirp-Z transform was used because it is more flexible than an FFT. In the case of the data presented here, there were 401 discretely sampled points which comprised the 0.5 to 2.0 GHz data and 801 points which comprised the 3.0 to 8.0 GHz data. A typical input file would be a response spectrum like that shown in Figure 2.6.1 for the 0.5 to 2.0 GHz test series. In this case, the data shown are for a 152 mm thick, double wythe brick wall, that is, a brick wall two blocks deep. Using a chirp-z transform, the data in Figure 2.6.1 can be converted to the

time domain plot shown in Figure 2.6.2. This is a particularly good data set, with very little attenuation involved. In fact, as can be seen for certain frequencies around 0.75 GHz in Figure 2.6.1, the cali-

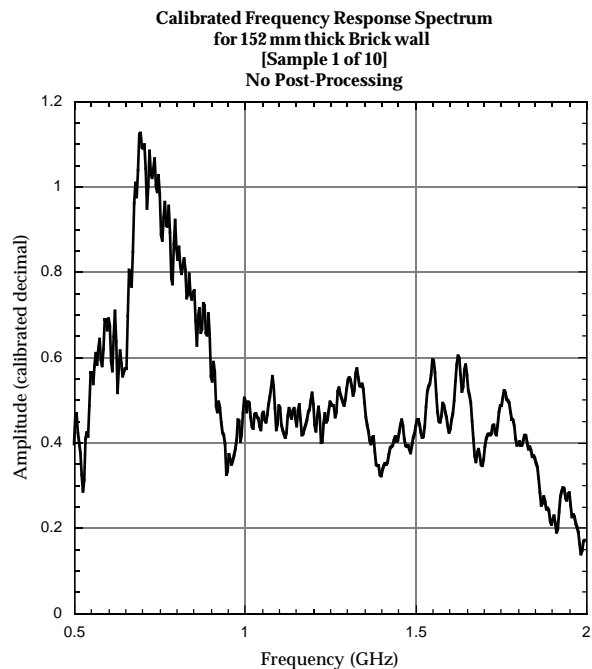

Figure 2.6.1: Calibrated frequency response spectrum for 152 mm thick Brick wall (no gating) for the 0.5 to 2.0 GHz test series, Specimen #1 of 10.

brated frequency response is actually slightly greater than 1.0, implying that constructive interference is taking place within the wall. This will not normally be the case, especially with thicker, denser walls such as concrete.

The time domain plot shown in Figure 2.6.2 shows one predominant peak at a range of slightly more than two meters. Two observations need to be made at this point. First, a “time domain” waveform implies amplitude as a function of time, usually expressed in seconds. In this case, the scale is actually in nanoseconds, where 1 nanosecond of travel in free

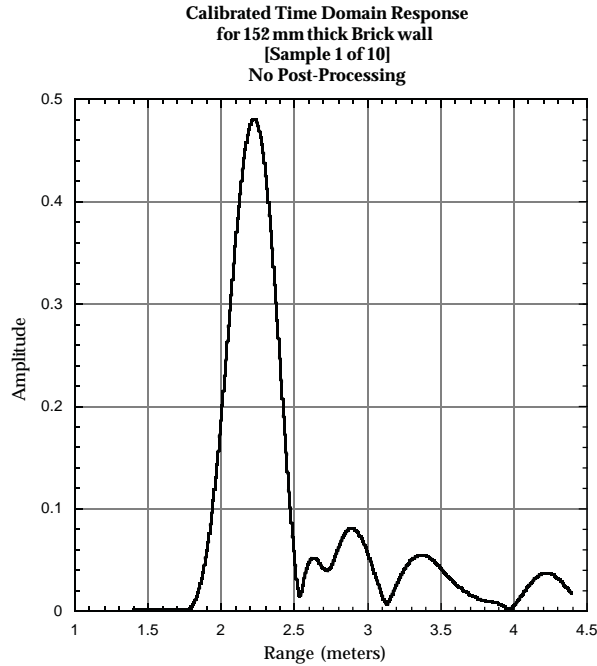

Figure 2.6.2: Calibrated Time Domain Response for 152 mm thick Brick wall (no post processing) for the 0.5 to 2.0 GHz test series, Specimen #1 of 10.

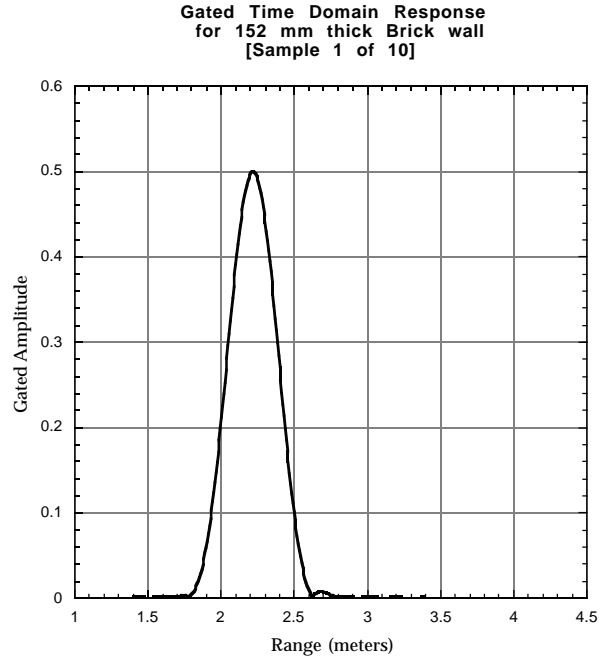

Figure 2.6.3: Gated Time Domain Response for 152 mm thick Brick wall for the 0.5 to 2.0 GHz test series, Specimen #1 of 10.

space is equivalent to approximately 304 mm (1 foot). This equivalence permits a recasting of the x-axis scale in the more useful units of distance. The second point is that the true distance between the two antennas was pre-set at 2.000 meters. The peak in Figure 2.6.2 clearly is not at 2.000 meters. The difference is due to the slower velocity of propagation of the signal through the material:

$$v = \frac{c}{\sqrt{\epsilon_r}} \quad \text{Eq. (2.6.1)}$$

where

v = actual wave speed in matter (m/s)

ϵ_r = material dielectric constant
(dimensionless)

c = vacuum speed of light (m/s)

During its transit through the brick wall, the signal travels (relative to our refer-

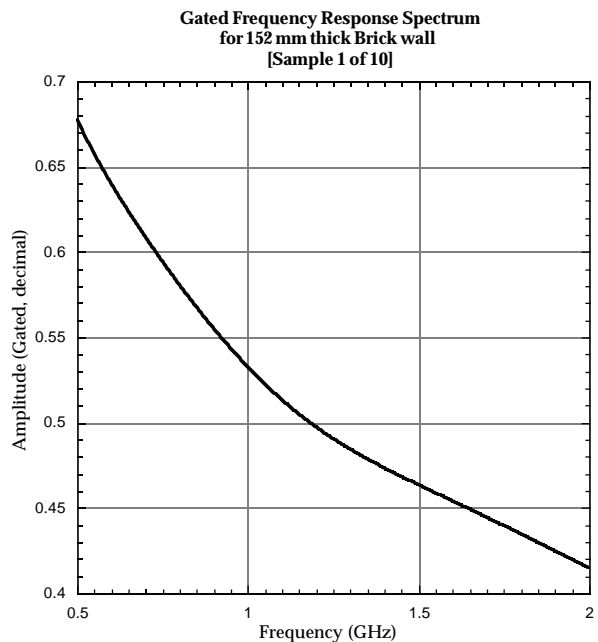

Figure 2.6.4: Gated response spectrum for 152 mm thick Brick wall for the 0.5 to 2.0 GHz test series, Specimen #1 of 10.

$$\epsilon_r = \left(\frac{\Delta x}{d} + 1 \right)^2 = \left(\frac{\Delta t \cdot c + 1}{d} \right)^2 \quad \text{Eq. (2.6.2)}$$

Δx = difference between the measured distance and the true distance (m)

Δt = difference between the measured time of flight and the vacuum time of flight (s)

d = material thickness (m)

ence frame) at a velocity less than the speed of light in a vacuum (Eq.2.6.1). For many engineering materials, for example reinforced concrete, the propagation velocity through the material can be as much as three (3) times slower than the speed of light in a vacuum. From Figure 2.6.3 the measured distance at the primary peak can be used to determine the material dielectric constant by means of Eq. 2.6.2.

Adjacent to the predominant peak in Figure 2.6.2 are several smaller peaks. In general these will be much more pronounced in materials with higher water content and where the signal to noise ratio is lower. Even for this case there is a substantial amount of noise in the spectrum shown in Figure 2.6.1. Noise in the spectrum is produced primarily by internal reflections within the target. Since the true distance was known with high accuracy for these experiments, a range gate [9] on the time domain can be used to clean up the spectra.

The HP 8530A used for these experiments contains a gating feature which allows for selective viewing of individual portions of the time domain response. The specific gating used was a 1 nanosecond wide Kaiser-Bessel window centered on the peak, which effectively considered only those data within a 6 dB amplitude variation from the peak. The result of the application of this gate in the time domain is shown in Figure 2.6.3 for the case of the brick wall previously considered.

An inverse transform of the time domain data yields the gated frequency response spectra. As can be seen from Figure 2.6.4, this is a much cleaner representation of the attenuation characteristics of the transmitted signal with respect to frequency. The processing of the data proceeded in a step-wise fashion as follows:

- Define the time gates to use for each material sample using DATAPRO.
- Apply the time gating to each measurement with DATAPRO, and save the gated frequency and time domain data in Network Common Data Form (netCDF).
- Read the netCDF data and perform statistical analysis on the gated frequency and time domain data using MatLab.
- Write out the averages and standard deviations of the measurements for each sample in both netCDF and ASCII files.

In Chapters 5 and 6 the attenuation data will be presented in the form shown in Figure 2.6.4, but with the notable inclusion of a 1-sigma error band, based on the replicate measurements taken for each specimen

3.0 Specimen Material Properties and Geometry

In the following sections, the material properties and geometry of each specimen are detailed. In general, these properties and dimensions differed from those listed previously in Table 2.4 as the nominal design specifications for the test specimen. Deviations from the design thicknesses were most pronounced in the concrete specimens. There, imprecision in the fabrication of the wood formwork and deflections of the formwork under the hydrostatic loading of the fresh concrete led to occasional differences of several millimeters in thickness across the specimen width.

Each specimen/test combination had a condensed alphanumeric name which generally consisted of a one or two letter prefix identifying the material, a specimen identification number, material thickness identifier, frequency bandwidth identifier, and the test number for the current test. A total of 10 tests were performed for each specimen in which the specimen was moved laterally (perpendicular to the signal propagation line) in 6 mm increments relative to the specimen centerline. Thus test #10 for any given specimen meant that the specimen was displaced 60 mm from its original centerline relative to the centerline of the transmitted signal. An example data file name would be:

C712L01

Where, “C” designates plain concrete, “7” is the concrete batch number (8 were used), “12” was the specimen thickness identifier (in this case 305 mm = 12 inches), “L” means “low” frequency bandwidth (0.5 to 2.0 GHz), and “01” was the first test for this specimen.

A complete list of specimen names (minus the within specimen test number suffix) for tests in the Low Range series (0.5 to 2.0 GHz) is given in Table 3.0.1. A similar set is given for the High Range tests (3.0 to 8.0 GHz) in Table 3.0.2.

Individuals desiring specific digital records of the raw, calibrated data should refer to the nomenclature defined in these two tables. Similar nomenclature prefixes apply to the averaged, gated response spectra described in detail in Chapters 4 and 5. Requests for digital copies of the “raw,” calibrated data (either in the frequency or time domain) should be addressed to the author at the email address listed at the front of this document. Please specify the test sets when doing so.

Table 3.1: Parent Specimen Nomenclature for Low Range Tests (0.5 to 2.0 GHz). Each parent specimen entry has 10 individual associated tests, beginning with suffix 01 and ending with suffix 10. The centroid of specimen 01 is aligned colinear with the direct signal path between transmitter and receiver; specimen 10 in each set is shifted laterally 60 mm from the transmitted signal path; all other tests are uniformly spaced at 6 mm intervals between these two extremes.

Parent Specimen Name	Material (Layer 1)	Exterior Surface Condition	Material (Layer 2)	Material (Layer 3)	Nominal Thickness (Layer 1) (mm)	Nominal Thickness (Layer 2) (mm)	Nominal Thickness (Layer 3) (mm)	Total Thickness (mm)
B1L	Brick	Dry			76			76
B2L	Brick	Dry	Brick		76	76		152
B3C84L	Brick	Dry	Concrete		76	102		178
B3C88L	Brick	Dry	Concrete		76	203		279
B3L	Brick	Dry	Brick	Brick	76	76	76	229
B3MB8L	Brick	Dry	Masonry Block		76	203		279
C112L	Concrete	Dry						305
C14L	Concrete	Dry						102
C18L	Concrete	Dry						203
C212L	Concrete	Dry						305
C24L	Concrete	Dry						102
C28L	Concrete	Dry						203
C312L	Concrete	Dry						305
C34L	Concrete	Dry						102
C38L	Concrete	Dry						203
C412L	Concrete	Dry						305
C44L	Concrete	Dry						102
C48L	Concrete	Dry						203
C512L	Concrete	Dry						305
C54L	Concrete	Dry						102
C58L	Concrete	Dry						203
C612L	Concrete	Dry						305
C64L	Concrete	Dry						102
C68L	Concrete	Dry						203
C712L	Concrete	Dry						305
C74L	Concrete	Dry						102
C78L	Concrete	Dry						203
C812L	Concrete	Dry						305
C84L	Concrete	Dry						102
C88L	Concrete	Dry						203
CB1L	Masonry Block	Dry			203			203
CB2L	Masonry Block	Dry	Masonry Block		203	203		406
CB3L	Masonry Block	Dry	Masonry Block	Masonry Block	203	203	203	610
D25L	Drywall	Dry			6			6
D50L	Drywall	Dry			13			13
D625L	Drywall	Dry			16			16
G25L	Glass	Dry			6			6
G50L	Glass	Dry			13			13
G75L	Glass	Dry			19			19
L15DL	Southern Pine	Dry			38			38
L15WL	Southern Pine	Wet			38			38
L30DL	Southern Pine	Dry			76			76
L30WL	Southern Pine	Wet			76			76
L45DL	Southern Pine	Dry			114			114
L45WL	Southern Pine	Wet			114			114
L60DL	Southern Pine	Dry			152			152
L60WL	Southern Pine	Wet			152			152
P125DL	Plywood	Dry	Plywood		13	19		32
P125WL	Plywood	Wet			13	19		32
P25DL	Plywood	Dry			6			6
P25WL	Plywood	Wet			6			6
P50DL	Plywood	Dry			13			13
P50WL	Plywood	Wet			13			13
P75DL	Plywood	Dry			19			19
P75WL	Plywood	Wet			19			19
RC881L	Reinforced Concrete	Dry			203			203
RC882L	Reinforced Concrete	Dry			203			203
RE1L	Rebar Grid	Dry			19			19

Table 3.2: Parent Specimen Nomenclature for High Range Tests (3.0 to 8.0 GHz). Each parent specimen entry has 10 individual associated tests, beginning with suffix 01 and ending with suffix 10. The centroid of specimen 01 is aligned colinear with the direct signal path between transmitter and receiver; specimen 10 in each set is shifted laterally 60 mm from the transmitted signal path; all other tests are uniformly spaced at 6 mm intervals between these two extremes.

Parent Specimen Name	Material (Layer 1)	Exterior Surface Condition	Material (Layer 2)	Material (Layer 3)	Nominal Thickness (Layer 1) (mm)	Nominal Thickness (Layer 2) (mm)	Nominal Thickness (Layer 3) (mm)	Total Thickness (mm)
B1H	Brick	Dry			76			76
B2H	Brick	Dry	Brick		76	76		152
B3C84H	Brick	Dry	Concrete		76	102		178
B3C88H	Brick	Dry	Concrete		76	203		279
B3H	Brick	Dry	Brick	Brick	76	76	76	229
B3MB8H	Brick	Dry	Masonry Block		76	203		279
C112H	Concrete	Dry						305
C14H	Concrete	Dry						102
C18H	Concrete	Dry						203
C212H	Concrete	Dry						305
C24H	Concrete	Dry						102
C28H	Concrete	Dry						203
C312H	Concrete	Dry						305
C34H	Concrete	Dry						102
C38H	Concrete	Dry						203
C412H	Concrete	Dry						305
C44H	Concrete	Dry						102
C48H	Concrete	Dry						203
C512H	Concrete	Dry						305
C54H	Concrete	Dry						102
C58H	Concrete	Dry						203
C612H	Concrete	Dry						305
C64H	Concrete	Dry						102
C68H	Concrete	Dry						203
C712H	Concrete	Dry						305
C74H	Concrete	Dry						102
C78H	Concrete	Dry						203
C812H	Concrete	Dry						305
C84H	Concrete	Dry						102
C88H	Concrete	Dry						203
CB1H	Masonry Block	Dry			203			203
CB2H	Masonry Block	Dry	Masonry Block		203	203		406
CB3H	Masonry Block	Dry	Masonry Block	Masonry Block	203	203	203	610
D25H	Drywall	Dry			6			6
D50H	Drywall	Dry			13			13
D625H	Drywall	Dry			16			16
G25H	Glass	Dry			6			6
G50H	Glass	Dry			13			13
G75H	Glass	Dry			19			19
L15DH	Southern Pine	Dry			38			38
L15WH	Southern Pine	Wet			38			38
L30DH	Southern Pine	Dry			76			76
L30WH	Southern Pine	Wet			76			76
L45DH	Southern Pine	Dry			114			114
L45WH	Southern Pine	Wet			114			114
L60DH	Southern Pine	Dry			152			152
L60WH	Southern Pine	Wet			152			152
P125DH	Plywood	Dry	Plywood		13	19		32
P25DH	Plywood	Dry			6			6
P25WH	Plywood	Wet			6			6
P50DH	Plywood	Dry			13			13
P50WH	Plywood	Wet			13			13
P75DH	Plywood	Dry			19			19
P75WH	Plywood	Wet			19			19
RC881H	Reinforced Concrete	Dry			203			203
RC882H	Reinforced Concrete	Dry			203			203
RE1H	Rebar Grid	Dry			19			19
RE2H	Rebar Grid	Dry			19			19

3.1 Brick

The red clay brick used in this study was a common variety used in residential and commercial construction containing three circular weight-reduction holes along the longitudinal centerline (see Figure 3.1.1). The bricks had nominal lengths of 193 mm, a width of 90 mm, and a vertical thickness of 56 mm. The center holes differed in size with the center hole averaging 34 mm in diameter and the two end holes averaging 37 mm diameter. The brick is Grade MW, meeting specification ASTM C 652. Detailed properties, including geometry and material density are given in Tables 3.1.1, 3.1.2, and 3.1.3.

As shown in Tables 3.1 and 3.2, there were three “brick wall” thickness configurations tested. For convenience, three nominally 1 x 1 meter single wythe brick walls were fabricated, following the dimensions listed shown in Table 3.1.1.

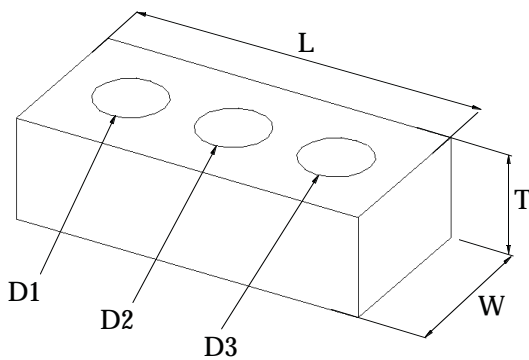

Figure 3.1.1: Individual brick geometry. Definitions of each parameter are given in Table 3.1.2 along with typical measurements and statistical parameters. Individual bricks were used to construct typical residential and commercial building walls of 1, 2, and 3 wythe depth, as shown in Figure 3.1.2.

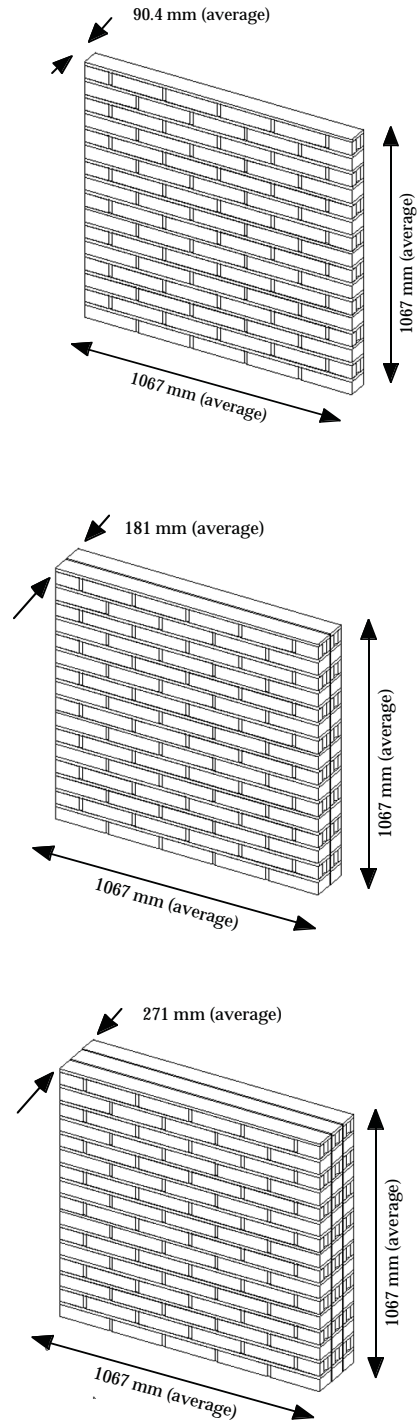

Figure 3.1.2: Brick wall geometries. Top: single wythe; Middle: double wythe; and Bottom: triple wythe construction. An air gap of between 3 to 5 mm existed between each wall in the multiple-wall tests owing to variations in placement of the bricks. Typical mortar joint thicknesses are presented in Table 3.1.1.

In order to represent two and three wythe thickness walls, single wythe walls were stacked as shown in Figure 3.1.1 to achieve the necessary thickness. On average, an air gap of 3 to 5 mm existed between each wall. This was due to variations in the placement of the individual bricks in each wall panel. The walls were supported by top and bottom steel channel sections connected by threaded rods. Shackles, attached to the threaded rods (not shown) allowed the wall sections to be handled by an overhead crane.

The mortar joints averaged between 13 and 14 mm thickness, as shown in Table 3.1.1. Characteristics for the mortar are given in Table 3.1.4 and 3.1.5 below and include both mix proportions and density, as well as various standard measures of the cured strength. The same mortar specified in Tables 3.1.4 and 3.1.5 was used in the lay up of the concrete masonry block walls described in Section 3.2, below.

TABLE 3.1.1: MEASUREMENTS OF ASSEMBLED 1X1 M BRICK WALL

Sample Number	Height along Wall (mm)	Wall Width (mm)	Unit Brick Length (mm)	Unit Brick Height (mm)	Bed Mortar Joint Height (mm)	Header Mortar Joint Width (mm)
1	0.0	90.3	192.4	56.5	10.3	10.8
2	63.5	90.9	190.5	56.8	12.9	11.1
3	130.2	90.3	193.4	55.6	11.4	13.3
4	200.0	91.1	192.9	55.2	15.4	10.4
5	269.9	90.1	192.1	55.7	15.2	18.5
6	336.6	89.4	192.4	54.0	15.7	14.1
7	406.4	91.1	191.7	56.2	11.8	16.4
8	476.3	91.2	192.5	55.1	16.2	12.7
9	546.1	89.4	191.1	55.4	19.2	13.3
10	619.1	91.2	191.5	55.9	13.9	11.4
11	689.0	89.8	191.4	55.5	11.1	15.0
12	755.7	88.8	192.7	54.8	15.6	14.2
13	828.7	89.8	192.9	54.4	14.3	11.8
14	898.5	91.3	192.2	55.9	12.3	17.1
15	968.4	89.1	191.6	54.8	15.8	10.5
Mean		90.3	192.1	55.4	14.1	13.4
S.D.		0.8	0.8	0.8	2.4	2.5

TABLE 3.1.2: STATISTICAL GEOMETRY DATA FOR BRICKS USED IN THE CONSTRUCTION OF THE WALL SPECIMENS (PART 1 OF 2)

BRICK Material Data (from 10 randomly sampled units)							
Grade MW Brick, meeting ASTM C 652							
General Description: rectangular solid with three circular holes through the thickness							
				D1	D2	D3	
				"Left"	"Center"	"Right"	M
	W	L	T	Hole	Hole	Hole	Individual
Sample	Brick	Brick	Brick	Diameter	Diameter	Diameter	Brick
Number	Width	Length	Thickness	# 1	# 2	# 3	Weight
	(mm)	(mm)	(mm)	(mm)	(mm)	(mm)	(g)
1a	90.8	192.5	56.0	37.2	32.9	37.0	1679.8
1b	90.3	193.1	56.3	38.4	35.3	37.3	
1c	91.2	193.0	56.0	38.0	33.1	37.3	
1d	90.8	192.6	56.2	38.5	34.7	37.2	
1e	89.8	192.7	56.4				
1f	91.0	192.2	56.6				
2a	90.0	192.4	56.0	35.7	32.4	36.7	1670.7
2b	89.4	193.1	56.0	37.5	35.3	38.3	
2c	89.5	192.6	56.3	35.4	31.6	36.2	
2d	89.3	192.9	55.9	38.0	35.1	38.4	
2e	88.5	193.4	56.4				
2f	88.7	192.9	56.0				
3a	90.9	193.6	56.9	37.0	32.3	37.8	1720.7
3b	90.2	193.4	57.7	37.4	35.2	38.8	
3c	91.3	192.9	57.3	37.1	32.8	37.5	
3d	90.8	192.5	56.5	37.4	35.2	38.6	
3e	90.1	193.2	56.9				
3f	90.9	192.9	56.5				
4a	90.9	192.1	56.4	37.4	32.6	37.1	1702.5
4b	90.3	192.5	56.8	38.9	35.0	37.4	
4c	91.1	192.3	56.4	38.2	32.6	36.6	
4d	89.8	191.9	56.2	38.0	34.9	36.8	
4e	88.7	191.3	56.7				
4f	90.2		55.9				
5a	90.9	192.8	56.0	37.0	32.8	38.0	1707.0
5b	89.9	192.5	56.5	37.2	35.4	38.3	
5c	91.1	192.5	56.2	37.1	32.9	37.4	
5d	91.1	192.0	55.5	37.3	35.4	37.5	
5e	90.1	192.4	56.2				
5f	91.1	191.9	55.4				
6a	89.8	192.1	56.3	37.6	32.0	36.5	1688.9
6b	89.6	192.4	55.9	38.5	35.2	37.2	
6c	90.1	192.4	55.8	38.0	32.9	37.0	
6d	91.2	192.6	56.5	38.0	35.3	37.3	
6e	89.9	192.5	56.3				
6f	90.6	192.0	55.7				

TABLE 3.1.2(continued): STATISTICAL GEOMETRY DATA FOR BRICKS USED IN THE CONSTRUCTION OF THE WALL SPECIMENS (PART 2 OF 2, INCLUDING SUMMARY)

7a	90.1	191.6	56.4	37.3	32.4	36.8	1675.3
7b	89.1	192.0	55.7	38.2	32.6	37.1	
7c	90.2	191.9	55.1	37.9	32.4	36.0	
7d	90.0	191.4	55.3	37.4	34.6	37.1	
7e	89.1	191.5	55.9				
7f	90.8	191.2	55.2				
8a	90.0	193.4	56.4	36.9	32.2	36.3	1679.8
8b	89.6	193.6	56.5	38.5	34.5	37.3	
8c	90.2	192.5	56.0	37.2	32.0	36.1	
8d	90.0	193.3	56.5	37.9	34.7	37.1	
8e	89.7	193.2	56.4				
8f	90.0	192.9	56.0				
9a	91.4	191.7	56.1	37.2	33.1	37.7	1702.5
9b	90.7	192.5	56.8	36.9	35.5	37.8	
9c	91.4	192.5	56.9	37.2	32.7	37.6	
9d	90.9	192.2	57.0	37.3	35.2	38.3	
9e	90.5	192.5	57.0				
9f	91.4	192.3	56.4				
10a	91.1	191.9	57.1	37.0	33.1	37.7	1688.9
10b	91.0	192.4	57.1	37.2	34.7	38.5	
10c	91.2	192.0	56.7	37.0	33.1	37.4	
10d	90.8	192.2	56.1	37.0	34.9	38.3	
10e	91.1	192.6	56.4				
10f	91.2	192.2	56.1				
	W	L	T	D1	D2	D3	M
Avg.	90.4	192.5	56.3	37.5	33.8	37.4	1691.6
S.D.	0.7	0.6	0.5	0.7	1.3	0.7	16.0
						Units	
Bounding Box Solid Volume [$V_s = W \cdot L \cdot T$]					979.0	cm ³	
Hole Volume [$V_h = \pi \cdot T \cdot (D1^2 + D2^2 + D3^2)/4$]					174.3	cm ³	
True Solid Volume [$V_t = V_s - V_h$]					804.7	cm ³	
True Material Density [$\rho = M/V_t$]					2.1	g/cm ³	
Apparent (radar) Density [$\rho_{app} = M/V_s$]					1.7	g/cm ³	
Where:	W, L, T, D1, D2, D3, and M are defined in the above table						
	pi = 3.14159						

TABLE 3.1.4: Compressive strength of the mortar used in the construction of the brick and concrete block wall specimens B1, B2, B3, CB1, CB2, and CB3.

Masonry Block Material Properties	Test #	Axial Load (kN)	Compressive Stress (MPa)
UngROUTED Masonry Block Sample Compressive Strength	1	551.6	14.0
	2	477.7	12.1
	3	589.8	15.0
	Mean		13.7
Mortar Cube Strength (moist cured)* 51x51x51 mm	1	59.3	23.0
	2	59.3	23.0
	3	60.0	23.2
	Mean		23.1
Mortar Cube Strength (air dried)** 51x51x51 mm	1	43.9	17.0
	2	42.6	16.5
	3	40.1	15.5
	Mean		16.3
* Mold break at 24 hours; subsequently cured underwater for 28 days at 22C			
** Mold break at 24 hours followed by 28 days in lab air at 22C			

TABLE 3.1.5: Mortar grout mix design used for the grout joints for the brick and concrete block wall specimens B1, B2, B3, CB1, CB2, and CB3.

Component	Mass for 1 Cubic Meter (kilograms)	Mass Fraction (%)
Portland Cement Type I	384.7	16.9%
Lime	61.2	2.7%
Sand	1483.0	65.3%
Water	341.9	15.1%
Density (fresh), kg/m ³	2270.8	

3.2 Masonry Block

The concrete masonry block used in this study was also a common variety used in residential and commercial construction which included two large, approximately rectangular holes set towards either end of the block, a central thin rectangular slot; and a cutout on one end of the type typically used for window frame setting.

The blocks were manufactured by Ernest Maier of Bladensburg, Maryland and meets ASTM C 90. The geometry key for the subsequent data tables is given in Figure 3.2.1. The variable names in

Figure 3.2.1 are defined in Table 3.2.1. The variables W, T, and L stand for the block width, height, and length, respectively. The dimensions for the various pockets and cutouts all have two names, e.g. L4T and L4B. The “L4” portion refers to the right hand cell. The “T” and “B” suffixes indicate whether the measurement was taken at the top or bottom of the block. These are listed in order to account for the differences in the the top and bottom dimensions which result from the manufacturing process. Tapered male mold inserts are used in order to facilitate removal of the blocks

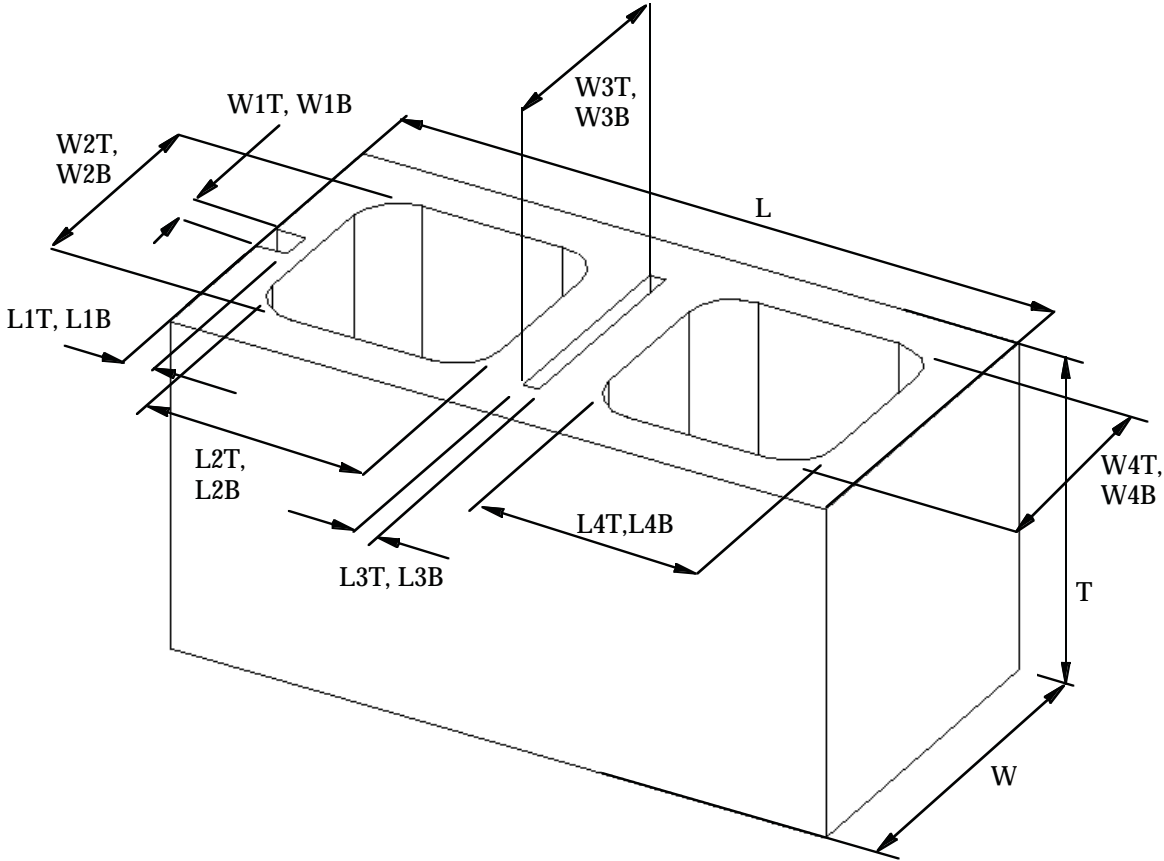
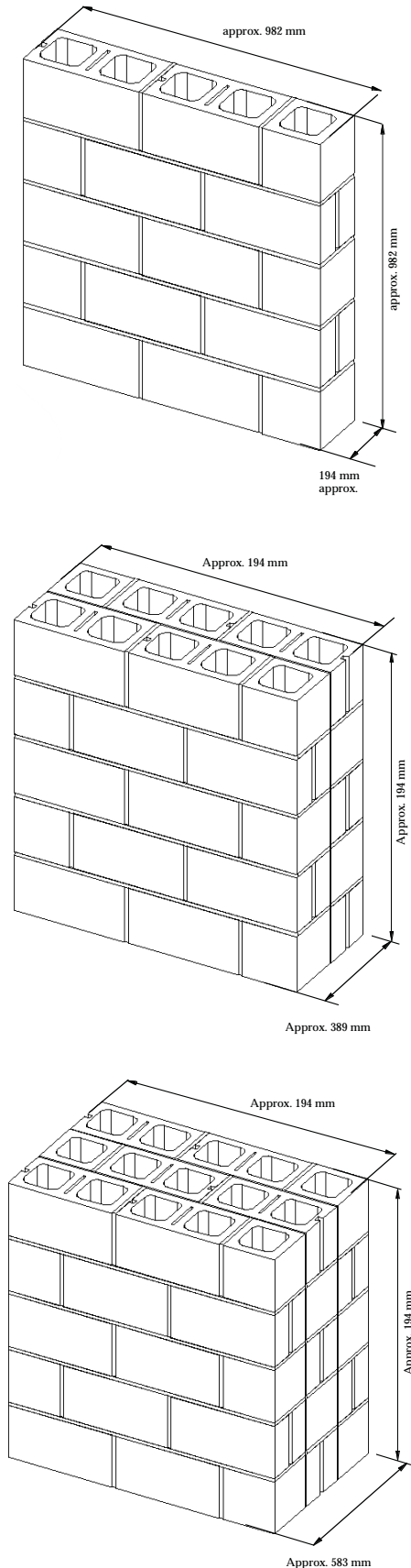

Figure 3.2.1: Masonry block geometry. Typical exterior, average dimensions were 395 mm long, 194 mm wide by 192 mm high. Weight reduction cells are specified in Table 3.2.1.



from the mold after steam curing. The difference can be significant and affects the overall mass of the block. We list these here for completeness, largely because they affect the “equivalent density” of the block, as seen by the radar pulse. To the radar pulse, the block is seen as a series of cells, partitioned by concrete walls. For real-time metrology purposes, however, it will be too burdensome to include such minute details in a time-of-flight calculation. Therefore, we develop an equivalent density equal to the mass of a single block divided by the overall volume of the block, as if the cells were not present. The equivalent density value can be used as a measure of the amount of time delay associated with a pulse propagating through the block. Those considering more detailed analyses can make use of the data contained in Table 3.2.1.

Geometry and density summary information is given in Table 3.2.1, Part 3. Mortar joint properties are the same as those for the brick walls, listed in Tables 3.1.4 and 3.1.5.

Figure 3.2.1 (opposite): Masonry block wall geometries. Top: single row; Middle: double row; and Bottom: triple row construction. An air gap of between 3 to 5 mm existed between each wall in the multiple-wall tests owing to variations in placement of the blocks. Typical mortar joint thicknesses are presented in Table 3.1.1, while mortar joint properties are given in Tables 3.1.4 and 3.1.5. The mortar design was the same as used for the brick walls.

TABLE 3.2.1 (Part 1 of 3): Masonry Block Properties

Sample Number	W Block Width (mm)	L Block Length (mm)	T Block Thickness (mm)	L1 End Notch Length (mm)	W1 End Notch Width (mm)	L2T 1st Cell Top Length (mm)	W2T 1st Cell Top Width (mm)	L2B 1st Cell Bottom Length (mm)	W2B 1st Cell Bottom Width (mm)
1a	194.4	382.6	191.2	18.3	19.1	124.0	121.9	132.7	130.1
1b	194.3	381.8	192.1	18.2	18.9	123.5	121.8	132.5	129.7
1c	194.3	395.3	193.1	17.8	19.6				
1d	193.9	396.9	192.4						
1e	194.1		192.3						
1f	194.8		191.7						
2a	194.9	396.1	192.0	19.0	19.1	128.3	127.1	123.7	120.5
2b	194.5	396.1	191.9	18.9	19.2	127.5	126.2	123.6	120.6
2c	194.4	396.9	191.8	19.0	19.1				
2d	194.7	396.1	192.4						
2e	194.8		192.1						
2f	194.3		192.5						
3a	194.1	396.1	191.8	19.0	19.2	128.7	126.3	123.9	120.4
3b	194.6	396.1	191.9	19.3	19.3	128.1	126.9	123.8	120.4
3c	194.5	396.1	191.6	19.4	19.4				
3d	194.3	396.9	191.8						
3e	194.5		191.9						
3f	194.9		192.9						
4a	194.4	395.3	192.3	18.4	19.2	132.7	128.8	123.9	122.2
4b	193.5	395.3	191.6	18.1	19.4	132.7	129.1	123.5	122.6
4c	193.3	395.3	191.1	17.9	19.5				
4d	193.8	394.5	191.1						
4e	193.4		191.0						
4f	194.0		191.1						
5a	194.0	396.1	193.2	18.4	19.4	133.0	130.8	124.4	121.9
5b	194.0	395.3	192.2	18.7	19.4	133.0	130.4	123.7	122.1
5c	195.0	395.3	191.6	18.9	19.1				
5d	193.9	395.3	192.0						
5e	193.8		192.0						
5f	193.7		193.0						
6a	193.4	395.3	192.6	17.9	19.5	133.5	129.0	123.8	122.1
6b	193.8	395.3	191.5	18.3	19.3	133.2	129.6	123.6	122.5
6c	193.9	395.3	190.5	19.2	19.4				
6d	194.4	396.1	190.2						
6e	193.9		190.2						
6f	193.5		191.0						
7a	194.1	395.3	190.3	18.1	19.8	123.2	122.1	133.2	129.3
7b	193.9	395.3	190.7	18.3	19.1	123.7	122.7	132.9	129.5
7c	194.0	395.3	191.0	18.6	18.9				
7d	194.8	396.1	192.4						
7e	193.8		191.9						
7f	193.8		191.6						
8a	194.1	395.3	191.2	18.6	19.2	123.8	122.1	133.0	129.0
8b	191.4	395.3	191.4	18.2	19.2	123.8	122.3	133.2	128.7
8c	191.2	395.3	191.2	18.3	19.7				
8d	193.7	395.3	193.7						
8e	193.0		193.0						
8f	191.7		191.7						
9a	194.6	396.1	192.3	19.2	19.4	128.4	125.9	123.5	120.6
9b	194.5	395.3	191.5	19.0	19.2	129.5	126.9	123.6	120.9
9c	194.1	396.9	191.1	19.0	18.9				
9d	194.9	396.1	191.4						
9e	194.5		191.3						
9f	194.2		191.4						
10a	194.4	395.3	192.9	19.2	19.3	128.5	126.0	123.4	120.7
10b	194.4	395.3	191.9	19.1	19.2	129.8	127.1	123.5	120.9
10c	194.0	396.9	191.4	19.1	19.1				
10d	194.9	396.1	191.8						
10e	194.5		191.7						
10f	194.3		191.5						

TABLE 3.2.1 (Part 2 of 3): Masonry Block Properties

Sample Number	L3T	W3T	L3B	W3B	L4T	W4T	L4B	W4B	M
	Slot Top Len. (mm)	Slot Top Width (mm)	Slot Bot. Len. (mm)	Slot Bottom Width (mm)	2nd Cell Top Length (mm)	2nd Cell Top Width (mm)	2nd Cell Bottom Length (mm)	2nd Cell Bottom Width (mm)	Individual Brick Weight (g)
1a	9.0	121.2	9.4	128.7	123.1	122.4	133.3	129.1	15113.7
1b	9.1		8.8		123.9	122.0	133.1	129.0	
1c									
1d									
1e									
1f									
2a	9.1	128.2	9.1	121.8	129.4	127.1	123.3	120.8	15431.5
2b	9.0		9.1		128.4	126.2	123.3	120.7	
2c									
2d									
2e									
2f									
3a	9.0	129.4	9.0	121.7	129.4	127.0	123.6	120.8	15490.5
3b	9.1		8.8		128.3	126.3	123.5	120.7	
3c									
3d									
3e									
3f									
4a	9.5	128.7	9.2	122.2	132.6	129.3	123.4	121.9	15113.7
4b	9.3		9.3		132.5	130.0	124.0	122.0	
4c									
4d									
4e									
4f									
5a	9.1	128.8	9.4	121.4	133.2	129.7	123.7	122.5	15281.6
5b	9.2		9.3		133.4	129.6	124.1	122.5	
5c	9.9		9.5						
5d									
5e									
5f									
6a	9.7	128.9	9.3	121.5	132.6	130.0	123.6	121.4	15091.0
6b	9.6		9.3		132.5	130.0	124.4	121.8	
6c			9.4						
6d									
6e									
6f									
7a	9.3	121.7	9.6	128.9	123.3	122.0	132.4	130.0	15095.5
7b	9.0		9.4		124.1	121.9	132.7	130.5	
7c	9.5		9.8						
7d									
7e									
7f									
8a	9.3	121.9	9.6	128.9	123.4	121.9	132.4	129.6	14941.1
8b	9.2		9.4		124.2	121.9	132.6	129.9	
8c	9.3		9.5						
8d									
8e									
8f									
9a	9.3	129.4	9.1	121.7	127.7	127.0	123.8	120.4	15476.9
9b	9.3		9.2		128.8	126.1	123.6	120.5	
9c	9.3		9.0						
9d									
9e									
9f									
10a	9.2	129.5	9.2	121.5	127.5	127.2	123.5	120.5	15458.7
10b	9.4		9.2		128.9	126.2	123.6	120.6	
10c	9.3								
10d									
10e									
10f									

TABLE 3.2.1 (Part 3 of 3): Masonry Block Properties
Summary Table

Average S.D.	W Brick Width (mm)	L Brick Length (mm)	T Brick Thickness (mm)	L1 End Notch Length (mm)	W1 End Notch Width (mm)																		
	194.042	395.058	191.7713	18.651	19.2718267																		
	0.74851	3.04395	0.741718	0.4733	0.21900078																		
Average S.D.	L2T 1st Cell Top Length (mm)	W2T 1st Cell Top Width (mm)	L2B 1st Cell Bottom Length (mm)	W2B 1st Cell Bottom Width (mm)																			
	128.444	126.15	126.4691	123.74																			
	3.74831	3.02608	4.332805	3.8632																			
Average S.D.	L3T Slot Top Len. (mm)	W3T Slot Top Width (mm)	L3B Slot Bot. Len. (mm)	W3B Slot Bottom Width (mm)	L4T 2nd Cell Top Length (mm)																		
	9.28827	126.779	9.277096	123.8	128.36017																		
	0.21859	3.59242	0.240215	3.4449	3.6694867																		
Average S.D.	W4T 2nd Cell Top Width (mm)	L4B 2nd Cell Bottom Length (mm)	W4B 2nd Cell Bottom Width (mm)	M Individual Brick Weight (g)																			
	126.199	126.402	123.764	15249																			
	3.12274	4.28312	4.042952	202.35																			
Bounding Box Solid Volume [$V_s = (W \cdot L \cdot T) / 1000$. g/cc] Hole Volume [$V_h = \text{avg}(L1 \cdot W1 + L2 \cdot W2 + L3 \cdot W3 + L4 \cdot W4) \cdot T / 1000$. g/cc] True Solid Volume [$V_t = V_s - V_h$] True Material Density [$\rho = M / V_t$] Apparent (radar) Density [$\rho_{\text{app}} = M / V_s$] Where: W, L, T, D1, D2, D3, and M are defined in the above table $\pi = 3.14159$																							
<table border="1"> <thead> <tr> <th></th> <th></th> <th>Units</th> </tr> </thead> <tbody> <tr> <td>Vs</td> <td>14701</td> <td>cc</td> </tr> <tr> <td>Vh</td> <td>6398.9</td> <td>cc</td> </tr> <tr> <td>Vt</td> <td>8301.8</td> <td>cc</td> </tr> <tr> <td>rho</td> <td>1.8369</td> <td>g/cc</td> </tr> <tr> <td>rhoapp</td> <td>1.0373</td> <td>g/cc</td> </tr> </tbody> </table>								Units	Vs	14701	cc	Vh	6398.9	cc	Vt	8301.8	cc	rho	1.8369	g/cc	rhoapp	1.0373	g/cc
		Units																					
Vs	14701	cc																					
Vh	6398.9	cc																					
Vt	8301.8	cc																					
rho	1.8369	g/cc																					
rhoapp	1.0373	g/cc																					

3.3 Plain Concrete

Plain concrete specimens accounted for 24 of the 58 material specimens tested during this study. This high percentage relates to the variable nature of concrete and the affect its constituents have on the propagation of EM waves. In addition to the principal geometry variable (thickness), aggregate size, water/cement ratio, and slump were investigated. Each of the latter variables had two levels (high

and low) while three specimen thicknesses were used for all mixes. This led to 24 total specimens. The nominal specimen thicknesses, as shown below in Figure 3.3.1, were approximately 102 mm, 203 mm, and 305 mm. However, because of deformations in the concrete formwork (due to hydrostatic loading during casting), and due to the less precise method of manufacture

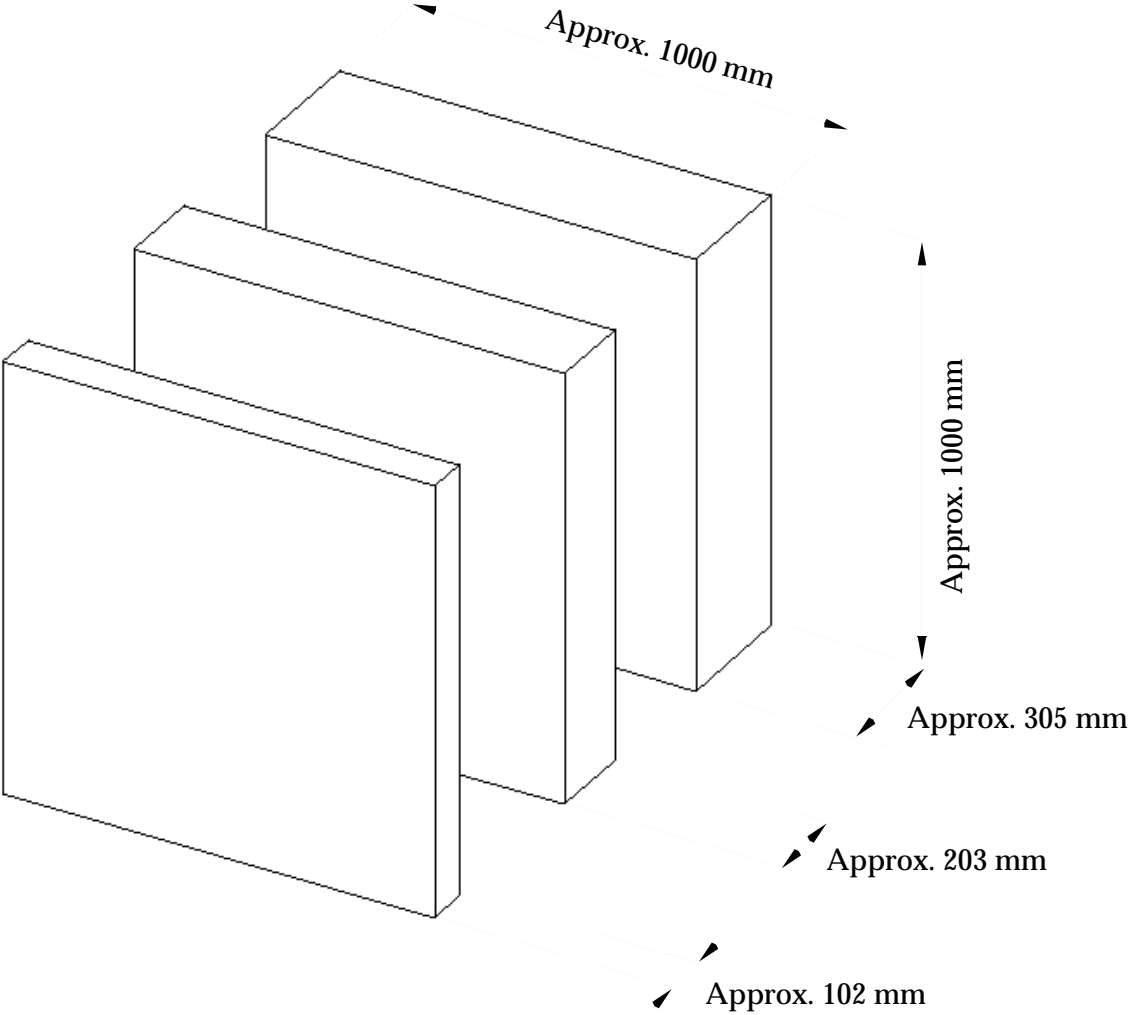

Figure 3.3.1: Plain concrete specimen geometry. Eight mixes were investigated for each of the three geometries shown above. Specific data for each specimen are given in Tables 3.3.1 through 3.3.3.

Table 3.3.1: Plain Concrete Wall Specimens, 101.6 mm Nominal Thickness. Actual specimen thicknesses along vertical and horizontal centerlines (mm) are listed below.

Horizontal Position from Side Edge (mm)	SPECIMEN NAME							
	C14	C24	C34	C44	C54	C64	C74	C84
50.8	105.7	103.4	103.7	102.7	101.9	103.9	99.9	103.8
152.4	107.1	104.0	103.9	103.0	101.7	104.0	100.0	104.8
254	108.0	104.4	104.1	103.4	101.7	99.5	100.4	105.3
355.6	108.6	104.6	104.0	103.9	101.5	103.3	101.1	105.8
457.2	109.2	105.0	104.1	103.9	101.9	103.4	101.8	105.9
558.8	109.4	104.9	104.2	103.9	102.2	102.7	102.7	105.8
660.4	109.1	104.6	104.3	103.6	102.3	102.4	103.2	105.7
762	108.7	104.1	103.8	103.6	102.0	102.3	104.0	105.4
863.6	108.2	103.3	103.5	103.3	101.9	102.3	104.4	104.2
965.2	107.5	102.1	103.3	103.1	102.1	102.4	104.6	102.3
Mean	108.1	104.0	103.9	103.4	101.9	102.6	102.2	104.9
S.D.	1.1	0.9	0.3	0.4	0.2	1.3	1.8	1.2

Vertical Position from Bottom Edge (mm)	SPECIMEN NAME							
	C14	C24	C34	C44	C54	C64	C74	C84
50.8	110.9	99.8	102.2	101.7	100.1	100.0	105.3	105.0
152.4	110.5	101.4	103.4	102.7	101.6	101.4	104.6	105.8
254	110.4	102.8	104.2	103.1	102.5	102.2	103.9	106.3
355.6	110.1	103.8	104.5	103.5	102.5	103.1	103.0	106.4
457.2	109.5	104.5	104.3	103.9	102.1	103.2	102.3	106.3
558.8	109.0	104.8	104.3	103.9	101.5	103.0	101.7	105.5
660.4	108.1	105.0	103.8	103.3	101.0	102.4	101.1	104.7
762	106.9	104.4	103.4	103.0	100.1	102.2	100.4	103.7
863.6	105.6	103.7	102.9	102.6	99.3	101.9	99.3	102.8
965.2	104.3	102.8	102.3	101.8	98.7	101.7	98.2	102.1
Mean	108.5	103.3	103.5	103.0	100.9	102.1	102.0	104.9
S.D.	2.3	1.6	0.8	0.8	1.3	1.0	2.3	1.5

Averaged Vertical and Horizontal Readings (Thickness & S.D.)								
Mean	108.3	103.7	103.7	103.2	101.4	102.4	102.1	104.9
S.D.	1.8	1.3	0.7	0.6	1.1	1.1	2.0	1.3

Table 3.3.2: Plain Concrete Wall Specimens, 203.2 mm Nominal Thickness. Actual specimen thicknesses along vertical and horizontal centerlines (mm) are listed below.

Horizontal Position from Side Edge (mm)	SPECIMEN NAME									
	C18	C28	C38	C48	C58	C68	C78	C88	RC881	RC882
50.8	201.5	203.8	203.3	202.6	202.4	202.9	202.5	203.0	207.6	205.9
152.4	201.8	204.1	203.6	202.5	203.1	203.2	203.1	203.1	208.5	206.6
254	201.9	204.1	203.9	202.6	203.7	203.5	203.3	202.6	209.4	206.7
355.6	202.1	204.1	204.2	202.6	204.5	204.2	202.7	202.2	210.3	206.8
457.2	202.4	204.4	204.3	202.6	205.0	204.8	202.5	202.1	210.6	206.9
558.8	202.4	204.4	203.9	202.7	204.8	204.9	202.1	201.9	210.9	206.7
660.4	202.7	204.3	203.5	202.8	204.5	204.7	201.5	201.9	210.5	206.6
762	202.8	204.1	203.1	202.8	204.1	203.8	201.0	202.1	209.7	206.4
863.6	202.8	203.6	202.4	202.6	203.4	203.0	200.9	202.5	208.6	205.9
965.2	202.5	203.4	201.6	202.5	204.3	202.7	200.6	203.1	207.6	205.1
Mean	202.3	204.0	203.4	202.6	204.0	203.8	202.0	202.5	209.4	206.4
S.D.	0.4	0.3	0.8	0.1	0.8	0.8	1.0	0.5	1.2	0.5

Vertical Position from Bottom Edge (mm)	SPECIMEN NAME									
	C18	C28	C38	C48	C58	C68	C78	C88	RC881	RC882
50.8	203.9	204.7	206.1	203.7	204.8	206.6	200.2	204.6	207.9	202.9
152.4	203.5	205.0	205.3	203.8	204.8	206.2	200.8	203.9	208.9	203.9
254	203.1	204.8	204.7	203.8	204.6	205.9	201.4	203.3	209.7	204.8
355.6	202.9	204.8	204.4	203.0	204.7	203.4	201.7	202.7	210.4	205.8
457.2	202.6	204.6	203.9	202.7	204.8	204.8	202.1	202.1	210.8	206.4
558.8	202.1	204.4	203.6	202.5	204.9	204.6	201.9	201.7	210.6	206.6
660.4	201.8	204.7	203.3	201.9	204.4	204.3	201.8	201.5	210.2	206.6
762	201.3	204.5	203.3	201.7	204.6	204.1	201.5	201.4	209.5	206.6
863.6	201.2	204.7	203.3	201.4	204.7	203.9	201.7	201.5	208.8	206.0
965.2	201.3	204.5	203.3	201.0	204.5	203.3	202.0	201.5	208.4	205.3
Mean	202.4	204.7	204.1	202.6	204.7	204.7	201.5	202.4	209.5	205.5
S.D.	1.0	0.2	1.0	1.0	0.1	1.2	0.6	1.1	1.0	1.3

Averaged Vertical and Horizontal Readings (Thickness & S.D.)										
Mean	202.3	204.4	203.8	202.6	204.3	204.2	201.8	202.4	209.5	205.9
S.D.	0.7	0.4	1.0	0.7	0.7	1.1	0.8	0.9	1.1	1.0

Table 3.3.3: Plain Concrete Wall Specimens, 304.8 mm Nominal Thickness. Actual specimen thicknesses along vertical and horizontal centerlines (mm) are listed below.

Horizontal Position from Side Edge (mm)	SPECIMEN NAME							
	C112	C212	C312	C412	C512	C612	C712	C812
50.8	307.1	312.7	306.9	307.0	306.3	308.3	304.4	308.8
152.4	307.4	310.9	307.7	308.2	305.6	308.6	305.9	309.6
254	307.5	311.4	308.4	308.8	305.0	309.0	307.2	310.5
355.6	307.6	311.6	308.5	309.4	304.8	308.9	308.1	311.1
457.2	308.0	311.8	308.6	309.8	305.0	308.8	308.4	311.7
558.8	308.0	311.8	308.8	310.0	305.0	308.8	308.4	311.9
660.4	308.0	311.5	308.7	309.9	305.0	308.5	307.8	311.3
762	307.9	311.2	308.7	309.6	305.5	308.5	307.2	310.7
863.6	307.4	310.7	308.6	309.2	305.5	307.6	306.9	309.7
965.2	307.0	309.8	308.2	308.5	305.7	306.7	306.0	308.6
Mean	307.6	311.3	308.3	309.0	305.3	308.4	307.0	310.4
S.D.	0.4	0.8	0.6	1.0	0.5	0.7	1.3	1.2

Vertical Position from Bottom Edge (mm)	SPECIMEN NAME							
	C112	C212	C312	C412	C512	C612	C712	C812
50.8	306.0	308.7	304.1	306.0	306.6	305.9	307.4	307.9
152.4	306.8	310.3	306.0	307.5	306.7	307.1	308.4	310.0
254	307.6	311.5	307.3	307.3	306.5	308.0	309.1	311.4
355.6	307.9	312.1	308.0	309.4	306.1	308.6	309.2	312.0
457.2	307.9	312.1	308.4	309.8	305.3	308.8	308.8	311.9
558.8	307.9	311.6	308.8	309.9	304.5	308.4	308.3	311.4
660.4	307.7	311.1	309.0	309.8	304.1	307.2	307.9	310.5
762	307.3	310.2	308.6	309.5	303.6	305.9	307.2	309.5
863.6	306.4	309.0	308.4	308.8	303.0	304.7	306.4	308.5
965.2	305.6	310.3	308.1	308.5	302.3	303.0	305.7	307.3
Mean	307.1	310.7	307.7	308.6	304.9	306.8	307.9	310.0
S.D.	0.9	1.2	1.5	1.3	1.6	1.9	1.2	1.7

Averaged Vertical and Horizontal Readings (Thickness & S.D.)								
Mean	307.4	311.0	308.0	308.8	305.1	307.6	307.4	310.2
S.D.	0.7	1.0	1.2	1.1	1.2	1.6	1.3	1.4

Table 3.3.4: Measured Concrete Mix Properties, as delivered to the Laboratory

Properties	Batch 1	Batch 2	Batch 3	Batch 4	Batch 5	Batch 6	Batch 7	Batch 8
Job #	203	204	135	136	77	78	79	80
Truck	196	198	196	164	153	153	153	153
Cement (kg)	468.2	538.6	309.1	365.9	418.2	477.3	281.8	431.8
Water (kg)	132.7	135.6	136.6	134.7	101.3	104.7	113.9	157.1
Additional Water (kg)	0*	75.8	11.4	18.9	147.6	151.4	49.3	0**
Total Water (kg)	132.7	211.4	148.0	153.6	248.9	256.1	163.2	157.1
Coarse Aggregate (kg)	805.6	774.1	774.1	778.6	1206.4	1251.6	1057.6	1431.1
Fine Aggregate (kg)	753.3	666.7	913.4	794.1	519.5	506.5	783.0	987.4
Nominal Volume Delivered (m ³)	0.956	0.956	0.956	0.956	0.956	0.956	0.956	1.338
Measured Density (kg/m ³)	2311	2311	2295	2300	2424	2387	2384	2392
Air Content (%)	2.0	1.3	N/A	1.3	1.5	1.0	1.4	N/A
Slump (mm)	57	165	64	222	76	171	83	165
Compressive Strength:								
f'c (test 1, 28 days) [MPa]	44.1	38.5	31.9	30.1	32.1	33.0	29.7	31.2
f'c (test 2, 28 days) [MPa]	43.6	39.6	33.8	29.4	32.6	32.7	29.8	31.9
f'c (test 3, 28 days) [MPa]	44.0	40.4	30.5	29.0	33.8	35.1	29.4	31.4
28-day strength (avg) [MPa]	43.9	39.5	32.1	29.5	32.8	33.6	29.6	31.5
Mean Size Aggregate (mm)	12.7	12.7	12.7	12.7	25.4	25.4	25.4	25.4
Actual Water/Cement Ratio	0.28*	0.39	0.48	0.42	0.60	0.54	0.58	0.36**
Desired Water/ Cement Ratio	0.4	0.4	0.4	0.4	0.6	0.6	0.6	0.6
* Measurements of the amount of water added on site were missing from the delivery ticket.								
** Measurements of the amount of water added on site were missing from the delivery ticket.								

(as compared to, e.g. a sheet of glass or plywood) measurable variances (on the order of a few millimeters) in specimen thickness across the width and height of the concrete specimens were noted in some cases. For completeness, Tables 3.3.1, 3.3.2, and 3.3.3 list precise thicknesses along the vertical and horizontal centerlines of all concrete specimens. These were measured using a digital caliper with a spanner frame accurate to 0.01 mm (see the photo on the cover).

added on site for those two batches was, unfortunately, not reported on the delivery ticket. For comparison, the desired w/c ratio for each mix is listed on the final row of Table 3.3.4, which shows general agreement with the remaining measured values.

Table 3.3.4, above, lists the measured properties of the as-delivered concrete mixes. For the most part these numbers closely match the desired numbers listed in Table 2.4. However the reported water/cement ratio for Batches 1 and 8 are incomplete. The quantity of water

3.4 Reinforced Concrete and Rebar Grid Specimens

Two reinforced concrete specimens were fabricated for comparison with the 203 mm thick Batch #8 plain concrete specimen. Other than the presence of a reinforcing bar grid on the centerline of each of specimens RC881 and RC882, these were identical in all respects to specimen C88 and were cast at the same time using the same concrete batch. Specimen RC881 had 1% reinforcing steel content. This was achieved using 19 mm [#6] Grade 60 rebar on a 140 mm square grid. Specimen RC882 had 2% reinforcing steel and utilized the same square grid format as RC881 but with half the bar spacing distance (70 mm).

Details of the reinforced concrete specimens are given in Figures 3.4.1 and 3.4.2.

To allow examination of superposition effects, duplicate rebar grids (identical to the ones embedded in specimens RC881 and RC882) were tested in air. Geometry for these grids are given in Figures 3.4.3 and 3.4.4. All grids were constructed from 19 mm (#6) Grade 60 reinforcement.

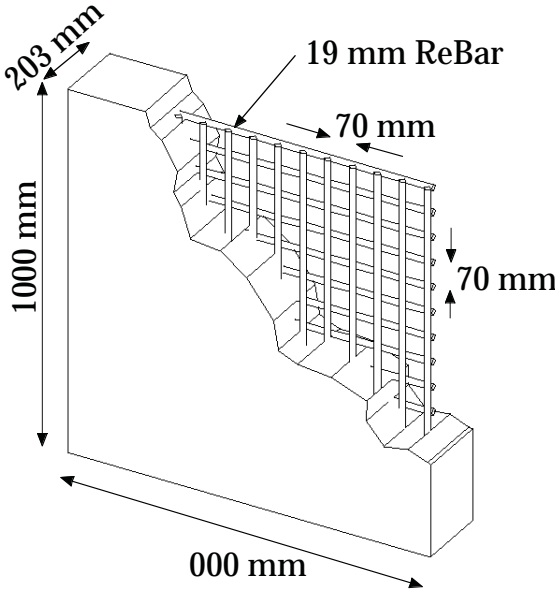
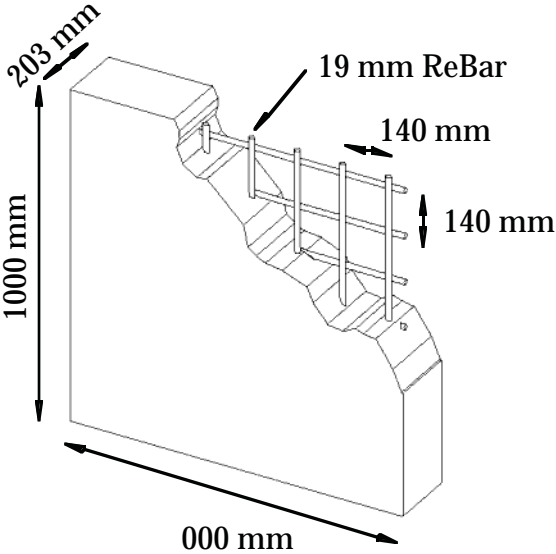

Figure 3.4.1: Reinforced concrete specimen RC881, nominally 203 mm thick, Batch #8 concrete mix with 1% steel.

Figure 3.4.2: Reinforced concrete specimen RC882, nominally 203 mm thick, Batch #8 concrete mix with 2% steel.

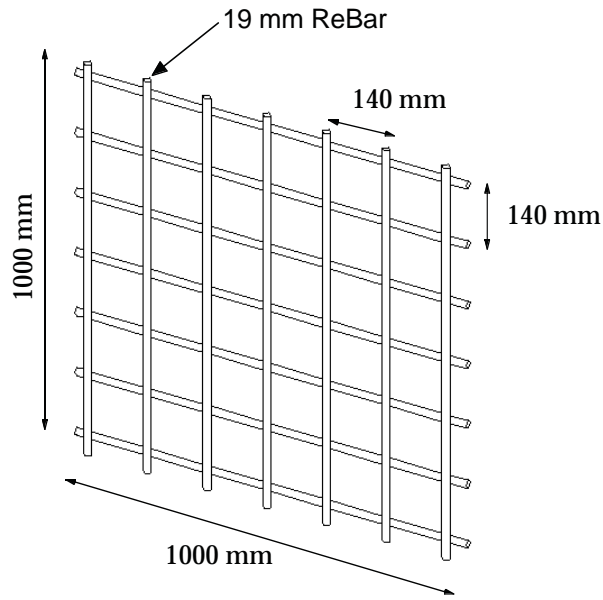

Figure 3.4.3: Bare rebar grid (the same as used in reinforced concrete specimen RC881). Seven 19 mm bars each in the horizontal and vertical directions were used to create a square mesh with 140 mm spacing between bar centers. This left open areas measuring 121 mm square for an open area to solid ratio of 75.2%

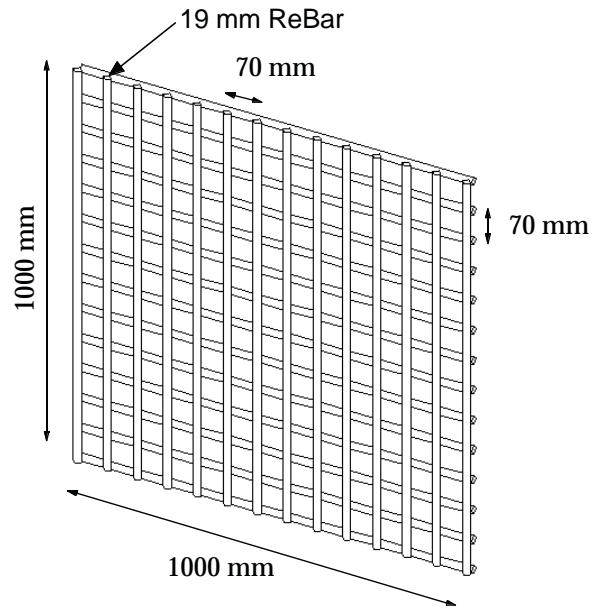

Figure 3.4.4: Bare rebar grid (the same as used in reinforced concrete specimen RC882). Fourteen 19 mm bars each in the horizontal and vertical directions were used to create a square mesh with 70 mm spacing between bar centers. This left open areas measuring 51 mm square for an open area to solid ratio of 53.9%

3.5 Glass

The glass used in this study was an ordinary architectural window glass produced by Libbey Owens Ford (Pilkington Group, Toledo, Ohio). Specifically it was soda-lime silica float glass with the dimensions and properties shown in Figure 3.5.1 and in Tables 3.5.1 through 3.5.3. Three thicknesses of 5.7, 12.5, and 18.6 mm were tested.

The main constituent (comprising 72% by mass) of the glass is silicon dioxide.

Sodium oxide is added as a flux for melting temperature reduction in the form of soda ash. Further additives, in the form of calcium oxide (from limestone) and magnesium oxide (from dolomite) are typically added to improve durability. Small amounts of iron oxide and aluminum oxide are also added to further reduce melting temperature and improve durability. The other components listed in Table 3.5.1 are trace contaminants.

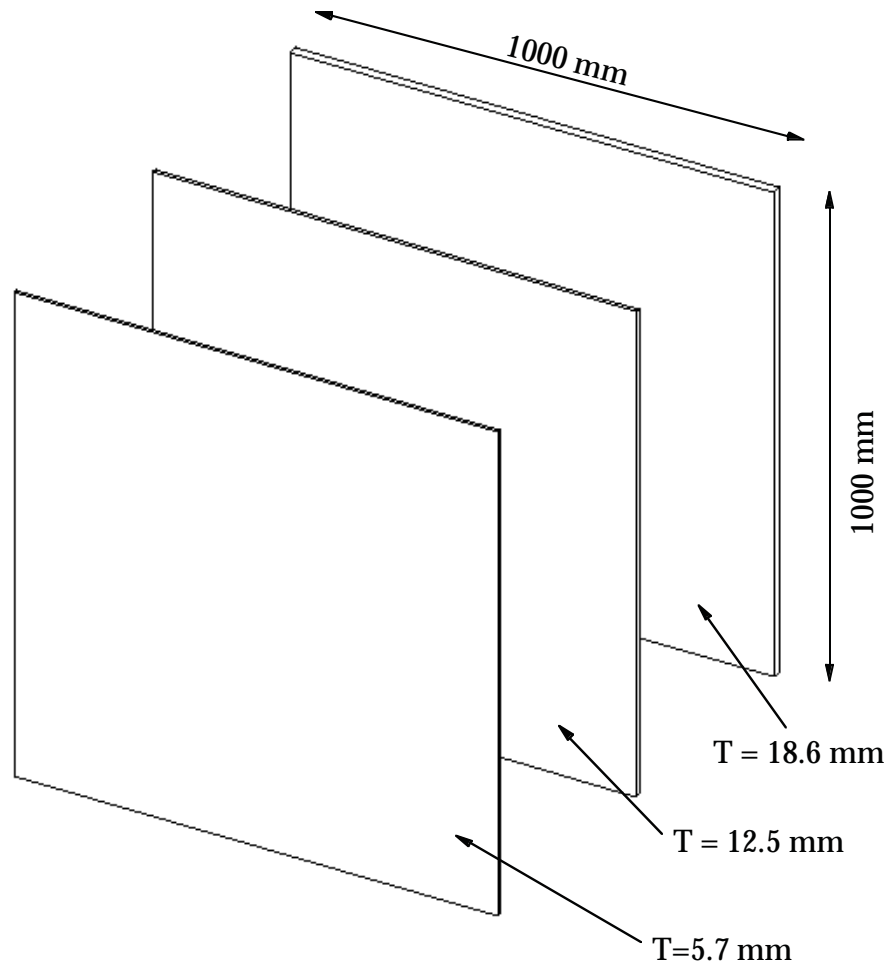

Figure 3.5.1: Glass panel specimens used in the Phase II NLS study. Thicknesses are measured average values. Properties are presented in Tables 3.5.1 through 3.5.3.

Table 3.5.1: Nominal composition of soda-lime silica float glass.

Material	Percent of Total Content
	(approximate)
SiO ₂	72
CaO (calcium oxide, from limestone)	8.4
Fe ₂ O ₃ (iron oxide, residual impurities)	0.11
Al ₂ O ₃ (aluminum oxide, residual impurities)	1.1
MgO (magnesium oxide, from dolomite)	3.9
Na ₂ O (sodium oxide, from soda ash)	13.9
K ₂ O (potassium oxide)	0.6
SO ₃ (sulphur trioxide, from salt cake)	0.2

Table 3.5.2: Properties of soda-lime silica float glass (source: Libbey Owens Ford, Toledo, Ohio).

Modulus of Rupture in Flexure for 60-second Load Duration	
Mean Value	41 MPa (6000 psi) Annealed
	82 MPa (12000 psi) Heat Strengthened
	165 MPa (24000 psi) Tempered
Typical Design Value (probability of breakage 0.8%)	19 MPa (2800 psi) Annealed
	39 MPa (5600 psi) Heat Strengthened
	77 MPa (11200 psi) Tempered
Modulus of Elasticity	72000 MPa (10,400,000 psi)
Modulus of Rigidity (Shear)	30000 MPa (4,300,000 psi)
Bulk Modulus	43000 MPa (6,200,000 psi)
Poisson's Ratio	0.23
Density (nominal)	2.53 g/cc (158 lb/ft ³)
Coefficient of Thermal Stress	0.62 MPa/C (50 psi/F)
Thermal Conductivity at 24C	0.937 W-m/m ² - C (6.5 Btu-in/hr-F-ft ²)
Specific Heat at 24C	0.88 kJ/kg-C (0.21 Btu/lbm-F)
Coefficient of Linear Expansion (24C-300C)	8.3(10) ⁻⁶ mm/mm-C (4.6(10) ⁻⁶ in/in-F)
Hardness (Moh's Scale)	6
Softening Point (ASTM C338)	715 C (1219 F)
Annealing Point (ASTM C336)	548 C (1018 F)
Strain Point (ASTM C336)	511 C (952 F)
Index of Refraction	
at 5(10) ¹⁴ Hz	1.523
at 3(10) ¹⁴ Hz	1.511
at 1.5(10) ¹⁴ Hz	1.499
Emissivity (Hemispherical) at 24C	0.84

Table 3.5.3: Measured Geometry, Mass, and Density for Glass Specimens Tested at NIST.

NLS Phase II Tests: **GLASS** Specimens

MEASURED Specimen Thicknesses along Horizontal and Vertical Edges (mm)

Measurement Number	SPECIMEN NAME		
	G25	G50	G75
1	5.64	12.50	18.64
2	5.69	12.50	18.62
3	5.72	12.50	18.62
4	5.72	12.47	18.62
5	5.74	12.50	18.59
6	5.64	12.52	18.59
7	5.64	12.57	18.59
8	5.64	12.57	18.59
9	5.64	12.57	18.59
10	5.69	12.57	18.59
11	5.69	12.50	18.59
12	5.69	12.47	18.59
Thickness (mm)	5.68	12.52	18.60
S.D. (mm)	0.04	0.04	0.02
WidTop (mm)	1016.8	1016.8	1016.8
WidMid(mm)	1016.8	1016.8	1017.6
WidBot(mm)	1016.8	1016.8	1016.8
Avg. Wid(mm)	1016.8	1016.8	1017.1
HeightTop(mm)	1018.4	1019.2	1017.6
HeightMid(mm)	1018.4	1019.2	1019.2
HeightBot(mm)	1018.4	1019.2	1018.4
Avg.Height(mm)	1018.4	1019.2	1018.4
Weight (g)	14618.8	31961.6	47897.0
Density (g/CC)	2.49	2.46	2.49

G25 = nominally 6.35 mm thick glass

G50 = nominally 12.70 mm thick glass

G75 = nominally 19.05 mm thick glass

3.6 Lumber

The U.S. Span Book for Major Lumber Species states that “more than 90%” of dimension lumber used in North America comes from four commercial species groups: Spruce-Pine-Fir; Douglas Fir-Larch; Hemlock-Fir, and Southern Pine.

Typical mechanical properties for the above four types of common construction lumber are given in Table 3.6.1. Unless specifically requested, one may be likely to receive any of the above species when asking for, as an example, a “2x12” (38 x 292 mm) residential construction plank. Further information on material properties for these general species of lumber is available from the Southern Forest Products Association (New Orleans, LA); the Southern Pine Inspection Board (Pensacola, FL); and the Canadian Wood Council (Ottawa, ON).

As can be seen from Table 3.6.1, the mechanical properties of all of the above species are similar. The specific type and grade obtained for the NLS Phase 2 tests was an off-the-rack “2x12x12-ft” (38 x 292 x 3658 mm) plank from the Lowe’s home improvement center in Gaithersburg,

Maryland. The plank was manufactured by Finlay Forest Industries (Canada) with the specification KD-SPF #2 & Better, which stands for: “Kiln Dried, Spruce-Pine-Fir, Grade #2.”

A single “2x12” plank was too narrow to meet the nominal 1x1 m square specimen size selected for the NLS Phase 2 test setup. Composite specimens were thus built up as shown in Figures 3.6.1 through 3.6.4. The nominal 37 mm thick specimen was constructed of one layer of planks; the 75 mm thick specimen of two layers; the 113 mm thick specimen of three layers; and the 151 mm thick specimen of four layers. In all cases the planks were hammered firmly in contact with one another prior to edge nailing (there were no nails within the central portion of the specimen where the measurements would be made). For specimens with more than one layer, each layer was alternated with horizontal and vertical layers in order to average the affects of stud joints.

Both dry and wet specimens were tested. Dry specimen names have a “D” suffix; while wet specimen names have a “W”

Species Group	Grade	Extreme Fiber Stress in Bending MPa	Tension Parallel to Grain MPa	Horizontal Shear Strength MPa	Compressive Strength Perpendicular MPa	Compressive Strength Parallel MPa	Modulus of Elasticity (psi) GPa
Spruce-Pine-Fir	No. 2	6.03	2.93	0.48	2.93	7.58	9.65
Douglas Fir-Larch	No. 2	5.69	3.45	0.65	4.31	9.31	11.03
Hemlock-Fir	No. 2	6.89	3.79	0.52	2.55	10.00	11.03
Southern Pine	No. 2	6.72	3.79	0.62	3.90	10.00	11.03

Table 3.6.1: Typical mechanical properties for the four most common species of construction lumber (source: Canadian Wood Council).

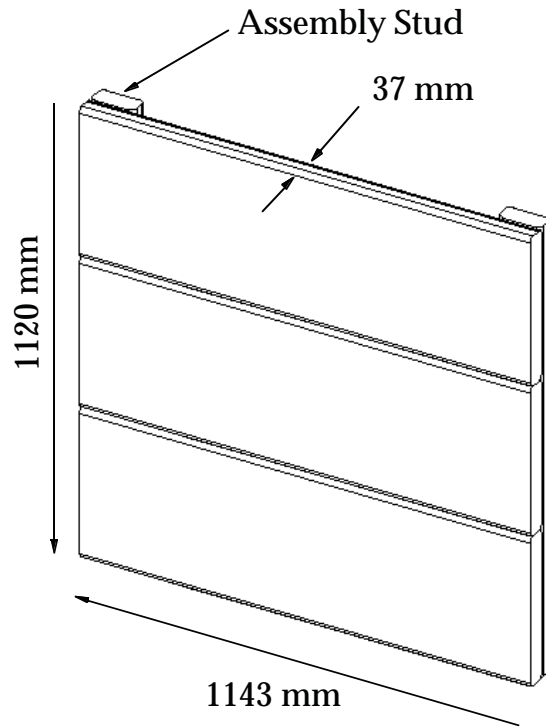

Figure 3.6.1: Specimen L15, a single layer built-up lumber specimen consisting of three “2x12” planks mounted on a “2x4” exterior frame. Both dry and wet specimens were tested.

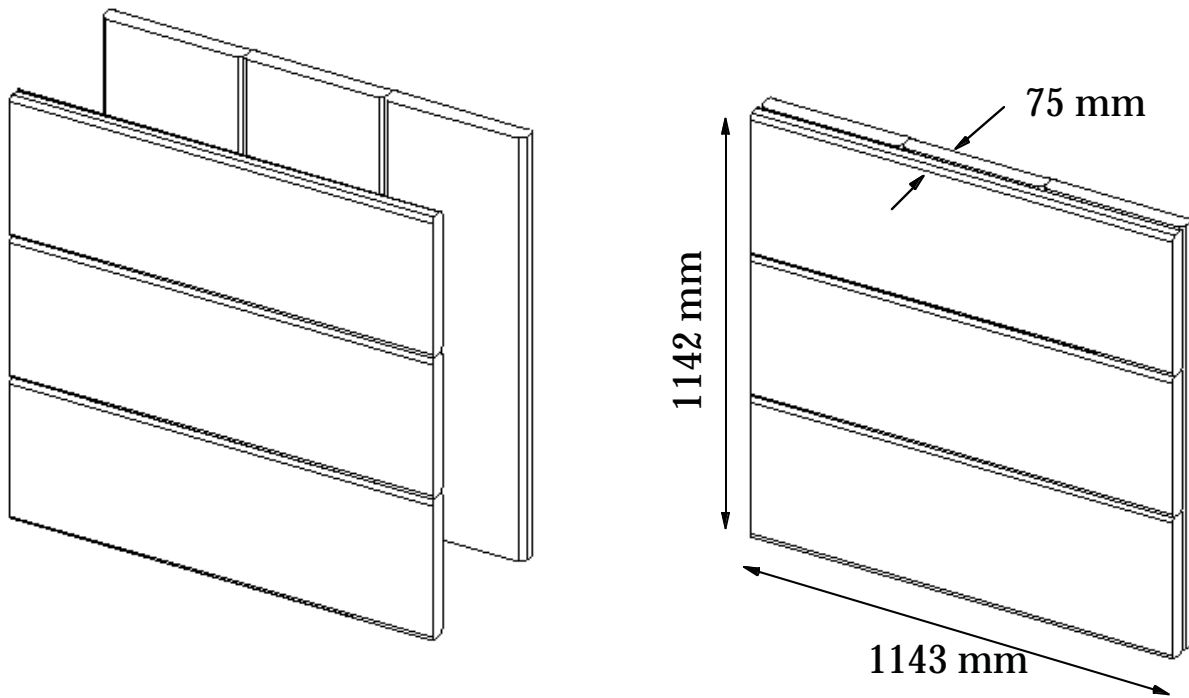

Figure 3.6.2: Specimen L30, a double layer built-up lumber specimen consisting of six “2x12” planks. Both dry and wet specimens were tested.

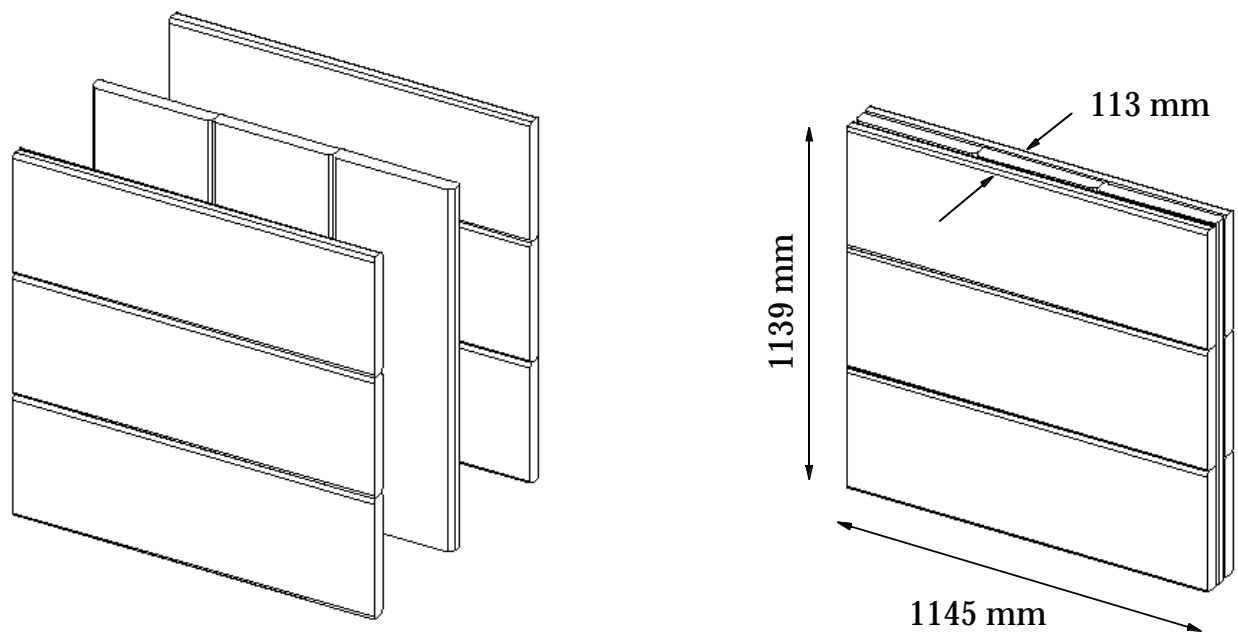

Figure 3.6.3: Specimen L45, a triple layer built-up lumber specimen consisting of nine “2x12” studs. Both dry and wet specimens were tested.

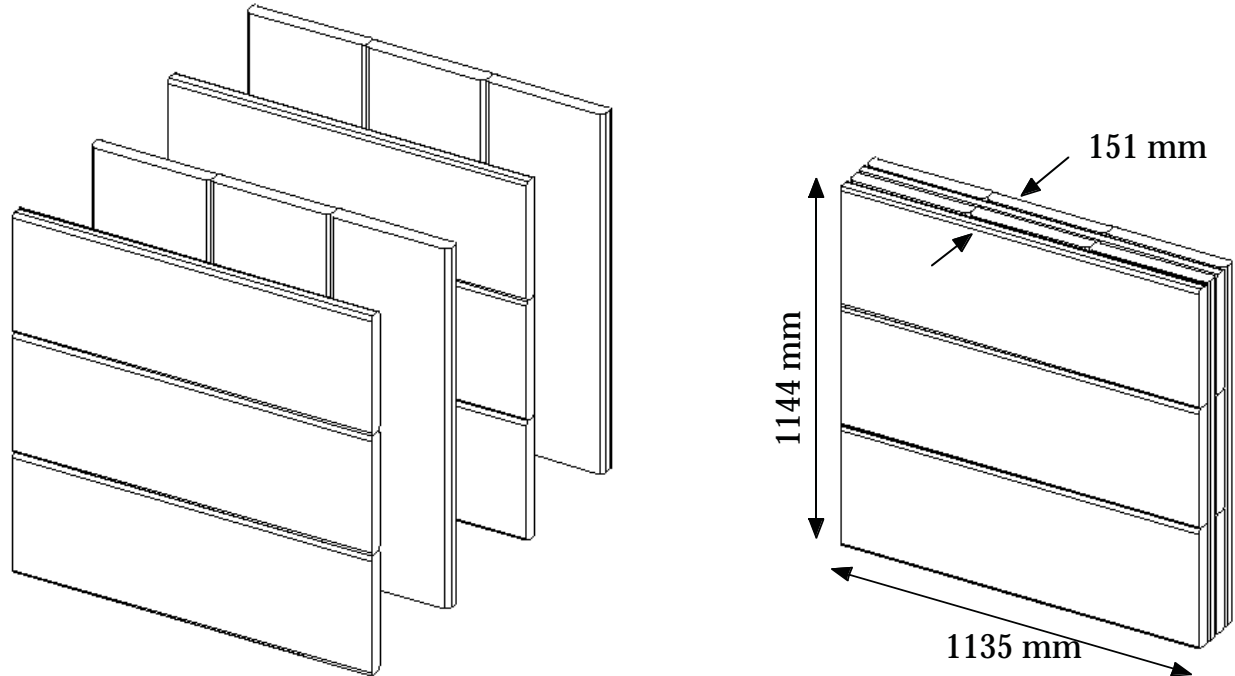

Figure 3.6.4: Specimen L60, a quadruple layer built-up lumber specimen consisting of twelve “2x12” studs. Both dry and wet specimens were tested.

suffix. The “wet” specimens were prepared using the following procedure. First, identical specimens to the dry specimens were set up vertically inside a plastic “tent” area. A garden sprinkler system was activated within this tent such that all specimens were in the line

of spray on both sides. The spray was maintained for four hours after which the specimens were allowed to “drip dry.” They were then weighed and tested within two hours of termination of the soaking. Measured densities for both wet and dry specimens are given in Table 3.6.2.

Figure 3.6.2: Pine Specimen Geometry and Properties for NLS Phase 2 Tests

NLS Phase II Tests: PINE Specimens								
MEASURED Specimen Thicknesses along Horizontal Centerline (mm)								
Measurement Number	SPECIMEN NAME							
	L15D	L15W	L30D	L30W	L45D	L45W	L60D	L60W
Thickness 1	36.9	x	75.2	x	112.7	x	151.6	x
Thickness 2	36.5	x	75.4	x	113.5	x	151.2	x
Thickness 3	38.0	x	75.6	x	112.7	x	151.1	x
Thickness 4	36.8	x	76.2	x	113.1	x	149.8	x
Thickness 5	37.4	x	74.8	x				
Thickness 6	37.4	x	75.3	x				
Thickness 7	36.9	x						
Thickness 8	37.6	x						
Thickness 9	36.7	x						
Thickness 10	36.9	x						
Thickness 11	36.2	x						
Thickness 12	37.1	x						
Mean	37.0		75.4		113.0		150.9	
S.D.	0.5		0.5		0.4		0.8	
WidTop (mm)	1142.2	x	1143.8	x	1144.6	x	1135.1	x
WidMid(mm)	1141.4	x	1143.8	x	1144.6	x	1135.1	x
WidBot(mm)	1146.2	x	1143.8	x	1144.6	x	1135.1	x
Avg. Wid(mm)	1143.3	x	1143.8	x	1144.6	x	1135.1	x
HeightTop(mm)	1120.8	x	1139.8	x	1136.7	x	1143.8	x
HeightMid(mm)	1120.8	x	1142.2	x	1139.8	x	1144.6	x
HeightBot(mm)	1118.4	x	1143.0	x	1141.4	x	1144.6	x
Avg.Height(mm)	1120.0	x	1141.7	x	1139.3	x	1144.3	x
Volume (cc)	47419.1	47419.1	98489.9	98489.9	147338.0	147338.0	196023.7	196023.7
Weight (grams)	19385.8	20293.8	40179.0	41858.8	62742.8	64150.2	83399.8	84761.8
Density (g/CC)	0.409	0.428	0.408	0.425	0.426	0.435	0.425	0.432
L15D = nominally 1-1/2 inch thick lumber panel (built up), DRY L15W = nominally 1-1/2 inch thick lumber panel (built up), WET L30D = nominally 3 inch thick lumber panel (built up) DRY L30W = nominally 3 inch thick lumber panel (built up) WET L45D = nominally 4-1/2 inch thick lumber panel (built up) DRY L45W = nominally 4-1/2 inch thick lumber panel (built up) WET L60D = nominally 6 inch thick lumber panel (built up) DRY L60W = nominally 6inch thick lumber panel (built up) WET								

3.7 Plywood

Three nominal thickness plywood panel specimens were fabricated using 6.3 mm [1/4 in], 11.8 mm [1/2 in], and 18.8 mm [3/4 in] plywood as shown in Figure 3.7.1. A fourth thickness was created by doubling specimens P50 and P75 to form the composite specimen P125 (nominally 31 mm thick). The measured specimen thicknesses differed significantly from the nominal warehouse label values (see Table 3.7.1).

The plywood used in this study met the PS-1-83 material and fabrication specification developed by the American Plywood Association (since superseded

by PS-1-95). All were of resin joined, hot-pressed construction with an A-C Exterior-use rating. The 19 mm specimens were manufactured by Lane Plywood Corp., while the 6 and 12 mm panels were manufactured by Roseburg.

Both dry and wet specimens were tested. Dry specimen names have a “D” suffix; while wet specimen names have a “W” suffix. The “wet” specimens were prepared using the same procedure as for the lumber specimens. Measured densities for both wet and dry specimens are given in Table 3.7.1.

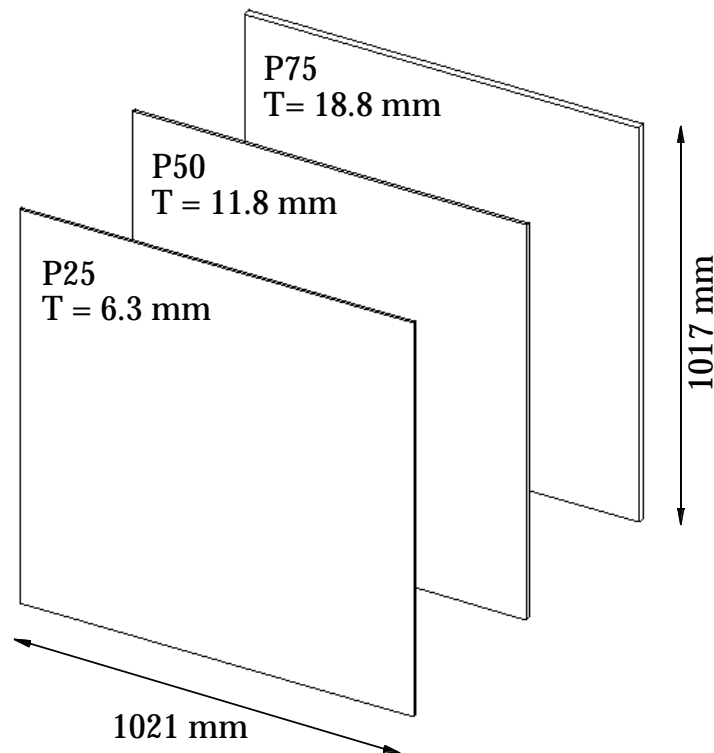

Figure 3.7.1: Nominal Geometry for Plywood Specimens Tested during the NLS Phase 2 experiments. The nominal thicknesses differed substantially from the measured ones (see Table 3.7.1).

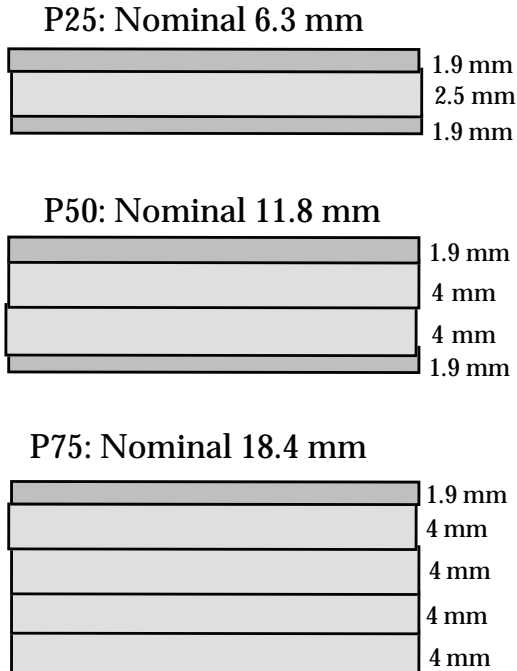

Figure 3.7.2: Measured nominal cross sections layups typical for the three types of plywood used in the NLS Phase 2 tests. The fine-hatched layers are exterior veneer; the coarse-hatched layers are interior laminates. Specimen P75 had only one exterior veneer layer.

Typical plywood laminate geometry is shown in Figure 3.7.2. In all cases except the 18.4 mm panels, an exterior veneer was bonded to both external surfaces. This veneer surface was usually sanded smooth to a nominally specified material thickness. The veneer measured approximately 2 mm thick while the central laminates averaged 4 mm thick. The 18.4 mm thick panels had exterior veneer on only one side.

Table 3.7.1: Measured Plywood Specimen Geometry, Mass and Density Data. Both dry and wet specimens were tested.

MEASURED Specimen Thicknesses along Horizontal and Vertical Centerlines (mm)

Measurement Number	SPECIMEN NAME					
	P25D	P50D	P75D	P25W	P50W	P75W
1	6.5	12.5	18.5	6.4	11.8	18.6
2	6.5	12.2	18.5	6.3	11.9	18.7
3	6.2	12.0	18.5	6.2	11.5	18.6
4	6.4	11.7	18.4	6.4	11.9	18.9
5	6.2	11.6	18.4	6.3	11.6	18.9
6	6.1	12.1	18.3	6.3	11.6	18.8
7	6.4	11.5	18.5	6.3	12.2	18.7
8	6.2	11.4	18.4	6.5	12.4	18.7
9	6.2	11.5	18.5	6.5	12.2	18.7
10	6.2	11.7	18.4	6.2	11.5	18.7
11	6.2	11.5	18.4	6.1	11.5	18.7
12	6.4	11.5	18.4	6.3	12.0	18.6
Mean	6.3	11.8	18.4	6.3	11.8	18.7
S.D.	0.1	0.3	0.1	0.1	0.3	0.1
WidTop (mm)	1020.8	1017.6	1017.6	1020.8	1022.4	1020.8
WidMid(mm)	1020.8	1016.8	1017.6	1020.8	1022.4	1020.8
WidBot(mm)	1020.8	1017.6	1017.6	1020.8	1022.4	1020.8
Avg. Wid(mm)	1020.8	1017.3	1017.6	1020.8	1022.4	1020.8
HeightTop(mm)	1017.6	1016.8	1016.0	1017.6	1019.2	1017.6
HeightMid(mm)	1017.6	1016.0	1016.0	1017.6	1019.2	1019.2
HeightBot(mm)	1016.8	1016.8	1016.0	1016.8	1018.4	1019.2
Avg.Height(mm)	1017.3	1016.5	1016.0	1017.3	1018.9	1018.6
Weight (g)	3686.5	6174.4	8853.0	3686.5	6178.9	8762.2
Density (g/CC)	0.565	0.508	0.465	0.563	0.501	0.450

- P25D = nominally 6.35mm thick, dry panel
- P50D = nominally 12.7 mm thick, dry panel
- P75D = nominally 19.05 mm thick, dry panel
- P25W = nominally 6.35 mm thick, saturated (wet) panel
- P50D = nominally 12.7 mm thick, saturated (wet) panel
- P75D = nominally 19.05 mm thick, saturated (wet) panel

3.8 Drywall

Drywall is typically used for interior wall and ceiling panels in most residential and some commercial construction. Typically, 12.7 mm panels are used for ceilings and single layer applications; 9.5 mm panels are used principally in the double wall system over wood framing and in repair and remodeling; and 6.3 mm panels are used as a base layer for improving sound control in double layer steel and wood stud partitions, and for use over old wall and ceiling surfaces. The latter is sometimes referred to as “ sound deadening board.”

The commercial brand known as SHEETROCK (R) manufactured by the United States Gypsum Company (Chicago, IL) was used in the present study. Nominal thicknesses of 6.3 mm

(1/4 in), 9.5 mm (1/2 in), and 12.7 mm (5/8 in) were tested. Nominal specimen geometries are given in Figure 3.8.1. Actual measurements of drywall panel thickness, mass, and density are presented in Table 3.8.2.

Table 3.8.1 provides a listing of the material composition of the drywall used in this study.

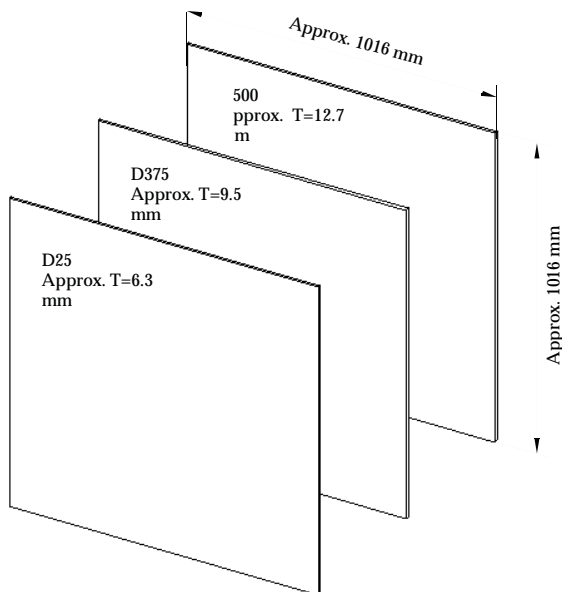

Figure 3.8.1: Nominal Geometry for Plywood Specimens Tested during the NLS Phase 2 experiments.

Material	% composition
Gypsum	85-95
Paper (cellulose fiber)	3-9
Starch	0.3-1
Glass fiber	0-1
Sucrose	0-1
Lignin Sulfonates	0-1
Sulfonated Naphthalene	0-1
Polyvinyl Alcohol	0-0.10
Calcium Stearate	0-0.01
Ammonium Salt	0-0.01
Pentasodium Salt	0-0.01
Boric Acid	0-0.01
Glycerin	0-trace

Table 3.8.1: SHEETROCK (R) material composition [source: U.S. Gypsum].

Table 3.8.2: Measured Drywall Specimen Geometry, Mass and Density Data.

NLS Phase II Tests: **DRYWALL** Specimens

MEASURED Specimen Thicknesses along Horizontal and Vertical Edges (mm)

Measurement Number	SPECIMEN NAME		
	D25	D375	D50
1	6.86	9.40	12.45
2	6.96	9.47	12.47
3	6.60	9.50	12.47
4	6.99	9.47	12.52
5	6.96	9.45	12.60
6	6.96	9.40	12.52
7	7.01	9.50	12.55
8	7.01	9.53	12.55
9	7.09	9.25	12.52
Mean Thickness	6.94	9.44	12.52
S.D.	0.14	0.09	0.05
WidTop (mm)	1016.0	1016.0	1014.4
WidMid(mm)	1015.2	1016.0	1015.2
WidBot(mm)	1015.2	1016.8	1016.8
Avg. Wid(mm)	1015.5	1016.3	1015.5
HeightTop(mm)	1016.0	1016.8	1016.8
HeightMid(mm)	1016.0	1016.8	1016.8
HeightBot(mm)	1016.0	1019.2	1018.4
Avg.Height(mm)	1016.0	1017.6	1017.3
Weight (g)	6197.1	6401.4	8376.3
Density (g/CC)	0.87	0.66	0.65

D25 = nominally 6.35 mm thick drywall
 D375 = nominally 9.53 mm thick drywall
 D50 = nominally 12.70 mm thick drywall

4.0 Response Spectra

In this chapter we present a compact but complete summary of the received signal amplitude as a function of frequency for various target thicknesses. These data have been calibrated, or normalized, with respect to a similarly recorded measurement with no target material between the transmitter and receiver.

The data are presented in the form of two pairs of facing tables and graphs for each generic material (e.g. “Brick”, “Concrete” etc). The first pair comprise the low band test results. For these, a Condor Systems 48450 quad-ridged horn, operating over a frequency range of 0.5 to 2.0 GHz, was used. The second pair of graphs and tables present the high-band test results. For these tests, Flam and Russell FR-6415 range illumination horns operating over a frequency of 3.0 to 8.0 GHz were used.

For the left page in each pair, decimal units are used for the received, normalized amplitude; on the right page of each pair the units are in decibels (dB). To further reinforce this difference in amplitude scales we have used the ordinate title “Transmission Coefficient” for decimal data and “Received Signal Magnitude” for decibel data. In the case of the decimal normalized data, a value of 1.0 indicates, nominally, lossless transmission (that is, 100% of the power gets through) while 0.0 would represent complete absorption (or reflection) of the signal by the target material. In the decibel units plots, 0.0 represents no loss of signal

strength and attenuated amplitudes are represented as negative exponents. When we use the term “relative to free space” to describe the normalized data, it means that the signal penetrating the solid structure is compared to the line-of-sight signal (in air) when the structure was not present in the transmission path.

Conversion between the two plot pairs is accomplished using Eq(2.1.26). The decibel scale is particularly useful for viewing the transmission characteristics of particularly absorptive materials, such as concrete, where signal attenuation of an order of magnitude or more difference can be observed between thinner and thicker specimens. To those unfamiliar with decibels, the decimal plots provide a clear feeling for the ability of the NLS approach to penetrate common engineering materials. Only in the case of thicker concrete specimens (greater than 200 mm) was significant attenuation observed, and that was for a transmission power level of less than a milliwatt. Higher transmission power can be used to increase penetration range.

The graphs contain, usually, three sets of curves, one group for each target thickness for the given specimen. Each set contains a solid central line (the mean signal amplitude) and two dotted lines representing one standard deviation from the mean. It was possible to construct these statistically based curves because of the ten independent sets of data that were taken for each test. Since the ampli-

tude was sampled at ten different locations for each specimen at each discrete frequency, the standard deviation line can be constructed on a point by point basis for each discrete frequency of transmission. That is why the reader may notice variations in standard deviation with frequency.

In a few cases, usually around a particular frequency and for thin material thickness, normalized amplitudes of slightly greater than 1.0 (decimal) or greater than 0.0 (dB) were observed. This effect can be ascribed to instrument resolution and to coherent superposition of many signals due to multiple internal reflections. The latter phenomena is exploited in the design of radomes.

In an effort to make the data more useful, regression curves have been fitted to most data. These are all gated spectra (see Section 2.6).

4.1 Brick

The following four tables (4.1a through 4.1d) present the response spectra for brick. The ordinate values represent the ratio of the received to transmitted signal. Figures 4.1a and 4.1b cover the band from 0.5 to 2.0 GHz,

while Figures 4.1c and 4.1d are for the range 3.0 to 8.0 GHz. The decimal attenuation values are presented first, followed by the same ordinate set converted to decibels.



Figure 4.1: Test setup for specimen B3L (three-wythe deep brick wall) for frequency response determination from 0.5 to 2.0 GHz. See Figures 4.1a and 4.1b.

Table 4.1a: Regression Coefficients (DECIMAL) for BRICK Transmission versus Frequency Curves
 Plotted in Figure 4.1a. The regression equation is of the form
 Transmission Coefficient = $M_0 + M_1 \cdot F + M_2 \cdot F^2 + M_3 \cdot F^3 + M_4 \cdot F^4 + M_5 \cdot F^5 + M_6 \cdot F^6$, where F is the frequency in GHz. The correlation coefficient, R, is defined in the text.
 Data are for the Frequency Range 0.5 to 2.0 GHz.

Brick Attenuation Curves (0.5-2.0GHz)									
Curve Identification	Format	Regression Coefficients							
		M0	M1	M2	M3	M4	M5	M6	R
B1L	Decimal	3.9639	-14.581	28.08	-29.294	17.034	-5.1913	0.64614	0.99991
B1L + sigma	Decimal	4.5257	-17.17	32.792	-33.64	19.218	-5.7648	0.70796	0.99994
B1L - sigma	Decimal	3.402	-11.993	23.368	-24.947	14.849	-4.6177	0.58433	0.99986
B2L	Decimal	1.0632	-1.5358	2.6528	-3.1728	2.1941	-0.77778	0.10904	0.99999
B2L + sigma	Decimal	1.518	-3.8092	7.087	-7.5039	4.4849	-1.4097	0.18071	0.99998
B2L - sigma	Decimal	0.60845	0.73763	-1.7813	1.1583	-0.096713	-0.14587	0.037369	0.99999
B3L	Decimal	1.2692	-2.6303	4.8103	-5.7441	3.9546	-1.4052	0.1983	0.99998
B3L + sigma	Decimal	1.722	-4.9095	9.2863	-10.126	6.2539	-2.0278	0.26699	0.99998
B3L - sigma	Decimal	0.81643	-0.35111	0.33429	-1.362	1.6553	-0.78258	0.12961	0.99998

Figure 4.1a: Transmission Coefficients for Brick
 B1L = 89 mm; B2L = 178 mm; B3L = 267 mm nominal Target Thickness.
 Dotted Curves represent +/- 1 standard deviation from mean (Solid Curves).
 Low Range Data: 0.5 to 2.0 GHz. Amplitude Units: (decimal)

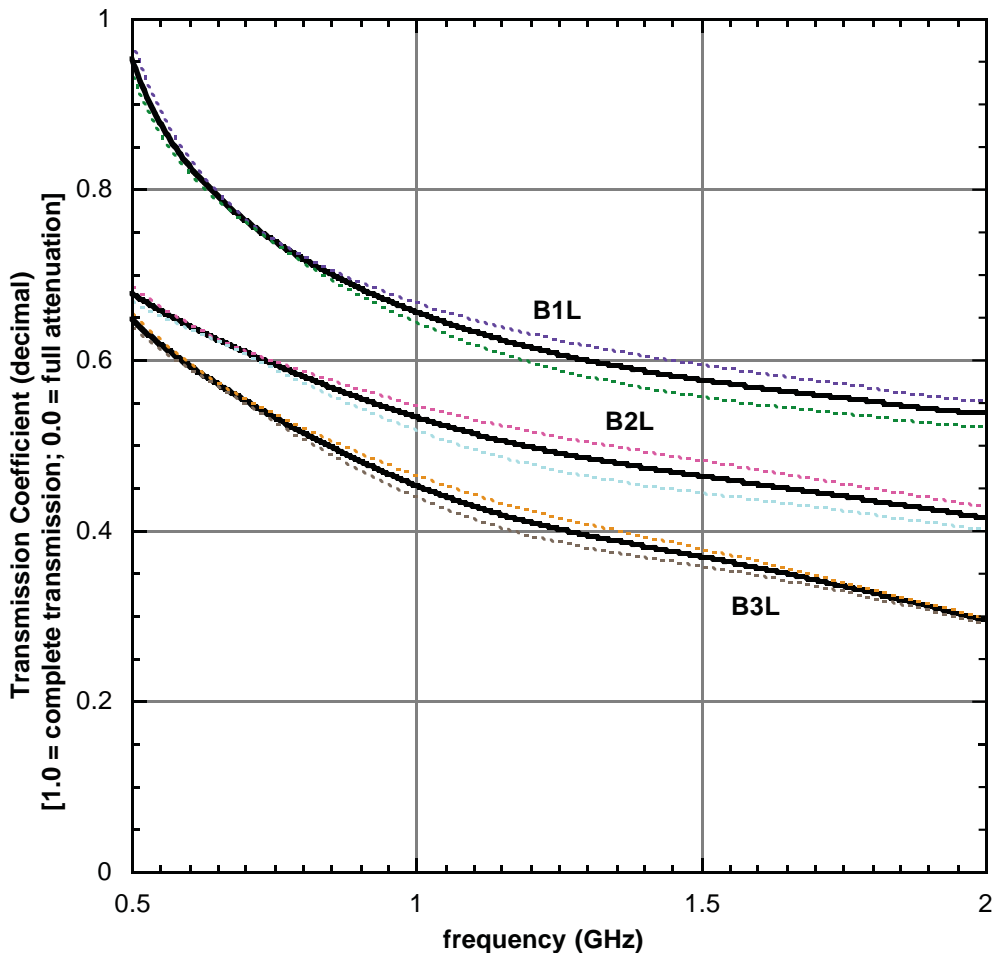

Table 4.1b: Regression Coefficients (dB) for BRICK Transmission versus Frequency Curves Plotted in Figure 4.1b. The regression equation is of the form
 Received Signal Magnitude = $M_0 + M_1 \cdot F + M_2 \cdot F^2 + M_3 \cdot F^3 + M_4 \cdot F^4 + M_5 \cdot F^5 + M_6 \cdot F^6$, where F is the frequency in GHz. The correlation coefficient, R, is defined in the text.
 Data are for the Frequency Range 0.5 to 2.0 GHz.

Brick Attenuation Curves (0.5-2.0 GHz)									
Curve Identification	Format	Regression Coefficients							
		M0	M1	M2	M3	M4	M5	M6	R
B1L	dB	27.078	-131.86	253.34	-266.89	156.92	-48.302	6.0616	0.99997
B1L + sigma	dB	31.421	-150.23	282.75	-289.23	165.39	-49.742	6.1277	0.99999
B1L - sigma	dB	22.706	-113.45	224.06	-244.89	148.71	-46.946	6.0054	0.99993
B2L	dB	1.8968	-22.766	44.568	-57.35	40.624	-14.465	2.0221	0.99999
B2L + sigma	dB	7.297	-48.75	92.552	-100.87	61.756	-19.789	2.5744	0.99999
B2L - sigma	dB	-3.3358	2.071	-0.39509	-17.73	22.095	-10.004	1.5827	0.99999
B3L	dB	5.7107	-44.841	95.34	-124.35	88.526	-31.737	4.469	0.99999
B3L + sigma	dB	11.077	-70.076	140	-161.66	104.11	-34.767	4.6648	0.99999
B3L - sigma	dB	0.47916	-20.635	53.628	-91.148	75.866	-29.741	4.4163	0.99998

Figure 4.1b: Received Signal Magnitude for Brick (relative to free space)
 B1L = 89 mm; B2L = 178 mm; B3L = 267 mm nominal Target Thickness.
 Dotted Curves represent +/- 1 standard deviation from mean (Solid Curves).
 Low Range Data: 0.5 to 2.0 GHz. Amplitude Units: (dB)

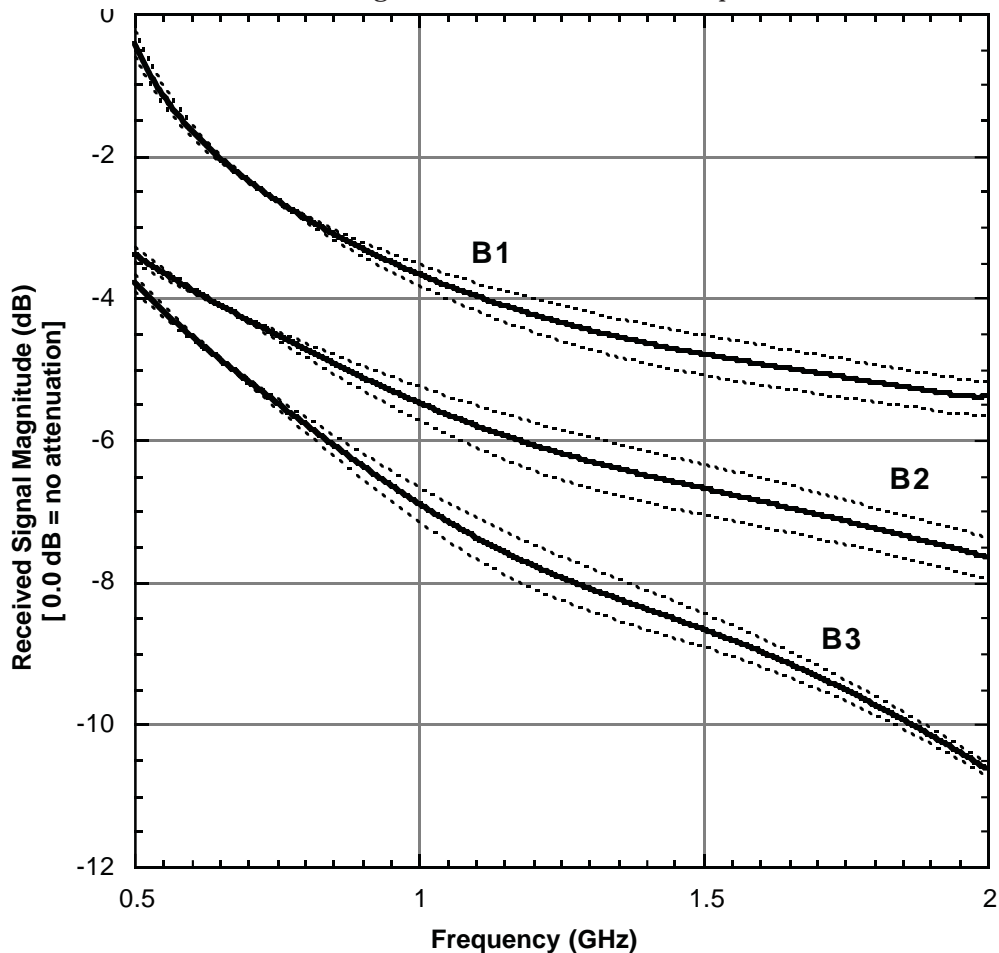

Table 4.1c: Regression Coefficients (dB) for BRICK Transmission versus Frequency Curves Plotted in Figure 4.1c. The regression equation is of the form
 Received Signal Magnitude = $M_0 + M_1 \cdot F + M_2 \cdot F^2 + M_3 \cdot F^3 + M_4 \cdot F^4 + M_5 \cdot F^5 + M_6 \cdot F^6$, where F is the frequency in GHz. The correlation coefficient, R, is defined in the text.
 Data are for the Frequency Range 3.0-8.0 GHz.

Brick Attenuation Curves (2.0-8.0 GHz)									
Curve Identification									
Coefficient	B1H	B1H + sigma	B1H - sigma	B2H	B2H + sigma	B2H - sigma	B3H	B3H + sigma	B3H - sigma
	Decimal	Decimal	Decimal	Decimal	Decimal	Decimal	Decimal	Decimal	Decimal
M0	0.1643	0.17818	0.15042	132.71	130.74	134.67	26.089	28.255	23.922
M1	0.0072085	-0.0095906	0.024008	-191.44	-188.62	-194.26	-38.424	-41.635	-35.213
M2	-0.0004138	0.009587	-0.010415	113.49	111.65	115.33	23.418	25.391	21.445
M3	-0.0004548	-0.0033807	0.0024711	-34.4	-33.608	-35.192	-7.3919	-8.0213	-6.7625
M4	0.00010601	0.00055481	-0.0003428	4.9945	4.7294	5.2596	1.1648	1.265	1.0646
M5	-1.11E-05	-4.52E-05	2.30E-05	-0.029182	0.039	-0.097365	-0.032867	-0.035492	-0.030242
M6	4.79E-07	1.50E-06	-5.42E-07	-0.10789	-0.12011	-0.095673	-0.019848	-0.021703	-0.017993
M7				0.017073	0.018455	0.015692	0.0034948	0.0038266	0.003163
M8				-0.0011524	-0.0012397	-0.001065	-0.0002477	-0.0002719	-0.0002236
M9				3.02E-05	3.26E-05	2.79E-05	6.73E-06	7.40E-06	6.06E-06
R	1	1	1	0.99975	0.9999	0.99932	0.9995	0.99915	0.99962

Figure 4.1c: Transmission Coefficients for Brick
 B1L = 89 mm; B2L = 178 mm; B3L = 267 mm nominal Target Thickness.
 Dotted Curves represent +/- 1 standard deviation from mean (Solid Curves).
 High Range Data: 3.0-8.0 GHz. Amplitude Units: (decimal)

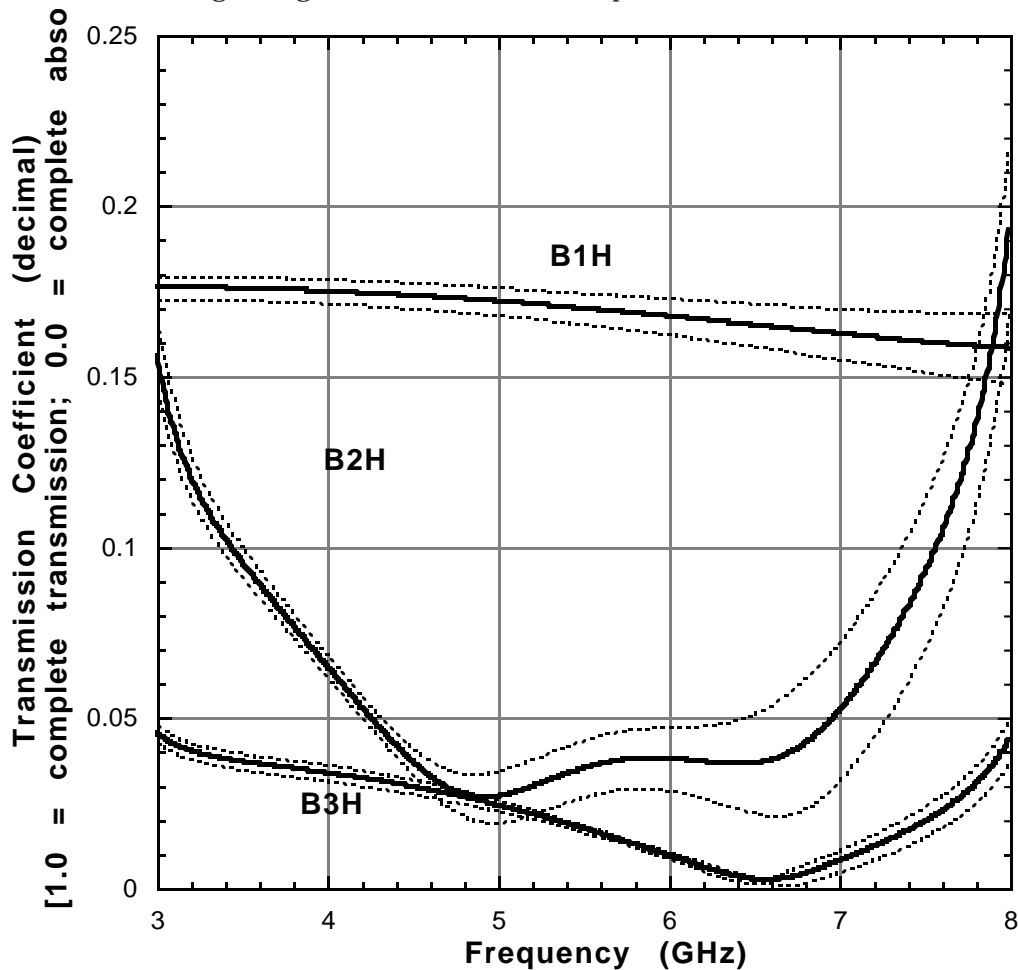
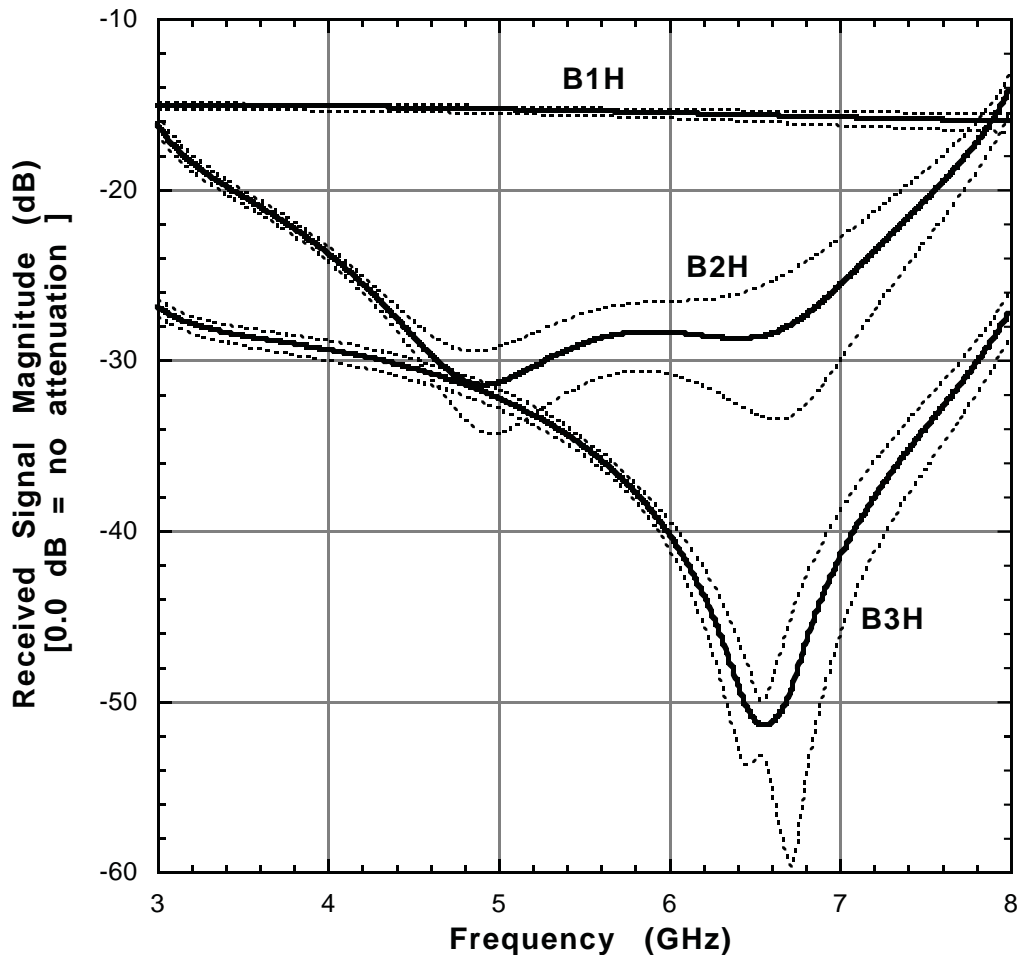

Table 4.1d: Regression Coefficients (dB) for BRICK Transmission versus Frequency Curves Plotted in Figure 4.1d. The regression equation is of the form
 Received Signal Magnitude = $M_0 + M_1 \cdot F + M_2 \cdot F^2 + M_3 \cdot F^3 + M_4 \cdot F^4 + M_5 \cdot F^5 + M_6 \cdot F^6$, where F is the frequency in GHz. The correlation coefficient, R, is defined in the text.
 Data are for the Frequency Range 3.0-8.0 GHz

Brick Attenuation Curves (2.0-8.0 GHz)									
Curve Identification									
Coefficient	B1H	B1H + sigma	B1H - sigma	B2H	B2H + sigma	B2H - sigma	B3H	B3H + sigma	B3H - sigma
	dB	dB	dB	dB	dB	dB	dB	dB	dB
M0	-15.651	-14.988	-16.294	24953	19635	34260	40922	34886	53110
M1	0.3304	-0.45205	1.0861	-36332	-28599	-49934	-61423	-52428	-79588
M2	-0.0033608	0.45549	-0.44798	21707	17029	29989	38073	32507	49346
M3	-0.02876	-0.16097	0.099196	-6665.8	-5161.9	-9354	-12282	-10463	-15999
M4	0.0065649	0.026479	-0.012619	1007.3	740.95	1490.9	2025.7	1706.4	2697.3
M5	-0.0006953	-0.0021688	0.00071188	-21.912	-0.21939	-63.032	-87.288	-64.749	-141.35
M6	2.99E-05	7.26E-05	-1.04E-05	-17.55	-17.077	-18.049	-26.917	-25.188	-28.811
M7				2.915	2.6614	3.3406	5.1505	4.6766	5.9312
M8				-0.19837	-0.17862	-0.23252	-0.37218	-0.3365	-0.43363
M9				0.0051939	0.0046684	0.0061143	0.010163	0.0091967	0.011845
R	1	1	1	0.997	0.991	0.993	0.986	0.98452	0.98

Figure 4.1d: Received Signal Magnitude for Brick (relative to free space)
 B1L = 89 mm; B2L = 178 mm; B3L = 267 mm nominal Target Thickness.
 Dotted Curves represent +/- 1 standard deviation from mean (Solid Curves).
 High Range Data: 3.0-8.0 GHz. Amplitude Units: (dB)



BLANK PAGE

4.2 Brick-Faced Concrete Wall

The following four tables (4.2a through 4.2d) present the frequency response spectrum for a composite brick-faced concrete wall. This is a single-wythe brick wall followed by a 203-mm thick plain concrete wall (Batch 8 concrete). An air gap of approximately 3 to 5 mm existed between the two walls, owing to irregularities in the respective wall thicknesses.

Figures 4.2a and 4.2b cover the band from 0.5 to 2.0 GHz, while Figures 4.2c and 4.2d are for the range 3.0 to 8.0 GHz. The ordinate values represent the ratio of the received to transmitted signal. The decimal attenuation values are presented first, followed by the same ordinate set converted to decibels.

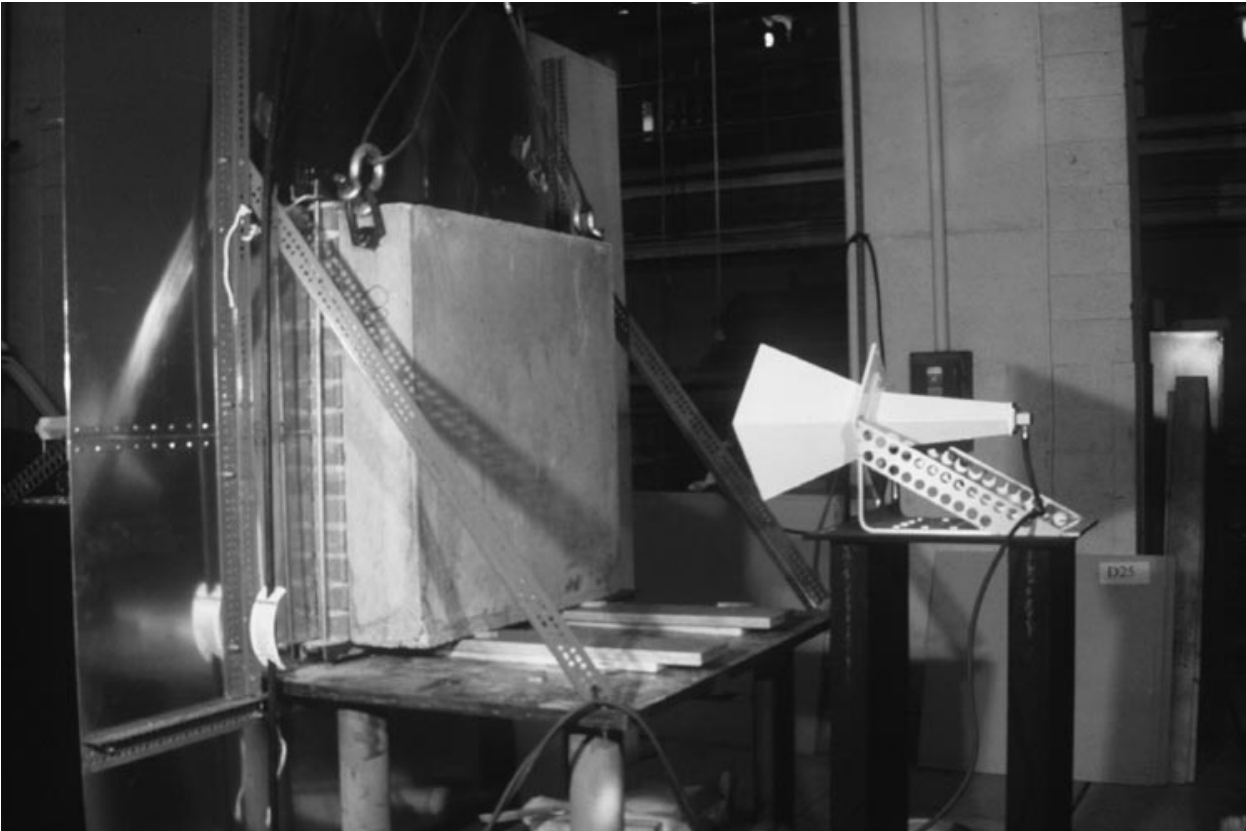

Figure 4.2: Test setup for specimen B3C88L (single-wythe deep brick wall facing a 203 mm thick concrete wall) for frequency response determination from 3.0 to 8.0 GHz. See Figures 4.2c and 4.2d.

Table 4.2a: Regression Coefficients (decimal) for Composite Brick/Concrete Wall Transmission versus Frequency Curves Plotted in Figure 4.2a. The regression equation is of the form $\text{Transmission Coefficient} = M_0 + M_1 * F + M_2 * F^2 + M_3 * F^3 + M_4 * F^4 + M_5 * F^5 + M_6 * F^6$ etc. where F is the frequency in GHz. The correlation coefficient, R, is defined in the text. Data are for the Frequency Range 0.5 to 2.0 GHz.

Composite Brick/Concrete Attenuation Curves (2.0-8.0 GHz)						
	Curve Identification					
Coefficient	B3C84L	B3C84L + sigma	B3C84L - sigma	B3C88L	B3C88L + sigma	B3C88L - sigma
	Decimal	Decimal	Decimal	Decimal	Decimal	Decimal
M0	0.38431	0.31606	0.45255	0.16354	0.16083	0.16624
M1	-0.3322	0.18069	-0.84509	-0.32384	-0.30867	-0.33901
M2	0.50372	-0.87713	1.8846	0.67832	0.64272	0.71391
M3	-0.75838	1.0444	-2.5611	-0.87974	-0.822276	-0.93673
M4	0.58992	-0.639	1.8188	0.58042	0.532	0.62883
M5	-2.15E-01	2.05E-01	-6.36E-01	-0.1854	-0.16606	-0.20475
M6	2.99E-02	-2.71E-02	8.70E-02	0.023088	0.020194	0.025982
M7						
M8						
M9						
R	1	1	0.99999	1	1	1

Figure 4.2a: Transmission Coefficients for Composite Brick/Concrete walls (relative to free space)

B3C84L = 90 mm Brick backed by 102mm of plain concrete (type 8);

B3C88L = 90 mm Brick backed by 203mm of plain concrete (type 8).

Dotted Curves represent +/- 1 standard deviation from mean (Solid Curves).

Low Range Data: 0.5 to 2.0 GHz

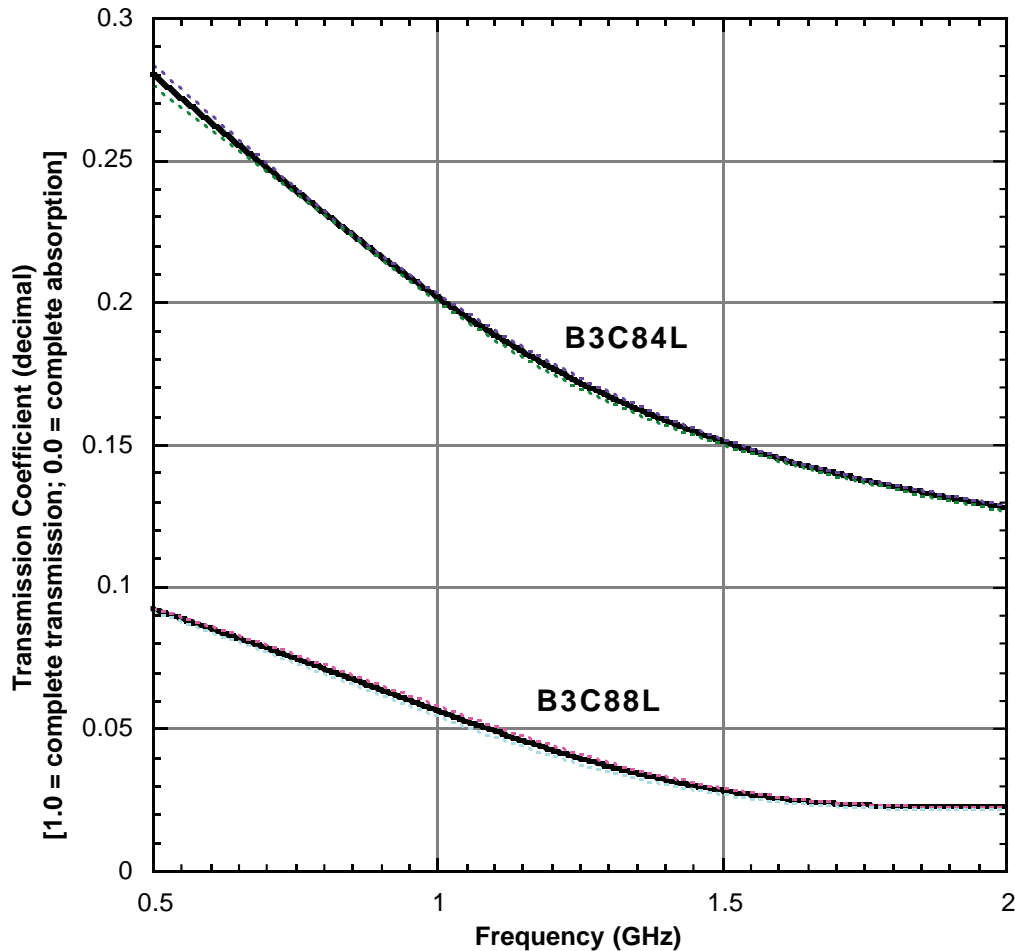

Table 4.2b: Regression Coefficients (dB) for Composite Brick/Concrete Wall Transmission versus Frequency Curves Plotted in Figure 4.2b. The regression equation is of the form
 Received Signal Magnitude (relative to free space)
 $= M_0 + M_1 * F + M_2 * F^2 + M_3 * F^3 + M_4 * F^4 + M_5 * F^5 + M_6 * F^6$, where F is the frequency in GHz.
 The correlation coefficient, R, is defined in the text.
 Data are for the Frequency Range 0.5 to 2.0 GHz.

Composite Brick/Concrete Attenuation Curves (2.0-8.0 GHz)						
Curve Identification						
Coefficient	B3C84L dB	B3C84L + sigma dB	B3C84L - sigma dB	B3C88L dB	B3C88L + sigma dB	B3C88L - sigma dB
M0	-6.6728	-10.896	-2.4035	-16.266	-18.242	-14.003
M1	-18.39	10.231	-47.343	-13.338	-1.582	-26.855
M2	37.664	-35.535	111.74	11.241	-16.478	43.241
M3	-51.957	40.694	-145.75	1.5373	35.354	-37.512
M4	35.823	-26.025	98.442	-18.011	-39.49	6.8261
M5	-1.1905E+01	8.94E+00	-3.30E+01	12.188	18.884	4.4136
M6	1.54E+00	-1.26E+00	4.37E+00	-2.3299	-3.1371	-1.3865
M7						
M8						
M9						
R	1	1	1	1	1	1

Figure 4.2b: Received Signal Magnitude (dB) for Composite Brick/Concrete Wall (relative to free space)
 B3C84L = 90 mm Brick backed by 102mm of plain concrete (type 8);
 B3C88L = 90 mm Brick backed by 203mm of plain concrete (type 8).
 Dotted Curves represent +/- 1 standard deviation from mean (Solid Curves).
 Low Range Data: 0.5 to 2.0 GHz

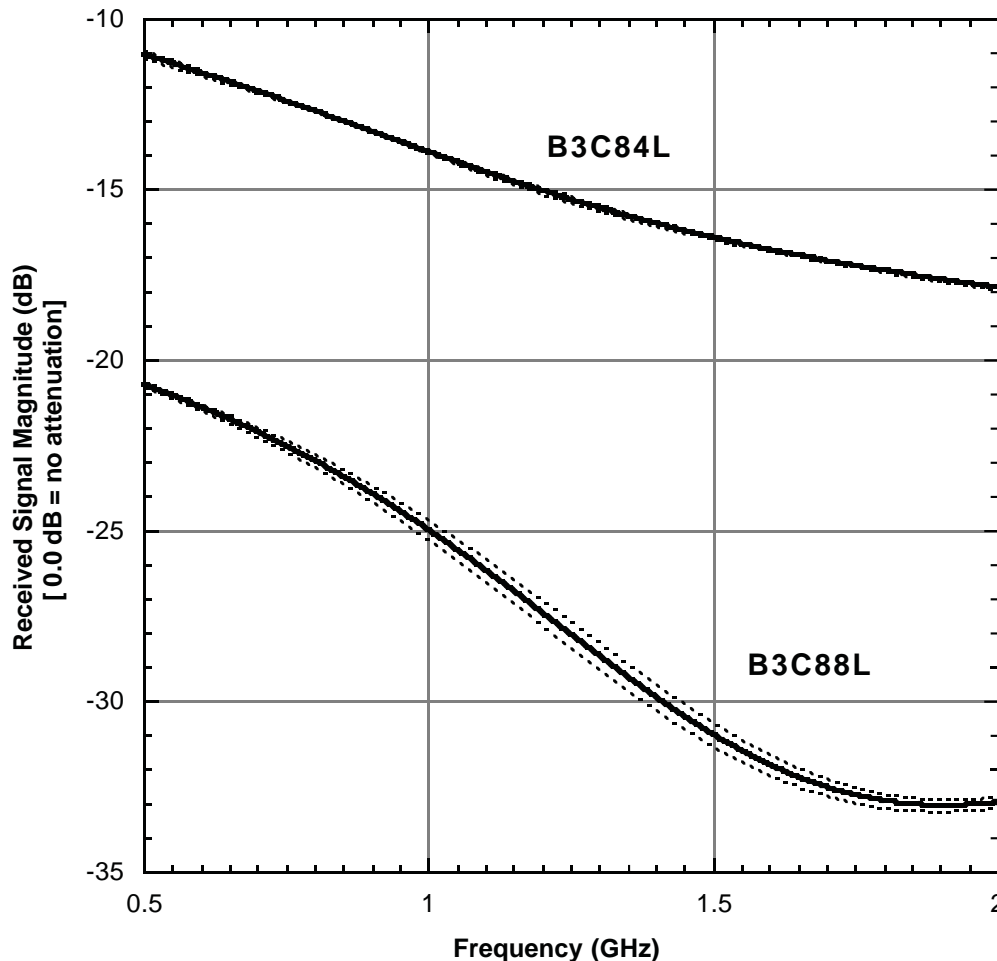

Table 4.2c: Regression Coefficients (decimal) for Composite Brick/Concrete Wall Transmission versus Frequency Curves Plotted in Figure 4.2c. The regression equation is of the form $\text{Transmission Coefficient} = M_0 + M_1 \cdot F + M_2 \cdot F^2 + M_3 \cdot F^3 + M_4 \cdot F^4 + M_5 \cdot F^5 + M_6 \cdot F^6$ etc. where F is the frequency in GHz. The correlation coefficient, R, is defined in the text. Data are for the Frequency Range 3.0 - 8.0 GHz.

Composite Brick/Concrete Attenuation Curves (3.0-8.0 GHz)						
Curve Identification						
Coefficient	B3C84H	B3C84H + sigma	B3C84H - sigma	B3C88H	B3C88H + sigma	B3C88H - sigma
	Decimal	Decimal	Decimal	Decimal	Decimal	Decimal
M0	0.04924	0.017529	0.08095	0.013063	0.0077828	0.041694
M1	-0.037976	0.0016424	-0.077594	-0.016246	-0.00658	-0.059819
M2	0.01901	-0.0011594	0.039179	0.0098738	0.0029523	0.037251
M3	-0.0050585	0.00031375	-0.010431	-0.0032383	-0.0074505	-0.012246
M4	0.00070611	-8.09E-05	0.00014931	0.00054217	0.00010342	0.00020922
M5	-5.0523E-05	9.50E-06	-1.11E-04	-2.08E-05	-7.38E-06	-0.00010764
M6	1.49E-06	-3.67E-07	3.36E-06	-8.70E-06	2.12E-07	-2.45E-05
M7						5.07E-06
M8						-3.78E-07
M9						1.05E-08
R	1	1	1	1	1	0.99999

Figure 4.2c: Transmission Coefficients for Composite Brick/Concrete walls (relative to free space)

B3C84L = 90 mm Brick backed by 102mm of plain concrete (type 8);

B3C88L = 90 mm Brick backed by 203mm of plain concrete (type 8).

Dotted Curves represent +/- 1 standard deviation from mean (Solid Curves).

High Range Data: 3.0 - 8.0 GHz

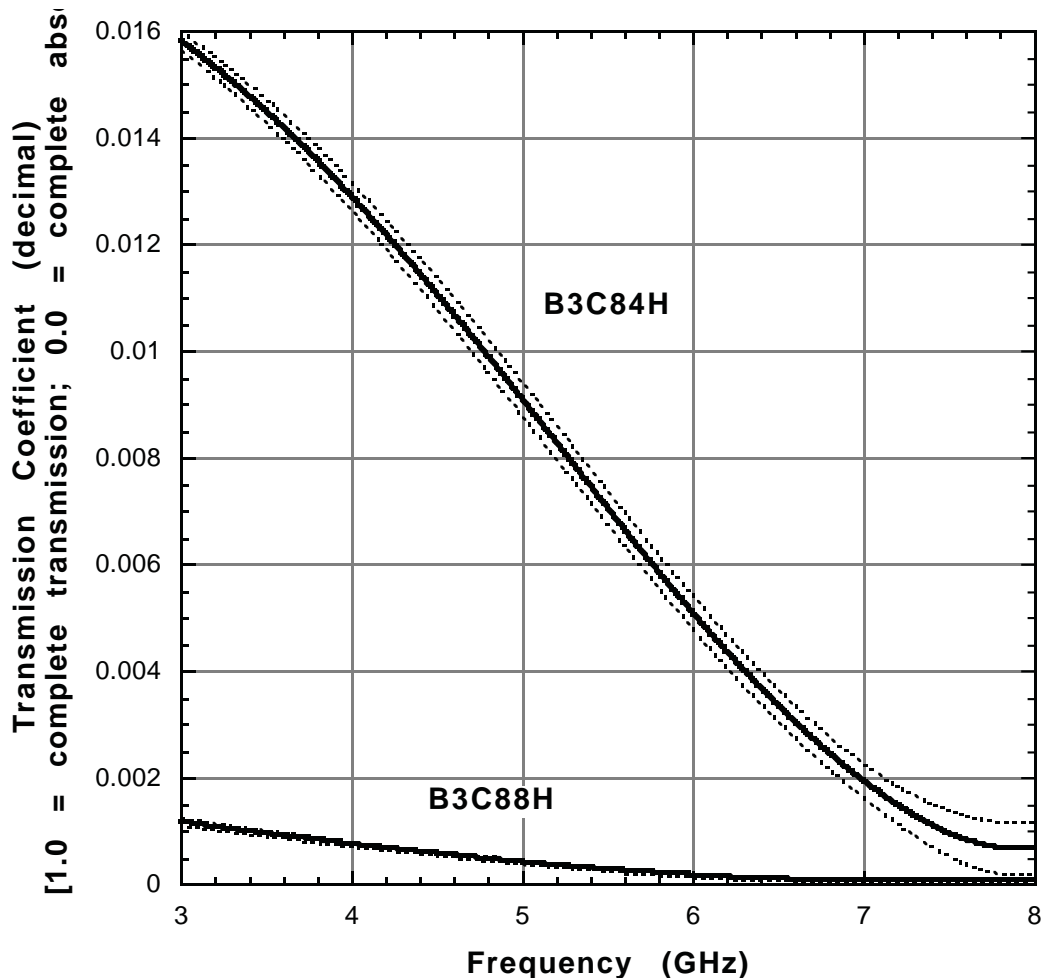

Table 4.2d: Regression Coefficients (dB) for Composite Brick/Concrete Wall Transmission versus Frequency Curves Plotted in Figure 4.2d. The regression equation is of the form

$$\text{Received Signal Magnitude (relative to free space)} = M_0 + M_1 * F + M_2 * F^2 + M_3 * F^3 + M_4 * F^4 + M_5 * F^5 + M_6 * F^6, \text{ where } F \text{ is the frequency in GHz.}$$

The correlation coefficient, R, is defined in the text. Data are for the Frequency Range 3.0 - 8.0 GHz.

Composite Brick/Concrete Attenuation Curves (3.0-8.0 GHz)						
	Curve Identification					
Coefficient	B3C84H	B3C84H + sigma	B3C84H - sigma	B3C88H	B3C88H + sigma	B3C88H - sigma
	dB	dB	dB	dB	dB	dB
M0	1393.3	-469.24	9746.1	2167.9	-708.51	8041.2
M1	-2210.6	648.53	-14962	-3329.8	980.76	-12115
M2	1414.7	-402.48	9492.9	2067.3	-611.45	7522.5
M3	-469.93	132.2	-3155.4	-673.47	201.82	-2459.8
M4	78.518	-2.36E+01	545.7	115.37	-36.281	428.36
M5	-2.6481000	1.7913000	-28.8580000	-6.84E+00	2.78E+00	-28.181
M6	-1.3919000	0.0912470	-6.4064000	-9.96E-01	1.54E-01	-2.95E+00
M7	0.2632800	-0.0296730	1.3543000	0.21959	-0.051084	7.23E-01
M8	-0.0198160	0.0022121	-0.1028700	-0.016009	0.0040733	-5.38E-02
M9	0.0005711	-0.0000569	0.0029316	4.29E-04	-1.16E-04	1.46E-03
R	1	1	1	0.99997	0.99999	0.99957

Figure 4.2d: Received Signal Magnitude (dB) for Composite Brick/Concrete Wall (relative to free space)

B3C84L = 90 mm Brick backed by 102mm of plain concrete (type 8);

B3C88L = 90 mm Brick backed by 203mm of plain concrete (type 8).

Dotted Curves represent +/- 1 standard deviation from mean (Solid Curves).

High Range Data: 3.0 - 8.0 GHz

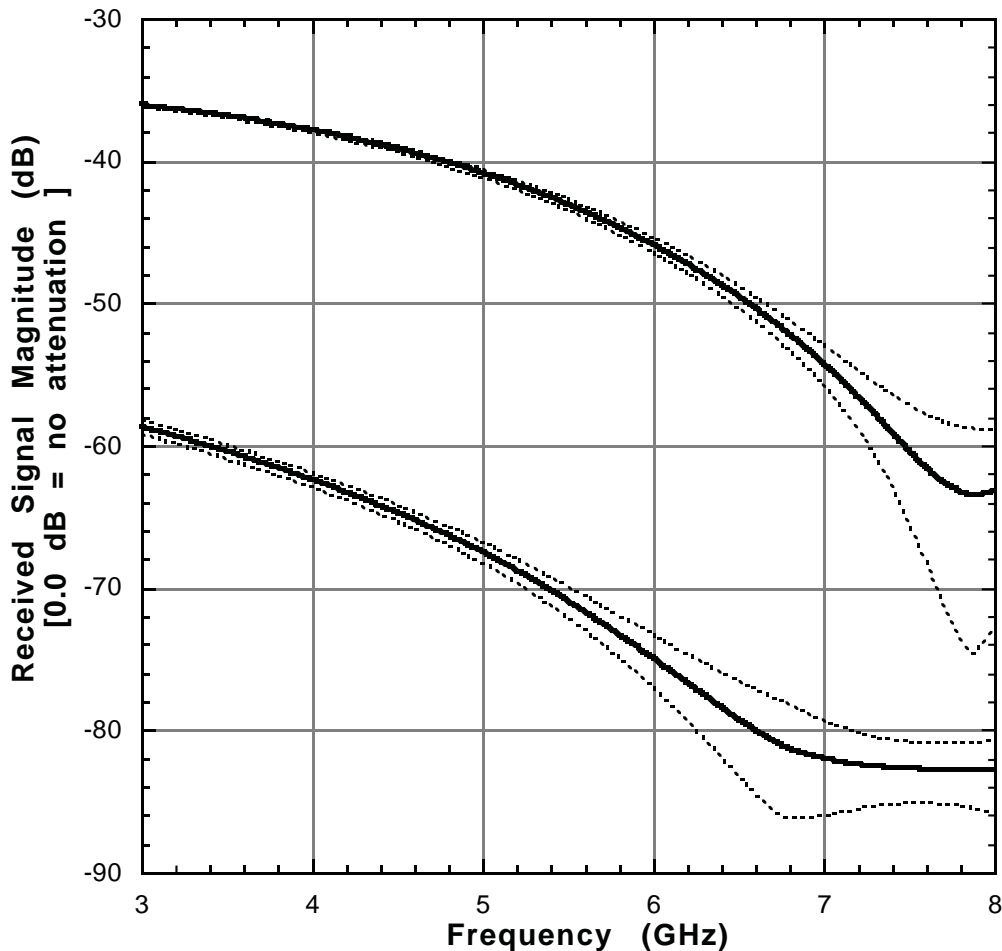

BLANK PAGE

4.3 Brick-Faced Masonry Block

The following four tables (4.3a through 4.3d) present the frequency response spectrum for a composite brick-faced masonry block wall. This is a single-wythe brick wall followed by a 203-mm thick masonry block wall. An air gap of approximately 3 to 5 mm existed between the two walls, owing to irregularities in the respective wall thicknesses.

Figures 4.3a and 4.3b cover the band from 0.5 to 2.0 GHz, while Figures 4.3c and 4.3d are for the range 3.0 to 8.0 GHz. The ordinate values represent the ratio of the received to transmitted signal. The decimal attenuation values are presented first, followed by the same ordinate set converted to decibels.

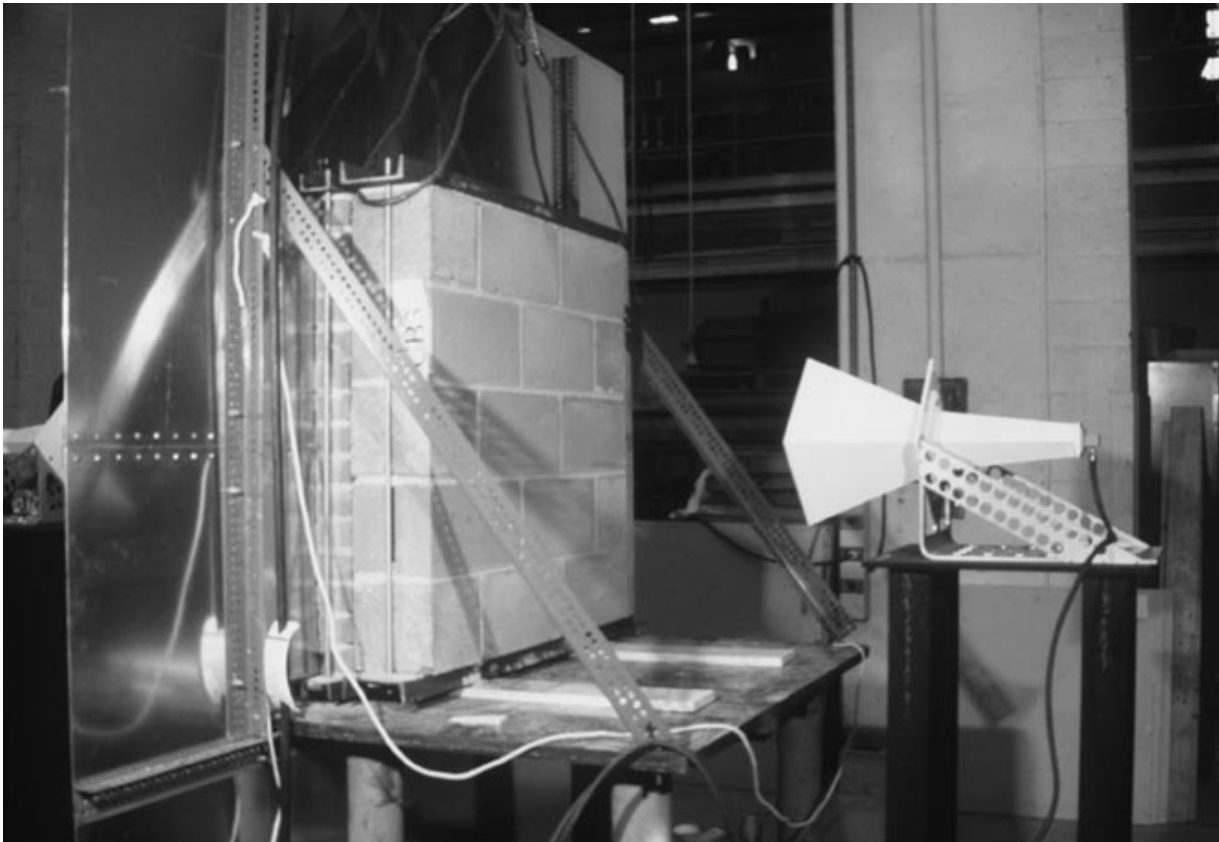

Figure 4.3: Test setup for specimen B3MB8L (single-wythe deep brick wall facing a 203 mm thick masonry block wall) for frequency response determination from 3.0 to 8.0 GHz. See Figures 4.3c and 4.3d.

Table 4.3a: Regression Coefficients (decimal) for Composite Brick/Masonry Block Wall Transmission versus Frequency Curves Plotted in Figure 4.3a. The regression equation is of the form $\text{Transmission Coefficient} = M_0 + M_1 * F + M_2 * F^2 + M_3 * F^3 + M_4 * F^4 + M_5 * F^5 + M_6 * F^6$ etc. where F is the frequency in GHz. The correlation coefficient, R, is defined in the text. Data are for the Frequency Range 0.5 to 2.0 GHz.

Composite Brick/Masonry Block Attenuation Curves (0.5-2.0 GHz)			
	Curve Identification		
Coefficient	B3MB8L	B3MB8L + sigma	B3MB8L - sigma
	Decimal	Decimal	Decimal
M0	0.492520	0.525160	0.459890
M1	0.064577	-0.119500	0.248640
M2	-0.913710	-0.251100	-1.576300
M3	0.808720	-0.332260	1.949700
M4	-0.069060	-0.879950	-1.019300
M5	-0.132840	-0.506170	0.240800
M6	0.035009	0.090922	-0.020904
M7			
M8			
M9			
R	0.999970	0.999830	0.999930

Figure 4.3a: Transmission Coefficients for Composite Brick/Masonry Block walls (relative to free space)
 B3MB8L = 90 mm Brick backed by 194 mm Block Wall
 Dotted Curves represent +/- 1 standard deviation from mean (Solid Curves).
 Low Range Data: 0.5 to 2.0 GHz

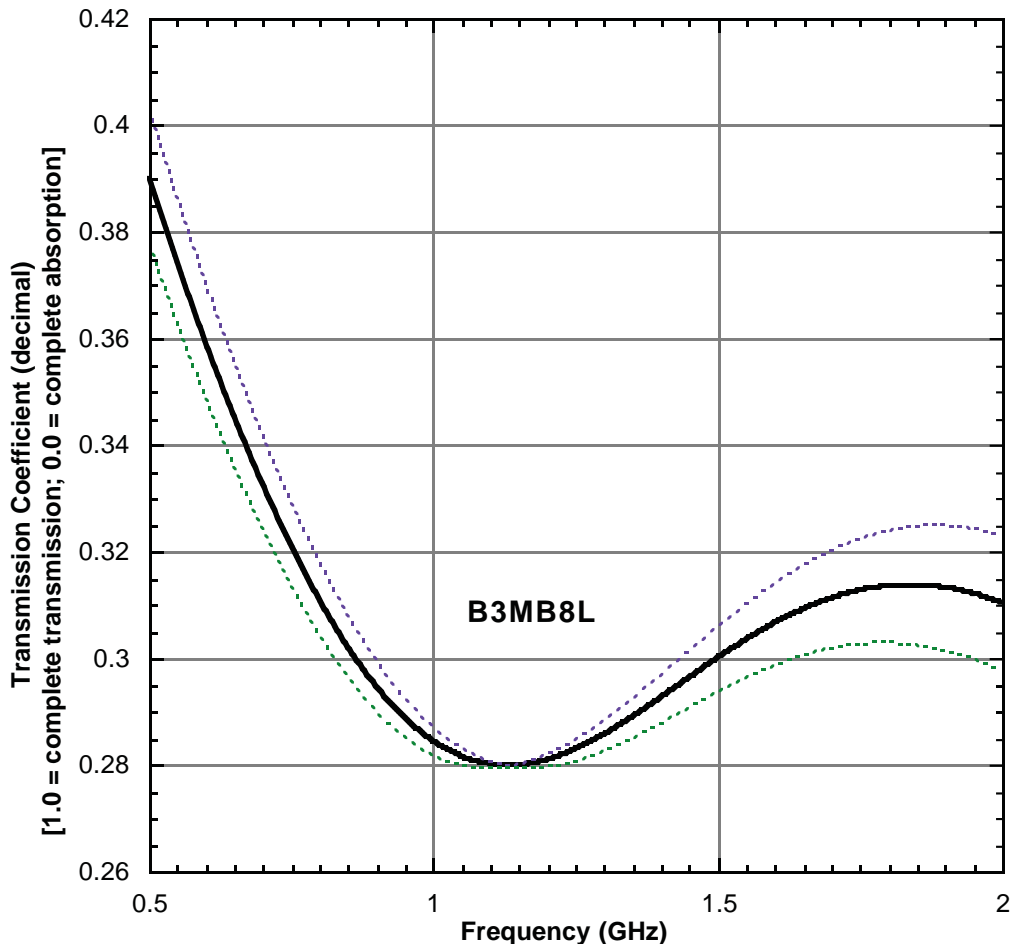

Table 4.3b: Regression Coefficients (dB) for Composite Brick/Masonry Block Wall Transmission versus Frequency Curves Plotted in Figure 4.3b. The regression equation is of the form
 Received Signal Magnitude (relative to free space)
 $= M_0 + M_1 \cdot F + M_2 \cdot F^2 + M_3 \cdot F^3 + M_4 \cdot F^4 + M_5 \cdot F^5 + M_6 \cdot F^6$, where F is the frequency in GHz.
 The correlation coefficient, R, is defined in the text.
 Data are for the Frequency Range 0.5 to 2.0 GHz.

Composite Brick/Masonry Block Attenuation Curves (0.5-2.0 GHz)			
Curve Identification			
Coefficient	B3MB8L dB	B3MB8L + sigma dB	B3MB8L - sigma dB
M0	-10.060000	-9.308500	-10.771000
M1	22.891000	16.778000	28.728000
M2	-59.770000	-36.133000	-82.866000
M3	49.211000	8.961400	89.004000
M4	-11.871000	21.084000	-44.648000
M5	-2.299700	-15.114000	10.486000
M6	0.985250	2.892600	-0.921490
M7			
M8			
M9			
R	0.999920	0.999650	0.999920

Figure 4.3b: Received Signal Magnitude (dB) for Composite Brick/Masonry Block Walls (relative to free space)
 B3MB8L = 90 mm Brick backed by 194 mm Block Wall
 Dotted Curves represent +/- 1 standard deviation from mean (Solid Curves).
 Low Range Data: 0.5 to 2.0 GHz

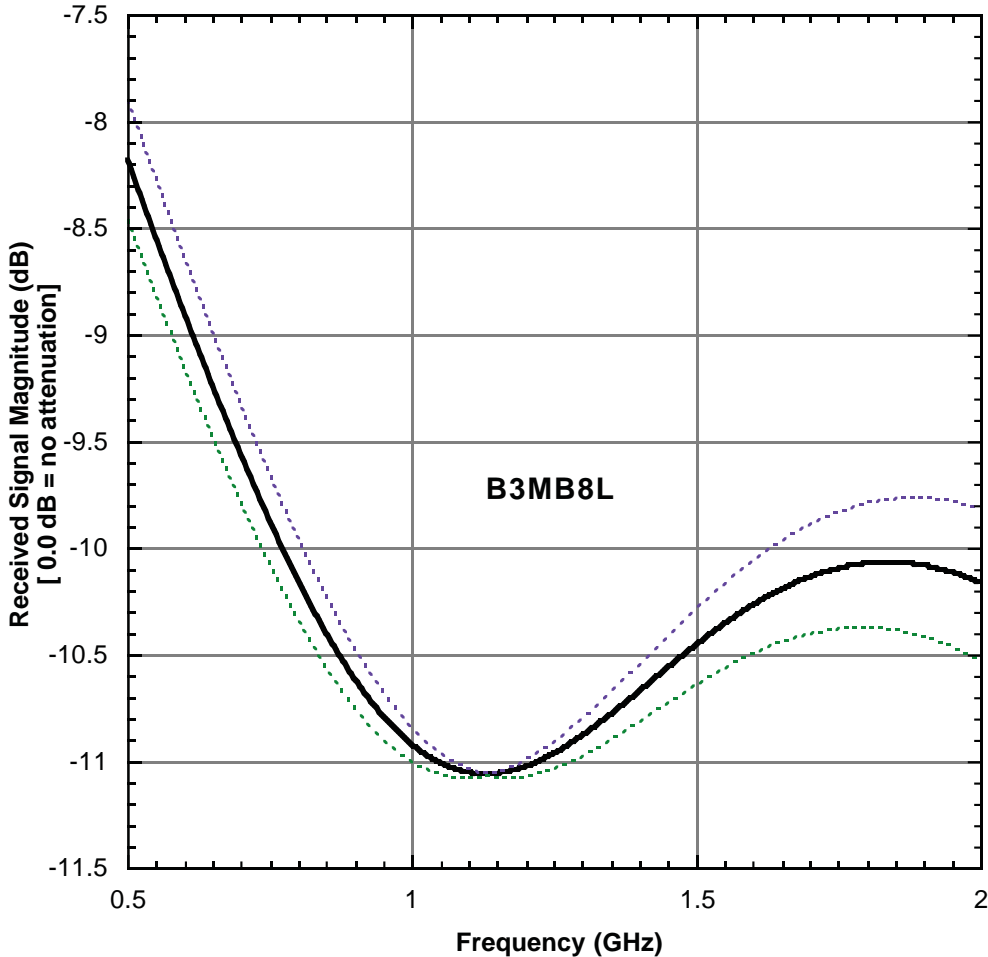

Table 4.3c: Regression Coefficients (decimal) for Composite Brick/Masonry Block Wall Transmission versus Frequency Curves Plotted in Figure 4.3c. The regression equation is of the form $\text{Transmission Coefficient} = M_0 + M_1 * F + M_2 * F^2 + M_3 * F^3 + M_4 * F^4 + M_5 * F^5 + M_6 * F^6$ etc. where F is the frequency in GHz. The correlation coefficient, R, is defined in the text. Data are for the Frequency Range 3.0 to 8.0 GHz.

Composite Brick/Masonry Block Attenuation Curves (3.0 to 8.0 GHz)			
	Curve Identification		
Coefficient	B3MB8H	B3MB8H + sigma	B3MB8H - sigma
	Decimal	Decimal	Decimal
M0	1.8578E+00	-5.6151E+00	9.3306E+00
M1	-2.7637E+00	8.7131E+00	-1.4240E+01
M2	1.7520E+00	-5.5957E+00	9.0997E+00
M3	-5.9409E-01	1.9059E+00	-3.0941E+00
M4	1.1269E-01	-3.5019E-01	5.7556E-01
M5	-1.0549E-02	2.5690E-02	-4.6788E-02
M6	3.9837E-05	2.2292E-03	-2.1496E-03
M7	8.9027E-05	-6.3359E-04	8.1165E-04
M8	-7.7230E-06	5.0896E-05	-6.6342E-05
M9	2.1482E-07	-1.4807E-06	1.9130E-06
R	9.9998E-01	9.9996E-01	9.9965E-01

Figure 4.3c: Transmission Coefficients for Composite Brick/Masonry Block walls (relative to free space)
 B3MB8H = 90 mm Brick backed by 194 mm Block Wall
 Dotted Curves represent +/- 1 standard deviation from mean (Solid Curves).
 High Range Data: 3.0 to 8.0 GHz

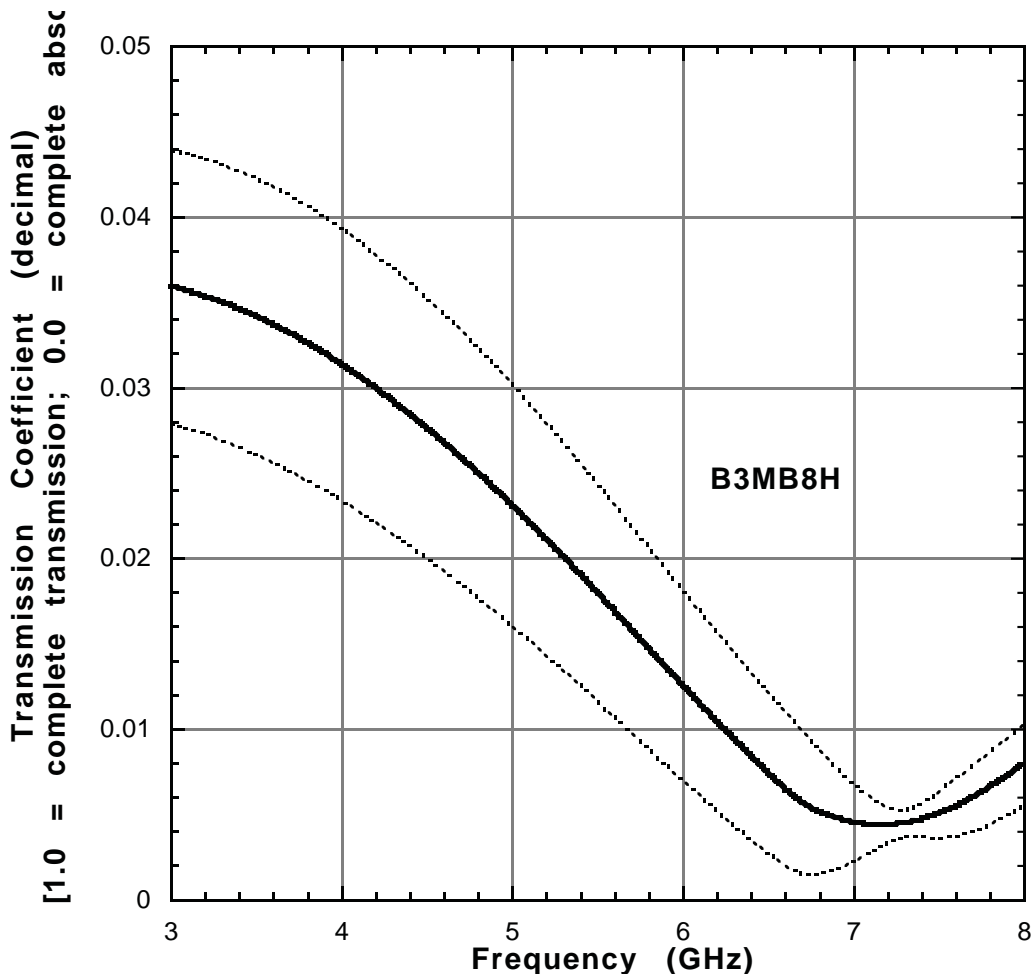
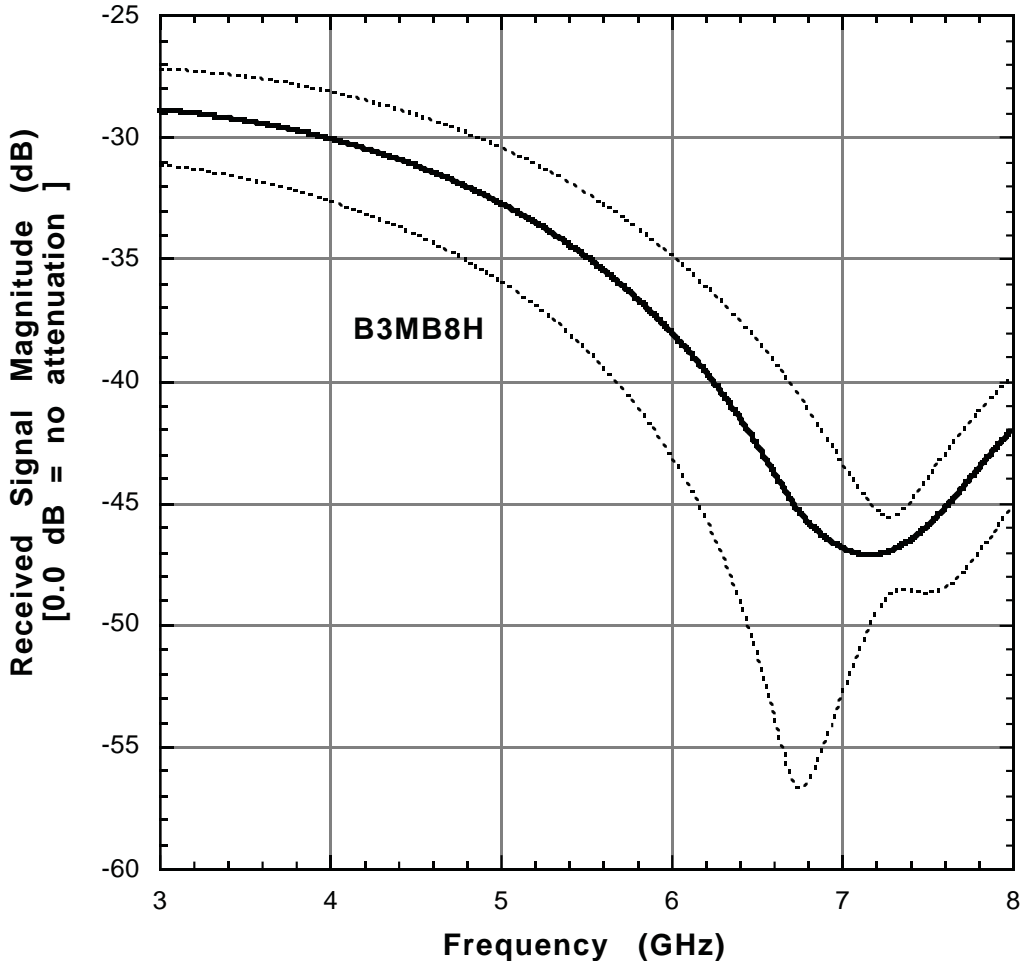

Table 4.3d: Regression Coefficients (dB) for Composite Brick/Masonry Block Wall Transmission versus Frequency Curves Plotted in Figure 4.3d. The regression equation is of the form
 Received Signal Magnitude (relative to free space)
 $= M_0 + M_1 * F + M_2 * F^2 + M_3 * F^3 + M_4 * F^4 + M_5 * F^5 + M_6 * F^6$, where F is the frequency in GHz.
 The correlation coefficient, R, is defined in the text.
 Data are for the Frequency Range 3.0 to 8.0 GHz.

Composite Brick/Masonry Block Attenuation Curves (3.0 to 8.0 GHz)			
	Curve Identification		
Coefficient	B3MB8H	B3MB8H + sigma	B3MB8H - sigma
	dB	dB	dB
M0	9.3306E+00	-8.0230E+02	-1.0550E+04
M1	-1.4240E+01	1.2864E+03	1.6209E+04
M2	9.0997E+00	-8.4533E+02	-1.0406E+04
M3	-3.0941E+00	2.5916E+02	3.5390E+03
M4	5.7556E-01	-2.2454E+01	-6.4842E+02
M5	-4.6788E-02	-9.1938E+00	4.7261E+01
M6	-2.1496E-03	3.3195E+00	4.1589E+00
M7	8.1165E-04	-4.7732E-01	-1.1700E+00
M8	-6.6342E-05	3.3586E-02	9.3519E-02
M9	1.9103E-06	-9.5017E-04	-2.7076E-03
R	9.9965E-01	9.9983E-01	9.9928E-01

Figure 4.3d: Received Signal Magnitude (dB) for Composite Brick/Masonry Block Walls (relative to free space)
 B3MB8H = 90 mm Brick backed by 194 mm Block Wall
 Dotted Curves represent +/- 1 standard deviation from mean (Solid Curves).
 High Range Data: 3.0 to 8.0 GHz



BLANK PAGE

4.4 Plain Concrete: Batch 1 Mix

The following four tables (4.4a through 4.4d) present the frequency response spectrum for a plain concrete wall. The specimens in this series bear the designation C1XXL and C1XXH, where the “XX” defines the specimen thickness in inches, and the L and H denote “low” (0.5 to 2.0 GHz) and “high” (3.0 to 8.0 GHz) frequency bandwidths.

The batch 1 concrete specimens had an approximate water cement ratio of 0.4*, a slump of 57 mm (“low”), a nominal

maximum crushed aggregate size of 12.7 mm (“small”), a cement content by weight of 22% and an average density of 2.31 g/cc.

Figures 4.4a and 4.4b cover the band from 0.5 to 2.0 GHz, while Figures 4.4c and 4.4d are for the range 3.0 to 8.0 GHz. The ordinate values represent the ratio of the received to transmitted signal. The decimal attenuation values are presented first, followed by the same ordinate set converted to decibels.

*the exact delivered value was not able to be calculated due to the omission of the water added on site from the delivery ticket.

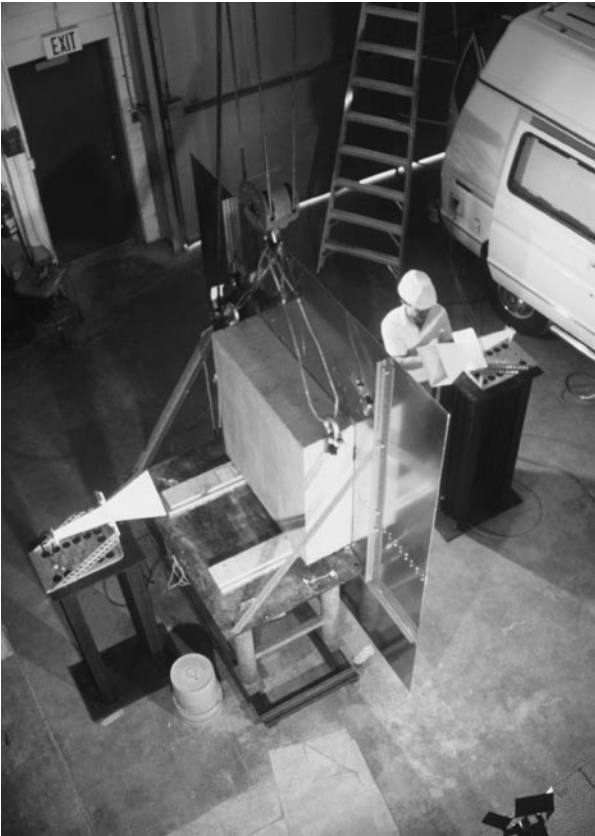

Figure 4.4: Test setup for specimen C112H (305 mm thick plain concrete wall) for frequency response determination from 3.0 to 8.0 GHz. See Figures 4.4c and 4.4d.

Table 4.4a: Regression Coefficients (decimal) for Concrete Type 1 Transmission versus Frequency Curves Plotted in Figure 4.4a. The regression equation is of the form $\text{Transmission Coefficient} = M_0 + M_1 * F + M_2 * F^2 + M_3 * F^3 + M_4 * F^4 + M_5 * F^5 + M_6 * F^6$ etc. where F is the frequency in GHz. The correlation coefficient, R, is defined in the text. Data are for the Frequency Range 0.5 to 2.0 GHz.

Concrete Type 1 Attenuation Curves (0.5 to 2.0 GHz)									
Curve Identification									
Coefficient	C14L	C14L + sigma	C14L - sigma	C18L	C18L + sigma	C18L - sigma	C112L	C112L + sigma	C112L - sigma
	Decimal	Decimal	Decimal	Decimal	Decimal	Decimal	Decimal	Decimal	Decimal
M0	4.2829E-01	3.8905E-01	4.6752E-01	1.2864E-01	1.3301E-01	1.2426E-01	7.4321E-02	7.0682E-02	7.7960E-02
M1	-1.2022E-01	1.9569E-01	-4.3612E-01	3.2106E-02	1.4186E-03	6.2796E-02	-1.7565E-01	-1.6427E-01	-1.8703E-01
M2	-3.2189E-01	-1.1961E+00	5.5232E-01	-3.3455E-01	-2.5888E-01	-4.1022E-01	1.7475E-01	1.7119E-01	1.7830E-01
M3	4.1577E-01	1.5621E+00	-7.3058E-01	4.5016E-01	3.7132E-01	5.2901E-01	-2.8414E-02	-4.2724E-02	-1.4104E-02
M4	-1.8072E-01	-9.5228E-01	5.9083E-01	-2.8115E-01	-2.4076E-01	-3.2154E-01	-5.2759E-02	-3.6218E-02	-6.9300E-02
M5	2.2805E-02	2.8139E-01	-2.3578E-01	8.4769E-02	7.4696E-02	9.4843E-02	3.1249E-02	2.4385E-02	3.8113E-02
M6	1.8124E-03	-3.2476E-02	3.6103E-02	-9.8875E-03	-8.9169E-03	-1.0858E-02	-5.2285E-03	-4.2159E-03	-6.2412E-03
M7									
M8									
M9									
R	0.99999	1	0.99998	1	1	1	0.99975	0.99985	0.99964

Figure 4.4a: Transmission Coefficients for Concrete Type 1 walls (relative to free space). Nominal thicknesses: C14L = 102 mm; C18L = 203 mm; C112L = 305 mm. Dotted Curves represent +/- 1 standard deviation from mean (Solid Curves). Low Range Data: 0.5 to 2.0 GHz

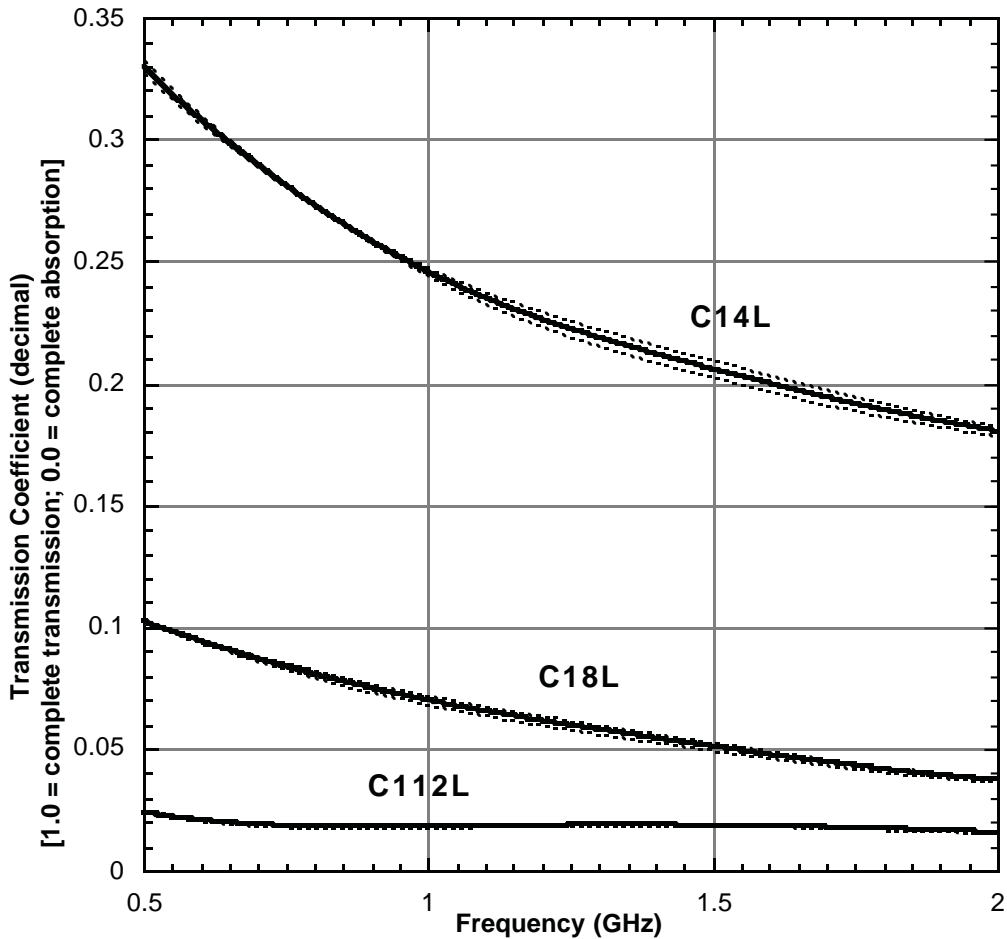

Table 4.4b: Regression Coefficients (dB) for Concrete Type 1 Transmission versus Frequency Curves Plotted in Figure 4.4b. The regression equation is of the form
 Received Signal Magnitude (relative to free space)
 $= M0+M1*F+M2*F^2+M3*F^3+M4*F^4+M5*F^5+M6*F^6$, where F is the frequency in GHz.
 The correlation coefficient, R, is defined in the text.
 Data are for the Frequency Range 0.5 to 2.0 GHz.

Concrete Type 1 Attenuation Curves (0.5 to 2.0 GHz)									
Curve Identification									
Coefficient	C14L dB	C14L + sigma dB	C14L - sigma dB	C18L dB	C18L + sigma dB	C18L - sigma dB	C112L dB	C112L + sigma dB	C112L - sigma dB
M0	-7.9286E+00	-9.7672E+00	-6.0598E+00	-1.9516E+01	-1.9965E+01	-1.9973E+01	-1.9320E+01	-1.9874E+01	-1.8879E+01
M1	5.3499E-01	1.3658E+01	-1.2776E+01	1.2151E+01	1.5324E+01	1.4838E+01	-2.7660E+01	-2.9674E+01	-2.4683E+01
M2	-1.2311E+01	-4.6550E+01	2.2368E+01	-4.3788E+01	-5.0952E+01	-4.9105E+01	-3.0002E+01	-1.3976E+01	-4.8861E+01
M3	9.3891E+00	5.2673E+01	-3.4393E+01	4.7941E+01	5.6012E+01	5.1657E+01	1.0578E+02	7.7935E+01	1.3745E+02
M4	-8.4422E-01	-2.9225E+01	2.7824E+01	-2.5801E+01	-3.0704E+01	-2.6500E+01	-9.4379E+01	-7.3213E+01	-1.1818E+02
M5	-1.4187E+00	7.9041E+00	-1.0823E+01	6.5042E+00	8.0386E+00	6.2677E+00	3.5923E+01	2.8371E+01	4.4373E+01
M6	3.9117E-01	-8.2580E-01	1.6172E+00	-5.7868E-01	-7.7288E-01	-4.9816E-01	-5.1097E+00	-4.0730E+00	-6.2674E+00
M7									
M8									
M9									
R	0.99999	1	0.99999	1	1	1	0.9995	0.9997	0.99923

Figure 4.4b: Received Signal Magnitude (dB) for Concrete Type 1 Walls (relative to free space). Nominal thicknesses:
 C14L = 102 mm; C18L = 203 mm; C112L = 305 mm
 Dotted Curves represent +/- 1 standard deviation from mean (Solid Curves).
 Low Range Data: 0.5 to 2.0 GHz

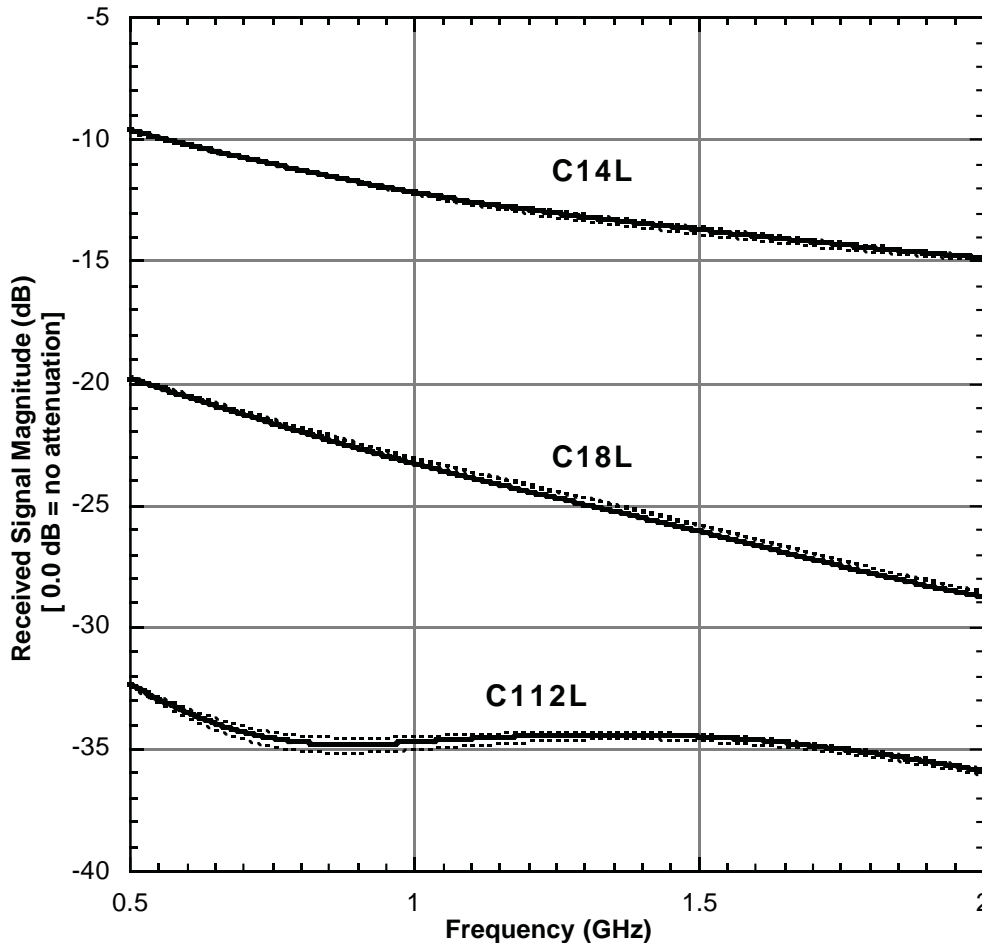

Table 4.4c: Regression Coefficients (decimal) for Concrete Type 1 Transmission versus Frequency Curves Plotted in Figure 4.4c. The regression equation is of the form $\text{Transmission Coefficient} = M_0 + M_1 * F + M_2 * F^2 + M_3 * F^3 + M_4 * F^4 + M_5 * F^5 + M_6 * F^6$ etc. where F is the frequency in GHz. The correlation coefficient, R, is defined in the text. Data are for the Frequency Range 3.0 to 8.0 GHz.

Concrete Type 1 Attenuation Curves (3.0 to 8.0 GHz)									
Curve Identification									
Coefficient	C14H	C14H + sigma	C14H - sigma	C18H	C18H + sigma	C18H - sigma	C112H	C112H + sigma	C112H - sigma
	Decimal	Decimal	Decimal	Decimal	Decimal	Decimal	Decimal	Decimal	Decimal
M0	5.1013E-01	5.2142E-01	4.9888E-01	2.7950E-02	2.8330E-02	2.7562E-02	1.8400E-03	2.1752E-03	1.4950E-03
M1	-6.8984E-01	-7.0613E-01	-6.7362E-01	-3.4066E-02	-3.4094E-02	-3.4028E-02	-2.6178E-03	-3.0958E-03	-2.1251E-03
M2	4.2180E-01	4.3185E-01	4.1180E-01	2.0177E-02	2.0062E-02	2.0288E-02	1.6111E-03	1.9038E-03	1.3094E-03
M3	-1.2626E-01	-1.2936E-01	1.2320E-01	-5.7195E-03	-5.6238E-03	-5.8140E-03	-4.6437E-04	-5.5677E-04	-3.6933E-04
M4	1.6003E-02	1.6443E-02	1.5572E-02	5.5084E-04	5.1483E-04	5.8685E-04	4.7371E-05	6.1869E-05	3.2557E-05
M5	1.0723E-03	1.0792E-03	1.0635E-03	1.2131E-04	1.2905E-04	1.1352E-04	8.3175E-06	7.9096E-06	8.6944E-06
M6	-6.7554E-04	6.8828E-04	-6.6255E-04	-4.5794E-05	-4.6798E-05	-4.4774E-05	-3.2792E-06	-3.5224E-06	-3.0203E-06
M7	9.8276E-05	1.0027E-04	9.6264E-05	6.2614E-06	6.3381E-06	6.1829E-06	4.43E-07	4.8522E-07	3.9819E-07
M8	-6.5776E-06	-6.7150E-06	-6.4393E-06	-4.1499E-07	-4.1805E-07	-4.1181E-07	-2.8770E-08	-3.1738E-08	-2.5658E-08
M9	1.7403E-07	1.7775E-07	1.7029E-07	1.1076E-08	1.1122E-08	1.1027E-08	7.5170E-10	8.3089E-10	6.6872E-10
R	1	1	1	1	1	1	1	1	1

Figure 4.4c: Transmission Coefficients for Concrete Type 1 walls (relative to free space). Nominal thicknesses: C14H = 102 mm; C18H = 203 mm; C112H = 305 mm. Dotted Curves represent +/- 1 standard deviation from mean (Solid Curves). High Range Data: 3.0 to 8.0 GHz

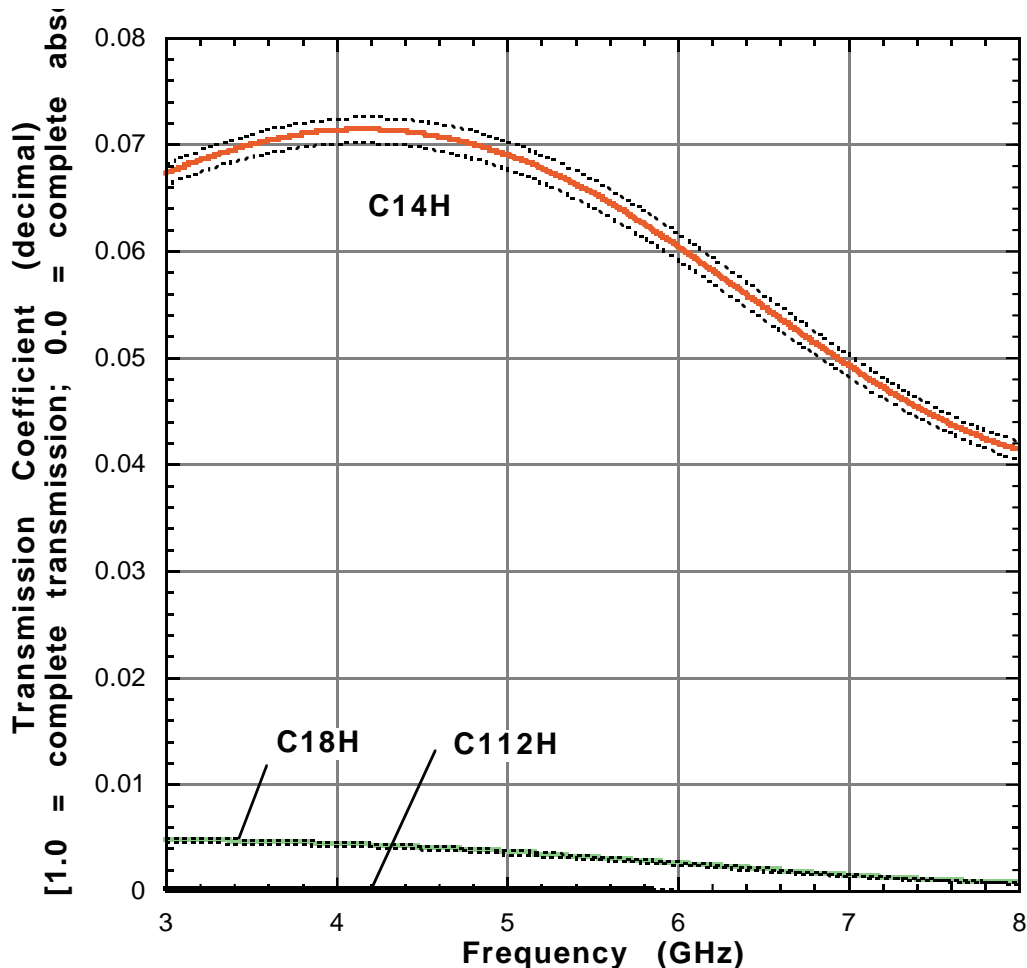
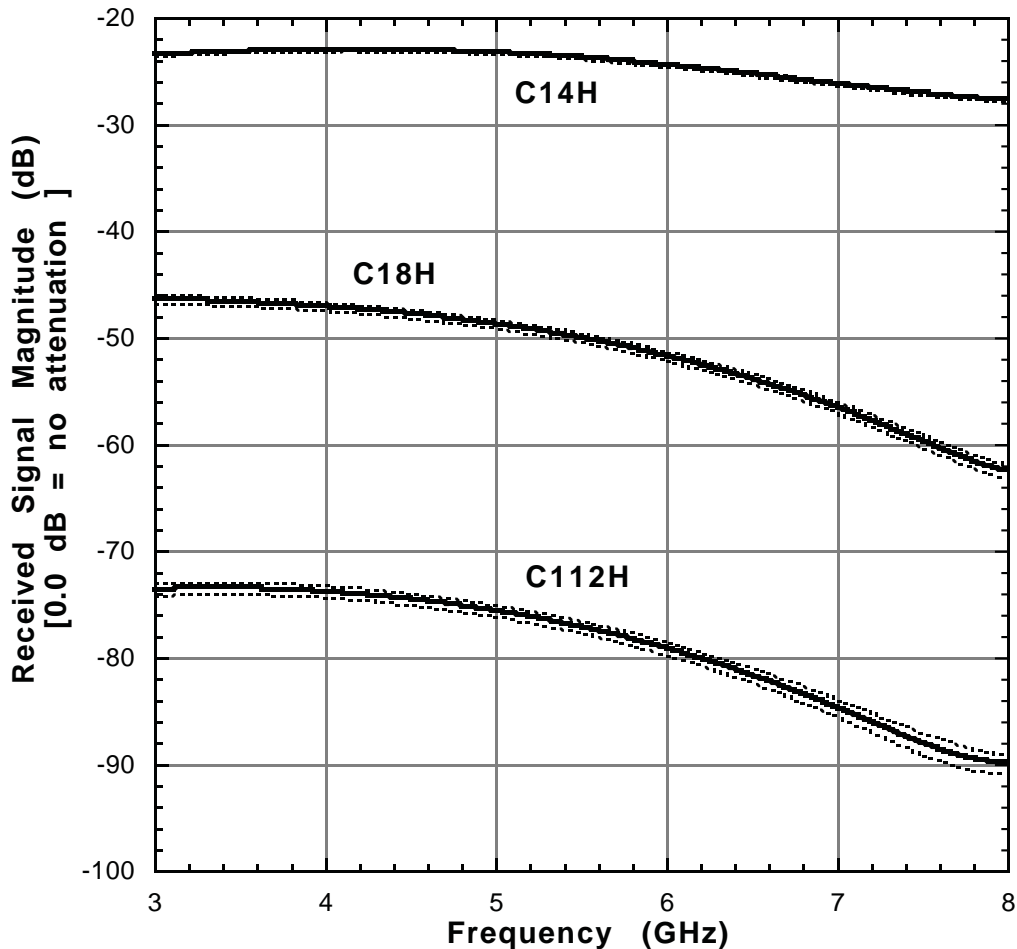

Table 4.4d: Regression Coefficients (dB) for Concrete Type 1 Transmission versus Frequency Curves Plotted in Figure 4.4d. The regression equation is of the form
 Received Signal Magnitude (relative to free space)
 $= M_0 + M_1 * F + M_2 * F^2 + M_3 * F^3 + M_4 * F^4 + M_5 * F^5 + M_6 * F^6$, where F is the frequency in GHz.
 The correlation coefficient, R, is defined in the text.
 Data are for the Frequency Range 3.0 to 8.0 GHz.

Concrete Type 1 Attenuation Curves (3.0 to 8.0 GHz)									
Curve Identification									
Coefficient	C14H	C14H + sigma	C14H - sigma	C18H	C18H + sigma	C18H - sigma	C112H	C112H + sigma	C112H - sigma
	dB	dB	dB	dB	dB	dB	dB	dB	dB
M0	3.3110E+01	3.3330E+01	3.2886E+01	1.6811E+02	1.4175E+02	1.9955E+02	6.7802E+01	7.6859E+01	5.9012E+01
M1	-8.8319E+01	-8.8568E+01	-8.8062E+01	-3.2842E+02	-2.8711E+02	-3.7760E+02	-2.2797E+02	-2.3778E+02	-2.1945E+02
M2	5.3943E+01	5.4132E+01	5.3746E+01	2.0689E+02	1.8050E+02	2.3830E+02	1.4618E+02	1.5080E+02	1.4277E+02
M3	-1.6053E+01	-1.6123E+01	-1.5978E+01	-6.6763E+01	-5.7975E+01	-7.7235E+01	-4.6098E+01	-4.7412E+01	-4.5223E+01
M4	2.0035E+00	2.0173E+00	1.9879E+00	1.0358E+01	8.8556E+00	1.2155E+01	6.1910E+00	6.5559E+00	5.8463E+00
M5	1.3960E-01	1.3872E-01	1.4092E-01	-7.4879E-02	-5.8497E-03	-1.6011E-01	3.9922E-01	2.8260E-01	5.4872E-01
M6	-8.4168E-02	-8.4366E-02	-8.4032E-02	-2.5409E-01	-2.3313E-01	-2.7840E-01	-2.7700E-01	-2.4883E-01	-3.1635E-01
M7	1.2014E-02	1.2065E-02	1.1968E-02	4.3347E-02	3.9133E-02	4.8287E-02	4.27E-02	3.8631E-02	4.8422E-02
M8	-7.9082E-04	-7.9549E-04	-7.8639E-04	-3.1547E-03	-2.8359E-03	-3.5292E-03	-3.0410E-03	-2.7315E-03	-3.4760E-03
M9	2.0626E-05	2.0787E-05	2.0471E-05	8.9365E-05	8.0241E-05	1.0009E-04	8.6331E-05	7.6653E-05	9.9795E-05
R	1	1	1	1	1	1	1	1	1

Figure 4.4d: Received Signal Magnitude (dB) for Concrete Type 1 Walls (relative to free space). Nominal thicknesses:
 C14H = 102 mm; C18H = 203 mm; C112H = 305 mm
 Dotted Curves represent +/- 1 standard deviation from mean (Solid Curves).
 High Range Data: 3.0 to 8.0 GHz



BLANK PAGE

4.5 Plain Concrete: Batch 2 Mix

The following four tables (4.5a through 4.5d) present the frequency response spectrum for a plain concrete wall. The specimens in this series bear the designation C2XXL and C2XXH, where the “XX” defines the specimen thickness in inches, and the L and H denote “low” (0.5 to 2.0 GHz) and “high” (3.0 to 8.0 GHz) frequency bandwidths.

The Batch 2 concrete specimens had an approximate water cement ratio of 0.39, a slump of 165 mm (“high”), a nominal

maximum crushed aggregate size of 12.7 mm (“small”), a cement content (by weight) of 25%, and an average density of 2.31 g/cc.

Figures 4.5a and 4.5b cover the band from 0.5 to 2.0 GHz, while Figures 4.5c and 4.5d are for the range 3.0 to 8.0 GHz. The ordinate values represent the ratio of the received to transmitted signal. The decimal attenuation values are presented first, followed by the same ordinate set converted to decibels.



Figure 4.5: Measuring thickness variations for a nominal 305 mm thick concrete specimen.

Table 4.5a: Regression Coefficients (decimal) for Concrete Type 2 Transmission versus Frequency Curves Plotted in Figure 4.5a. The regression equation is of the form $\text{Transmission Coefficient} = M_0 + M_1 * F + M_2 * F^2 + M_3 * F^3 + M_4 * F^4 + M_5 * F^5 + M_6 * F^6$ etc. where F is the frequency in GHz. The correlation coefficient, R, is defined in the text. Data are for the Frequency Range 0.5 to 2.0 GHz.

Concrete Type 2 Attenuation Curves (0.5 to 2.0 GHz)									
Curve Identification									
Coefficient	C24L	C24L + sigma	C24L - sigma	C28L	C28L + sigma	C28L - sigma	C212L	C212L + sigma	C212L - sigma
	Decimal	Decimal	Decimal	Decimal	Decimal	Decimal	Decimal	Decimal	Decimal
M0	1.5115E+00	1.6781E+00	1.3449E+00	1.0107E-01	1.0711E-01	9.5039E-02	3.3972E-03	3.8931E-03	2.9014E-03
M1	-5.2542E+00	-6.0063E+00	-4.5020E+00	-1.4674E-01	-1.7823E-01	-1.1524E-01	1.3835E-02	1.3173E-02	1.4496E-02
M2	9.6710E+00	1.1003E+01	8.3387E+00	1.9452E-01	2.5916E-01	1.2987E-01	-3.6608E-02	-3.4865E-02	-3.8349E-02
M3	-9.7143E+00	-1.0897E+01	-8.5322E+00	-1.9013E-01	-2.5662E-01	-1.2364E-01	4.7143E-02	4.4977E-02	4.9308E-02
M4	5.3957E+00	5.9593E+00	4.8322E+00	1.1100E-01	1.4833E-01	7.3667E-02	-3.1261E-02	-2.9872E-02	-3.2648E-02
M5	-1.5524E+00	-1.6902E+00	-1.4146E+00	-3.3090E-02	-4.4083E-02	-2.2097E-02	1.0453E-02	1.0003E-02	1.0903E-02
M6	1.7967E-01	1.9313E-01	1.6621E-01	3.8416E-03	5.1721E-03	2.5111E-03	-1.3842E-03	-1.3264E-03	-1.4421E-03
M7									
M8									
M9									
R	0.99995	0.99996	0.99994	1.00000	1.00000	1.00000	0.99998	0.99998	0.99998

Figure 4.5a: Transmission Coefficients for Concrete Type 2 walls (relative to free space). Nominal thicknesses: C24L = 102 mm; C28L = 203 mm; C212L = 305 mm. Dotted Curves represent +/- 1 standard deviation from mean (Solid Curves). Low Range Data: 0.5 to 2.0 GHz

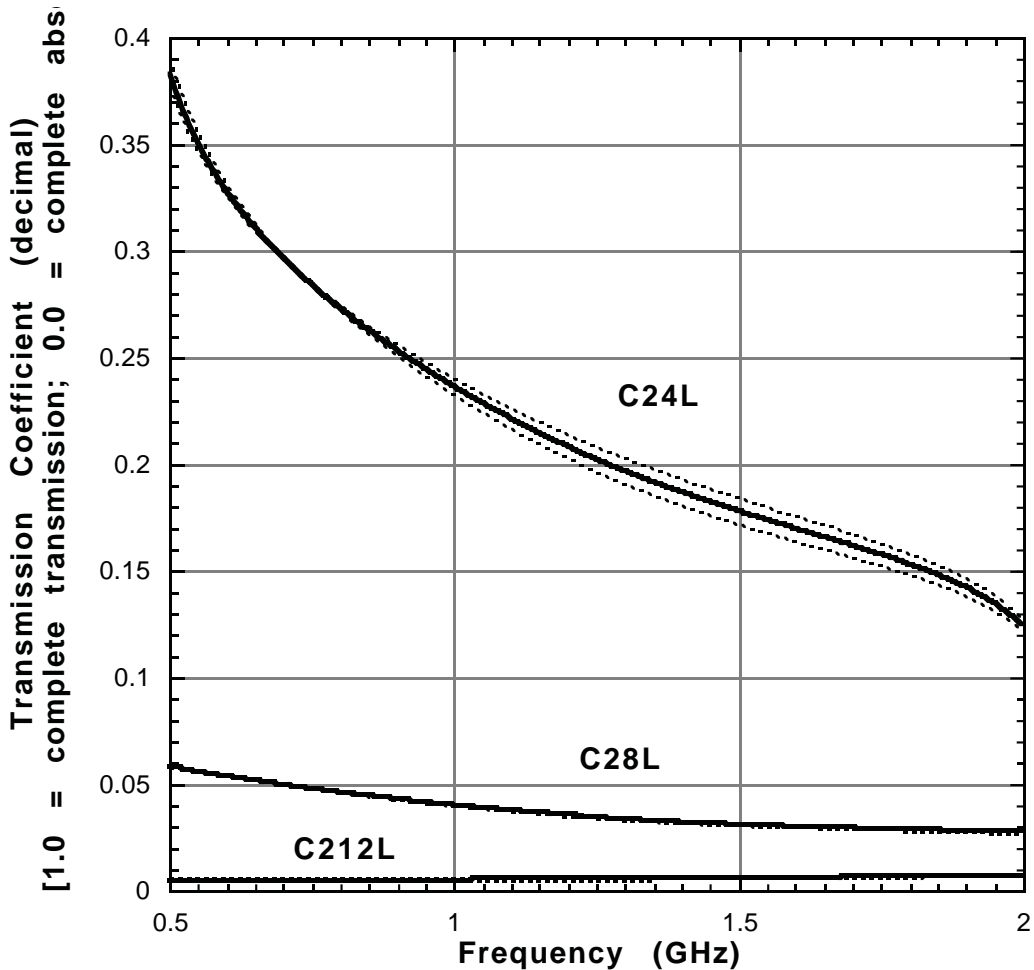

Table 4.5b: Regression Coefficients (dB) for Concrete Type 2 Transmission versus Frequency Curves Plotted in Figure 4.5b. The regression equation is of the form
 Received Signal Magnitude (relative to free space)
 $= M_0 + M_1 * F + M_2 * F^2 + M_3 * F^3 + M_4 * F^4 + M_5 * F^5 + M_6 * F^6$, where F is the frequency in GHz.
 The correlation coefficient, R, is defined in the text.
 Data are for the Frequency Range 0.5 to 2.0 GHz.

Concrete Type 2 Attenuation Curves (0.5 to 2.0 GHz)									
Curve Identification									
Coefficient	C24L	C24L + sigma	C24L - sigma	C28L	C28L + sigma	C28L - sigma	C212L	C212L + sigma	C212L - sigma
	dB	dB	dB	dB	dB	dB	dB	dB	dB
M0	1.1993E+01	1.4623E+01	9.3794E+00	-1.8223E+01	-1.7443E+01	-1.8996E+01	-4.8331E+01	-4.7388E+01	-4.9369E+01
M1	-8.5297E+01	-9.5034E+01	-7.5738E+01	-2.3568E+01	-2.7458E+01	-1.9725E+01	2.0854E+01	1.8576E+01	2.3473E+01
M2	1.3576E+02	1.4780E+02	1.2424E+02	3.6488E+01	4.4031E+01	2.9056E+01	-5.5733E+01	-4.9608E+01	-6.2786E+01
M3	-1.1670E+02	-1.2112E+02	-1.1296E+02	-4.0541E+01	-4.7841E+01	-3.3367E+01	7.2279E+01	6.4413E+01	8.1345E+01
M4	5.0742E+01	4.9114E+01	5.2796E+01	2.4156E+01	2.8129E+01	2.0253E+01	-4.8148E+01	-4.2967E+01	-5.4120E+01
M5	-9.2480E+00	-7.6983E+00	-1.0924E+01	-6.9012E+00	-8.0748E+00	-5.7456E+00	1.6157E+01	1.4438E+01	1.8139E+01
M6	2.3748E-01	-6.4144E-02	5.5357E-01	7.3263E-01	8.7879E-01	5.8815E-01	-2.1534E+00	-1.9262E+00	-2.4154E+00
M7									
M8									
M9									
R	0.99996	0.99997	0.99996	1	1	1	0.99998	0.99998	0.99998

Figure 4.5b: Received Signal Magnitude (dB) for Concrete Type 2 Walls (relative to free space). Nominal thicknesses:
 C24L = 102 mm; C28L = 203 mm; C212L = 305 mm
 Dotted Curves represent +/- 1 standard deviation from mean (Solid Curves).
 Low Range Data: 0.5 to 2.0 GHz

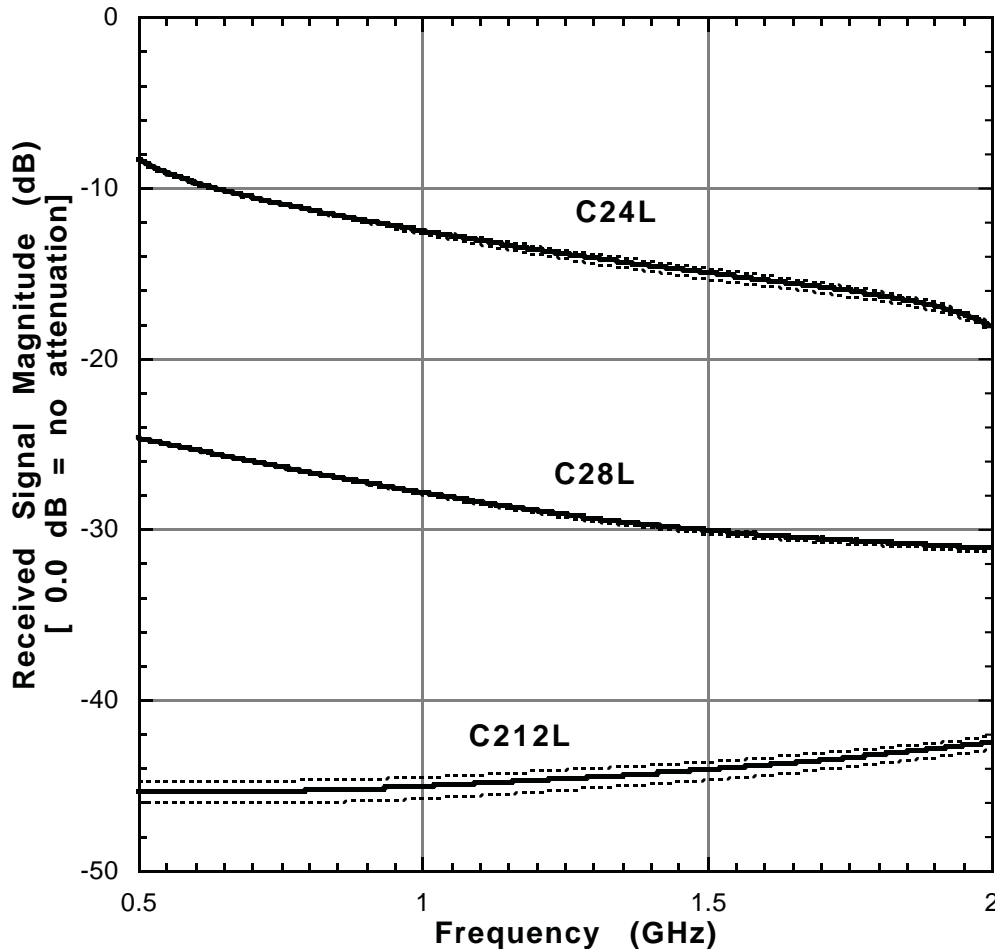

Table 4.5c: Regression Coefficients (decimal) for Concrete Type 2 Transmission versus Frequency Curves Plotted in Figure 4.5c. The regression equation is of the form $\text{Transmission Coefficient} = M_0 + M_1 \cdot F + M_2 \cdot F^2 + M_3 \cdot F^3 + M_4 \cdot F^4 + M_5 \cdot F^5 + M_6 \cdot F^6$ where F is the frequency in GHz. The correlation coefficient, R, is defined in the text. Data are for the Frequency Range 3.0 to 8.0 GHz.

Concrete Type 2 Attenuation Curves (3.0 to 8.0 GHz)									
Curve Identification									
Coefficient	C24H	C24H + sigma	C24H - sigma	C28H	C28H + sigma	C28H - sigma	C212H	C212H + sigma	C212H - sigma
	Decimal	Decimal	Decimal	Decimal	Decimal	Decimal	Decimal	Decimal	Decimal
M0	-3.3982E-02	-3.4025E-02	-3.3939E-02	5.3294E-03	3.8223E-03	6.8360E-03	-9.6950E-04	-3.5358E-04	-1.5866E-03
M1	1.0009E-01	1.0072E-01	9.9459E-02	-3.5110E-03	-1.5624E-03	-5.4590E-03	1.6303E-03	6.9823E-04	2.5642E-03
M2	-4.9740E-02	-5.0108E-02	-4.9371E-02	1.8400E-03	8.3829E-04	2.8415E-03	-1.0119E-03	-4.2150E-04	-1.6033E-03
M3	1.4413E-02	1.4541E-02	1.4285E-02	-5.0589E-04	-2.3754E-04	-7.7417E-04	3.2845E-04	1.3482E-04	5.2241E-04
M4	-2.3603E-03	-2.3827E-03	-2.3378E-03	7.2570E-05	3.3094E-05	1.1204E-04	-5.7326E-05	-2.5529E-05	-8.9183E-05
M5	1.9434E-04	1.9625E-04	1.9243E-04	-5.4904E-06	-2.4746E-06	-8.5055E-06	3.9208E-06	2.9053E-06	4.9408E-06
M6	-6.2169E-06	-6.2804E-06	-6.1534E-06	1.7894E-07	8.5542E-08	2.7231E-07	3.5814E-07	-1.9601E-07	9.1252E-07
M7							-9.37E-08	8.25E-09	-1.96E-07
M8							7.1806E-09	-3.0570E-10	1.4673E-08
M9							-2.0039E-10	9.7493E-12	-4.1069E-10
R	1	1	1	1	1	1	1.00000	1.00000	1.00000

Figure 4.5c: Transmission Coefficients for Concrete Type 2 walls (relative to free space). Nominal thicknesses: C24H = 102 mm; C28H = 203 mm; C212H = 305 mm. Dotted Curves represent +/- 1 standard deviation from mean (Solid Curves). High Range Data: 3.0 to 8.0 GHz

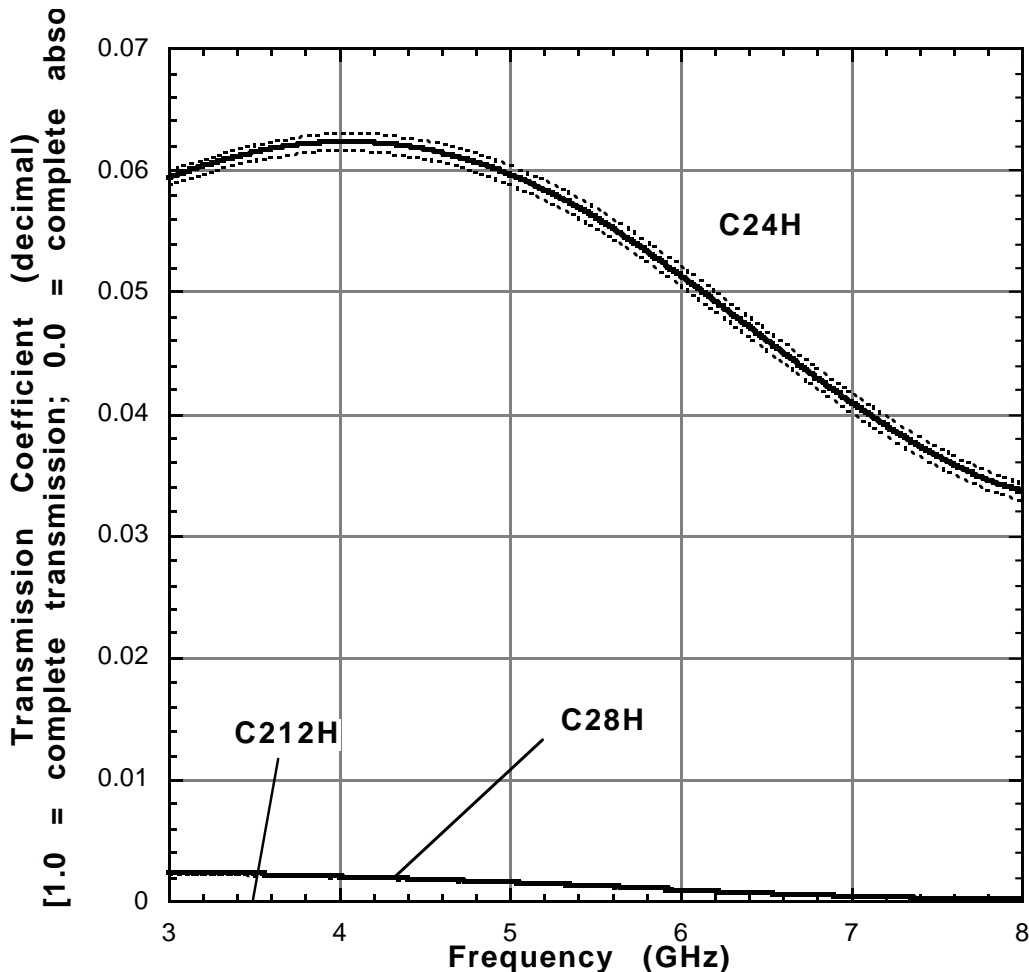
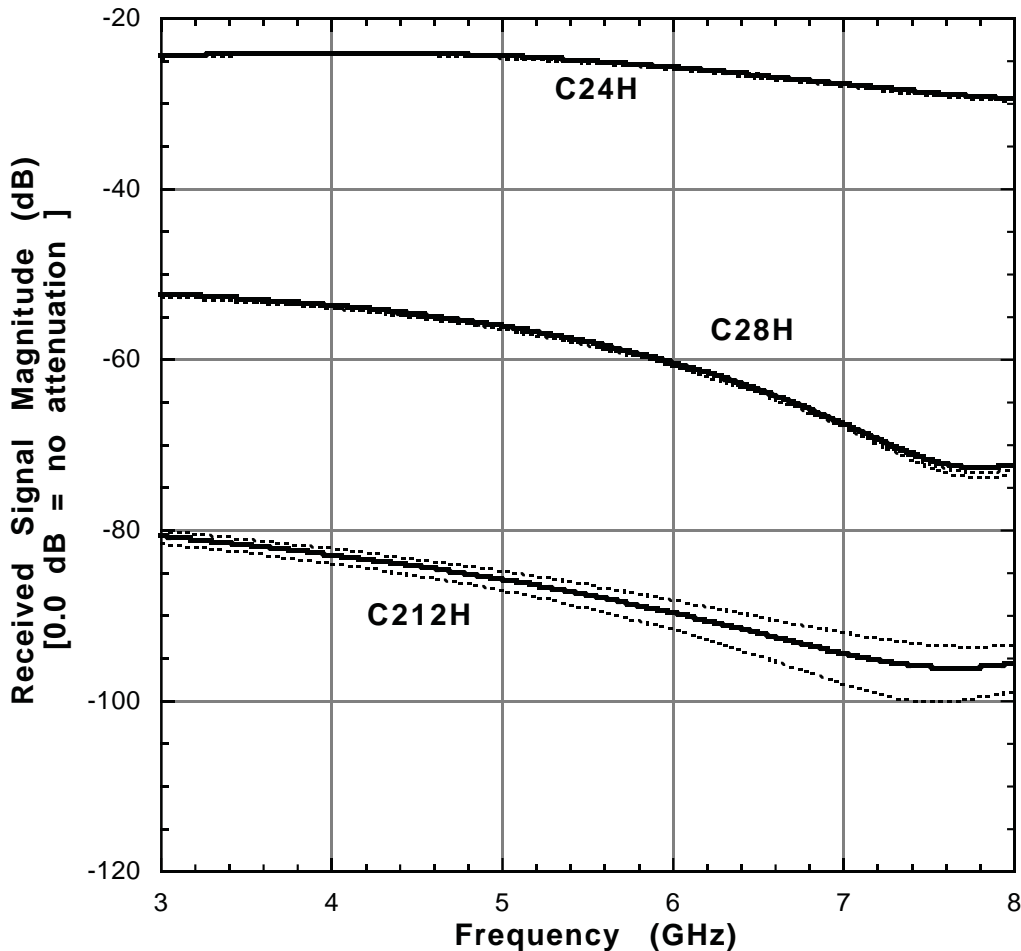

Table 4.5d: Regression Coefficients (dB) for Concrete Type 2 Transmission versus Frequency Curves Plotted in Figure 4.5d. The regression equation is of the form
 Received Signal Magnitude (relative to free space)
 $= M_0 + M_1 * F + M_2 * F^2 + M_3 * F^3 + M_4 * F^4 + M_5 * F^5 + M_6 * F^6$, where F is the frequency in GHz.
 The correlation coefficient, R, is defined in the text.
 Data are for the Frequency Range 3.0 to 8.0 GHz.

Concrete Type 2 Attenuation Curves (3.0 to 8.0 GHz)									
Curve Identification									
Coefficient	C24H dB	C24H + sigma dB	C24H - sigma dB	C28H dB	C28H + sigma dB	C28H - sigma dB	C212H dB	C212H + sigma dB	C212H - sigma dB
M0	-3.9676E+01	-3.9621E+01	-3.9723E+01	-5.4103E+02	-7.1967E+02	-3.3765E+02	-6.9460E+02	-2.1031E+02	-1.8542E+03
M1	1.5142E+01	1.5194E+01	1.5077E+01	7.2328E+02	9.9960E+02	4.0904E+02	9.3418E+02	1.9603E+02	2.7002E+03
M2	-6.6584E+00	-6.7040E+00	-6.6049E+00	-4.4701E+02	-6.2314E+02	-2.4683E+02	-5.8715E+02	-1.2102E+02	-1.7010E+03
M3	1.6625E+00	1.6817E+00	1.6408E+00	1.4860E+02	2.0657E+02	8.2690E+01	1.9317E+02	3.9744E+01	5.5968E+02
M4	-2.3213E-01	-2.3611E-01	-2.2773E-01	-2.8212E+01	-3.7647E+01	-1.7439E+01	-3.3154E+01	-7.2781E+00	-9.5167E+01
M5	1.5765E-02	1.6179E-02	1.5313E-02	2.8975E+00	3.1234E+00	2.6158E+00	1.7807E+00	6.3180E-01	4.6590E+00
M6	-3.8830E-04	-4.0531E-04	-3.6991E-04	-1.1265E-01	7.8407E-02	-3.2360E-01	3.6696E-01	8.3213E-03	1.1862E+00
M7				-0.0047492	-0.039242	0.033621	-7.76E-02	-7.02E-03	-2.41E-01
M8				4.8423E-04	3.0353E-03	-2.3566E-03	5.8257E-03	5.8149E-04	1.7946E-02
M9				-6.0888E-06	-7.8684E-05	7.4729E-05	-1.6332E-04	-1.6103E-05	-5.0273E-04
R	1	1	1	0.99999	0.99999	0.99999	1.00000	1.00000	0.99999

Figure 4.5d: Received Signal Magnitude (dB) for Concrete Type 2 Walls (relative to free space). Nominal thicknesses:
 C24H = 102 mm; C28H = 203 mm; C212H = 305 mm
 Dotted Curves represent +/- 1 standard deviation from mean (Solid Curves).
 High Range Data: 3.0 to 8.0 GHz



BLANK PAGE

4.6 Plain Concrete: Batch 3 Mix

The following four tables (4.6a through 4.6d) present the frequency response spectrum for a plain concrete wall. The specimens in this series bear the designation C3XXL and C3XXH, where the “XX” defines the specimen thickness in inches, and the L and H denote “low” (0.5 to 2.0 GHz) and “high” (3.0 to 8.0 GHz) frequency bandwidths.

The Batch 3 concrete specimens had an approximate water cement ratio of 0.48, a slump of 64 mm (“low”), a nominal maximum crushed aggregate size of 12.7 mm (“small”), a cement content (by

weight) of 14%, and an average density of 2.3 g/cc.

Figures 4.6a and 4.6b cover the band from 0.5 to 2.0 GHz, while Figures 4.6c and 4.6d are for the range 3.0 to 8.0 GHz. The ordinate values represent the ratio of the received to transmitted signal. The decimal attenuation values are presented first, followed by the same ordinate set converted to decibels.



Figure 4.6: Adjusting low frequency (0.5 to 2.0 GHz) band receiver antenna for 203 mm concrete wall test.

Table 4.6a: Regression Coefficients (decimal) for Concrete Type 3 Transmission versus Frequency Curves Plotted in Figure 4.6a. The regression equation is of the form $\text{Transmission Coefficient} = M_0 + M_1 \cdot F + M_2 \cdot F^2 + M_3 \cdot F^3 + M_4 \cdot F^4 + M_5 \cdot F^5 + M_6 \cdot F^6$ etc. where F is the frequency in GHz. The correlation coefficient, R, is defined in the text. Data are for the Frequency Range 0.5 to 2.0 GHz.

Concrete Type 3 Attenuation Curves (0.5 to 2.0 GHz)									
Curve Identification									
Coefficient	C34L	C34L + sigma	C34L - sigma	C38L	C38L + sigma	C38L - sigma	C312L	C312L + sigma	C312L - sigma
	Decimal	Decimal	Decimal	Decimal	Decimal	Decimal	Decimal	Decimal	Decimal
M0	4.2776E-01	3.0514E-01	5.5038E-01	2.0234E-01	2.3758E-01	1.6710E-01	7.8438E-02	1.1841E-01	3.8467E-02
M1	8.6563E-02	9.1873E-01	-7.4561E-01	-4.5876E-01	-6.2262E-01	-2.9490E-01	-2.0568E-01	-4.1654E-01	5.1782E-03
M2	-8.0631E-01	-2.8811E+00	1.2685E+00	7.3542E-01	1.0341E+00	4.3669E-01	2.7561E-01	7.1789E-01	-1.6667E-01
M3	1.0256E+00	3.5560E+00	-1.5048E+00	-7.3591E-01	-1.0095E+00	-4.6234E-01	-1.5727E-01	-6.3031E-01	3.1577E-01
M4	-6.0124E-01	-2.2193E+00	1.0168E+00	4.1901E-01	5.5537E-01	2.8265E-01	1.6998E-02	2.9254E-01	-2.5855E-01
M5	1.6754E-01	6.9004E-01	-3.5495E-01	-1.2308E-01	-1.5863E-01	-8.7521E-02	1.5224E-02	-6.8167E-02	9.8615E-02
M6	-1.7584E-02	-8.4947E-02	4.9780E-02	1.4379E-02	1.8184E-02	1.0573E-02	-4.0641E-03	6.2091E-03	-1.4337E-02
M7									
M8									
M9									
R	0.99999	1	0.99999	1	1	1	0.99997	0.99996	0.99994

Figure 4.6a: Transmission Coefficients for Concrete Type 3 walls (relative to free space). Nominal thicknesses: C34L = 102 mm; C38L = 203 mm; C312L = 305 mm. Dotted Curves represent +/- 1 standard deviation from mean (Solid Curves). Low Range Data: 0.5 to 2.0 GHz

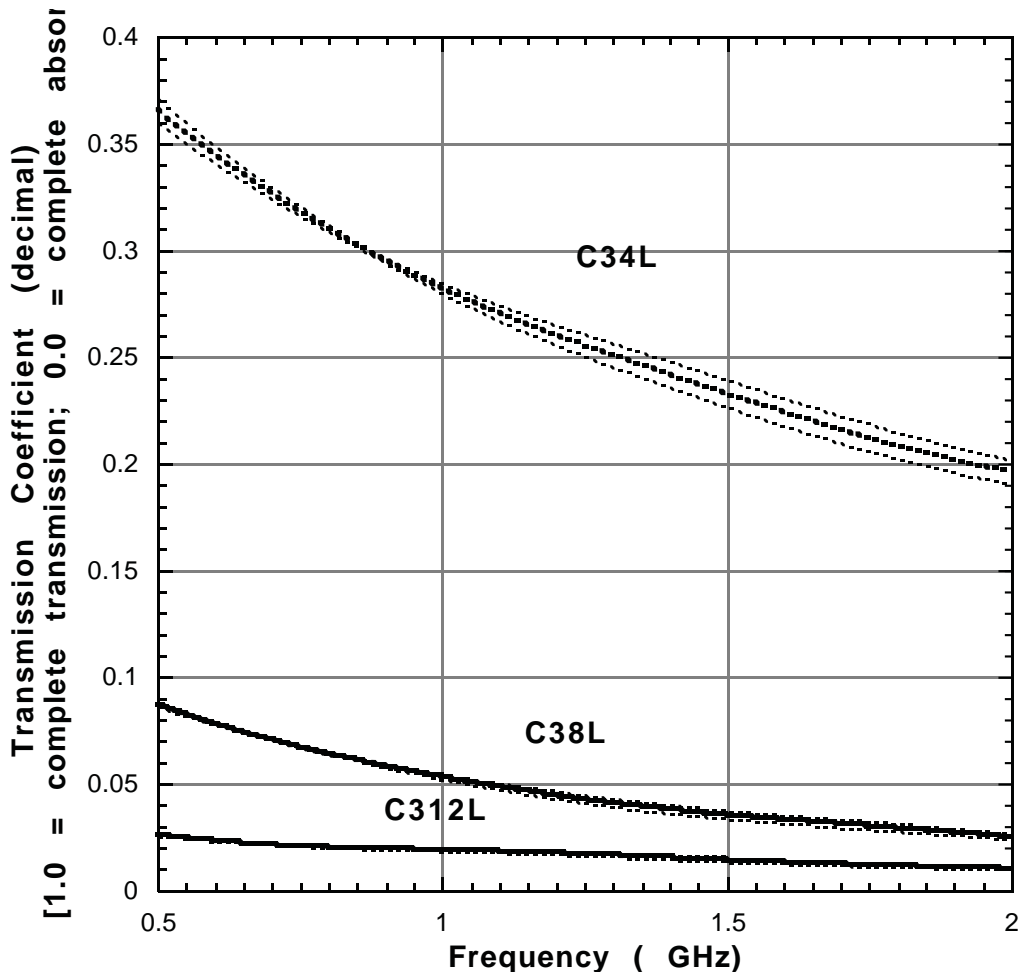

Table 4.6b: Regression Coefficients (dB) for Concrete Type 3 Transmission versus Frequency Curves Plotted in Figure 4.6b. The regression equation is of the form
 Received Signal Magnitude (relative to free space)
 $= M_0 + M_1 * F + M_2 * F^2 + M_3 * F^3 + M_4 * F^4 + M_5 * F^5 + M_6 * F^6$, where F is the frequency in GHz.
 The correlation coefficient, R, is defined in the text.
 Data are for the Frequency Range 0.5 to 2.0 GHz.

Concrete Type 3 Attenuation Curves (0.5 to 2.0 GHz)									
Curve Identification									
Coefficient	C34L dB	C34L + sigma dB	C34L - sigma dB	C38L dB	C38L + sigma dB	C38L - sigma dB	C312L dB	C312L + sigma dB	C312L - sigma dB
M0	-8.3108E+00	-1.2347E+01	-4.2289E+00	-1.0690E+01	-8.0046E+00	-1.3357E+01	-1.9398E+01	-4.3670E+00	-3.4874E+01
M1	7.1829E+00	3.3363E+01	-1.9285E+01	-4.0618E+01	-5.1772E+01	-2.9567E+01	-3.4404E+01	-1.1452E+02	4.8087E+01
M2	-2.7770E+01	-9.1391E+01	3.6511E+01	6.3805E+01	8.1145E+01	4.6609E+01	5.4500E+00	1.7513E+02	-1.6930E+02
M3	3.0264E+01	1.0647E+02	-4.6656E+01	-6.3207E+01	-7.6055E+01	-5.0297E+01	5.5335E+01	-1.2795E+02	2.4422E+02
M4	-1.5903E+01	-6.3930E+01	3.2517E+01	3.2112E+01	3.7319E+01	2.6653E+01	-6.5451E+01	4.2428E+01	-1.7675E+02
M5	3.8767E+00	1.9206E+01	-1.1558E+01	-7.3492E+00	-8.5070E+00	-6.0346E+00	2.8585E+01	-4.3503E+00	6.2608E+01
M6	-3.2541E-01	-2.2837E+00	1.6440E+00	4.9598E-01	6.0954E-01	3.5283E-01	-4.4284E+00	-3.4795E-01	-8.6481E+00
M7									
M8									
M9									
R	0.99999	1	0.99999	1	1	1	0.99998	0.99997	0.99996

Figure 4.6b: Received Signal Magnitude (dB) for Concrete Type 3 Walls (relative to free space). Nominal thicknesses:
 C34L = 102 mm; C38L = 203 mm; C312L = 305 mm
 Dotted Curves represent +/- 1 standard deviation from mean (Solid Curves).
 Low Range Data: 0.5 to 2.0 GHz

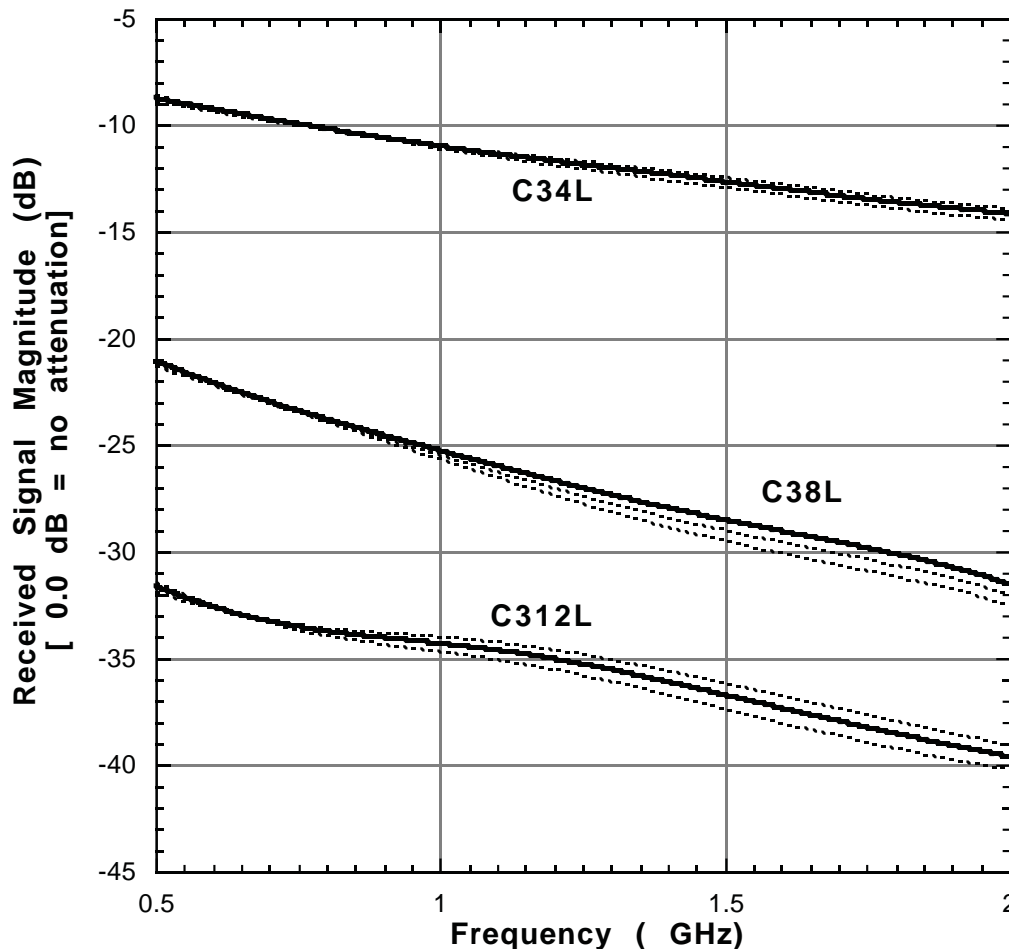

Table 4.6c: Regression Coefficients (decimal) for Concrete Type 3 Transmission versus Frequency Curves Plotted in Figure 4.6c. The regression equation is of the form $\text{Transmission Coefficient} = M_0 + M_1 \cdot F + M_2 \cdot F^2 + M_3 \cdot F^3 + M_4 \cdot F^4 + M_5 \cdot F^5 + M_6 \cdot F^6$ etc. where F is the frequency in GHz. The correlation coefficient, R, is defined in the text. Data are for the Frequency Range 3.0 to 8.0 GHz.

Concrete Type 3 Attenuation Curves (3.0 to 8.0 GHz)									
Curve Identification									
Coefficient	C34H	C34H + sigma	C34H - sigma	C38H	C38H + sigma	C38H - sigma	C312H	C312H + sigma	C312H - sigma
	Decimal	Decimal	Decimal	Decimal	Decimal	Decimal	Decimal	Decimal	Decimal
M0	-2.9934E-02	-3.0970E-02	-2.8898E-02	5.9671E-03	5.1018E-03	6.8326E-03	-7.1213E-04	-5.6040E-04	-8.6356E-04
M1	1.1300E-01	1.1495E-01	1.1106E-01	-3.6329E-03	-2.3919E-03	-4.8740E-03	1.2155E-03	1.0522E-03	1.3784E-03
M2	-5.6986E-02	-5.7900E-02	-5.6072E-02	1.8756E-03	1.2491E-03	2.5022E-03	-5.8874E-04	-5.0609E-04	-6.7121E-04
M3	1.6782E-02	1.7030E-02	1.6534E-02	-5.0386E-04	-3.3667E-04	-6.7107E-04	1.4238E-04	1.1990E-04	1.6482E-04
M4	-2.7576E-03	-2.7956E-03	-2.7196E-03	6.9284E-05	4.4460E-05	9.4112E-05	-1.8860E-05	-1.5502E-05	-2.2212E-05
M5	2.2586E-04	2.2892E-04	2.2280E-04	-4.9726E-06	-3.0585E-06	-6.8870E-06	1.2755E-06	1.0152E-06	1.5353E-06
M6	-7.1731E-06	-7.2733E-06	-7.0728E-06	1.5444E-07	9.5086E-08	2.1381E-07	-3.3388E-08	-2.5181E-08	-4.1582E-08
M7									
M8									
M9									
R	1.00000	1.00000	1.00000	1.00000	1.00000	1.00000	0.99990	0.99990	0.99991

Figure 4.6c: Transmission Coefficients for Concrete Type 3 walls (relative to free space). Nominal thicknesses: C34H = 102 mm; C38H = 203 mm; C312H = 305 mm. Dotted Curves represent +/- 1 standard deviation from mean (Solid Curves). High Range Data: 3.0 to 8.0 GHz

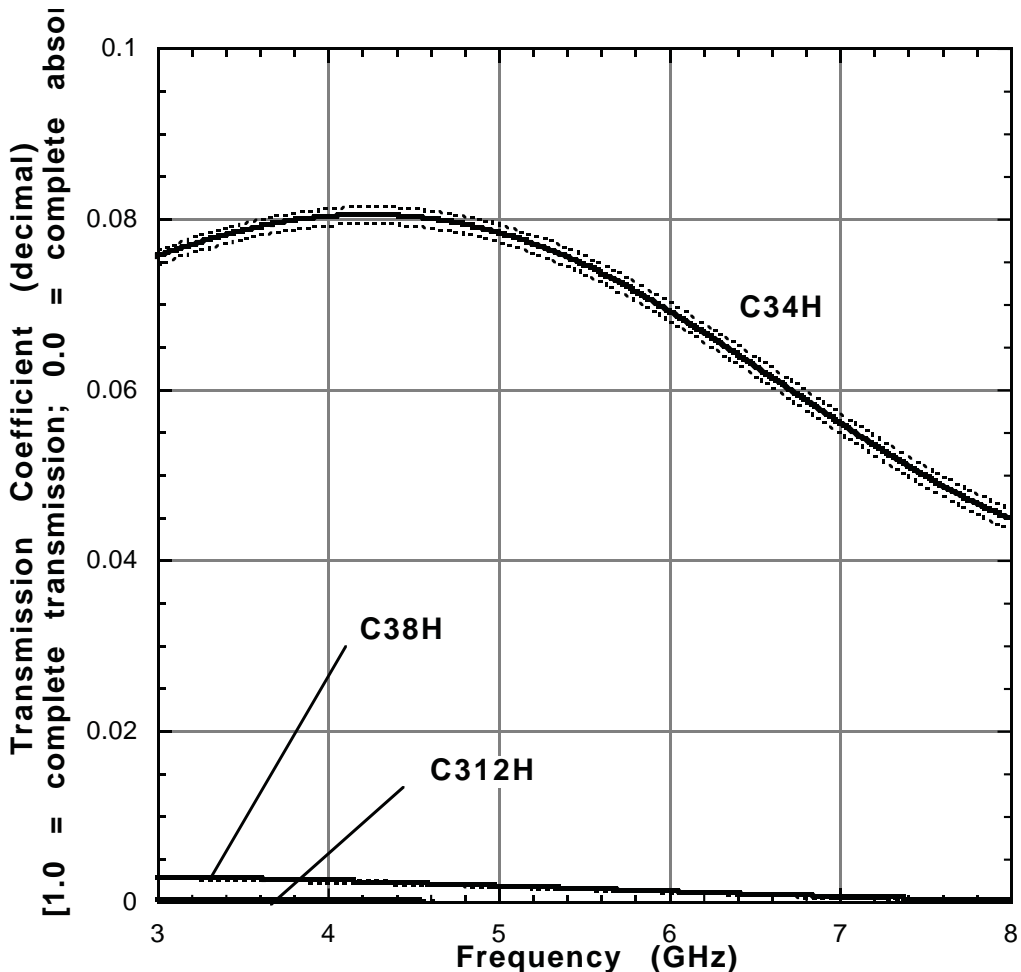
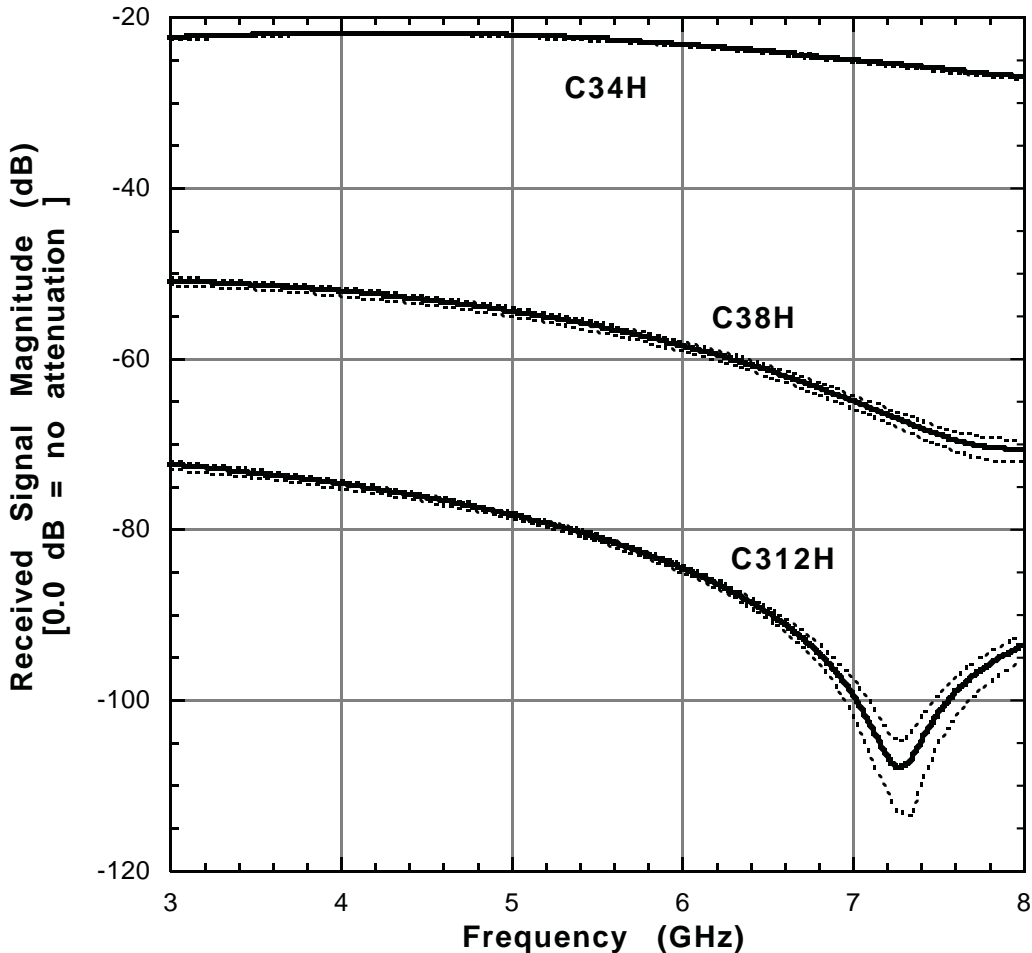

Table 4.6d: Regression Coefficients (dB) for Concrete Type 3 Transmission versus Frequency Curves Plotted in Figure 4.6d. The regression equation is of the form
 Received Signal Magnitude (relative to free space)
 $= M0+M1*F+M2*F^2+M3*F^3+M4*F^4+M5*F^5+M6*F^6$, where F is the frequency in GHz.
 The correlation coefficient, R, is defined in the text.
 Data are for the Frequency Range 3.0 to 8.0 GHz.

Concrete Type 3 Attenuation Curves (3.0 to 8.0 GHz)									
Curve Identification									
Coefficient	C34H dB	C34H + sigma dB	C34H - sigma dB	C38H dB	C38H + sigma dB	C38H - sigma dB	C312H dB	C312H + sigma dB	C312H - sigma dB
M0	-3.3066E+01	-3.3386E+01	-3.2716E+01	2.2593E+02	1.8339E+02	2.7831E+02	-3.2895E+04	-2.6831E+04	-4.4191E+04
M1	9.8512E+00	1.0372E+01	9.2908E+00	-3.5366E+02	-3.0015E+02	-4.1934E+02	4.9856E+04	4.0662E+04	6.6973E+04
M2	-4.1713E+00	-4.4435E+00	-3.8788E+00	1.8537E+02	1.5818E+02	2.1868E+02	-3.1374E+04	-2.5595E+04	-4.2134E+04
M3	1.0578E+00	1.1333E+00	9.7662E-01	-5.0913E+01	-4.3703E+01	-5.9724E+01	1.0327E+04	8.4242E+03	1.3877E+04
M4	-1.5147E-01	-1.6318E-01	-1.3893E-01	7.7190E+00	6.6678E+00	9.0000E+00	-1.7641E+03	-1.4369E+03	-2.3785E+03
M5	1.0370E-02	1.1332E-02	9.3415E-03	-6.1421E-01	-5.3435E-01	-7.1121E-01	9.0695E+01	7.2780E+01	1.2597E+02
M6	-2.5438E-04	-2.8671E-04	-2.1992E-04	2.0010E-02	1.7543E-02	2.2996E-02	2.0646E+01	1.7146E+01	2.6756E+01
M7							-4.2707E+00	-3.5252E+00	-5.6100E+00
M8							3.1898E-01	2.6313E-01	4.1981E-01
M9							-8.9352E-03	-7.3734E-03	-1.1758E-02
R	1	1	1	0.99998	0.99998	0.99996	0.99537	0.99640	0.99270

Figure 4.6d: Received Signal Magnitude (dB) for Concrete Type 3 Walls (relative to free space). Nominal thicknesses:
 C34H = 102 mm; C38H = 203 mm; C312H = 305 mm
 Dotted Curves represent +/- 1 standard deviation from mean (Solid Curves).
 High Range Data: 3.0 to 8.0 GHz



BLANK PAGE

4.7 Plain Concrete: Batch 4 Mix

The following four tables (4.7a through 4.7d) present the frequency response spectrum for a plain concrete wall. The specimens in this series bear the designation C4XXL and C4XXH, where the “XX” defines the specimen thickness in inches, and the L and H denote “low” (0.5 to 2.0 GHz) and “high” (3.0 to 8.0 GHz) frequency bandwidths.

The Batch 4 concrete specimens had an approximate water cement ratio of 0.42, a slump of 222 mm (“high”), a nominal

maximum crushed aggregate size of 12.7 mm (“small”), a cement content (by weight) of 17%, and an average density of 2.3 g/cc.

Figures 4.7a and 4.7b cover the band from 0.5 to 2.0 GHz, while Figures 4.7c and 4.7d are for the range 3.0 to 8.0 GHz. The ordinate values represent the ratio of the received to transmitted signal. The decimal attenuation values are presented first, followed by the same ordinate set converted to decibels.



Figure 4.7: Erik Anderson and Jose Ortiz measure thickness sections for 305 mm nominal thickness plain concrete panel.

Table 4.7a: Regression Coefficients (decimal) for Concrete Type 4 Transmission versus Frequency Curves Plotted in Figure 4.7a. The regression equation is of the form $\text{Transmission Coefficient} = M_0 + M_1 \cdot F + M_2 \cdot F^2 + M_3 \cdot F^3 + M_4 \cdot F^4 + M_5 \cdot F^5 + M_6 \cdot F^6$ etc. where F is the frequency in GHz. The correlation coefficient, R, is defined in the text. Data are for the Frequency Range 0.5 to 2.0 GHz.

Concrete Type 4 Attenuation Curves (0.5 to 2.0 GHz)									
Curve Identification									
Coefficient	C44L	C44L + sigma	C44L - sigma	C48L	C48L + sigma	C48L - sigma	C412L	C412L + sigma	C412L - sigma
	Decimal	Decimal	Decimal	Decimal	Decimal	Decimal	Decimal	Decimal	Decimal
M0	3.6137E-01	3.0968E-01	4.1307E-01	1.8544E-01	1.8572E-01	1.8516E-01	2.0851E-02	2.2612E-02	1.9091E-02
M1	-2.1255E-02	3.2766E-01	-3.7017E-01	-4.3886E-01	-4.2972E-01	-4.4800E-01	-3.5753E-02	-4.7188E-02	-2.4318E-02
M2	-5.2662E-01	-1.3801E+00	3.2687E-01	7.0080E-01	6.6261E-01	7.3900E-01	5.2305E-02	8.0928E-02	2.3682E-02
M3	7.2753E-01	1.7490E+00	-2.9391E-01	-6.9923E-01	-6.4025E-01	-7.5822E-01	-3.6926E-02	-7.1389E-02	-2.4627E-03
M4	-4.3799E-01	-1.0819E+00	2.0596E-01	4.0136E-01	3.5820E-01	4.4451E-01	9.9079E-03	3.1950E-02	-1.2134E-02
M5	1.2248E-01	3.2819E-01	-8.3228E-02	-1.1955E-01	-1.0434E-01	-1.3475E-01	8.4547E-04	-6.3382E-03	8.0291E-03
M6	-1.2624E-02	-3.8909E-02	1.3660E-02	1.4208E-02	1.2124E-02	1.6292E-02	-5.9596E-04	3.4148E-04	-1.5334E-03
M7									
M8									
M9									
R	1	1	0.99999	1	1	1	0.99993	0.99993	0.99993

Figure 4.7a: Transmission Coefficients for Concrete Type 4 walls (relative to free space). Nominal thicknesses: C44L = 102 mm; C48L = 203 mm; C412L = 305 mm. Dotted Curves represent +/- 1 standard deviation from mean (Solid Curves). Low Range Data: 0.5 to 2.0 GHz

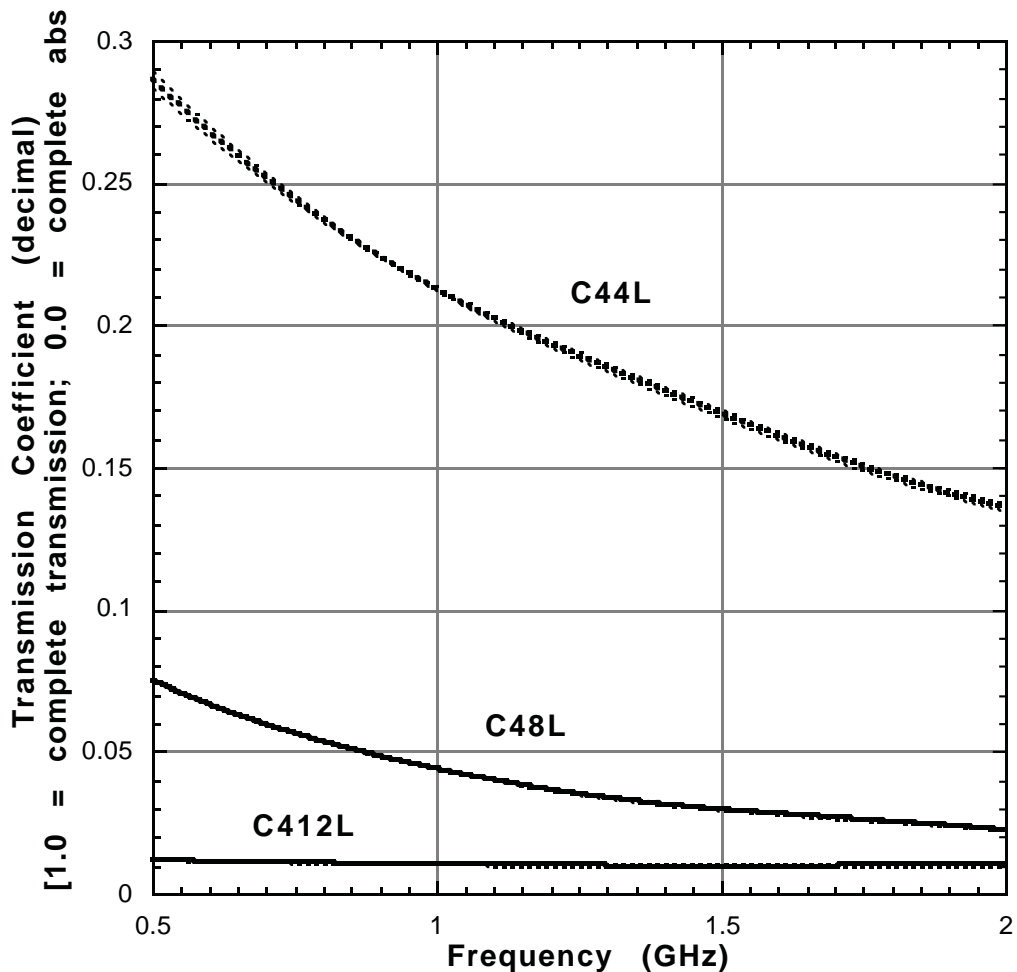

Table 4.7b: Regression Coefficients (dB) for Concrete Type 4 Transmission versus Frequency Curves Plotted in Figure 4.7b. The regression equation is of the form
 Received Signal Magnitude (relative to free space)
 $= M_0 + M_1 * F + M_2 * F^2 + M_3 * F^3 + M_4 * F^4 + M_5 * F^5 + M_6 * F^6$, where F is the frequency in GHz.
 The correlation coefficient, R, is defined in the text.
 Data are for the Frequency Range 0.5 to 2.0 GHz.

Concrete Type 4 Attenuation Curves (0.5 to 2.0 GHz)									
Curve Identification									
Coefficient	C44L dB	C44L + sigma dB	C44L - sigma dB	C48L dB	C48L + sigma dB	C48L - sigma dB	C412L dB	C412L + sigma dB	C412L - sigma dB
M0	-9.8867E+00	-1.2183E+01	-7.5780E+00	-1.0157E+01	-1.0721E+01	-9.5919E+00	-3.2301E+01	-3.0832E+01	-3.3853E+01
M1	5.6682E+00	2.0305E+01	-9.0571E+00	-4.9691E+01	-4.5190E+01	-5.4196E+01	-2.3759E+01	-3.3321E+01	-1.3691E+01
M2	-2.6365E+01	-6.1109E+01	8.6001E+00	8.3592E+01	7.1440E+01	9.5754E+01	3.2058E+01	5.6045E+01	6.8701E+00
M3	2.8748E+01	6.9509E+01	-1.2280E+01	-8.8286E+01	-7.2830E+01	-1.0374E+02	-1.8803E+01	-4.7921E+01	1.1753E+01
M4	-1.4677E+01	-3.9980E+01	1.0792E+01	4.9417E+01	3.9394E+01	5.9425E+01	1.2067E+00	2.0074E+01	-1.8597E+01
M5	3.2913E+00	1.1272E+01	-4.7419E+00	-1.3262E+01	-1.0032E+01	-1.6482E+01	2.9157E+00	-3.3297E+00	9.4738E+00
M6	-2.1513E-01	-1.2240E+00	8.0021E-01	1.2848E+00	8.7342E-01	1.6943E+00	-7.8271E-01	4.5338E-02	-1.6525E+00
M7									
M8									
M9									
R	1	0.99999	0.99999	1	1	1	0.99991	0.99991	0.99991

Figure 4.7b: Received Signal Magnitude (dB) for Concrete Type 4 Walls (relative to free space). Nominal thicknesses:
 C44L = 102 mm; C48L = 203 mm; C412L = 305 mm
 Dotted Curves represent +/- 1 standard deviation from mean (Solid Curves).
 Low Range Data: 0.5 to 2.0 GHz

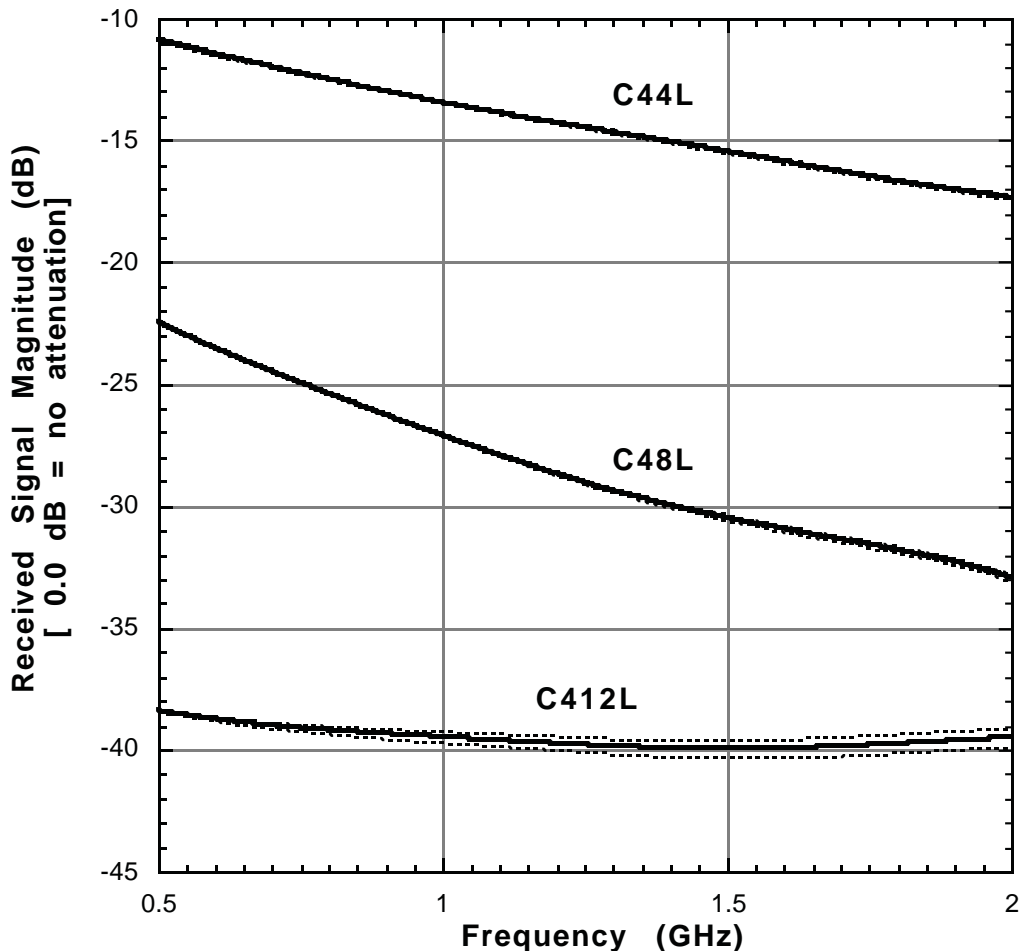

Table 4.7c: Regression Coefficients (decimal) for Concrete Type 4 Transmission versus Frequency Curves Plotted in Figure 4.7c. The regression equation is of the form $\text{Transmission Coefficient} = M_0 + M_1 * F + M_2 * F^2 + M_3 * F^3 + M_4 * F^4 + M_5 * F^5 + M_6 * F^6$ where F is the frequency in GHz. The correlation coefficient, R, is defined in the text. Data are for the Frequency Range 3.0 to 8.0 GHz.

Concrete Type 4 Attenuation Curves (3.0 to 8.0 GHz)									
Curve Identification									
Coefficient	C44H	C44H + sigma	C44H - sigma	C48H	C48H + sigma	C48H - sigma	C412H	C412H + sigma	C412H - sigma
	Decimal	Decimal	Decimal	Decimal	Decimal	Decimal	Decimal	Decimal	Decimal
M0	-2.5627E-02	2.0714E-02	-7.1967E-02	5.1733E-03	8.1318E-03	2.2138E-03	-4.8994E-04	1.1261E-04	-1.0896E-03
M1	9.1244E-02	3.2472E-02	1.5002E-01	-1.5825E-03	-4.9407E-03	1.7769E-03	1.1571E-03	2.7513E-04	2.0352E-03
M2	-4.5467E-02	-1.4670E-02	-7.6265E-02	7.1915E-04	2.3239E-03	-8.8623E-04	-7.4820E-04	-1.9907E-04	-1.2952E-03
M3	1.3261E-02	4.7720E-03	2.1750E-02	-1.9953E-04	-5.9600E-04	1.9710E-04	2.4319E-04	6.6759E-05	4.1915E-04
M4	-2.1831E-03	-8.8459E-04	-3.4817E-03	2.5750E-05	7.8593E-05	-2.7114E-05	-4.3159E-05	-1.6067E-05	-7.0247E-05
M5	1.7987E-04	7.5565E-05	2.8417E-04	-1.7203E-06	-5.3187E-06	1.8798E-06	3.6202E-06	3.5636E-06	3.7019E-06
M6	-5.7382E-06	-2.3110E-06	-9.1655E-06	5.6527E-08	1.5446E-07	-4.1451E-08	1.2751E-08	-6.8618E-07	7.0539E-07
M7							-2.71E-08	8.94E-08	-1.43E-07
M8							1.8784E-09	-6.4251E-09	1.0137E-08
M9							-3.9649E-11	1.8942E-10	-2.6761E-10
R	1	1	1	1	1	1	1.00000	1.00000	1.00000

Figure 4.7c: Transmission Coefficients for Concrete Type 4 walls (relative to free space). Nominal thicknesses: C44H = 102 mm; C48H = 203 mm; C412H = 305 mm. Dotted Curves represent +/- 1 standard deviation from mean (Solid Curves). High Range Data: 3.0 to 8.0 GHz

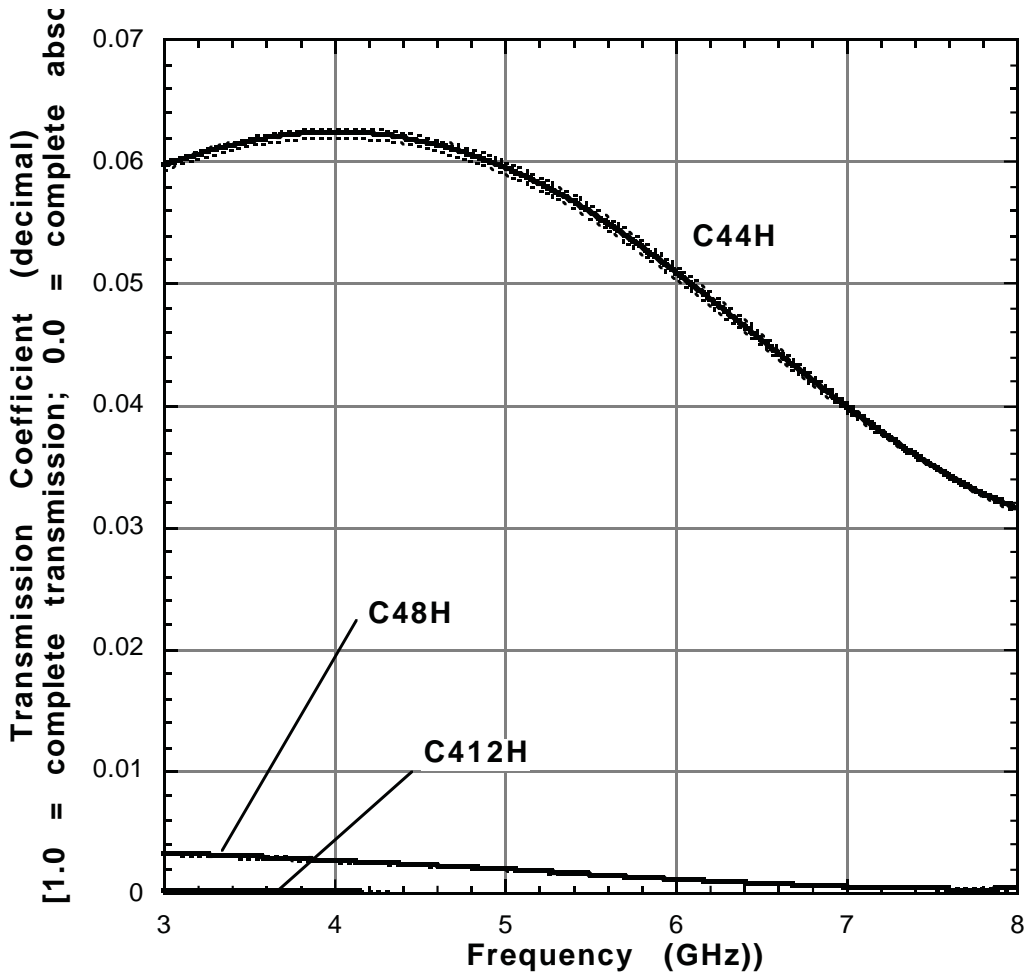
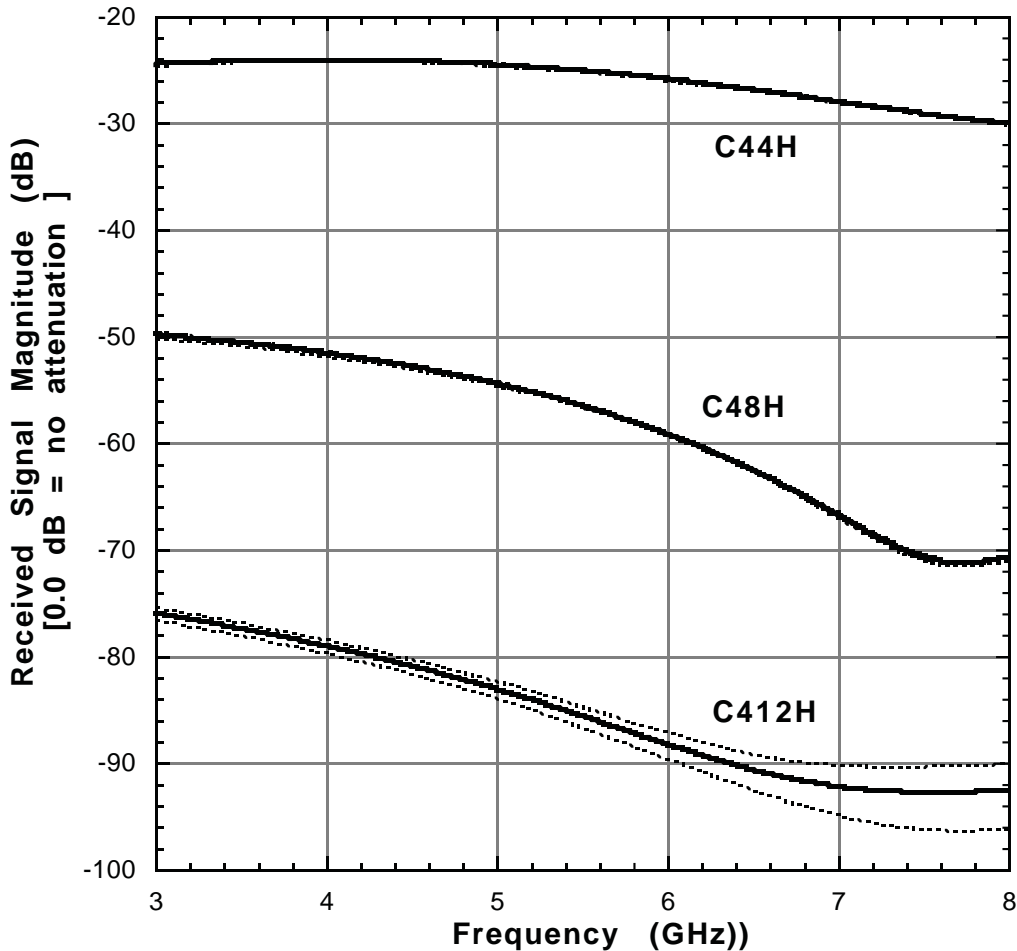

Table 4.7d: Regression Coefficients (dB) for Concrete Type 4 Transmission versus Frequency Curves
 Plotted in Figure 4.7d. The regression equation is of the form
 Received Signal Magnitude (relative to free space)
 $= M_0 + M_1 * F + M_2 * F^2 + M_3 * F^3 + M_4 * F^4 + M_5 * F^5 + M_6 * F^6$, where F is the frequency in GHz.
 The correlation coefficient, R, is defined in the text.
 Data are for the Frequency Range 3.0 to 8.0 GHz.

Concrete Type 4 Attenuation Curves (3.0 to 8.0 GHz)									
Curve Identification									
Coefficient	C44H dB	C44H + sigma dB	C44H - sigma dB	C48H dB	C48H + sigma dB	C48H - sigma dB	C412H dB	C412H + sigma dB	C412H - sigma dB
M0	-3.5412E+01	-2.0154E+01	-5.0866E+01	-1.4430E+03	-8.7228E+02	-2.0460E+03	1.9642E+02	4.1401E+02	-2.2286E+02
M1	1.0029E+01	-9.3100E+00	2.9621E+01	2.1084E+03	1.2387E+03	3.0272E+03	-4.1396E+02	-7.4628E+02	2.2332E+02
M2	-4.0741E+00	5.9880E+00	-1.4270E+01	-1.3240E+03	-7.7555E+02	-1.9034E+03	2.6226E+02	4.7190E+02	-1.3794E+02
M3	9.6873E-01	-1.7747E+00	3.7494E+00	4.3794E+02	2.5777E+02	6.2831E+02	-8.5432E+01	-1.5355E+02	4.4630E+01
M4	-1.2878E-01	2.8455E-01	-5.4782E-01	-7.7080E+01	-4.6805E+01	-1.0911E+02	1.3369E+01	2.4232E+01	-7.7778E+00
M5	7.7213E-03	-2.4869E-02	4.0769E-02	5.0383E+00	3.7196E+00	6.4500E+00	-1.2659E-01	-3.4394E-01	5.3283E-01
M6	-1.3585E-04	9.1367E-04	-1.2003E-03	5.8075E-01	1.5685E-01	1.0245E+00	-3.1449E-01	-5.3878E-01	4.9230E-02
M7				-0.14127	-0.058484	-0.22823	5.27E-02	9.20E-02	-1.32E-02
M8				1.0681E-02	4.5543E-03	1.7120E-02	-3.7071E-03	-6.5376E-03	1.0548E-03
M9				-2.9446E-04	-1.2294E-04	-4.7476E-04	1.0003E-04	1.7851E-04	-3.1077E-05
R	1	1	1	0.99998	0.99999	0.99997	1.00000	1.00000	1.00000

Figure 4.7d: Received Signal Magnitude (dB) for Concrete Type 4 Walls
 (relative to free space). Nominal thicknesses:
 C44H = 102 mm; C48H = 203 mm; C412H = 305 mm
 Dotted Curves represent +/- 1 standard deviation from mean (Solid Curves).
 High Range Data: 3.0 to 8.0 GHz



BLANK PAGE

4.8 Plain Concrete: Batch 5 Mix

The following four tables (4.8a through 4.8d) present the frequency response spectrum for a plain concrete wall. The specimens in this series bear the designation C5XXL and C5XXH, where the “XX” defines the specimen thickness in inches, and the L and H denote “low” (0.5 to 2.0 GHz) and “high” (3.0 to 8.0 GHz) frequency bandwidths.

The Batch 5 concrete specimens had an approximate water cement ratio of 0.60, a slump of 76 mm (“low”), a nominal

maximum crushed aggregate size of 25.4 mm (“large”), a cement content (by weight) of 17%, and an average density of 2.42 g/cc.

Figures 4.8a and 4.8b cover the band from 0.5 to 2.0 GHz, while Figures 4.8c and 4.8d are for the range 3.0 to 8.0 GHz. The ordinate values represent the ratio of the received to transmitted signal. The decimal attenuation values are presented first, followed by the same ordinate set converted to decibels.

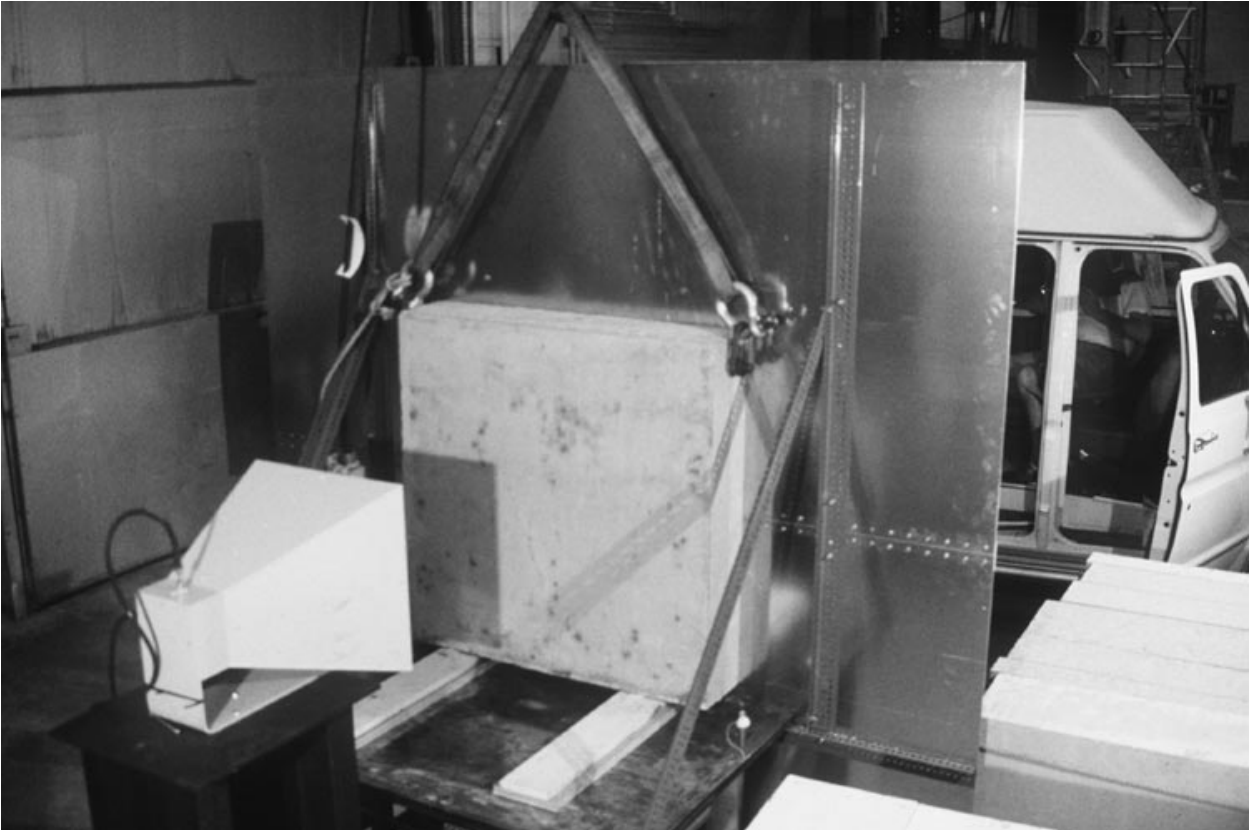

Figure 4.8: Test setup for specimen C58L (203 mm thick plain concrete wall) for frequency response determination from 0.5 to 2.0 GHz. See Figures 4.8a and 4.8b.

Table 4.8a: Regression Coefficients (decimal) for Concrete Type 5 Transmission versus Frequency Curves Plotted in Figure 4.8a. The regression equation is of the form $\text{Transmission Coefficient} = M_0 + M_1 * F + M_2 * F^2 + M_3 * F^3 + M_4 * F^4 + M_5 * F^5 + M_6 * F^6$ etc. where F is the frequency in GHz. The correlation coefficient, R, is defined in the text. Data are for the Frequency Range 0.5 to 2.0 GHz.

Concrete Type 5 Attenuation Curves (0.5 to 2.0 GHz)									
Coefficient	Curve Identification								
	C54L Decimal	C54L + sigma Decimal	C54L - sigma Decimal	C58L Decimal	C58L + sigma Decimal	C58L - sigma Decimal	C512L Decimal	C512L + sigma Decimal	C512L - sigma Decimal
M0	4.2273E-01	3.0341E-01	5.4204E-01	2.4365E-01	2.8104E-01	2.0626E-01	4.6061E-02	5.0459E-02	4.1663E-02
M1	-2.7851E-02	7.9352E-01	-8.4923E-01	-5.4943E-01	-7.4803E-01	-3.5083E-01	-5.0757E-02	-7.3741E-02	-2.7772E-02
M2	-5.9126E-01	-2.6728E+00	1.4903E+00	8.8667E-01	1.3020E+00	4.7130E-01	3.7062E-02	8.5538E-02	-1.1413E-02
M3	8.0743E-01	3.3841E+00	-1.7693E+00	-8.9354E-01	-1.3327E+00	-4.5434E-01	-8.3134E-03	-5.8203E-02	4.1576E-02
M4	-4.7886E-01	-2.1490E+00	1.1913E+00	5.1252E-01	7.6565E-01	2.5940E-01	-5.6374E-03	2.1981E-02	-3.3256E-02
M5	1.3205E-01	6.7798E-01	-4.1389E-01	-1.5168E-01	-2.2779E-01	-7.5568E-02	3.9411E-03	-4.0004E-03	1.1883E-02
M6	-1.3405E-02	-8.4572E-02	5.7763E-02	1.7882E-02	2.7236E-02	8.5275E-03	-7.1533E-04	2.1899E-04	-1.6497E-03
M7									
M8									
M9									
R	1	1	0.99998	1	1	1	1	1	1

Figure 4.8a: Transmission Coefficients for Concrete Type 5 walls (relative to free space). Nominal thicknesses: C54L = 102 mm; C58L = 203 mm; C512L = 305 mm. Dotted Curves represent +/- 1 standard deviation from mean (Solid Curves). Low Range Data: 0.5 to 2.0 GHz

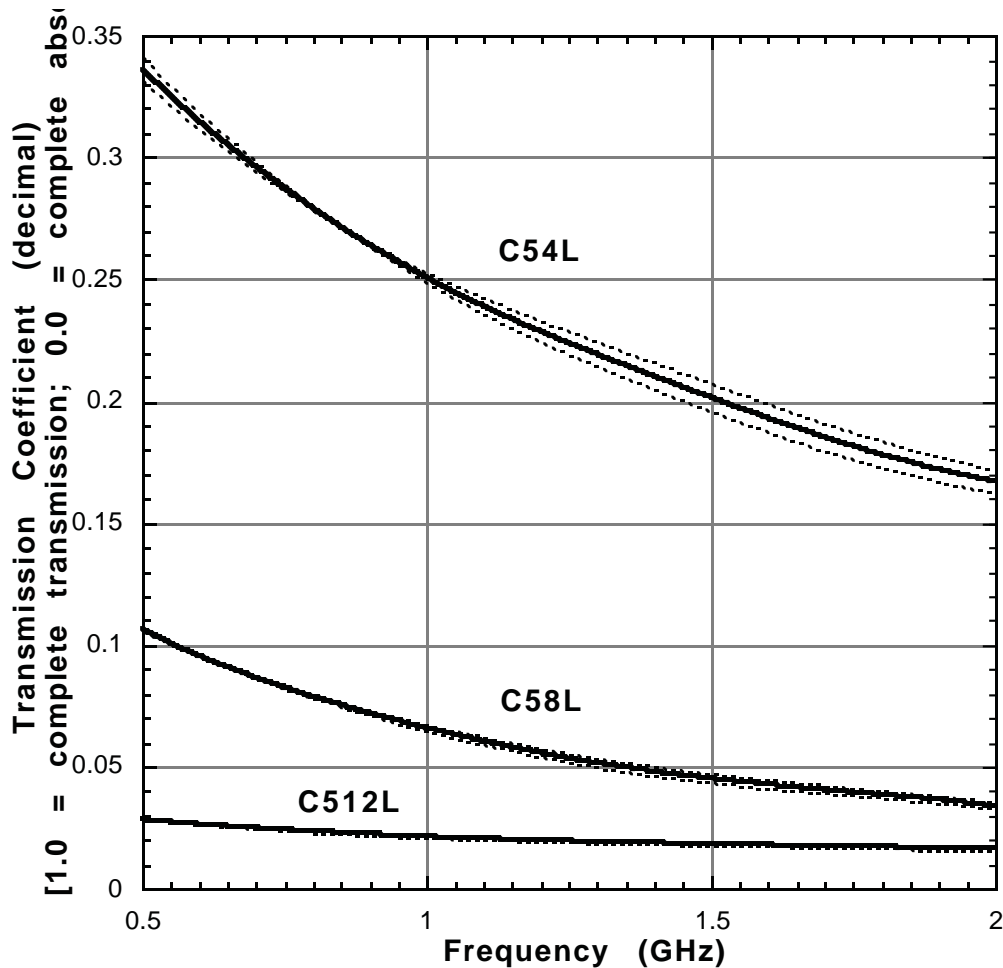

Table 4.8b: Regression Coefficients (dB) for Concrete Type 5 Transmission versus Frequency Curves Plotted in Figure 4.8b. The regression equation is of the form
 Received Signal Magnitude (relative to free space)
 $= M_0 + M_1 * F + M_2 * F^2 + M_3 * F^3 + M_4 * F^4 + M_5 * F^5 + M_6 * F^6$, where F is the frequency in GHz.
 The correlation coefficient, R, is defined in the text.
 Data are for the Frequency Range 0.5 to 2.0 GHz.

Concrete Type 5 Attenuation Curves (0.5 to 2.0 GHz)									
Curve Identification									
Coefficient	C54L dB	C54L + sigma dB	C54L - sigma dB	C58L dB	C58L + sigma dB	C58L - sigma dB	C512L dB	C512L + sigma dB	C512L - sigma dB
M0	-8.4885E+00	-1.2991E+01	-3.9371E+00	-8.7038E+00	-5.9012E+00	-1.1467E+01	-2.6881E+01	-2.5534E+01	-2.8230E+01
M1	5.3858E+00	3.4842E+01	-2.4380E+01	-4.3026E+01	-5.7469E+01	-2.8820E+01	-8.2154E+00	-1.5160E+01	-1.3062E+00
M2	-2.5367E+01	-9.7866E+01	4.7841E+01	7.1051E+01	1.0023E+02	4.2400E+01	-3.1728E+00	1.1026E+01	-1.7184E+01
M3	2.7480E+01	1.1540E+02	-6.1213E+01	-7.3379E+01	-1.0335E+02	-4.3957E+01	1.1250E+01	-2.6635E+00	2.4828E+01
M4	-1.3966E+01	-7.0040E+01	4.2528E+01	3.9785E+01	5.6979E+01	2.2852E+01	-9.1801E+00	-1.8221E+00	-1.6281E+01
M5	3.1592E+00	2.1256E+01	-1.5050E+01	-1.0269E+01	-1.5525E+01	-5.0627E+00	3.3985E+00	1.3616E+00	5.3449E+00
M6	-2.1594E-01	-2.5516E+00	2.1314E+00	9.4236E-01	1.6064E+00	2.7995E-01	-4.9309E-01	-2.6006E-01	-7.1403E-01
M7									
M8									
M9									
R	1	1	0.99998	1	1	1	1	1	1

Figure 4.8b: Received Signal Magnitude (dB) for Concrete Type 5 Walls (relative to free space). Nominal thicknesses:
 C54L = 102 mm; C58L = 203 mm; C512L = 305 mm
 Dotted Curves represent +/- 1 standard deviation from mean (Solid Curves).
 Low Range Data: 0.5 to 2.0 GHz

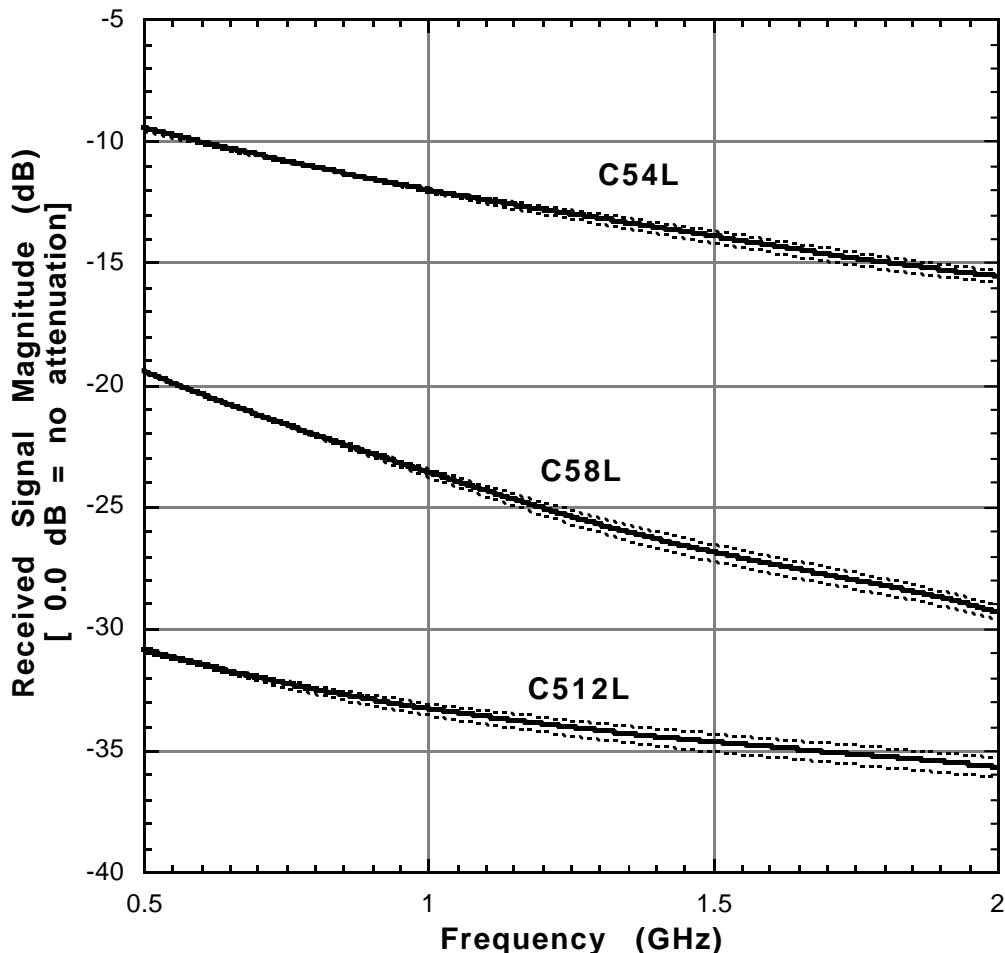

Table 4.8c: Regression Coefficients (decimal) for Concrete Type 5 Transmission versus Frequency Curves Plotted in Figure 4.8c. The regression equation is of the form $\text{Transmission Coefficient} = M_0 + M_1 * F + M_2 * F^2 + M_3 * F^3 + M_4 * F^4 + M_5 * F^5 + M_6 * F^6$ etc. where F is the frequency in GHz. The correlation coefficient, R, is defined in the text. Data are for the Frequency Range 3.0 to 8.0 GHz.

Concrete Type 5 Attenuation Curves (3.0 to 8.0 GHz)									
Coefficient	Curve Identification								
	C54H Decimal	C54H + sigma Decimal	C54H - sigma Decimal	C58H Decimal	C58H + sigma Decimal	C58H - sigma Decimal	C512H Decimal	C512H + sigma Decimal	C512H - sigma Decimal
M0	-4.4403E-02	-3.8098E-02	-5.0708E-02	2.4582E-03	1.1059E-03	3.8109E-03	-4.1218E-03	-1.3105E-02	4.8745E-03
M1	1.1728E-01	1.1081E-01	1.2376E-01	1.0306E-03	2.8488E-03	-7.8799E-04	6.9668E-03	2.0637E-02	-6.7223E-03
M2	-5.8217E-02	-5.4325E-02	-6.2108E-02	-4.4871E-04	-1.4143E-03	5.1705E-04	-4.4705E-03	-1.3087E-02	4.1568E-03
M3	1.6836E-02	1.5719E-02	1.7954E-02	1.1484E-04	3.8258E-04	-1.5296E-04	1.5075E-03	4.3593E-03	-1.3474E-03
M4	-2.7470E-03	-2.5578E-03	-2.9362E-03	-2.2079E-05	-6.2953E-05	1.8803E-05	-2.6831E-04	-7.6509E-04	2.2886E-04
M5	2.2613E-04	2.0834E-04	2.4394E-04	1.9853E-06	5.2359E-06	-1.2658E-06	1.5788E-05	4.5334E-05	-1.3736E-05
M6	-7.2667E-06	-6.5886E-06	-7.9449E-06	-5.6896E-08	-1.6192E-07	4.8142E-08	2.8865E-06	7.5716E-06	-1.8130E-06
M7							-6.53E-07	-1.71E-06	4.02E-07
M8							5.1018E-08	1.3067E-07	-2.8764E-08
M9							-1.4875E-09	-3.7223E-09	7.5060E-10
R	1	1	1	1	1	1	1.00000	0.99999	1.00000

Figure 4.8c: Transmission Coefficients for Concrete Type 5 walls (relative to free space). Nominal thicknesses: C54H = 102 mm; C58H = 203 mm; C512H = 305 mm. Dotted Curves represent +/- 1 standard deviation from mean (Solid Curves). High Range Data: 3.0 to 8.0 GHz

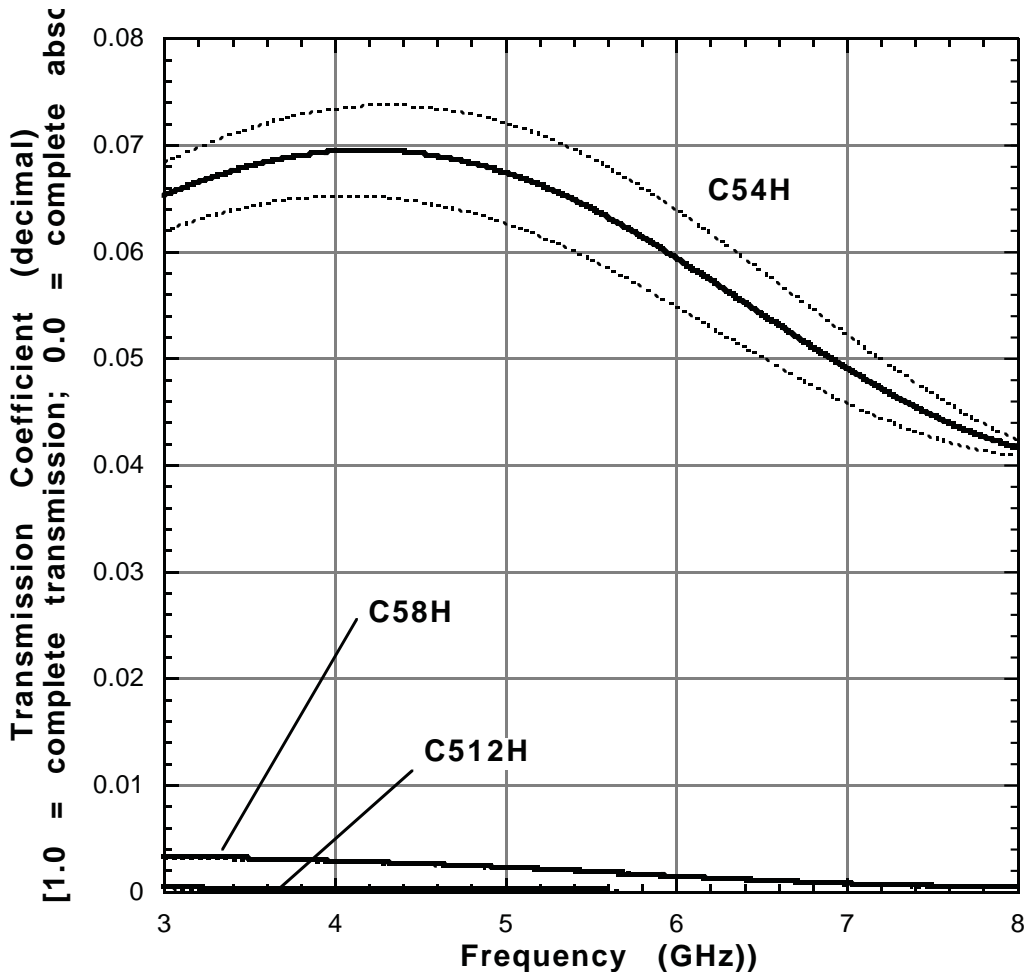
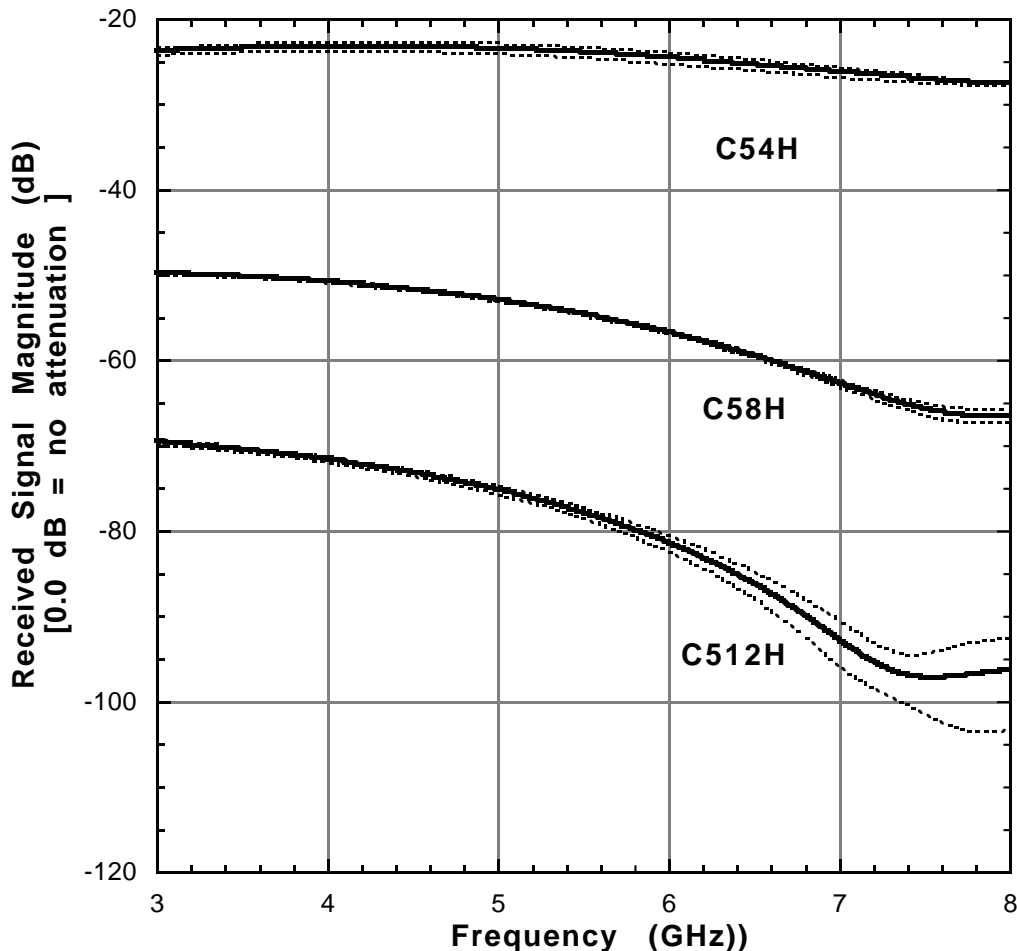

Table 4.8d: Regression Coefficients (dB) for Concrete Type 5 Transmission versus Frequency Curves Plotted in Figure 4.8d. The regression equation is of the form
 Received Signal Magnitude (relative to free space)
 $= M_0 + M_1 * F + M_2 * F^2 + M_3 * F^3 + M_4 * F^4 + M_5 * F^5 + M_6 * F^6$, where F is the frequency in GHz.
 The correlation coefficient, R, is defined in the text.
 Data are for the Frequency Range 3.0 to 8.0 GHz.

Concrete Type 5 Attenuation Curves (3.0 to 8.0 GHz)									
Curve Identification									
Coefficient	C54H	C54H + sigma	C54H - sigma	C58H	C58H + sigma	C58H - sigma	C512H	C512H + sigma	C512H - sigma
	dB	dB	dB	dB	dB	dB	dB	dB	dB
M0	-4.1911E+01	-3.5645E+01	-4.9467E+01	1.1496E+02	6.4431E+01	1.7367E+02	-6.0914E+03	-7.7427E+03	-2.0996E+03
M1	1.8910E+01	1.1238E+01	2.8272E+01	-2.1550E+02	-1.5134E+02	-2.8989E+02	9.1683E+03	1.1667E+04	3.1137E+03
M2	-8.6628E+00	-4.6207E+00	-1.3622E+01	1.1590E+02	8.2718E+01	1.5430E+02	-5.7783E+03	-7.3532E+03	-1.9552E+03
M3	2.2415E+00	1.1366E+00	3.6065E+00	-3.2698E+01	-2.3735E+01	-4.3049E+01	1.9016E+03	2.4275E+03	6.2435E+02
M4	-3.2569E-01	-1.5905E-01	-5.3311E-01	5.0993E+00	3.7660E+00	6.6358E+00	-3.2278E+02	-4.1767E+02	-9.3311E+01
M5	2.3791E-02	1.0721E-02	4.0201E-02	-4.1851E-01	-3.1495E-01	-5.3756E-01	1.5518E+01	2.2496E+01	-7.5398E-01
M6	-6.7060E-04	-2.5843E-04	-1.1936E-03	1.4090E-02	1.0812E-02	1.7849E-02	4.1007E+00	4.6249E+00	2.6407E+00
M7							-8.26E-01	-9.79E-01	-4.29E-01
M8							6.1433E-02	7.3466E-02	3.0297E-02
M9							-1.7190E-03	-2.0609E-03	-8.3300E-04
R	1	1	1	0.99999	0.99999	0.99999	0.99992	0.99976	0.99993

Figure 4.8d: Received Signal Magnitude (dB) for Concrete Type 5 Walls (relative to free space). Nominal thicknesses:
 C54H = 102 mm; C58H = 203 mm; C512H = 305 mm
 Dotted Curves represent +/- 1 standard deviation from mean (Solid Curves).
 High Range Data: 3.0 to 8.0 GHz



BLANK PAGE

4.9 Plain Concrete: Batch 6 Mix

The following four tables (4.9a through 4.9d) present the frequency response spectrum for a plain concrete wall. The specimens in this series bear the designation C6XXL and C6XXH, where the “XX” defines the specimen thickness in inches, and the L and H denote “low” (0.5 to 2.0 GHz) and “high” (3.0 to 8.0 GHz) frequency bandwidths.

The Batch 6 concrete specimens had an approximate water cement ratio of 0.54, a slump of 172 mm (“high”), a nominal

maximum crushed aggregate size of 25.4 mm (“large”), a cement content (by weight) of 19%, and an average density of 2.39 g/cc.

Figures 4.9a and 4.9b cover the band from 0.5 to 2.0 GHz, while Figures 4.9c and 4.9d are for the range 3.0 to 8.0 GHz. The ordinate values represent the ratio of the received to transmitted signal. The decimal attenuation values are presented first, followed by the same ordinate set converted to decibels.

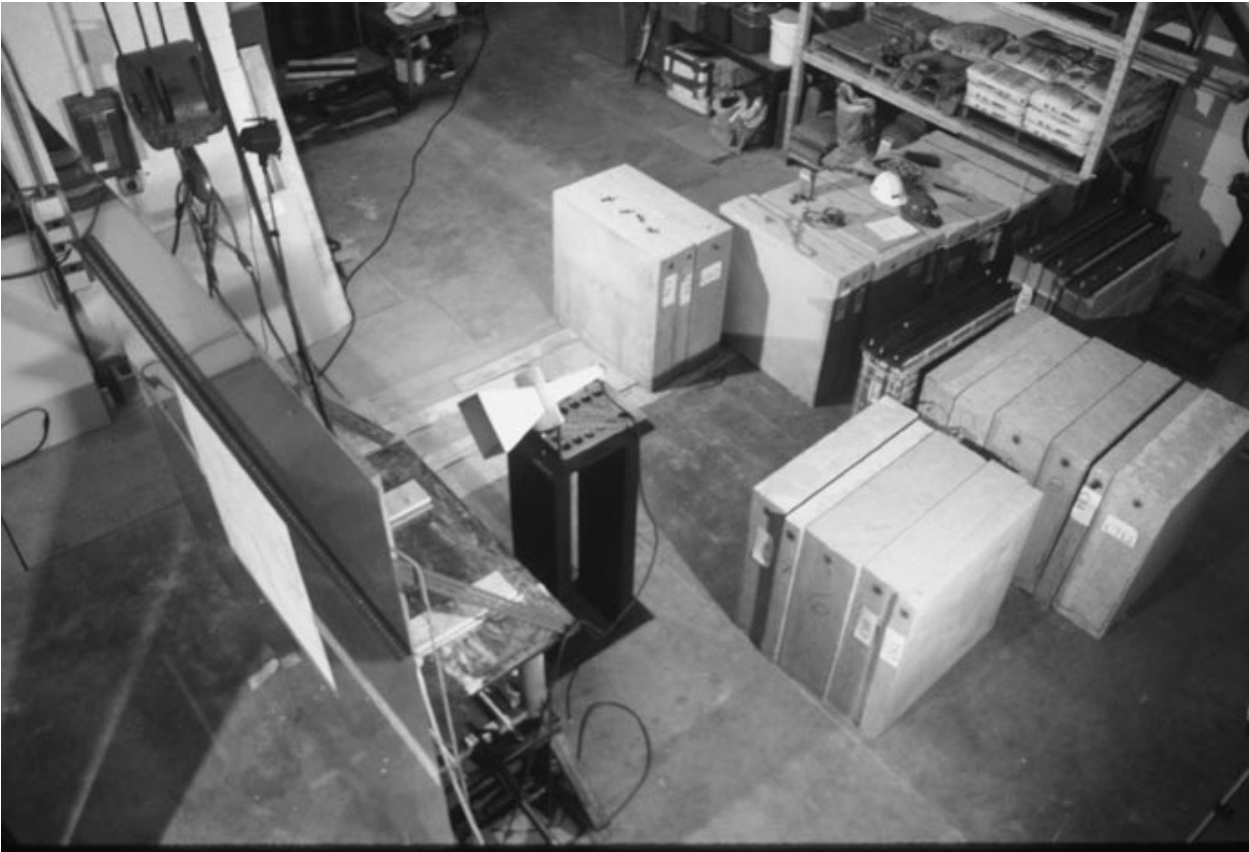

Figure 4.9: Test setup for specimen C612H (305 mm thick plain concrete wall) for frequency response determination from 3.0 to 8.0 GHz.

Table 4.9a: Regression Coefficients (decimal) for Concrete Type 6 Transmission versus Frequency Curves Plotted in Figure 4.9a. The regression equation is of the form $\text{Transmission Coefficient} = M_0 + M_1 * F + M_2 * F^2 + M_3 * F^3 + M_4 * F^4 + M_5 * F^5 + M_6 * F^6$ etc. where F is the frequency in GHz. The correlation coefficient, R, is defined in the text. Data are for the Frequency Range 0.5 to 2.0 GHz.

Concrete Type 6 Attenuation Curves (0.5 to 2.0 GHz)									
Coefficient	Curve Identification								
	C64L Decimal	C64L + sigma Decimal	C64L - sigma Decimal	C68L Decimal	C68L + sigma Decimal	C68L - sigma Decimal	C612L Decimal	C612L + sigma Decimal	C612L - sigma Decimal
M0	3.9821E-01	4.3714E-01	3.5928E-01	1.8358E-01	1.9656E-01	1.7060E-01	2.7250E-02	2.6570E-02	2.6570E-02
M1	-2.9347E-01	-4.7552E-01	-1.1142E-01	-4.6695E-01	-5.3441E-01	-3.9950E-01	-4.7470E-02	-4.6196E-02	-4.6196E-02
M2	1.6115E-01	4.9084E-01	-1.6853E-01	7.6959E-01	9.0750E-01	6.3168E-01	4.8906E-02	5.4399E-02	5.4399E-02
M3	-1.7899E-01	-4.6785E-01	1.0986E-01	-7.8972E-01	-9.2990E-01	-6.4954E-01	-1.0070E-02	-2.1841E-02	-2.1841E-02
M4	1.7735E-01	3.0783E-01	4.6876E-02	4.6501E-01	5.4203E-01	3.8799E-01	-1.3669E-02	-4.4065E-03	-4.4065E-03
M5	-8.1433E-02	-1.1023E-01	-5.2640E-02	-1.4187E-01	-1.6398E-01	-1.1975E-01	8.9116E-03	5.5819E-03	5.5819E-03
M6	1.3624E-02	1.6000E-02	1.1248E-02	1.7302E-02	1.9920E-02	1.4685E-02	-1.5817E-03	-1.1241E-03	-1.1241E-03
M7									
M8									
M9									
R	1	1	1	1	1	1	0.99989	0.99987	0.99987

Figure 4.9a: Transmission Coefficients for Concrete Type 6 walls (relative to free space). Nominal thicknesses: C64L = 102 mm; C68L = 203 mm; C612L = 305 mm. Dotted Curves represent +/- 1 standard deviation from mean (Solid Curves). Low Range Data: 0.5 to 2.0 GHz

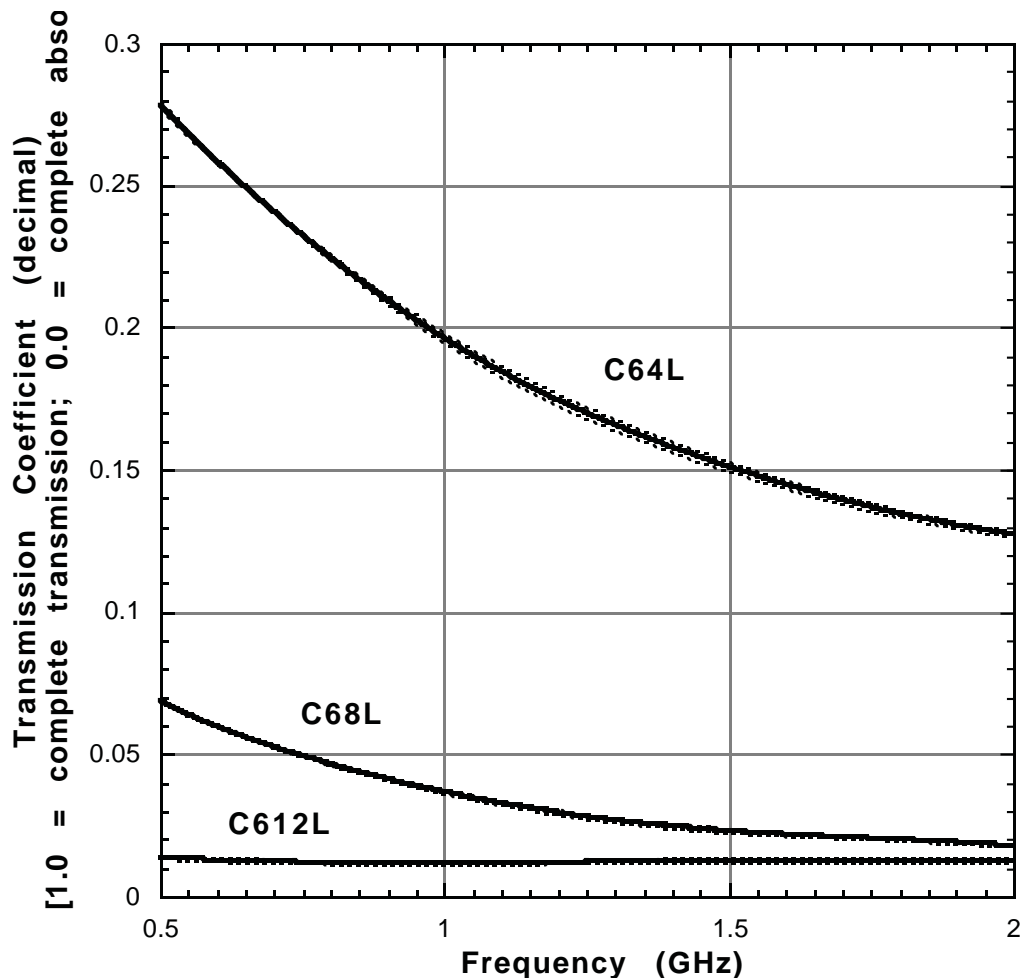

Table 4.9b: Regression Coefficients (dB) for Concrete Type 6 Transmission versus Frequency Curves Plotted in Figure 4.9b. The regression equation is of the form
 Received Signal Magnitude (relative to free space)
 $= M0+M1*F+M2*F^2+M3*F^3+M4*F^4+M5*F^5+M6*F^6$, where F is the frequency in GHz.
 The correlation coefficient, R, is defined in the text.
 Data are for the Frequency Range 0.5 to 2.0 GHz.

Concrete Type 6 Attenuation Curves (0.5 to 2.0 GHz)									
Curve Identification									
Coefficient	C64L dB	C64L + sigma dB	C64L - sigma dB	C68L dB	C68L + sigma dB	C68L - sigma dB	C612L dB	C612L + sigma dB	C612L - sigma dB
M0	-7.7569E+00	-6.8515E+00	-8.6497E+00	-7.0894E+00	-6.3369E+00	-7.7260E+00	-2.9707E+01	-2.9851E+01	-2.9729E+01
M1	-8.6884E+00	-1.2284E+01	-5.1857E+00	-7.0842E+01	-7.3736E+01	-6.8661E+01	-2.3157E+01	-2.4779E+01	-2.0341E+01
M2	9.2704E+00	1.4052E+01	4.7506E+00	1.3152E+02	1.3493E+02	1.2982E+02	1.3420E+01	2.3814E+01	-1.3491E-01
M3	-1.6696E+01	-1.8498E+01	-1.5250E+01	-1.4570E+02	-1.4621E+02	-1.4721E+02	1.5231E+01	-1.2079E+00	3.5559E+01
M4	1.4858E+01	1.4043E+01	1.5921E+01	8.5023E+01	8.4038E+01	8.7252E+01	-2.2619E+01	-1.0777E+01	-3.6939E+01
M5	-6.0590E+00	-5.3103E+00	-6.8932E+00	-2.4165E+01	-2.3700E+01	-2.5008E+01	1.0211E+01	6.1139E+00	1.5106E+01
M6	9.3595E-01	7.9103E-01	1.0924E+00	2.5986E+00	2.5447E+00	2.6974E+00	-1.5993E+00	-1.0465E+00	-2.2546E+00
M7									
M8									
M9									
R	1	1	1	1	1	1	0.99981	0.99979	0.99982

Figure 4.9b: Received Signal Magnitude (dB) for Concrete Type 6 Walls (relative to free space). Nominal thicknesses:
 C64L = 102 mm; C68L = 203 mm; C612L = 305 mm
 Dotted Curves represent +/- 1 standard deviation from mean (Solid Curves).
 Low Range Data: 0.5 to 2.0 GHz

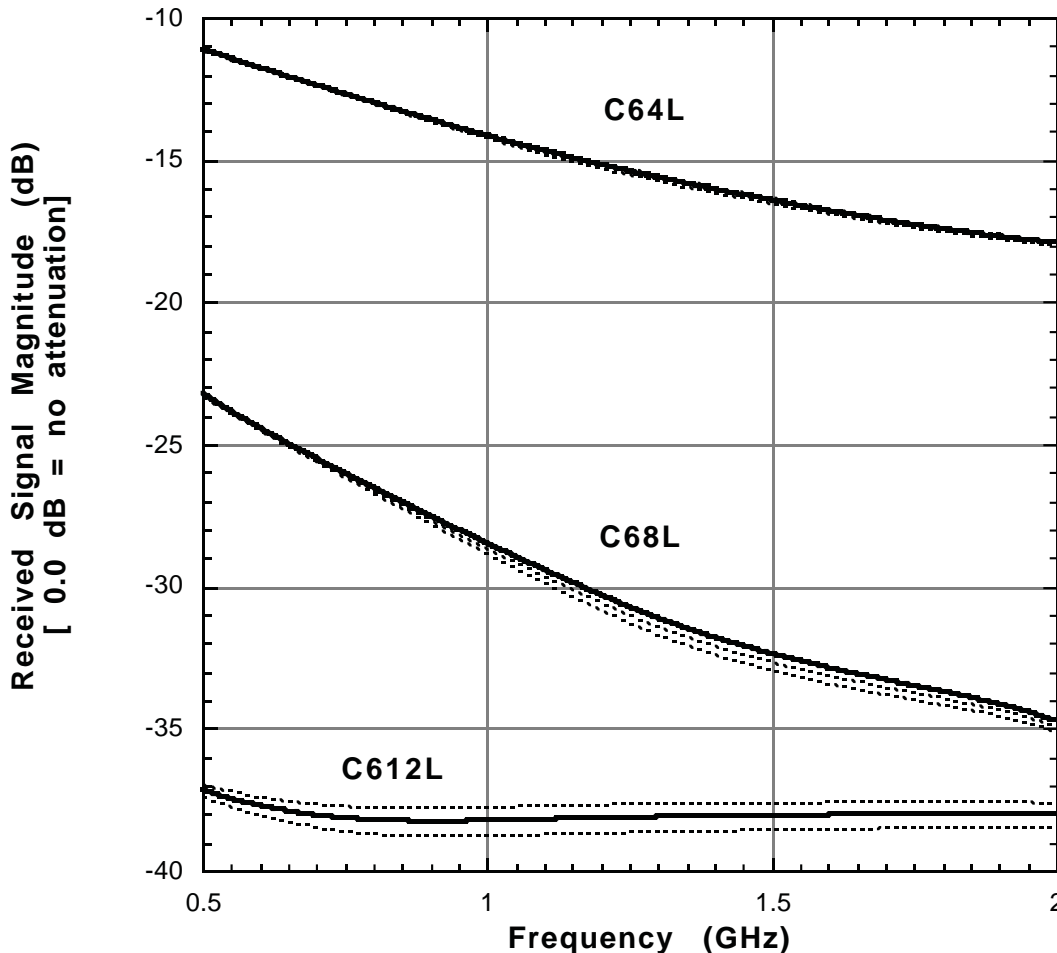

Table 4.9c: Regression Coefficients (decimal) for Concrete Type 6 Transmission versus Frequency Curves Plotted in Figure 4.9c. The regression equation is of the form $\text{Transmission Coefficient} = M_0 + M_1 \cdot F + M_2 \cdot F^2 + M_3 \cdot F^3 + M_4 \cdot F^4 + M_5 \cdot F^5 + M_6 \cdot F^6$ etc. where F is the frequency in GHz. The correlation coefficient, R, is defined in the text. Data are for the Frequency Range 3.0 to 8.0 GHz.

Concrete Type 6 Attenuation Curves (3.0 to 8.0 GHz)									
Curve Identification									
Coefficient	C64H	C64H + sigma	C64H - sigma	C68H	C68H + sigma	C68H - sigma	C612H	C612H + sigma	C612H - sigma
	Decimal	Decimal	Decimal	Decimal	Decimal	Decimal	Decimal	Decimal	Decimal
M0	-2.2557E-02	-2.3815E-02	-2.1299E-02	1.9586E+00	2.0215E+00	1.8958E+00	3.6336E-03	2.8635E-03	4.4061E-03
M1	8.2637E-02	8.5391E-02	7.9883E-02	-2.7092E+00	-2.8033E+00	-2.6151E+00	-3.1840E-03	-1.6616E-03	-4.7101E-03
M2	-4.1607E-02	-4.3128E-02	-4.0085E-02	1.5367E+00	1.5949E+00	1.4785E+00	9.5514E-04	-2.2760E-04	2.1402E-03
M3	1.2265E-02	1.2723E-02	1.1807E-02	-4.3715E-01	-4.5587E-01	-4.1843E-01	5.1962E-05	5.2865E-04	-4.2556E-04
M4	-2.0195E-03	-2.0947E-03	-1.9443E-03	5.3100E-02	5.6211E-02	4.9990E-02	-1.0931E-04	-2.1602E-04	-2.4087E-06
M5	1.6621E-04	1.7251E-04	1.5990E-04	3.4999E-03	3.3444E-03	3.6554E-03	3.1704E-05	4.4085E-05	1.9298E-05
M6	-5.3164E-06	-5.5282E-06	-5.1046E-06	-2.1168E-03	-2.1505E-03	-2.0831E-03	-4.6618E-06	-5.0312E-06	-4.2902E-06
M7				0.00030063	0.00030735	0.00029392	3.87E-07	3.12E-07	4.62E-07
M8				-1.9803E-05	-2.0283E-05	-1.9322E-05	-1.7315E-08	-8.7165E-09	-2.5909E-08
M9				5.1908E-07	5.3198E-07	5.0617E-07	3.2738E-10	4.5872E-11	6.0882E-10
R	1	1	1	0.99973	0.99974	0.99971	1.00000	1.00000	1.00000

Figure 4.9c: Transmission Coefficients for Concrete Type 6 walls (relative to free space). Nominal thicknesses: C64H = 102 mm; C68H = 203 mm; C612H = 305 mm. Dotted Curves represent +/- 1 standard deviation from mean (Solid Curves). High Range Data: 3.0 to 8.0 GHz

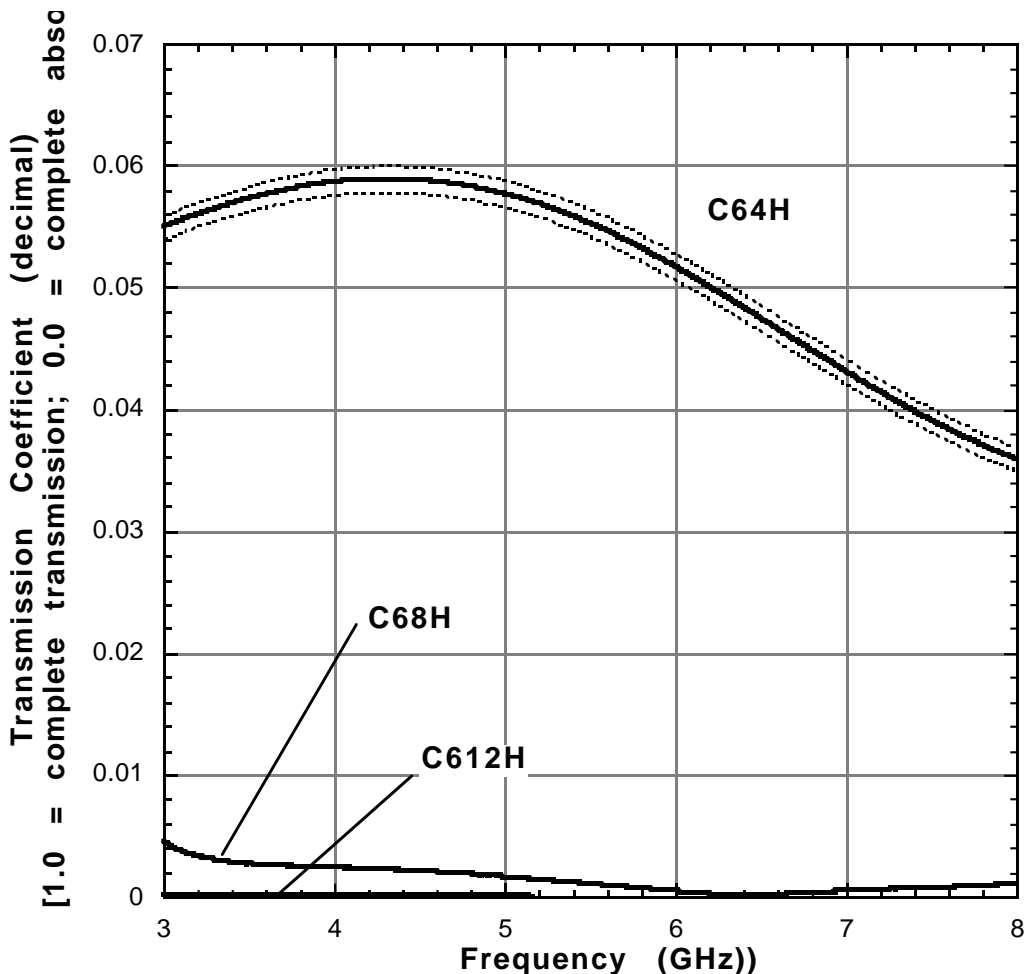
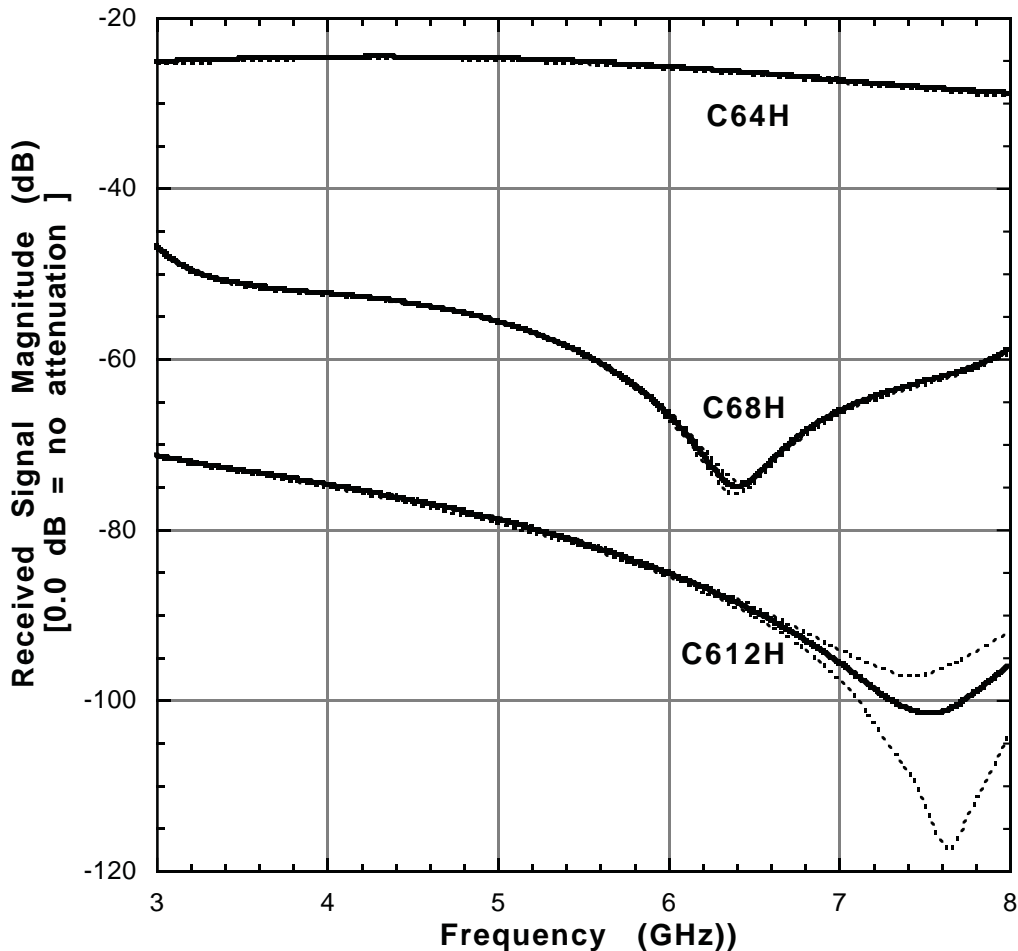

Table 4.9d: Regression Coefficients (dB) for Concrete Type 6 Transmission versus Frequency Curves Plotted in Figure 4.9d. The regression equation is of the form
 Received Signal Magnitude (relative to free space)
 $= M0+M1*F+M2*F^2+M3*F^3+M4*F^4+M5*F^5+M6*F^6$, where F is the frequency in GHz.
 The correlation coefficient, R, is defined in the text.
 Data are for the Frequency Range 3.0 to 8.0 GHz.

Concrete Type 6 Attenuation Curves (3.0 to 8.0 GHz)									
Curve Identification									
Coefficient	C64H dB	C64H + sigma dB	C64H - sigma dB	C68H dB	C68H + sigma dB	C68H - sigma dB	C612H dB	C612H + sigma dB	C612H - sigma dB
M0	-3.8240E+01	-3.8513E+01	-3.7938E+01	3.2287E+04	3.1552E+04	3.3151E+04	-4.9613E+03	-5.1764E+03	8.6949E+03
M1	1.2897E+01	1.3478E+01	1.2273E+01	-4.8428E+04	-4.7309E+04	-4.9743E+04	7.4199E+03	7.8117E+03	-1.3554E+04
M2	-5.7874E+00	-6.1148E+00	-5.4368E+00	2.9825E+04	2.9135E+04	3.0636E+04	-4.6776E+03	-4.9546E+03	8.6321E+03
M3	1.5144E+00	1.6104E+00	1.4118E+00	-9.4197E+03	-9.2105E+03	-9.6660E+03	1.5594E+03	1.6507E+03	-2.8239E+03
M4	-2.2331E-01	-2.3875E-01	-2.0683E-01	1.4365E+03	1.4111E+03	1.4668E+03	-2.8065E+02	-2.9016E+02	4.4645E+02
M5	1.6335E-02	1.7635E-02	1.4950E-02	-1.4530E+01	-1.7287E+01	-1.1489E+01	2.0702E+01	1.7790E+01	-4.3765E+00
M6	-4.5554E-04	-5.0017E-04	-4.0803E-04	-3.2063E+01	-3.0658E+01	-3.3667E+01	1.4598E+00	2.6332E+00	-1.0919E+01
M7				5.3331	5.1294	5.5667	-4.28E-01	-6.05E-01	1.90E+00
M8				-3.7462E-01	-3.6076E-01	-3.9053E-01	3.3111E-02	4.6078E-02	-1.3981E-01
M9				1.0186E-02	9.8107E-03	1.0616E-02	-9.1484E-04	-1.2954E-03	3.9995E-03
R	1	1	1	0.99259	0.99306	0.99189	0.99977	0.99985	0.99878

Figure 4.9d: Received Signal Magnitude (dB) for Concrete Type 6 Walls (relative to free space). Nominal thicknesses:
 C64H = 102 mm; C68H = 203 mm; C612H = 305 mm
 Dotted Curves represent +/- 1 standard deviation from mean (Solid Curves).
 High Range Data: 3.0 to 8.0 GHz



BLANK PAGE

4.10 Plain Concrete: Batch 7 Mix

The following four tables (4.10a through 4.10d) present the frequency response spectrum for a plain concrete wall. The specimens in this series bear the designation C7XXL and C7XXH, where the “XX” defines the specimen thickness in inches, and the L and H denote “low” (0.5 to 2.0 GHz) and “high” (3.0 to 8.0 GHz) frequency bandwidths.

The Batch 7 concrete specimens had an approximate water cement ratio of 0.87, a slump of 83 mm (“low”), a nominal

maximum crushed aggregate size of 25.4 mm (“large”), a cement content (by weight) of 12%, and an average density of 2.38 g/cc.

Figures 4.10a and 4.10b cover the band from 0.5 to 2.0 GHz, while Figures 4.10c and 4.10d are for the range 3.0 to 8.0 GHz. The ordinate values represent the ratio of the received to transmitted signal. The decimal attenuation values are presented first, followed by the same ordinate set converted to decibels.

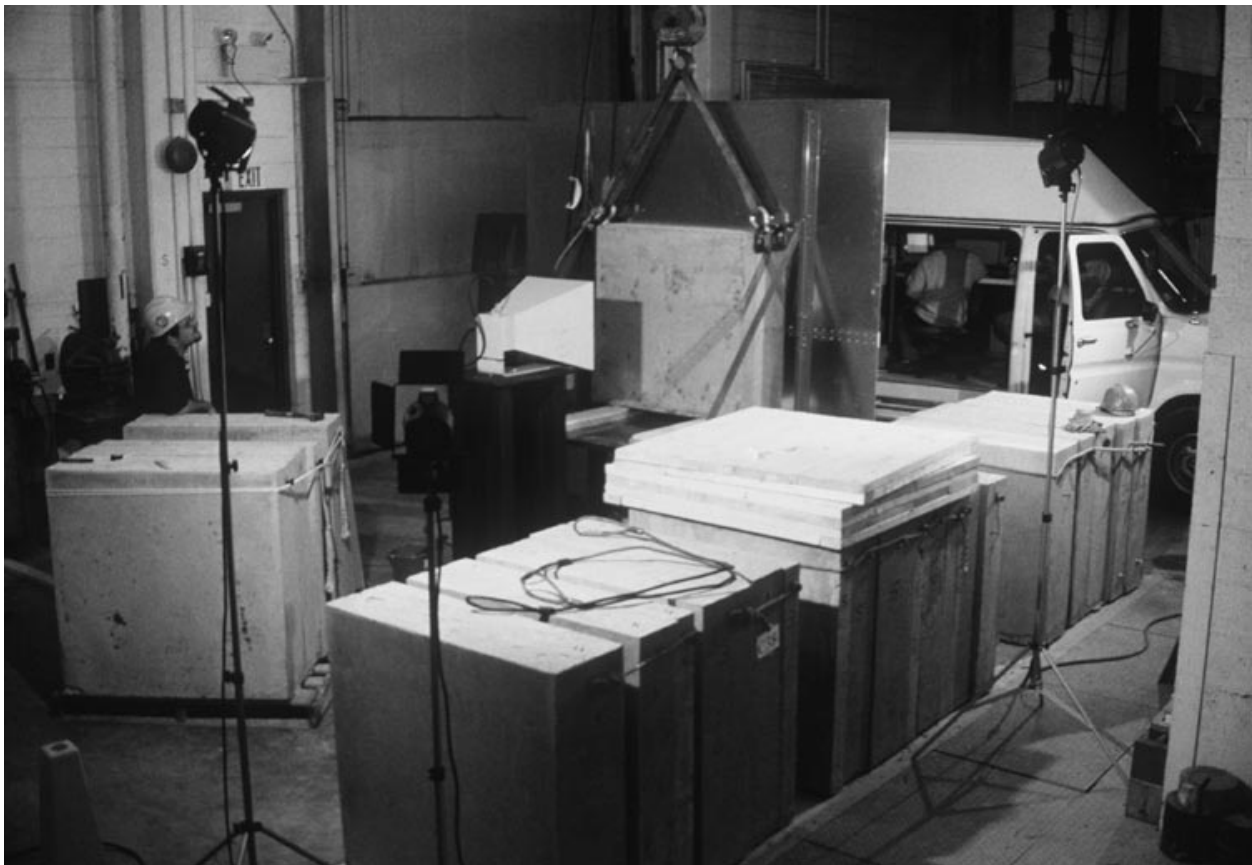

Figure 4.10: Concrete panel specimens lined up for low frequency (0.5 to 2.0 GHz) test series.

Table 4.10a: Regression Coefficients (decimal) for Concrete Type 7 Transmission versus Frequency Curves Plotted in Figure 4.10a. The regression equation is of the form $\text{Transmission Coefficient} = M_0 + M_1 * F + M_2 * F^2 + M_3 * F^3 + M_4 * F^4 + M_5 * F^5 + M_6 * F^6$ etc. where F is the frequency in GHz. The correlation coefficient, R, is defined in the text. Data are for the Frequency Range 0.5 to 2.0 GHz.

Concrete Type 7 Attenuation Curves (0.5 to 2.0 GHz)									
Coefficient	Curve Identification								
	C74L Decimal	C74L + sigma Decimal	C74L - sigma Decimal	C78L Decimal	C78L + sigma Decimal	C78L - sigma Decimal	C712L Decimal	C712L + sigma Decimal	C712L - sigma Decimal
M0	4.5326E-01	4.8295E-01	4.2358E-01	2.7709E-01	2.6557E-01	2.8862E-01	3.6287E-02	4.3184E-02	2.9391E-02
M1	-1.4898E-02	-6.4268E-02	3.4466E-02	-6.2320E-01	-5.2515E-01	-7.2125E-01	-4.6302E-02	-7.8300E-02	-1.4304E-02
M2	-5.4759E-01	-6.7594E-01	-4.1923E-01	1.0189E+00	7.5004E-01	1.2878E+00	3.9930E-02	9.9612E-02	-1.9752E-02
M3	6.3929E-01	1.0229E+00	2.5571E-01	-1.0418E+00	-6.9658E-01	-1.3871E+00	-5.7698E-03	-6.2051E-02	5.0511E-02
M4	-2.9246E-01	-6.4098E-01	5.6068E-02	6.0347E-01	3.7611E-01	8.3083E-01	-1.2483E-02	1.6532E-02	-4.1497E-02
M5	5.1100E-02	1.8731E-01	-8.5107E-02	-1.8029E-01	-1.0572E-01	-2.5487E-01	7.7221E-03	-1.0735E-04	1.5551E-02
M6	-1.0912E-03	-2.0858E-02	1.8675E-02	2.1529E-02	1.1849E-02	3.1210E-02	-1.3804E-03	-5.1387E-04	-2.2468E-03
M7									
M8									
M9									
R	0.99999	1	0.99998	1	1	1	0.99999	0.99999	0.99999

Figure 4.10a: Transmission Coefficients for Concrete Type 7 walls (relative to free space). Nominal thicknesses: C74L = 102 mm; C78L = 203 mm; C712L = 305 mm. Dotted Curves represent +/- 1 standard deviation from mean (Solid Curves). Low Range Data: 0.5 to 2.0 GHz

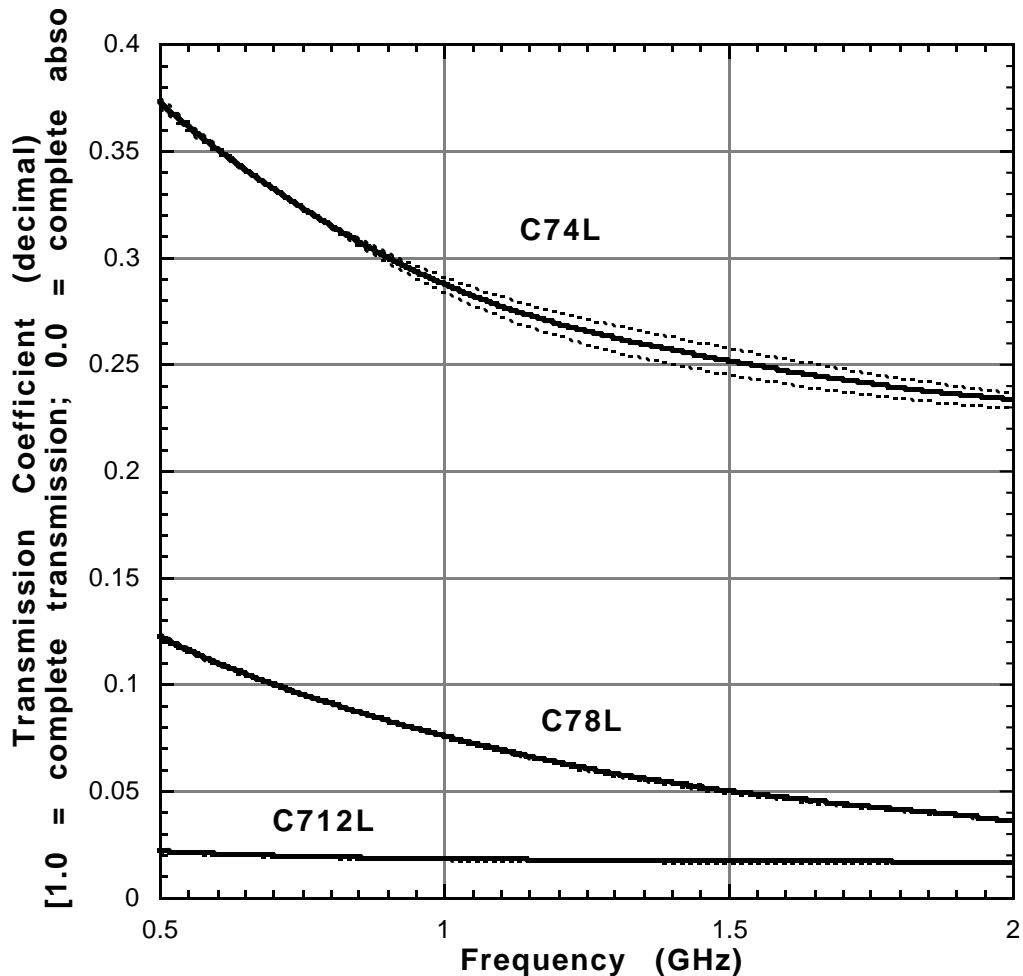

Table 4.10b: Regression Coefficients (dB) for Concrete Type 7 Transmission versus Frequency Curves Plotted in Figure 4.10b. The regression equation is of the form
 Received Signal Magnitude (relative to free space)
 $= M_0 + M_1 * F + M_2 * F^2 + M_3 * F^3 + M_4 * F^4 + M_5 * F^5 + M_6 * F^6$, where F is the frequency in GHz.
 The correlation coefficient, R, is defined in the text.
 Data are for the Frequency Range 0.5 to 2.0 GHz.

Concrete Type 7 Attenuation Curves (0.5 to 2.0 GHz)									
Curve Identification									
Coefficient	C74L	C74L + sigma	C74L - sigma	C78L	C78L + sigma	C78L - sigma	C712L	C712L + sigma	C712L - sigma
	dB	dB	dB	dB	dB	dB	dB	dB	dB
M0	-7.4920E+00	-7.3807E+00	-7.5248E+00	-7.4629E+00	-9.3763E+00	-5.5346E+00	-2.8743E+01	-2.6123E+01	-3.1397E+01
M1	3.0412E+00	5.6047E+00	-6.6853E-03	-4.3735E+01	-3.0714E+01	-5.6858E+01	-1.0652E+01	-2.2614E+01	1.4297E+00
M2	-1.6580E+01	-2.8827E+01	-3.1769E+00	7.3574E+01	4.1529E+01	1.0585E+02	-1.9754E+00	1.9804E+01	-2.3898E+01
M3	1.4213E+01	3.4562E+01	-7.4952E+00	-7.6654E+01	-3.8504E+01	-1.1504E+02	1.7784E+01	-2.0407E+00	3.7663E+01
M4	-3.8593E+00	-1.9288E+01	1.2400E+01	4.1785E+01	1.8246E+01	6.5431E+01	-1.7212E+01	-7.3755E+00	-2.7041E+01
M5	-3.9244E-01	5.1229E+00	-6.1611E+00	-1.0986E+01	-3.7229E+00	-1.8267E+01	6.9579E+00	4.4037E+00	9.5035E+00
M6	2.4525E-01	-5.1324E-01	1.0342E+00	1.0614E+00	1.7201E-01	1.9508E+00	-1.0525E+00	-7.8032E-01	-1.3233E+00
M7									
M8									
M9									
R	0.99999	1	0.99998	1	1	1	0.99999	0.99998	0.99999

Figure 4.10b: Received Signal Magnitude (dB) for Concrete Type 7 Walls (relative to free space). Nominal thicknesses:
 C74L = 102 mm; C78L = 203 mm; C712L = 305 mm
 Dotted Curves represent +/- 1 standard deviation from mean (Solid Curves).
 Low Range Data: 0.5 to 2.0 GHz

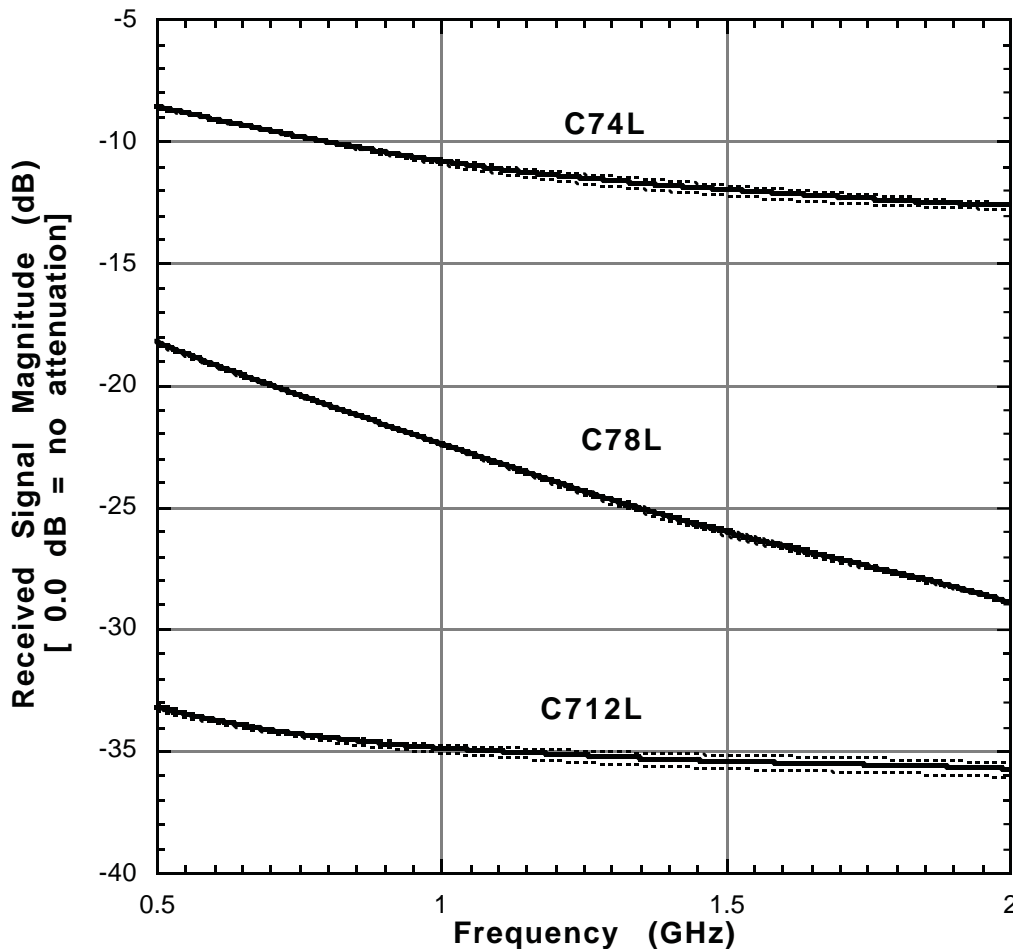

Table 4.10c: Regression Coefficients (decimal) for Concrete Type 7 Transmission versus Frequency Curves Plotted in Figure 4.10c. The regression equation is of the form $\text{Transmission Coefficient} = M_0 + M_1 * F + M_2 * F^2 + M_3 * F^3 + M_4 * F^4 + M_5 * F^5 + M_6 * F^6$ etc. where F is the frequency in GHz. The correlation coefficient, R, is defined in the text. Data are for the Frequency Range 3.0 to 8.0 GHz.

Concrete Type 7 Attenuation Curves (3.0 to 8.0 GHz)									
Curve Identification									
Coefficient	C74H	C74H + sigma	C74H - sigma	C78H	C78H + sigma	C78H - sigma	C712H	C712H + sigma	C712H - sigma
	Decimal	Decimal	Decimal	Decimal	Decimal	Decimal	Decimal	Decimal	Decimal
M0	9.7788E-03	2.7046E-03	1.6854E-02	7.0611E-03	6.4596E-03	7.6619E-03	-4.1998E-02	-4.5607E-02	-3.8387E-02
M1	1.4753E-01	1.5970E-01	1.3536E-01	7.0122E-03	8.3633E-03	5.6622E-03	9.4489E-02	1.0250E-01	8.6468E-02
M2	-7.1367E-02	-7.6871E-02	-6.5862E-02	-4.3674E-03	-5.0878E-03	-3.6476E-03	-7.7022E-02	-8.3429E-02	-7.0612E-02
M3	2.0328E-02	2.1769E-02	1.8888E-02	1.2982E-03	1.5007E-03	1.0959E-03	3.1878E-02	3.4449E-02	2.9307E-02
M4	-3.3935E-03	-3.6089E-03	-3.1782E-03	-2.2867E-04	-2.6107E-04	-1.9629E-04	-7.3206E-03	-7.8856E-03	-6.7554E-03
M5	2.8920E-04	3.0591E-04	2.7249E-04	2.0758E-05	2.3474E-05	1.8044E-05	8.9466E-04	9.5856E-04	8.3075E-04
M6	-9.6399E-06	-1.0163E-05	-9.1171E-06	-7.2743E-07	-8.1879E-07	-6.3611E-07	-3.8327E-05	-4.0152E-05	-3.6503E-05
M7							-3.27E-06	-3.64E-06	-2.90E-06
M8							4.4285E-07	4.8381E-07	4.0188E-07
M9							-1.4597E-08	-1.5889E-08	-1.3305E-08
R	1	1	1	1	1	1	0.99965	0.99960	0.99970

Figure 4.10c: Transmission Coefficients for Concrete Type 7 walls (relative to free space). Nominal thicknesses: C74H = 102 mm; C78H = 203 mm; C712H = 305 mm. Dotted Curves represent +/- 1 standard deviation from mean (Solid Curves). High Range Data: 3.0 to 8.0 GHz

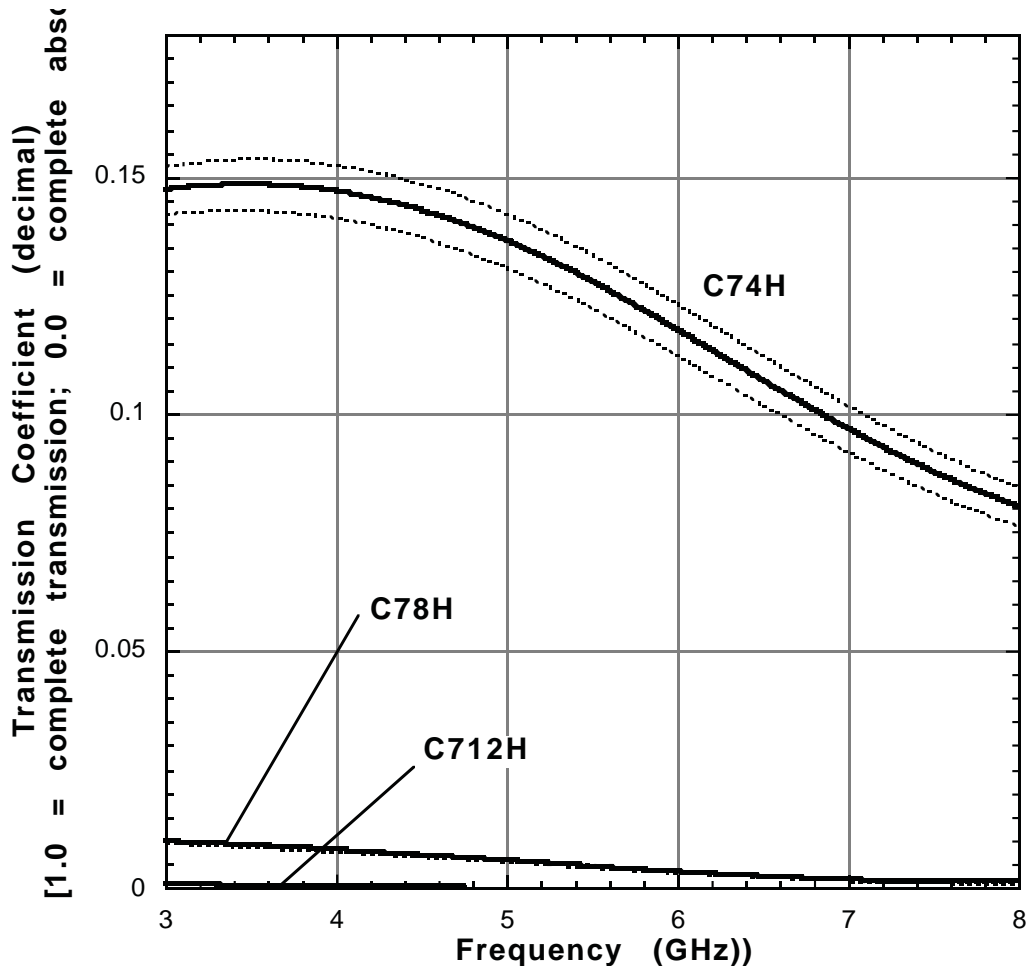
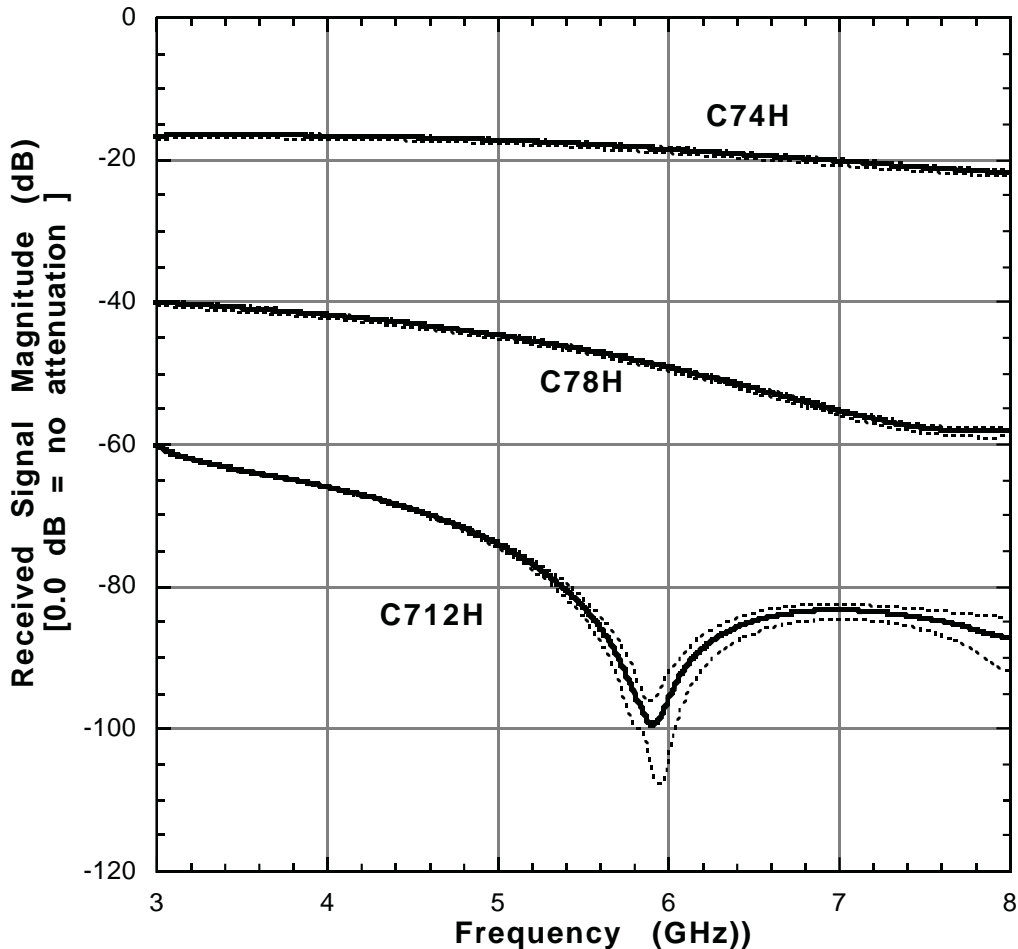

Table 4.10d: Regression Coefficients (dB) for Concrete Type 7 Transmission versus Frequency Curves Plotted in Figure 4.10d. The regression equation is of the form
 Received Signal Magnitude (relative to free space)
 $= M_0 + M_1 \cdot F + M_2 \cdot F^2 + M_3 \cdot F^3 + M_4 \cdot F^4 + M_5 \cdot F^5 + M_6 \cdot F^6$, where F is the frequency in GHz.
 The correlation coefficient, R, is defined in the text.
 Data are for the Frequency Range 3.0 to 8.0 GHz.

Concrete Type 7 Attenuation Curves (3.0 to 8.0 GHz)									
Curve Identification									
Coefficient	C74H	C74H + sigma	C74H - sigma	C78H	C78H + sigma	C78H - sigma	C712H	C712H + sigma	C712H - sigma
	dB	dB	dB	dB	dB	dB	dB	dB	dB
M0	-2.9468E+01	-2.9456E+01	-2.9479E+01	-6.8692E+02	-6.5468E+02	-7.2261E+02	-3.9381E+04	-3.4233E+04	-4.9443E+04
M1	1.4362E+01	1.4582E+01	1.4136E+01	9.8928E+02	9.4123E+02	1.0425E+03	5.7992E+04	5.0488E+04	7.2723E+04
M2	-6.8886E+00	-6.9653E+00	-6.8104E+00	-6.2581E+02	-5.9582E+02	-6.5898E+02	-3.5531E+04	-3.0963E+04	-4.4548E+04
M3	1.8272E+00	1.8438E+00	1.8102E+00	2.0706E+02	1.9723E+02	2.1794E+02	1.1535E+04	1.0044E+04	1.4500E+04
M4	-2.7445E-01	-2.7663E-01	-2.7221E-01	-3.5539E+01	-3.3833E+01	-3.7432E+01	-2.0438E+03	-1.7687E+03	-2.5960E+03
M5	2.0981E-02	2.1159E-02	2.0793E-02	1.8100E+00	1.7027E+00	1.9319E+00	1.5965E+02	1.3348E+02	2.1291E+02
M6	-6.3054E-04	-6.3763E-04	-6.2287E-04	4.3131E-01	4.1803E-01	4.4519E-01	6.0144E+00	6.5202E+00	4.9270E+00
M7				-0.089354	-0.086268	-0.092659	-2.29E+00	-2.16E+00	-2.57E+00
M8				6.7230E-03	6.4956E-03	6.9668E-03	1.7580E-01	1.6354E-01	2.0171E-01
M9				-1.8969E-04	-1.8358E-04	-1.9621E-04	-4.7007E-03	-4.3733E-03	-5.4137E-03
R	1	1	1	1	1	1	0.97877	0.98247	0.96779

Figure 4.10d: Received Signal Magnitude (dB) for Concrete Type 7 Walls (relative to free space). Nominal thicknesses:
 C74H = 102 mm; C78H = 203 mm; C712H = 305 mm
 Dotted Curves represent +/- 1 standard deviation from mean (Solid Curves).
 High Range Data: 3.0 to 8.0 GHz



BLANK PAGE

4.11 Plain Concrete: Batch 8 Mix

The following four tables (4.11a through 4.11d) present the frequency response spectrum for a plain concrete wall. The specimens in this series bear the designation C8XXL and C8XXH, where the “XX” defines the specimen thickness in inches, and the L and H denote “low” (0.5 to 2.0 GHz) and “high” (3.0 to 8.0 GHz) frequency bandwidths.

The Batch 8 concrete specimens had an approximate water cement ratio of 0.36, a slump of 165 mm (“high”), a nominal

maximum crushed aggregate size of 25.4 mm (“large”), a cement content (by weight) of 14%, and an average density of 2.38 g/cc.

Figures 4.11a and 4.11b cover the band from 0.5 to 2.0 GHz, while Figures 4.11c and 4.11d are for the range 3.0 to 8.0 GHz. The ordinate values represent the ratio of the received to transmitted signal. The decimal attenuation values are presented first, followed by the same ordinate set converted to decibels.

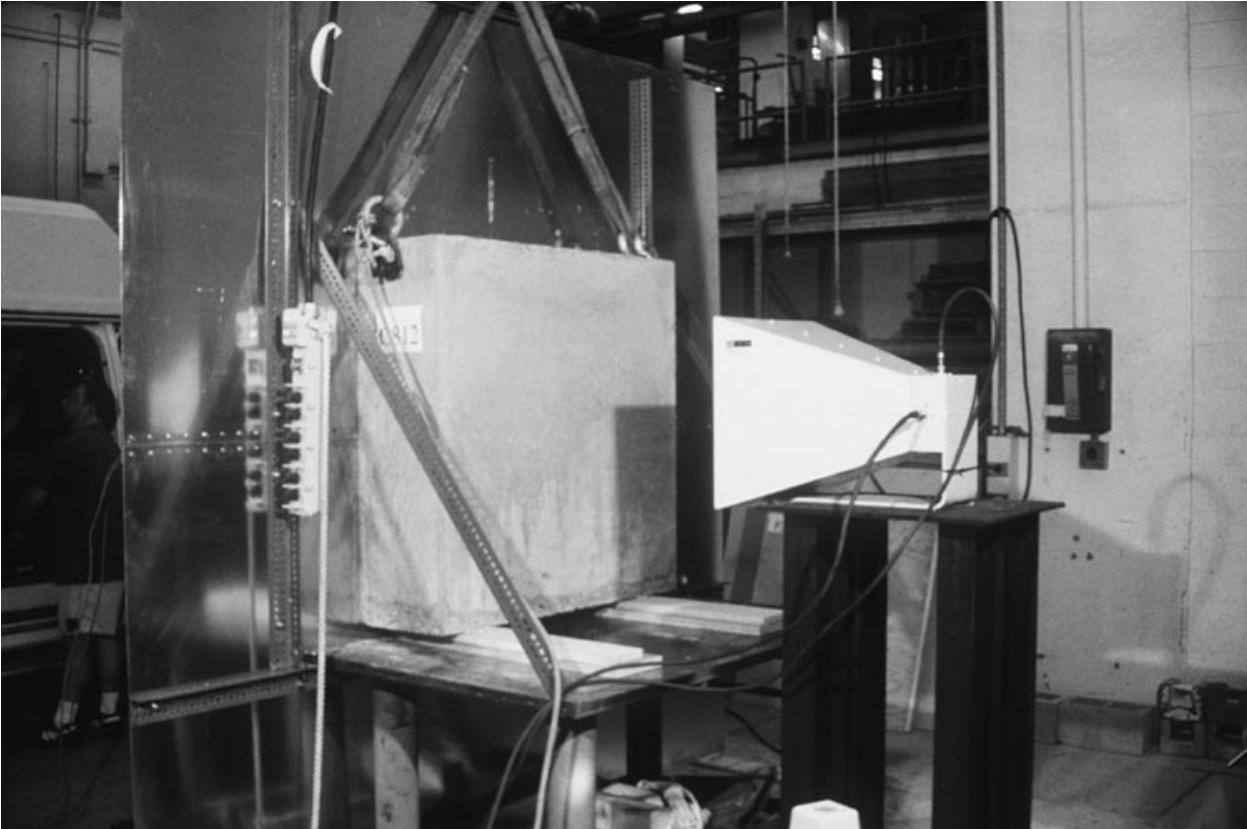

Figure 4.11: Test setup for specimen C812L (305 mm thick plain concrete wall) for frequency response determination from 3.0 to 8.0 GHz. See Figures 4.11c and 4.11d.

Table 4.11a: Regression Coefficients (decimal) for Concrete Type 8 Transmission versus Frequency Curves Plotted in Figure 4.11a. The regression equation is of the form $\text{Transmission Coefficient} = M_0 + M_1 * F + M_2 * F^2 + M_3 * F^3 + M_4 * F^4 + M_5 * F^5 + M_6 * F^6$ etc. where F is the frequency in GHz. The correlation coefficient, R, is defined in the text. Data are for the Frequency Range 0.5 to 2.0 GHz.

Concrete Type 8 Attenuation Curves (0.5 to 2.0 GHz)									
Curve Identification									
Coefficient	C84L	C84L + sigma	C84L - sigma	C88L	C88L + sigma	C88L - sigma	C812L	C812L + sigma	C812L - sigma
	Decimal	Decimal	Decimal	Decimal	Decimal	Decimal	Decimal	Decimal	Decimal
M0	3.9261E-01	3.2877E-01	4.5646E-01	1.9574E-01	2.1489E-01	1.7659E-01	3.7269E-02	3.8848E-02	3.5690E-02
M1	-2.5243E-01	1.7877E-01	-6.8363E-01	-4.9081E-01	-5.8680E-01	-3.9481E-01	-5.3262E-02	-6.0641E-02	-4.5883E-02
M2	4.5625E-02	-1.0246E+00	1.1158E+00	8.0792E-01	9.9712E-01	6.1872E-01	6.8098E-02	8.6298E-02	4.9900E-02
M3	-2.2586E-02	1.2787E+00	-1.3239E+00	-8.3060E-01	-1.0186E+00	-6.4256E-01	-5.4013E-02	-7.5671E-02	-3.2356E-02
M4	8.1722E-02	-7.5028E-01	9.1372E-01	4.9001E-01	5.9206E-01	3.8796E-01	2.2128E-02	3.5810E-02	8.4461E-03
M5	-5.4640E-02	2.1442E-01	-3.2370E-01	-1.4966E-01	-1.7878E-01	-1.2054E-01	-3.3519E-03	-7.7342E-03	1.0302E-03
M6	1.0761E-02	-2.3988E-02	4.5509E-02	1.8226E-02	2.1659E-02	1.4792E-02	-5.1188E-05	5.0721E-04	-6.0955E-04
M7									
M8									
M9									
R	1	1	0.99999	1	1	1	0.99999	0.99999	0.99999

Figure 4.11a: Transmission Coefficients for Concrete Type 8 walls (relative to free space). Nominal thicknesses: C84L = 102 mm; C88L = 203 mm; C812L = 305 mm. Dotted Curves represent +/- 1 standard deviation from mean (Solid Curves). Low Range Data: 0.5 to 2.0 GHz

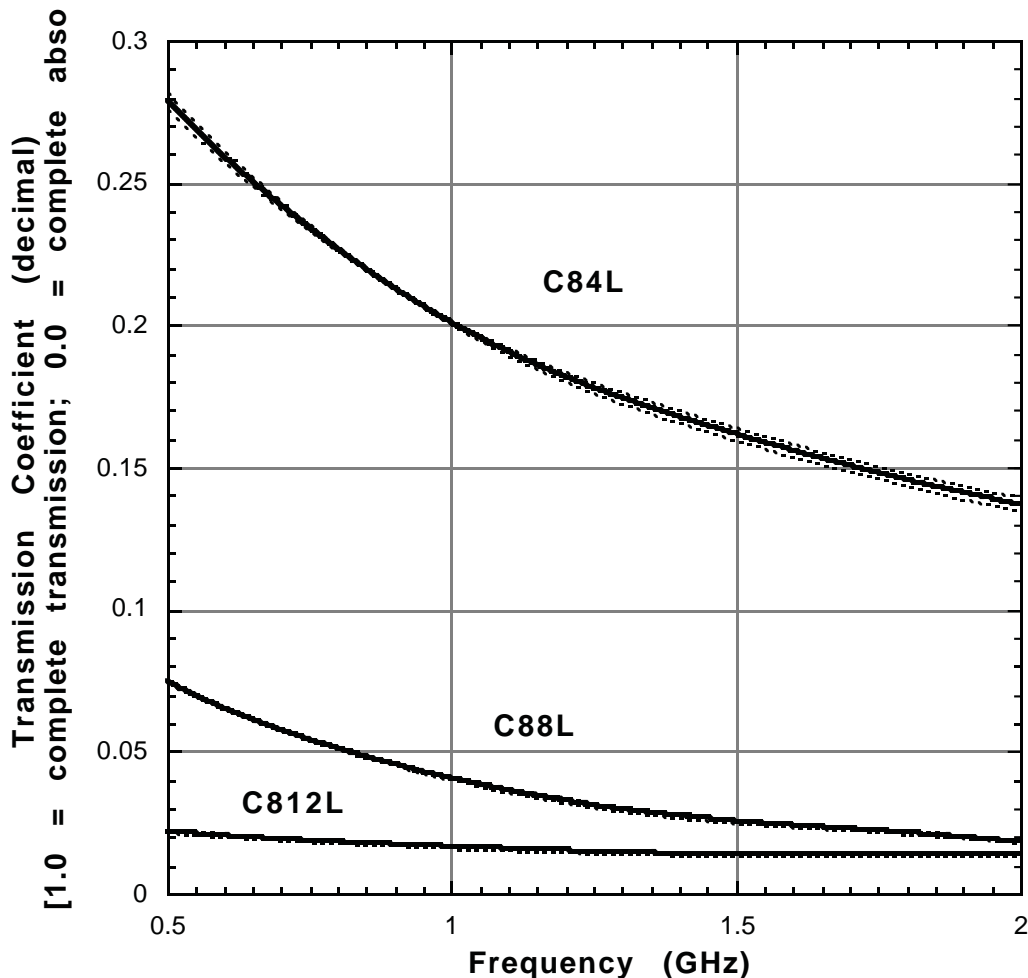

Table 4.11b: Regression Coefficients (dB) for Concrete Type 8 Transmission versus Frequency Curves Plotted in Figure 4.11b. The regression equation is of the form
 Received Signal Magnitude (relative to free space)
 $= M_0 + M_1 * F + M_2 * F^2 + M_3 * F^3 + M_4 * F^4 + M_5 * F^5 + M_6 * F^6$, where F is the frequency in GHz.
 The correlation coefficient, R, is defined in the text.
 Data are for the Frequency Range 0.5 to 2.0 GHz.

Concrete Type 8 Attenuation Curves (0.5 to 2.0 GHz)									
Curve Identification									
Coefficient	C84L dB	C84L + sigma dB	C84L - sigma dB	C88L dB	C88L + sigma dB	C88L - sigma dB	C812L dB	C812L + sigma dB	C812L - sigma dB
M0	-8.1679E+00	-1.1223E+01	-5.0922E+00	-7.5025E+00	-6.1221E+00	-8.7903E+00	-2.7598E+01	-2.6900E+01	-2.8353E+01
M1	-6.0224E+00	1.3507E+01	-2.5688E+01	-6.4597E+01	-7.0406E+01	-5.9339E+01	-1.8415E+01	-2.2076E+01	-1.4415E+01
M2	2.6371E+00	-4.4385E+01	4.9984E+01	1.1751E+02	1.2639E+02	1.0988E+02	2.1544E+01	3.0913E+01	1.1338E+01
M3	-8.8756E+00	4.7127E+01	-6.5253E+01	-1.2896E+02	-1.3519E+02	-1.2414E+02	-1.5258E+01	-2.6675E+01	-2.8155E+00
M4	1.0721E+01	-2.4501E+01	4.6165E+01	7.4256E+01	7.6711E+01	7.2597E+01	3.6460E+00	1.1139E+01	-4.5284E+00
M5	-5.0736E+00	6.1611E+00	-1.6374E+01	-2.0580E+01	-2.1214E+01	-2.0164E+01	1.0297E+00	-1.4844E+00	3.7745E+00
M6	8.4753E-01	-5.8610E-01	2.2889E+00	2.0961E+00	2.1840E+00	2.0306E+00	-4.3310E-01	-9.7174E-02	-7.9992E-01
M7									
M8									
M9									
R	1	1	0.99999	1	1	1	0.99999	0.99999	0.99999

Figure 4.11b: Received Signal Magnitude (dB) for Concrete Type 8 Walls (relative to free space). Nominal thicknesses:
 C84L = 102 mm; C88L = 203 mm; C812L = 305 mm
 Dotted Curves represent +/- 1 standard deviation from mean (Solid Curves).
 Low Range Data: 0.5 to 2.0 GHz

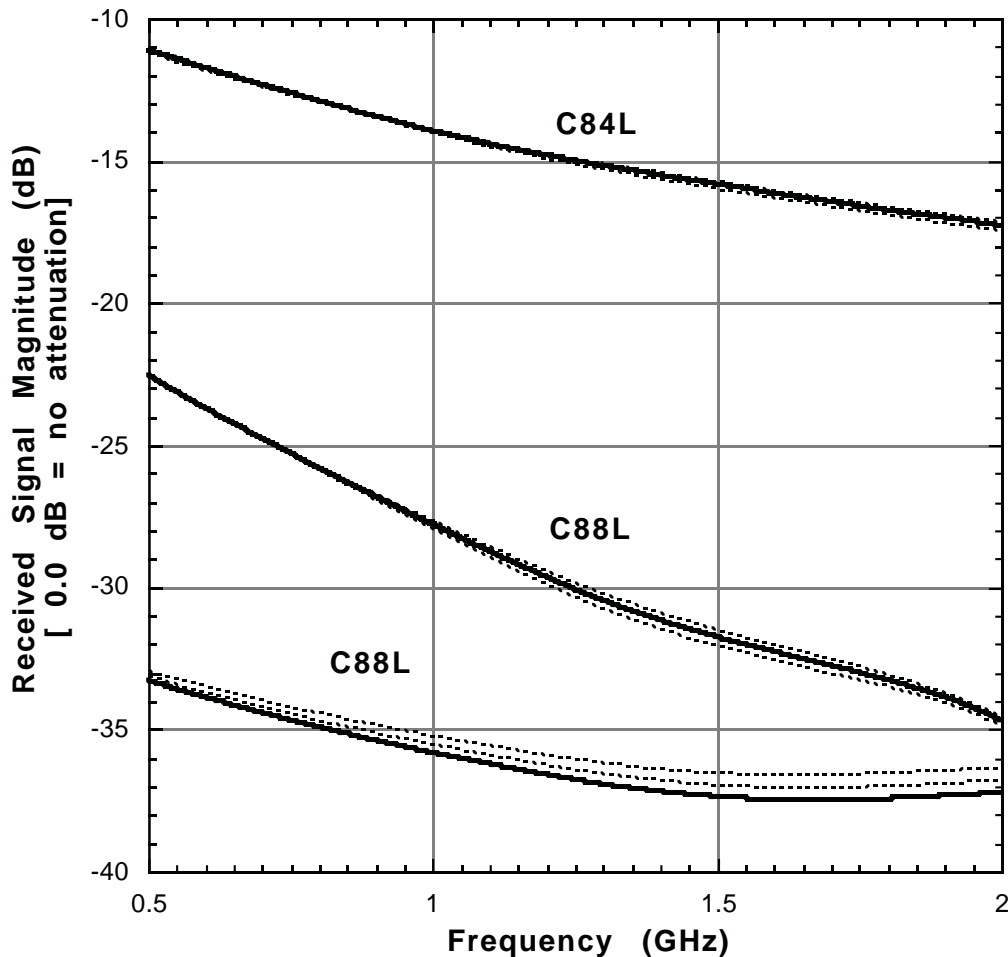

Table 4.11c: Regression Coefficients (decimal) for Concrete Type 8 Transmission versus Frequency Curves Plotted in Figure 4.11c. The regression equation is of the form $\text{Transmission Coefficient} = M_0 + M_1 \cdot F + M_2 \cdot F^2 + M_3 \cdot F^3 + M_4 \cdot F^4 + M_5 \cdot F^5 + M_6 \cdot F^6$ etc. where F is the frequency in GHz. The correlation coefficient, R, is defined in the text. Data are for the Frequency Range 3.0 to 8.0 GHz.

Concrete Type 8 Attenuation Curves (3.0 to 8.0 GHz)									
Curve Identification									
Coefficient	C84H	C84H + sigma	C84H - sigma	C88H	C88H + sigma	C88H - sigma	C812H	C812H + sigma	C812H - sigma
	Decimal	Decimal	Decimal	Decimal	Decimal	Decimal	Decimal	Decimal	Decimal
M0	2.9799E-02	2.9505E-02	3.0093E-02	8.5008E-03	8.7618E-03	8.2397E-03	-5.0974E-04	-4.4285E-04	-5.8435E-04
M1	3.3405E-02	3.5684E-02	3.1127E-02	-5.7899E-03	-5.8974E-03	-5.6824E-03	1.3805E-03	1.3002E-03	1.4715E-03
M2	-1.7539E-02	-1.8676E-02	-1.6401E-02	2.7328E-03	2.7595E-03	2.7060E-03	-9.2188E-04	-8.7702E-04	-9.7278E-04
M3	5.3405E-03	5.6573E-03	5.0236E-03	-7.0006E-04	-7.0104E-04	-6.9909E-04	3.1953E-04	3.0631E-04	3.3446E-04
M4	-9.5007E-04	-9.9913E-04	-9.0100E-04	9.3971E-05	9.2931E-05	9.5014E-05	-6.4113E-05	-6.2093E-05	-6.6339E-05
M5	8.4011E-05	8.7818E-05	8.0204E-05	-6.4726E-06	-6.2918E-06	-6.6536E-06	7.1799E-06	7.0755E-06	7.2735E-06
M6	-2.8509E-06	-2.9672E-06	-2.7346E-06	1.8601E-07	1.7739E-07	1.9464E-07	-3.5036E-07	-3.6326E-07	-3.3041E-07
M7							-6.74E-09	-4.37E-09	-1.01E-08
M8							1.4050E-09	1.2646E-09	1.6063E-09
M9							-4.0075E-11	-3.7111E-11	-4.4564E-11
R	1	1	1	1	1	1	1.00000	1.00000	1.00000

Figure 4.11c: Transmission Coefficients for Concrete Type 8 walls (relative to free space). Nominal thicknesses: C84H = 102 mm; C88H = 203 mm; C812H = 305 mm. Dotted Curves represent +/- 1 standard deviation from mean (Solid Curves). High Range Data: 3.0 to 8.0 GHz

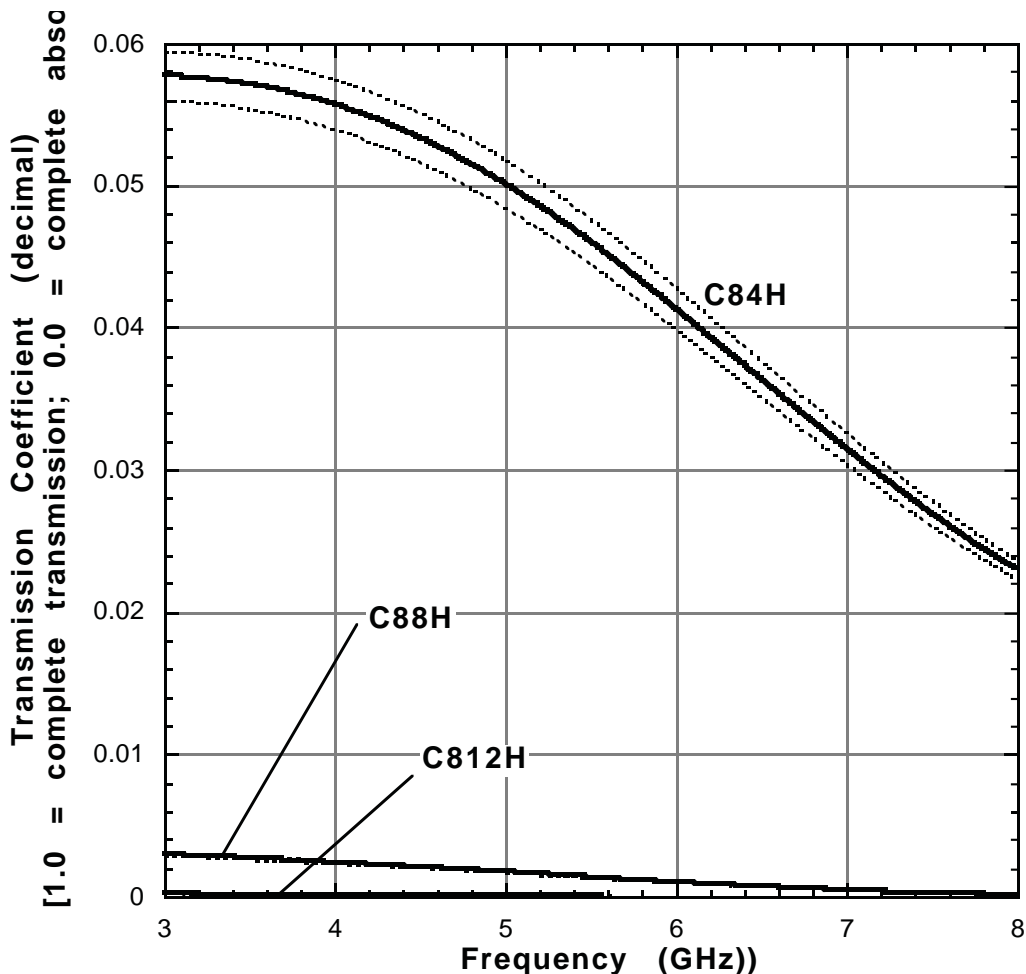
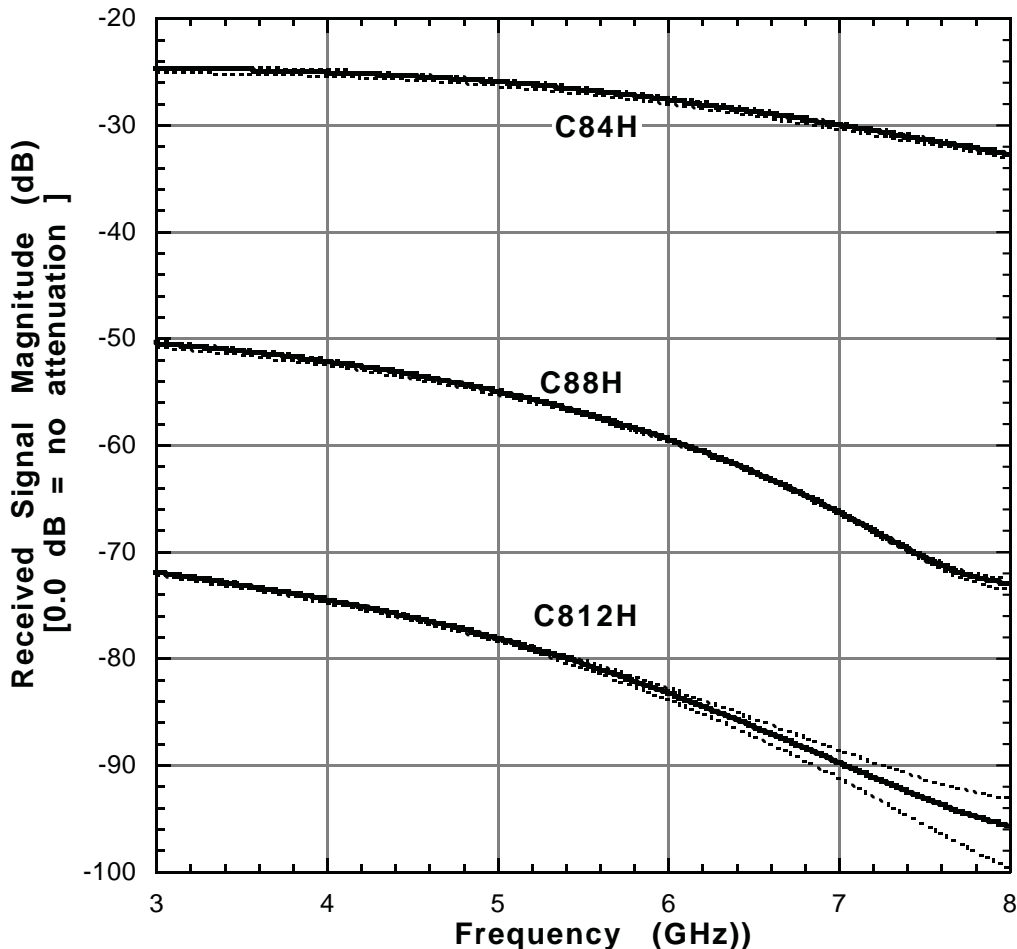

Table 4.11d: Regression Coefficients (dB) for Concrete Type 8 Transmission versus Frequency Curves Plotted in Figure 4.11d. The regression equation is of the form
 Received Signal Magnitude (relative to free space)
 $= M_0 + M_1 * F + M_2 * F^2 + M_3 * F^3 + M_4 * F^4 + M_5 * F^5 + M_6 * F^6$, where F is the frequency in GHz.
 The correlation coefficient, R, is defined in the text.
 Data are for the Frequency Range 3.0 to 8.0 GHz.

Concrete Type 8 Attenuation Curves (3.0 to 8.0 GHz)									
Curve Identification									
Coefficient	C84H	C84H + sigma	C84H - sigma	C88H	C88H + sigma	C88H - sigma	C812H	C812H + sigma	C812H - sigma
	dB	dB	dB	dB	dB	dB	dB	dB	dB
M0	-3.0433E+01	-3.0162E+01	-3.0738E+01	2.1087E+02	2.0579E+02	2.1482E+02	-1.4288E+02	-1.5325E+02	-7.6299E+01
M1	6.5631E+00	6.5120E+00	6.6502E+00	-3.3034E+02	-3.2375E+02	-3.3550E+02	1.0867E+02	1.2633E+02	4.7141E+00
M2	-3.1947E+00	-3.1628E+00	-3.2458E+00	1.7179E+02	1.6855E+02	1.7428E+02	-6.7188E+01	-7.9231E+01	-3.0508E-01
M3	8.5973E-01	8.5119E-01	8.7357E-01	-4.6890E+01	-4.6076E+01	-4.7497E+01	2.2457E+01	2.6611E+01	1.3064E-01
M4	-1.3183E-01	-1.3059E-01	-1.3387E-01	7.0653E+00	6.9559E+00	7.1434E+00	-4.5277E+00	-5.1896E+00	-7.8233E-01
M5	9.8529E-03	9.7752E-03	9.9933E-03	-5.5888E-01	-5.5155E-01	-5.6371E-01	5.7683E-01	5.6584E-01	4.5179E-01
M6	-2.8023E-04	-2.7946E-04	-2.8291E-04	1.8103E-02	1.7918E-02	1.8205E-02	-4.9986E-02	-2.6467E-02	-1.1754E-01
M7							3.37E-03	-7.18E-04	1.62E-02
M8							-1.8481E-04	1.2875E-04	-1.1504E-03
M9							5.6351E-06	-3.7738E-06	3.3487E-05
R	1	1	1	0.99998	0.99998	0.99998	1.00000	1.00000	1.00000

Figure 4.11d: Received Signal Magnitude (dB) for Concrete Type 8 Walls (relative to free space). Nominal thicknesses:
 C84H = 102 mm; C88H = 203 mm; C812H = 305 mm
 Dotted Curves represent +/- 1 standard deviation from mean (Solid Curves).
 High Range Data: 3.0 to 8.0 GHz



BLANK PAGE

4.12 Masonry Block

The following four tables (4.12a through 4.12d) present the frequency response spectrum for masonry block walls. The specimens in this series bear the designation CBXXL and CBXXH, where the “XX” defines the specimen thickness in inches, and the L and H denote “low” (0.5 to 2.0 GHz) and “high” (3.0 to 8.0 GHz) frequency bandwidths.

Three specimen thicknesses, 203 mm, 406 mm, and 609 mm, were tested. The average material density was 1.84 g/cc. However, because the specimens were hollow (see Section 3.2) the “apparent”

density (external block volume divided by the block mass) as seen by the radar was approximately 1.04 g/cc. One could, alternatively, consider the results in terms of “apparent thickness,” that is, the total thickness minus the internal cell width.

Figures 4.12a and 4.12b cover the band from 0.5 to 2.0 GHz, while Figures 4.12c and 4.12d are for the range 3.0 to 8.0 GHz. The ordinate values represent the ratio of the received to transmitted signal. The decimal attenuation values are presented first, followed by the same ordinate set converted to decibels. The generally high standard deviations are attributed to the presence of the cells.

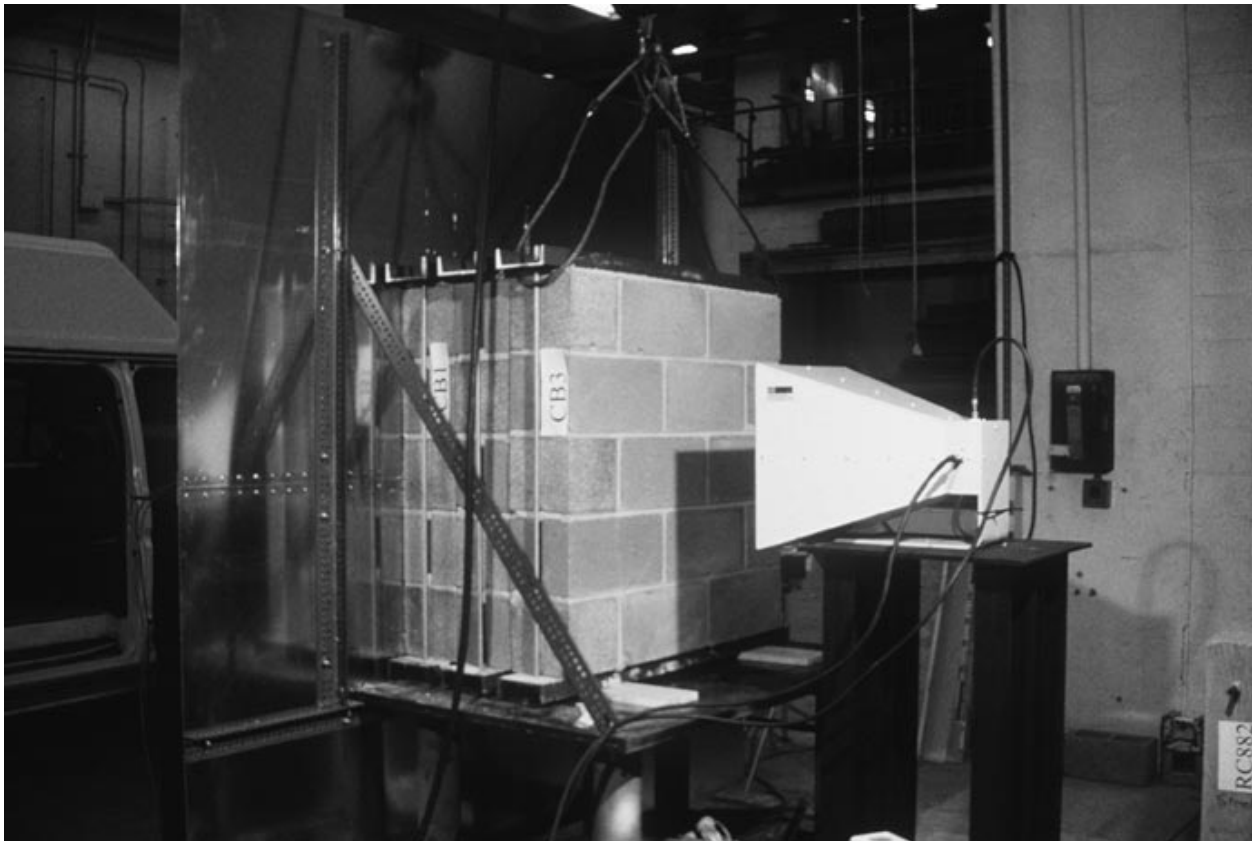

Figure 4.12: Test setup for specimen CB3L (3 layers deep of 203 mm masonry block, total thickness 609 mm) for frequency response determination from 0.5 to 2.0 GHz. See Figures 4.12a and 4.12b.

Table 4.12a: Regression Coefficients (decimal) for Masonry Block Transmission versus Frequency Curves Plotted in Figure 4.12a. The regression equation is of the form Transmission Coefficient = $M_0 + M_1 * F + M_2 * F^2 + M_3 * F^3 + M_4 * F^4 + M_5 * F^5 + M_6 * F^6$ etc. where F is the frequency in GHz. The correlation coefficient, R, is defined in the text. Data are for the Frequency Range 0.5 to 2.0 GHz.

Masonry Block Attenuation Curves (0.5 to 2.0 GHz)									
Curve Identification									
Coefficient	CB1L	CB1L + sigma	CB1L - sigma	CB2L	CB2L + sigma	CB2L - sigma	CB3L	CB3L + sigma	CB3L - sigma
	Decimal	Decimal	Decimal	Decimal	Decimal	Decimal	Decimal	Decimal	Decimal
M0	5.1710E-01	0.5979	4.3630E-01	6.1626E-01	6.3842E-01	5.9410E-01	5.3364E-02	6.0813E-02	4.5916E-02
M1	6.7249E-01	3.0885E-01	1.0361E+00	-1.3796E+00	-1.3698E+00	-1.3894E+00	1.8802E-02	1.2808E-02	2.4795E-02
M2	-3.8783E+00	-3.1181E+00	-4.6385E+00	1.5051E+00	1.4814E+00	1.5288E+00	-1.1534E-01	-1.1070E-01	-1.1997E-01
M3	5.5193E+00	4.6895E+00	6.3490E+00	-7.3537E-01	-7.5417E-01	-7.1656E-01	1.5970E-01	1.5579E-01	1.6360E-01
M4	-3.4453E+00	-2.9643E+00	-3.9262E+00	1.0979E-01	1.5817E-01	6.1411E-02	-1.0757E-01	-1.0517E-01	-1.0997E-01
M5	9.8550E-01	8.4614E-01	1.1249E+00	2.8706E-02	-2.2677E-03	5.9680E-02	3.5787E-02	3.4938E-02	3.6635E-02
M6	-1.0371E-01	-8.7903E-02	-1.1952E-01	-8.4654E-03	-1.8271E-03	-1.5104E-02	-4.6812E-03	-4.5636E-03	-4.7987E-03
M7									
M8									
M9									
R	0.99991	9.9997E-01	0.99976	0.99999	0.99999	0.99998	1	1	1

Figure 4.12a: Transmission Coefficients for Masonry Block walls (relative to free space). Nominal thicknesses: CB1L = 203 mm; CB2L = 406 mm; CB3L = 610 mm. Dotted Curves represent +/- 1 standard deviation from mean (Solid Curves). Low Range Data: 0.5 to 2.0 GHz

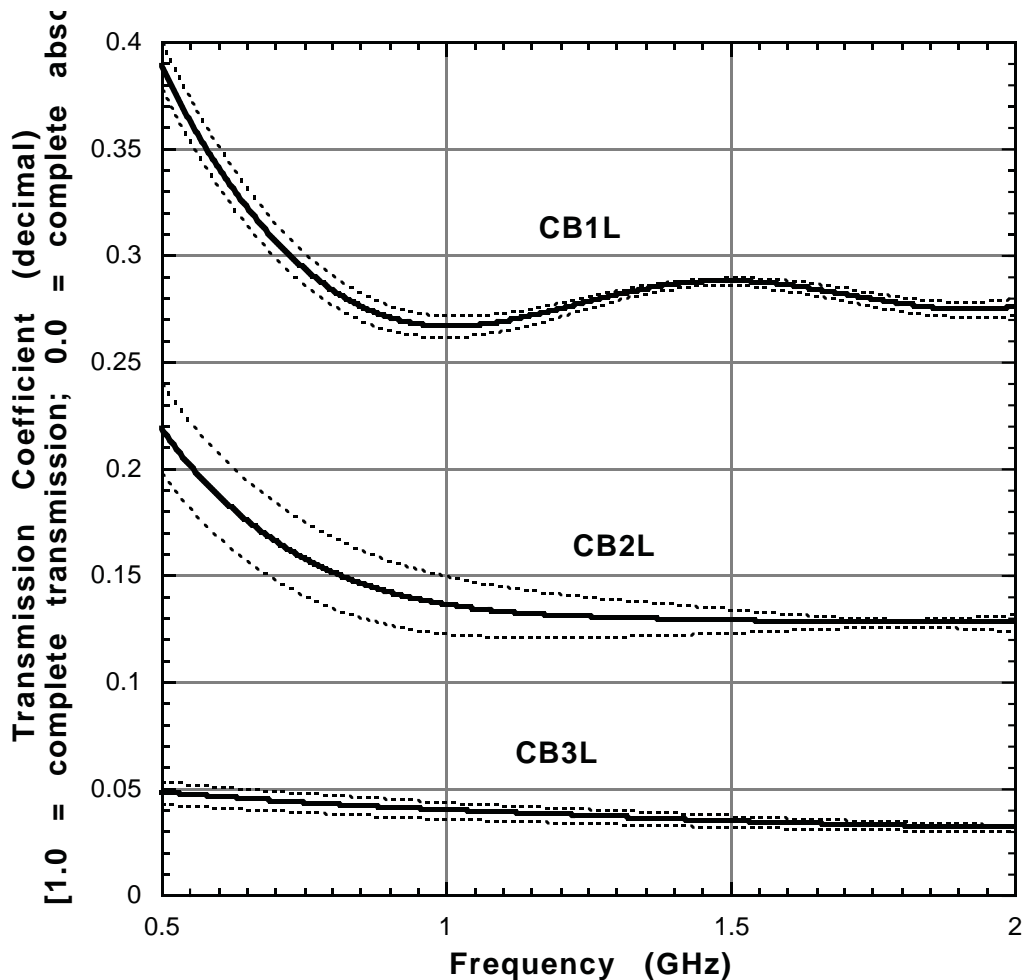

Table 4.12b: Regression Coefficients (dB) for Masonry Block Transmission versus Frequency Curves Plotted in Figure 4.12b. The regression equation is of the form Received Signal Magnitude = $M_0 + M_1 * F + M_2 * F^2 + M_3 * F^3 + M_4 * F^4 + M_5 * F^5 + M_6 * F^6$, where F is the frequency in GHz. The correlation coefficient, R, is defined in the text. Data are for the Frequency Range 0.5 to 2.0 GHz.

Masonry Block Attenuation Curves (0.5 to 2.0 GHz)									
Coefficient	Curve Identification								
	CB1L dB	CB1L + sigma dB	CB1L - sigma dB	CB2L dB	CB2L + sigma dB	CB2L - sigma dB	CB3L dB	CB3L + sigma dB	CB3L - sigma dB
M0	-1.7808E+01	-15.63	-2.0013E+01	-7.0249E+00	-6.5323E+00	-7.7221E+00	-2.6225E+01	-2.5053E+01	-2.7559E+01
M1	8.9222E+01	7.7737E+01	1.0084E+02	3.0414E+00	1.1823E+00	6.4468E+00	7.9288E+00	6.5269E+00	9.6252E+00
M2	-2.5509E+02	-2.2820E+02	-2.8236E+02	-7.1560E+01	-5.9690E+01	-8.8628E+01	-3.0368E+01	-2.7202E+01	-3.4191E+01
M3	3.0965E+02	2.7814E+02	3.4169E+02	1.1536E+02	9.4815E+01	1.4321E+02	3.8844E+01	3.4777E+01	4.3766E+01
M4	-1.8510E+02	-1.6588E+02	-2.0468E+02	-8.0206E+01	-6.4029E+01	-1.0135E+02	-2.5317E+01	-2.2582E+01	-2.8640E+01
M5	5.3652E+01	4.7828E+01	5.9602E+01	2.6496E+01	2.0189E+01	3.4448E+01	8.2547E+00	7.3251E+00	9.3905E+00
M6	-6.0000E+00	-5.3075E+00	-6.7093E+00	-3.4085E+00	-2.4178E+00	-4.6140E+00	-1.0622E+00	-9.3869E-01	-1.2144E+00
M7									
M8									
M9									
R	0.9999	0.99995	0.99978	1	0.99999	0.99996	1	1	1

Figure 4.12b: Received Signal Magnitude (dB) for Masonry Block Walls (relative to free space).
 Nominal thicknesses: CB1L = 203 mm; CB2L = 406 mm; CB3L = 610 mm
 Dotted Curves represent +/- 1 standard deviation from mean (Solid Curves).
 Low Range Data: 0.5 to 2.0 GHz

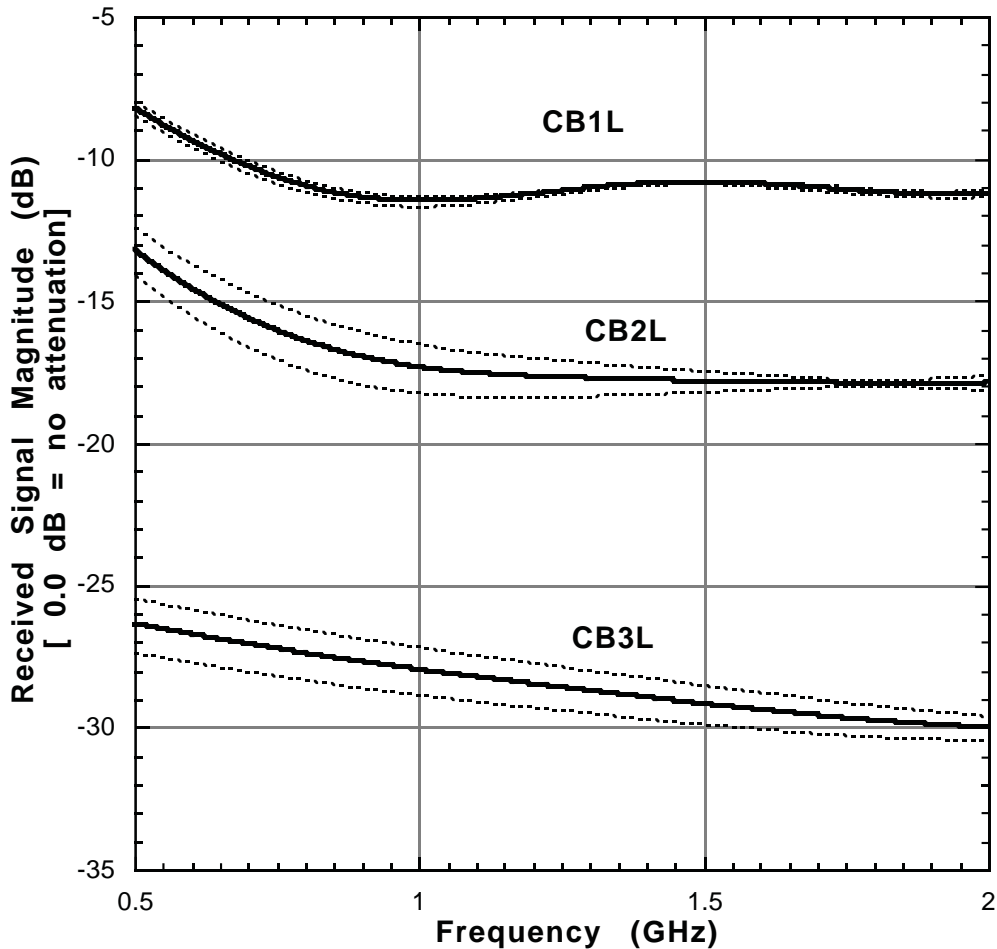

Table 4.12c: Regression Coefficients (decimal) for Masonry Block Transmission versus Frequency Curves Plotted in Figure 4.12c. The regression equation is of the form Transmission Coefficient = M0+M1*F+M2*F^2+M3*F^3+M4*F^4+M5*F^5+M6*F^6 etc. where F is the frequency in GHz. The correlation coefficient, R, is defined in the text. Data are for the Frequency Range 3.0 to 8.0 GHz.

Masonry Block Attenuation Curves (3.0 to 8.0 GHz)									
Curve Identification									
Coefficient	CB1H	CB1H + sigma	CB1H - sigma	CB2H	CB2H + sigma	CB2H - sigma	CB3H	CB3H + sigma	CB3H - sigma
	Decimal	Decimal	Decimal	Decimal	Decimal	Decimal	Decimal	Decimal	Decimal
M0	-3.5380E-02	-0.010959	-5.9800E-02	-5.5132E+01	-6.7389E+01	-4.2875E+01	-2.8270E+00	7.1842E+00	-1.2838E+01
M1	2.2871E-01	2.4203E-01	2.1539E-01	8.9368E+01	1.1138E+02	6.7360E+01	6.1321E+00	-8.4907E+00	2.0755E+01
M2	-1.1111E-01	-1.1792E-01	-1.0431E-01	-5.8783E+01	-7.4411E+01	-4.3155E+01	-4.8129E+00	3.9465E+00	-1.3572E+01
M3	3.0930E-02	3.2995E-02	2.8865E-02	1.9681E+01	2.5242E+01	1.4119E+01	1.7701E+00	-9.1401E-01	4.4543E+00
M4	-4.8634E-03	-5.2020E-03	-4.5247E-03	-3.2169E+00	-4.1724E+00	-2.2614E+00	-2.7302E-01	1.2444E-01	-6.7047E-01
M5	3.8809E-04	4.1636E-04	3.5982E-04	7.7397E-02	1.0086E-01	5.3934E-02	-1.4144E-02	-1.8857E-02	-9.4311E-03
M6	-1.2190E-05	-1.3123E-05	-1.1257E-05	6.3083E-02	8.3569E-02	4.2598E-02	1.2323E-02	4.3094E-03	2.0337E-02
M7				-0.011089	-0.014803	-0.0073755	-0.00197	-0.00067924	-0.0032608
M8				7.9218E-04	1.0651E-03	5.1930E-04	1.4117E-04	5.3753E-05	2.2859E-04
M9				-2.1648E-05	-2.9294E-05	-1.4003E-05	-3.9504E-06	-1.6591E-06	-6.2417E-06
R	1	1	1	0.99697	0.99777	0.99019	0.99767	0.99823	0.99641

Figure 4.12c: Transmission Coefficients for Masonry Block walls (relative to free space). Nominal thicknesses: CB1H = 203 mm; CB2H = 406 mm; CB3H = 610 mm. Dotted Curves represent +/- 1 standard deviation from mean (Solid Curves). High Range Data: 3.0 to 8.0 GHz

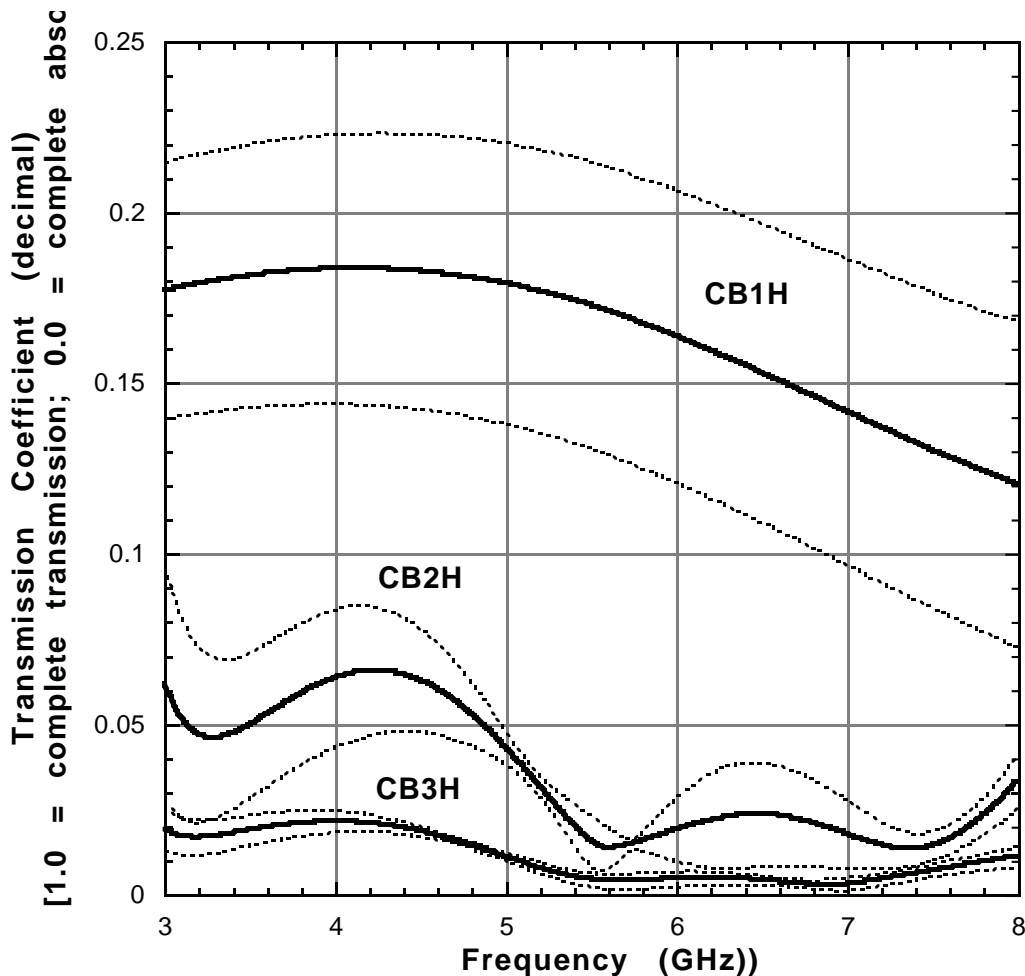
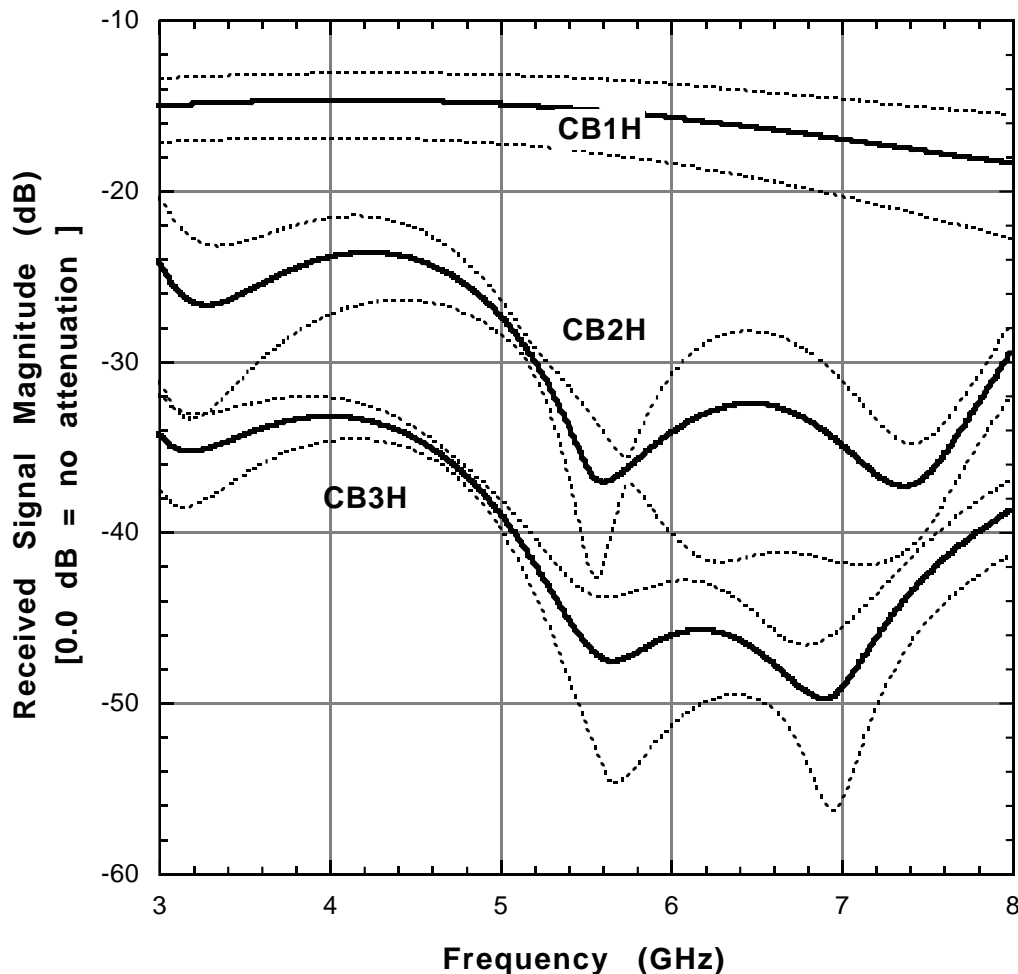

Table 4.12d: Regression Coefficients (dB) for Masonry Block Transmission versus Frequency Curves Plotted in Figure 4.12d. The regression equation is of the form Received Signal Magnitude = $M_0 + M_1 * F + M_2 * F^2 + M_3 * F^3 + M_4 * F^4 + M_5 * F^5 + M_6 * F^6$, where F is the frequency in GHz. The correlation coefficient, R, is defined in the text. Data are for the Frequency Range 3.0 to 8.0 GHz.

Masonry Block Attenuation Curves (3.0 to 8.0 GHz)									
Curve Identification									
Coefficient	CB1H	CB1H + sigma	CB1H - sigma	CB2H	CB2H + sigma	CB2H - sigma	CB3H	CB3H + sigma	CB3H - sigma
	dB	dB	dB	dB	dB	dB	dB	dB	dB
M0	-2.5922E+01	-23.383	-2.7998E+01	-3.3039E+04	-3.5063E+04	-2.0688E+04	-1.6712E+04	-4.4124E+03	-4.0676E+04
M1	1.1336E+01	1.0567E+01	1.0829E+01	5.0251E+04	5.3365E+04	3.1648E+04	2.5604E+04	7.3317E+03	6.1222E+04
M2	-5.2156E+00	-4.9537E+00	-4.7410E+00	-3.1459E+04	-3.3386E+04	-2.0009E+04	-1.5991E+04	-4.8237E+03	-3.7795E+04
M3	1.3617E+00	1.3182E+00	1.1910E+00	1.0179E+04	1.0764E+04	6.5944E+03	5.0189E+03	1.5009E+03	1.1918E+04
M4	-2.0058E-01	-1.9761E-01	-1.6995E-01	-1.6588E+03	-1.7298E+03	-1.1284E+03	-7.1037E+02	-1.6047E+02	-1.8037E+03
M5	1.4936E-02	1.5059E-02	1.2073E-02	6.0594E+01	5.3176E+01	6.1169E+01	-1.9803E+01	-3.4403E+01	1.4680E+01
M6	-4.3635E-04	-4.5228E-04	-3.3281E-04	2.5021E+01	2.8811E+01	1.1785E+01	2.3327E+01	1.3899E+01	4.0707E+01
M7				-4.5858	-5.1287	-2.4678	-3.6012	-1.9689	-6.6857
M8				3.2723E-01	3.6355E-01	1.8131E-01	2.4801E-01	1.3374E-01	4.6560E-01
M9				-8.8712E-03	-9.8347E-03	-4.9654E-03	-6.7025E-03	-3.6333E-03	-1.2570E-02
R	1	1	1	0.9874	0.98742	0.97947	0.98886	0.99194	0.97547

Figure 4.12d: Received Signal Magnitude (dB) for Masonry Block Walls (relative to free space).
 Nominal thicknesses: CB1H = 203 mm; CB2H = 406 mm; CB3H = 610 mm
 Dotted Curves represent +/- 1 standard deviation from mean (Solid Curves).
 High Range Data: 3.0 to 8.0 GHz



BLANK PAGE

4.13 Drywall

The following four tables (4.13a through 4.13d) present the response spectrum for drywall panels. The specimens in this series bear the designation DXXL and DXXH, where the “XX” defines the specimen thickness in inches, and the L and H denote “low” (0.5 to 2.0 GHz) and “high” (3.0 to 8.0 GHz) frequency bandwidths.

Three specimen thicknesses, 6 mm, 13 mm, and 16 mm were tested. The average material density was 0.87 g/cc. for the 6 mm specimens and 0.66 for the 13 mm and 16 mm specimens.

Figures 4.13a and 4.13b cover the band from 0.5 to 2.0 GHz, while Figures 4.13c and 4.13d are for the range 3.0 to 8.0 GHz. The ordinate values represent the ratio of the received to transmitted signal. The decimal attenuation values are presented first, followed by the same ordinate set converted to decibels. Figures 4.13c and 4.13d show transmission coefficients close to or slightly greater than 1.0 in the decimal range (0 or slightly positive in dB) for some frequencies. These may be attributed to constructive interference within the material and to resolution limitations of the measurement system.



Figure 4.13: Test setup for specimen D25L (nominal 6 mm thick drywall panel) for frequency response determination from 0.5 to 2.0 GHz. See Figures 4.13a and 4.13b.

Table 4.13a: Regression Coefficients (decimal) for Drywall Transmission versus Frequency Curves Plotted in Figure 4.13a. The regression equation is of the form $\text{Transmission Coefficient} = M_0 + M_1 \cdot F + M_2 \cdot F^2 + M_3 \cdot F^3 + M_4 \cdot F^4 + M_5 \cdot F^5 + M_6 \cdot F^6$ etc. where F is the frequency in GHz. The correlation coefficient, R, is defined in the text. Data are for the Frequency Range 0.5 to 2.0 GHz.

Drywall Attenuation Curves (0.5 to 2.0 GHz)									
Curve Identification									
Coefficient	D25L	D25L + sigma	D25L - sigma	D25L	D25L + sigma	D25L - sigma	D25L	D25L + sigma	D25L - sigma
	Decimal	Decimal	Decimal	Decimal	Decimal	Decimal	Decimal	Decimal	Decimal
M0	1.0120E+00	1.0217	1.0024E+00	1.0132E+00	1.0145E+00	1.0119E+00	1.0138E+00	1.0146E+00	1.0129E+00
M1	-4.5483E-02	-4.8958E-02	-4.2010E-02	-4.5454E-02	-3.5784E-02	-5.5134E-02	-4.7934E-02	-3.8792E-02	-5.7076E-02
M2	-3.4007E-02	-1.2588E-02	-5.5421E-02	-3.6504E-02	-2.5642E-02	-4.7347E-02	-3.1643E-02	-2.1601E-02	-4.1683E-02
M3	6.3383E-02	4.0933E-02	8.5828E-02	6.7589E-02	4.9882E-02	8.5277E-02	6.1056E-02	4.4591E-02	7.7520E-02
M4	-4.9455E-02	-3.6062E-02	-6.2845E-02	-5.2301E-02	-3.9673E-02	-6.4917E-02	-4.8109E-02	-3.6322E-02	-5.9895E-02
M5	1.9210E-02	1.4778E-02	2.3640E-02	2.0169E-02	1.5548E-02	2.4787E-02	1.8817E-02	1.4497E-02	2.3137E-02
M6	-2.8969E-03	-2.3007E-03	-3.4930E-03	-3.0254E-03	-2.3664E-03	-3.6840E-03	-2.8515E-03	-2.2354E-03	-3.4676E-03
M7									
M8									
M9									
R	1	1	1	1	1	1	1	1	1

Figure 4.13a: Transmission Coefficients for Drywall Panels (relative to free space). Nominal thicknesses: D25L = 6 mm; D50L = 13 mm; D625L = 16 mm. Dotted Curves represent +/- 1 standard deviation from mean (Solid Curves). Low Range Data: 0.5 to 2.0 GHz

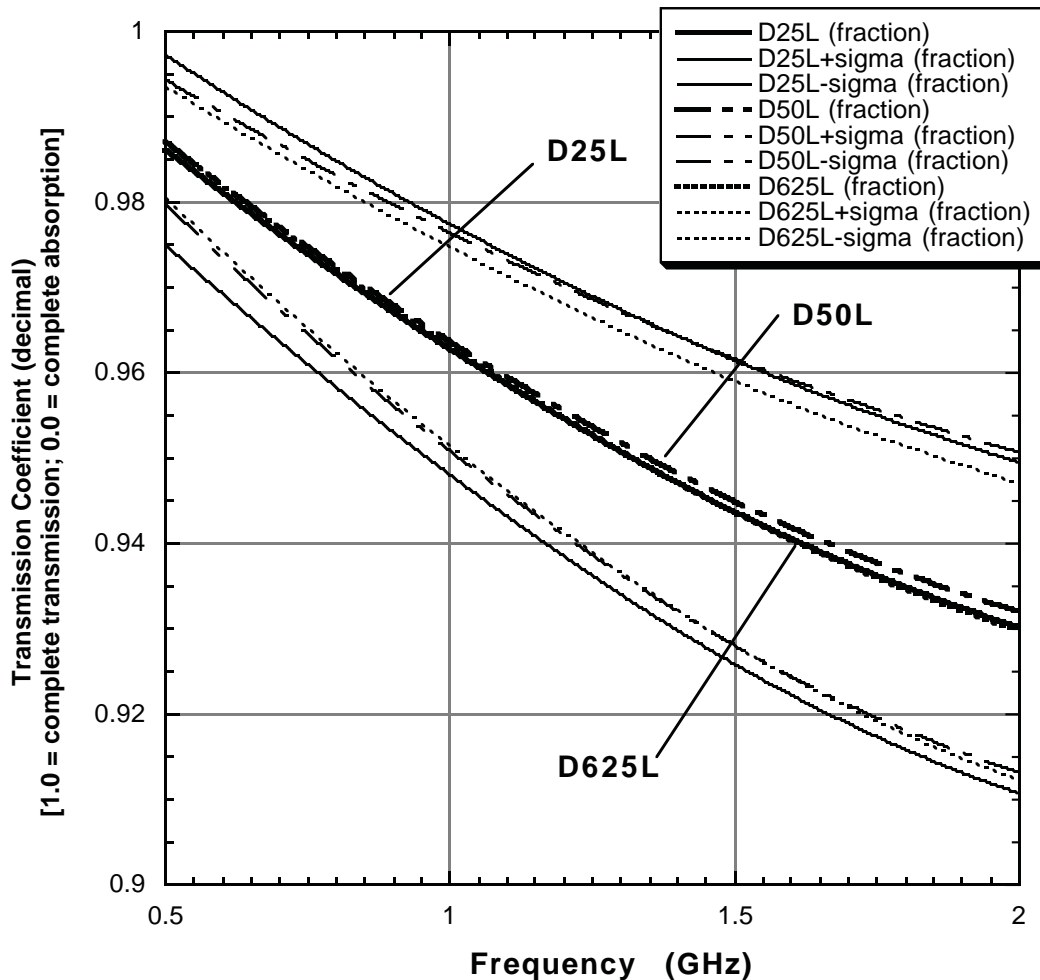

Table 4.13b: Regression Coefficients (dB) for Drywall Transmission versus Frequency Curves Plotted in Figure 4.13b. The regression equation is of the form Received Signal Magnitude = $M_0 + M_1 * F + M_2 * F^2 + M_3 * F^3 + M_4 * F^4 + M_5 * F^5 + M_6 * F^6$, where F is the frequency in GHz. The correlation coefficient, R, is defined in the text. Data are for the Frequency Range 0.5 to 2.0 GHz.

Drywall Attenuation Curves (0.5 to 2.0 GHz)									
Curve Identification									
Coefficient	D25L dB	D25L + sigma dB	D25L - sigma dB	D25L dB	D25L + sigma dB	D25L - sigma dB	D25L dB	D25L + sigma dB	D25L - sigma dB
M0	1.0177E-01	0.18498	1.7610E-02	1.1164E-01	1.2358E-01	9.9376E-02	1.1682E-01	1.2507E-01	1.0830E-01
M1	-3.7653E-01	-4.0794E-01	-3.4359E-01	-3.7506E-01	-2.9825E-01	-4.4994E-01	-3.9706E-01	-3.2439E-01	-4.6797E-01
M2	-3.4312E-01	-1.4362E-01	-5.4856E-01	-3.6647E-01	-2.5031E-01	-4.8986E-01	-3.2299E-01	-2.1556E-01	-4.3673E-01
M3	5.9856E-01	3.8808E-01	8.1527E-01	6.3649E-01	4.6043E-01	8.2014E-01	5.7808E-01	4.1465E-01	7.4814E-01
M4	-4.6255E-01	-3.3449E-01	-5.9483E-01	-4.8783E-01	-3.6305E-01	-6.1772E-01	-4.5065E-01	-3.3436E-01	-5.7141E-01
M5	1.7912E-01	1.3599E-01	2.2380E-01	1.8759E-01	1.4186E-01	2.3520E-01	1.7566E-01	1.3297E-01	2.1999E-01
M6	-2.6954E-02	-2.1080E-02	-3.3050E-02	-2.8084E-02	-2.1552E-02	-3.4886E-02	-2.6556E-02	-2.0457E-02	-3.2890E-02
M7									
M8									
M9									
R	1	1	1	1	1	1	1	1	1

Figure 4.13b: Received Signal Magnitude (dB) for Drywall Panels (relative to free space).
 D25L = 6 mm; D50L = 13 mm; D625L = 16 mm
 Dotted Curves represent +/- 1 standard deviation from mean (Solid Curves).
 Low Range Data: 0.5 to 2.0 GHz

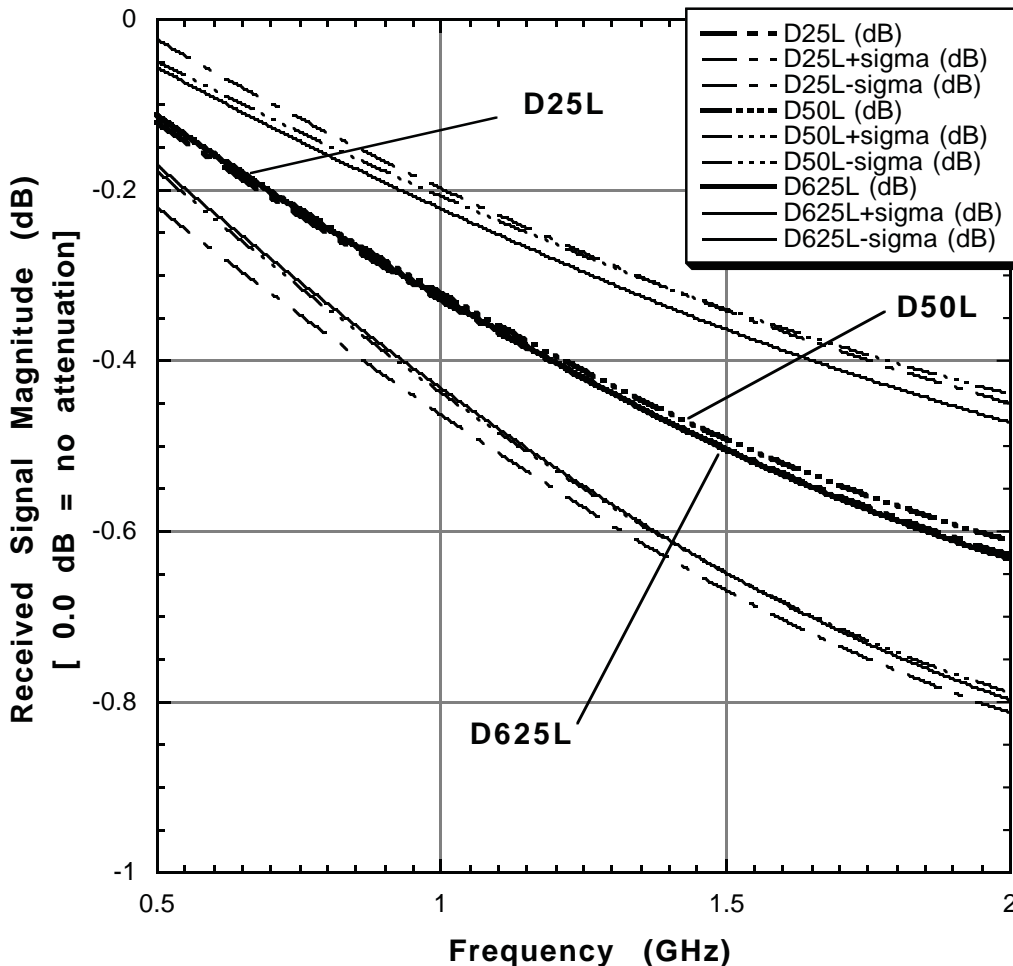

Table 4.13c: Regression Coefficients (decimal) for Drywall Transmission versus Frequency Curves Plotted in Figure 4.13c. The regression equation is of the form Transmission Coefficient = M0+M1*F+M2*F^2+M3*F^3+M4*F^4+M5*F^5+M6*F^6 etc. where F is the frequency in GHz. The correlation coefficient, R, is defined in the text. Data are for the Frequency Range 3.0 to 8.0 GHz.

Drywall Attenuation Curves (3.0 to 8.0 GHz)									
Curve Identification									
Coefficient	D25H decimal	D25H + sigma decimal	D25H - sigma decimal	D50H decimal	D50H + sigma decimal	D50H - sigma decimal	D625H decimal	D625H + sigma decimal	D625H - sigma decimal
M0	6.0134E-01	0.6047	5.9799E-01	8.6272E-01	8.6619E-01	8.5924E-01	9.8255E-01	9.8641E-01	9.7872E-01
M1	2.6860E-01	2.6803E-01	2.6914E-01	5.1441E-02	5.1697E-02	5.1196E-02	-3.2132E-02	-3.1460E-02	-3.2842E-02
M2	-9.2323E-02	-9.1855E-02	-9.2782E-02	1.0819E-02	1.0781E-02	1.0852E-02	4.8537E-02	4.8387E-02	4.8706E-02
M3	2.0894E-02	2.0748E-02	2.1038E-02	-6.2370E-03	-6.2465E-03	-6.2261E-03	-1.5920E-02	-1.5911E-02	-1.5935E-02
M4	-2.8179E-03	-2.7969E-03	-2.8385E-03	9.8820E-04	9.9094E-04	9.8523E-04	2.0619E-03	2.0650E-03	2.0595E-03
M5	1.8957E-04	1.8807E-04	1.9105E-04	-7.8599E-05	-7.8834E-05	-7.8347E-05	-1.2109E-04	-1.2181E-04	-1.2041E-04
M6	-4.8090E-06	-4.7647E-06	-4.8524E-06	2.7051E-06	2.7115E-06	2.6983E-06	2.8106E-06	2.8488E-06	2.7737E-06
M7									
M8									
M9									
R	0.99999	0.99999	0.99999	1	1	1	1	1	1

Figure 4.13c: Transmission Coefficients for Drywall Panels (relative to free space). Nominal thicknesses: D25H = 6 mm; D50H = 13 mm; D625H = 16 mm. Dotted Curves represent +/- 1 standard deviation from mean (Solid Curves). High Range Data: 3.0 to 8.0 GHz

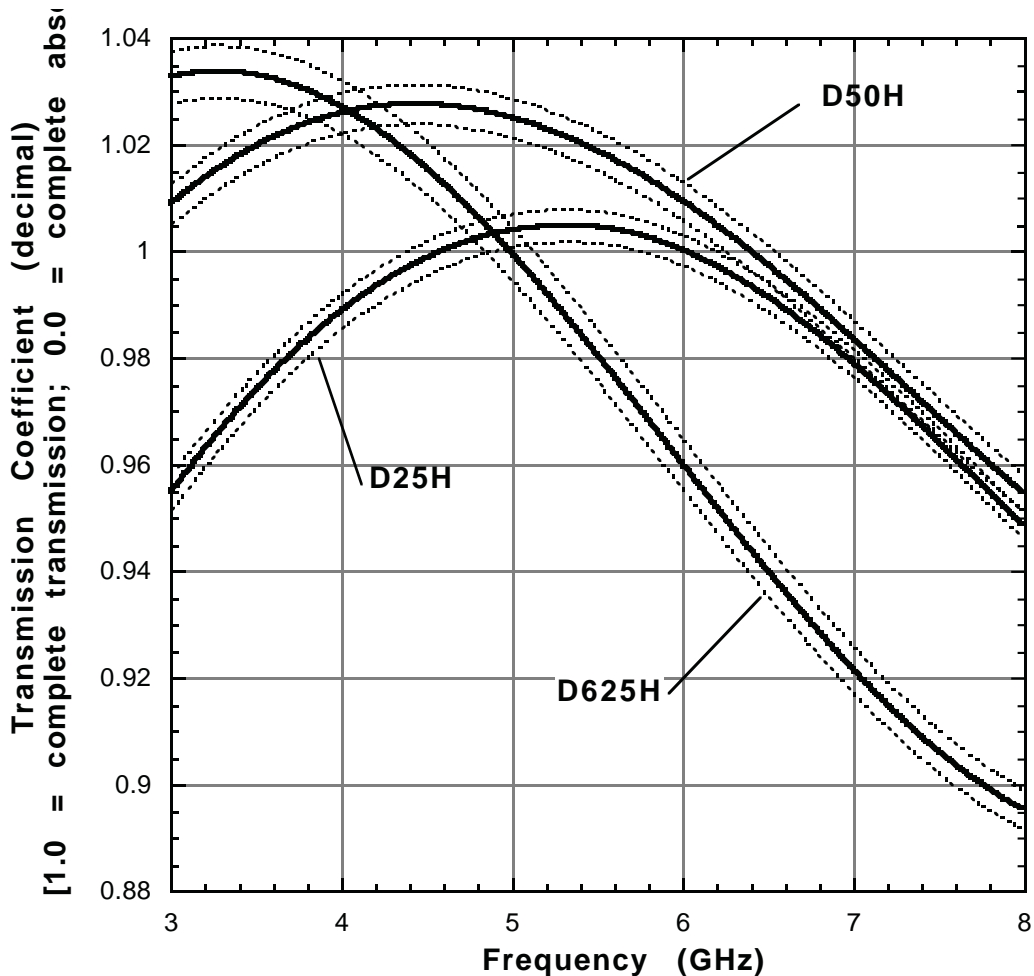
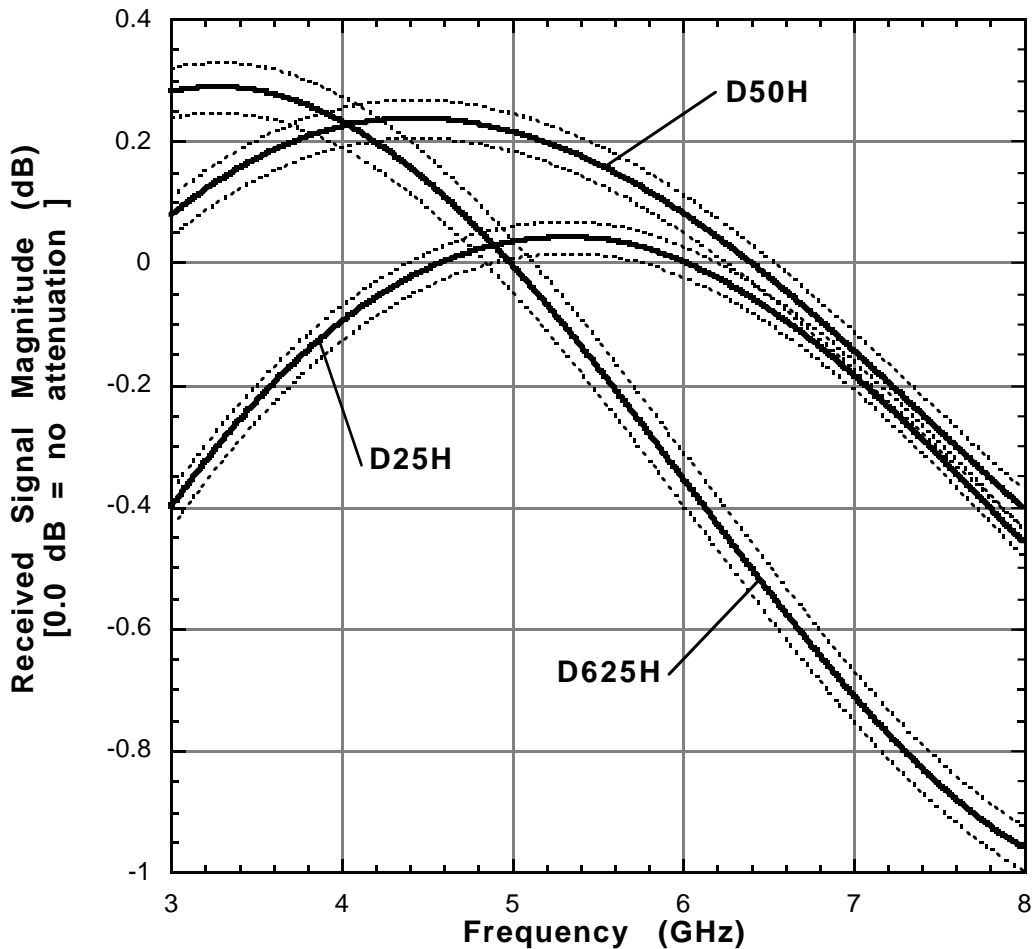

Table 4.13d: Regression Coefficients (dB) for Drywall Transmission versus Frequency Curves Plotted in Figure 4.13d. The regression equation is of the form Received Signal Magnitude = $M_0 + M_1 * F + M_2 * F^2 + M_3 * F^3 + M_4 * F^4 + M_5 * F^5 + M_6 * F^6$, where F is the frequency in GHz. The correlation coefficient, R, is defined in the text. Data are for the Frequency Range 3.0 to 8.0 GHz.

Drywall Attenuation Curves (3.0 to 8.0 GHz)									
Curve Identification									
Coefficient	D25H	D25H + sigma	D25H - sigma	D50H	D50H + sigma	D50H - sigma	D625H	D625H + sigma	D625H - sigma
	dB	dB	dB	dB	dB	dB	dB	dB	dB
M0	-3.6610E+00	-3.6213	-3.7009E+00	-1.3024E+00	-1.2673E+00	-1.3376E+00	-4.6243E-01	-4.2225E-01	-5.0279E-01
M1	2.4242E+00	2.4133E+00	2.4352E+00	5.6703E-01	5.6717E-01	5.6687E-01	1.6090E-01	1.5967E-01	1.6215E-01
M2	-7.9028E-01	-7.8451E-01	-7.9606E-01	4.7116E-02	4.6465E-02	4.7784E-02	1.7497E-01	1.7647E-01	1.7346E-01
M3	1.6723E-01	1.6559E-01	1.6887E-01	-4.6679E-02	-4.6521E-02	-4.6841E-02	-6.9699E-02	-7.0386E-02	-6.9001E-02
M4	-2.1237E-02	-2.1002E-02	-2.1474E-02	8.2634E-03	8.2438E-03	8.2837E-03	7.9927E-03	8.1647E-03	7.8183E-03
M5	1.3407E-03	1.3236E-03	1.3579E-03	-7.1352E-04	-7.1179E-04	-7.1530E-04	-3.4621E-04	-3.6632E-04	-3.2581E-04
M6	-3.1210E-05	-3.0705E-05	-3.1716E-05	2.5864E-05	2.5785E-05	2.5944E-05	4.9902E-06	5.8154E-06	4.1533E-06
M7									
M8									
M9									
R	0.99999	1	0.99999	1	1	1	1	1	1

Figure 4.13d: Received Signal Magnitude (dB) for Drywall Panels (relative to free space).
 D25H = 6 mm; D50H = 13 mm; D625H = 16 mm
 Dotted Curves represent +/- 1 standard deviation from mean (Solid Curves).
 High Range Data: 3.0 to 8.0 GHz



BLANK PAGE

4.14 Glass

The following four tables (4.14a through 4.14d) present the frequency response spectrum for silica float glass panels (typical architectural window glass). The specimens in this series bear the designation GXXL and GXXH, where the “XX” defines the specimen thickness in inches, and the L and H denote “low” (0.5 to 2.0 GHz) and “high” (3.0 to 8.0 GHz) frequency bandwidths.

Three specimen thicknesses, 6 mm, 13 mm, and 19 mm were tested. The average material density was 2.49 g/cc.

Figures 4.14a and 4.14b cover the band from 0.5 to 2.0 GHz, while Figures 4.14c and 4.14d are for the range 3.0 to 8.0 GHz. The ordinate values represent the ratio of the received to transmitted signal. The decimal attenuation values are presented first, followed by the same ordinate set converted to decibels.

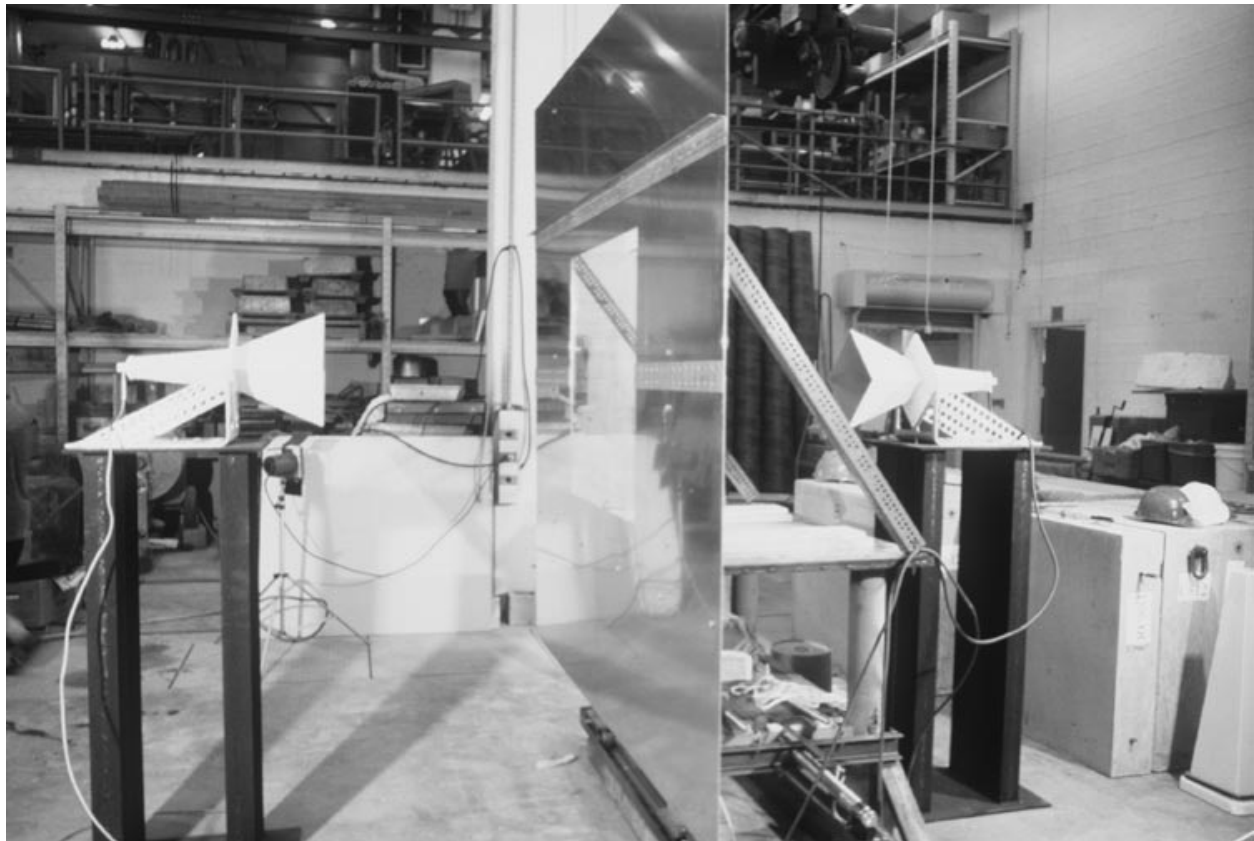

Figure 4.14: Test setup for specimen G75H (19 mm thick silica float glass panel) for frequency response determination from 3.0 to 8.0 GHz. See Figures 4.14c and 4.14d.

Table 4.14a: Regression Coefficients (decimal) for Glass Transmission versus Frequency Curves Plotted in Figure 4.14a. The regression equation is of the form Transmission Coefficient = M0+M1*F+M2*F^2+M3*F^3+M4*F^4+M5*F^5+M6*F^6 etc. where F is the frequency in GHz. The correlation coefficient, R, is defined in the text. Data are for the Frequency Range 0.5 to 2.0 GHz.

Drywall Attenuation Curves (0.5 to 2.0 GHz)									
Curve Identification									
Coefficient	G25L	G25L + sigma	G25L - sigma	G50L	G50L + sigma	G50L - sigma	G75L	G75L + sigma	G75L - sigma
	Decimal	Decimal	Decimal	Decimal	Decimal	Decimal	Decimal	Decimal	Decimal
M0	1.1348E+00	1.1684	1.1011E+00	1.0531E+00	1.0393E+00	1.0669E+00	9.3305E-01	9.3003E-01	9.3608E-01
M1	-5.0150E-01	-7.2417E-01	-2.7884E-01	-6.5103E-01	-5.9802E-01	-7.0403E-01	-5.5790E-01	-5.5488E-01	-5.6091E-01
M2	5.7774E-01	1.1067E+00	4.8839E-02	8.2106E-01	7.4504E-01	8.9708E-01	7.2419E-01	7.4382E-01	7.0456E-01
M3	-4.8200E-01	-1.0649E+00	1.0088E-01	-7.3820E-01	-6.5504E-01	-8.2134E-01	-6.7911E-01	-6.9777E-01	-6.6044E-01
M4	2.3613E-01	5.8282E-01	-1.1057E-01	3.7675E-01	3.2360E-01	4.2989E-01	3.7057E-01	3.7817E-01	3.6298E-01
M5	-5.6425E-02	-1.6422E-01	5.1369E-02	-9.4567E-02	-7.7528E-02	-1.1160E-01	-1.0184E-01	-1.0365E-01	-1.0002E-01
M6	4.4928E-03	1.8198E-02	-9.2124E-03	8.5765E-03	6.4328E-03	1.0720E-02	1.0703E-02	1.0928E-02	1.0478E-02
M7									
M8									
M9									
R	1	0.99999	1	1	1	1	1	1	1

Figure 4.14a: Transmission Coefficients for Glass Panels (relative to free space). Nominal thicknesses: G25L = 6 mm; G50L = 13 mm; G75L = 19 mm. Dotted Curves represent +/- 1 standard deviation from mean (Solid Curves). Low Range Data: 0.5 to 2.0 GHz

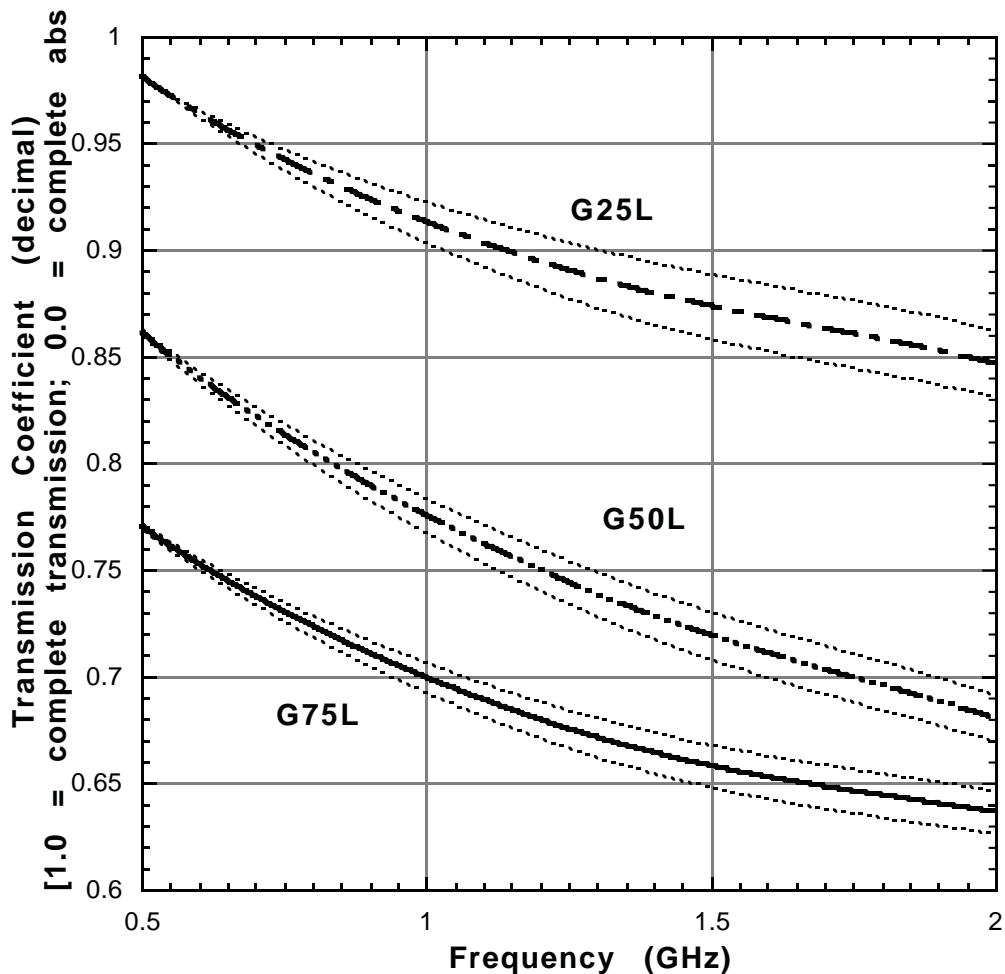

Table 4.14b: Regression Coefficients (dB) for Glass Transmission versus Frequency Curves Plotted in Figure 4.14b. The regression equation is of the form Received Signal Magnitude = $M_0 + M_1 * F + M_2 * F^2 + M_3 * F^3 + M_4 * F^4 + M_5 * F^5 + M_6 * F^6$, where F is the frequency in GHz. The correlation coefficient, R, is defined in the text. Data are for the Frequency Range 0.5 to 2.0 GHz.

Drywall Attenuation Curves (0.5 to 2.0 GHz)									
Curve Identification									
Coefficient	G25L dB	G25L + sigma dB	G25L - sigma dB	G50L dB	G50L + sigma dB	G50L - sigma dB	G75L dB	G75L + sigma dB	G75L - sigma dB
M0	1.1444E+00	1.4489	8.4091E-01	5.5734E-01	4.1902E-01	6.9685E-01	-4.8576E-01	-5.2131E-01	-4.4929E-01
M1	-4.1804E+00	-6.1723E+00	-2.1976E+00	-6.1539E+00	-5.6180E+00	-6.6977E+00	-6.0418E+00	-5.9921E+00	-6.0979E+00
M2	4.6468E+00	9.3273E+00	-3.0783E-03	7.5398E+00	6.7300E+00	8.3727E+00	7.8315E+00	7.9813E+00	7.7003E+00
M3	-3.8722E+00	-8.9783E+00	1.1898E+00	-6.7859E+00	-5.8482E+00	-7.7565E+00	-7.5311E+00	-7.6129E+00	-7.4755E+00
M4	1.8625E+00	4.8889E+00	-1.1357E+00	3.3498E+00	2.7485E+00	3.9725E+00	4.1246E+00	4.1251E+00	4.1408E+00
M5	-4.1623E-01	-1.3588E+00	5.1816E-01	-7.6848E-01	-5.8022E-01	-9.6312E-01	-1.1108E+00	-1.1074E+00	-1.1190E+00
M6	2.6245E-02	1.4666E-01	-9.3270E-02	5.5140E-02	3.2328E-02	7.8674E-02	1.1126E-01	1.1148E-01	1.1156E-01
M7									
M8									
M9									
R	1	0.99999	1	1	1	1	1	1	1

Figure 4.13b: Received Signal Magnitude (dB) for Glass Panels (relative to free space).
 G25L = 6 mm; G50L = 13 mm; G75L = 19 mm
 Dotted Curves represent +/- 1 standard deviation from mean (Solid Curves).
 Low Range Data: 0.5 to 2.0 GHz

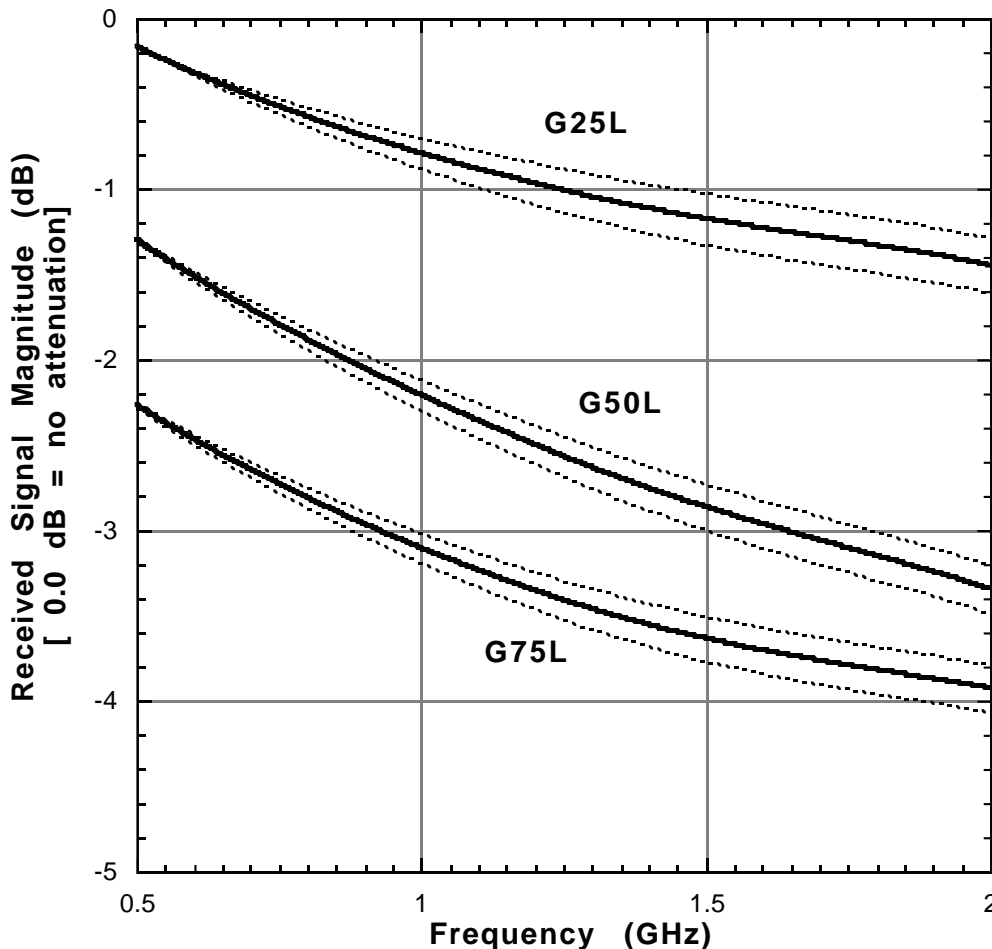

Table 4.14c: Regression Coefficients (decimal) for Glass Transmission versus Frequency Curves Plotted in Figure 4.14c. The regression equation is of the form Transmission Coefficient = M0+M1*F+M2*F^2+M3*F^3+M4*F^4+M5*F^5+M6*F^6 etc. where F is the frequency in GHz. The correlation coefficient, R, is defined in the text. Data are for the Frequency Range 3.0 to 8.0 GHz.

Drywall Attenuation Curves (3.0 to 8.0 GHz)									
Curve Identification									
Coefficient	G25L	G25L + sigma	G25L - sigma	G50L	G50L + sigma	G50L - sigma	G755L	G75L + sigma	G75L - sigma
	Decimal	Decimal	Decimal	Decimal	Decimal	Decimal	Decimal	Decimal	Decimal
M0	-2.8863E-01	-0.29862	-2.7864E-01	-2.2856E-01	-2.1475E-01	-2.4237E-01	-6.1924E-01	-6.1640E-01	-6.2206E-01
M1	1.0385E+00	1.0523E+00	1.0247E+00	1.2246E+00	1.2160E+00	1.2332E+00	1.4234E+00	1.4239E+00	1.4229E+00
M2	-4.5350E-01	-4.5982E-01	-4.4718E-01	-5.9079E-01	-5.8724E-01	-5.9435E-01	-6.2104E-01	-6.2104E-01	-6.2103E-01
M3	1.1776E-01	1.1936E-01	1.1615E-01	1.6438E-01	1.6359E-01	1.6517E-01	1.5583E-01	1.5588E-01	1.5579E-01
M4	-1.7566E-02	-1.7793E-02	-1.7339E-02	-2.5655E-02	-2.5558E-02	-2.5751E-02	-2.2182E-02	-2.2205E-02	-2.2160E-02
M5	1.3553E-03	1.3719E-03	1.3386E-03	2.0271E-03	2.0210E-03	2.0332E-03	1.6405E-03	1.6436E-03	1.6374E-03
M6	-4.1583E-05	-4.2080E-05	-4.1086E-05	-6.2768E-05	-6.2618E-05	-6.2919E-05	-4.8891E-05	-4.9022E-05	-4.8760E-05
M7									
M8									
M9									
R	0.99999	0.99999	0.99999	1	1	1	0.99999	0.99999	0.99999

Figure 4.14c: Transmission Coefficients for Glass Panels (relative to free space). Nominal thicknesses: G25H = 6 mm; G50H = 13 mm; G75H = 19 mm. Dotted Curves represent +/- 1 standard deviation from mean (Solid Curves). High Range Data: 3.0 to 8.0 GHz

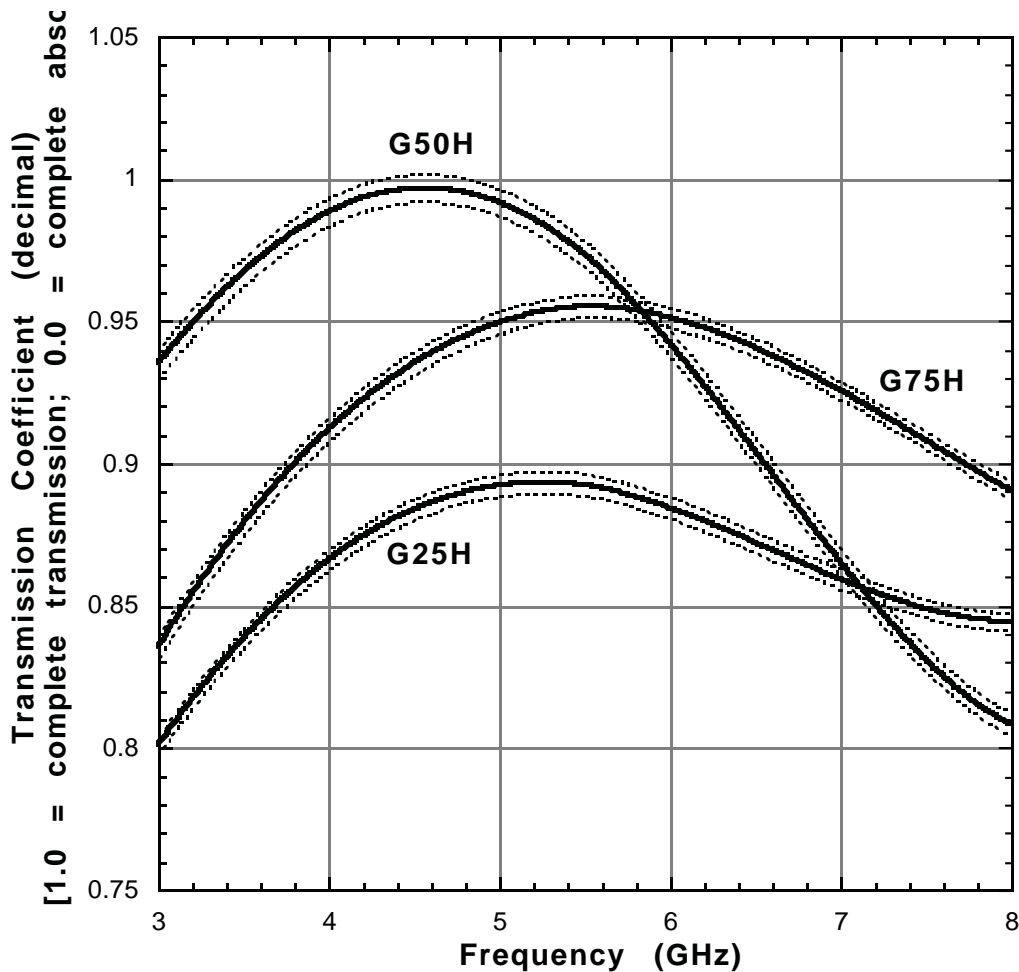
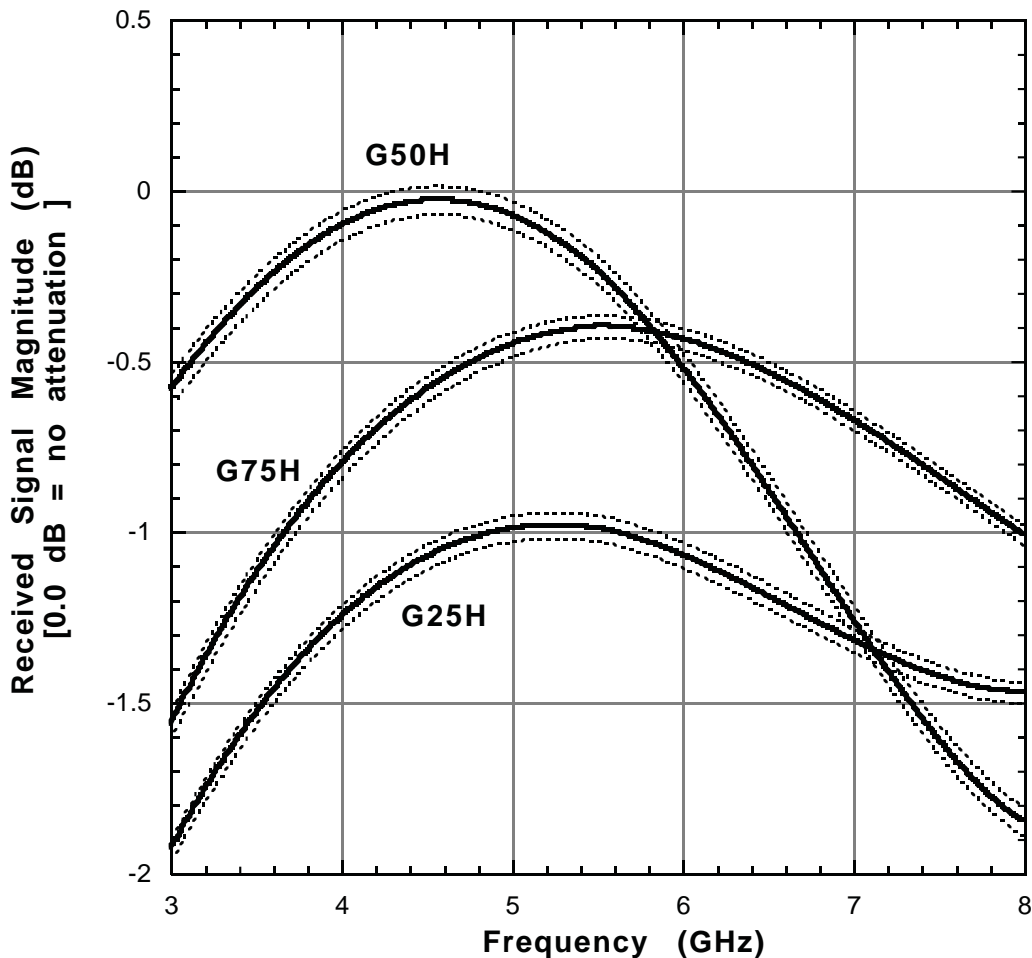

Table 4.14d: Regression Coefficients (dB) for Glass Transmission versus Frequency Curves Plotted in Figure 4.14d. The regression equation is of the form Received Signal Magnitude = $M_0 + M_1 * F + M_2 * F^2 + M_3 * F^3 + M_4 * F^4 + M_5 * F^5 + M_6 * F^6$, where F is the frequency in GHz. The correlation coefficient, R, is defined in the text. Data are for the Frequency Range 3.0 to 8.0 GHz.

Drywall Attenuation Curves (3.0 to 8.0 GHz)									
Curve Identification									
Coefficient	G25L dB	G25L + sigma dB	G25L - sigma dB	G50L dB	G50L + sigma dB	G50L - sigma dB	G755L dB	G75L + sigma dB	G75L - sigma dB
M0	-1.4824E+01	-14.878	-1.4768E+01	-1.2190E+01	-1.1992E+01	-1.2390E+01	-1.7088E+01	-1.7006E+01	-1.7171E+01
M1	1.2201E+01	1.2295E+01	1.2107E+01	1.1883E+01	1.1734E+01	1.2034E+01	1.4896E+01	1.4856E+01	1.4937E+01
M2	-5.1640E+00	-5.2059E+00	-5.1217E+00	-5.4546E+00	-5.3915E+00	-5.5186E+00	-6.2841E+00	-6.2665E+00	-6.3019E+00
M3	1.2814E+00	1.2915E+00	1.2712E+00	1.4330E+00	1.4183E+00	1.4479E+00	1.5197E+00	1.5157E+00	1.5237E+00
M4	-1.8346E-01	-1.8482E-01	-1.8209E-01	-2.1186E-01	-2.0995E-01	-2.1379E-01	-2.0985E-01	-2.0941E-01	-2.1030E-01
M5	1.3703E-02	1.3798E-02	1.3608E-02	1.5879E-02	1.5751E-02	1.6007E-02	1.5169E-02	1.5147E-02	1.5192E-02
M6	-4.0969E-04	-4.1242E-04	-4.0695E-04	-4.6484E-04	-4.6153E-04	-4.6819E-04	-4.4443E-04	-4.4402E-04	-4.4486E-04
M7									
M8									
M9									
R	0.99999	0.99999	0.99999	1	1	1	0.99999	0.99999	0.99999

Figure 4.13d: Received Signal Magnitude (dB) for Glass Panels (relative to free space).
 G25H = 6 mm; G50H = 13 mm; G75H = 19 mm
 Dotted Curves represent +/- 1 standard deviation from mean (Solid Curves).
 High Range Data: 3.0 to 8.0 GHz



BLANK PAGE

4.15 Lumber (Dry)

The following four tables (4.15a through 4.15d) present the response spectrum for lumber panels (fabricated from spruce-pine-fir grade material). The specimens in this series bear the designation LXXDL and LXXDH, where the “XX” defines the specimen thickness in inches, “D” is for dry, and the L and H denote “low” (0.5 to 2.0 GHz) and “high” (3.0 to 8.0 GHz) frequency bandwidths.

Four nominal specimen thicknesses, 38 mm, 76 mm, 114 mm, and 152 mm were tested.

The average material density (dry) varied from 0.409 (38 mm thickness) to 0.425 g/cc (152 mm thickness).

Figures 4.15a and 4.15b cover the band from 0.5 to 2.0 GHz, while Figures 4.15c and 4.15d are for the range 3.0 to 8.0 GHz. The ordinate values represent the ratio of the received to transmitted signal. The decimal attenuation values are presented first, followed by the same ordinate set converted to decibels.

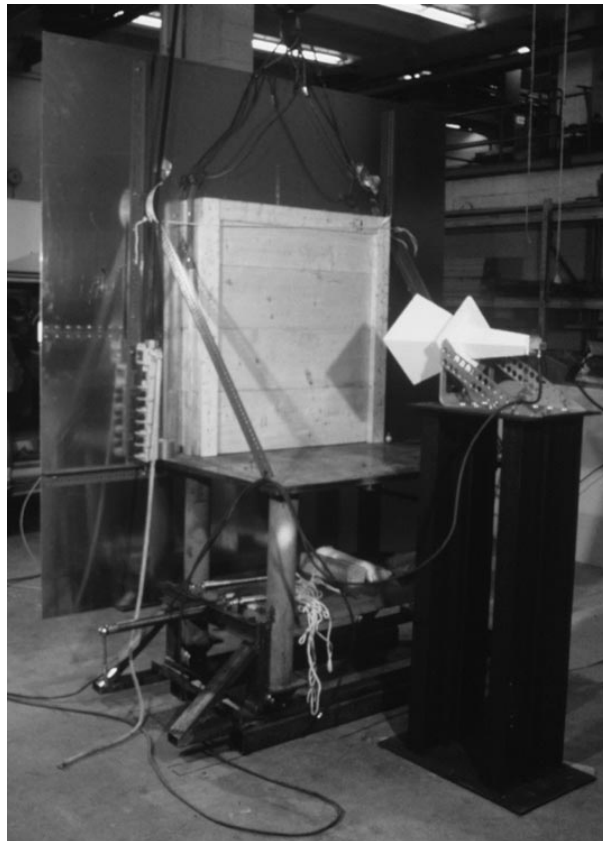

Figure 4.15: Test setup for specimen L45DH (114 mm thick spruce-pine-fir panel) for frequency response determination from 3.0 to 8.0 GHz. See Figures 4.15c and 4.15d.

Table 4.15a: Regression Coefficients (decimal) for Lumber (Spruce-Pine-Fir) (Dry) Transmission versus Frequency Curves Plotted in Figure 4.15a. The regression equation is of the form $\text{Transmission Coefficient} = M_0 + M_1 * F + M_2 * F^2 + M_3 * F^3 + M_4 * F^4 + M_5 * F^5 + M_6 * F^6$ etc. where F is the frequency in GHz. The correlation coefficient, R, is defined in the text. Data are for the Frequency Range 0.5 to 2.0 GHz.

Southern Pine (Dry) Attenuation Curves (0.5 to 2.0 GHz)												
Coefficient	Curve Identification											
	L15DL decimal	L15DL + sigma decimal	L15DL - sigma decimal	L30DL decimal	L30DL + sigma decimal	L30DL - sigma decimal	L45DL decimal	L45DL + sigma decimal	L45DL - sigma decimal	L60DL decimal	L60DL + sigma decimal	L60DL - sigma decimal
M0	9.5901E-01	0.8799	1.0381E+00	1.0967E+00	6.6067E-01	1.5328E+00	1.0438E+00	1.0630E+00	1.0246E+00	0.70229	0.6112	0.79339
M1	-6.7361E-01	-1.5271E-01	-1.1945E+00	-1.1459E+00	1.5488E+00	-3.8407E+00	-1.0973E+00	-1.1666E+00	-1.0280E+00	-0.1929	0.50888	-0.89468
M2	1.2281E+00	9.8449E-02	2.3577E+00	2.3858E+00	-3.8969E+00	8.6684E+00	2.2033E+00	2.5822E+00	1.8244E+00	0.0104	-1.8942	1.915
M3	-1.5147E+00	-3.5713E-01	-2.6722E+00	-2.9633E+00	4.2928E+00	-1.0219E+01	-2.8437E+00	-3.6361E+00	-2.0513E+00	-0.13737	2.3401	-2.6148
M4	9.9192E-01	3.8382E-01	1.6000E+00	1.8198E+00	-2.6144E+00	6.2540E+00	1.8338E+00	2.5558E+00	1.1119E+00	0.18676	-1.4812	1.8547
M5	-3.1470E-01	-1.5803E-01	-4.7137E-01	-5.2911E-01	8.4657E-01	-1.9048E+00	-5.6575E-01	-8.6565E-01	-2.6585E-01	-0.086031	0.47541	-0.64747
M6	3.8690E-02	2.3302E-02	5.4078E-02	5.8620E-02	-1.1231E-01	2.2955E-01	6.7384E-02	1.1412E-01	2.0647E-02	0.013748	-0.061096	0.088591
M7												
M8												
M9												
R	1	0.99999	0.99999	1	0.99999	0.99999	1	1	1	1	1	0.99999

Figure 4.15a: Transmission Coefficients for Lumber (Spruce-Pine-Fir) (Dry) Panels (relative to free space). Nominal thicknesses: L15DL = 38 mm; L30DL = 76 mm; L45DL = 114 mm; L60DL = 152 mm. Dotted Curves represent +/- 1 standard deviation from mean (Solid Curves). Low Range Data: 0.5 to 2.0 GHz

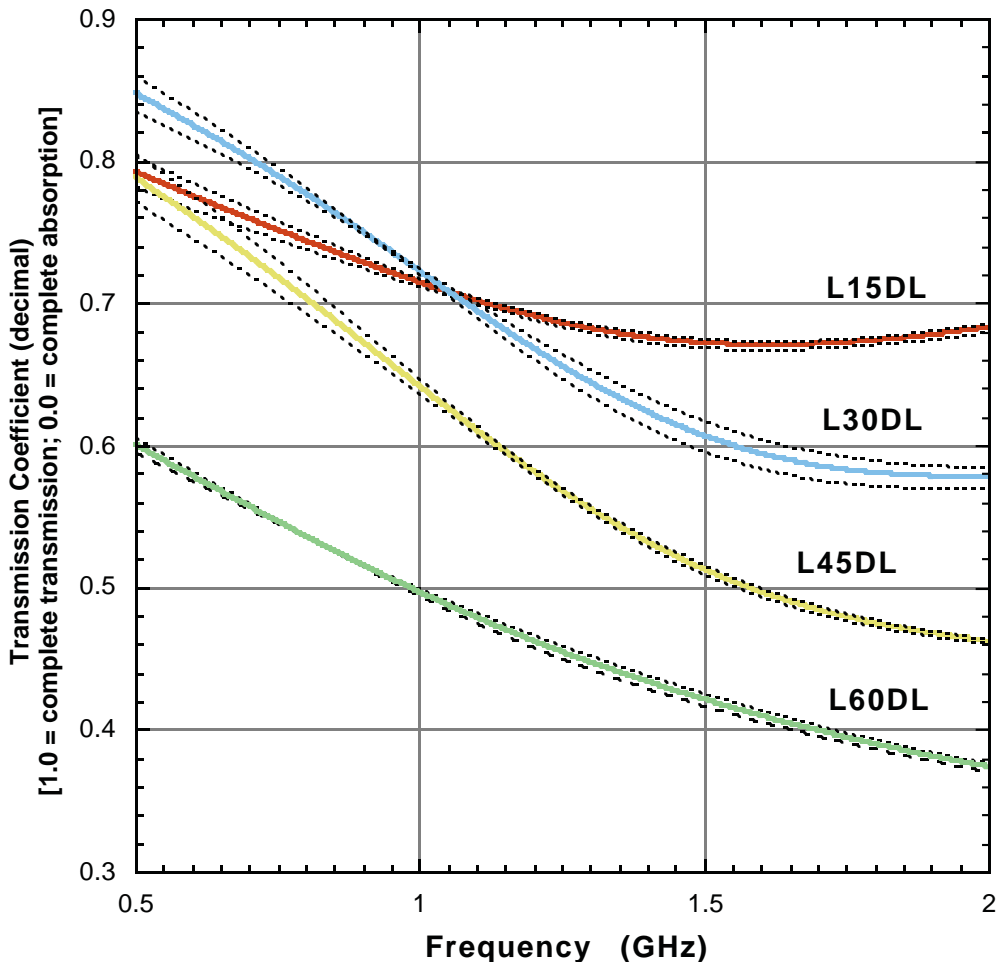

Table 4.15b: Regression Coefficients (dB) for Lumber (Spruce-Pine-Fir) (Dry) Transmission versus Frequency Curves Plotted in Figure 4.15b. The regression equation is of the form Received Signal Magnitude = M0+M1*F+M2*F^2+M3*F^3+M4*F^4+M5*F^5+M6*F^6, where F is the frequency in GHz. The correlation coefficient, R, is defined in the text. Data are for the Frequency Range 0.5 to 2.0 GHz.

Southern Pine (Dry) Attenuation Curves (0.5 to 2.0 GHz)												
Coefficient	Curve Identification			L30DL	L30DL + sigma	L30DL - sigma	L45DL	L45DL + sigma	L45DL - sigma	L60DL	L60DL + sigma	L60DL - sigma
	L15DL	L15DL + sigma	L15DL - sigma									
	dB	dB	dB	dB	dB	dB	dB	dB	dB	dB	dB	dB
M0	-3.7815E-02	-0.99962	9.3376E-01	1.3400E+00	-3.7974E+00	6.5128E+00	1.0902E+00	1.7270E+00	-4.6826E-01	-2.934	-4.8032	-1.0456
M1	-8.4443E+00	-2.3448E+00	-1.4619E+01	-1.2841E+01	1.8338E+01	-4.4237E+01	-1.4021E+01	-1.7810E+01	-1.0341E+01	-3.3868	10.035	-16.942
M2	1.6274E+01	3.3533E+00	2.9377E+01	2.6101E+01	-4.5579E+01	9.8259E+01	2.8164E+01	4.0526E+01	-1.6023E+01	2.7721	-32.384	38.268
M3	-2.0175E+01	-7.2370E+00	-3.3321E+01	-3.0397E+01	5.1258E+01	-1.1254E+02	-3.4100E+01	-5.3670E+01	-1.4723E+01	-6.2594	38.441	-51.38
M4	1.3042E+01	6.4411E+00	1.9765E+01	1.6748E+01	-3.2410E+01	6.6148E+01	1.9815E+01	3.5306E+01	4.3990E+00	5.5957	-23.991	35.451
M5	-4.0665E+00	-2.4365E+00	-5.7324E+00	-4.1246E+00	1.0884E+01	-1.9188E+01	-5.3377E+00	-1.1280E+01	5.9489E-01	-2.1818	7.6408	-12.09
M6	4.9020E-01	3.4087E-01	6.4375E-01	3.4943E-01	-1.4847E+00	2.1876E+00	5.3373E-01	1.4148E+00	-3.4778E-01	0.31941	-0.97486	1.6245
M7												
M8												
M9												
R	1	0.99999	0.99998	1	0.99999	0.99999	1	1	1	1	1	0.99999

Figure 4.15b: Received Signal Magnitude (dB) for Lumber (Spruce-Pine-Fir) (Dry) Panels (relative to free space).
 L15DL = 38 mm; L30DL = 76 mm; L45DL = 114 mm; L60DL = 152 mm
 Dotted Curves represent +/- 1 standard deviation from mean (Solid Curves).
 Low Range Data: 0.5 to 2.0 GHz

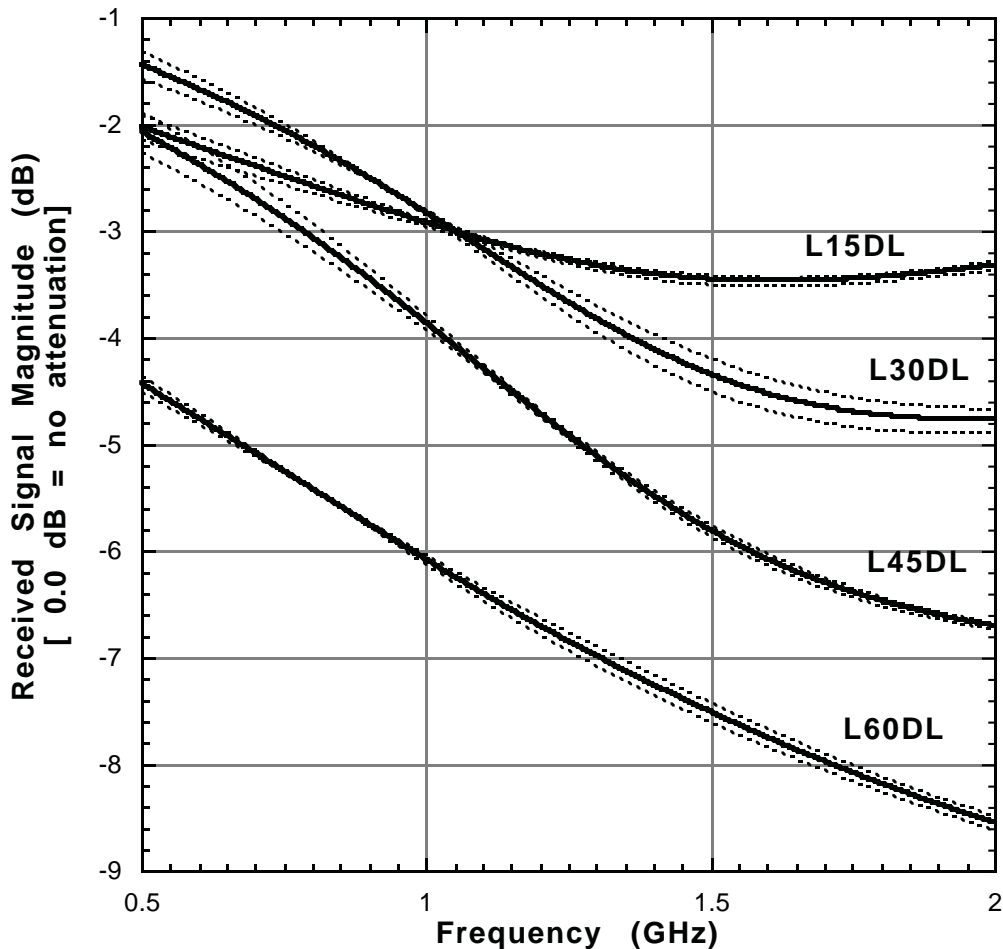

Table 4.15c: Regression Coefficients (decimal) for Lumber (Spruce-Pine-Fir) (Dry) Transmission versus Frequency Curves Plotted in Figure 4.15c. The regression equation is of the form $\text{Transmission Coefficient} = M_0 + M_1 * F + M_2 * F^2 + M_3 * F^3 + M_4 * F^4 + M_5 * F^5 + M_6 * F^6$ where F is the frequency in GHz. The correlation coefficient, R, is defined in the text. Data are for the Frequency Range 3.0 to 8.0 GHz.

Southern Pine (Dry) Attenuation Curves (3.0 to 8.0 GHz)												
Coefficient	Curve Identification			L30DH	L30DH + sigma	L30DH - sigma	L45DH	L45DH + sigma	L45DH - sigma	L60DH	L60DH + sigma	L60DH - sigma
	L15DH	L15DH + sigma	L15DH - sigma									
	decimal	decimal	decimal	decimal	decimal	decimal	decimal	decimal	decimal	decimal	decimal	decimal
M0	-1.6053E-01	-0.1402	-1.8087E-01	-1.1390E-01	-1.3643E-01	-9.1373E-02	2.6982E-03	1.6294E-02	-1.0895E-02	0.027905	-0.55338	0.60919
M1	7.7684E-01	7.5711E-01	7.9657E-01	5.0837E-01	5.5793E-01	4.5882E-01	2.2310E-01	2.2229E-01	2.2392E-01	0.10128	0.84398	-0.64141
M2	-3.5007E-01	-3.3793E-01	-3.6222E-01	-2.3602E-01	-2.6942E-01	-2.0261E-01	-1.0581E-01	-1.0439E-01	-1.0723E-01	-0.051557	-0.4363	0.33319
M3	9.4176E-02	9.0607E-02	9.7746E-02	6.3589E-02	7.4898E-02	5.2280E-02	2.9468E-02	2.9094E-02	2.9841E-02	0.015359	0.11931	-0.088593
M4	-1.4603E-02	-1.4048E-02	-1.5159E-02	-9.6970E-03	-1.1746E-02	-7.6483E-03	-4.7322E-03	-4.6898E-03	-4.7746E-03	-0.002721	-0.01815	0.012708
M5	1.1667E-03	1.1238E-03	1.2096E-03	7.5784E-04	9.4529E-04	5.7040E-04	3.8913E-04	3.8709E-04	3.9117E-04	0.00024545	0.0014365	-0.00094556
M6	-3.6915E-05	-3.5611E-05	-3.8219E-05	-2.3524E-05	-3.0289E-05	-1.6759E-05	-1.2625E-05	-1.2584E-05	-1.2665E-05	-8.57E-06	-4.59E-05	2.88E-05
M7												
M8												
M9												
R	0.99999	0.99999	0.99999	0.99999	0.99999	1	1	1	1	1	0.99999	0.99998

Figure 4.15c: Transmission Coefficients for Lumber (Spruce-Pine-Fir) (Dry) Panels (relative to free space). Nominal thicknesses: L15DH = 38 mm; L30DH = 76 mm; L45DH = 114 mm; L60DH = 152 mm. Dotted Curves represent +/- 1 standard deviation from mean (Solid Curves). High Range Data: 3.0 to 8.0 GHz

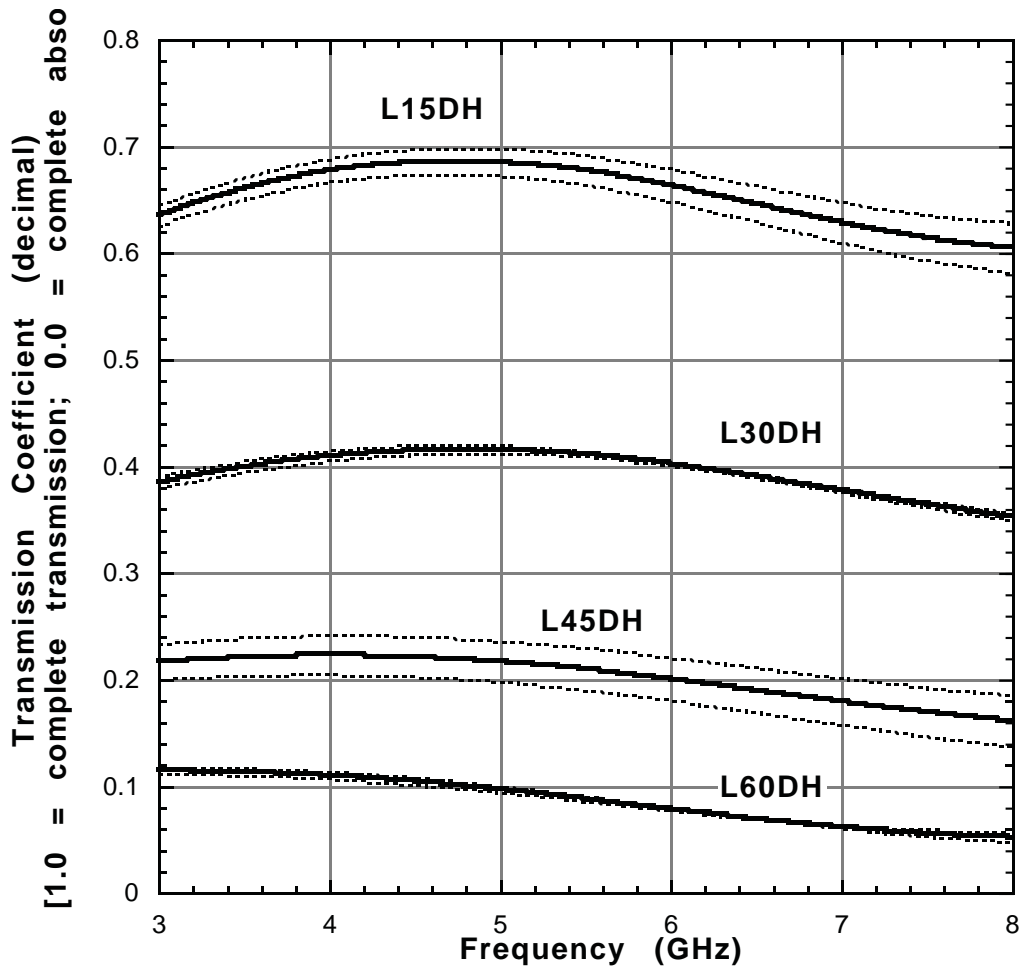
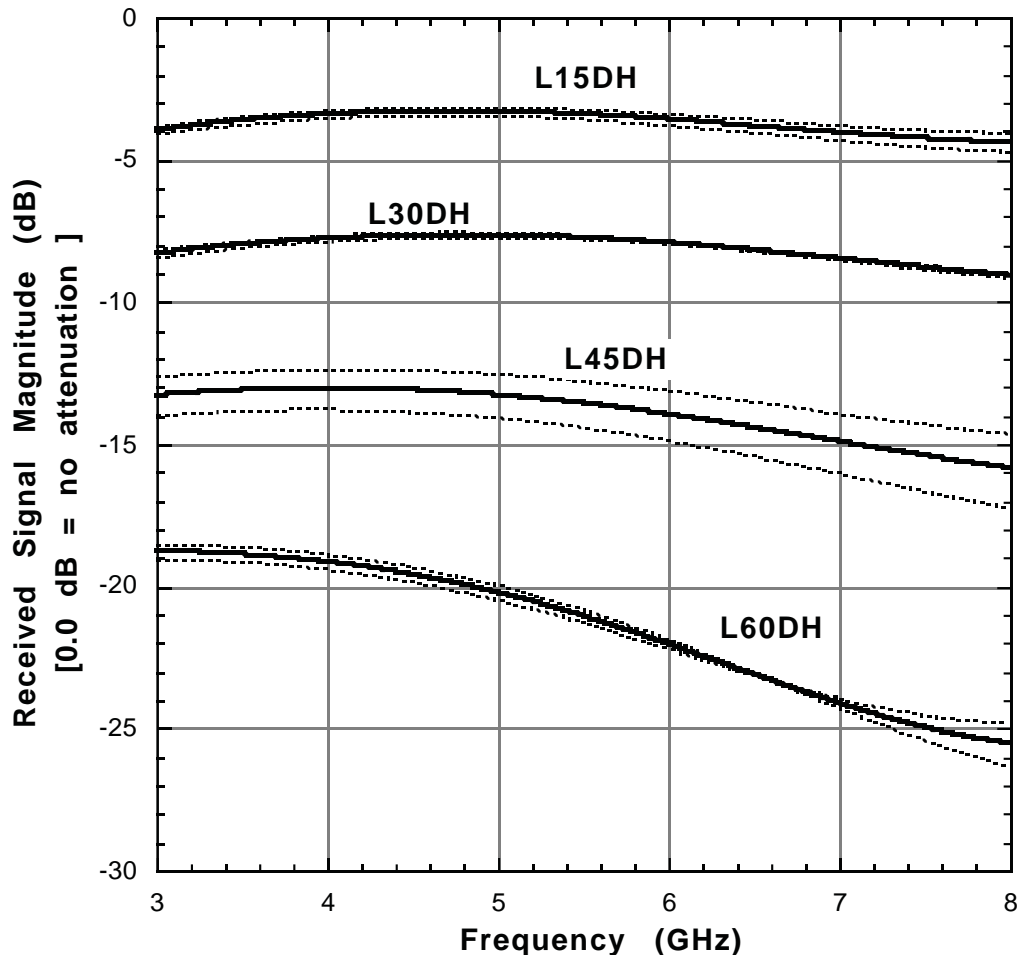

Table 4.15d: Regression Coefficients (dB) for Lumber (Spruce-Pine-Fir) (Dry) Transmission versus Frequency Curves Plotted in Figure 4.15d. The regression equation is of the form Received Signal Magnitude = M0+M1*F+M2*F^2+M3*F^3+M4*F^4+M5*F^5+M6*F^6, where F is the frequency in GHz. The correlation coefficient, R, is defined in the text. Data are for the Frequency Range 3.0 to 8.0 GHz.

Southern Pine (Dry) Attenuation Curves (3.0 to 8.0 GHz)												
Coefficient	Curve Identification			L30DH	L30DH + sigma	L30DH - sigma	L45DH	L45DH + sigma	L45DH - sigma	L60DH	L60DH + sigma	L60DH - sigma
	L15DH	L15DH + sigma	L15DH - sigma									
	dB	dB	dB	dB	dB	dB	dB	dB	dB	dB	dB	dB
M0	-1.6547E+01	-16.087	-1.7010E+01	-2.0122E+01	-2.1139E+01	-1.9108E+01	-2.4170E+01	-2.2925E+01	-2.5546E+01	-39.722	-122.06	44.041
M1	1.2399E+01	1.1961E+01	1.2837E+01	1.1806E+01	1.3596E+01	1.0015E+01	1.1601E+01	1.0823E+01	1.2481E+01	25.664	129.83	-80.242
M2	-5.4636E+00	-5.2319E+00	-5.6952E+00	-5.2732E+00	-6.3741E+00	-4.1711E+00	-5.4335E+00	-5.0375E+00	-5.8805E+00	-13.004	-66.517	41.368
M3	1.4022E+00	1.3393E+00	1.4649E+00	1.3594E+00	1.7045E+00	1.0137E+00	1.4424E+00	1.3394E+00	1.5582E+00	3.5173	17.838	-11.022
M4	-2.0711E-01	-1.9790E-01	-2.1623E-01	-1.9937E-01	-2.5806E-01	-1.4055E-01	-2.1806E-01	-2.0345E-01	-2.3446E-01	-0.53078	-2.6343	1.6025
M5	1.5876E-02	1.5207E-02	1.6532E-02	1.5069E-02	2.0182E-02	9.9424E-03	1.6930E-02	1.5891E-02	1.8095E-02	0.040883	0.20152	-0.12182
M6	-4.8509E-04	-4.6620E-04	-5.0340E-04	-4.5414E-04	-6.3196E-04	-2.7576E-04	-5.2171E-04	-4.9207E-04	-5.5528E-04	-1.24E-03	-6.22E-03	3.80E-03
M7												
M8												
M9												
R	0.99999	0.99999	0.99999	0.99999	0.99999	1	1	1	1	1	0.99998	0.99997

Figure 4.15d: Received Signal Magnitude (dB) for Lumber (Spruce-Pine-Fir) (Dry) Panels (relative to free space).
 L15DH = 38 mm; L30DH = 76 mm; L45DH = 114 mm; L60DH = 152 mm
 Dotted Curves represent +/- 1 standard deviation from mean (Solid Curves).
 High Range Data: 3.0 to 8.0 GHz



BLANK PAGE

4.16 Lumber (Wet)

The following four tables (4.16a through 4.16d) present the frequency response spectrum for lumber panels (fabricated from spruce-pine-fir grade material). The specimens in this series bear the designation LXXWL and LXXWH, where the “XX” defines the specimen thickness in inches, the “W” is for wetted, and the L and H denote “low” (0.5 to 2.0 GHz) and “high” (3.0 to 8.0 GHz) frequency bandwidths.

Four nominal specimen thicknesses, 38 mm, 76 mm, 114 mm, and 152 mm were tested.

The average material density (dry) varied from 0.428 (38 mm thickness) to 0.432 g/cc (152 mm thickness). All specimens were soaked (see Section 3.6) and allowed to drip dry prior to testing.

Figures 4.16a and 4.16b cover the band from 0.5 to 2.0 GHz, while Figures 4.16c and 4.16d are for the range 3.0 to 8.0 GHz. The ordinate values represent the ratio of the received to transmitted signal. The decimal attenuation values are presented first, followed by the same ordinate set converted to decibels.

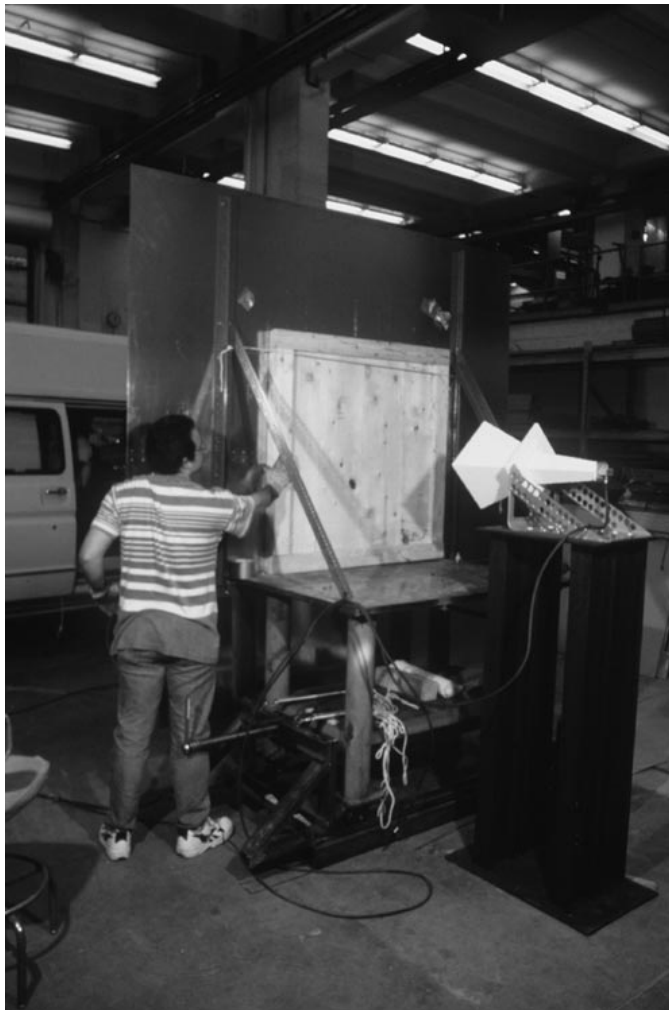

Figure 4.16: Adjusting the test setup for specimen L30WH (76 mm thick spruce-pine-fir panel, soaked) for frequency response determination from 3.0 to 8.0 GHz. See Figures 4.16c and 4.16d.

Table 4.16a: Regression Coefficients (decimal) for Lumber (Spruce-Pine-Fir) (Wet) Transmission versus Frequency Curves Plotted in Figure 4.16a. The regression equation is of the form Transmission Coefficient = M0+M1*F+M2*F^2+M3*F^3+M4*F^4+M5*F^5+M6*F^6 etc. where F is the frequency in GHz. The correlation coefficient, R, is defined in the text. Data are for the Frequency Range 0.5 to 2.0 GHz.

Southern Pine (Wet) Attenuation Curves (0.5 to 2.0 GHz)												
Coefficient	Curve Identification											
	L15WL decimal	L15WL + sigma decimal	L15WL - sigma decimal	L30WL decimal	L30WL + sigma decimal	L30WL - sigma decimal	L45WL decimal	L45WL + sigma decimal	L45WL - sigma decimal	L60WL decimal	L60WL + sigma decimal	L60WL - sigma decimal
M0	0.82917	0.8378	8.2054E-01	1.5830E+00	1.5221E+00	1.6440E+00	1.1196E+00	1.0745E+00	1.1648E+00	0.5885	0.4282	0.7488
M1	1.1303E-01	1.0732E-01	1.1873E-01	-3.1336E+00	-2.6777E+00	-3.5895E+00	-1.5041E+00	-1.1608E+00	-1.8474E+00	-0.02743	0.97531	-1.0302
M2	-3.7344E-01	-3.4554E-01	-4.0130E-01	5.8085E+00	4.6394E+00	6.9775E+00	3.1182E+00	2.3416E+00	3.8949E+00	-0.49513	-2.8042	1.814
M3	4.4380E-01	4.0972E-01	4.7782E-01	-6.1830E+00	-4.7250E+00	-7.6409E+00	-4.3139E+00	-3.4808E+00	-5.1470E+00	0.59934	3.2148	-2.0162
M4	-2.7125E-01	-2.5054E-01	-2.9194E-01	3.4540E+00	2.4928E+00	4.4151E+00	3.0586E+00	2.5872E+00	3.5300E+00	-0.3189	-1.8841	1.2463
M5	8.3517E-02	7.7323E-02	8.9701E-02	-9.4668E-01	-6.2403E-01	-1.2693E+00	-1.0456E+00	-9.0865E-01	-1.1825E+00	0.076928	0.55233	-0.39848
M6	-1.0280E-02	-9.5533E-03	-1.1005E-02	1.0027E-01	5.6856E-02	1.4369E-01	1.3817E-01	1.2201E-01	1.5433E-01	-0.006383	-0.064204	0.051439
M7												
M8												
M9												
R	0.99999	0.99999	0.99999	1	1	0.99999	1	1	1	1	0.99999	1

Figure 4.16a: Transmission Coefficients for Lumber (Spruce-Pine-Fir) (Wet) Panels (relative to free space). Nominal thicknesses: L15WL = 38 mm; L30WL = 76 mm; L45WL = 114 mm; L60WL = 152 mm. Dotted Curves represent +/- 1 standard deviation from mean (Solid Curves). Low Range Data: 0.5 to 2.0 GHz

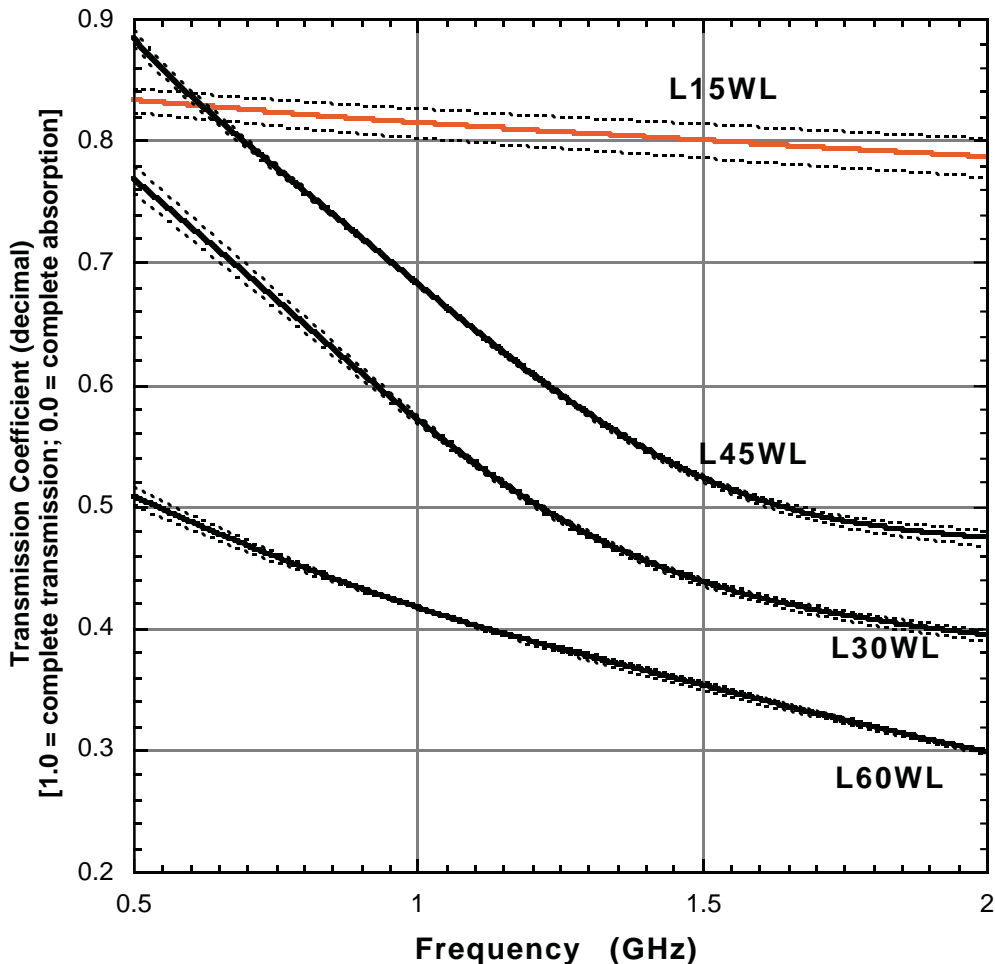

Table 4.16b: Regression Coefficients (dB) for Lumber (Spruce-Pine-Fir) (Wet) Transmission versus Frequency Curves Plotted in Figure 4.16b. The regression equation is of the form Received Signal Magnitude = M0+M1*F+M2*F^2+M3*F^3+M4*F^4+M5*F^5+M6*F^6, where F is the frequency in GHz. The correlation coefficient, R, is defined in the text. Data are for the Frequency Range 0.5 to 2.0 GHz.

Southern Pine (Wet) Attenuation Curves (0.5 to 2.0 GHz)												
Coefficient	Curve Identification			L30WL	L30WL + sigma	L30WL - sigma	L45WL	L45WL + sigma	L45WL - sigma	L60WL	L60WL + sigma	L60WL - sigma
	L15WL	L15WL + sigma	L15WL - sigma									
	dB	dB	dB	dB	dB	dB	dB	dB	dB	dB	dB	dB
M0	-1.6379E+00	-1.5452	-1.7318E+00	5.2482E+00	4.3055E+00	6.1990E+00	3.7409E+00	3.0867E+00	4.4101E+00	-4.8427	-8.1666	-1.4954
M1	1.2351E+00	1.1492E+00	1.3250E+00	-2.6780E+01	-2.0308E+01	-3.3310E+01	-3.0069E+01	-2.5626E+01	-3.4615E+01	0.92997	21.109	-19.411
M2	-4.0036E+00	-3.6454E+00	-4.3737E+00	4.6340E+01	2.9237E+01	6.1598E+01	6.7570E+01	5.8019E+01	7.7366E+01	-9.9686	-55.544	35.994
M3	4.7313E+00	4.3030E+00	5.1727E+00	-4.2576E+01	-2.2729E+01	-6.2622E+01	-8.7389E+01	-7.7467E+01	-9.7589E+01	9.9268	60.716	-41.306
M4	-2.8839E+00	-2.6255E+00	-3.1500E+00	1.8234E+01	5.1944E+00	3.1410E+01	5.7273E+01	5.1787E+01	6.2927E+01	-4.3506	-34.261	25.823
M5	8.8617E-01	8.0903E-01	9.6549E-01	-2.7354E+00	1.6494E+00	-7.1680E+00	-1.8263E+01	-1.6692E+01	-1.9887E+01	0.70746	9.644	-8.3072
M6	-1.0890E-01	-9.9835E-02	-1.1821E-01	-4.9102E-02	-6.4178E-01	5.5022E-01	2.2689E+00	2.0844E+00	2.4601E+00	-0.001346	-1.07	1.0765
M7												
M8												
M9												
R	0.99999	0.99999	0.99999	1	1	1	1	1	1	1	0.99999	1

Figure 4.16b: Received Signal Magnitude (dB) for Lumber (Spruce-Pine-Fir) (Wet) Panels (relative to free space).
 L15WL = 38 mm; L30WL = 76 mm; L45WL = 114 mm; L60WL = 152 mm
 Dotted Curves represent +/- 1 standard deviation from mean (Solid Curves).
 Low Range Data: 0.5 to 2.0 GHz

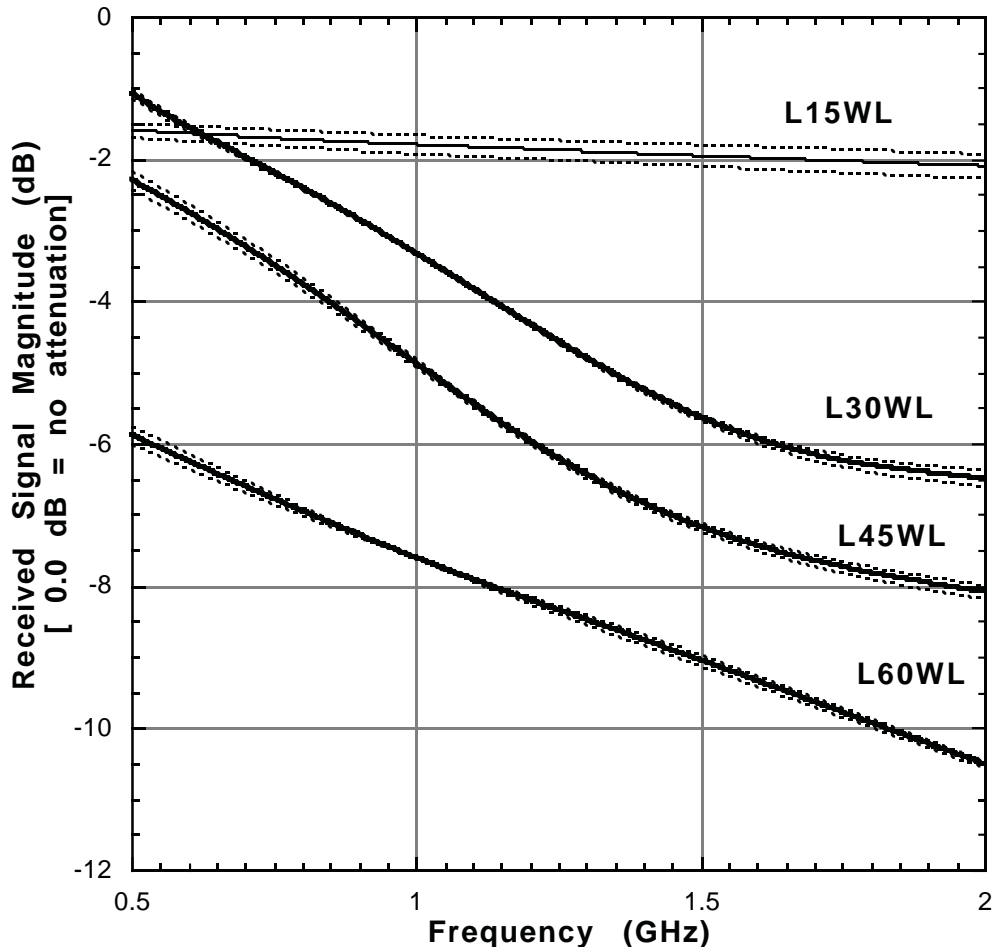

Table 4.16c: Regression Coefficients (decimal) for Lumber (Spruce-Pine-Fir) (Wet) Transmission versus Frequency Curves Plotted in Figure 4.16c. The regression equation is of the form Transmission Coefficient = M0+M1*F+M2*F^2+M3*F^3+M4*F^4+M5*F^5+M6*F^6 etc. where F is the frequency in GHz. The correlation coefficient, R, is defined in the text. Data are for the Frequency Range 3.0 to 8.0 GHz.

Southern Pine (Wet) Attenuation Curves (3.0 to 8.0 GHz)												
Coefficient	L15WH		L30WH		L45WH		L60WH		L15WH		L30WH	
	decimal	sigma	decimal	sigma	decimal	sigma	decimal	sigma	decimal	sigma	decimal	sigma
M0	-5.1516E-01	-0.5695	-4.6082E-01	-1.0443E-01	-4.4426E-01	2.3541E-01	-2.2519E-02	-2.7090E-02	-1.7948E-02	-0.0024898	-0.034619	0.029639
M1	1.0381E+00	1.0963E+00	9.7992E-01	2.9343E-01	7.0730E-01	-1.2044E-01	1.2780E-01	1.3997E-01	1.1564E-01	0.053956	0.096654	0.011259
M2	-5.0131E-01	-5.2291E-01	-4.7972E-01	-1.4270E-01	-3.4337E-01	5.7961E-02	-6.5971E-02	-7.1493E-02	-6.0450E-02	-0.027229	-0.049981	-0.0044763
M3	1.4337E-01	1.4687E-01	1.3987E-01	4.1823E-02	9.1866E-02	-8.2199E-03	1.9824E-02	2.1421E-02	1.8228E-02	0.0081103	0.014416	0.0018047
M4	-2.2760E-02	-2.2794E-02	-2.2726E-02	-6.9503E-03	-1.3652E-02	-2.4865E-04	-3.3180E-03	-3.5615E-03	-3.0746E-03	-0.0013754	-0.0023315	-0.00041928
M5	1.8207E-03	1.7813E-03	1.8602E-03	5.8470E-04	1.0369E-03	1.3252E-04	2.7643E-04	2.9458E-04	2.5828E-04	0.00011554	0.0001905	4.06E-05
M6	-5.7089E-05	-5.4657E-05	-5.9521E-05	-1.9244E-05	-3.1108E-05	-7.3796E-06	-8.9116E-06	-9.4551E-06	-8.3682E-06	-3.71E-06	-6.07E-06	-1.34E-06
M7												
M8												
M9												
R	0.99999	0.99999	0.99998	0.99999	0.99995	0.99985	1	1	1	1	1	1

Figure 4.16c: Transmission Coefficients for Lumber (Spruce-Pine-Fir) (Wet) Panels (relative to free space). Nominal thicknesses: L15WH = 38 mm; L30WH = 76 mm; L45WH = 114 mm; L60WH = 152 mm. Dotted Curves represent +/- 1 standard deviation from mean (Solid Curves). High Range Data: 3.0 to 8.0 GHz

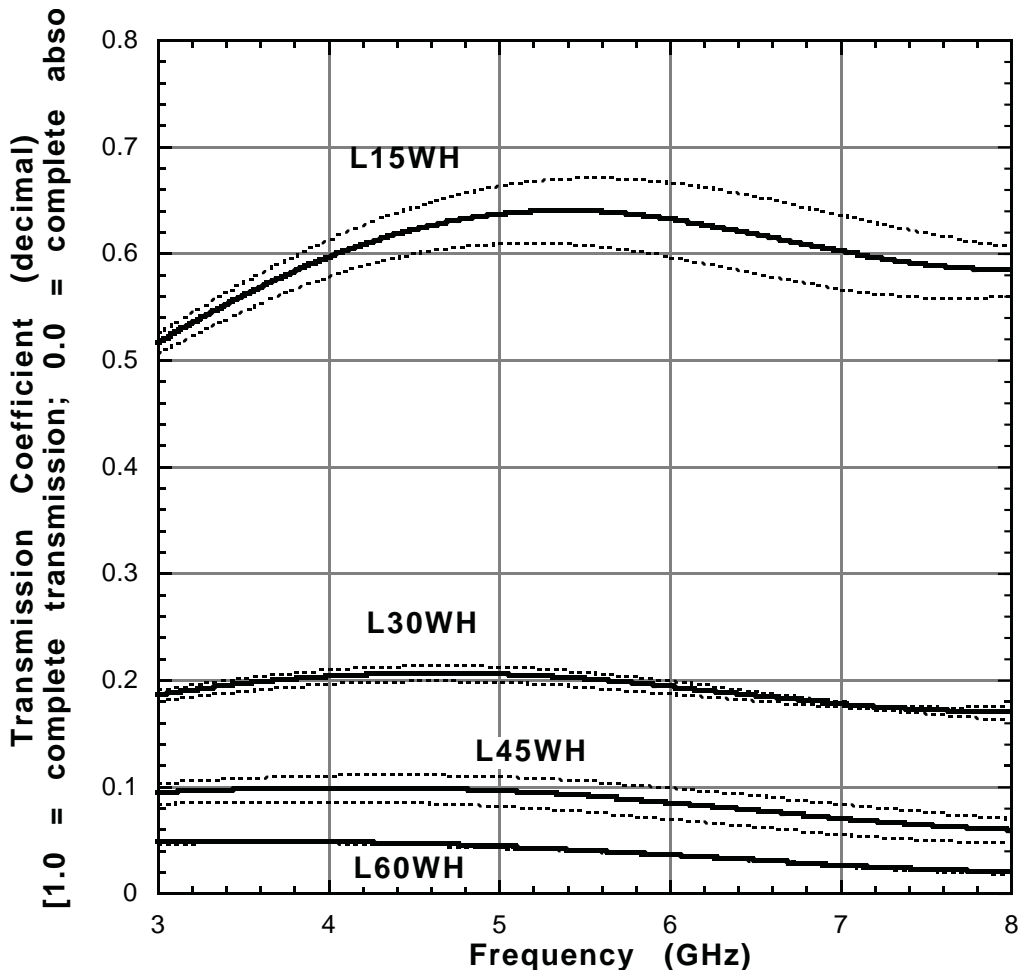
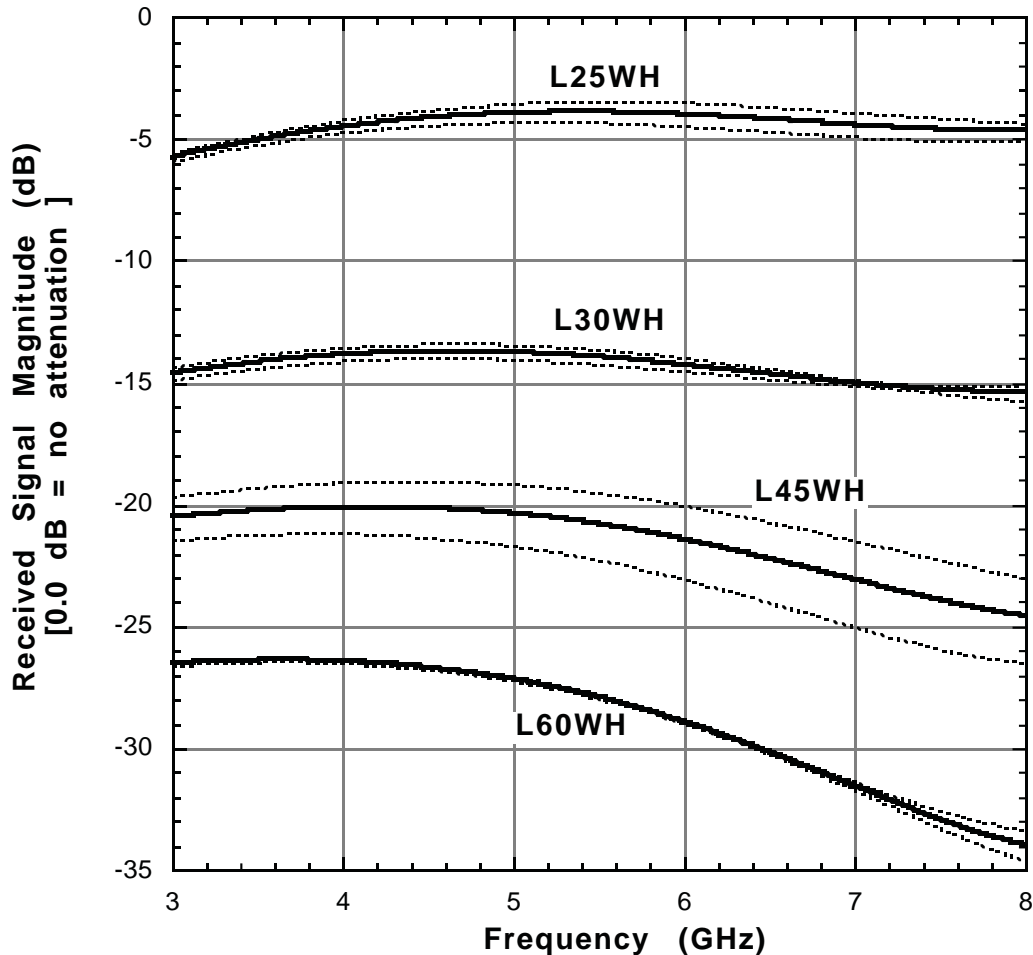

Table 4.16d: Regression Coefficients (dB) for Lumber (Spruce-Pine-Fir) (Wet) Transmission versus Frequency Curves Plotted in Figure 4.16d. The regression equation is of the form Received Signal Magnitude = M0+M1*F+M2*F^2+M3*F^3+M4*F^4+M5*F^5+M6*F^6, where F is the frequency in GHz. The correlation coefficient, R, is defined in the text. Data are for the Frequency Range 3.0 to 8.0 GHz.

Southern Pine (Wet) Attenuation Curves (3.0 to 8.0 GHz)												
Coefficient	Curve Identification											
	L15WH	L15WH + sigma	L15WH - sigma	L30WH	L30WH + sigma	L30WH - sigma	L45WH	L45WH + sigma	L45WH - sigma	L60WH	L60WH + sigma	L60WH - sigma
	dB											
M0	-2.4127E+01	-23.007	-2.5726E+01	-3.3675E+01	-4.7522E+01	-1.9352E+01	-3.3121E+01	-3.1267E+01	-3.5990E+01	-29.032	-42.859	-15.978
M1	1.7162E+01	1.5642E+01	1.9324E+01	1.9658E+01	3.6289E+01	2.4386E+00	1.3001E+01	1.1461E+01	1.5680E+01	0.013127	17.649	-16.597
M2	-7.4272E+00	-6.5329E+00	-8.6725E+00	-9.1433E+00	-1.7010E+01	-9.8940E-01	-6.0203E+00	-5.2200E+00	-7.3560E+00	1.1032	-7.9784	9.6254
M3	1.9329E+00	1.6662E+00	2.3000E+00	2.4510E+00	4.3448E+00	4.8597E-01	1.5954E+00	1.4003E+00	1.9127E+00	-0.48865	1.9399	-2.7567
M4	-2.8797E-01	-2.4385E-01	-3.4788E-02	-3.7372E-01	-6.1530E-01	-1.2287E-01	-2.3610E-01	-2.1145E-01	-2.7472E-01	0.10049	-0.25444	0.42987
M5	2.2031E-02	1.8285E-02	2.7059E-02	2.9349E-02	4.4547E-02	1.3561E-02	1.7226E-02	1.5847E-02	1.9247E-02	-0.011401	0.015403	-0.036062
M6	-6.6578E-04	-5.4104E-04	-8.3228E-04	-9.1427E-04	-1.2710E-03	-5.4369E-04	-4.7452E-04	-4.5573E-04	-4.9550E-04	5.21E-04	-2.93E-04	1.26E-03
M7												
M8												
M9												
R	0.99999	0.99999	0.99999	0.99999	0.99992	0.99984	1	1	1	1	1	1

Figure 4.16d: Received Signal Magnitude (dB) for Lumber (Spruce-Pine-Fir) (Wet) Panels (relative to free space).
 L15WH = 38 mm; L30WH = 76 mm; L45WH = 114 mm; L60WH = 152 mm
 Dotted Curves represent +/- 1 standard deviation from mean (Solid Curves).
 High Range Data: 3.0 to 8.0 GHz



BLANK PAGE

4.17 Plywood (Dry)

The following four tables (4.17a through 4.17d) present the frequency response spectrum for plywood panels. The specimens in this series bear the designation PXXDL and PXXDH, where the “XX” defines the specimen thickness in inches, “D” for dry, and the L and H denote “low” (0.5 to 2.0 GHz) and “high” (3.0 to 8.0 GHz) frequency bandwidths.

Four nominal specimen thicknesses, 6 mm, 13 mm, 19 mm, and 32 mm were tested.

The average material density (dry) varied from 0.565 (6 mm thickness) to 0.465 g/cc (19 mm thickness).

Figures 4.17a and 4.17b cover the band from 0.5 to 2.0 GHz, while Figures 4.17c and 4.17d are for the range 3.0 to 8.0 GHz. The ordinate values represent the ratio of the received to transmitted signal. The decimal attenuation values are presented first, followed by the same ordinate set converted to decibels.



Figure 4.17: Test setup for specimen P50H (13 mm dry plywood panel) for frequency response determination from 3.0 to 8.0 GHz. See Figures 4.17c and 4.17d.

Table 4.17a: Regression Coefficients (decimal) for Plywood (Dry) Transmission versus Frequency Curves Plotted in Figure 4.17a. The regression equation is of the form $\text{Transmission Coefficient} = M_0 + M_1 * F + M_2 * F^2 + M_3 * F^3 + M_4 * F^4 + M_5 * F^5 + M_6 * F^6$ etc. where F is the frequency in GHz. The correlation coefficient, R, is defined in the text. Data are for the Frequency Range 0.5 to 2.0 GHz.

Southern Pine (Dry) Attenuation Curves (0.5 to 2.0 GHz)												
Coefficient	Curve Identification			P50DL	P50DL + sigma	P50DL - sigma	P75DL	P75DL + sigma	P75DL - sigma	P125DL	P125DL + sigma	P125DL - sigma
	P25DL	P25DL + sigma	P25DL - sigma									
	decimal	decimal	decimal	decimal	decimal	decimal	decimal	decimal	decimal	decimal	decimal	decimal
M0	1.0640E+00	1.0586	1.0693E+00	1.0607E+00	1.0392E+00	1.0822E+00	1.0293E+00	1.0115E+00	1.0471E+00	1.0427	1.0366	1.0488
M1	-1.9480E-01	-2.0136E-01	-1.8824E-01	-1.9577E-01	-1.1324E-01	-2.7831E-01	-1.7839E-01	-1.0433E-01	-2.5245E-01	-0.39032	-0.36903	-0.41163
M2	1.4377E-01	2.0014E-01	8.7404E-02	1.4143E-01	1.1263E-02	2.7161E-01	1.0333E-01	-1.4440E-02	2.2109E-01	0.452	0.42903	0.47499
M3	-1.0416E-01	-1.5899E-01	-4.9341E-02	-9.8323E-02	5.2038E-02	-2.4869E-01	-4.3341E-02	9.1697E-02	-1.7837E-01	-0.43949	-0.41076	-0.46825
M4	4.1431E-02	6.8583E-02	1.4281E-02	3.4895E-02	-6.1276E-02	1.3107E-01	-4.1308E-03	-9.0292E-02	8.2026E-02	0.25116	0.23078	0.27155
M5	-3.2702E-03	-1.1323E-02	4.7825E-03	-3.6758E-04	2.9967E-02	-3.0704E-02	1.2587E-02	3.9836E-02	-1.4660E-02	-0.070414	-0.063708	-0.077125
M6	-1.1922E-03	-1.0925E-04	-2.2752E-03	-1.6501E-03	-5.4140E-03	2.1141E-03	-3.3267E-03	-6.7284E-03	7.4775E-05	0.0074462	0.006607	0.0082861
M7												
M8												
M9												
R	1	1	1	1	1	1	1	1	1	1	1	1

Figure 4.17a: Transmission Coefficients for Plywood (Dry) Panels (relative to free space). Nominal thicknesses: P25DL = 6 mm; P50DL = 13 mm; P75DL = 19 mm; P125DL = 32 mm. Dotted Curves represent +/- 1 standard deviation from mean (Solid Curves). Low Range Data: 0.5 to 2.0 GHz

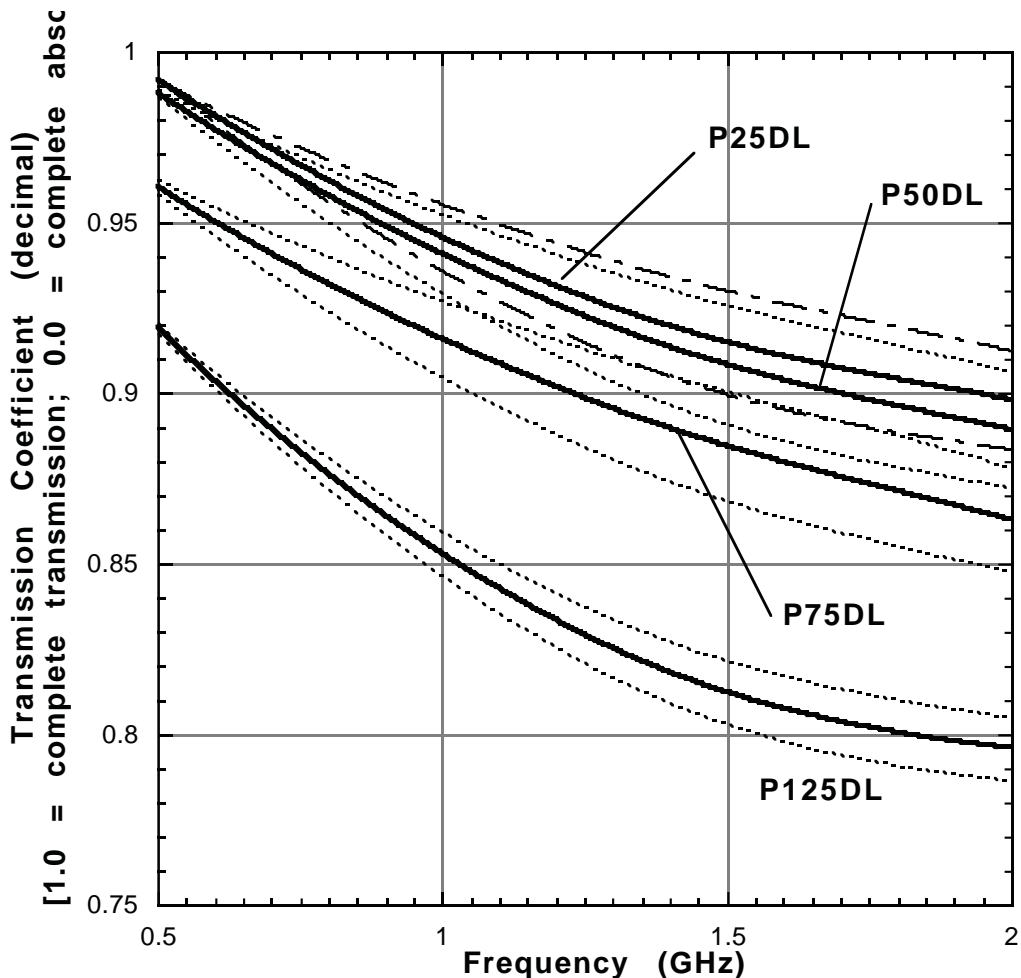

Table 4.17b: Regression Coefficients (dB) for Plywood (Dry) Transmission versus Frequency Curves Plotted in Figure 4.17b. The regression equation is of the form Received Signal Magnitude = $M_0 + M_1 * F + M_2 * F^2 + M_3 * F^3 + M_4 * F^4 + M_5 * F^5 + M_6 * F^6$, where F is the frequency in GHz. The correlation coefficient, R, is defined in the text. Data are for the Frequency Range 0.5 to 2.0 GHz.

Southern Pine (Dry) Attenuation Curves (0.5 to 2.0 GHz)												
Coefficient	Curve Identification			P50DL	P50DL + sigma	P50DL - sigma	P75DL	P75DL + sigma	P75DL - sigma	P125DL	P125DL + sigma	P125DL - sigma
	P25DL	P25DL + sigma	P25DL - sigma									
	dB	dB	dB	dB	dB	dB	dB	dB	dB	dB	dB	dB
M0	-5.4784E-01	0.50124	5.9586E-01	5.2046E-01	3.3170E-01	7.1115E-01	2.5407E-01	9.3873E-02	4.1607E-01	0.4172	0.35737	0.47769
M1	-1.6494E+00	-1.7001E+00	-1.6098E+00	-1.6566E+00	-9.2550E-01	-2.4008E+00	-1.5237E+00	-8.5406E-01	-2.2048E+00	-3.6322	-3.4135	-3.8551
M2	1.1830E+00	1.6349E+00	7.6405E-01	1.1466E+00	-3.4798E-02	2.3662E+00	7.7456E-01	-3.0824E-01	1.8885E+00	4.2968	4.0184	4.5867
M3	-8.7390E-01	-1.2808E+00	-5.1196E-01	-7.9810E-01	5.9151E-01	-2.2398E+00	-2.4793E-01	1.0152E+00	-1.5537E+00	-4.3415	-3.9734	-4.7253
M4	3.3208E-01	5.2435E-01	1.6743E-01	2.5451E-01	-6.3178E-01	1.1728E+00	-1.3730E-01	-9.4202E-01	6.9417E-01	2.5	2.2461	2.7635
M5	-9.7020E-03	-6.8722E-02	4.1569E-02	2.3782E-02	2.9992E-01	-2.6134E-01	1.5509E-01	4.0690E-01	-1.0442E-01	-0.6916	-0.61123	-0.77465
M6	-1.4473E-02	-5.9404E-03	-2.2189E-02	-1.9714E-02	-5.3422E-02	1.4941E-02	-3.7016E-02	-6.8001E-02	-5.1910E-03	0.070952	0.061315	0.080875
M7												
M8												
M9												
R	1	1	1	1	1	1	1	1	1	1	1	1

Figure 4.17b: Received Signal Magnitude (dB) for Plywood (Dry) Panels (relative to free space).
P25DL = 6 mm; P50DL = 13 mm; P75DL = 19 mm; P125DL = 32 mm
Dotted Curves represent +/- 1 standard deviation from mean (Solid Curves).
Low Range Data: 0.5 to 2.0 GHz

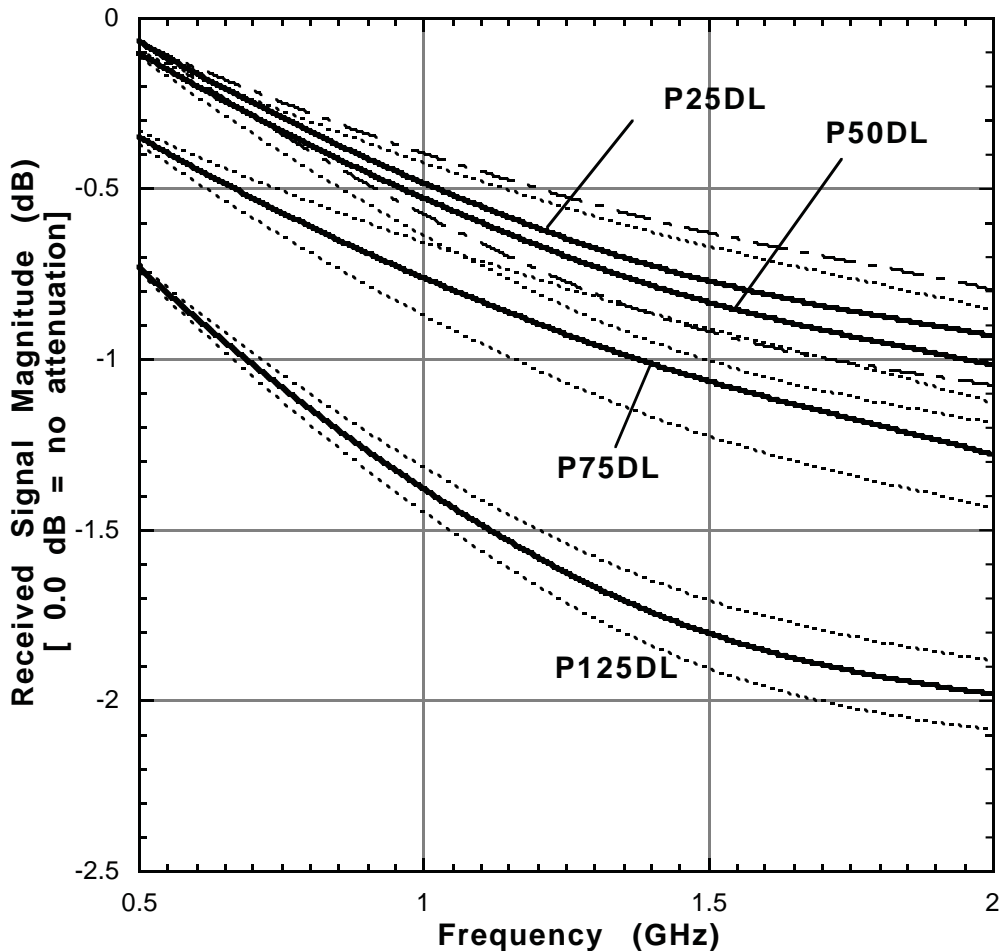

Table 4.17c: Regression Coefficients (decimal) for Plywood (Dry) Transmission versus Frequency Curves Plotted in Figure 4.17c. The regression equation is of the form $\text{Transmission Coefficient} = M_0 + M_1 \cdot F + M_2 \cdot F^2 + M_3 \cdot F^3 + M_4 \cdot F^4 + M_5 \cdot F^5 + M_6 \cdot F^6$ etc. where F is the frequency in GHz. The correlation coefficient, R, is defined in the text. Data are for the Frequency Range 3.0 to 8.0 GHz.

Southern Pine (Dry) Attenuation Curves (3.0 to 8.0 GHz)																						
Curve Identification	P25DH + sigma		P25DH - sigma		P50DH		P50DH + sigma		P50DH - sigma		P75DH		P75DH + sigma		P75DH - sigma		P125DH		P125DH + sigma		P125DH - sigma	
Coefficient	decimal	decimal	decimal	decimal	decimal	decimal	decimal	decimal	decimal	decimal	decimal	decimal	decimal	decimal	decimal	decimal	decimal	decimal	decimal	decimal	decimal	decimal
M0	-2.5942E-01	-0.25971	-2.5913E-01	-2.9631E-01	-3.0708E-01	-2.8556E-01	-3.4218E-01	-3.4493E-01	-3.3943E-01	-0.77519	-0.76401	-0.78638										
M1	1.1761E+00	1.1810E+00	1.1712E+00	1.2065E+00	1.2249E+00	1.1881E+00	1.2313E+00	1.2446E+00	1.2181E+00	1.4203	1.4006	1.44										
M2	-5.2085E-01	-5.2329E-01	-5.1842E-01	-5.3419E-01	-5.4267E-01	-5.2571E-01	-5.5401E-01	-5.6025E-01	-5.4776E-01	-0.64104	-0.62729	-0.65479										
M3	1.3813E-01	1.3873E-01	1.3754E-01	1.4034E-01	1.4243E-01	1.3825E-01	1.4561E-01	1.4724E-01	1.4398E-01	0.175	0.17035	0.17964										
M4	-2.1341E-02	-2.1416E-02	-2.1265E-02	-2.1311E-02	-2.1597E-02	-2.1025E-02	-2.1813E-02	-2.2052E-02	-2.1573E-02	-0.027135	-0.026321	-0.027949										
M5	1.7078E-03	1.7123E-03	1.7033E-03	1.6745E-03	1.6946E-03	1.6543E-03	1.6823E-03	1.7004E-03	1.6643E-03	0.0021554	0.0020844	0.0022265										
M6	-5.4157E-05	-5.4258E-05	-5.4057E-05	-5.2242E-05	-5.2812E-05	-5.1672E-05	-5.1546E-05	-5.2085E-05	-5.1007E-05	-6.77E-05	-6.53E-05	-7.02E-05										
M7																						
M8																						
M9																						
R	0.99999	0.99999	0.99999	0.99999	0.99999	0.99999	0.99999	0.99999	0.99999	0.99999	0.99999	0.99999										

Figure 4.17c: Transmission Coefficients for Plywood (Dry) Panels (relative to free space). Nominal thicknesses: P25DH = 6 mm; P50DH = 13 mm; P75DH = 19 mm; P125DH = 32 mm. Dotted Curves represent +/- 1 standard deviation from mean (Solid Curves). High Range Data: 3.0 to 8.0 GHz

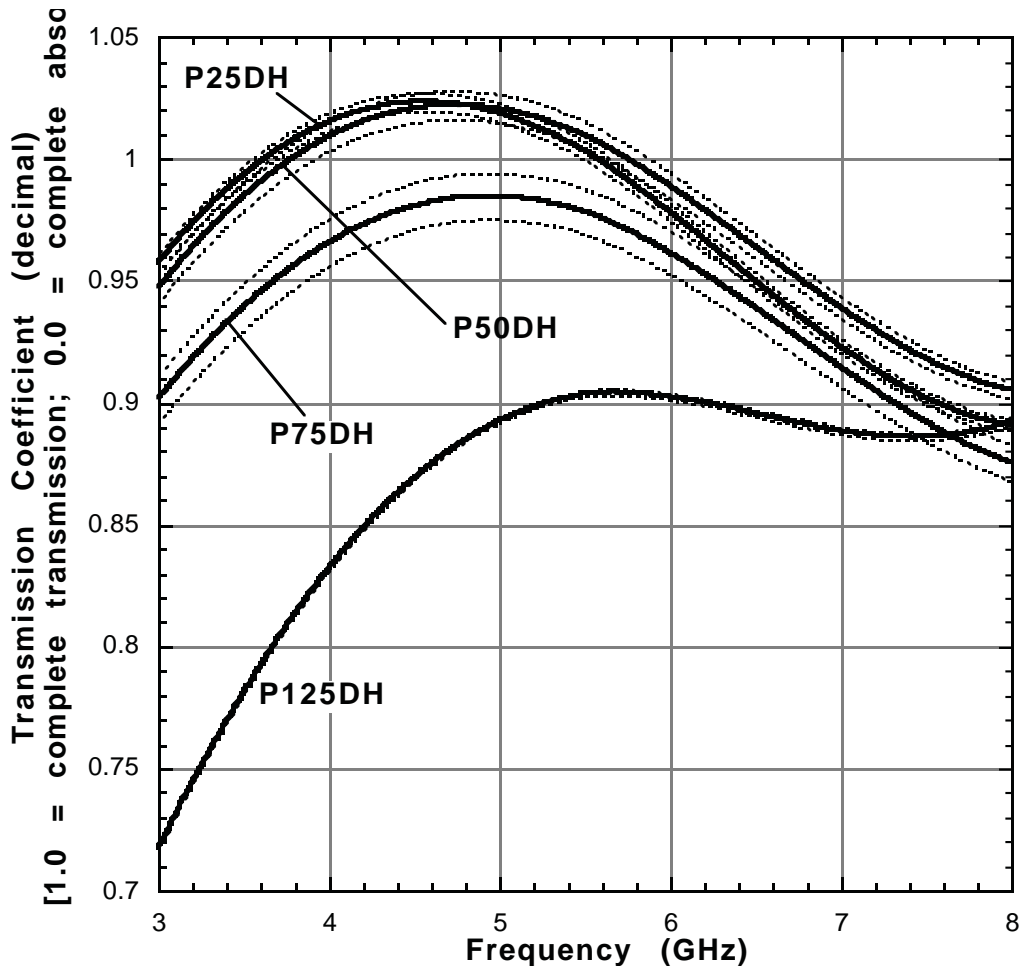
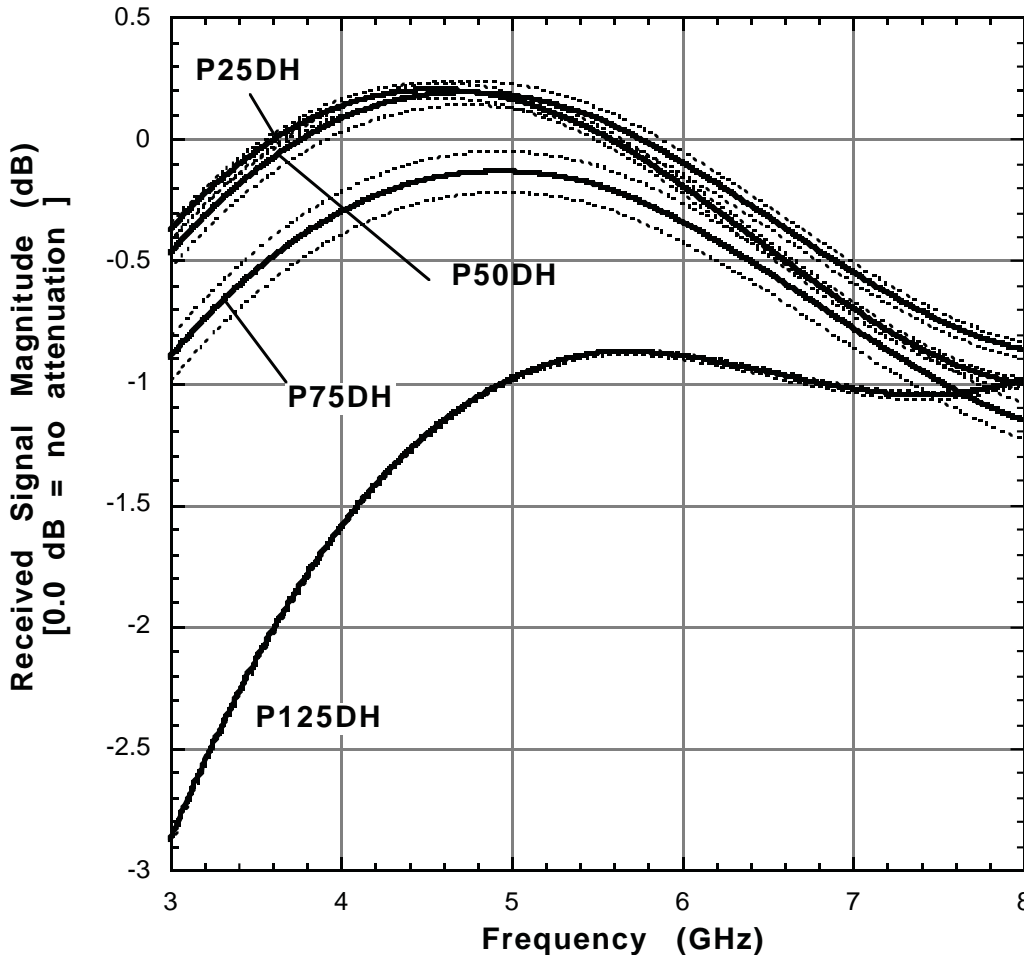

Table 4.17d: Regression Coefficients (dB) for Plywood (Dry) Transmission versus Frequency Curves Plotted in Figure 4.17d. The regression equation is of the form Received Signal Magnitude = $M_0 + M_1 * F + M_2 * F^2 + M_3 * F^3 + M_4 * F^4 + M_5 * F^5 + M_6 * F^6$, where F is the frequency in GHz. The correlation coefficient, R, is defined in the text. Data are for the Frequency Range 0.5 to 2.0 GHz.

Southern Pine (Dry) Attenuation Curves (3.0 to 8.0 GHz)												
Coefficient	Curve Identification			P50DH	P50DH + sigma	P50DH - sigma	P75DH	P75DH + sigma	P75DH - sigma	P125DH	P125DH + sigma	P125DH - sigma
	P25DH	P25DH + sigma	P25DH - sigma									
	dB	dB	dB	dB	dB	dB	dB	dB	dB	dB	dB	dB
M0	-1.3704E+01	-13.624	-1.3783E+01	-1.3497E+01	-1.3504E+01	-1.3489E+01	-1.3703E+01	-1.3598E+01	-1.3809E+01	-23.512	-23.382	-23.644
M1	1.3197E+01	1.3153E+01	1.3242E+01	1.2736E+01	1.2811E+01	1.2661E+01	1.2495E+01	1.2493E+01	1.2497E+01	19.042	18.84	19.247
M2	-5.8051E+00	-5.7850E+00	-5.8254E+00	-5.5360E+00	-5.5706E+00	-5.5008E+00	-5.4318E+00	-5.4346E+00	-5.4291E+00	-7.9679	-7.8332	-8.1035
M3	1.4778E+00	1.4722E+00	1.4834E+00	1.3948E+00	1.4026E+00	1.3867E+00	1.3660E+00	1.3668E+00	1.3651E+00	1.9912	1.9465	2.0361
M4	-2.1707E-01	-2.1614E-01	-2.1800E-01	-2.0241E-01	-2.0334E-01	-2.0147E-01	-1.9646E-01	-1.9657E-01	-1.9635E-01	-0.28871	-0.28094	-0.29652
M5	1.6594E-02	1.6512E-02	1.6676E-02	1.5281E-02	1.5332E-02	1.5228E-02	1.4632E-02	1.4636E-02	1.4628E-02	0.021917	0.021241	0.022595
M6	-5.0589E-04	-5.0306E-04	-5.0876E-04	-4.6046E-04	-4.6149E-04	-4.5940E-04	-4.3452E-04	-4.3446E-04	-4.3458E-04	-0.00066748	-0.00064438	-0.00069069
M7												
M8												
M9												
R	1	1	1	0.99999	0.99999	0.99999	0.99999	0.99999	0.99999	0.99999	0.99999	0.99999

Figure 4.17d: Received Signal Magnitude (dB) for Plywood (Dry) Panels (relative to free space).
P25DH = 6 mm; P50DH = 13 mm; P75DH = 19 mm; P125DH = 32 mm
Dotted Curves represent +/- 1 standard deviation from mean (Solid Curves).
High Range Data: 3.0 to 8.0 GHz



BLANK PAGE

4.18 Plywood (Wet)

The following four tables (4.18a through 4.18d) present the frequency response spectrum for plywood panels. The specimens in this series bear the designation PXXWL and PXXWH, where the “XX” defines the specimen thickness in inches, “W” for wetted, and the L and H denote “low” (0.5 to 2.0 GHz) and “high” (3.0 to 8.0 GHz) frequency bandwidths.

Four nominal specimen thicknesses, 6 mm, 13 mm, 19 mm, and 32 mm were tested. The average material density (dry) varied from 0.563 (6 mm thickness) to 0.450 g/cc (19 mm thickness). All

specimens were

soaked (see Section 3.6) and allowed to drip dry prior to testing.

Figures 4.18a and 4.18b cover the band from 0.5 to 2.0 GHz, while Figures 4.18c and 4.18d are for the range 3.0 to 8.0 GHz. The ordinate values represent the ratio of the received to transmitted signal. The decimal attenuation values are presented first, followed by the same ordinate set converted to decibels.

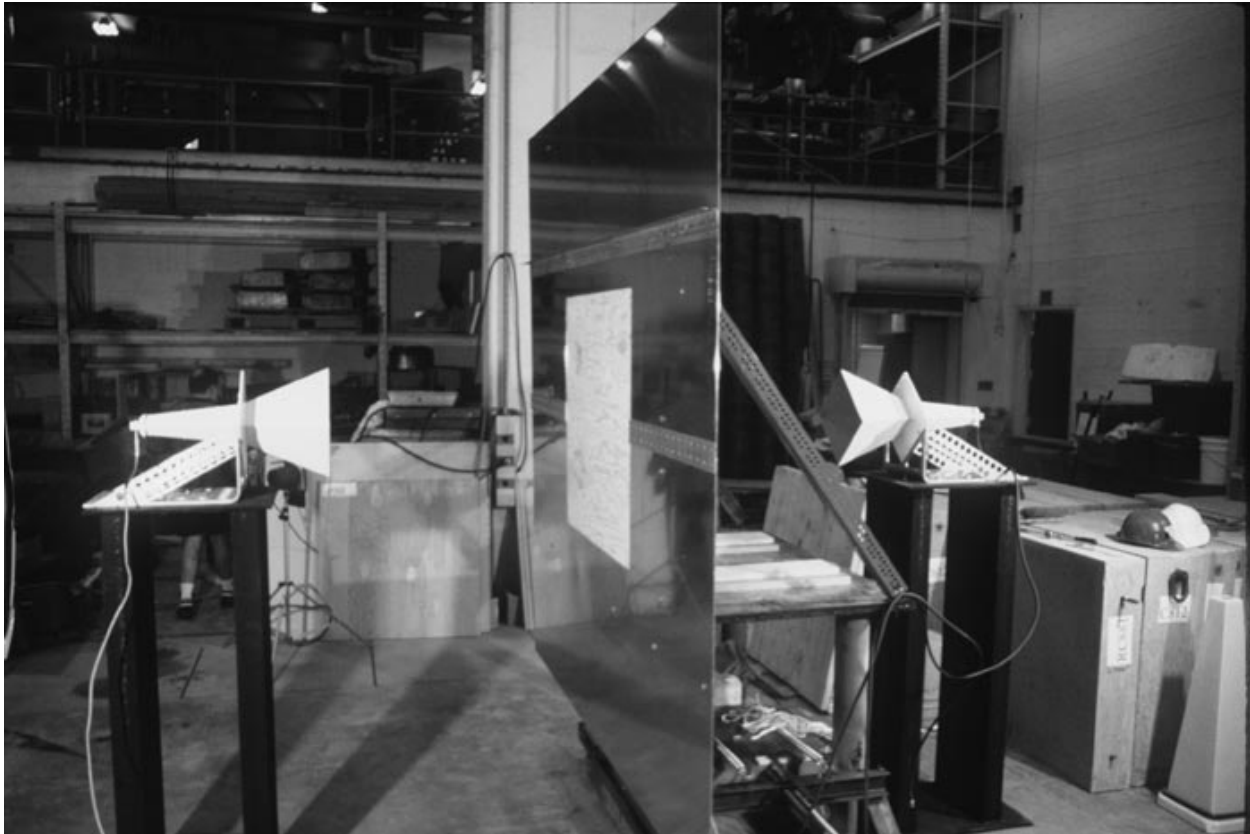

Figure 4.18: Test setup for specimen P50WH (13 mm wetted plywood panel) for frequency response determination from 3.0 to 8.0 GHz. See Figures 4.18c and 4.18d.

Table 4.18a: Regression Coefficients (decimal) for Plywood (Wet) Transmission versus Frequency Curves Plotted in Figure 4.18a. The regression equation is of the form $\text{Transmission Coefficient} = M_0 + M_1 * F + M_2 * F^2 + M_3 * F^3 + M_4 * F^4 + M_5 * F^5 + M_6 * F^6$ etc. where F is the frequency in GHz. The correlation coefficient, R, is defined in the text. Data are for the Frequency Range 0.5 to 2.0 GHz.

Southern Pine (Wet) Attenuation Curves (0.5 to 2.0 GHz)												
Curve Identification	P25WL + sigma			P25WL - sigma			P50WL			P75WL		
Coefficient	P25WL + sigma decimal	P25WL - sigma decimal	P25WL decimal	P50WL + sigma decimal	P50WL - sigma decimal	P50WL decimal	P75WL + sigma decimal	P75WL - sigma decimal	P75WL decimal	P125WL + sigma decimal	P125WL - sigma decimal	P125WL decimal
M0	1.0715E+00	1.0596	1.0835E+00	1.0104E+00	9.9931E-01	1.0215E+00	1.0216E+00	1.0396E+00	1.0035E+00	0.88958	0.88273	0.89642
M1	-5.1379E-01	-4.6696E-01	-5.6063E-01	-4.0697E-01	-3.4299E-01	-4.7093E-01	-4.7879E-01	-5.9385E-01	-3.6373E-01	-0.35921	-0.32298	-0.39542
M2	6.5154E-01	5.8763E-01	7.1546E-01	4.8159E-01	3.7487E-01	5.8828E-01	6.1525E-01	8.8380E-01	3.4669E-01	0.45257	0.4002	0.50492
M3	-6.8482E-01	-6.0528E-01	-7.6437E-01	-4.8797E-01	-3.6648E-01	-6.0941E-01	-6.4398E-01	-9.2288E-01	-3.6506E-01	-0.47169	-0.40785	-0.53552
M4	3.9133E-01	3.3679E-01	4.4588E-01	2.7305E-01	1.9309E-01	3.5299E-01	3.8164E-01	5.3967E-01	2.2361E-01	0.28825	0.24475	0.33174
M5	-1.0695E-01	-8.9282E-02	-1.2462E-01	-7.2673E-02	-4.6325E-02	-9.9013E-02	-1.1075E-01	-1.5848E-01	-6.3019E-02	-0.087469	-0.073059	-0.10187
M6	1.1073E-02	8.8668E-03	1.3280E-02	7.1755E-03	3.7536E-03	1.0596E-02	1.2431E-02	1.8393E-02	6.4684E-03	1.04E-02	8.50E-03	1.22E-02
M7												
M8												
M9												
R	1	1	1	1	1	1	1	1	1	1	1	1

Figure 4.18a: Transmission Coefficients for Plywood (Wet) Panels (relative to free space). Nominal thicknesses: P25WL = 6 mm; P50WL = 13 mm; P75WL = 19 mm; P125WL = 32 mm. Dotted Curves represent +/- 1 standard deviation from mean (Solid Curves). Low Range Data: 0.5 to 2.0 GHz

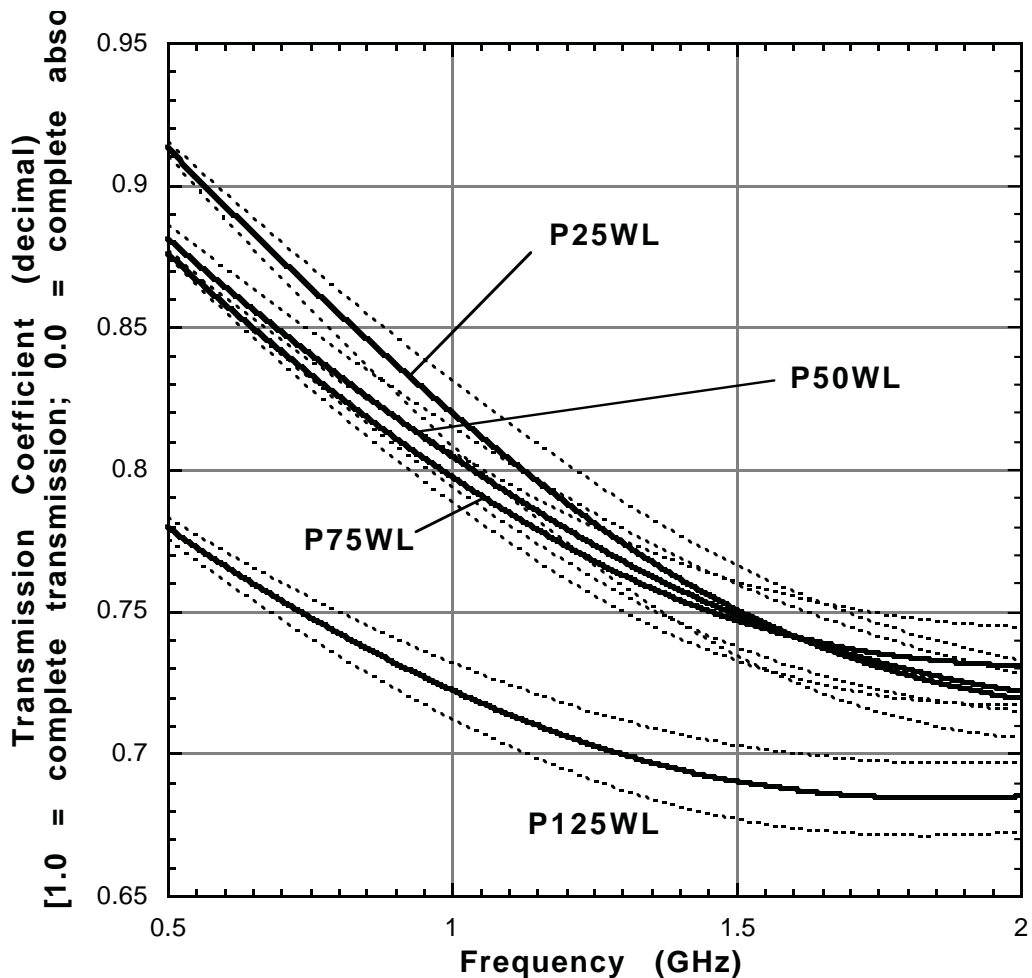

Table 4.18b: Regression Coefficients (dB) for Plywood (Wet) Transmission versus Frequency Curves Plotted in Figure 4.18b. The regression equation is of the form Received Signal Magnitude = $M_0 + M_1 * F + M_2 * F^2 + M_3 * F^3 + M_4 * F^4 + M_5 * F^5 + M_6 * F^6$, where F is the frequency in GHz. The correlation coefficient, R, is defined in the text. Data are for the Frequency Range 0.5 to 2.0 GHz.

Southern Pine (Wet) Attenuation Curves (0.5 to 2.0 GHz)											
Curve Identification	P25DL		P50DL		P75DL		P125DL				
Coefficient	+ sigma	- sigma	+ sigma	- sigma	+ sigma	- sigma	+ sigma	- sigma	+ sigma	- sigma	
	dB	dB	dB	dB	dB	dB	dB	dB	dB	dB	dB
M0	7.0553E-01	0.58131	8.3281E-01	1.5955E-01	3.8468E-02	2.8353E-01	2.8839E-01	4.5981E-01	1.1864E-01	-0.94451	-1.0293
M1	-4.8813E+00	-4.3672E+00	-5.4141E+00	-3.9717E+00	-3.2770E+00	-4.6835E+00	-4.7902E+00	-5.8705E+00	-3.7218E+00	-4.0194	-3.566
M2	6.3624E+00	5.5619E+00	7.2098E+00	4.8050E+00	3.5842E+00	6.0674E+00	6.4163E+00	8.8947E+00	3.9708E+00	5.2694	4.5475
M3	-6.8000E+00	-5.7896E+00	-7.8685E+00	-4.9824E+00	-3.5458E+00	-6.4754E+00	-6.9476E+00	-9.4600E+00	-4.4767E+00	-5.7184	-4.8052
M4	3.7592E+00	3.1060E+00	4.4449E+00	2.7254E+00	1.7845E+00	3.7048E+00	4.1048E+00	5.5241E+00	2.7081E+00	3.5288	2.9131
M5	-9.5921E-01	-7.6311E-01	-1.1632E+00	-6.8494E-01	-3.8123E-01	-1.0011E+00	-1.1648E+00	-1.6003E+00	-7.3461E-01	-1.0652	-0.86587
M6	8.8941E-02	6.6363E-02	1.1217E-01	6.0964E-02	2.2489E-02	1.0098E-01	1.2631E-01	1.8197E-01	7.1064E-02	1.25E-01	9.96E-02
M7											
M8											
M9											
R	1	1	1	1	1	1	1	1	1	1	1

Figure 4.18b: Received Signal Magnitude (dB) for Plywood (Wet) Panels (relative to free space).
P25WL = 6 mm; P50WL = 13 mm; P75WL = 19 mm; P125WL = 32 mm
Dotted Curves represent +/- 1 standard deviation from mean (Solid Curves).
Low Range Data: 0.5 to 2.0 GHz

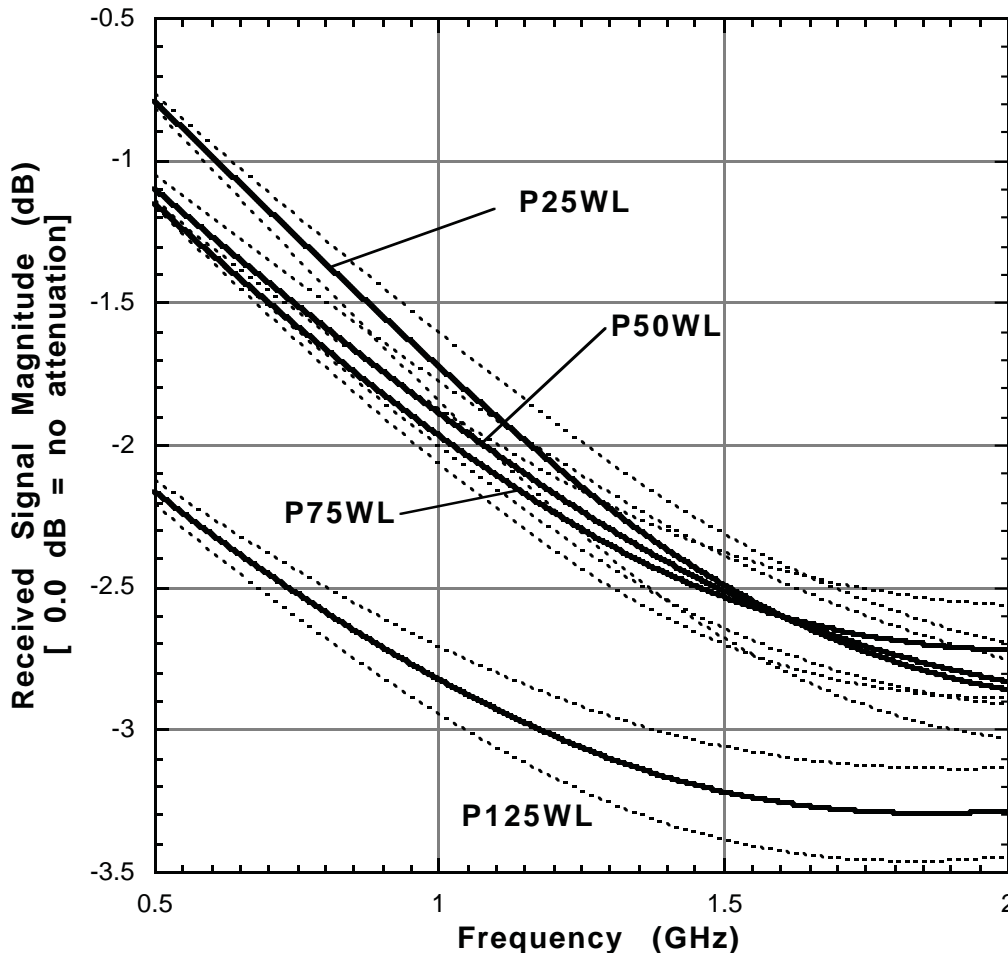

Table 4.18c: Regression Coefficients (decimal) for Plywood (Wet) Transmission versus Frequency Curves Plotted in Figure 4.18c. The regression equation is of the form $\text{Transmission Coefficient} = M_0 + M_1 \cdot F + M_2 \cdot F^2 + M_3 \cdot F^3 + M_4 \cdot F^4 + M_5 \cdot F^5 + M_6 \cdot F^6$ etc. where F is the frequency in GHz. The correlation coefficient, R, is defined in the text. Data are for the Frequency Range 3.0 to 8.0 GHz.

Southern Pine (Wet) Attenuation Curves (3.0 to 8.0 GHz)									
Curve Identification									
Coefficient	P25DH	P25DH + sigma	P25DH - sigma	P50DH	P50DH + sigma	P50DH - sigma	P75DH	P75DH + sigma	P75DH - sigma
	decimal	decimal	decimal	decimal	decimal	decimal	decimal	decimal	decimal
M0	-5.3832E-01	-0.55892	-5.1773E-01	-6.1972E-01	-6.7122E-01	-5.6822E-01	-1.5508E-01	-2.0561E-01	-1.0454E-01
M1	1.0774E+00	1.1034E+00	1.0513E+00	1.1971E+00	1.2663E+00	1.1279E+00	5.5829E-01	6.3090E-01	4.8567E-01
M2	-4.9546E-01	-5.0702E-01	-4.8391E-01	-5.5889E-01	-5.9176E-01	-5.2601E-01	-2.3524E-01	-2.7270E-01	-1.9778E-01
M3	1.3596E-01	1.3865E-01	1.3326E-01	1.5623E-01	1.6459E-01	1.4786E-01	7.1457E-02	8.1998E-02	6.0916E-02
M4	-2.0459E-02	-2.0797E-02	-2.0122E-02	-2.4482E-02	-2.5612E-02	-2.3352E-02	-1.3020E-02	-1.4663E-02	-1.1376E-02
M5	1.5497E-03	1.5713E-03	1.5281E-03	1.9475E-03	2.0219E-03	1.8732E-03	1.1992E-03	1.3306E-03	1.0679E-03
M6	-4.6217E-05	-4.6780E-05	-4.5656E-05	-6.1050E-05	-6.2882E-05	-5.9218E-05	-4.2450E-05	-4.6630E-05	-3.8270E-05
M7									
M8									
M9									
R	1	1	1	0.99999	0.99999	0.99999	0.99999	0.99999	0.99999

Figure 4.18c: Transmission Coefficients for Plywood (Wet) Panels (relative to free space). Nominal thicknesses: P25WH = 6 mm; P50WH = 13 mm; P75WH = 19 mm. Dotted Curves represent +/- 1 standard deviation from mean (Solid Curves). High Range Data: 3.0 to 8.0 GHz

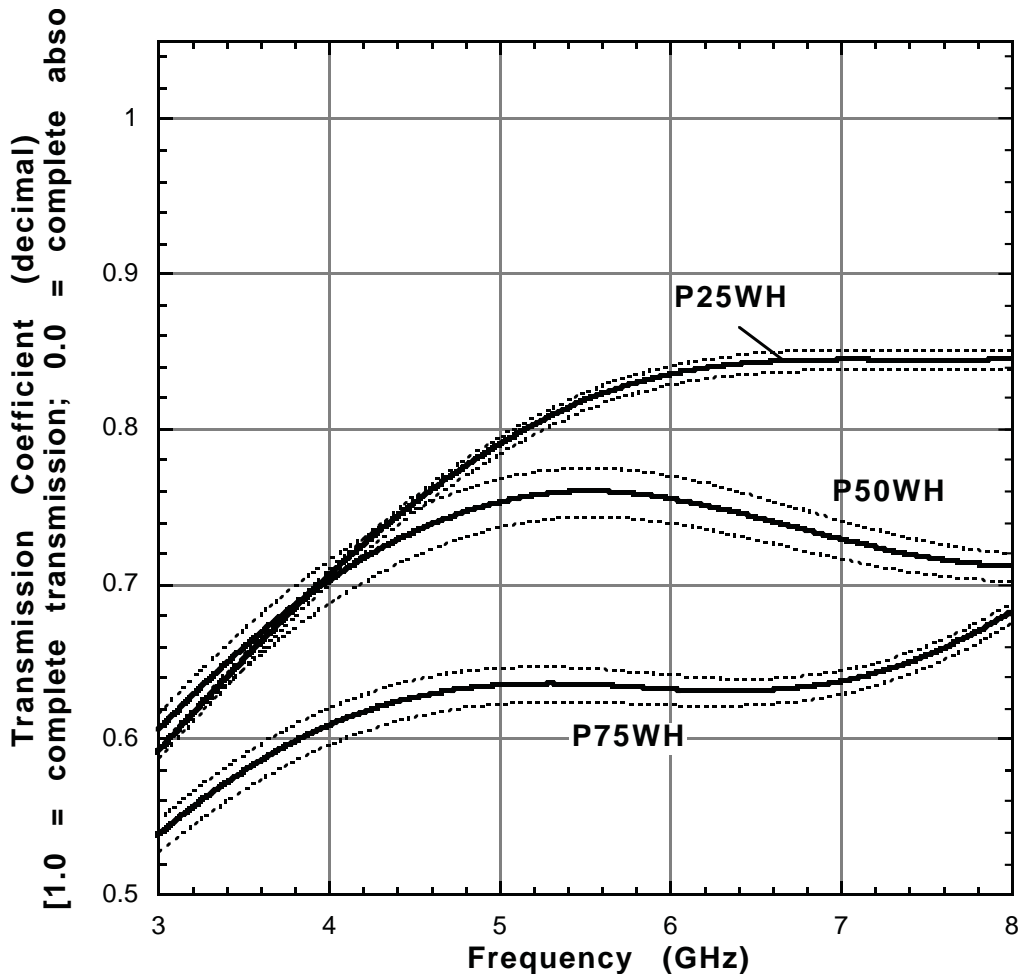
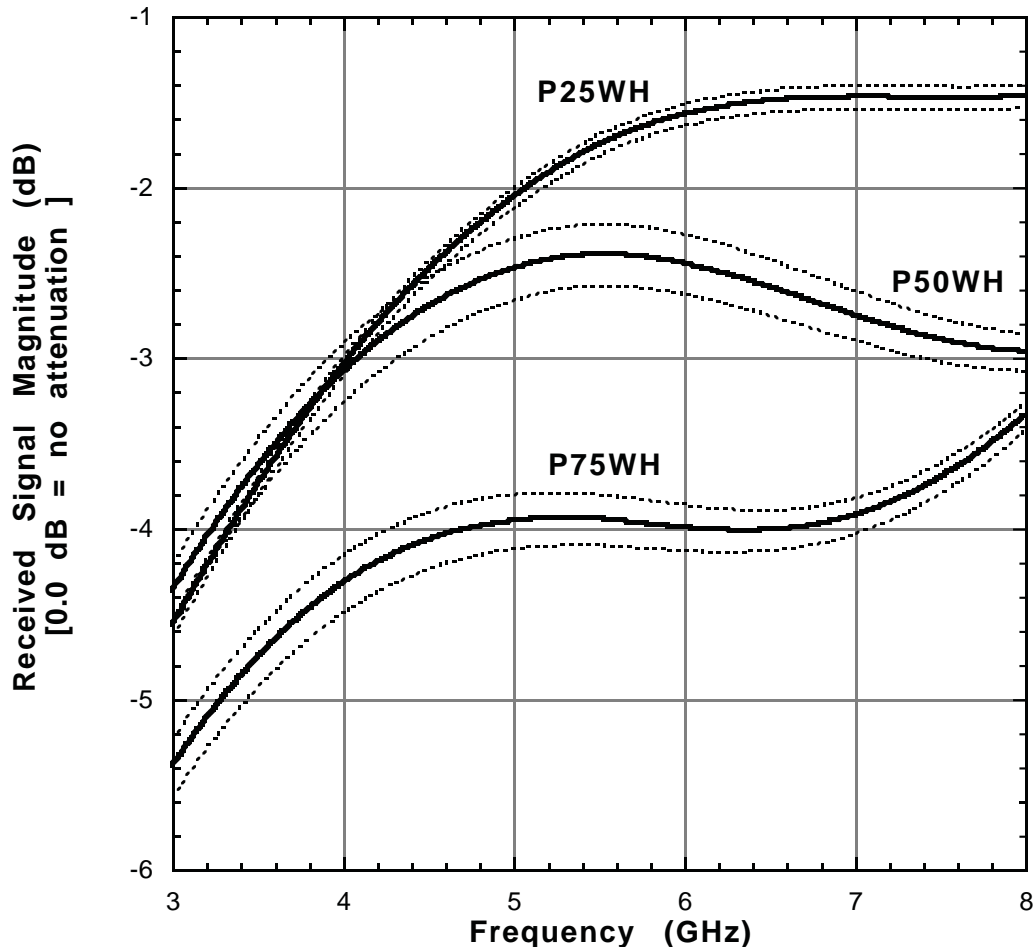

Table 4.18d: Regression Coefficients (dB) for Plywood (Wet) Transmission versus Frequency Curves Plotted in Figure 4.18d. The regression equation is of the form Received Signal Magnitude = $M_0 + M_1 * F + M_2 * F^2 + M_3 * F^3 + M_4 * F^4 + M_5 * F^5 + M_6 * F^6$, where F is the frequency in GHz. The correlation coefficient, R, is defined in the text. Data are for the Frequency Range 0.5 to 2.0 GHz.

Southern Pine (Wet) Attenuation Curves (3.0 to 8.0 GHz)									
Curve Identification									
Coefficient	P25DH	P25DH + sigma	P25DH - sigma	P50DH	P50DH + sigma	P50DH - sigma	P75DH	P75DH + sigma	P75DH - sigma
	dB	dB	dB	dB	dB	dB	dB	dB	dB
M0	-1.9642E+01	-19.793	-1.9490E+01	-2.3351E+01	-2.3431E+01	-2.3241E+01	-2.3092E+01	-2.3829E+01	-2.2334E+01
M1	1.2480E+01	1.2718E+01	1.2240E+01	1.7474E+01	1.7708E+01	1.7203E+01	1.6171E+01	1.7327E+01	1.4982E+01
M2	-4.8766E+00	-4.9855E+00	-4.7668E+00	-7.3831E+00	-7.4714E+00	-7.2766E+00	-6.8619E+00	-7.4655E+00	-6.2402E+00
M3	1.2182E+00	1.2434E+00	1.1929E+00	1.8786E+00	1.8931E+00	1.8596E+00	1.8090E+00	1.9734E+00	1.6394E+00
M4	-1.7620E-01	-1.7931E-01	-1.7307E-01	-2.7588E-01	-2.7627E-01	-2.7490E-01	-2.8506E-01	-3.0952E-01	-2.5979E-01
M5	1.3127E-02	1.3325E-02	1.2927E-02	2.1008E-02	2.0869E-02	2.1109E-02	2.3759E-02	2.5625E-02	2.1828E-02
M6	-3.8798E-04	-3.9321E-04	-3.8274E-04	-6.3750E-04	-6.2726E-04	-6.4678E-04	-7.9178E-04	-8.4878E-04	-7.3275E-04
M7									
M8									
M9									
R	1	1	1	0.99999	0.99999	0.99999	0.99999	0.99999	0.99999

Figure 4.18d: Received Signal Magnitude (dB) for Plywood (Wet) Panels (relative to free space).
P25WH = 6 mm; P50WH = 13 mm; P75WH = 19 mm.
Dotted Curves represent +/- 1 standard deviation from mean (Solid Curves).
High Range Data: 3.0 to 8.0 GHz



BLANK PAGE

4.19 Reinforced Concrete

The following four tables (4.19a through 4.19d) present the frequency response spectrum for reinforced concrete walls. The specimens in this series bear the designation RC88XL and RC88XH, where the “X” defines the percent reinforcement, and the L and H denote “low” (0.5 to 2.0 GHz) and “high” (3.0 to 8.0 GHz) frequency bandwidths.

All specimens were fabricated from Batch 8 concrete and were nominally 203 mm thick. The reinforcement grids are as shown in Figure 4.19 (below) and were identical to those in the rebar grid tests described in Section 4.20.

Figures 4.19a and 4.19b cover the band from 0.5 to 2.0 GHz, while Figures 4.19c and 4.19d are for the range 3.0 to 8.0 GHz. The ordinate values represent the ratio of the received to transmitted signal. The decimal attenuation values are presented first, followed by the same ordinate set converted to decibels.

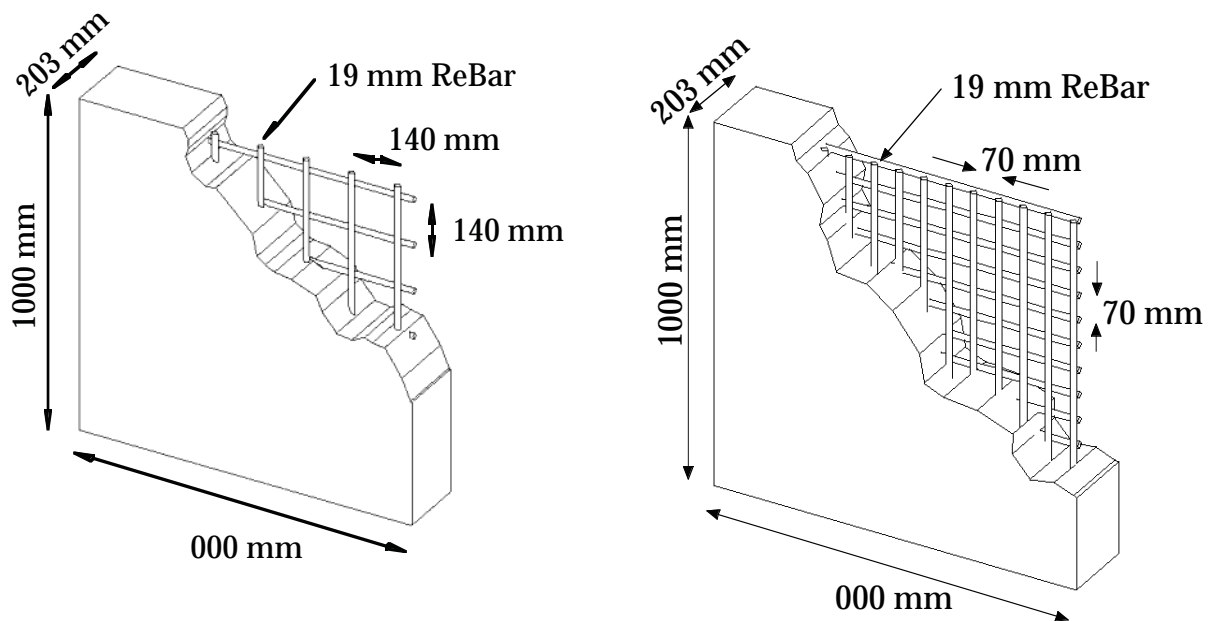

Figure 4.19: Specimens RC881 (left) and RC882 (right). Concrete batch was the same as for specimens C88. The results of these specimens are compared in this section with the reinforced samples.

Table 4.19a: Regression Coefficients (decimal) for Reinforced Concrete Transmission versus Frequency Curves Plotted in Figure 4.19a. The regression equation is of the form $\text{Transmission Coefficient} = M_0 + M_1 \cdot F + M_2 \cdot F^2 + M_3 \cdot F^3 + M_4 \cdot F^4 + M_5 \cdot F^5 + M_6 \cdot F^6$ etc. where F is the frequency in GHz. The correlation coefficient, R, is defined in the text. Data are for the Frequency Range 0.5 to 2.0 GHz.

Reinforced Concrete Attenuation Curves (0.5 to 2.0 GHz)									
Coefficient	Curve Identification								
	C88L	C88L + sigma	C88L - sigma	RC881L	RC881L + sigma	RC881L - sigma	RC882L	RC882L + sigma	RC882L - sigma
	Decimal	Decimal	Decimal	Decimal	Decimal	Decimal	Decimal	Decimal	Decimal
M0	1.9574E-01	2.1489E-01	1.7659E-01	0.11632	0.12819	0.10445	8.8034E-02	9.2206E-02	8.3863E-02
M1	-4.9081E-01	-5.8680E-01	-3.9481E-01	-0.038559	-0.097943	0.020824	-1.2997E-01	-1.5205E-01	-1.0789E-01
M2	8.0792E-01	9.9712E-01	6.1872E-01	-0.14826	-0.033705	-0.26282	1.5164E-01	2.0077E-01	1.0251E-01
M3	-8.3060E-01	-1.0186E+00	-6.4256E-01	0.14603	0.038506	0.25355	-1.4795E-01	-2.0002E-01	-9.5885E-02
M4	4.9001E-01	5.9206E-01	3.8796E-01	-0.014967	0.039006	-0.068939	1.0358E-01	1.3238E-01	7.4778E-02
M5	-1.4966E-01	-1.7878E-01	-1.2054E-01	-0.023988	-0.038072	-0.0099049	-4.0443E-02	-4.8468E-02	-3.2418E-02
M6	1.8226E-02	2.1659E-02	1.4792E-02	0.0065792	0.0080924	0.0050661	6.2570E-03	7.1446E-03	5.3694E-03
M7									
M8									
M9									
R	1	1	1	0.99999	0.99999	0.99999	1	1	1

Figure 4.19a: Transmission Coefficients for Reinforced Concrete Walls (relative to free space). Nominal thicknesses: All Specimens are 203 mm Thick. Low Range Data: 0.5 to 2.0 GHz
 C88L = Unreinforced Reference; RC881L = 1% Steel; RC882L = 2% Steel
 Dotted Curves represent +/- 1 standard deviation from mean (Solid Curves).

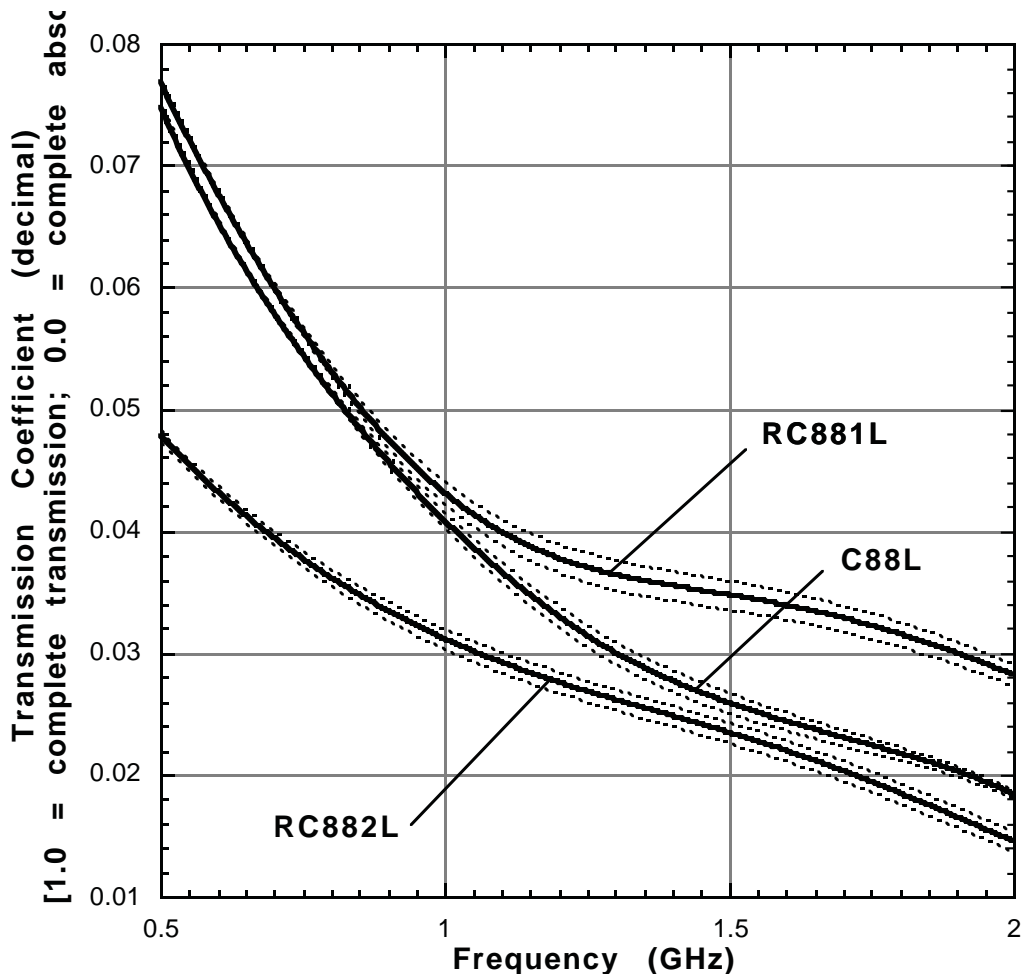

Table 4.19b: Regression Coefficients (dB) for Reinforced Concrete Transmission versus Frequency Curves Plotted in Figure 4.19b. The regression equation is of the form Received Signal Magnitude = $M_0 + M_1 * F + M_2 * F^2 + M_3 * F^3 + M_4 * F^4 + M_5 * F^5 + M_6 * F^6$, where F is the frequency in GHz. The correlation coefficient, R, is defined in the text. Data are for the Frequency Range 0.5 to 2.0 GHz.

Reinforced Concrete Attenuation Curves (0.5 to 2.0 GHz)									
Curve Identification									
Coefficient	C88L dB	C88L + sigma dB	C88L - sigma dB	RC881L dB	RC881L + sigma dB	RC881L - sigma dB	RC882L dB	RC882L + sigma dB	RC882L - sigma dB
M0	-7.5025E+00	-6.1221E+00	-8.7903E+00	-18.774	-18.305	-19.105	-1.9363E+01	-1.8639E+01	-2.0090E+01
M1	-6.4597E+01	-7.0406E+01	-5.9339E+01	-7.8074	-8.4393	-8.0524	-2.5150E+01	-2.8706E+01	-2.1612E+01
M2	1.1751E+02	1.2639E+02	1.0988E+02	18.292	14.693	24.066	4.1211E+01	4.8086E+01	3.4491E+01
M3	-1.2896E+02	-1.3519E+02	-1.2414E+02	-59.486	-49.468	-72.189	-5.6320E+01	-6.1846E+01	-5.1128E+01
M4	7.4256E+01	7.6711E+01	7.2597E+01	64.724	55.575	75.611	4.4126E+01	4.6001E+01	4.2547E+01
M5	-2.0580E+01	-2.1214E+01	-2.0164E+01	-28.832	-25.23	-32.996	-1.7168E+01	-1.7299E+01	-1.7155E+01
M6	2.0961E+00	2.1840E+00	2.0306E+00	4.5809	4.0568	5.1773	2.5310E+00	2.4960E+00	2.5836E+00
M7									
M8									
M9									
R	1	1	1	0.99999	0.99998	0.99999	1	1	1

Figure 4.19b: Received Signal Magnitude (dB) for Reinforced Concrete Walls (relative to free space).
 All Specimens are 203 mm Thick. Low Range Data: 0.5 to 2.0 GHz
 C88L = Unreinforced Reference; RC881L = 1% Steel; RC882L = 2% Steel
 Dotted Curves represent +/- 1 standard deviation from mean (Solid Curves).

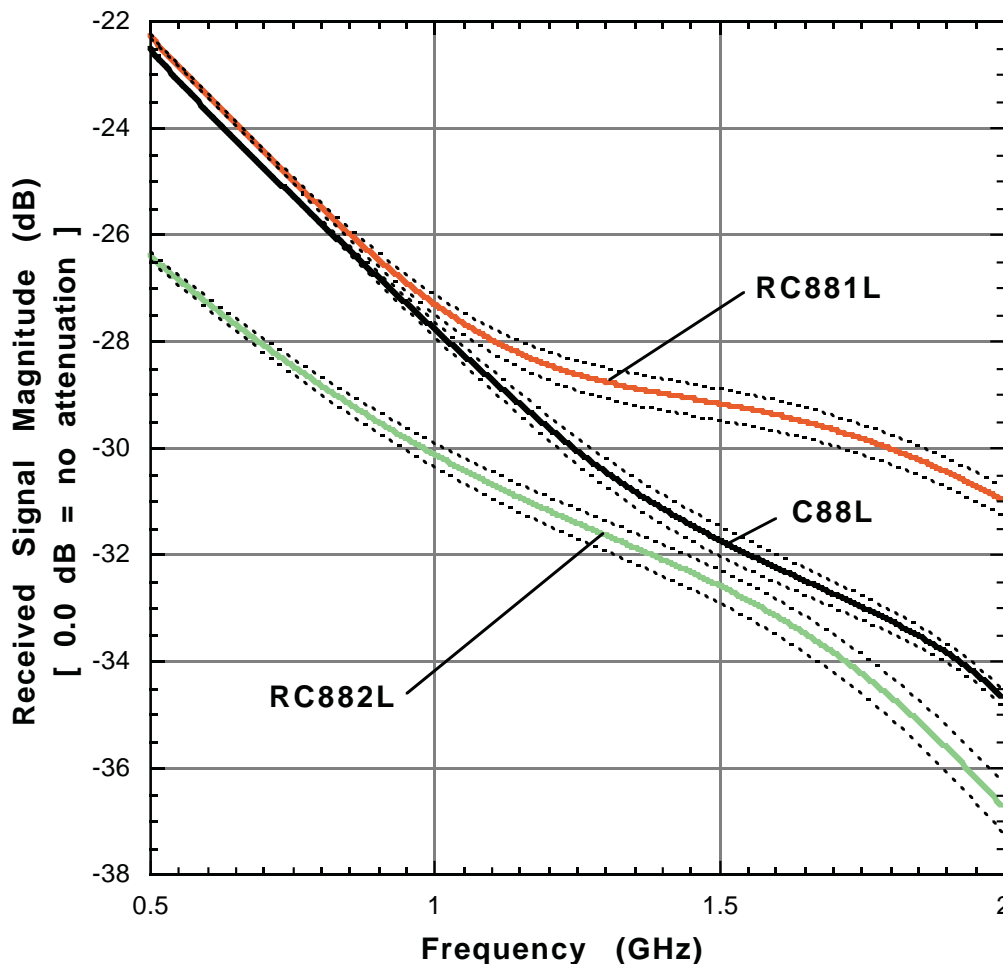

Table 4.19c: Regression Coefficients (decimal) for Reinforced Concrete Transmission versus Frequency Curves Plotted in Figure 4.19c. The regression equation is of the form $\text{Transmission Coefficient} = M_0 + M_1 * F + M_2 * F^2 + M_3 * F^3 + M_4 * F^4 + M_5 * F^5 + M_6 * F^6$ etc. where F is the frequency in GHz. The correlation coefficient, R, is defined in the text. Data are for the Frequency Range 3.0 to 8.0 GHz.

Reinforced Concrete Attenuation Curves (3.0 to 8.0 GHz)									
Curve Identification									
Coefficient	C88H	C88H + sigma	C88H - sigma	RC881H	RC881H + sigma	RC881H - sigma	RC882H	RC882H + sigma	RC882H - sigma
	Decimal	Decimal	Decimal	decimal	decimal	decimal	decimal	decimal	decimal
M0	8.5008E-03	8.7618E-03	8.2397E-03	0.0072087	0.0070249	0.0073922	2.8272E-03	4.6088E-03	1.0470E-03
M1	-5.7899E-03	-5.8974E-03	-5.6824E-03	-0.0039265	-0.0035561	-0.0042964	3.0774E-04	-1.7448E-03	2.3586E-03
M2	2.7328E-03	2.7595E-03	2.7060E-03	0.0017313	0.0015383	0.0019241	-3.6695E-04	6.4895E-04	-1.3821E-03
M3	-7.0006E-04	-7.0104E-04	-6.9909E-04	-0.00041259	-0.00035941	-0.00046571	1.3022E-04	-1.4153E-04	4.0176E-04
M4	9.3971E-05	9.2931E-05	9.5014E-05	4.91E-05	4.08E-05	5.74E-05	-2.7350E-05	1.3654E-05	-6.8327E-05
M5	-6.4726E-06	-6.2918E-06	-6.6536E-06	-2.89E-06	-2.20E-06	-3.57E-06	2.7480E-06	-5.1612E-07	6.0100E-06
M6	1.8601E-07	1.7739E-07	1.9464E-07	7.07E-08	4.80E-08	9.33E-08	-9.9968E-08	5.9965E-09	-2.0587E-07
M7									
M8									
M9									
R	1	1	1	1	1	1	1	1	1

Figure 4.19c: Transmission Coefficients for Reinforced Concrete Walls (relative to free space). Nominal thicknesses: All Specimens are 203 mm Thick. High Range Data: 3.0 to 8.0 GHz
 C88L = Unreinforced Reference; RC881L = 1% Steel; RC882L = 2% Steel
 Dotted Curves represent +/- 1 standard deviation from mean (Solid Curves).

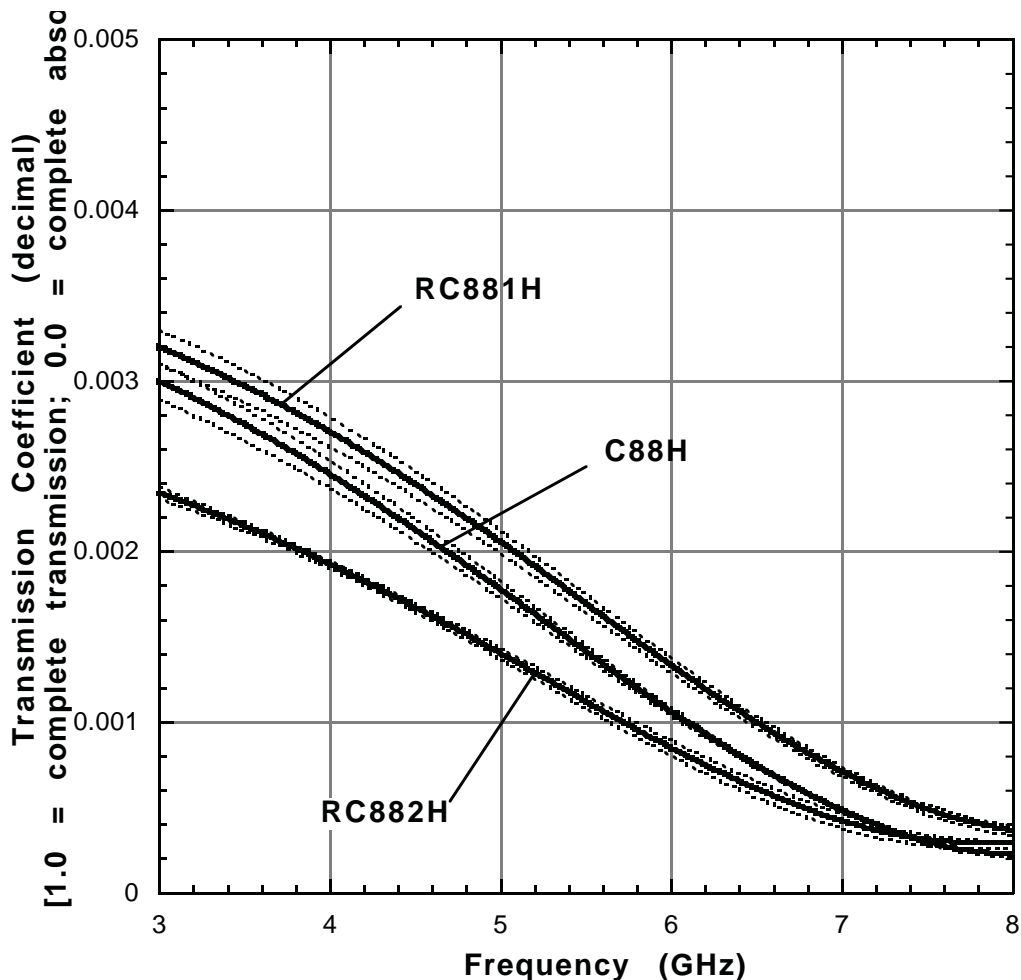
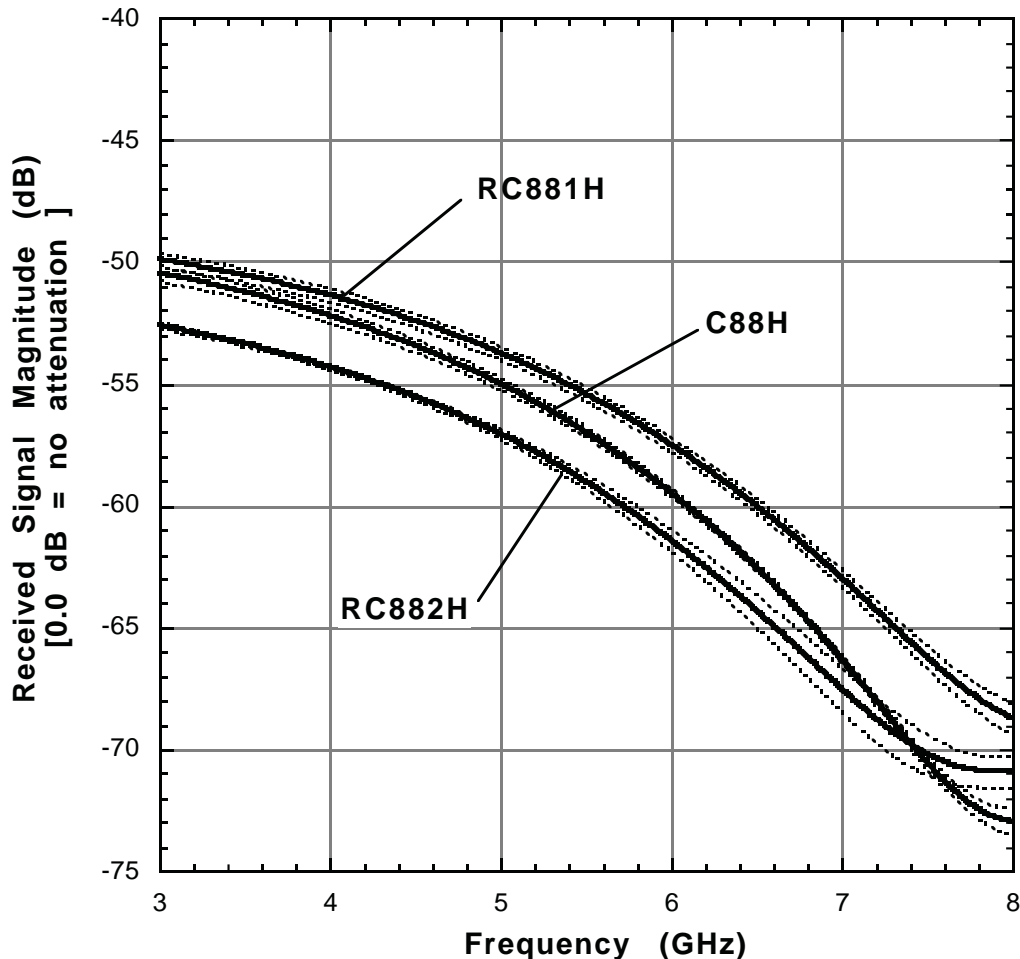

Table 4.19d: Regression Coefficients (dB) for Reinforced Concrete Transmission versus Frequency Curves Plotted in Figure 4.19d. The regression equation is of the form Received Signal Magnitude = $M_0 + M_1 \cdot F + M_2 \cdot F^2 + M_3 \cdot F^3 + M_4 \cdot F^4 + M_5 \cdot F^5 + M_6 \cdot F^6$, where F is the frequency in GHz. The correlation coefficient, R, is defined in the text. Data are for the Frequency Range 0.5 to 2.0 GHz.

Reinforced Concrete Attenuation Curves (3.0 to 8.0 GHz)									
Curve Identification									
Coefficient	C88H	C88H + sigma	C88H - sigma	RC881H	RC881H + sigma	RC881H - sigma	RC882H	RC882H + sigma	RC882H - sigma
	dB	dB	dB	dB	dB	dB	dB	dB	dB
M0	2.1087E+02	2.0579E+02	2.1482E+02	51.337	41.974	61.136	5.5418E+00	5.2986E+01	-5.1414E+01
M1	-3.3034E+02	-3.2375E+02	-3.3550E+02	-126.92	-115.03	-139.33	-7.7524E+01	-1.3466E+02	-9.0516E+00
M2	1.7179E+02	1.6855E+02	1.7428E+02	65.976	59.989	72.206	4.3696E+01	7.1752E+01	1.0178E+01
M3	-4.6890E+01	-4.6076E+01	-4.7497E+01	-18.072	-16.501	-19.7	-1.3085E+01	-2.0244E+01	-4.5693E+00
M4	7.0653E+00	6.9559E+00	7.1434E+00	2.7352	2.5093	2.9684	2.1692E+00	3.1667E+00	9.8904E-01
M5	-5.5888E-01	-5.5155E-01	-5.6371E-01	-0.21832	-0.20148	-0.23561	-1.9028E-01	-2.6190E-01	-1.0607E-01
M6	1.8103E-02	1.7918E-02	1.8205E-02	0.0071561	0.0066503	0.0076719	6.8546E-03	8.9184E-03	4.4448E-03
M7									
M8									
M9									
R	0.99998	0.99998	0.99998	1	1	0.99999	0.99999	1	0.99997

Figure 4.19d: Received Signal Magnitude (dB) for Reinforced Concrete Walls (relative to free space).
 All Specimens are 203 mm Thick. High Range Data: 3.0 to 8.0 GHz.
 C88L = Unreinforced Reference; RC881L = 1% Steel; RC882L = 2% Steel
 Dotted Curves represent +/- 1 standard deviation from mean (Solid Curves).



BLANK PAGE

4.20 Rebar Grid

The following four tables (4.20a through 4.20d) present the frequency response spectrum for steel reinforcing rod (rebar) grids. The specimens in this series bear the designation REXL and REXH, where the “X” defines the volumetric percentage of reinforcement relative to specimens C88L and C88H. The L and H denote “low” (0.5 to 2.0 GHz) and “high” (3.0 to 8.0 GHz) frequency bandwidths.

All specimens were fabricated from 19 mm diameter Grade 60 (yield stress 414

MPa) steel deformed reinforcement. The reinforcement grids are as shown in Figure 4.20 (below) and were identical to the grids used in the reinforced concrete specimens (Section 4.19).

Figures 4.20a and 4.20b cover the band from 0.5 to 2.0 GHz, while Figures 4.20c and 4.20d are for the range 3.0 to 8.0 GHz. The ordinate values represent the ratio of the received to transmitted signal. The decimal attenuation values are presented first, followed by the same ordinate set converted to decibels.

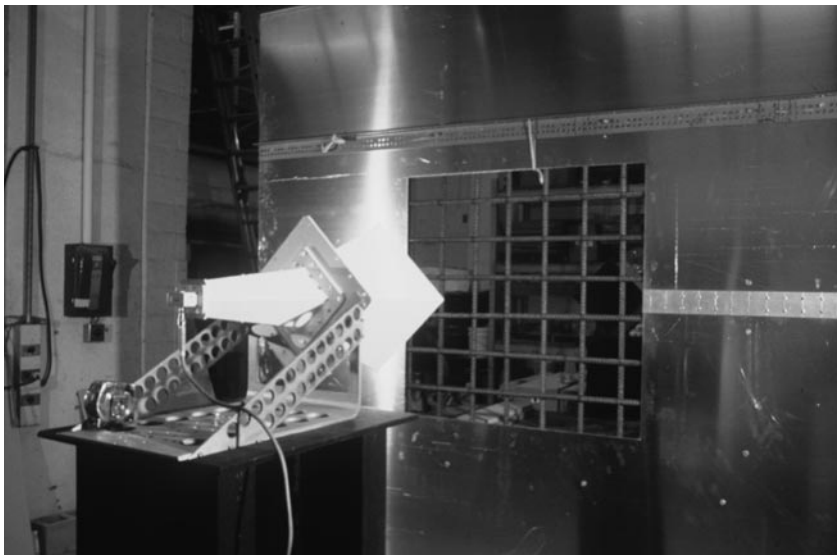

Figure 4.20a: Specimen RE1H (19 mm diameter reinforcing bars on 140 mm centers). Frequency test range: 3.0 to 8.0 GHz. See Figure 5.20c and 5.20d.

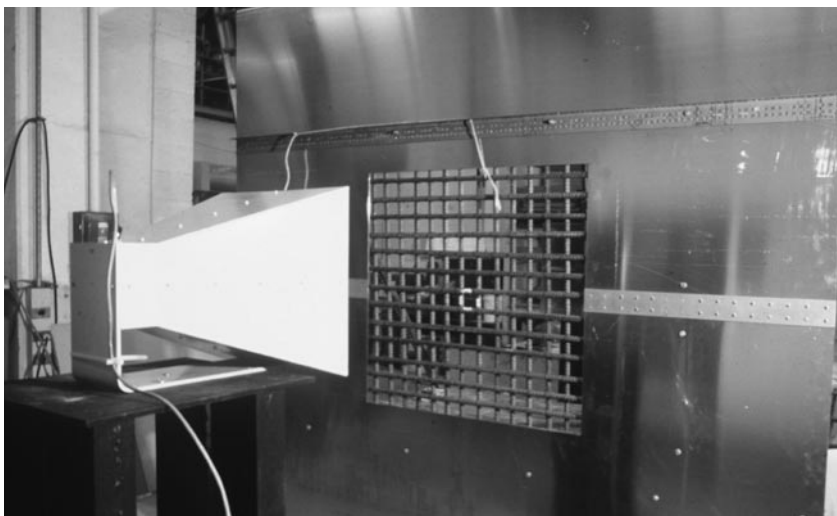

Figure 4.20b: Specimen RE2L (19 mm diameter reinforcing bars on 70 mm centers). Frequency test range: 0.5 to 2.0 GHz. See Figure 5.20a and 5.20b.

Table 4.20a: Regression Coefficients (decimal) for Reinforcing Bar Grid Transmission versus Frequency Curves Plotted in Figure 4.20a. The regression equation is of the form $\text{Transmission Coefficient} = M_0 + M_1 \cdot F + M_2 \cdot F^2 + M_3 \cdot F^3 + M_4 \cdot F^4 + M_5 \cdot F^5 + M_6 \cdot F^6$ etc. where F is the frequency in GHz. The correlation coefficient, R, is defined in the text. Data are for the Frequency Range 0.5 to 2.0 GHz.

Rebar Grid Attenuation Curves (0.5 to 2.0 GHz)						
Curve Identification						
Coefficient	RE1L	RE1L + sigma	RE1L - sigma	RE2L	RE2L + sigma	RE2L - sigma
	decimal	decimal	decimal	decimal	decimal	decimal
M0	6.5645E-01	8.2826E-01	4.8464E-01	0.10422	0.14179	0.066658
M1	-2.2744E-02	-7.7363E-01	7.2813E-01	0.41864	0.23067	0.60661
M2	1.6691E-01	1.3736E+00	-1.0398E+00	-1.1158	-0.74372	-1.4878
M3	-2.9442E-01	-1.1575E+00	5.6858E-01	1.399	1.0271	1.771
M4	3.8773E-01	6.5343E-01	1.2206E-01	-0.78225	-0.57795	-0.98654
M5	-1.9888E-01	-2.1713E-01	-1.8064E-01	0.19803	0.13932	0.25673
M6	3.4080E-02	3.0091E-02	3.8070E-02	-0.01821	-0.011311	-0.02511
R	1	1	1	1	1	1

Figure 4.20a: Transmission Coefficients for Rebar Grids (relative to free space).
 RE1RL = 19 mm bars on 140 mm square grid
 RE2RL = 19 mm bars on 70 mm square grid
 Low Range Data: 0.5 to 2.0 GHz
 Dotted Curves represent +/- 1 standard deviation from mean (Solid Curves).

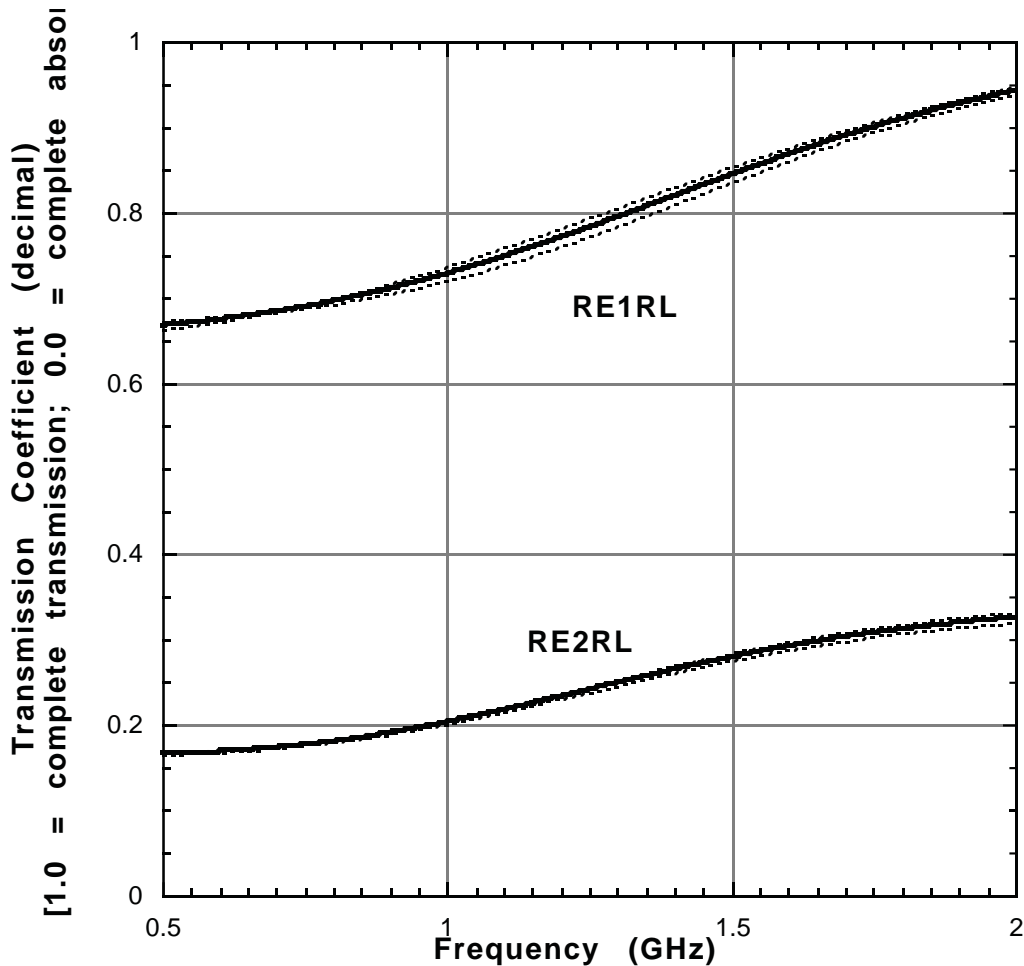

Table 4.20b: Regression Coefficients (dB) for Rebar Grid Transmission versus Frequency Curves Plotted in Figure 4.20b. The regression equation is of the form Received Signal Magnitude = $M_0 + M_1 * F + M_2 * F^2 + M_3 * F^3 + M_4 * F^4 + M_5 * F^5 + M_6 * F^6$, where F is the frequency in GHz. The correlation coefficient, R, is defined in the text. Data are for the Frequency Range 0.5 to 2.0 GHz.

Rebar Grid Attenuation Curves (0.5 to 2.0 GHz)						
	Curve Identification					
Coefficient	RE1L	RE1L + sigma	RE1L - sigma	RE2L	RE2L + sigma	RE2L - sigma
	dB	dB	dB	dB	dB	dB
M0	-3.9873E+00	-1.4936E+00	-6.4737E+00	-17.993	-15.847	-20.151
M1	1.9272E+00	-9.4768E+00	1.3243E+01	18.812	7.8252	29.851
M2	-3.8192E+00	1.5906E+01	-2.3237E+01	-57.469	-35.195	-79.823
M3	4.4558E+00	-1.1665E+01	2.0102E+01	82.429	59.686	105.22
M4	-1.0471E+00	5.4843E+00	-7.2203E+00	-54.714	-42.114	-67.325
M5	-4.2203E-01	-1.6182E+00	6.4328E-01	17.214	13.59	20.836
M6	1.4873E-01	2.1424E-01	1.0173E-01	-2.0991	-1.6744	-2.5231
R	1	1	1	1	1	1

Figure 4.20b: Received Signal Magnitude (dB) for Rebar Grids (relative to free space).

RE1RL = 19 mm bars on 140 mm square grid

RE2RL = 19 mm bars on 70 mm square grid

Low Range Data: 0.5 to 2.0 GHz

Dotted Curves represent +/- 1 standard deviation from mean (Solid Curves).

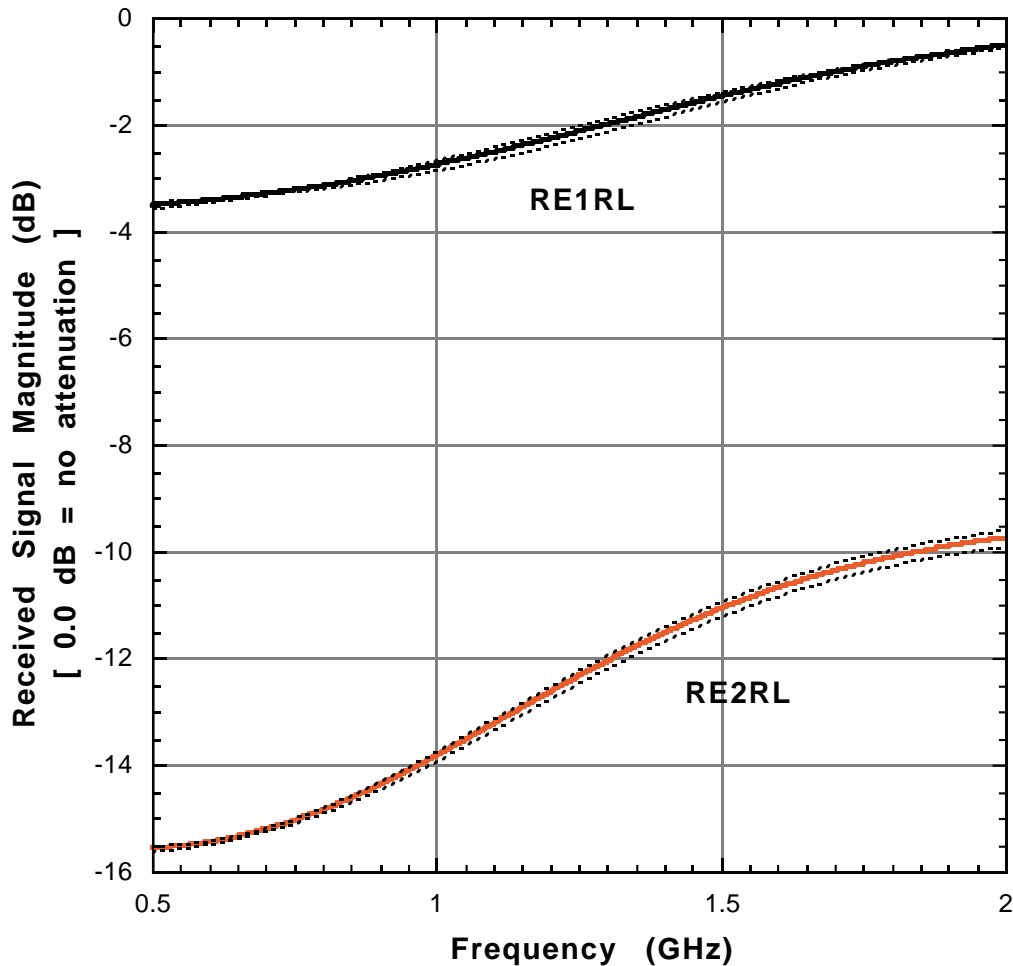

Table 4.20c: Regression Coefficients (decimal) for Rebar Grid Transmission versus Frequency Curves Plotted in Figure 4.20c. The regression equation is of the form Transmission Coefficient = M0+M1*F+M2*F^2+M3*F^3+M4*F^4+M5*F^5+M6*F^6 etc. where F is the frequency in GHz. The correlation coefficient, R, is defined in the text. Data are for the Frequency Range 3.0 to 8.0 GHz.

Rebar Grid Attenuation Curves (3.0 to 8.0 GHz)						
Curve Identification						
Coefficient	RE1H	RE1H + sigma	RE1H - sigma	RE2H	RE2H + sigma	RE2H - sigma
	decimal	decimal	decimal	decimal	decimal	decimal
M0	-7.9473E-01	-8.0232E-01	-7.8714E-01	-0.27782	-0.34225	-0.21339
M1	1.4472E+00	1.4722E+00	1.4222E+00	0.79174	0.89753	0.68593
M2	-6.6937E-01	-6.8407E-01	-6.5467E-01	-0.39285	-0.45472	-0.33097
M3	1.8363E-01	1.8772E-01	1.7953E-01	0.11412	0.13276	0.09548
M4	-2.7857E-02	-2.8395E-02	-2.7318E-02	-0.017376	-0.02043	-0.014322
M5	2.1365E-03	2.1666E-03	2.1065E-03	0.0012969	0.0015537	0.0010402
M6	-6.4617E-05	-6.5075E-05	-6.4159E-05	-3.76E-05	-4.63E-05	-2.90E-05
R	1	1	1	1	1	1

Figure 4.20c: Transmission Coefficients for Rebar Grids (relative to free space).
 RE1RL = 19 mm bars on 140 mm square grid
 RE2RL = 19 mm bars on 70 mm square grid
 High Range Data: 3.0 to 8.0 GHz
 Dotted Curves represent +/- 1 standard deviation from mean (Solid Curves).

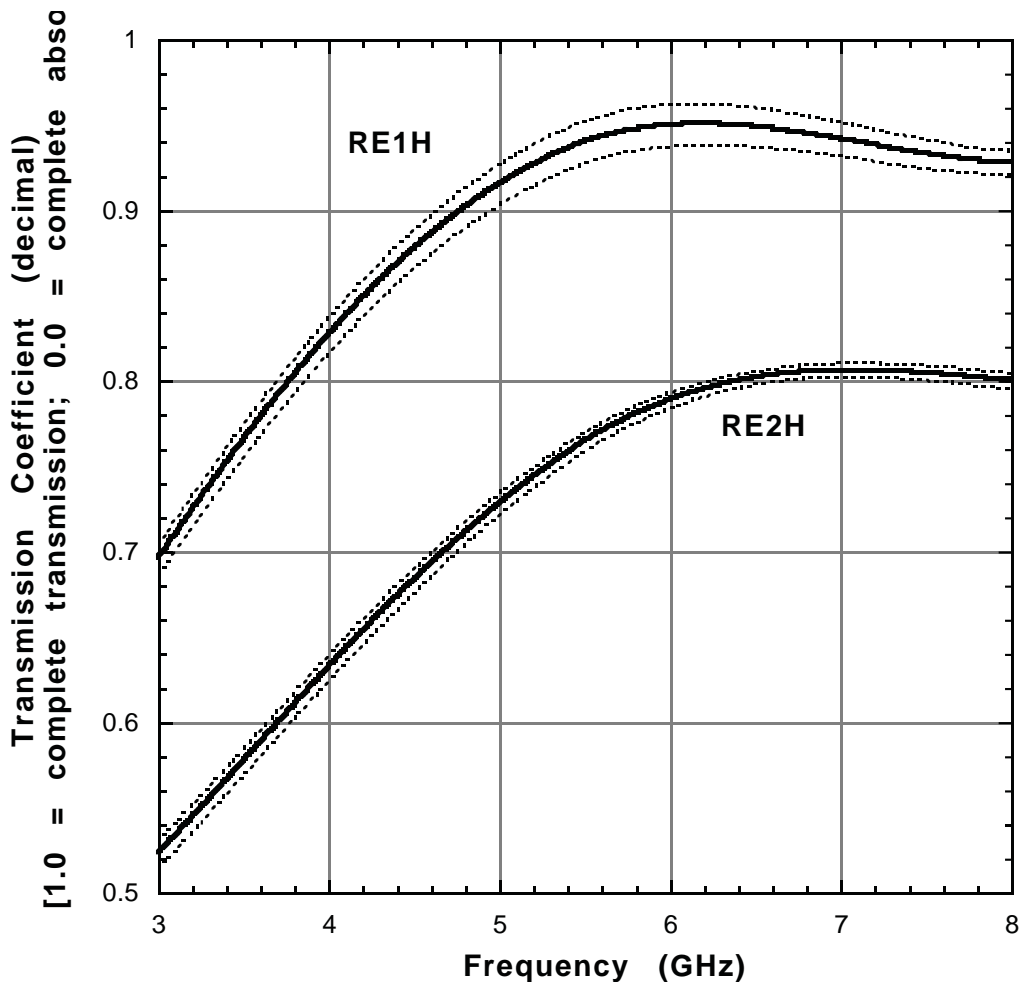

Table 4.20d: Regression Coefficients (dB) for Rebar Grid Transmission versus Frequency Curves Plotted in Figure 4.20d. The regression equation is of the form Received Signal Magnitude = $M_0 + M_1 \cdot F + M_2 \cdot F^2 + M_3 \cdot F^3 + M_4 \cdot F^4 + M_5 \cdot F^5 + M_6 \cdot F^6$, where F is the frequency in GHz. The correlation coefficient, R, is defined in the text. Data are for the Frequency Range 3.0 to 8.0 GHz.

Rebar Grid Attenuation Curves (3.0 to 8.0 GHz)						
	Curve Identification					
Coefficient	RE1H	RE1H + sigma	RE1H - sigma	RE2H	RE2H + sigma	RE2H - sigma
	dB	dB	dB	dB	dB	dB
M0	-2.1005E+01	-2.0424E+01	-21.586	-1.3237E+01	-13.573	-12.921
M1	1.5522E+01	1.5067E+01	15.974	4.5845E+00	5.4441	3.7409
M2	-6.2548E+00	-6.0698E+00	-6.4368	-1.5544E+00	-2.1036	-1.0108
M3	1.5567E+00	1.5137E+00	1.5988	4.8611E-01	0.65674	0.31651
M4	-2.2387E-01	-2.1759E-01	-0.23002	-8.3460E-02	-0.11186	-0.055158
M5	1.6654E-02	1.6118E-02	0.017182	6.7194E-03	0.009133	0.004309
M6	-4.9322E-04	-4.7366E-04	-0.00051259	-2.0257E-04	-0.00028454	-0.0001206
R	1	1	1	1	1	1

Figure 4.20d: Received Signal Magnitude (dB) for Rebar Grids (relative to free space).

RE1RL = 19 mm bars on 140 mm square grid

RE2RL = 19 mm bars on 70 mm square grid

High Range Data: 3.0 to 8.0 GHz

Dotted Curves represent +/- 1 standard deviation from mean (Solid Curves).

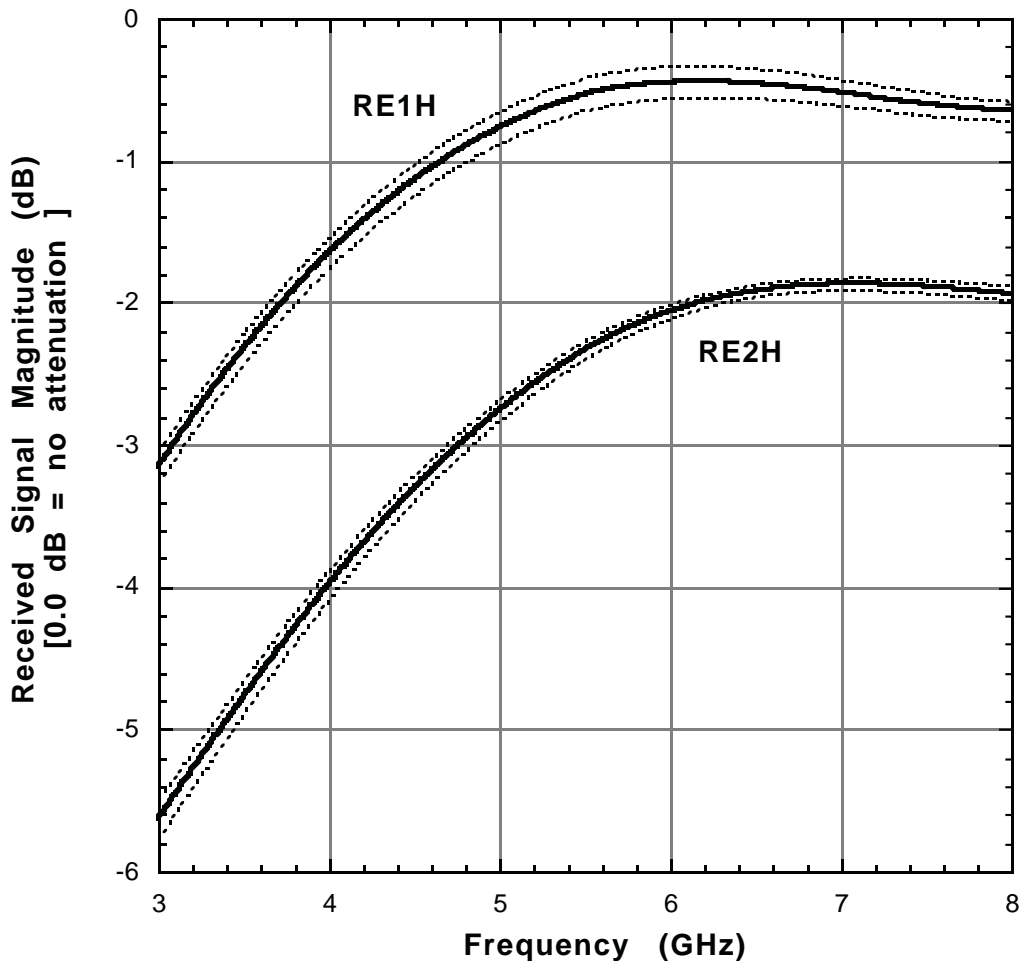

5.0 Summary

The above data represent a fairly comprehensive set of information concerning the most common construction materials and their susceptibility to penetration by electromagnetic (EM) radiation in the 0.5 to 8.0 GHz (60 cm to 4 cm wavelength) range.

Perhaps the most striking aspect of these data is the relative “transparency” of the majority of these materials to EM waves within the frequency range tested, which constituted relatively long wavelength radiation as compared with, for example, visible light. As an example, the average power of the received signal for a broadband pulse in the 0.5 to 2.0 GHz regime incident upon a 3-wythe thick (267 mm) brick wall was on the order of 40% that of the transmitted signal power. And this was for a transmission power level of only 1 mW. Similar characteristics apply to masonry block walls, a staple of commercial construction practice. A one mW signal penetrating three layers of masonry block (610 mm thick) was received at a power level of approximately 0.05 mW, still well above the noise threshold of the receiving instrumentation.

Other materials more common to residential construction -- plywood, lumber studs, glass, and drywall -- were penetrated even more easily. A 13 mm thick plywood panel dissipated only 10% of the power of the transmitted signal; two layers of solid fir planks (76 mm thick) dissipated 30% of the transmitted signal strength; a 19 mm thick glass panel dissipated 30%; and a 13 mm thick drywall

panel dissipated only 6% of the transmitted power. In a few special cases for thinner specimens subjected to signals in the 3.0 to 8.0 GHz regime (specifically the drywall and glass specimens), the received signal, at certain discrete frequencies, approached or slightly exceeded the transmitted power level. This is a well known phenomenon of resonance that is exploited in radome design.

The strongest signal absorption occurred for concrete specimens. However, measurable signals were acquired for slabs of up to 305 mm thick. Previous tests [Stone, 1996] indicated a limiting thickness penetration of between 0.5 to 0.75 m for a 1 mW signal).

Several observations concerning reinforced concrete are worth discussing. The most important appears to be a relative EM penetration insensitivity to significant changes in the concrete constituents. A 100% increase in aggregate size has no observable effect on received signal power. Nor, apparently, does the water-cement ratio. The most measurable effect appears to be related to the slump (a measure of the flow-ability of the mixture per ASTM standard procedures). Even this, however, is not a dramatic effect: an 8% reduction in received signal power for a 4-fold increase in slump (see Figure 5.1).

Another useful means of comparing the transparency of engineering materials is to calculate the signal loss per unit thickness (expressed in dB/mm). This quanti-

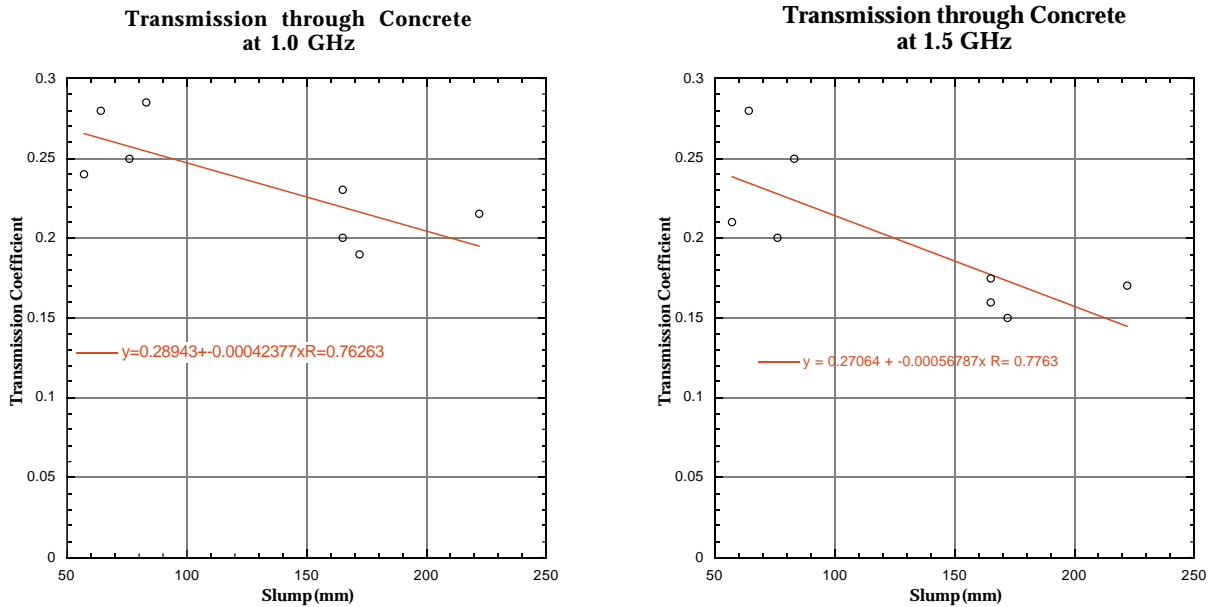

Figure 5.1: Signal attenuation versus slump relationship considering all eight concrete mixtures at two representative discrete frequencies (1.0 and 1.5 GHz) for 102 mm thick plain concrete specimens.

ty, for a limited number of tests involving various materials, is plotted in Figure 5.2 as a function of the measured material density (in g/cc). For this plot, the density for the brick and masonry block specimens was the true density of the solid material (not counting the cores). Likewise, the loss per unit thickness for the brick and masonry block specimens was calculated on the assumption that the EM signal penetrated the thinnest sidewall distance, propagated across the air gap in the cells, and then continued through the opposite wall, with the power dissipation occurring only during the penetration of the front and rear walls. Despite the scatter in the data, Figure 5.2 strongly supports the notion that, at least in non-conducting materials, the signal loss per unit thickness is proportional to the material density.

In general, the signal attenuation (dB/mm) increases with increasing frequency. A one milliwatt signal penetrating a 305 mm thick concrete wall will undergo a loss of approximately 90 dB at 8 GHz. While this can be recovered from the background noise in a laboratory setting, that is not guaranteed in an industrial situation such as a construction site or busy inner city complex.

The data presented herein were taken largely to prepare for the development of NLS metrology systems, since accurate distance measurement will require compensation of the range errors which result from propagation delays as the signal travels through the solid material. In their present form, the data should be of general use as a material reference handbook to mobile and portable communica-

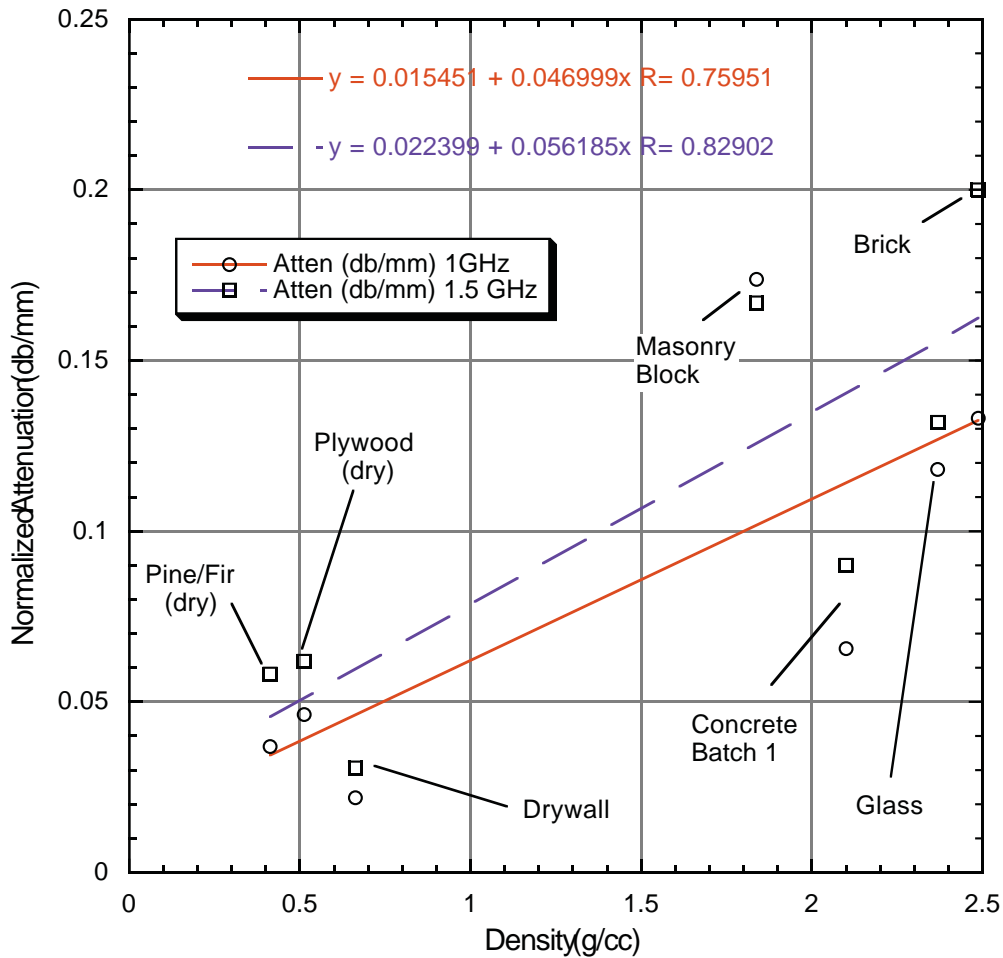

Figure 5.2: Signal loss per unit material thickness (expressed in dB/mm) as a function of the material density (g/cc). The above data represent a very small sampling of the available database at only two discrete frequencies. Attenuation increases, generally, with increasing signal frequency.

tions equipment researchers and designers, whose tasks involve the calculation and simulation of signal attenuation throughout office structures and the like.

From a practical standpoint, the data presented herein strongly support the future development of NLS surveying and tracking systems -- surveying through "solid walls." Within the RF spectrum investigated herein, measurable signals, which can subsequently be used to reconstruct time-of-flight distances, can be

received through substantial thicknesses of most common construction materials.

A forthcoming report will investigate the frequency dependency of the material dielectric and conductivity constants and will develop simplified regression equations for the prediction of propagation delay times. These latter quantities will be more specifically developed for embedded position error compensation systems for NLS metrology.

6.0 References

- [1] Stone, W.C., Non-Line-of-Sight (NLS) Metrology, NIST Construction Automation Program Report No. 1, NISTIR 5825, National Institute of Standards and Technology, Gaithersburg, MD, Feb. 1996
- [2] Stone, W.C., Ed., Proceedings of the NIST Construction Automation Workshop, March 30-31, 1995, NIST Construction Automation Program Report No. 2, NISTIR 5856, National Institute of Standards and Technology, Gaithersburg, MD, May 1996, pp 13-22; 29-42.
- [3] Stone, W.C., "Surveying Through Solid Walls," Proceedings, ISARC-14, June 8-11, 1997, Pittsburgh, PA. pp. 22-40.
- [4] Ulaby, F.T., Whitt, M., and Sarabandi, K., AVNA - Based Polarimetric Scatterometers, IEEE Antennas and Propagation Magazine, October 1990, pp. 6-17.
- [5] Blejer, D.J., Frost, C.E., and Scarborough, S.M., Theory and Measurements of Buried and Partially Buried Trihedrals for Ground Penetration Radar, Project Report GPR-3, MIT Lincoln Lab, 22 February 1995.
- [6] Churchill, R., Complex Variables and Applications, McGraw-Hill, 1984.
- [7] Rabiner, L.R., and Gold, B., Theory and Application of Digital Signal Processing, Prentice-Hall, 1975, pp. 356-399.
- [8] Krauss, T.P., Shure, L., and Little, J.N., Signal Processing Toolbox, The Math Works, Inc., Natick, MA, September 1995. pp. 1.56-1.57.
- [9] HP 8530A Microwave Receiver Operating Manual, HP Part No. 08350-90010, February 1993, Edition 2, pp. 13.12 - 13.14.
- [10] Scarborough, S, Frost, C, and Blejer, D., Range Accuracy Experiment, Internal Report from MIT Lincoln Lab to NIST, November 1, 1996.
- [11] Blejer, D., Frost, C., and Scarborough, S., "SAR Imaging of mine-like targets over ultra-wide bandwidths," SPIE Vol. 2496, April 1995, pp 54-69.
- * Any mention of commercial products is for information only; it does not imply recommendation or endorsement by the National Institute of Standards and Technology nor does it imply that the products mentioned are necessarily the best available for the purpose.

Appendix A: MatLab Scripts

The following pages contain MatLab scripts for post-processing the test data in order to create the tables and plots presented in Chapter 4. The radar data acquisition and storage program was a proprietary code (DataPro) developed by Flam & Russell. Following the acquisition of the initial frequency power spectra for each test, DataPro was used to perform three subsequent digital signal processing steps: 1) Conversion of the frequency domain data to time domain (using a chirp-Z algorithm); 2) Time domain gating (using a band-pass filter) to eliminate unwanted multipath signals; and 3) production of a gated frequency spectra (using an inverse FFT algorithm). Any of these steps could have also been accomplished using standard commercial packages such as MatLab, IDL etc. Unprocessed frequency domain data (ten complete frequency response spectras for each material specimen) from these tests are available through NIST (and amount to approximately 600 Mbytes of disk space). Also available, as indicated earlier, are digital copies of the gated time and frequency data.

Time domain gating of the above data was centered on the average peak time for the ten sample files taken for each specimen. A 1 nanosecond gate, was used for the low frequency data (0.5 to 2.0 GHz) and a 0.5 nanosecond gate was used for the high frequency data (3.0 to 8.0 GHz). For convenience, and machine portability, the data processed using DataPro were stored in Network Common Data Form (netCDF) at the conclusion of each test. NetCDF is a computing platform independent data format developed by the University Corporation for Atmospheric Research (UCAR, Boulder, CO) for the National Science Foundation. The data can be accessed and manipulated with a set of FORTRAN and C-callable subroutines contained in a self-extracting archive file named 'NETCDF.EXE' which is available from UCAR, NSF, and USGS.

In order to provide more easily usable data the netCDF data files were subsequently post-processed using a series of MatLab routines which read the data, performed statistical functions (average and standard deviation calculations), peak detection, data decimation, etc. and wrote the subsequent processed data to ASCII format output files. These files were then subsequently used for plotting of the data on a PowerMac 8100 using Excel and KaleidaGraph. The MatLab program flow, with a brief functional description of each routine, is as follows:

NISTGATE	-	Tabulates and plots statistics of specified netCDF files.
+++GATEAVG	-	Computes Statistics for specified netCDF files.
+---DOSFILES	-	Generates a list of files from a wildcard specification.
+---CDFLAMIN	-	Extracts data from a netCDF format FR959 radar data file.
+---MEXCDF	-	Provides netCDF interface.
+++GFRETBL	-	Tabulates gated frequency domain response statistics.
+++FDBPLOT	-	Plots gated frequency domain response statistics.

+---GTIMTBL - Tabulates gated time domain response statistics.
 +---RDBPLOT - Plots gated time domain response statistics.
 MADBCOLS - Adds dB columns to multiple tabulated statistic files.
 +---DOSFILES - Generates a list of files from a wildcard specification.
 +---ADDBCOLS - Adds columns for average and standard deviation in dB
 to a file containing tabulabulated statistics.

All of the above routines were written by Carl Frost at MIT Lincoln Lab.

NISTGATE:

```

function nistgate(tag)
%NISTGATE tabulates and plots statistics for specified Gated NIST NLS
%   files in netCDF format, given a data set identifier or 'tag'.
%   example:
%       nistgate('B1L')
%   Created Sept 3, 1996 by C. E. Frost
orient tall            %Set plot mode
c=.2998;               %Speed of light in Gigameters/sec
[favg,fdev,f]=gateavg([tag,'*.GDF']); %Get frequency stats for 'tag'.
if favg > 0
    gfretbl(f,favg,fdev,[tag,'.GFR']); %Write the table file.
    subplot(2,1,1);                %Plot frequency on top half.
    fdbplot(f,favg,fdev,['',tag,' GATED FREQUENCY RESPONSE']); %Plot.
end
[tavg,tdev,t,r0]=gateavg([tag,'*.GDT']); %Get time stats for 'tag'.
if tavg > 0
    r=c*t+r0;                        %Compute absolute range
    gtimtbl(r,tavg,tdev,[tag,'.GTI']); %Write the table file.
    subplot(2,1,2);                %Plot range(time) on bottom half.
    rdbplot(r,tavg,tdev,['',tag,' GATED TIME DOMAIN RESPONSE']); %Plot.
end
eval(['print -dps ',tag,'.PS']);     %Generate postscript plot file.
  
```

GATEAVG:

```

function [avg,stdev,x,r0]=gateavg(filespec)
%GATEAVG procuces a matrix of averages and standard deviations for the
%   netCDF files matching the input file specification.
%   example:
%       [avg,stdev,x,r0]=gateavg(filespec)
%   where:
%       filespec is a wild card netCDF file specification
%       avg     is the average of the file contents
  
```

```

%      stdev  is the standard deviation of the file contents
%      x      is the frequency or time scale
%      r0     is the calibration range in meters
%      The length of the data arrays in the files must match.
%      Created Sept 3, 1996 by C. E. Frost
[filelist,nfiles] = dosfiles(filespec);
if nfiles > 0
    [y,x,r0]=cdfamin(filelist(1,:));
    for n=2:nfiles,
        y=[y,cdfamin(filelist(n,:))];
    end
    y=abs(y');
    avg=mean(y)';
    stdev=std(y)';
else
    disp(['ERROR ',filespec,' NOT FOUND']);
    y=-1;avg=-1;stdev=-1;
end

```

DOSFILES:

```

function [list, count]=dosfiles(filespec)
%DOSFILES returns a list of files matching the input file specification.
%      and an optional file count.
%      Returns -1 on error
%      example:
%          [list, count]=dosfiles(filespec)
%
%      For use only with the MS Windows version of Matlab.
%
%      Created Sept 3, 1996 by C. E. Frost
tempfile=tempname;           %Get a temp file name from Matlab.
unix(['dir ',filespec,' /b > ',tempfile]); %Direct the bare directory command
                                   %results to the temp file.
fid=fopen(tempfile,'r');      %Open the temp file, readonly.
count=0;                      %Initialize the count.
list = fgetl(fid);           %Get the first entry.
if list >= 0,                 %Check for empty list.
    count=1;                  %Set the file count to 1.
    name = fgetl(fid);        %Get the next entry.
    while name >= 0,         %Loop until EOF.
        list=str2mat(list,name); %Build the file name list.
        count=count+1;      %Increment the file count.
        name = fgetl(fid);   %Get the next entry.
    end
end

```

```

end
end
fclose(fid);           %Close the temp file.
delete(tempfile)      %Delete the temp file.

```

CDFLAMIN:

```

function [y,x,r0]=cdflamin(path)
%CDFLAMIN extracts data from a netCDF format Flam & Russel 959 file.
%   example:
%           [y,x,r0]=cdflamin(path)
%   where:
%       y is the frequency or time domain data.
%       x is the frequency(GHz) or time(ns) scale.
%       r0 is the calibration range in meters.
%   Created Sept 3, 1996 by C. E. Frost. This version is capable
%   of extracting data only from netCDF FR959 files containing
%   one polarization, and one antenna position.
old_ncopts=mexcdf('SETOPTS',0);           %Set mode to NOVERBOSE
cdfid=mexcdf('OPEN', path, 'NOWRITE');    %Open the file readonly
% Get the file content properties:
[ndims, nvars, natts, recdim, status] = mexcdf('INQUIRE', cdfid);
dimlen=zeros(1,ndims);           %Initialize the dimension length matrix
for dimid=0:ndims-1,             %Populate the dimension length matrix
    [dimname,dimlen(1,dimid+1)]=mexcdf('DIMINQ',cdfid,dimid);
end
for varid=0:nvars-1,             %Parse through the variables for what we want
    [varname,dtype,ndims,dim,natts,status] = mexcdf('VARINQ',cdfid,varid);
    if strcmp(upper(varname),'FREQUENCY'), %Get the frequency or time variable
        [freqdim,nfreq,status]=mexcdf('DIMINQ',cdfid,dim);
        x =mexcdf('VARGET',cdfid,varid,zeros(1,ndims),dimlen(dim+1));
    end
    if strcmp(upper(varname),'FREQUENCY_DOMAIN'), %Get the Time/Freq Domain
data
        count=[dimlen(dim(1:ndims-1)+1),1]; %Form the count matrix
        rcorner=zeros(1,ndims);           %Form the real corner matrix
        icorner=[zeros(1,ndims-1),1];     %Form the imaginary corner matrix
        %Extract and combine the real and imaginary components.
        y=mexcdf('VARGET',cdfid,varid,rcorner,count)...
        +i*mexcdf('VARGET',cdfid,varid,icorner,count);
    end
end
%Get the calibration range.
r0=mexcdf('ATTGET',cdfid,mexcdf('PARAMETER','NC_GLOBAL'),'calibration_range_

```

```
Meters');
mexcdf('CLOSE',cdfid);
```

MEXCDF:

```
% MEXCDF provides an interface between netCDF and MATLAB.
% This Mex-file invokes the complete C-Language NetCDF interface,
% as described in the NetCDF Users Guide. All of the specified
% NetCDF input arguments are required. All output arguments are
% optional.
%
% Matlab Syntax:
%
%     [out1, out2, ...] = mexcdf('operation', in1, in2, ...)
%
% Extensions:
%
%     1.  Dimensions and variables accessible by id or name.
%     2.  Attributes accessible by name or number.
%     3.  Parameters accessible by number or name.
%     4.  Prepended "nc" not necessary for operation names.
%     5.  Prepended "NC_" not necessary for specifying parameters.
%     6.  Parameter names not case-sensitive.
%     7.  Required lengths default to actual lengths via -1.
%     8.  Scaling via "scale_factor" and "add_offset" attributes.
%     9.  SETOPTS to set NetCDF options. NC_FATAL is disabled.
%    10.  ERR to get the error-code of the most recent operation.
%    11.  PARAMETER to access parameters by name.
%    12.  USAGE to list NCMEX syntax.
%
%
% NetCDF OPERATIONS
% cdfid = mexcdf('CREATE', 'path', cmode);
% cdfid = mexcdf('OPEN', 'path', mode);
% status = mexcdf('ENDEF', cdfid);
% status = mexcdf('CLOSE', cdfid);
% [ndims, nvars, natts, recdim, status] = mexcdf('INQUIRE', cdfid);
% status = mexcdf('REDEF', cdfid);
% status = mexcdf('SYNC', cdfid);
% status = mexcdf('ABORT', cdfid);
% len = mexcdf('TYPELEN', datatype);
% old_fillmode = mexcdf('SETFILL', cdfid, fillmode);
% old_ncopts = mexcdf('SETOPTS', ncopts);
% ncerr = mexcdf('ERR');
```

```

% code = mexcdf('PARAMETER', 'NC_...');
%
% DIMENSIONS
% status = mexcdf('DIMDEF', cdfid, 'name', length);
% dimid = mexcdf('DIMID', cdfid, 'name');
% ['name',length,status] = mexcdf('DIMINQ', cdfid, dimid);
% status = mexcdf('DIMRENAME', cdfid, 'name');
%
% VARIABLES
% status = mexcdf('VARDEF', cdfid, 'name', datatype, ndims, [dim]);
% status = mexcdf('VARID', cdfid, 'name');
% ['name',datatype,ndims,[dim],natts, status] = mexcdf('VARINQ', cdfid, varid);
% status = mexcdf('VARPUT1', cdfid, varid, [coords], value);
% ['name',dtype,ndims,[dim],natts, status] = mexcdf('VARINQ', cdfid, varid);
% [value,status] = mexcdf('VARGET1', cdfid, varid, [coords]);
% status = mexcdf('VARPUT', cdfid, varid, [start], [count], [value]);
% [value,status] = mexcdf('VARGET', cdfid, varid, [start], [count]);
% status = mexcdf('VARRENAME', cdfid, varid, 'name');
%
% ATTRIBUTES
% status = mexcdf('ATTPUT', cdfid, varid, 'name', datatype, len, [value]);
% [datatype, len, status] = mexcdf('ATTINQ', cdfid, varid, 'name');
% [value], len, status] = mexcdf('ATTGET', cdfid, varid, 'name');
% status = mexcdf('ATTCOPY', incdf, invar, 'name', outcdf, outvar);
% ['name', status] = mexcdf('ATTNAME', cdfid, varid, attnum);
% status = mexcdf('ATTRENAME', cdfid, varid, 'name', 'newname');
% status = mexcdf('ATTDEL', cdfid, varid, 'name');

```

GFRETABLE:

```

function gfretbl(f,favg,fdev,outfile)
%GFRETABLE tabulates frequency domain statistical data.
%   Created Sept 3, 1996 by C. E. Frost
fid=fopen(outfile,'w');
fprintf(fid,' %15.15s %15.15s %15.15s\n','frequency (GHz)','average','std. deviation');
fprintf(fid,' %15.7g %15.7g %15.7g\n',[f,favg,fdev]);
fclose(fid);

```

FDBPLOT:

```

function fdbplot(f,favg,fdev,tag)
%FDBPLOT plots average frequency domain data with one standard deviation
%   upper and lower bounds in dB.
%   Created Sept 3, 1996 by C. E. Frost

```

```

plot(f,20*log10(favg),f,20*log10(favg-fdev),'g',f,20*log10(favg+fdev),'g');
xlabel('FREQUENCY (GHz)');
ylabel('AVERAGE MAGNITUDE (dB)');
title(tag);

```

GTIMTBL:

```

function gtimtbl(r,tavg,tdev,outfile)
%GTIMTBL tabulates time domain statistical data.
%   Created Sept 3, 1996 by C. E. Frost
fid=fopen(outfile,'w');
fprintf(fid,' %15.15s %15.15s %15.15s\n','range (m)', 'average', 'std. deviation');
fprintf(fid,' %15.7g %15.7g %15.7g\n',[r,tavg,tdev]);
fclose(fid);

```

RDBPLOT:

```

function rdbplot(r,tavg,tdev,tag)
%RDBPLOT plots average time domain data with one standard deviation
%   upper and lower bounds in dB.
%   Created Sept 3, 1996 by C. E. Frost
plot(r,20*log10(tavg),r,20*log10(tavg-tdev),'g',r,20*log10(tavg+tdev),'g');
xlabel('RANGE (m)');
ylabel('AVERAGE MAGNITUDE (dB)');
title(tag);

```

MADBCOLS:

```

function madbcols(filespec)
%MADBCOLS adds columns for the average and standard deviation in dB
%   for the gated spectrum and time domain tables produced by
%   GFRETBL and GTIMTBL matching the input file specification.
%
%   example:
%           madbcols('B*.GTI')
%
%   For use only with the MS Windows version of Matlab.
%
%   Created Sept 19, 1996 by C. E. Frost
[files,nfiles]=dosfiles(filespec); % Get file list matching filespec
if nfiles > 0
    for n=1:nfiles
        disp(files(n,:)); % Display the file name
        addbcols(files(n,:)); % Add the dB columns to the table
    end
end

```

```
end
end
```

DOSFILES: (Previously defined above)

ADDBCOLS:

```
function addbcols(infile)
%ADDBCOLS reads in an existing time or frequency domain file containing
%   tabulated statistical data, and adds two columns for the
%   average and standard deviations in dB.
%   Created Sept 19, 1996 by C. E. Frost
fid=fopen(infile,'r');    %Open the input file to read.
hdr=fgetl(fid);          %Read in the header line without \n
[dat,ndat]=fscanf(fid,'%g',[3,inf]); %Read the data into a 3 row matrix.
fclose(fid);             %Close the input file.
%Append the new column headers to the old:
hdr=[hdr,sprintf(' %15.15s %15.15s\n','average(db)','std. dev(db)')];
dbavg=20*log10(dat(2,:)); %Convert the average to dB.
dbdev=20*log10(dat(3,:)); %Convert the standard deviation to dB.
dat=[dat',dbavg',dbdev']; %Transpose, concatenate, and transpose
fid=fopen(infile,'w');   %Open the file to write
fprintf(fid,'%s',hdr);   %Write the header.
%Write out the data in five columns:
fprintf(fid,' %15.7g %15.7g %15.7g %15.7g %15.7g\n',dat);
fclose(fid);             %Close the file;
end;
```