

insē



Please do not hesitate to contact us whenever you want, we are always more than happy to help you!

✉ support@inselife.com

🌐 www.inselife.com



Call us at **1-888-970-0050**.

Our hours are 9 a.m. to 5 p.m. Monday - Friday.

FC



MADE IN CHINA

insē

USER MANUAL

**Cordless Stick
Vacuum Cleaner**

S6T / S6P Pro

S650 / S660 / S670

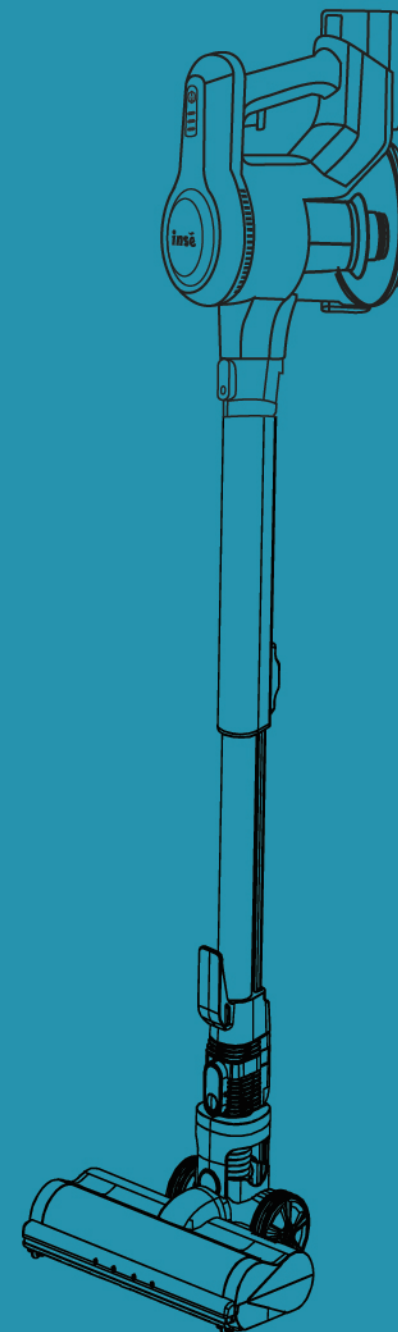

Warranty

NOTE:
THIS WARRANTY TERM GIVES YOU SPECIFIC LEGAL RIGHTS, AND YOU MAY ALSO HAVE OTHER RIGHTS WHICH VARY FROM STATE TO STATE.

12-month Warranty & Lifetime Customer Support

Only apply to eligible purchases made directly from the INSE authorized distributors. Warranty coverage applies to the original owner and to the original product only and is not transferable.

How to initiate a warranty claim

If your appliance operates improperly while in use under normal household conditions within the warranty period, please contact our customer support [[support@inse.life.com](mailto:support@inse.life)] or visit www.inse.life.com to fill out the warranty form to initiate a warranty claim.

For more warranty details, please refer to www.inse.life.com.
All rights are reserved by INSE official website.

Ready to Use Your Vacuum Cleaner?

Please read the attached user manual carefully before use.
Besides, you could get more operation guidance and maintenance tips on INSE Youtube:



www.inse.life.com
General tips, FAQ, etc



bit.ly/inseyoutube-s6T
Installation videos

INSE CUSTOMER CARE

Your INSE vacuum cleaner enjoys a 12-month warranty. It will be covered for all accessories for 12-month from the date of purchase. If you have any questions about your INSE appliance, just contact INSE Customer Support via the following channels:

You can reach the INSE customer support team at
Email: support@inse.life.com with your order ID,
and details of the issue you met.

Hotline: call us at **1-888-970-0050**.
Our hours are **9 a.m. to 5 p.m. Monday - Friday**.

INSE Customer Support will help you solve the problem quickly within 24 hours.

CONTENTS

Important Safety Instructions	01
Battery safety	02
Warning	03
Product Parts List and Schematic	04
Product Overview	05
Assembly and Storage	06
Ready to Use	07
Charging	08-09
Product Technical Parameters	10
Accessory Instructions	11
Combination	12
Daily Maintenance	13-14
Trouble Shooting	15

IMPORTANT SAFETY INSTRUCTIONS

BEFORE USING THIS MACHINE READ ALL INSTRUCTIONS AND CAUTIONARY MARKINGS IN THIS MANUAL AND ON THE MACHINE

When using an electrical appliance, basic precautions should always be followed, including the following:



Do not use near open flames

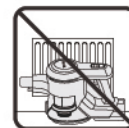

Do not store near heat sources



Do not pick up water or liquids



Do not pick up burning objects



Do not put hands near the brush bar when the machine is in use



Do not place on or near the cooker

- Do not use to pick up water or any other liquid, as this may cause electric shock.
- Do not use to pick up sharp objects such as glass or screws, etc.
- Do not use the appliance to pick up flammable liquid, matches, cigarette ends, hot ashes or any hot, burning or smoking objects.
- Do not use if any of its openings are blocked.
- Do not store the appliance in direct sunlight or in high humidity conditions.
- Do not use this appliance outdoors.
- Do not use any damaged accessories or adaptors.
- Do not use any parts/accessories or adaptors other than those supplied with this appliance, as this may cause damage.
- Do not use the appliance for anything other than its intended use.
- Do not use the appliance if it has been dropped or if there are visible signs of damage.
- Do not use the adaptor to recharge non-rechargeable batteries.
- Do not remove from the adaptor from the mains power supply by pulling the cord; switch off and remove the plug by hand.
- Do not expose the appliance to rain.
- Do not operate the appliance with wet hands.
- Do not immerse the appliance in water or any other liquid.
- Only use with provided power adapter.
- Use of an extension power cord is not allowed.
- Always ensure that the appliance has cooled fully after use before performing any cleaning or user maintenance.
- Switch off the appliance and disconnect it from the mains power supply before changing or fitting accessories.
- Take care when equipping accessories with rotating parts as this could cause entrapment.
- This appliance is intended for domestic use only. It should not be used for commercial purposes.

- Keep the appliance away from other heat emitting appliances.
- Keep the appliance away from heat or sharp edges that could cause damage.
- Keep away from children aged below 8.
- Improper repairs may put the user in danger.
- If any part is damaged due to human error, only a qualified electrician can repair it. Please note the appliance is not under warranty in this case.
- This appliance is not a toy.
- Children should be supervised to ensure that they do not play with the appliance.
- Children whose aged from 8 years and above, people who with reduced physical, sensory or mental capabilities or lack of experience and knowledge can use this appliance, only if they have been given supervision or instruction concerning to use the appliance in a safe way and understand the hazards involved.
- Check the voltage indicated on the rating plate and confirm you connect the appliance to the power supply with correct voltage.

Battery Safety















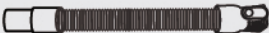

- If the battery pack becomes exhausted, it should be removed from the product to avoid leakage.
- In the event of the battery pack leaking, do not allow any liquid to come into contact with the skin or eyes.
- If contact has been made, wash the affected area with copious amounts of water and seek medical advice.
- Keep the battery pack out of the reach of children.
- Secondary battery packs need to be charged before use. After extended periods of storage, it may be necessary to charge and discharge the batteries several times to obtain maximum performance.
- Do not leave battery packs on charge for prolonged periods of time.
- Do not use any charger other than that specifically provided for use with the product.
- The supply terminals are not to be short-circuited.
- Do not store above 60°C. Avoid storing in direct sunlight.
- Do not use any battery packs that are not designed for use with the product.
- Do not dispose of the battery pack in a fire.
- Do not crush, puncture, dismantle or otherwise damage the battery pack.
- Do not dismantle, open or shred battery packs.
- Do not expose the battery pack to heat or fire as it may explode.
- Do not subject the battery pack to mechanical shock.
- Do not dispose of the exhausted battery pack in household waste.
- To dispose of the exhausted battery pack, take it to a local recycling station.
- Contact the local government offices for further details.
- This appliance is fitted with a 29.6V 2500mAh Li-ion rechargeable battery.

WARNING

Read all safety warnings and instructions. Failure to follow the warnings and instructions may result in electric shock, fire and/or serious injury.

1. Prevent unintentional starting ensure the switch is in the off-position before connecting pack, picking up, or carrying the appliance.
Carrying the appliance with your finger on the switch or energizing appliance that have the switch on invites accidents.
2. Disconnect the battery pack from the appliance before making any adjustments changing accessories or storing appliance.
Such preventive safety measures reduce the risk of starting the appliance accidentally.
3. Recharge only with the charger specified by the manufacturer. A charger that is suitable for one type of battery pack may create a risk of fire when used with another battery pack.
4. Use appliances only with specifically designated battery packs.
Use of any other battery packs may create a risk of injury and fire.
5. When battery pack is not in use, keep it away from other metal objects, like paper clips, coins, keys, nails, screws or other small metal objects, that can make a connection from one terminal to another.
Shorting the battery terminals together may cause burns or a fire.
6. Under abusive conditions, liquid maybe ejected from the battery; avoid contact.
If contact accidentally occurs, flush with water.
If liquid contacts eyes, additionally seek medical help.
Liquid ejected from the battery may cause irritation or burns.
7. Do not use a battery pack or appliance that is damaged or modified.
Damaged or modified batteries may exhibit unpredictable behavior resulting in fire, explosion or risk of injury.
8. Do not expose a battery pack or appliance to fire or excessive temperature.
Exposure to fire or temperature above 130°C may cause explosion.
The temperature of 130°C can be replaced by the temperature of 265 °F.
9. Follow all charging instructions and do not charge the battery pack or appliance outside of the temperature range specified in the instructions.
Charging improperly or at temperatures outside of the specified range may damage the battery and increase the risk of fire.
10. Have servicing performed by a qualified repair person using only identical replacement parts.
This will ensure that the safety of the product is maintained.
11. Do not modify or attempt to repair the appliance or the battery pack (as applicable) except as indicated in the instructions for use and care.

Product Parts List and Schematic

Item	S6T	S6P Pro
	✓	✓
	✓	✓
	✓	✓
	✓	✓
	✓	✓
	✓	✓
	✓	✓
	✓	✓ 2 Pack
	✓	✓
	✓	✓
	✓	✓
	✓	✓
	✓	✓
	✓	✓
	✓	✓
	✓	✓

* Actual accessories may vary from shown or change without notice.

* Available accessories may vary by market.

Product Overview

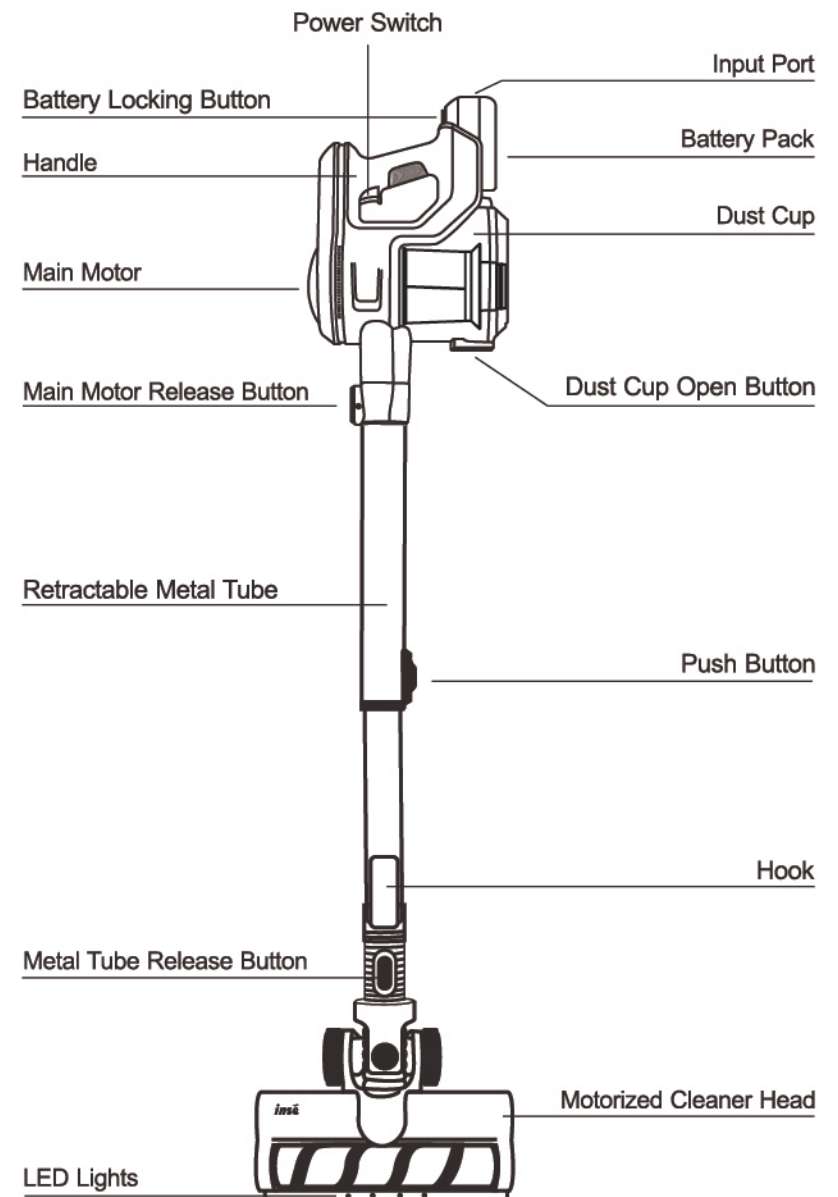

Assembly and Storage

1. Insert the tube end into the cleaner head port until you hear a click, make sure the connection is tight. And press the metal tube release button with one hand, hold the tube with another hand and then pull it out to remove it.

2. Insert the metal tube end into the suction port of the main motor until you hear a click, make sure the connection is tight. And press the main motor release button with one hand, hold the main motor with another hand and then pull the handle to remove the main motor from the tube.

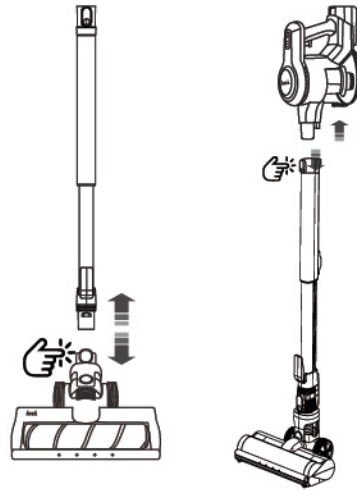

Way 1:
Hanging the whole machine onto the wall bracket

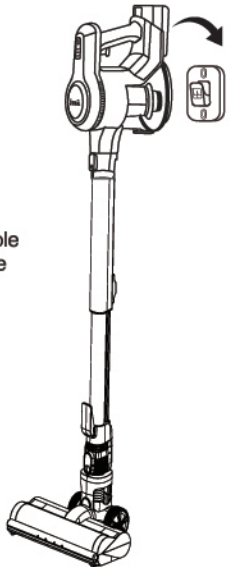

Way 2:
Hanging the main motor onto the hook of the metal tube

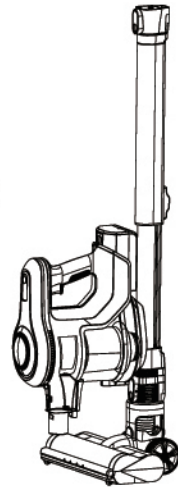

Ready to Use

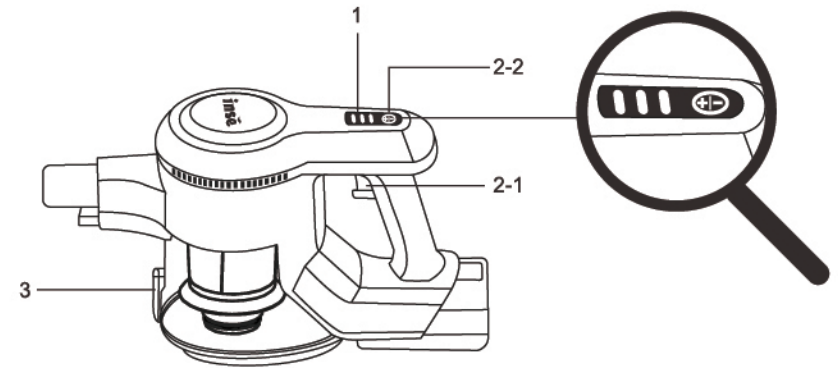

1. Preparation

Please check if the battery power is sufficient before using. It's suggested to charge over 5-6 hours before the first time of use to ensure utmost performance of the product. Choose the attachment you need according to the cleaning area/surface.

2. Start to Work

2-1 Press the power switch to turn on the vacuum, then second press to MAX mode, third-time press to turn it off.

2-2 Press the +/- button to switch the power mode between MAX and Standard.

- ❶ HOUSEHOLD USE ONLY
- ❶ DO NOT use outdoors or on wet surfaces
- ❶ DO NOT immerse in water

3. Dust Cup Cleaning

After turning off, press the button to release the dustbin cover, dump the dirt and then close the cover until you hear a click.

Charging

- * For safety, the battery was charged up to 30% battery capacity before shipping. Please fully charge the battery before first use.
- * It takes about 5.5 hours to fully charge the battery from flat status.

Way 1: Insert the battery pack into the main motor; insert the power plug into the battery pack; connect the power adaptor with the power supply



Way 2: Charge the separate battery directly

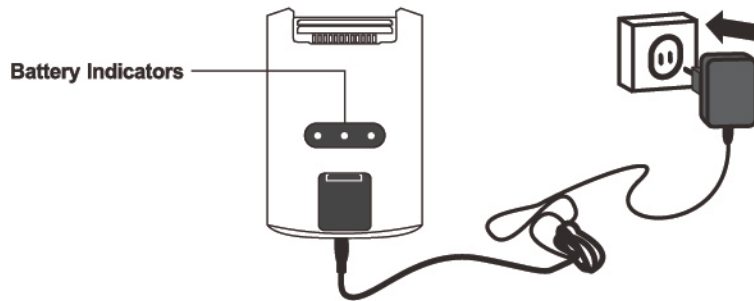

Battery Indicators

On Work

- Three solid blue lights: **full power**
- Two solid blue lights: **medium power**
- One solid blue light: **low power**
- One blinking blue light: **lower than 5% of the total power, needs a recharge**

During Charging

- Three blue lights blinking successively: **charging**
- Three steady lights: **charging complete**

! Notes:

- * The machine cannot be turned on during charging
- * Charge the battery only with the adaptor (36v) provided by INSE
- * When you won't use the battery for a long time, please store it in a cool dry place. In this situation, please ensure that the battery has been half charged (2 glowing indicator lights)
- * If you need an additional battery, please purchase from an authorized distributor of INSE

Product Technical Parameters

Product Category	Vacuum Cleaner		
Product Weight (Including All Attachments)	S6T: 3.6kg / S6P Pro: 4.0kg		
Product Net Weight (Main Motor with Battery)	1.5kg/3.3lb	Rated Power	265W
Dust Cup Capacity	1.2L	Rated Voltage	29.6V
Charging Time	5.5 hours	Power Adapter Input	100-240V~50/60Hz
Battery Capacity	2500mAh	Power Adapter Output	36V 500mA

Power Mode and Runtime

Note:

- * Any runtime posted on the website is the time when the machine runs without attaching to any surface and debris.
- * Actual runtime will vary based on the power mode, battery capacity, attachment, debris amount, cleaning area/surface.

	Runtime	Suction Power
Standard Mode	35-45 minutes	12KPa
Max Mode	12-20 minutes	23KPa

Accessory Instructions



Motorized Cleaner Head

Can be connected to the metal tube for daily cleaning on the floor or carpet, or to the main motor for cleaning the trunk



Stiff Roller Brush

Can be installed into the cleaner head; Ideal for both hard floors and carpets



Soft Roller Brush

Can be installed into the cleaner head; Perfect for hard floors, performs better for removing fine dirt from wood floor

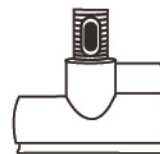

Mini Motorized Cleaner Head

Perfect for picking up hair and dust mite from fabric surface like sofa and mattresses like bed, pillow

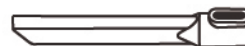

Long Crevice

For corners and other hard-to-reach places; can be connected to the metal tube to clean spider web on the ceiling



Flexible Hose

Can be connected with long crevice or 2-in-1 brush, perfect for cleaning corners inside the car or cabinet



2-in-1 Brush

Can be switched into a brush or a wide crevice; suitable for fabric surface and corners



2-in-1 Cleaning Gadget

The blade end can be used to cut off hair that wrapped around roller brush, the another brush end can be used to clean dirt inside dustbin, strainer or cleaner head