

miku

Let's get started.



## Content

Safety	4
In the box	5
What you'll need	6
Get the app	7
Installation	8
Limited Warranty & Compliance	24

For installation videos visit [mikucare.com/support](https://mikucare.com/support)

# Safety

**STRANGULATION HAZARD** — Children have STRANGLED in cords.

NEVER attempt to use cord without the protective covering. Check protective covering before each use to ensure that the cord is not exposed to your child. Immediately discontinue use if protective covering is damaged or broken. This device is designed for indoor use only. This device is designed to be used behind a standard crib and against the wall only. Use only the AC power supply included with your Miku. Adult assembly is required. Keep small parts away from children when assembling. This product cannot replace adult supervision. Ensure your child's health by checking on him/her regularly. This product is not a toy. Do not allow children to play with it.

**DISCLAIMER** — Miku Baby Monitor was created to help parents track factors that affect their baby's sleep schedule and general wellbeing. It is not intended to cure, treat, or prevent any disease or health condition, including, but not limited to, Sudden Infant Death Syndrome (SIDS). No baby monitor can ever replace you as a caregiver, or substitute for asking your doctor for medical advice.

**PELIGRO DE ESTRANGULAMIENTO** — Niños se han ESTRANGULADO con el cordón.

NUNCA intente de usar el cordón sin cobertura de protección. Cheque la cobertura de protección antes de cada uso para asegurarse que el cordón no esté expuesto a su hijo(a). Inmediatamente pare el uso si la cobertura de protección está dañada o quebrada. Este aparato está diseñado para uso de interior. Este aparato está diseñado para uso detrás de cuna estándar y contra la pared solamente. Use solamente el fuente de alimentación de CA incluido con su Miku. Asamblea de adulto es necesario. Mantenga partes pequeñas lejos de los niños cuando esté armando. Este producto no es reemplazo de la supervisión de adulto. Asegure la salud de su hijo(a) por chequeando en él o ella regularmente. Este producto no es un juguete. No permita que su hijo(a) juegue con el aparato.

**DESCARGO DE RESPONSABILIDAD** — Miku Baby Monitor fue creado para ayudar a los papás rastrear factores que afectan el horario de sueño y el bienestar general de su hijo(a). El intento no es curar, tratar, o prevenir cualquier enfermedad o condición de salud, incluyendo, pero no limitado a, el Síndrome de Muerte Súbita Infantil. Ningún monitor de bebé puede reemplazar a usted de un cuidador o cuidadora o ser un sustituto de conseguir consejo médico de su doctor.

## In the box



Baby Monitor



Pencil



Wall Mount  
& Level



Measuring Tape



Screwdriver

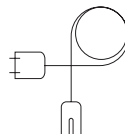

Power Cord

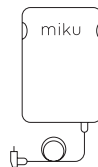

Power Supply



Cable Guides



Large Drywall Anchors



Screws

### Optional Universal Hardware

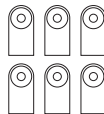

Wall Guides

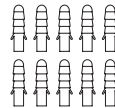

Small Universal  
Anchors

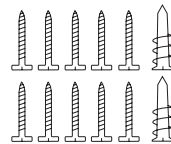

Extra Screws &  
Large Drywall Anchors

QSGV006

## What you'll need

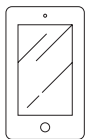

Smart Device

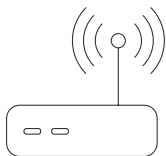

WiFi Internet

## Get the app

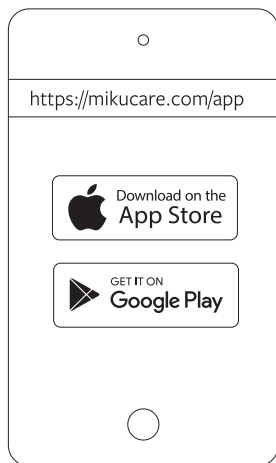

### Now, get the app.

Download the free Miku app from [mikucares.com/app](https://mikucares.com/app) and create your user account.

Open the App and follow along to pair your Miku.

## Installation

1.

---

Position the crib against the preferred wall in the nursery.

**IMPORTANT: CRIB CENTER MUST BE IN A STUD-FREE AREA OF THE WALL.** *If unsure, use a stud finder.*

*For wall surfaces other than drywall, please view our support page at [mikucare.com/support](https://mikucare.com/support)*

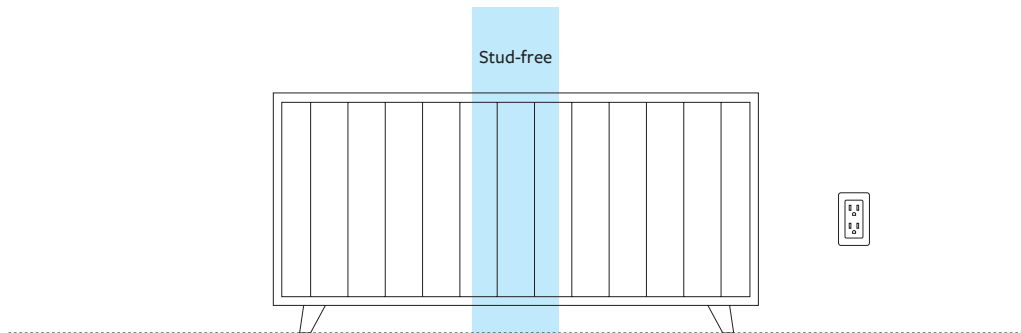



2.

---

Using the Measuring Tape, find the center of the crib and mark the wall with a pencil.

**Note:** *Center of crib must be within 6 feet of an electrical outlet.*

Then, move the crib away from the wall.

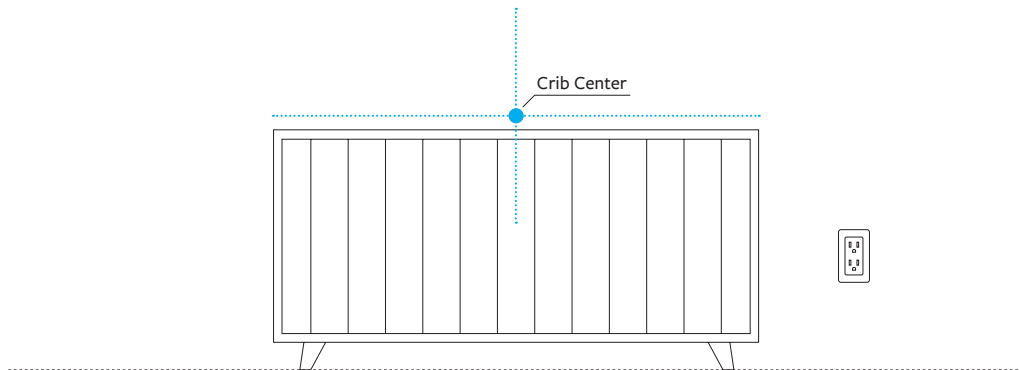

3.

---

Step on the bottom of the Measuring Tape so it aligns with the floor and your “Crib Center” mark on the wall. Lift the tape up 60 inches and mark at the “MARK HERE” indicator.

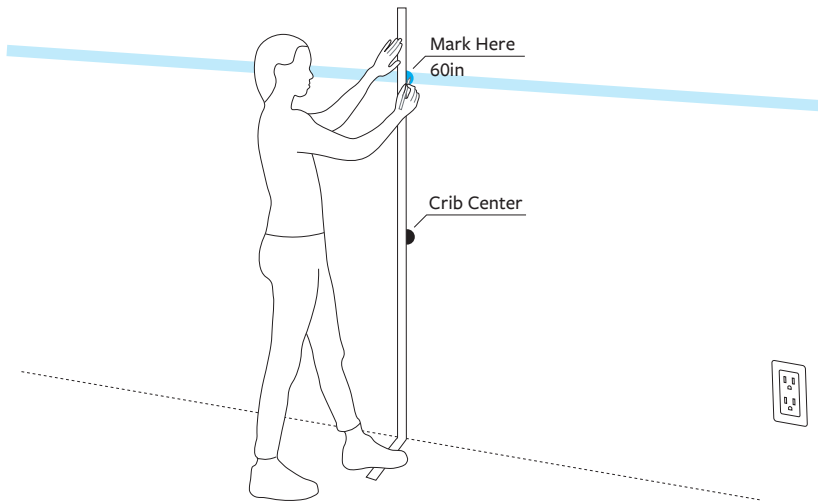

4.

---

Take the Wall Mount and place it over your mark at 60 inches so you can see the mark through the center hole.

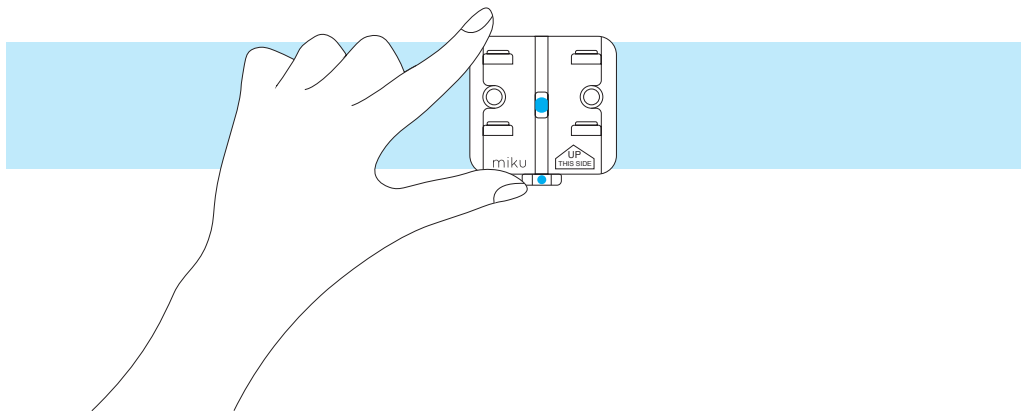

5.

---

Use the Level below the Wall Mount to verify that it is level. Mark the wall through the two holes in the Wall Mount.

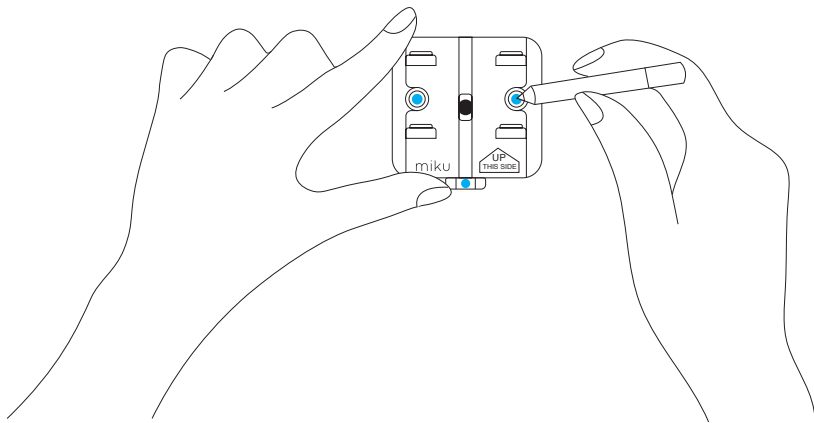

6.

---

Pull and remove the Level from the bottom of the Wall Mount.

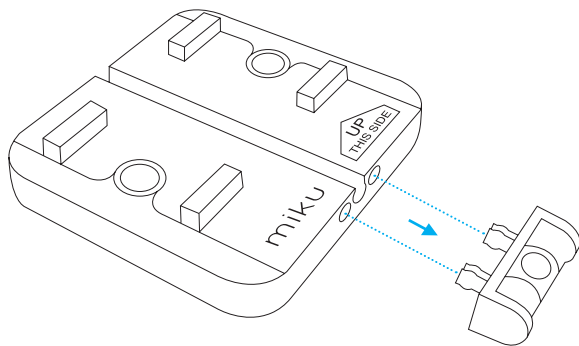

7.

---

Using the Screwdriver, push and twist into the two marks to create larger holes in the drywall. Only push as far as the black tip of the Screwdriver.

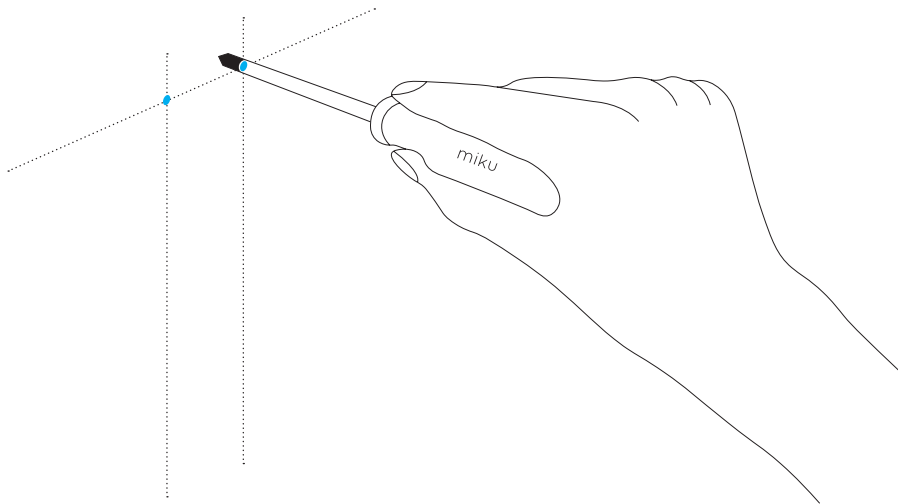

8.

---

Push the Large Drywall Anchors into each hole and screw them until they are flush.

**Note:** *If the wall anchor doesn't screw into the wall easily, you may have hit a stud. In this case no wall anchor is required for that hole.*

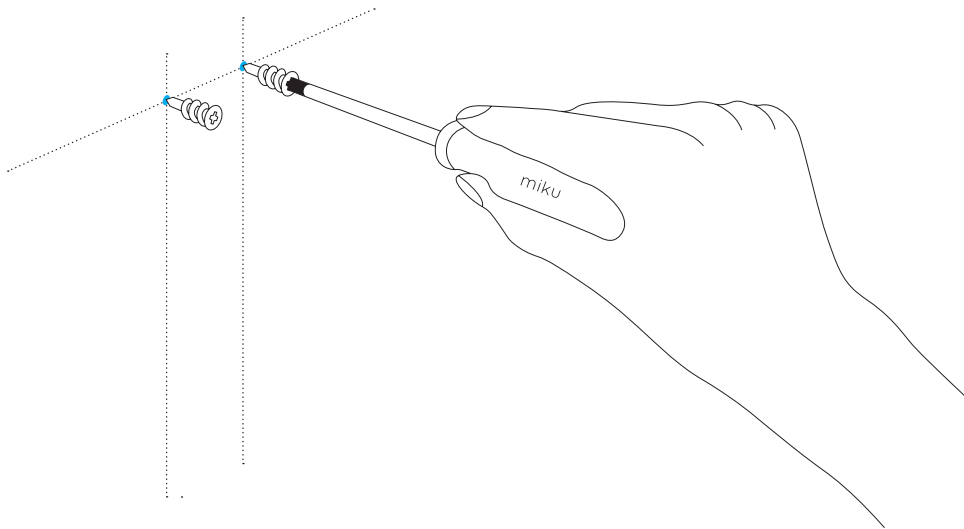

9.

Position the Wall Mount over the “+” holes of the anchors. Screw the Large Screws into the “+” holes and secure the Wall Mount until flush with the wall.

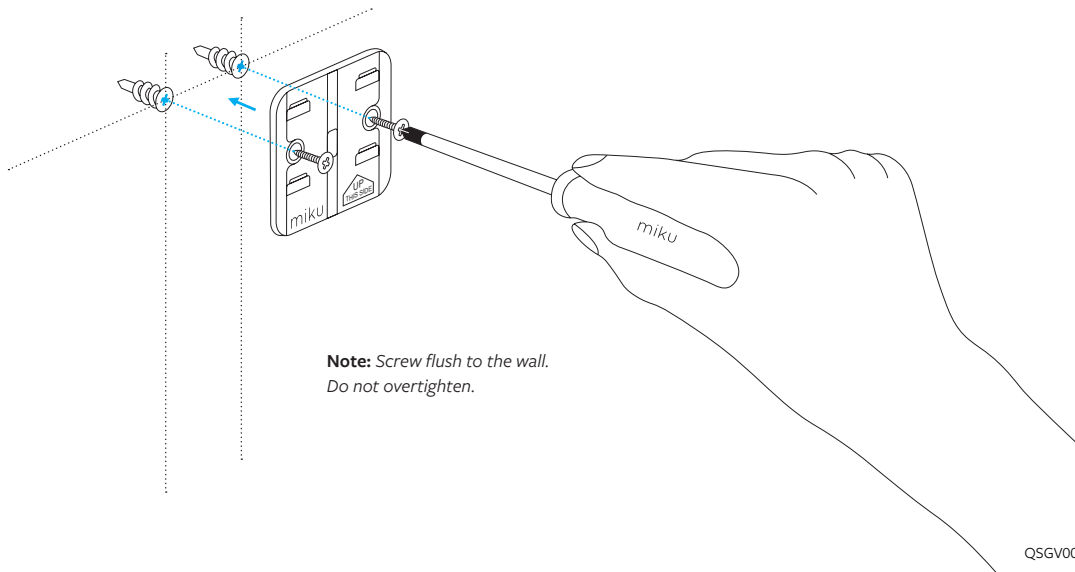



10.

---

Unroll the Power Supply and align the top rubber indicator to the center of the Wall Mount, leaving the top of the cord hanging. Using the Screwdriver, push the rubber indicator into the Wall Mount to secure the Power Supply.

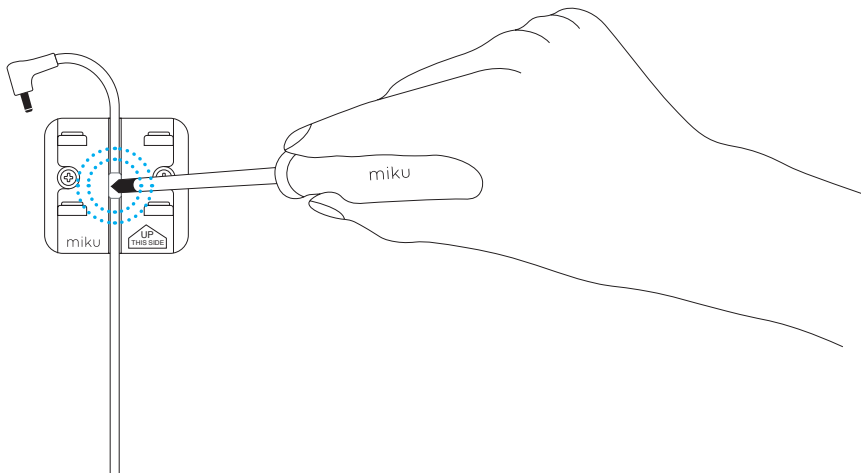

11.

---

Slide the base of the Miku device into the Wall Mount until it clicks.

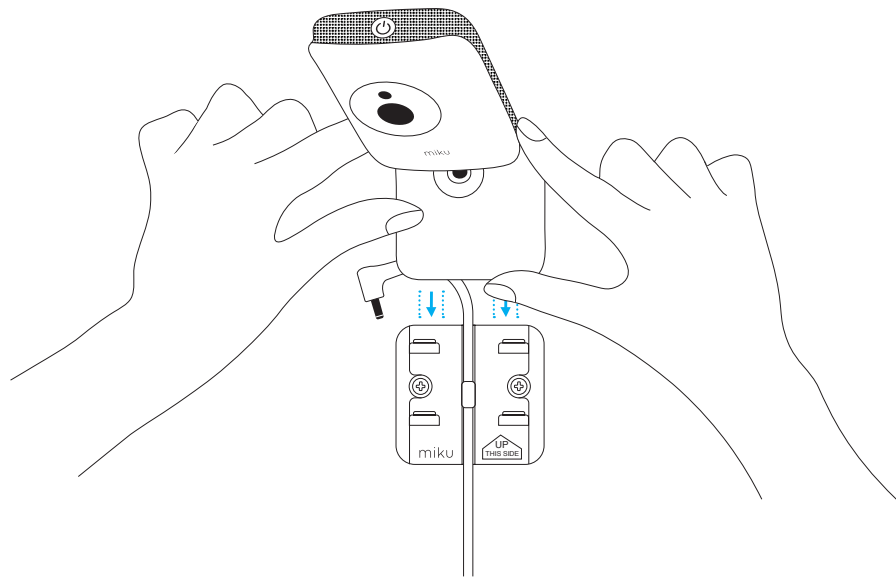

12.

---

Plug the Power Supply into the back of the Miku device.

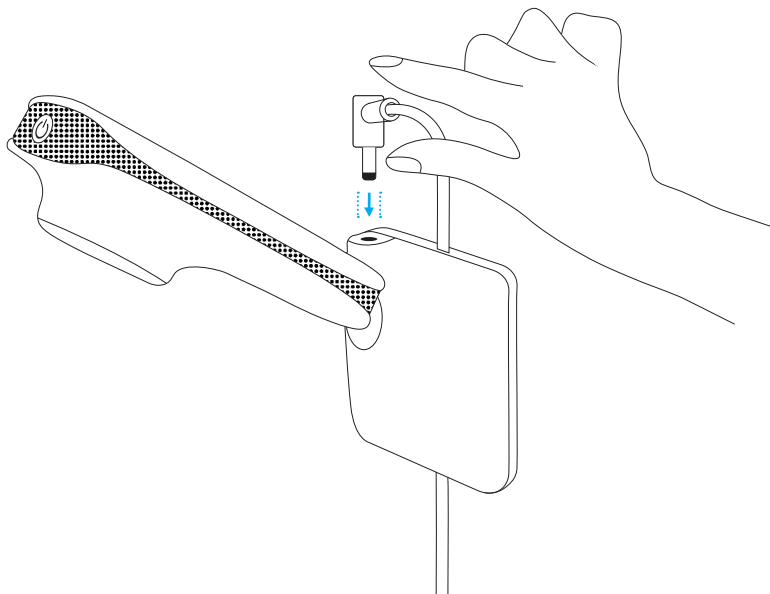

13.

---

(a) Insert the first Cable Guide into the bottom holes of the Wall Mount, making sure the Cable Guide is covering the cord. (b) Remove the adhesive strips and adhere to wall.

**Note:** *If you need to customize your cord path, you may need to use our Optional Cable Guide Hardware.*

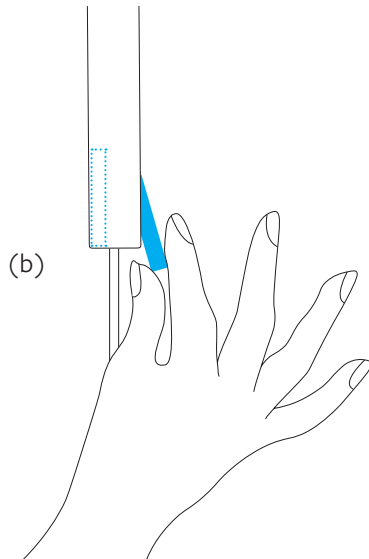
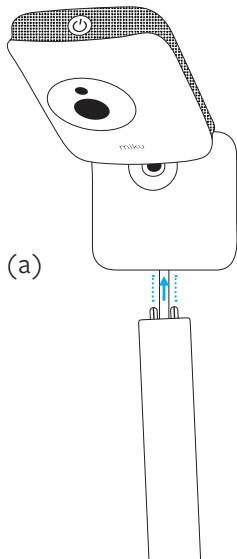

14.

---

(a) Insert each Cable Guide into the bottom holes of the previously installed section. Remove the adhesive strips and adhere to the wall. (b) One by one, repeat for remaining Cable Guides.

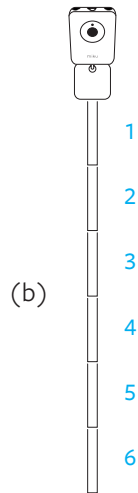
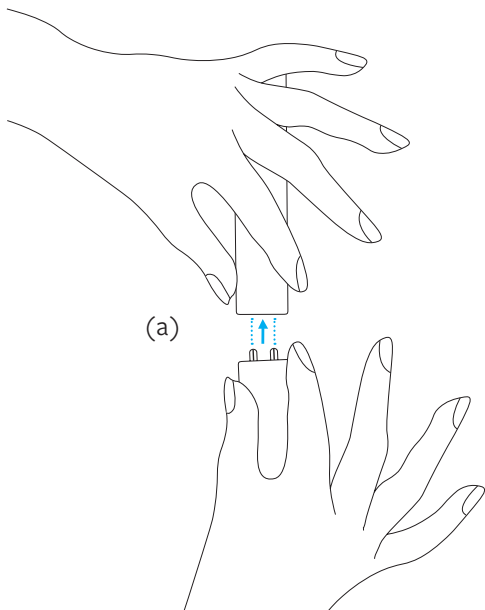

15.

---

Connect the Power Cord to the Power Supply.

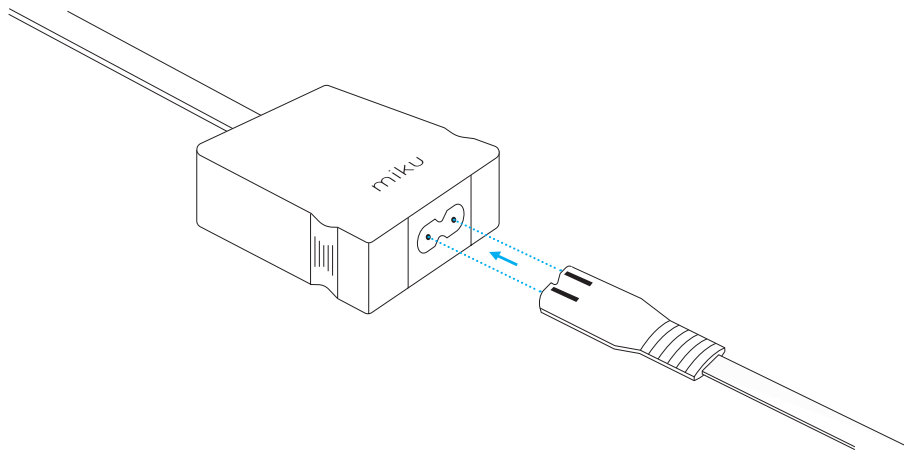

16.

---

Plug the Power Cord into the nearest outlet and press Miku's power button.  
Once it is powered, you're ready to go.

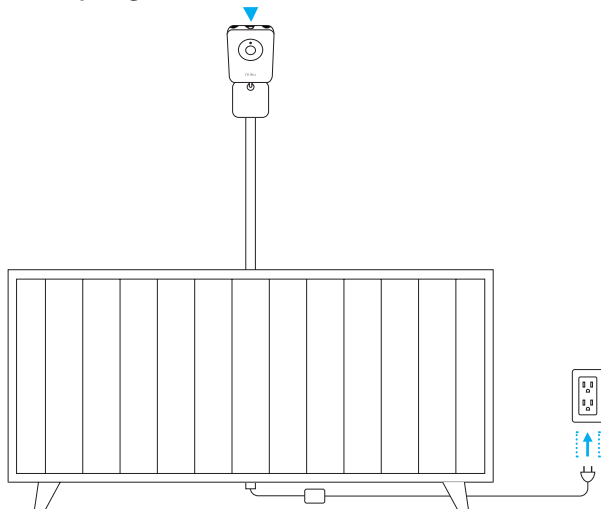

## Limited Warranty & Compliance

For information on Miku's Limited Warranty visit: [mikucare.com/warranty](https://mikucare.com/warranty)

**Miku, Inc.** | Miku Life Monitor | Model No: M0100 | FCC ID: 2AQM3M0100 | Contains TX FCC ID: 2AD9QX4M02  
IC: 24123-M0100 | Contains TX IC ID: 22782-X4M02 | CAN ICES-3(B)/NMB-3(B)



This device complies with Part 15 of the FCC Rules. Operation is subject to the following two conditions:

- (1) this device may not cause harmful interference, and
- (2) this device must accept any interference received, including interference that may cause undesired operation.

This equipment has been tested and found to comply with the limits for a Class B digital device, pursuant to Part 15 of the FCC Rules. These limits are designed to provide reasonable protection against harmful interference in a residential installation. This equipment generates, uses and can radiate radio frequency energy and, if not installed and used in accordance with the instructions, may cause harmful interference to radio communications. However, there is no guarantee that interference will not occur in a particular installation. If this equipment does cause harmful interference to radio or television reception, which can be determined by turning the equipment off and on, the user is encouraged to try to correct the interference by one or more of the following measures:

- Reorient or relocate the receiving antenna.
- Increase the separation between the equipment and receiver.
- Connect the equipment into an outlet on a circuit different from that to which the receiver is connected.
- Consult the dealer or an experienced radio/TV technician for help.



**CAUTION**

Any changes or modifications not expressly approved by the grantee of this device could void the user's authority to operate the equipment.

**RF EXPOSURE WARNING:**

The equipment complies with FCC RF exposure limits set forth for an uncontrolled environment.

The equipment must not be co-located or operating in conjunction with any other antenna or transmitter. This equipment should be installed and operated with minimum distance 20cm between the radiator and your body. It could be removed.

**CANADA, INDUSTRY CANADA (IC) NOTICES**

This device complies with Canada licence-exempt RSS standard(s).

Operation is subject to the following two conditions: (1) this device may not cause interference, and (2) this device must accept any interference, including interference that may cause undesired operation of the device.

**CANADA, AVIS D'INDUSTRIE CANADA (IC)**

Cet appareil est conforme avec Industrie Canada exemptes de licence RSS standard(s).

Son fonctionnement est soumis aux deux conditions suivantes : (1) cet appareil ne doit pas causer d'interférence et (2) cet appareil doit accepter toute interférence, notamment les interférences qui peuvent affecter son fonctionnement.

**RADIO FREQUENCY (RF) EXPOSURE INFORMATION**

The radiated output power of the Wireless Device is below the Industry Canada (IC) radio frequency exposure limits. The Wireless Device should be used in such a manner such that the potential for human contact during normal operation is minimized.

This device has also been evaluated and shown compliant with the IC RF Exposure limits under mobile exposure conditions. (antennas are greater than 20cm from a person's body).

**INFORMATIONS CONCERNANT L'EXPOSITION AUX FRÉQUENCES RADIO (RF)**

La puissance de sortie émise par l'appareil de sans fil est inférieure à la limite d'exposition aux fréquences radio d'Industry Canada (IC). Utilisez l'appareil de sans fil de façon à minimiser les contacts humains lors du fonctionnement normal.

Ce périphérique a également été évalué et démontré conforme aux limites d'exposition aux RF d'IC dans des conditions d'exposition à des appareils mobiles (antennes sont supérieures à 20 cm à partir du corps d'une personne).

#### **RF EXPOSURE INFORMATION**

This device meets the EU requirements (2014/53/EU) on the limitation of exposure of the general public to electromagnetic fields by way of health protection.

#### **CE MARK WARNING**

This is a Class B product, in a domestic environment, this product may cause radio interference, in which case the user may be required to take adequate measures.

#### **POWER ADAPTER WARNING**

The adapter shall be installed near the equipment and shall be easily accessible.

#### **SIMPLIFIED EU DECLARATION OF CONFORMITY**

Hereby, Miku, Inc., 10 Woodbridge Center Drive Suite 650, Woodbridge, NJ 07095 declares that the radio equipment type Miku Life Monitor M0100 is in compliance with Directive 2014/53/EU. The full text of the EU declaration of conformity is available at the following internet address: [mikuare.com/EU](http://mikuare.com/EU)

	<b>AT</b>	<b>BE</b>	<b>DK</b>	<b>GE</b>	<b>EL</b>
	<b>ES</b>	<b>FI</b>	<b>FR</b>	<b>IE</b>	<b>IT</b>
	<b>NL</b>	<b>PL</b>	<b>SE</b>	<b>UK</b>	

#### **THE ABBREVIATIONS FOR MEMBER STATES SHALL BE AS FOLLOWS:**

Belgium (BE), Bulgaria (BG), Czech Republic (CZ), Denmark (DK), Germany (DE), Estonia (EE), Ireland (IE), Greece (EL), Spain (ES), France (FR), Croatia (HR), Italy (IT), Cyprus (CY), Latvia (LV), Lithuania (LT), Luxembourg (LU), Hungary (HU), Malta (MT), Netherlands (NL), Austria (AT), Poland (PL), Portugal (PT), Romania (RO), Slovenia (SI), Slovakia (SK), Finland (FI), Sweden (SE) and United Kingdom (UK).

This device meets the EU requirements (2014/53/EU) on the limitation of exposure of the general public to electromagnetic fields by way of health protection. This equipment should be installed and operated with minimum distance 20 cm between the radiator and your body .



