

CE6000 SERIES

CUTTING PLOTTER

SETUP MANUAL

MANUAL NO.CE6000-UM-8M4

Preface

Thank you for choosing this product. Carefully keep this manual in a handy location for quick reference as necessary prior to use to ensure safe and correct use and also to thoroughly understand the functions and operate them effectively.

Prior to use

Be sure to read the attached "TO ENSURE SAFE AND CORRECT USE" prior to use. Otherwise, it may cause an unexpected accident or fire.

Notes on this Manual

- (1) No part of this publication may be reproduced, stored in a retrieval system, or transmitted, in any form or by any means, without the prior written permission of Graphtec Corporation.
- (2) The product specifications and other information in this manual are subject to change without notice.
- (3) While every effort has been made to provide complete and accurate information, please contact your sales representative or nearest Graphtec vendor if you find any unclear or erroneous information or wish to make other comments or suggestions.
- (4) Notwithstanding the stipulations in the preceding paragraph, Graphtec Corporation assumes no liability for damages resulting from either the use of the information contained herein or the use of the product.

Registered Trademarks

All names of companies, brands, logotypes, and products appearing in this manual are the trademarks or registered trademarks of their respective companies.

Copyright

This User's Manual is copyrighted by Graphtec Corporation.

Roles of each manual

- Setup Manual (this manual) Read it to understand Displaying method for User's Manual, Method for connecting this Cutting Plotter with the PC, Installing method for controller driver software, and to prepare for the operation.
- User's Manual (PDF data) Read it to thoroughly understand the functions.
- Cutting Plotter Controller Manual (PDF data) Read it to run the software "Cutting Plotter Controller" for operation of this Cutting Plotter through your PC.

Before starting the Setup

Make the following preparations before starting Setup.

- Check that all of the items included in the package. (Please see the User's Manual (PDF).
For the Parts Names, please see the User's Manual (PDF).
- Assemble this Cutting Plotter, and set up it. For the assembling procedures, see either Manual attached to the Stand or User's Manual (PDF).
- To use the Cutting Master 4, previously install the Design application (Adobe Illustrator or CorelDRAW) that is used.
For the latest supported version, please visit our website.
- When there are virus detection program or system resident program, terminate them beforehand.
- Upon installation, be sure to log into Windows using an account with administrator privileges on your computer.

CAUTION

Usage of the software

Each of the Cutting Plotter Controller/Graphtec Studio software is engaged in various settings on the Cutting Plotter. Do not use them at the same time.

Flow of setup

Setting up the Plotter main unit

1. Attaching a Tool	The cutter blade can be replaced depending on the material or thickness of the media.	P.03
2. Loading Media (Paper or Marking Film)	Fix the media to the Plotter.	P.04
3. Aligning the Push Rollers	Adjust the position of the push roller.	P.09
4. About the Initial Setup screen	Select "Display Language" and "Length Unit".	P.10
5. Set the media type into the Plotter	Set the media type to the Cutting Plotter, depending on the set media.	P.10
6. Tool adjustment and test cutting	Adjust the protruded cutter edge length and the cutting Force depending on the material and thickness of the media. Make test cutting for the set media to adjust the best condition.	P.11

Installing the Software

• Setup in a Windows operating environment

Launching the Start menu	For each software, install them using the Installer housed in the attached DVD-ROM.	P.14
A. Install CE6000Plus Software		
Installing the Cutting Plotter Controller	Once Cutting Plotter Controller is installed, you can control main functions of the Cutting Plotter through the PC.	P.16
Installing the Driver software (Cutting Plotter Driver)	The Driver software controls the Plotter and makes plotting according to the data created by the PC.	P.16
• To connect using the USB	Turn on the power source of Plotter in the middle of installing, and connect the USB cable.	P.17

Install the software as necessary.

B. Setup the Graphtec Pro Studio	Software enabling cutting data to be created through simple commands. Create designs and edit characters/shapes using this software.	P.18
C. Setup the Cutting Master 4	Plug-in driver that enables simple cutting through direct operation from within Adobe Illustrator and CorelDRAW.	P.18
D. Install the User's Manual	Installs the User's Manual.	P.18

• Setup in a Macintosh operating environment

A. Setup the Cutting Master 4	Plug-in driver that enables simple cutting through direct operation from within Adobe Illustrator.	P.19
B. Setup the Graphtec Studio	Software enabling cutting data to be created through simple commands. Create designs and edit characters/shapes using this software.	P.19

Setting up the Plotter main unit

1. Attaching a Tool

Attach a tool (cutter plunger, plotter pen) to the plotter.

Attaching a Tool

When mounting the tool in the tool holder, please note the following.

- Push the tool all the way into the holder until its flange contacts the upper part of the holder and then tighten the screw firmly.
- To prevent injury, avoid absolutely touching the tool immediately after the cutting plotter is turned on or whenever the tool is moving.

For details, see “Attaching a Tool” on in User’s Manual.
It is explained here using cutter plunger as an example.

CAUTION

When pushing the tool holder with your fingers, the blade tip may be protruding. Take care not to cut your fingers.

Supplement

- When using with half cutting and plotter pen, set the seal in Tool Holder 1 (backward), and when using cutting out (perforated cut), set the seal in Tool Holder 2 (forward).
- Cutting out means that the media is cut out completely.
- Half cutting means that only the marking film is cut out, leaving the backing sheet uncut.

1 Loosen the tool holder screw.

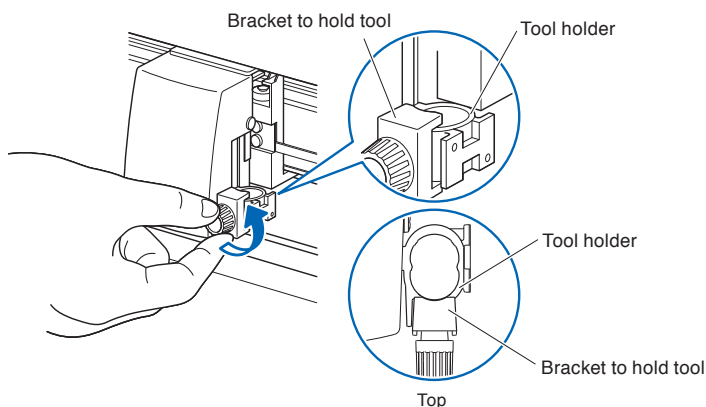

2 While pushing up the tool holder, push until its flange completely touches the upper part of the holder.

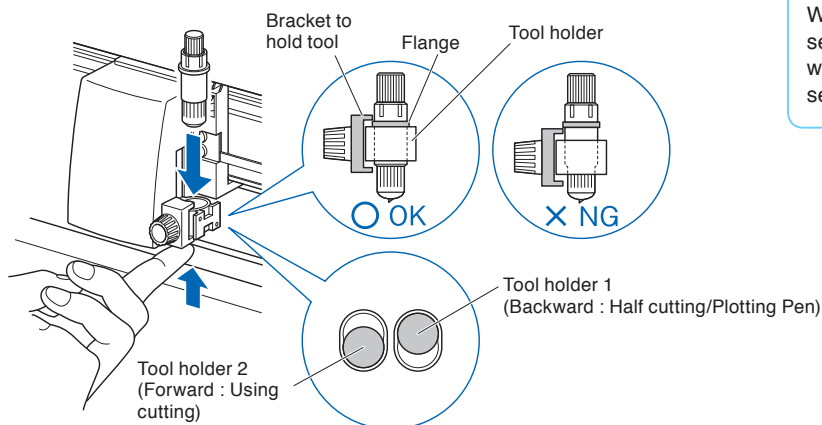

Supplement

When using with half cutting and plotter pen, set the seal in Tool Holder 1 (backward), and when using cutting out (perforated cut), set the seal in Tool Holder 2 (forward).

3 Make sure that the tool bracket is engaged on the tool's flange, and then tighten the screw.

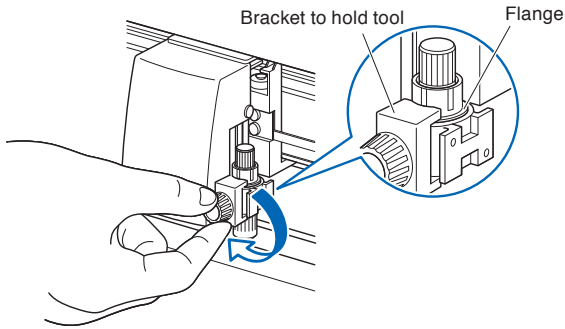

Removing the tool

When removing the tool, turn it counterclockwise to remove the tool.

2. Loading Media (Paper or Marking Film)

Both roll media and sheet media can be used with the CE6000.

Load the media according to the instructions given for each type. Use the grit roller on the right side of the media (looking from the front) as a guide when setting it in the media sensor. Afterwards, adjust the push roller so that it's lined up with the side of the media.

For details, see User's Manual (PDF).

Loading Roll Media

1 Lower the media set lever to raise the push rollers.

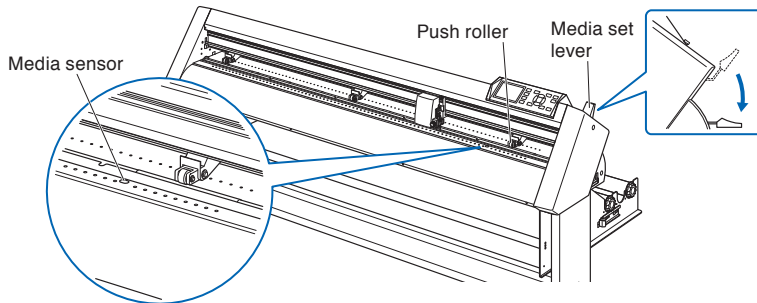

Supplement

For more information about the position of the push roller, see "Adjust the Push Roller".

2 Set the roll media on top of the stock shaft, and then insert the roll media into the stopper. Once it's set, tighten the stopper's screws.

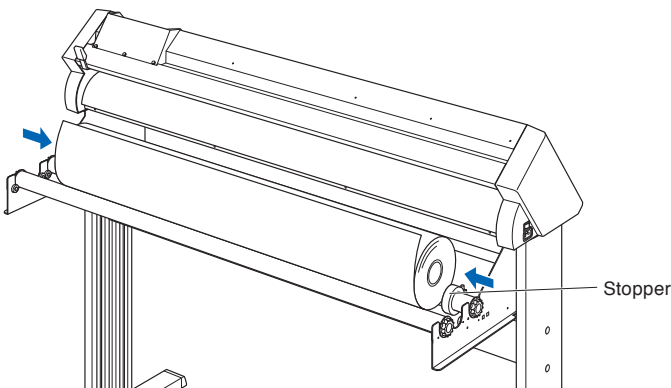

- 3 Push the tip of the roll media forward from the back of the CE6000. Make sure to pull it so that there is no slackening across the roll media's route.

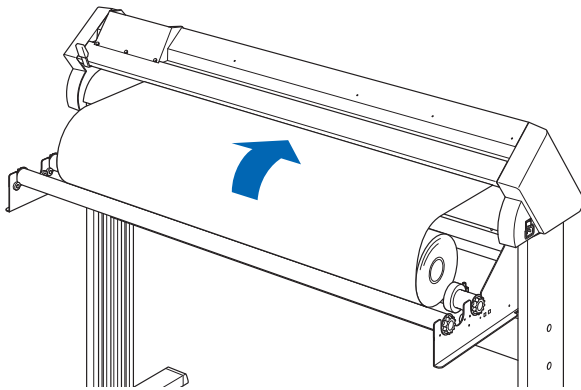

When using the roll media tray

Put the roll media on the roll media tray and then push the tip of the roll media forward from the back of the machine.

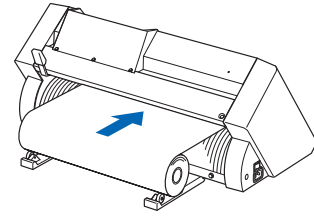

- 4 Press the media stopper to engage it, and then pull the leading edge out of the front of the plotter, making sure that it completely covers the media sensor.

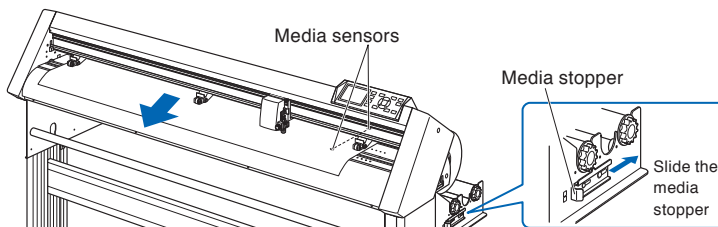

Media stopper

This stops the stock shaft from spinning when setting in media. It is also utilized when pulling roll media straight out.

Supplement

When actually cutting, please release the lock from the media stopper (while pulling to the exterior, slide it forward).

- 5 Position the media and the push rollers to correspond with the width of the media.

When using the model with 2 push rollers

The push rollers push down on either side of the media. Use the grit roller position guide to make sure the push rollers are set on top of the grit rollers.

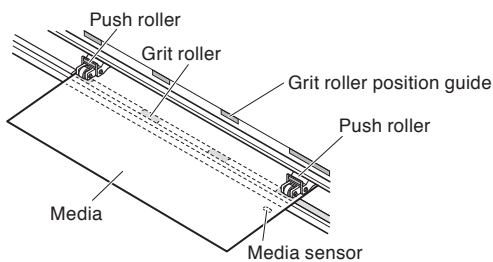

Supplement

- The media must always be positioned over the media sensor.
- See "Aligning the Push Rollers" about the position of the push rollers.

When using the model with 4 push rollers

Use the 4 push rollers to push down the sides and center of the media. Use the grit roller position guide and make sure the push rollers are on top of the grit rollers.

You can adjust the center push roller's hold-down force.

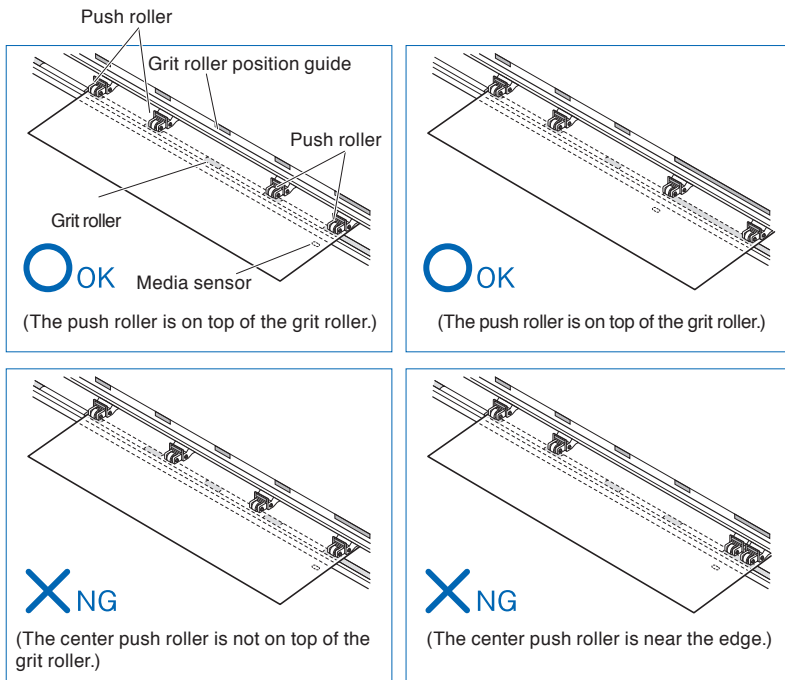

Supplement

- The media must always be positioned over the media sensor.
- See "Aligning the Push Rollers" about the position of the push rollers.
- See "Aligning the Push Rollers" for information about push roller hold-down force.

When Feeding Long-axis Media (at exceeds 2 meters)

Position the push rollers at least 15 mm inside the edges of the media.

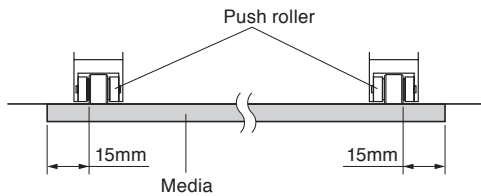

When Feeding Long-axis Media (at least 2 meters)

Position the push rollers at least 5 mm inside the edges of the media.

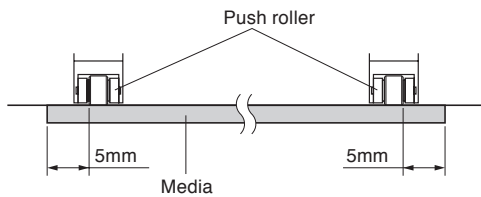

- 6 Pull the media taut to make sure that there is no slack in the conveyance path, and then raise the media set lever to lower the push rollers.

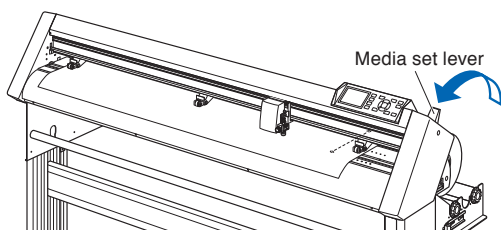

7 Release the lock from the media stopper (Pull the sides and slide it forward).

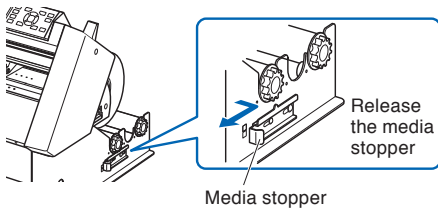

8 When the set lever is up (and the media is held down by the push rollers) and the media stopper is unlocked, pull out the roll media and give it slack.

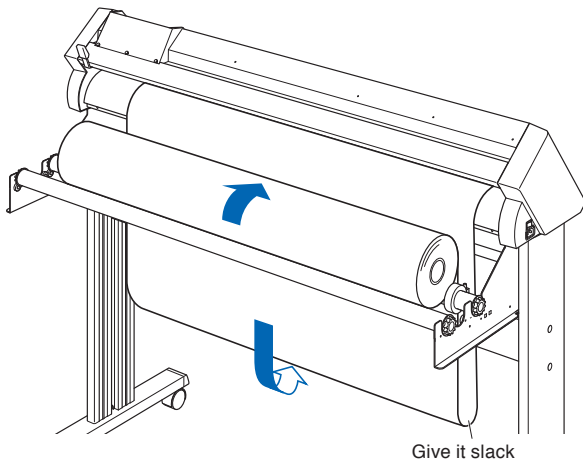

Create the same amount of slack in the media as will be used for the back of the machine.

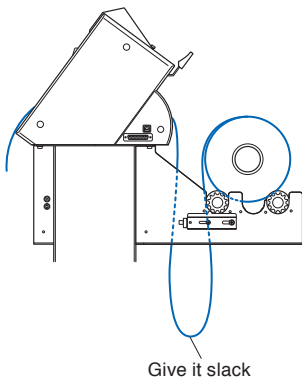

Supplement

Dirt from the floor may stick to the media when giving it slack, so please be careful.

When using the roll media tray

Create the same amount of slack in the media as will be used for the back of the machine.

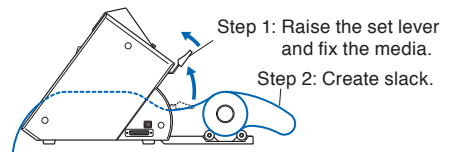

Loading Sheet Media

1 Lower the media set lever to raise the push rollers.

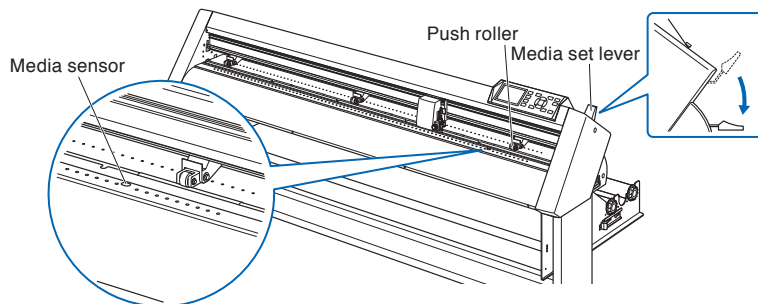

Supplement

See "Aligning the Push Rollers" about the position of the push rollers.

- 2 Make sure that the sheet media completely covers the media sensor.

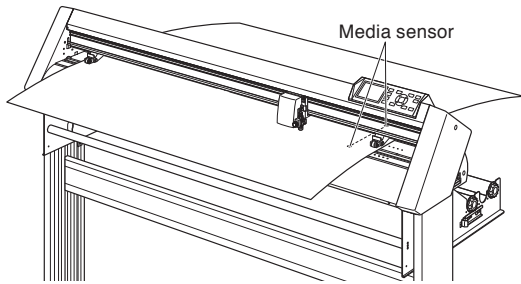

- 3 Position the media and the push rollers to correspond with the width of the media.

Supplement

Refer to the description of "Loading Roll Media".

- 4 Pull the media taut to make sure that there is no slack in the conveyance path, and then raise the media set lever to lower the push rollers.
Set the sheet media so that the paper's edges line up with the guideline on the front side.

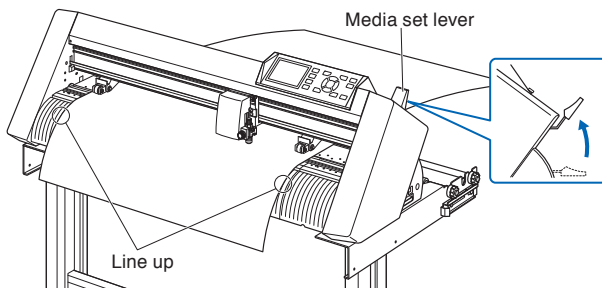

When using the model with media guide bar

- 4 Pull out the front media under the media guide bar.

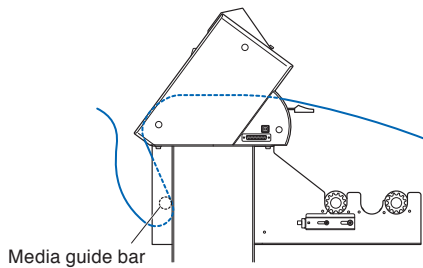

- 5 You can set the media straight by stacking media you pull out and matching the edges up together.
After you check to make sure there's no slack, raise the media set lever and fixate the sheet media in the push roller.

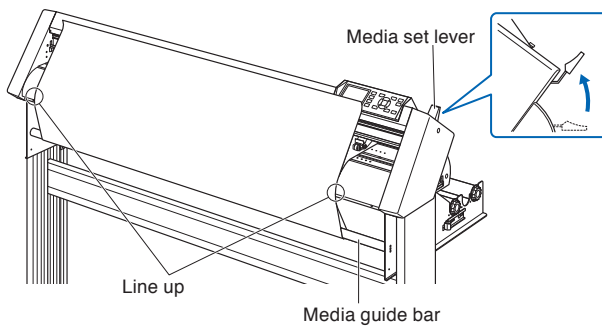

3. Aligning the Push Rollers

This section describes how to alignment of the push rollers.

Aligning the Push Roller

Position the left and right push rollers to correspond with the width of the media. Adjust the push rollers so that they are positioned above both the media and the grit rollers.

Position the push rollers within the grit roller position guides ensures that they are above the grit rollers.

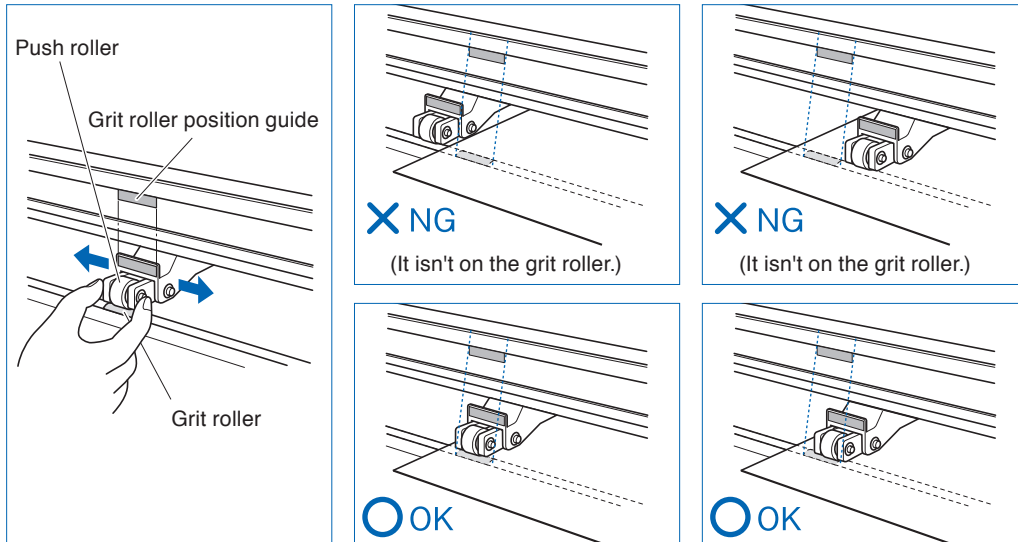

CAUTION

To move the push rollers, the media set lever must be in the lowered position.

Supplement

If a [confirming push roller point] message appears after setting the media and raising the media set lever, it means the right push roller is not on the right grit roller, or that the left or center push roller is not on the proper grit roller. Make sure everything is set correctly.

For minimum width media

Make sure that all push rollers are on the long right grit roller. Use the left side of the grit roller as a starting point and then set the push rollers so that they're on both sides of the media.

The settable width of the media is 55 mm or more (Model with 2 push rollers) or 125 mm* or more (Model with 4 push rollers).

* When using the model with 4 push rollers, and all push rollers are on the right grit roller (wide), turn the center (all rollers but the side rollers) push roller hold-down force OFF.

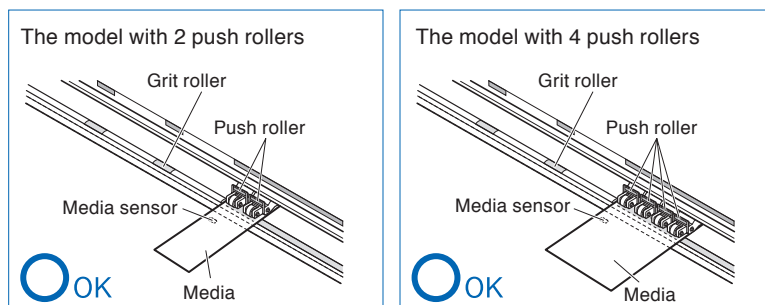

Supplement

The model with 4 push rollers requires the center push roller hold-down force to be set based on the media's width and material type in order to keep the media in place.

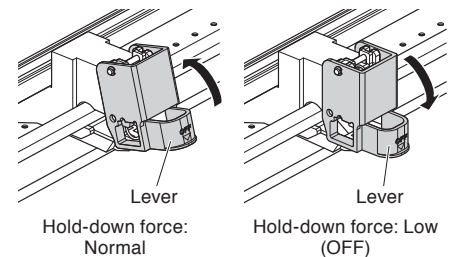

Refer to "Changing the Hold-down Force".

4. About the Initial Setup screen

The Initial Setup screen appears only when powering up the Cutting Plotter for the first time after purchase. Here, you can set "Display Language" and "Length Unit".

After the initial setup is completed, you can also select the menu from the READY status. See "Connecting to the Power" for turning on the power.

- 1 Once the machine is powered on (with the "I" switch) a message will be displayed after the version is displayed.

▶ Here, PLEASE DISPLAY LANGUAGE setting screen is displayed.



- 2 Use the POSITION (▲▼◀▶) keys to select the language. (This manual assumes you chose the English language setting.)

- 3 Press the [ENTER] key.

▶ After the DISPLAY LANGUAGE is selected, the LENGTH UNIT screen will appear.

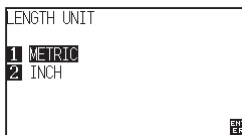

- 4 Press the [1] key (METRIC) or the [2] key (INCH) to select the length unit setting.

- 5 Confirm the setting and press the [ENTER] key (SET).

▶ Setting will be set, and the default screen is displayed.

5. Set the media type into the Plotter.

Set the media type into the Plotter depending on the preset media.

- 1 If you have already loaded the media, the MEDIA TYPE menu appears. Select the media type to suit the loaded media.

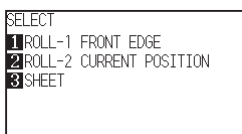

Roll media	Plot starting with the edge of media.	[1] ROLL-1 FRONT EDGE
	Plot starting with the preset position.	[2] ROLL-2 CURRENT POSITION
Sheet media	Set a sheet media.	[3] SHEET
CONTINUE	When similar media is reset	[4] CONTINUE

- 2 After the media is detected, the plotter is ready to receive data for cutting or plotting. This status is called "READY status" of the default screen. When setting is finished, the tool carriage's location will become the initial point.

▶ Default screen is displayed.

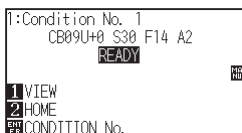

Menu screen
(Normal mode)



Menu screen
(Simple mode)

⚠ CAUTION

Release the media stopper.

Supplement

The CONTINUE menu parameter appears when the media set lever is raised and then lowered again after media was previously loaded, making it possible to select the previous settings.

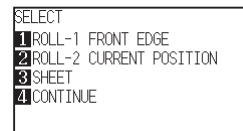

Simple mode/ Normal mode

You can use the [SIMPLE] key on the default screen to switch between Simple mode and Normal mode. CE6000 will be reset once when you switch.

In Simple mode you can change easy settings from the menu screen.

In Normal mode, you will be able to change more detailed settings.

Simple mode and Normal mode are independent from one another. The settings of the mode you're currently in will take precedence.

For details, see "About Simple mode".

6. Tool adjustment and test cutting

After setting the Tool/Speed/Force/Acceleration, make test cutting, and repeat until optimal condition is achieved.

- 1 Load the media for test cutting in the plotter.
- 2 Press the [COND/TEST] key in the default screen.
 - ▶ In Normal mode, CONDITION screen (1/3) is displayed.
 - ▶ In Simple mode, CONDITION screen (1/5) is displayed.

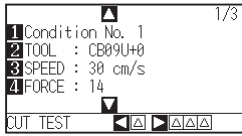

CONDITION screen
(Normal mode)

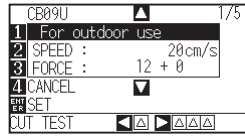

CONDITION screen
(Simple mode)

- 3 Set the Tool conditions (Tool, Speed, Force, Acceleration).

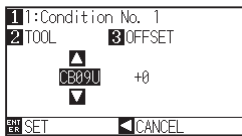

Ex.) TOOLS CONDITION
Settings screen (Normal mode)

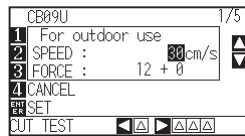

Ex.) TOOLS CONDITION
Settings screen (Simple mode)

CAUTION

Do not touch the Tool edge when power is turned on or during operation.

Setting the Tool conditions

For more information about the various cutting conditions, see "Selecting Tool Condition".

To make 1 cut with set value

- 4 Make test cutting for one piece while Tool conditions are being set.

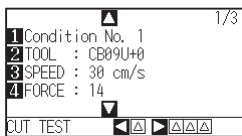

CONDITION screen
(Normal mode)

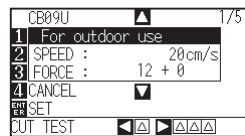

CONDITION screen
(Simple mode)

- (1) Press the POSITION (◀) key (CUT TEST).

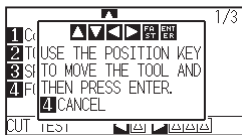

- (2) Press the POSITION (▲▼◀▶) key the tool carriage to the location you wish to perform the test cutting.

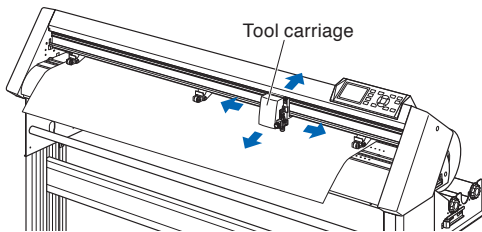

- Press the [ENTER] key.
▶ Cut test pattern is cut.

CAUTION

When the [ENTER] key is pressed, the tool carriage will start moving, so take care not to cut your fingers.

To make 3 cuts with set value and ±1 of set value

- 4 Make test cutting for three pieces while Tool conditions are being set.

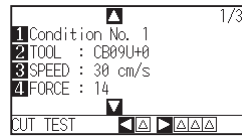

CONDITION screen
(Normal mode)

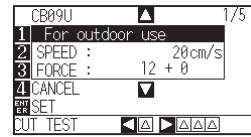

CONDITION screen
(Simple mode)

- (1) Press the POSITION (▶) key (CUT TEST).

▶ CUT TEST screen is displayed.

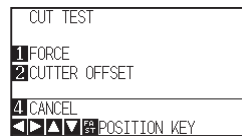

CUT TEST screen
(Normal mode)

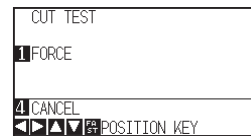

CUT TEST screen
(Simple mode)

- (2) Press the POSITION (▲▼◀▶) key the tool carriage to the location you wish to perform the test cutting.

- (3) Press the [1] key (FORCE).

▶ 3 cutting test patterns are cut, with current FORCE in the center, and 1 each of FORCE increased and decreased for 1

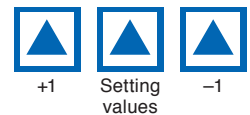

- (4) Press the [ENTER] key after completion.

▶ It will return to CUT TEST menu screen.

- (5) Press the [2] key (CUTTER OFFSET). (Normal mode only)

▶ 3 cutting test patterns are cut, with current CUTTER OFFSET in the center, and 1 each of CUTTER OFFSET increased and decreased for 1.

- (6) Press the [ENTER] key after completion.

▶ It will return to CUT TEST menu screen.

- 5 Check if the cut test is appropriate. Confirm the cutting test results, and adjust to optimal setting. Repeat cutting test and adjustment until optimal cut is achieved.

Adjustment of Offset

Check the corners of the triangles and rectangles. See "Setting the Tool" and adjust the offset value if the corner is not cut or if it is cut too much. Adjust offsets in Normal mode.

Adjustment for Half Cutting

Peel off the triangle area, and adjust so it cuts slightly into the backing sheet.

If the backing sheet has been cut through, either the FORCE setting is too high or the cutter-blade tip is extended too far. If the backing sheet shows only a few traces of the cutter blade, either the FORCE setting is too low or the cutter blade tip is not sufficiently extended.

See "Adjusting the Blade Length" and "Setting the Force" and adjust the settings.

Adjustment for Cutting Out

Adjust so the media is completely cut out.

If the media is not completely cut, either the FORCE setting is too low or the cutter blade tip is not sufficiently extended. See "Adjusting the Blade Length" and "Setting the Force" and adjust the settings.

Adjustment When Using Plotting Pen

Adjust the FORCE so there will be no faint lines. To prolong the pen life, set the FORCE to the lowest setting without any faint lines. See "Setting the Force" or setting the FORCE.

How to check offset

Check if the offset value is set correctly by following.



Not enough adjustment. Increase the offset value.



Optimal offset value.



Too much adjustment. Decrease the offset value.

Adjust the Blade Length (Automatic Height Adjust)

Test cutting must be performed several times in order to confirm the optimal blade length setting. However, if the blade length adjustment function is used, the optimal length can be easily set.

- 1 Load the media for test cutting in the plotter.
- 2 Press the POSITION (▲▼◀▶) key the tool carriage to the location you wish to perform the blade length adjustment.



- 3 Press the [COND/TEST] key in the default screen.
 - ▶ CONDITION setting screen (1/3) is displayed.

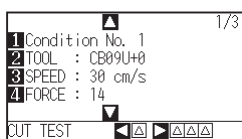

- 4 Press the POSITION (▼) key.
 - ▶ CONDITION setting screen (3/3) is displayed.

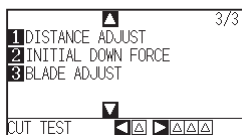

- 5 Press the [3] key (BLADE ADJUST).
 - ▶ Message prompting to turn the blade-length adjustment knob is displayed.

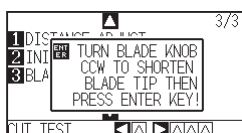

Supplement

Perform the settings in Normal mode.

- 6 As instructed, turn the blade length adjustment knob to the left to fully retract the blade.

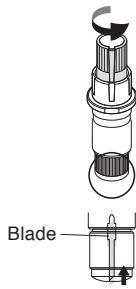

- 7 Set the cutter Plunger in Tool Holder 1 (Backward).

- 8 Press the [ENTER] key.
You can calculate the height by moving the tool up and down.

▶ TO ACHIEVE THE TARGET LENGTH screen is displayed.

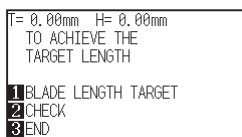

- 9 Press the [1] key (BLADE LENGTH TARGET).

▶ BLADE LENGTH TARGET screen (TARGET) is displayed.

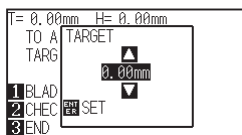

- 10 Press the POSITION (▲▼) key and increase or decrease the setting value.



- 11 Confirm the settings and press the ENTER key (SET).

▶ The Blade Length Target will be selected, and you will return to the TO ACHIEVE THE TARGET LENGTH screen.

- 12 Press the [2] key (CHECK).

You can calculate the height by moving the tool up and down.

▶ The amount and direction to turn the adjustment knob is displayed.

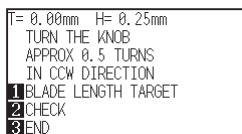

- 13 Turn the blade-length adjustment knob and adjust the cutter blade length.

▶ [2] Current blade length is displayed by pressing the [2] key (CHECK) , so adjust the blade length until it matches the thickness of the media.

- 14 Press the [3] key (END).

▶ Adjustment is completed and it will return to CONDITION screen (3/3).

- 15 Press the [COND/TEST] key.

▶ I will be return to default screen. After completing the settings, press [ENTER] key.

CAUTION

Do not touch the Tool edge when power is turned on or during operation.

Supplement

See "Structure of Cutter Plunger" for bladlength adjustment knob.

Supplement

Adjustment is only possible for the cutter pen set in Tool Holder 1 (Backward). It does not apply to Tool Holder 2 (Forward). See "Attaching a Tool" for instructions on setting.

Supplement

"T" is the target value of the blade length, and "H" is the current blade height (amount). Turning the blade-length adjustment knob displays the number of turns and direction.

CAUTION

Depending on the loaded media, the blade might sink in to the media, making accurate measurement impossible.

Installing the Software

Install the software housed in the attached DVD-ROM into the PC that is used.
This section explains how to install the software when using a Windows 10 (64 bit) operating environment.

Note

- Upon installation, be sure to log on Windows using an account with administrator privileges on your computer. If you have logged on using a standard user account, an [User Account Control] screen asking you to enter the administrator account password may appear.
- Supported OS
This software supports the following OS environments:
Windows 10 (32 bit/64 bit), Windows 8.1 (32 bit/64 bit), Windows 8 (32 bit/64 bit), Windows 7 (32bit/64bit), (Plotter driver/Cutting Plotter Controller also supports Windows Vista.)
Mac OS X 10.11 to 10.7 / mac OS 10.12
(Graphtec Studio also supports Mac OSX 10.6.)
- When Using Macintosh
Macintosh operating environments are supported by the following software.
Proceed with installation in accordance with your operating environment.
 - Graphtec Studio : Software application that enables cutting data to be created through simple commands.
 - Cutting Master 4 : Plug-in driver that can be directly operated from within Adobe Illustrator.
Note that Adobe Illustrator must be installed on your computer prior to use.When checking the manual in the Macintosh operating environment, open the pertinent manual on the accompanying DVD-ROM in the following sequence: [Mac] > [Manuals] > [English (Each language)] > [Manual According to Software].

● Setup in a Windows operating environment

1. Launching the Start Menu

< When using the DVD >

After starting up Windows, insert the [USER GUIDE & SOFTWARE DVD] provided with the CE6000 into your computer's DVD drive.

The below screen will appear before the Start Menu launches.

Continue with installation in accordance with the following procedures.

- 1 The start-up message of DVD drive is displayed. Click on the message.
 - * When setting up the DVD in the computer, this message will disappear after a few seconds.

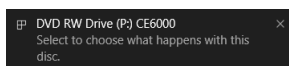

- 2 DVD operation screen is displayed.
Select the "Run MultiSetup.exe" from the DVD operation screen.

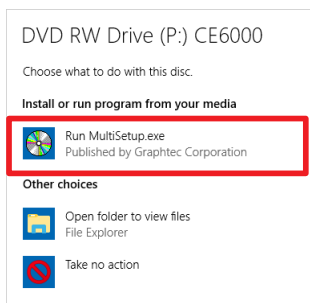

- * If the DVD operation screen is not displayed, select the set DVD drive from the Explorer. Open the DVD and double-click on [MultiSetup.exe].

3 Click [Yes] if you have logged on using an administrator account.

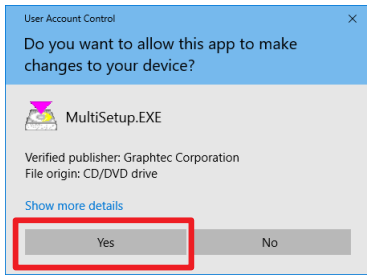

Supplement

If you have logged on using a standard user account, an [User Account Control] screen asking you to enter the administrator account password may appear. Enter the password, and then click [Yes].

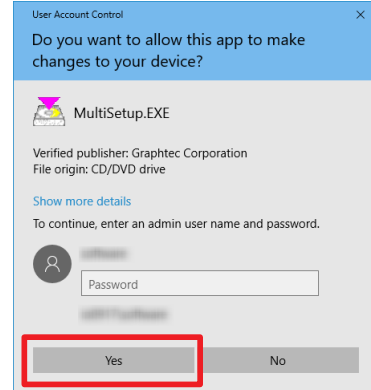

4 The [Start] will appear.

"Use this menu to install the software you require to use the Cutting Plotter
First-time users should proceed with installation by clicking on [Install CE6000Plus Software]."
Proceed with installation according to your operating environment.

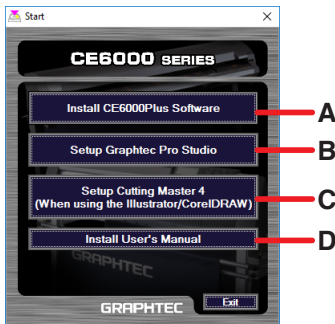

- A. Install CE6000Plus Software:
Install the [Cutting Plotter Controller] and [Plotter Driver].
- B. Setup Graphtec Pro Studio:
"Software enabling cutting data to be created through simple commands.
Create designs and edit characters/shapes using this software."
- C. Setup Cutting Master 4:
Plug-in driver that enables simple cutting through direct operation from within Adobe Illustrator and CoreIDRAW.
Adobe Illustrator or CoreIDRAW must be installed on your computer prior to use.
- D. Install User's Manual:
Installs the User's Manual.

A. Install CE6000Plus Software

If you are using the Cutting Plotter for the first time, click on [Install CE6000Plus Software] to install the device.

This operation will install the [Cutting Plotter Controller] and [Plotter Driver].



Note

Do not connect the accompanying USB cable yet. Doing so may prevent the [Plotter Driver] from being installed properly. Refer to the procedures in this User's Manual when connecting the USB cable.

Installing the [Cutting Plotter Controller]

- 1 Click on [Install CE6000Plus Software]. The [Setup] screen to setup Cutting Plotter Controller for CE6000 will appear momentarily. Click on [Next].

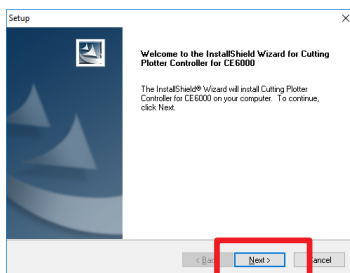

- 2 The [Chose Destination Location] screen will appear. Check the installation destination folder displayed. If there is no need to change it, click on [Next].

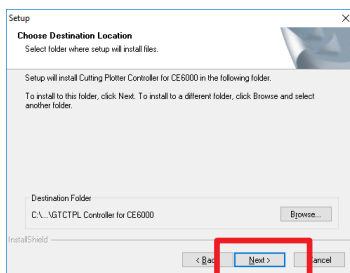

- 3 The [Select Program Folder] window will appear. Simply click on [Next].

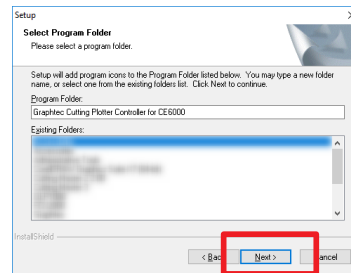

- 4 When the next screen appears, click on [Finish].

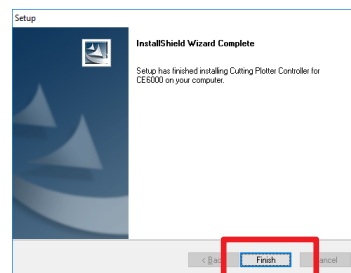

This concludes the installation of the [Cutting Plotter Controller]. Next, install the [Plotter Driver].

Installing the [Plotter Driver]

- 5 After installation of the [Cutting Plotter Controller] is complete, the [Setup] screen for the [Graphtec CE6000Plus Driver] will appear momentarily. When it does, click on [OK].

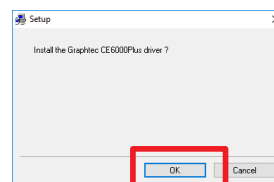

- 6 Next, check to make sure the [Cutting Plotter] is not connected to your computer, then click on [Next].

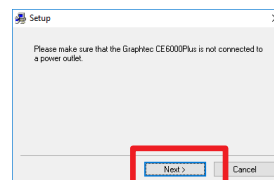

- 7 Click on [Next] again.

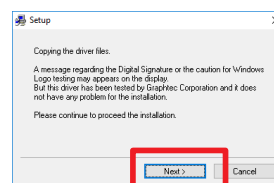

- 8 A window for selecting the [Port Name] to be used appears. Select [USB]. Clicking on [Next] will begin the driver installation process.

Available Port Names

- USB : Selected when a USB cable is used for connection.
- COM1 : Selected when an RS-232C (serial) cable is used for connection.
- FILE : Selected to save outputted data (plot data) to a file.

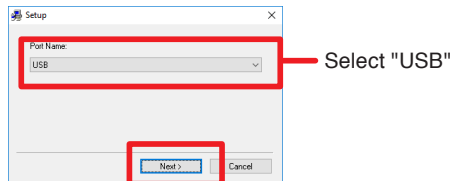

Supplement (When selecting the COM1)

To select "COM1" in "Selecting Port Name", do the installation according to the message. After the installation is completed, connect the RS-232C cable. (For more information about connecting the RS-232C cable, see "Connecting the computer" in User's Manual.) To connect the COM1 for RS-232C, the Cutting Plotter must be set to "Normal mode". For more information about setting the COM1, see "Preparing to Cut" in User's Manual.

- 9 The [Windows Security] screen will appear momentarily. Click on [Install] to install the [Plotter Driver].

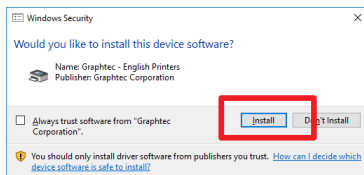

- 10 Next, the [Update for the Graphtec CE6000Plus driver was completed] screen will appear. Click on [OK] to reboot your computer.

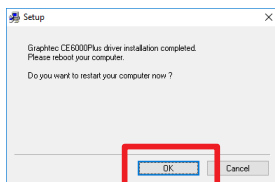

This concludes the installation of the [Plotter Driver]. After rebooting your computer, follow the below procedures to connect the USB cable.

Connecting the USB Cable

- 11 First, make sure that Windows 10 has been launched successfully. Next, connect the USB cable accompanying the Cutting Plotter to your computer. Ensure that the Cutting Plotter is turned off when you do.

- (1) Ensure that the Plotter's power is turned off ("O" position).

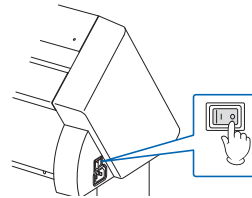

- (2) Connect the power cable.

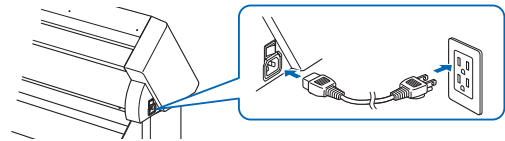

- (3) Connect the USB cable.

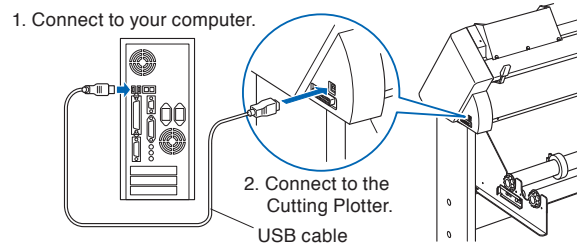

- 12 Turn on the Cutting Plotter.

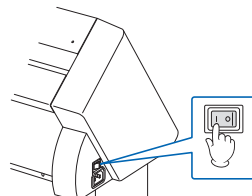

- 13 Installation of the device starts. After a while, the printer icon of Plotter will be added in the "Devices and Printers" screen.

* To display the "Devices and Printers" screen, display the "Control Panel" screen from the Start menu and then click on the [Devices and Printers] in the [Hardware and Sound].

This concludes the installation of the driver software. Next, please install the software applications. Install the software in accordance with your operating environment.

B. Setup Graphtec Pro Studio

Please download the User's Manual separately from our website and perform the setup.

C. Set Up Cutting Master 4

Please download the User's Manual separately from our website and perform the setup.

D. Install User's Manual

Follow the below procedures to install the User's Manual (pdf format).

Adobe Reader must be installed on your computer in order to read the manual.



Installing "User's Manual"

- 1 Click on [Install User's Manual].
The [CE6000 User's Manual Setup] screen will appear momentarily.
Click on [Next].

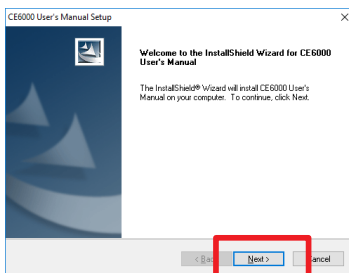

- 2 When this screen appears, click on [Finish].

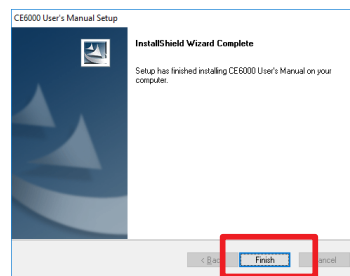

This concludes the installation of the [User's Manual]. The newly-installed [User's Manual] will be registered under your Windows Start Menu.

● Setup in a Macintosh operating environment

A. Set Up Cutting Master 4

Please download the User's Manual separately from our website and perform the setup.

B. Setup Graphtec Studio

Please download the User's Manual separately from our website and perform the setup.

GRAPHTEC