

GRAPHTEC

CUTTING PLOTTER
CELITE-50
USER'S MANUAL



Introduction

Thank you for purchasing Cutting Plotter CE LITE-50. This device is a cutting plotter that realizes high-speed and high-precision work. In addition to cutting marking films, this device can also be used as a pen plotter. Please carefully read through this manual prior to use in order to ensure safe and proper use of the device. This product is manufactured and sold under license from Gerber Scientific Products, Inc. for US Patent No. 5,537,135 and its foreign patents.

Notes on this Manual

- (1) No part of this publication may be reproduced, stored in a retrieval system, or transmitted, in any form or by any means, without the prior written permission of Graphtec Corporation.
- (2) The product specifications and other information in this manual are subject to change without notice.
- (3) While every effort has been made to provide complete and accurate information, please contact your sales representative or nearest Graphtec vendor if you find any unclear or erroneous information or wish to make other comments or suggestions.
- (4) Not with standing the stipulations in the preceding paragraph, Graphtec Corporation assumes no liability for damages resulting from either the use of the information contained herein or the use of the product.

Registered Trademarks

All names of companies, brands, logotypes, and products appearing in this manual are the trademarks or registered trademarks of their respective companies.

Copyright

This User's Manual is copyrighted by Graphtec Corporation.

Precautions on Handling the Cutter Blade

This product uses a blade. In order to prevent injury accidents due to the blade, please be very careful when handling the cutter blade such as when attaching the cutter pen to the main unit.

Cutter Pen

The tip is a sharp blade. Be careful not to use an excessive blade depth. In addition, refrain from protruding the blade from the tip of the cutter pen when the cutter pen is not in use.

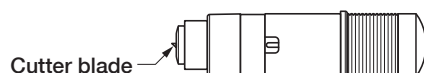

After Attachment to the Main Unit

Refrain from touching the pen tip after the power has been turned ON and during operation as doing so is dangerous.

Precautions After Turning the Power ON

The tool carriage and media that is set may suddenly move during work, immediately after work has ended, and while configuring various settings. Keep hands, hair, and clothes, etc. away from moving parts and their range of motion and refrain from placing objects on these places. When using the device, be very careful to avoid injury due to getting hands, hair, or clothes, etc. caught in the device.

Notes regarding Warning Labels

The warning label shown below has been placed on the tool carriage of the device. Be sure to observe the precautions listed.

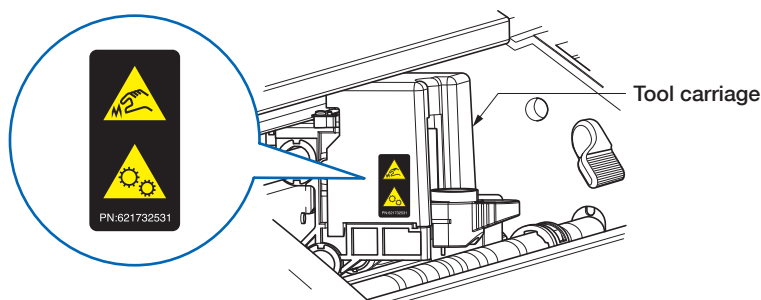

Notes regarding the Wording in This Manual

- "Cutting" as used in this manual refers to the device operating to draw figures with a drawing pen or cut media with the cutter pen.
- "Media" as used in this manual collectively refers to paper, roll paper, sheet paper, and marking film.

Before Work

- Be sure to read through the included "TO ENSURE SAFE AND CORRECT USE" Performing work without reading this section may lead to an unexpected accident or cause a fire.

Precautions when Using Curled Media

- An upward curl, even when weak, can cause the media to jam.
- Either use media that is not curled or manually fix the curl so that the media has a weak downward curl that fits along the main unit of the plotter.

CONTENTS

Introduction	i
Notes on this Manual	i
Registered Trademarks	i
Copyright	i
Cutter Pen	ii
After Attachment to the Main Unit	ii
Precautions After Turning the Power ON	ii
Notes regarding Warning Labels	ii
Notes regarding the Wording in This Manual	ii
Before Work	iii
Precautions when Using Curled Media	iii

Chapter 1 Notes Before Use

1.1 Standard Accessories	1-2
1.2 Names and Functions of Each Component	1-3
1.3 Operation Panel	1-4
Types of Screens and Operations	1-4
Other Displays and Operations	1-5
1.4 Installing the Main Unit	1-6
Installation Space	1-6
1.5 Media Size and Cutting Area	1-7
Compatible Media Sizes	1-7
Cutting Area	1-7
1.6 Installing the Driver and Software	1-8
1.7 Connecting and Turning ON the Power	1-9
1.8 Connecting a Computer	1-10
1.9 Settings when Turning the Power ON for the First Time	1-11

Chapter 2 Basic Operations

2.1 Setting the Tool	2-2
Adjusting the Blade Depth of the Cutter	2-2
Reference and Precautions regarding Blade Depth Adjustment	2-3
Setting the Tool	2-4
2.2 Setting the Media Set Levers	2-5
2.3 Setting the Push Rollers	2-6
Moving the Push Rollers	2-6
Push Roller Setting Positions	2-6
2.4 Loading Sheet Media	2-7
Loading the Media Up Against the Push Rollers	2-7
Loading the Media upon Releasing the Push Rollers	2-9
Unloading Sheet Media	2-10
2.5 Confirming the CONDITION NO. (Cutting Condition)	2-11
2.6 Precautions when Creating Data	2-12
Notes regarding the Cutting Origin Position	2-12
Notes regarding the Cutting Area	2-13

2.7	Sending Cutting Data	2-14
2.8	Ordinary Care	2-15
	Cleaning the Cutter Pen	2-15

Chapter 3 Cutting along Printed Data

3.1	What is Printing & Cutting?	3-2
3.2	Simple Printing & Cutting	3-3
3.3	Registration Mark Scanned Printing & Cutting	3-5
3.4	Types and Arrangement of Registration Marks	3-6
	Registration Mark Shapes	3-6
	Positions for Registration Mark Arrangement	3-7
	Automatic Registration Mark Position Detection	3-8
3.5	Flow of Creating Registration Marks to Cutting	3-9
	Graphtec Pro Studio	3-9
	Cutting Master 4	3-12
	Graphtec Studio	3-15

Chapter 4 Convenient Functions

4.1	Cutting Roll Media	4-2
	Assembling the Roll Media Stocker	4-2
	Loading and Scanning Roll Media	4-4
	Setting the Page Length	4-8
	Usage of the Cross Cutter	4-9
4.2	Cutting using the Carrier Sheet	4-10
	Loading Media onto the Carrier Sheet	4-11
	Loading the Carrier Sheet	4-12
4.3	Plotting with the Drawing Pen	4-15
	Setting the Drawing Pen in the Pen Adapter	4-15
	Setting the Pen Adapter	4-16
4.4	Cutting from a USB Memory	4-18
	Saving Data on a USB Memory	4-18
	Cutting upon Loading USB Memory Data	4-18
	Cutting Barcode-equipped Data	4-19
4.5	Cutting Multiple Media using the Same Data (Copy Function)	4-20
	Copying Multiple Cuts on a Single Media	4-20
	Copying Repeatedly on Multiple Media	4-22
4.6	Cutting upon Specifying the Cutting Position	4-23
4.7	Expanding the Cutting Area	4-24
4.8	Aborting and Pausing during a Cut	4-25
4.9	Withdrawing the Tool Carriage	4-26

Chapter 5 Detailed Settings

5.1	Individually Registering Settings for Cutting Conditions	5-2
5.2	Adjusting the Cutting Quality	5-3
	Selecting the Tool and Setting the Offset Value	5-3
	Setting the Cutting Force	5-4
	Setting the Offset Force	5-4

	Setting the Condition Priority	5-5
	Setting the Distance Adjustment	5-5
	Setting the Blade Tip Orientation Initialization Position	5-6
5.3	Adjusting the Cutting Time	5-7
	Setting the Speed	5-7
	Setting the Acceleration	5-7
	Setting the Tool Up Speed	5-8
5.4	Cutting Thick Media	5-9
	What is the Tangential Mode?	5-9
	Setting the Tangential Mode	5-9
	Setting the Overcuts	5-10
5.5	Performing Cut Tests	5-11
	Cutting 1 Test with the Setting Values	5-11
	Cutting 3 Tests to include Setting Values ± 1	5-12
	Confirming the Cut Test	5-12
5.6	Registration Mark Scan Settings	5-13
	Setting the Scan Mode	5-13
	Confirming Registration	5-14
	Correcting the Registration Mark Position	5-16
	Setting Automatic Registration Mark Position Detection	5-19
5.7	Adjusting the Media Operation	5-20
	Setting the Pre Feed Operation	5-20
	Setting the Auto Pre Feed	5-21
	Setting the Initial Feed	5-21
	Setting the Media Width Detection	5-22
5.8	Setting Commands	5-24
	Selecting the Command	5-24
	Setting the HP-GL Origin Point	5-24
	Setting the HP-GL Model Emulated	5-24
	Setting the GP-GL Step Size	5-25
5.9	Setting the Operation Panel	5-26
	Language Selection	5-26
	Selection of Unit for Lengths	5-26
	Setting the Beep for Key Operation	5-26

Chapter 6 Troubleshooting

6.1	Responding to Trouble	6-2
	When the device does not operate even when the power is turned ON	6-2
	Operation is Irregular	6-2
6.2	Confirming Error Messages	6-3
	GP-GL Command Errors	6-3
	HP-GL Command Errors	6-3
	ARMS Errors	6-4
	Other Error Displays	6-4
6.3	Confirming the Operation of the Main Unit	6-5
	Plotting the Self Test Pattern	6-5
	Plotting the Test Pattern	6-5
	Adjusting the Width Detection Sensor	6-6

	Main Unit Diagnosis Test	6-6
6.4	Confirming the Main Unit Firmware Version.....	6-7
6.5	How to Replace the Cutting Mat	6-8
Appendix		
A.1	Standard Specifications	A-2
A.2	Supply Items	A-3
A.3	Appearance Drawing	A-4
A.4	Menu Tree	A-5
A.5	List of Initial Values	A-9
INDEX	I-1



Chapter 1 Notes Before Use

An overview of this device and connections with a computer are explained in this chapter.

- 1.1 Standard Accessories
- 1.2 Names and Functions of Each Component
- 1.3 Operation Panel
- 1.4 Installing the Main Unit
- 1.5 Media Size and Cutting Area
- 1.6 Installing the Driver and Software
- 1.7 Connecting and Turning ON the Power
- 1.8 Connecting a Computer
- 1.9 Settings when Turning the Power ON for the First Time

1.1 Standard Accessories

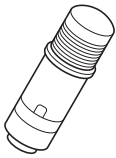
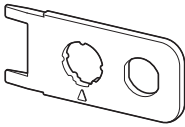
Please confirm that all accessories are included. If any of the accessories are missing, please immediately contact your store of purchase or our company's customer service.

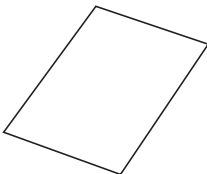
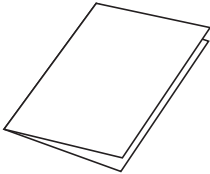
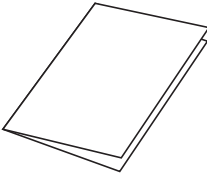
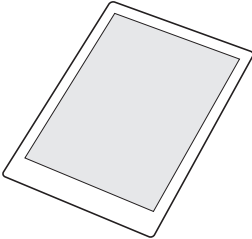
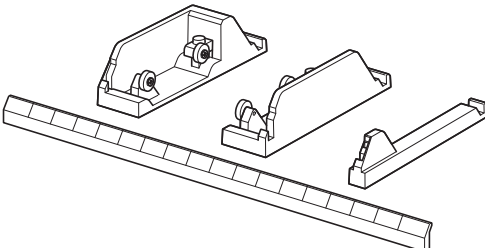
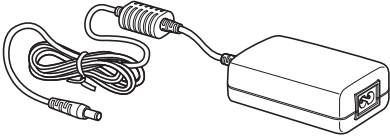
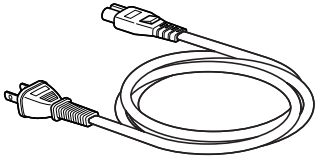
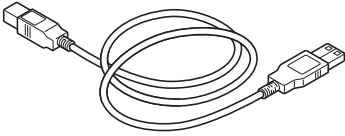
Cutter Set (Standard Blade) [PM-BS-001] 1 set 	Blade Tip Cap Jig 1 unit 
Cross Cutter [PM-CC-001] 1 unit 	Software Activation Code 1 sheet 
SETUP MANUAL 1 copy 	TO ENSURE SAFE AND CORRECT USE 1 copy 
Carrier Sheet (13-inch) 1 sheet 	Roll Media Sticker 1 set 
AC Adapter 1 unit 	AC Cable 1 unit 
USB Cable (1.5 m) 1 unit 	

1.2 Names and Functions of Each Component

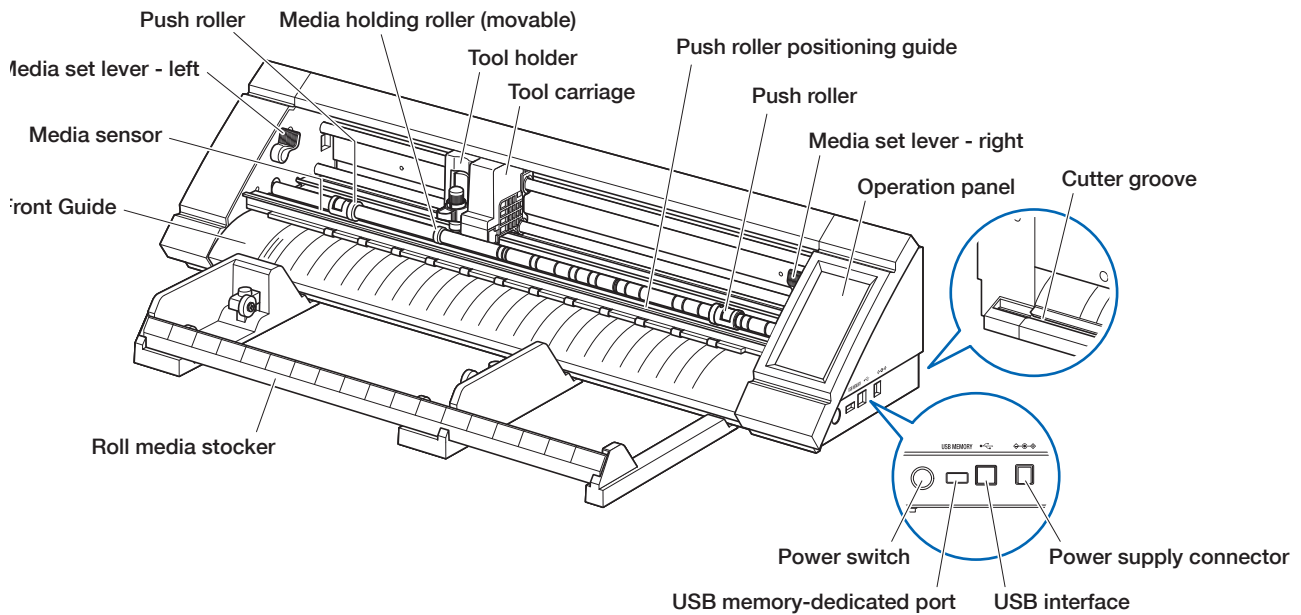

Operation panel:	Used to operate the device and configure various settings.
Media set lever-right:	Used to raise/lower the push roller when setting media and fix (3 positions) / release the media. Adjust this lever according to the width of the media.
Media set lever-left:	Used to raise/lower the push roller when setting media and fix/release the media.
Push rollers:	Touches the media to fix/transport the media. Adjust this roller according to the type and size of the media.
Push roller positioning guide:	Sets the push rollers at the position of the indicated marking.
Tool carriage:	Drives the tool left/right and scans registration marks and barcodes.
Tool holder:	Holds the tool and drives it up/down.
Media holding roller (movable):	Holds down media to prevent low cutting quality and malfunction of register mark detection. Set it in the center or the most lifted part of the media.
Media sensor:	Scans media.
Front Guide:	Sets the media at the position of the indicated marking.
Roll media stocker:	Holds roll media.
Power switch:	Used to turn the power ON/OFF.
USB memory-dedicated port:	Used to connect and load data from a USB memory.
USB interface:	Used to connect the device with a computer.
Power supply connector:	Used to connect the power cable.
Cutter groove:	Used when registrationping roll media with the cross cutter.

1.3 Operation Panel

Types of Screens and Operations

HOME Screen and Functions of Buttons

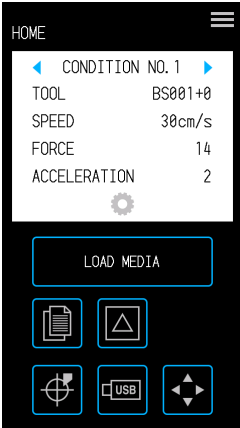

- "MENU" button: Used to transition to the "MENU" screen.
- "CONDITION NO. Selection" buttons: Used to select the CONDITION NO.
- "CONDITION" button: Used to transition to the CONDITION (cutting condition) setting screen.
- "LOAD MEDIA" button: Used to transition to the Load Media screen.

The following screen is displayed when media is set.
- "UNLOAD MEDIA" button: Used to Unload Media that has been set.
- "COPY" button: Used to transition to the copy mode.
- "CUT TEST" button: Used to transition to the cut test screen.
- "HOME" button: Used to move the tool carriage to the home point.
- "USB" button: Used to transition to the menu for cutting from a USB memory.
- Position key: Used to transition to the position key screen.

Other Buttons

- "Page" button: Used to transition to the next page on the same tier level.
- "Exit" button: Used to exit the current screen. When touched before the (Confirm) in a screen where the (Confirm) is displayed, the screen is exited without setting the item.
- "Confirm" button: Used to confirm settings.
- "Execute" button: Used to execute settings.
- "Origin" button: Used to configure the plot origin.
- "Cutting Area" button: Used to display the cutting area of the media that has been loaded.
- "OK" button: Used to confirm the position of the tool moved with the position keys.
- "Stop" button: Stops the cutting operation.

Menu Selection Screen

This screen is used to select setting items. Please touch the button to set.

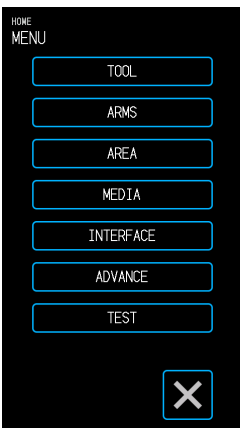

Different Button Colors

Light blue indicates the selected setting. Please touch the button to set.

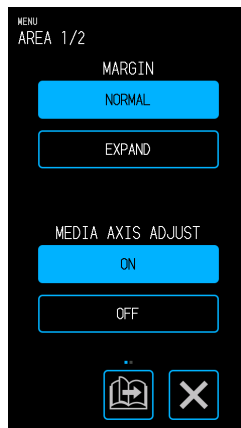

Different Display Boxes

White boxes can be touched to transition to the input screen.

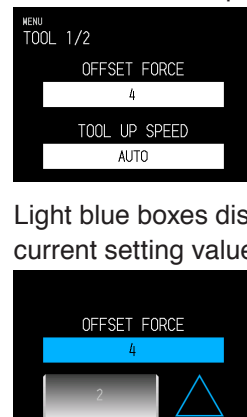

Light blue boxes display the current setting value.

Input Screen

Number Input

Touch the buttons to input a number.

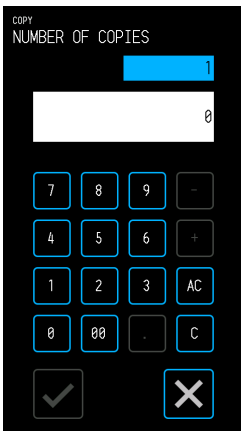

Drum Selection

Rotate the drum to scroll through the list and select a setting value.

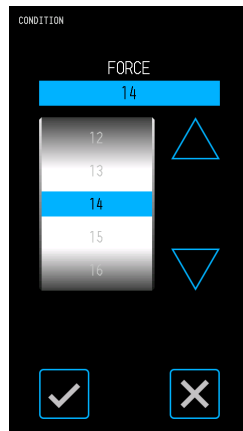

List Selection

Touch the item you wish to select from the list to set the item.

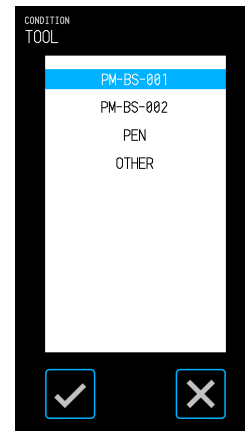

Position Keys

The tool carriage or media moves to each direction when the " \triangle ", " ∇ ", " \triangleleft " and " \triangleright " position keys are touched.

The movement will be started from slow speed when the position keys are touched. The movement speed changes to fast speed when key is touching more than a few seconds.

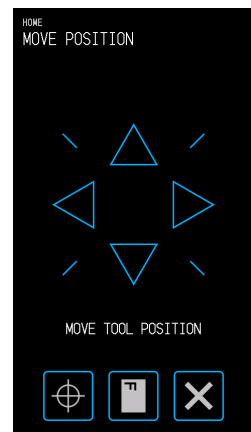

Other Displays and Operations

Instruction Screen

- If the power is turned ON while in a state where the media set levers are released, the message "SET THE MEDIA SETTING LEVER." will appear on the operation panel. Once the media set levers are lowered, the "LOAD MEDIA" screen will be displayed.
- When setting the media, a message regarding the media or the push rollers may appear. In such case, operate the device by following the on-screen instructions.
- Operate the device by following the on-screen instructions also when other operation related messages appear.

Sleep Release

The touch panel function will be turned off (Sleep Mode) in a few minutes when it is not touched.

To restart it, touch the touch panel.

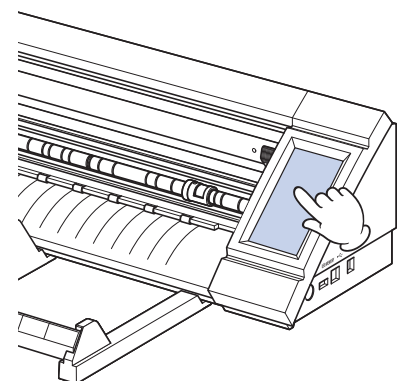

1.4 Installing the Main Unit

Installation Space

Secure enough space to install the device so that the cutting operation is not affected.

- The space required to the front and rear of the device will vary depending on the size of the media being used.
- Refrain from placing obstacles in front of or behind the main unit that will interfere with transportation of the media.

Installation Space when Using Carrier Sheets

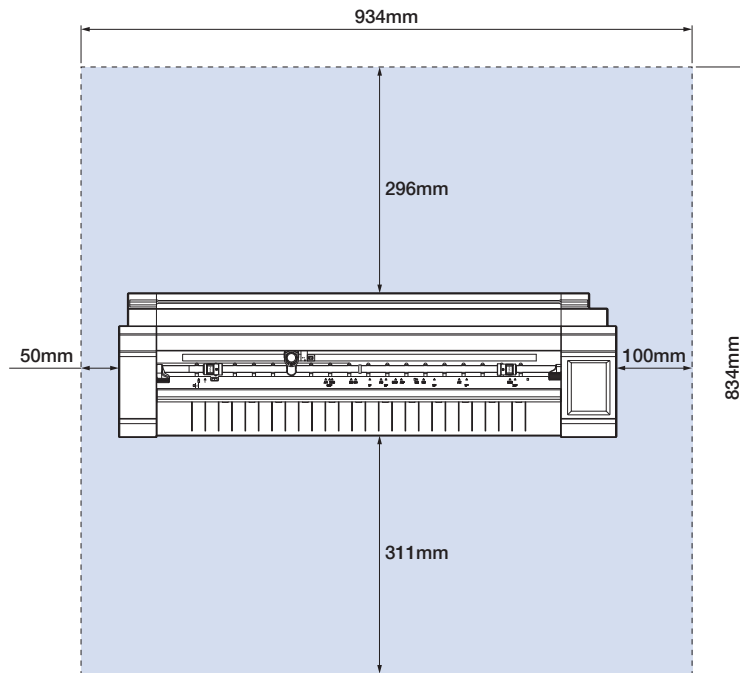

When using the roll media stocker and installing the device on a table, use a table that is leveled and solid with a top panel that is at least 934 × 502 mm in size.

- When using roll media, refrain from placing obstacles in front of or behind the main unit that will interfere with transportation of the media.

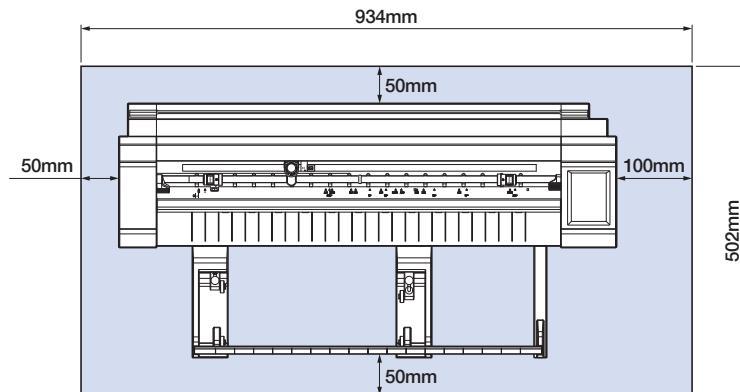

1.5 Media Size and Cutting Area

Compatible Media Sizes

This cutter is able to use only width of standard media size as shown in the table below.

Use the carrier sheet when the media width is other than below.

For more information on the carrier sheet, refer to "4.2 Cutting using the Carrier Sheet".

Compatible Media Width	Size					Position of right side Media Set Lever
	ISO A/JIS A	JIS B	ISO B	Inch	Non-Standard	
210.0mm	A4					1
215.9mm				8.5inch		
220.0mm					OK	
250.0mm			B4			
257.0mm		B4				
279.4mm				11inch		
297.0mm	A3					2
304.8mm				12inch		
320.0mm					OK	
329.0mm	A3+					
353.0mm			B3			
364.0mm		B3				
381.0mm				15inch		3
420.0mm	A2					
431.8mm				17inch		
500.0mm			B2			
508.0mm				20inch		

Cutting Area

The cutting area and cutting direction will be as shown below.

Sheet Media

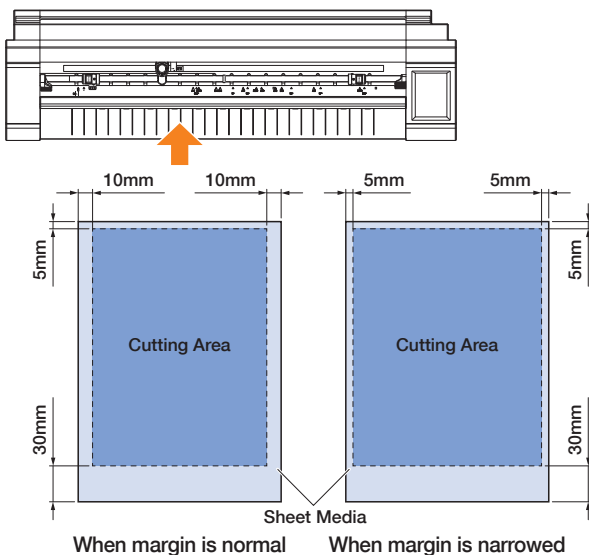

Roll Media

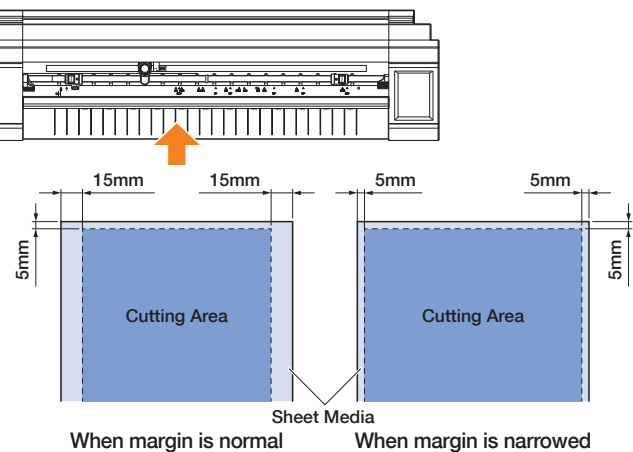

1.6 Installing the Driver and Software

Download the device driver and application software from Graphtec website to install these on your computer.

Notes on Compatible OS

The software for this device is compatible with the following OS environments:

Graphtec Pro Studio & Cutting Master 4 & Divece Driver (Windows)

Windows 10 (32-bit / 64-bit), Windows 8.1 (32-bit / 64-bit), Windows 8 (32-bit / 64-bit),

Windows 7 (32-bit / 64-bit)

Graphtec Studio & Cutting Master 4 (Mac)

Macintosh Mac OS X 10.11 - 10.7 / mac OS 10.13 - 10.12 (Graphtec Studio is also compatible with Mac OS X 10.6)

Please confirm the latest compatible OS environment on our company website.

Installing the Cutting Plotter Driver (Windows)

Download the devoce driver from Graphtec website website.

For installation procedures, refer to the documented procedures available on the website.

URL: <http://www.graphtec.co.jp/en/imaging/celite/support.html>

The device driver for Mac does not need install.

CAUTION

Do not connect this device and the computer with a USB cable before installing the printer driver. Connecting these prior to installation may prevent the printer driver from being properly installed.

Installing Graphtec Pro Studio (Windows)

Download the software from the following Graphtec website.

URL: <http://www.graphtec.co.jp/en/imaging/celite/support.html>

For installation procedures, refer to the documented procedures available on the website.

Installing Cutting Master 4 (Windows/Mac)

Download the software from the following Graphtec website.

URL: <http://www.graphtec.co.jp/en/imaging/celite/support.html>

For installation procedures, refer to the documented procedures available on the website.

Installing Graphtec Studio (Mac)

Download the software from Graphtec website.

URL: <http://www.graphtec.co.jp/en/imaging/celite/support.html>

For installation procedures, refer to the documented procedures available on the website.

1.7 Connecting and Turning ON the Power

Connect this device and the AC outlet via the standard accessory of AC adapter, and then turn ON the power.

1. Connect the AC adapter and the AC cable (1). Connect the AC adapter to the power supply connector of this device (2). Connect the AC cable to the AC outlet of specified voltage (3).

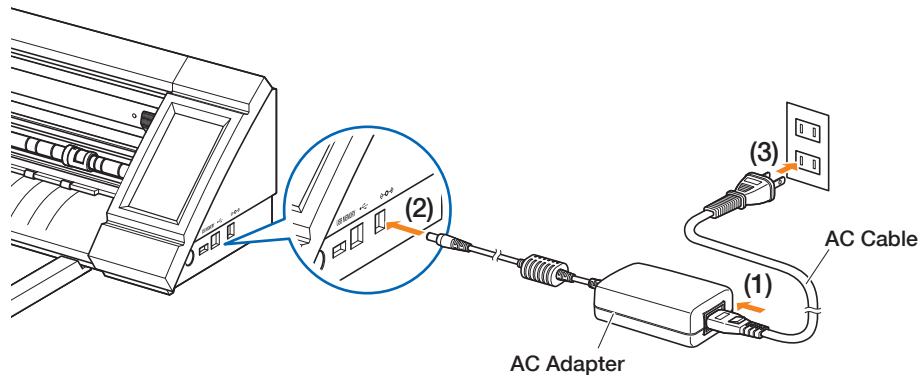

2. Press the power switch to turn ON the power.
Confirm that the touch panel has started up.
When turning ON the power, wait at least 20 seconds to turn on the power after the power was turned OFF.
The device may fail when immediately the power turned ON, after the power was turned OFF.

- After the power was turned ON when the media set lever was not set, the "SET THE MEDIA SETTING LEVER." is displayed.
At this time, lower the set lever, and then the "LOAD MEDIA" is displayed.
Then touch the  (Exit) to exit to the HOME menu.

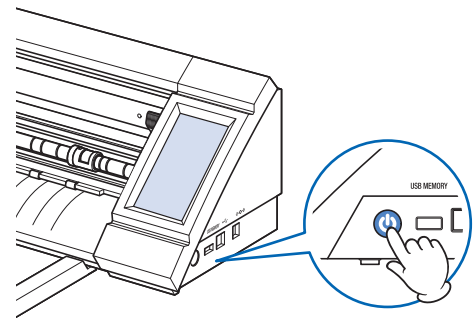

1.8 Connecting a Computer

Connect this device and a computer by using the supplied USB Cable.

- For Windows: Connect the USB cable after the device driver was installed to the PC.

1. Turn OFF the power.
Touch the touch panel and confirm that the screen does not start up.

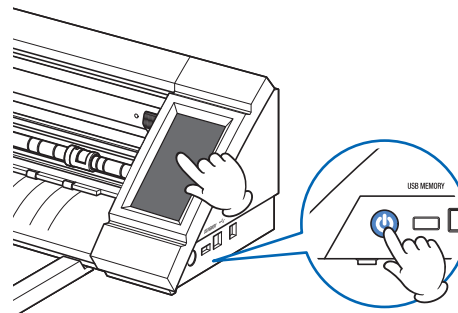

2. Connect this device and the computer by the USB cable.

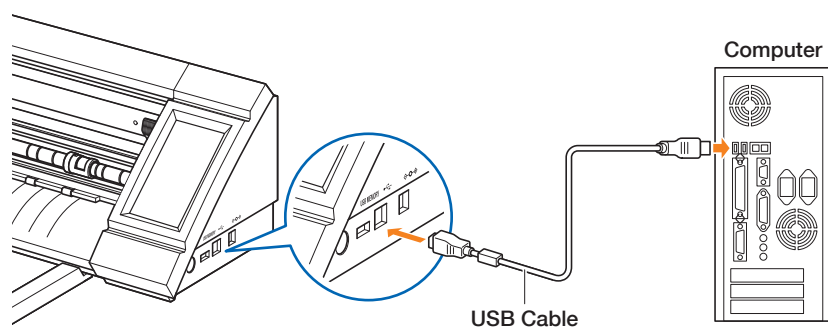

1.9 Settings when Turning the Power ON for the First Time

When the device is started up for the first time, it will be necessary to set the language and the unit for lengths.

Language Selection

When the power of this device is turned ON for the first time, the startup screen will be followed by a language selection screens.

Select the language used, and then touch the (Confirm).



Selection of Unit for Length

Once the language has been set, the screen for selecting the unit for length will appear.

Select the unit used, and then touch the (Confirm).

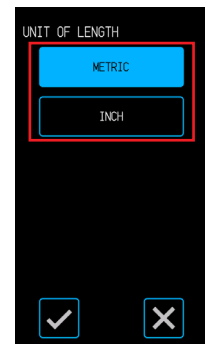

Once the unit for lengths has been set, the HOME screen will be displayed.

Chapter 2 Basic Operations

Perform basic cuts by following the items explained in this chapter.

- 2.1 Setting the Tool
- 2.2 Setting the Media Set Levers
- 2.3 Setting the Push Rollers
- 2.4 Loading Sheet Media
- 2.5 Confirming the CONDITION NO. (Cutting Condition)
- 2.6 Precautions when Creating Data
- 2.7 Sending Cutting Data
- 2.8 Ordinary Care

2.1 Setting the Tool

The cutter pen (PM-BS-001) is a consumption goods.
Purchase a new cutter pen when the cutter blade becomes dull.
Optional cutter pen (Long blade: PM-BS-002) can also be used.

Adjusting the Blade Depth of the Cutter

The blade depth needs to be adjusted in order to perform optimal cutting. Perform the test cutting several times to set an optimal blade depth.

⚠ CAUTION

- Be careful when handling the cutter blade to avoid cutting your hands, etc.
- An excessive blade depth will damage the cutter blade and cutting mat or lead to wasteful consumption of media. Keep the blade depth less than the thickness of the media.

PM-BS-001

The blade depth is adjusted by turning the tip of the cutter pen.
Align the number with the red line to adjust the blade depth.
Aligning a larger number to the line will increase the blade depth. The blade depth is changed in approximately 0.1 mm for each number. The blade depth is able to adjust to a maximum of approximately 1 mm.

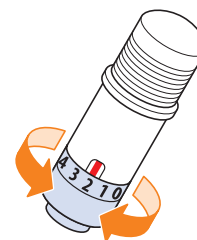

⚠ CAUTION

Do not turn the cap clockwise (towards 10) from the state where the blade tip is not protruding (at 0). Similarly, do not turn the cap further counter-clockwise (towards 0) past the state where the blade tip is protruding by 1 mm (at 10). Doing either of these may damage the cutter pen.

PM-BS-002

The blade depth is adjusted by turning the tip of the cutter pen.
Align the number with the red line to adjust the blade depth.
Aligning a larger number to the line will increase the blade depth. The blade depth is changed in approximately 0.1 mm for each number. The blade depth is able to adjust to a maximum of approximately 2 mm.

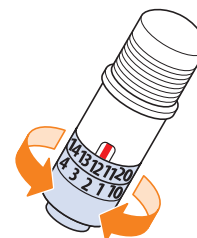

⚠ CAUTION

Do not turn the cap clockwise (towards 20) from the state where the blade tip is not protruding. Similarly, do not turn the cap further counter-clockwise past the state where the blade tip is protruding by 2 mm (at 20). Doing either of these may damage the cutter pen.

Reference and Precautions regarding Blade Depth Adjustment

Commonly available vinyl sticker sheets are configured of two layers - a sheet with an adhesive and a backing. Adjust the blade depth so as not to penetrate the backing.

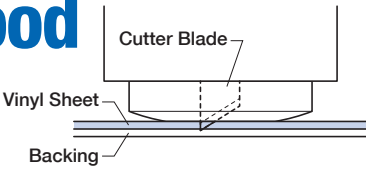
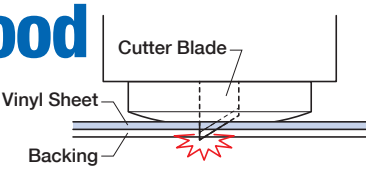
<p>Adjust the blade depth so that the vinyl sheet is penetrated and a light trace of the cut is left on the backing.</p>	<p>An excessive blade depth will be cause to dull cutting not only, it damages the tip of blade also.</p>
<p>Good</p>  <p>The diagram shows a cross-section of a cutter blade positioned above a vinyl sheet and a backing. The blade is cutting through the vinyl sheet, and a dashed line indicates the cut path. A light trace of the cut is visible on the backing. Labels include 'Cutter Blade', 'Vinyl Sheet', and 'Backing'.</p>	<p>No Good</p>  <p>The diagram shows a cross-section of a cutter blade positioned above a vinyl sheet and a backing. The blade is cutting through the vinyl sheet and penetrating the backing. A red starburst indicates damage to the blade tip. Labels include 'Cutter Blade', 'Vinyl Sheet', and 'Backing'.</p>

- When adjusting the blade depth, start with a shallow blade depth and make adjustments to a greater depth.
- The appropriate blade depth will vary depending on the thickness of the media. Make adjustments and perform cut tests every time the type of media is switched.

Setting the Tool

To attach the tool, insert the tool into the tool holder completely, and then fix the tool by the locking lever.

⚠ CAUTION

- Don't touch to the tool while it is moving, it is extremely dangerous.
- Be careful not to injure yourself with the cutter blade when setting the tool.

1. Pull the locking lever to open the lock.

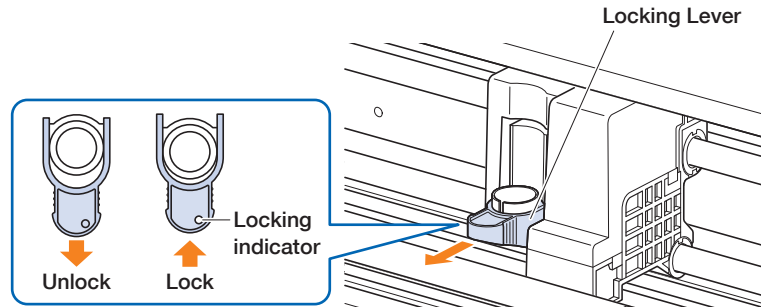

2. Insert the cutter pen to the tool holder while holding it.

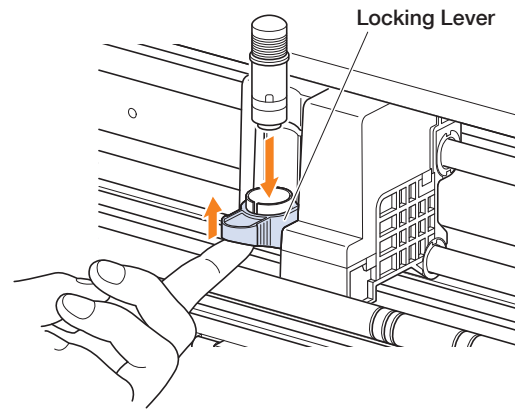

3. Push the locking lever until it clicks to hold the cutter pen. Confirm the locking indicator became the white.

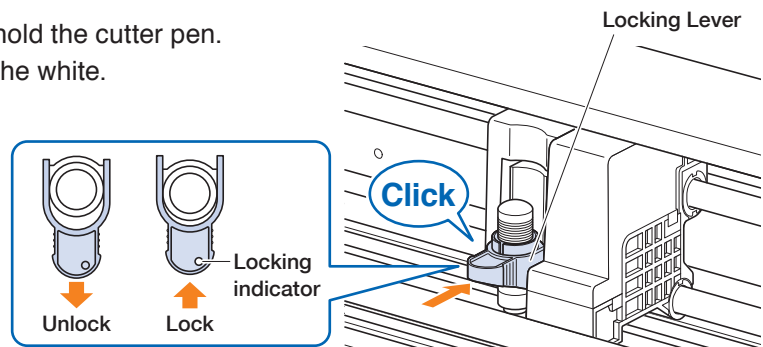

4. Pull the locking lever to open the lock, and then remove the cutter pen from the tool holder.

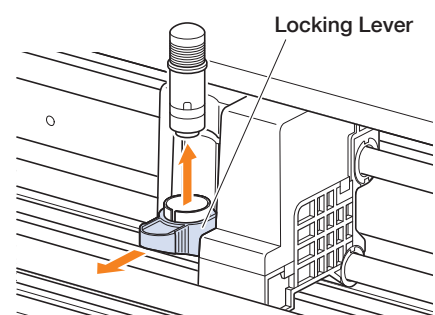

2.2 Setting the Media Set Levers

Set the media set levers to the locked position, except the following conditions.

Moving the push roller position or removing jammed media.

When this device will not be used for a long period, set the media set levers to the released position.

The "SET THE MEDIA SETTING LEVER." is displayed when the media set levers did not set to the locked position when the HOME menu is selected.

Setting the Media Set Lever - Left

Set the media set lever - left to the lock position to hold the media with the left side push roller.

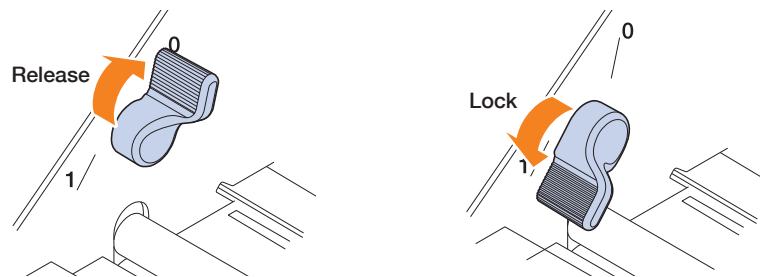

Setting the Media Set Lever - Right

There are three lock positions for the media set lever - right.

The lock position depends on the width of media.

Set the media set lever - right to the correct position.

Refer to the "1.5 Media Size and Cutting Area" to set the right side Media Set Lever to correct position.

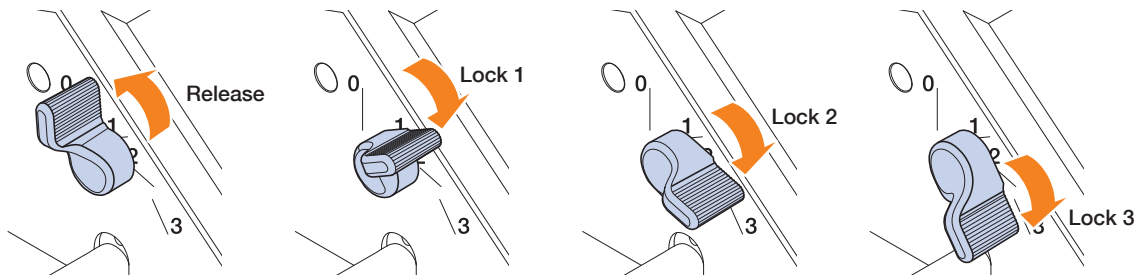

When the media lock lever was set to incorrect position, the message of correct position will be displayed.

Set the media set lever - right to the correct position according with the message

Media Width and Lock Position

Lock 1: A4 / 8.5" / 220mm / B4 / 11" / A3

Lock 2: 12" / 320mm / A3+ / CARRIER SHEET / B3 / 15" / A2

Lock 3: 17" / 500mm / 20".

2.3 Setting the Push Rollers

Adjust the positions of the left and right push rollers to suit the width of the media.
Set the push rollers positioned onto both edges of the media.

Moving the Push Rollers

To move the push rollers, raise the media set levers and release the push rollers. Squeeze the "PUSH" part with your fingers, and then move the push roller left and right while pressing the "PUSH" part. If the "PUSH" is in a position that is difficult to press, rotate the roller so that it can easily be pressed. When the push roller reaches to the desired position, release the "PUSH" part and place it in the position where it "clicks" into the positioning groove. After setting the push roller, move slightly to the left and right without pressing the "PUSH" part to check that it fits in the positioning groove.

If the tool carriage obstructs the setting the push rollers, release the left and right media set levers and slowly move the tool carriage away. Gently hold the tool carriage from both sides. Holding this at a different position or forcefully moving it may cause damage. The tool carriage that has been moved will return to its home position when the power is turned ON.

CAUTION

Be sure to operate/move the media set lever, push rollers, and tool carriage when operating the load media menu.

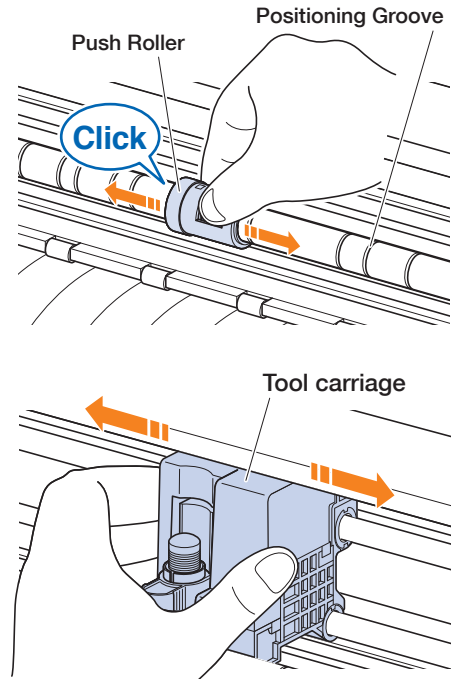

Push Roller Setting Positions

Left Side Push Roller Setting Positions

Align the "media pressing portion" of the push roller with the position of the push roller positioning guide to set the push roller in place.

Align the push roller to the "□" position when using the sheet media or the carrier sheet.

Align the push roller to the "⊙" position when using the roll media.

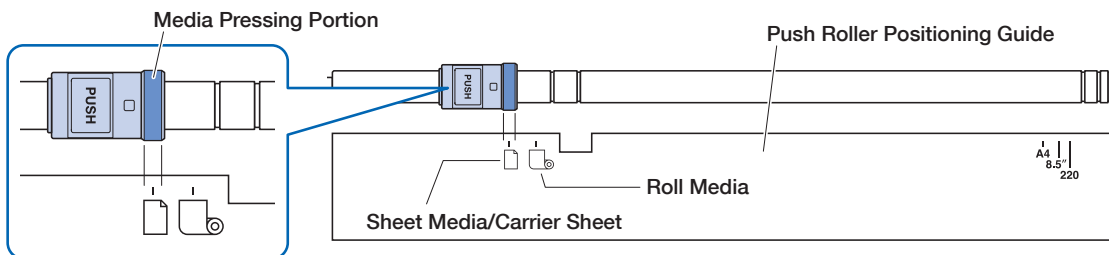

Right Side Push Roller Setting Positions

Set the "Media pressing portion" of the push roller according to the width of media.

Align the media pressing portion with the markings on the top row for standardized sizes (mm), the middle row for standardized sizes (inch), and the bottom row for non-standardized sizes or the carrier sheet.

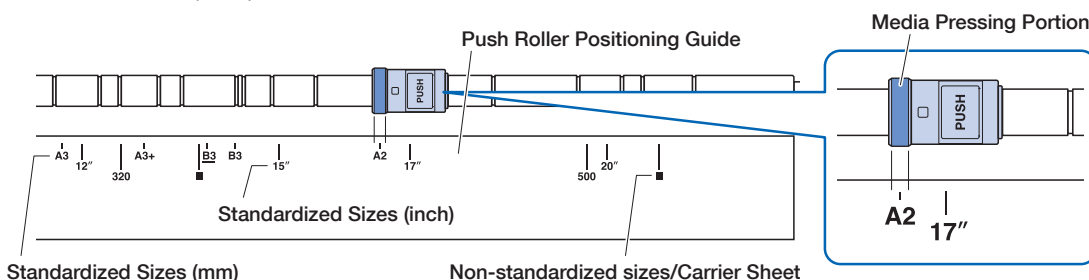

2.4 Loading Sheet Media

Use the standard media size of sheet media. Use the carrier sheet when using the non standard media size of sheet media.

- Depending on the type of media (especially with high transparency), the media cannot be set because CE LITE-50 cannot detect the leading edge /width /position of the media. In this case, use a carrier sheet or disable the Media width detection.
- Depending on the type of media, the center of the media may be lifted up because the push rollers cannot hold down the media sufficiently. In this case, move the Media holding rollers (movable) to the position where the media is lifted up. When the media is load flat, move them to the right push roller.
- Move the Media holding rollers (movable) after raising the Media set levers.
- Limp or too much thin media cannot be cut.

For more information on the carrier sheet, refer to "4.2 Cutting using the Carrier Sheet".

For more information on the media width detection, refer to "5.7 Setting the Media Width Detection".

Supported sheet media size: A4 - 20inch (refer to "1.5 Media Size and Cutting Area")

Loading the Media Up Against the Push Rollers

1. Raise the media set levers and release the push rollers.
2. Set the push roller on the left side at the position of the "□" mark.
Set the push roller on the right side according to the width of the sheet media.
3. Lower the media set levers on both sides to lock the push rollers.
4. On the "HOME" screen, touch the "LOAD MEDIA" – "SHEET".

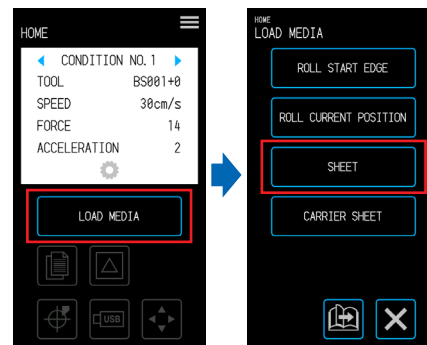

5. Evenly position the edge of the sheet media up against the push rollers. Pass the sheet media under the push roller positioning guide and load it so that it is parallel with the front guide.

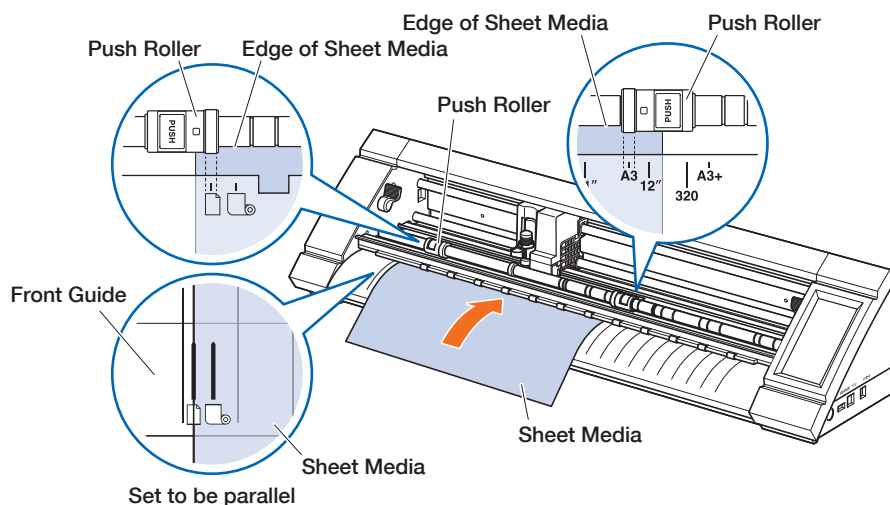

6. Align the left edge of the sheet media with the " | " marking of the " □ " mark on the front guide.

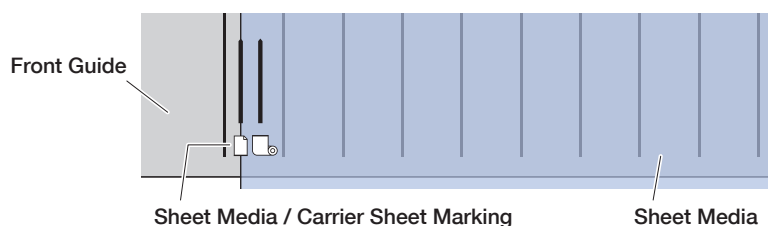

7. The width, front edge, and rear edge of the media are scanned and the sheet media is loaded. If an error is displayed, operate the device by following the on-screen instructions.

⚠ CAUTION

When the "SHEET" is touched, the media and tool carriage will start moving. Be careful to avoid contact with your body or any object.

Loading the Media upon Releasing the Push Rollers

1. Raise the media set levers and release the push rollers.
2. Set the push roller on the left side at the position of the "□" mark.
Set the push roller on the right side according to the width of the sheet media.
3. Insert the front edge of the sheet media in until it reaches the cutting mat (white translucent mat) behind the push rollers.
Pass the sheet media under the push roller positioning guide and load it so that it is parallel with the front guide.
If the sheet media is inserted too far, there may be cases when the media cannot be scanned.

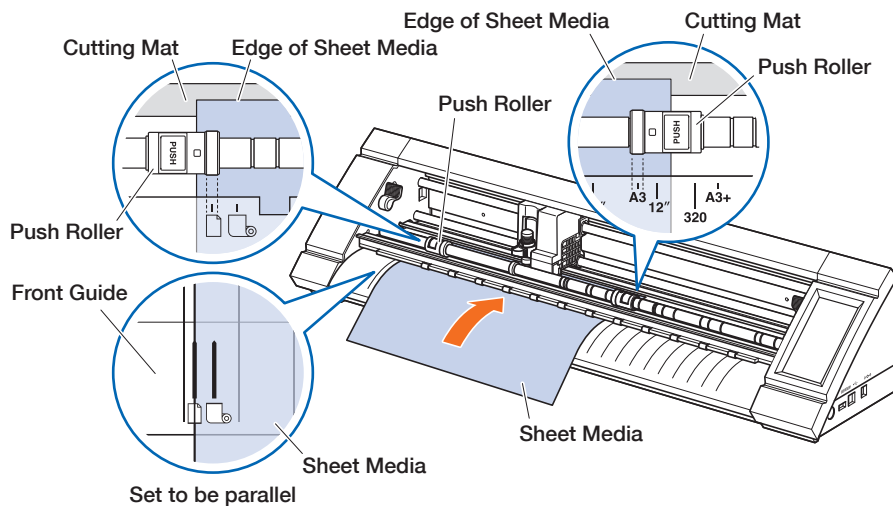

4. Align the left edge of the sheet media with the "I" marking of the "□" mark on the front guide.

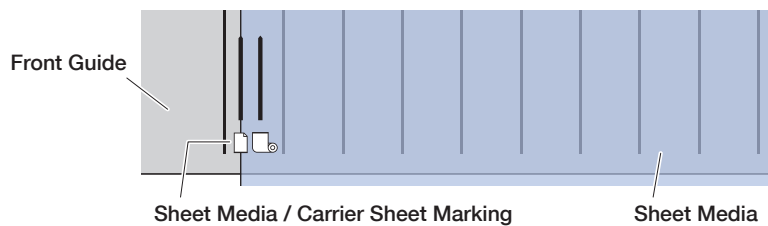

5. Lower the media set levers on both sides and lock the push rollers.

6. On the "HOME" screen, touch the "LOAD MEDIA".
When the "SHEET" is touched, the width, front edge, and rear edge of the media are scanned and the sheet media is loaded.
If an error is displayed, operate the device by following the on-screen instructions.

⚠ CAUTION

When the "SHEET" is touched, the media and tool carriage will start moving. Be careful to avoid contact with your body or any object.

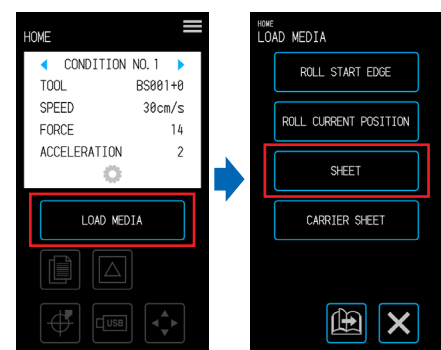

Unloading Sheet Media

1. Confirm that the cutting operation has stopped.
2. Touch the "UNLOAD MEDIA" and the media will be unloaded from the front of the device.

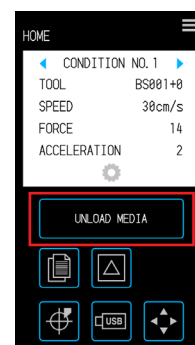

2.5 Confirming the CONDITION NO. (Cutting Condition)

Select a CONDITION NO. to which a cutting condition for the tool is registered and confirm the setting details.

That which is displayed in the currently selected CONDITION NO. and cutting condition.

Select the CONDITION NO. to use with the "◀" and "▶" on the "HOME" screen and confirm the setting details.

For more details on setting the CONDITION NO. and cutting conditions, refer to "5.1 Individually Registering Settings for Cutting Conditions".

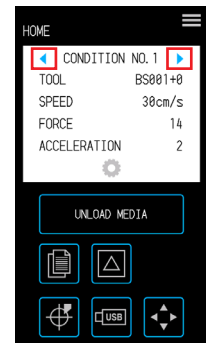

2.6 Precautions when Creating Data

Notes regarding the Cutting Origin Position

The position of the cutting origin will vary depending on the settings for "Cutting Area". Create cutting data in reference to the following:

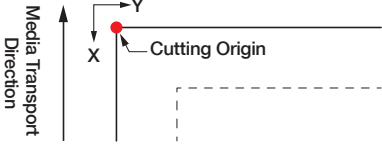
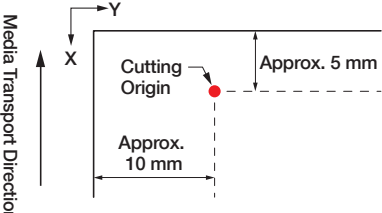
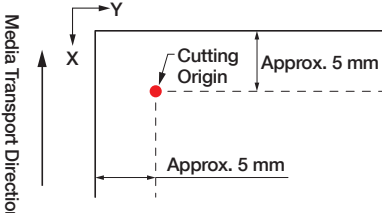
Tilt correction: Enabled Margin: Normal/Expanded	Tilt correction: Disabled Margin: Normal	Tilt correction: Disabled Margin: Expanded
<p>The cutting origin (0, 0) will always be near the vertex of the media edge regardless of the state in which the margin has been set.</p>  <ul style="list-style-type: none"> As the area between the media edge approximately 5 mm inward from the edge is outside of the cutting area, the media will not be cut in this area even if cutting data exists. 	<p>The cutting origin (0, 0) will be the vertex of the effective cutting area. The point approximately 5 mm inward from the front edge and approximately 10 mm from the left edge.</p> 	<p>The cutting origin (0, 0) will be the vertex of the effective cutting area. The point approximately 5 mm inward from the front edge and the left edge.</p> 

- For information on the cutting origin when scanning registration marks, refer to "3.3 Printing & Cutting upon Scanning Registration Marks".
- For information on how to change the cutting origin, refer to "4.6 Cutting upon Specifying Cutting Positions".
- For information on how to change the tilt correction, refer to "3.2 Simple Printing & Cutting".
- For information on how to change the margin settings, refer to "4.7 Expanding the Cutting Area".

Notes regarding the Cutting Area

The cutting area will vary depending on the media and the settings for "Cutting Area". Create cutting data in reference to the following:

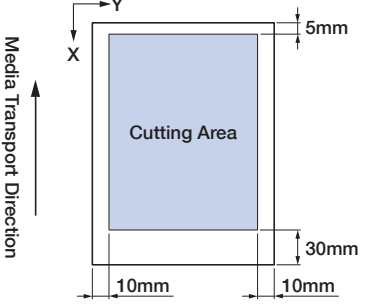
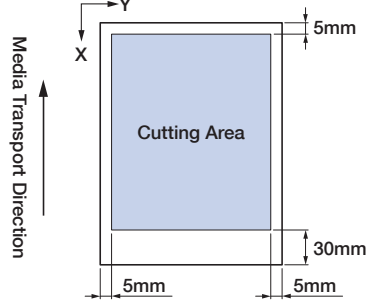
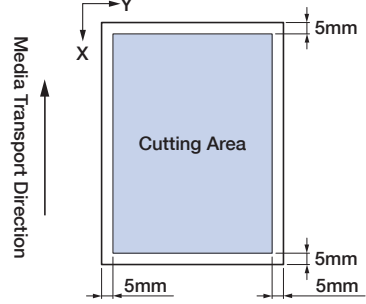
Media: Sheet media Tilt correction: Enabled/Disabled, Margin: Normal	Media: Sheet media Tilt correction: Enabled/Disabled, Margin: Expanded
Front Edge: 5 mm / Left/Right: 10 mm / Rear Edge: 30 mm 	Front Edge: 5 mm / Left/Right: 5 mm / Rear Edge: 30 mm 
Media: Carrier sheet Margin: Normal/Expanded	
Front Edge: 5 mm / Left/Right: 5 mm / Rear Edge: 5 mm 	

- For information on how to change the margin settings, refer to "4.7 Expanding the Cutting Area".
- For more information on the carrier sheet, refer to "4.2 Cutting using the Carrier Sheet".

2.7 Sending Cutting Data

From a computer, send cutting data created in one of the environments listed below.

For more details, refer to the manuals respective to each software.

- Dedicated software: Graphtec Pro Studio Plus (optional)
- Dedicated software: Graphtec Pro Studio
- Dedicated software: Graphtec Studio for Mac
- Dedicated plug-in software: Cutting Master 4
- Dedicated Windows Driver

2.8 Ordinary Care

Conduct ordinary care while being careful of the items listed below.

- Refrain from lubricating the mechanical section.
- To clean the main unit, wipe the unit with either a dry cloth or a cloth soaked in a diluted neutral detergent. Refrain from using substances such as paint thinner, benzene, or alcohol, etc. as these will damage the surface.
- If the cutting mat is dirty, clean it by wiping it with a dry cloth.
If the cutting mat is very dirty, wipe it with a cloth moistened with alcohol or a diluted neutral detergent.
- Dust or dirt, etc. attaching to the sensor unit which scans the media or the roller unit that transports the media can cause the device to malfunction. Regularly wipe these components with a cloth or cotton swabs moistened with alcohol or a diluted neutral detergent.
 - * Absolutely refrain from using benzene, paint thinner, etc.
- If the Y-rail sliding surface has become dirty, gently wipe off the dirt with a clean dry cloth.
 - * Lubricant seeps out onto the sliding surface. Avoid forcefully wiping this off.

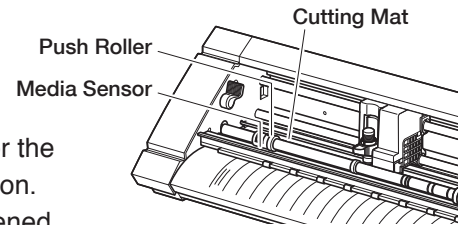

Storage Method

Be careful of the following items for storage when the device will not be used.

- Be sure to remove the tool from the tool holder when storing the device.
- Prevent dust from accumulating by covering the main unit with a cover cloth cover.
- Refrain from storing the device in a location exposed to direct sunlight or subject to high temperatures and humidity.
- Raise the media set levers and place the push rollers in their unlocked state for storage.

Cleaning the Cutter Pen

Media scraps, etc. attached to the tip of the cutter blade will lower the quality of the cuts. Regularly clean the cutter pen to remove any media scraps, etc.

CAUTION

- Be very careful when handling the cutter blade to avoid cutting your hands, etc.
- Clean the tip of the cutter blade with air or a soft material. Using a stiff material can cause the blade to chip or break.

1. Align the red line on the cutter pen with "0" to place it in a state where the blade is not protruding.

2. Turn the Blade Tip Cap to counterclockwise to remove it by using the Blade Tip Cap Jig.

Attach the Blade Tip Cap Jig to the Blade Tip Cap, and then remove the Blade Tip Cap while holding the number part of cutter pen as shown in the picture.

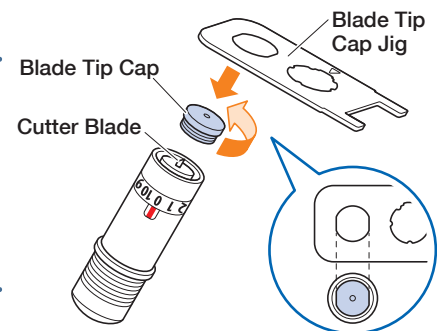

3. Clean the removed blade tip cap and cutter blade with air or a soft material.

4. Attach the Blade Tip Cap to the Cutter pen, and then manually turn the Blade Tip Cap clockwise to install it. Securely tighten the Blade Tip Cap by using the Blade Tip Cap Jig.

Chapter 3 Cutting along Printed Data

"Printing & Cutting" which involves cutting the media along printed data is explained in this chapter along with registration marks.

- 3.1 What is Printing & Cutting?
- 3.2 Simple Printing & Cutting
- 3.3 Registration Mark Scanned Printing & Cutting
- 3.4 Types and Arrangement of Registration Marks
- 3.5 Flow of Creating Registration Marks to Cutting

3.1 What is Printing & Cutting?

Stickers, etc. can be created by placing a cutting line in the media along with the cutting of printed data. In order to realize this printing & cutting function, this device has been equipped with two functions. Use each function according to the environment of use.

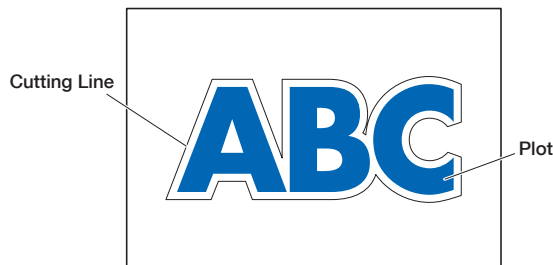

Simple Printing & Cutting

With this function, the edge of the media is scanned and cutting lines are made upon predicting the cutting positions of the printed data based on the position of this scanned edge. This method is useful when working with media on which registration marks cannot be printed.

However, as the edge of the media needs to be scanned, there are conditions such as the media having to be a standardized size and the cutting line being affected by the positioning precision of the printer used.

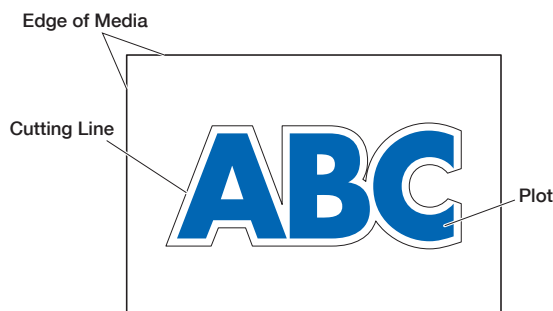

Registration Mark Scanned Printing & Cutting

The data is printed on the media with registration marks (reference lines) added. These registration marks are scanned with the sensor and cutting lines are made upon predicting the cutting positions of the printed data based on the positions of these scanned registration marks.

Because this method is affected by the base, etc. of the media, media on which registration marks are difficult to scan cannot be used.



3.2 Simple Printing & Cutting

When the media is loaded, the position and tilt of the media is scanned in order to layer the cutting line over the printed media.

- As this method does not use registration marks, it is not affected by issues such as not being able to scan the registration marks depending on the image on the base.
However, as this method is affected by the print positioning precision of the printed media, it is recommended that a printer with excellent print positioning precision be used.
- Be sure to use the standard size of media.
- Transparent media cannot be used. When using transparent media, also use release media that is not transparent.
- Media with roughly cut edges and media that is damaged can cause erroneous scans.
- This method cannot be used with roll media.
- For available media setting on the software, you must configure the standard paper size the same as that of your configured plotter.

1. On the "HOME" screen, select the CONDITION NO. to use by using the "◀" and "▶" and set the tool.

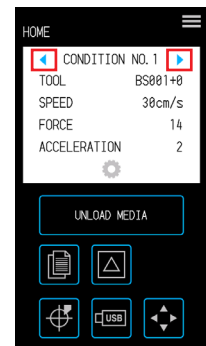

2. From the "MENU" screen, open the "AREA 1/2" screen and set "MEDIA AXIS ADJUST" to "ON".

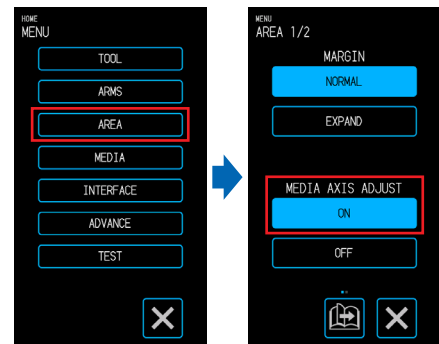

3. Touch the ✕ (Exit) to return to the "HOME" screen and load the printed media to make a sample cut.

4. Measure the displacement of the cutting line from the printed media that has been loaded.

Deciding the Offset Volume

Measure the offset volume (displacement amount) along the X-axis (vertical) and Y-axis (lateral) between the position at which you intended to make the cut and the position that was actually cut.

In the image below, the values are negative for both X and Y.

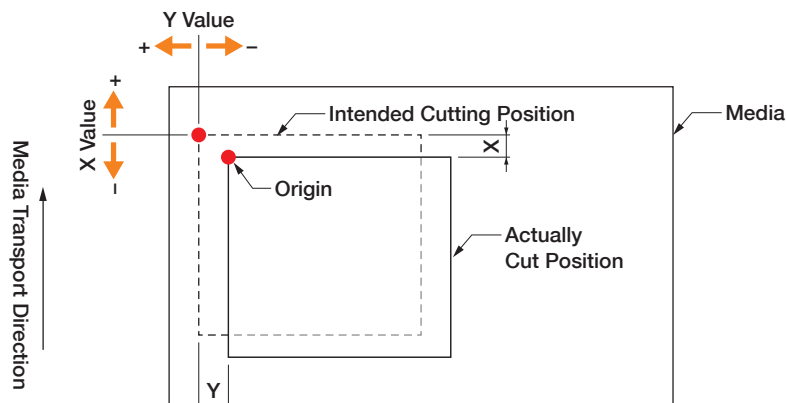

Deciding the Distance Adjustment Volume

Measure the lengths of X (vertical) and Y (lateral) for the shape of the data (printed media) and the shape that was cut.

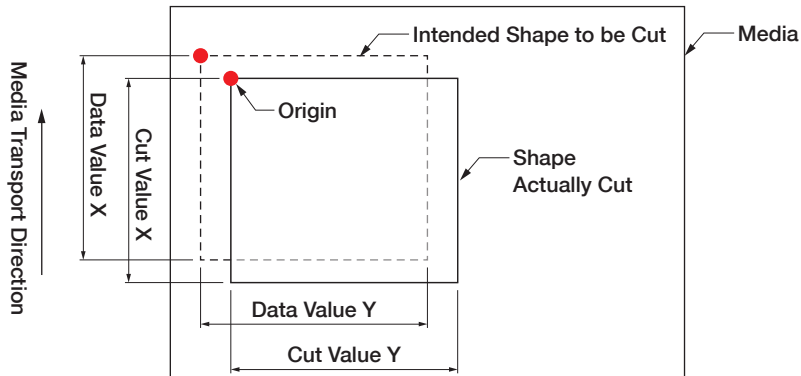

- From the "MENU" screen, open the "AREA 1/2" screen, proceed to the "AREA 2/2" screen, and input the offset and the correction value for distance adjustment. The space inside the white boxes for numerical input can be touched to transition to the input screen. Input the values for the offset value in the X/Y directions and the distance adjustment volumes in the X/Y directions.

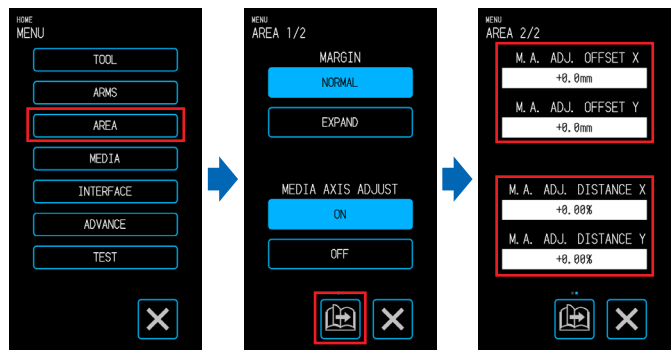

How to Input Numbers

Offset Volume:

Input the displacement amount and confirm the input with the .

Distance adjustment volume:

Input the enlargement/reduction rate (%) and confirm the input with the .

When the cut value is 50 mm and the data value is 51 mm, $(\text{Data value [51]} - \text{Cut value [50]} / \text{Cut Value [50]}) \times 100 (\%) = 2$ so set +2% (after being set, the cut will be made at a length of 51 mm).

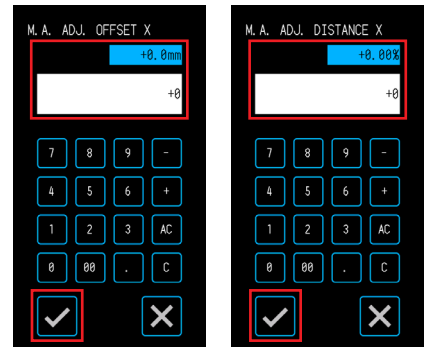

- Touch the (Exit) to return to the "HOME" screen, load the printed media, and perform the cutting operation.

- To make multiple cuts, send the data while changing the media. Printing & cutting will be performed according to the tilt when the printed media is set.

3.3 Registration Mark Scanned Printing & Cutting

With this method, cuts will be made upon scanning the registration marks (reference lines) drawn on the media. High-precision cutting is realized with this method as displacement of the printing position is adjusted when cutting the outline of a printed shape or when re-cutting media.

- If the registration marks cannot be scanned due to a registration mark scanning error or when the positions are off despite the registration marks being scanned, refer to "5.6 Registration Mark Scan Settings" and change the settings.

1. Create printed media on which registration marks have been drawn (refer to "3.4 Types and Arrangement of Registration Marks").

2. On the "HOME" screen, select the CONDITION NO. to use by using the "◀" and "▶" and set the tool.

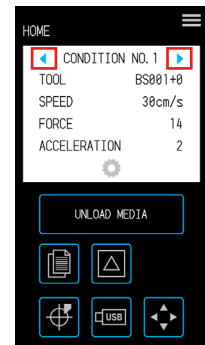

3. Load the printed media on which registration marks have been drawn.

4. Touch the  (Position) to open the "MOVE POSITION" screen.

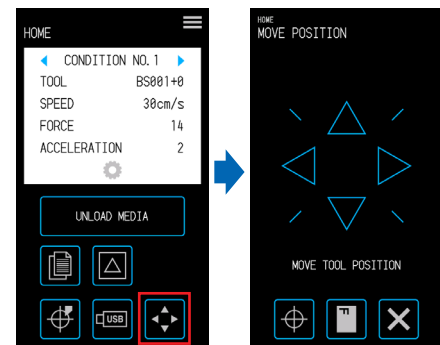

5. Use the "△", "▽", "◀" and "▶" to move the tool to the registration mark scan starting area.

If the current position of the tool is far away from the registration mark scan starting area, it may take time to search for the registration marks or the process may even end in an error.

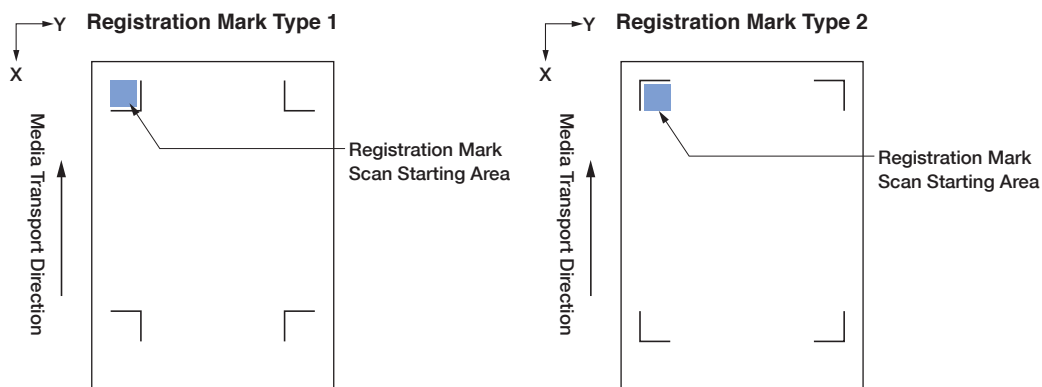

6. Touch the  (Exit) to return to the "HOME" screen and perform the cutting operation.

7. To make multiple cuts, send the data while changing the media. Printing & cutting will be performed according to the tilt when the printed media is set.

3.4 Types and Arrangement of Registration Marks

The types of registration marks that can be scanned with this device are explained in this chapter. Upon understanding the details, create the registration marks using the dedicated application software of "Graphtec Pro Studio", "Cutting Master 4", or "Graphtec Studio for Mac". Download the application software from our company website. URL: <http://www.graphtec.co.jp/en/imaging/celite/support.html>

Registration Mark Shapes

The shape of the registration marks can be one of two types - Type 1 or Type 2. Create the registration marks as plot data using the dedicated application software. Registration marks unique to the application software cannot be used. Line thickness of registration marks: 0.3 - 1.0 mm
Registration mark size: 5 - 20 mm

Registration Mark Type 1

Used when registration marks are preferably left outside of the cutting area. The cutting area within the media will become smaller to account for the size of the registration marks.

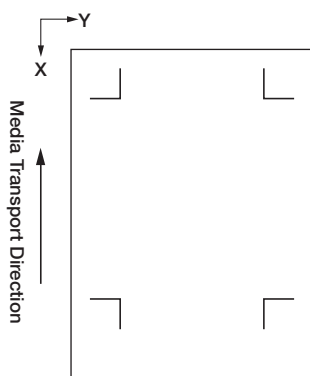

Registration Mark Type 2

Used when the cutting area is preferably kept as close as possible to the size of the media. Care must be taken as the registration marks will be placed within the cutting area. Cutting cannot be performed near the registration marks.

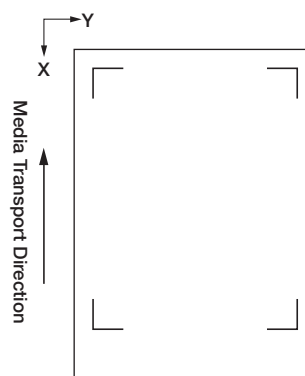

Positions for Registration Mark Arrangement

Registration marks are arranged on the edge of the media with a margin.

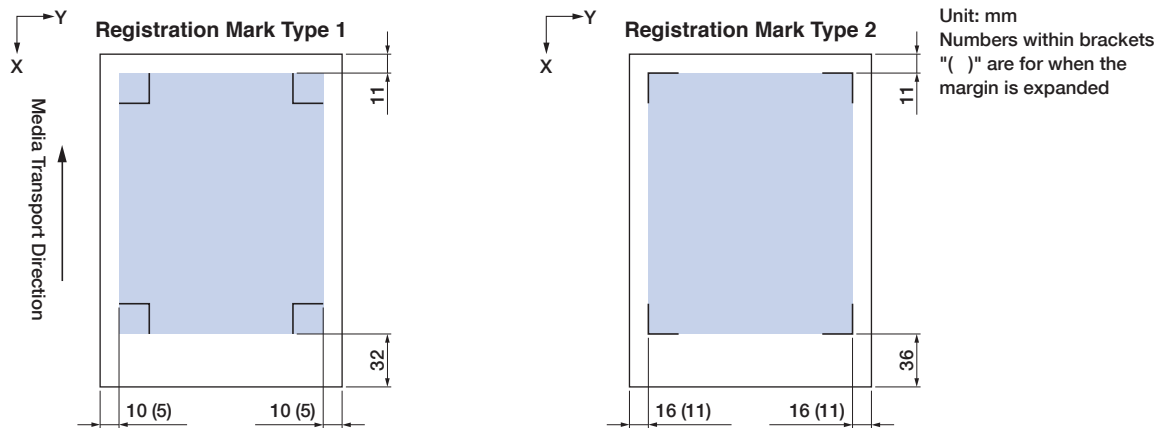

The area required to scan the registration marks is as shown below.

- When a plot other than a registration mark exists in the registration mark scanning area, the plot may be mistaken for a registration mark.
- Be sure to clean the media so that it is free of dirt and dust, etc. Dirt or dust may be mistaken for a registration mark.
- Create the registration marks using a contrast that is easy to scan such as black on white media. Adjust the registration mark settings when using the media other than white or glossy media. (Refer to "5.6 Registration Mark Scan Settings")

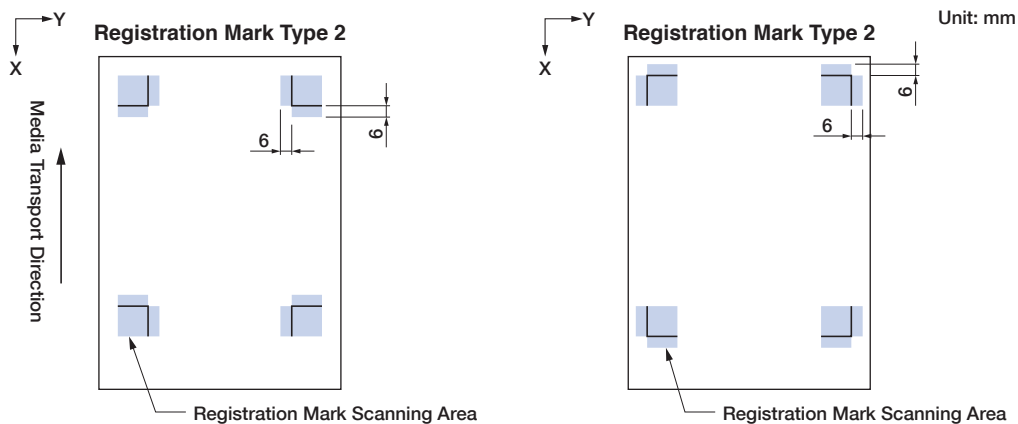

- If a registration mark scan error occurs, configure the registration mark scan settings. (Refer to "5.6 Registration Mark Scan Settings")
- For details on creating registration marks using the dedicated application, refer to "3.5 Flow of Creating Registration Marks to Cutting".

Automatic Registration Mark Position Detection

The area of "A" is scanned from the registration mark scan starting position (position of the tool), and if a registration mark is not located in the area of "A", the area of "B" is scanned.

Registration marks can be recognized as registration marks if they exist within the areas of "A" or "B".

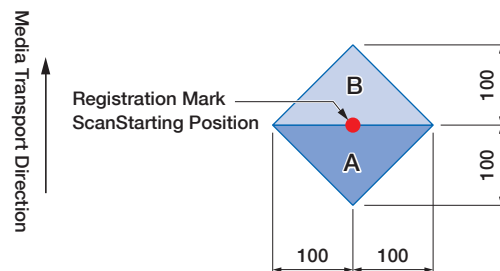

It may be difficult to scan registration marks depending on the state of the media being used.

- Transparent media
- Media with blurry printed registration marks
- Bent media
- Media with a dirty surface
- Media having a thickness of 0.6 mm or more
- Laminated media (depending on the type and state of lamination)
- Media on which black registration mark lines are not printed on a white surface.

When using media on which black registration mark lines are not printed on a white surface, set AUTO MARK SCAN to OFF. (Refer to "Setting Automatic Registration Mark Position Detection")

Otherwise, configure the registration mark scan settings. (Refer to "5.6 Registration Mark Scan Settings")

3.5 Flow of Creating Registration Marks to Cutting

The flow from creating the registration marks using the dedicated application to cutting the plot is explained in this chapter.

Graphtec Pro Studio

[1] Creating the registration marks

- Using the "Rectangle" tool in Graphtec Pro Studio, create a rectangle over the design.

A margin is required at the edge of the media when creating the rectangle. As the printing position may vary depending on the printer used to print the design, it is recommended that a few extra millimeters be allowed for the margin.

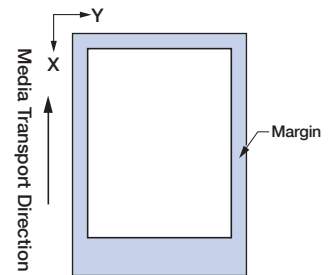

- Select the rectangle, and then select "Effects" – "Rectangle to Contour Cut Mark...".

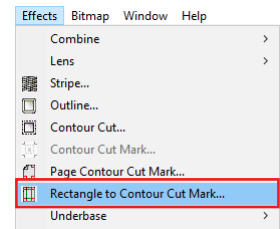

- On the "Design Central" screen, select the type of registration mark.

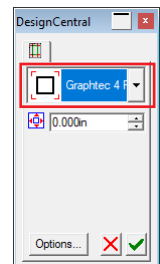

- Click the "Options".
The "Graphtec Mark Options" screen will appear where you can specify the length and line thickness of the registration marks.
After specifying each item, close the screen.

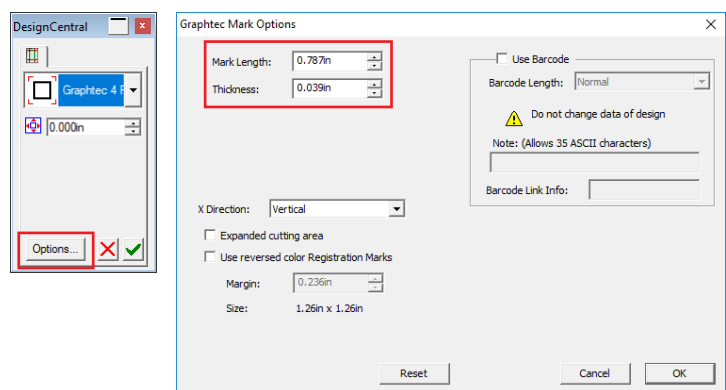

- On the "Design Central" screen, click the "✓".
Registration marks will be created over the design.

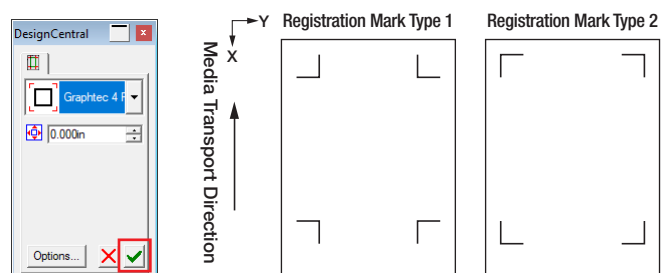

[2] Creating data for printing & cutting

1. Create data for printing & cutting.

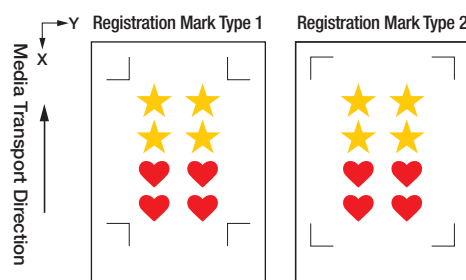

2. Select the printing data, and then select "Effects" – "Contour Cut...".
On the "Design Central" screen, select the offset for the outline.

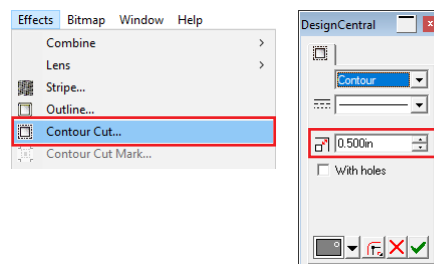

3. On the "Design Central" screen, click the "✓".
Cutting data will be created over the design.

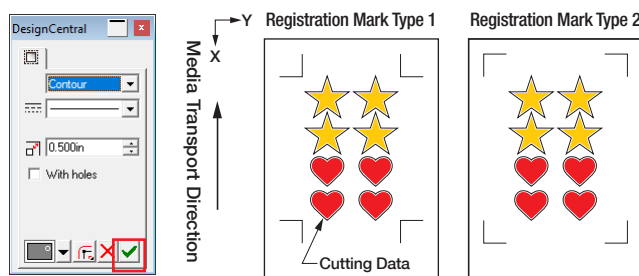

[3] Printing the created data

1. Print the created data.

⚠ CAUTION

Be careful to observe the following items as doing otherwise will lead to not being able to scan the registration marks and perform the cutting.

- Set the enlargement/reduction scale to 100%.
- Set the printing position (center / bottom left, etc.) to "Do Not Change".

[4] Cutting the printed media

1. Load the printed media onto CE LITE-50.
(Refer to "2.4 Loading Sheet Media")

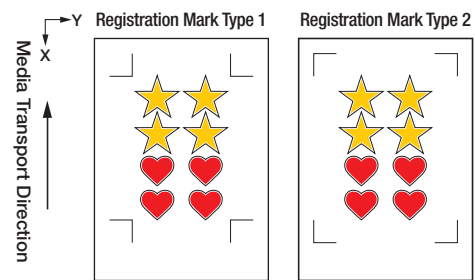

2. Click the "Cut Contour" icon.



3. The "Cut Contour" screen will launch. In order to match the orientation in which the media has been loaded, set ROTATE to "⌂".

- When the "Cut Contour" screen is displayed for the first time, the "Add Device" screen will be displayed. Follow the on-screen instructions to select "CE LITE-50" for the model name and "Graphtec USB" for the connection destination.

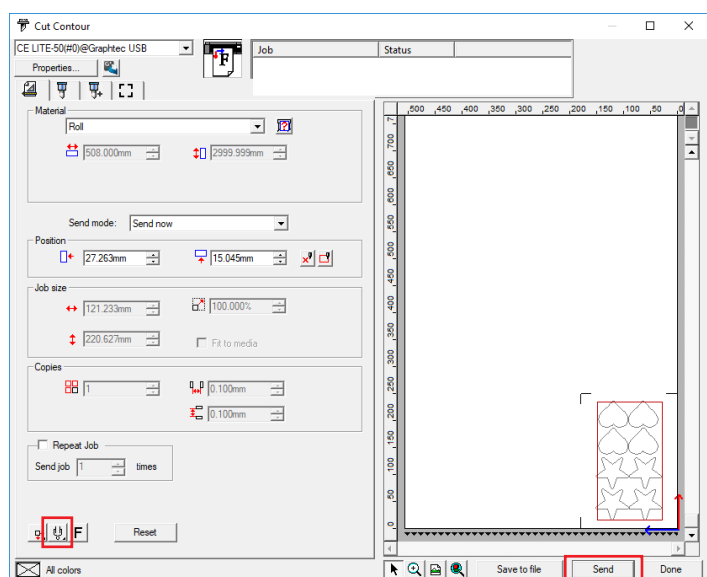

4. Click the "Send".

5. A confirmation screen will appear. Move the tool to the registration mark (red square) at the top left and click the "OK". Scanning of the registration marks will begin, and once all of the registration marks have been scanned, the cutting will begin.

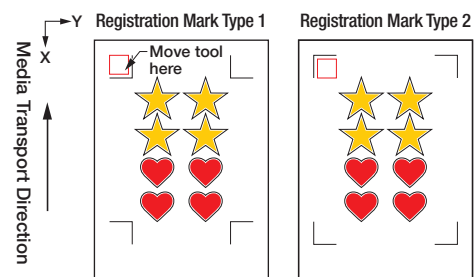

Cutting Master 4

[1] Creating the registration marks

- Using the "Rectangle" tool in Illustrator or CoreIDRAW, create a rectangle over the design.

A margin is required at the edge of the media when creating the rectangle. As the printing position may vary depending on the printer used to print the design, it is recommended that a few extra millimeters be allowed for the margin.

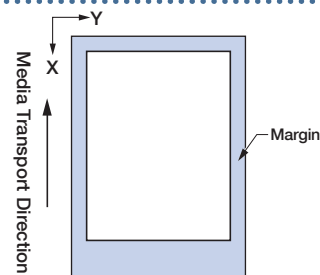

- After selecting the rectangle, when using Illustrator, access the File menu and select "Cutting Master4" – "Registration Marks". When using CoreIDRAW, go to the tool bar and select "Launch" – "Registration Marks (CM4)".

- When using a version of CoreIDRAW that is X7 or earlier, the registration marks screen will be displayed when it is selected from the application launcher.
- The screen to the right is the screen that appears when it is launched from Illustrator.

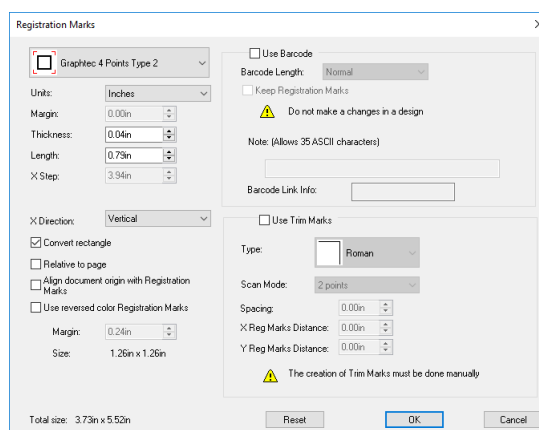

- Specify the registration mark type, line thickness, and length. Place a check in "Convert rectangle".

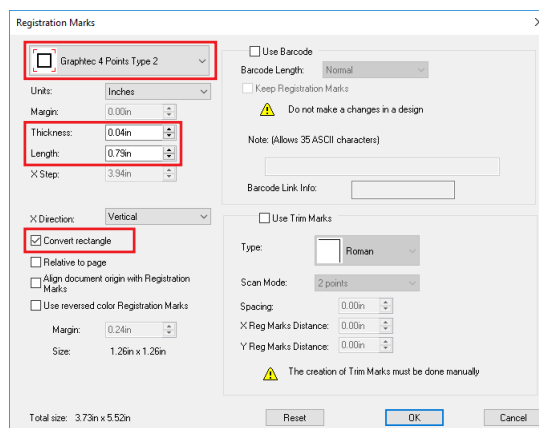

- Close the registration marks screen. Registration marks will be created over the design.

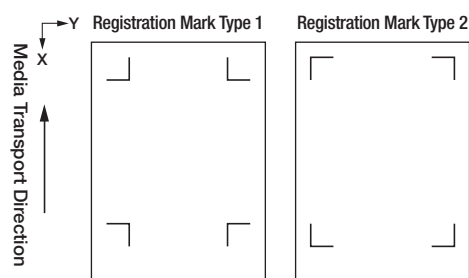

[2] Creating data for printing & cutting

1. Create data for printing & cutting.

It is recommended that the printing data and cutting data be created on separate layers.

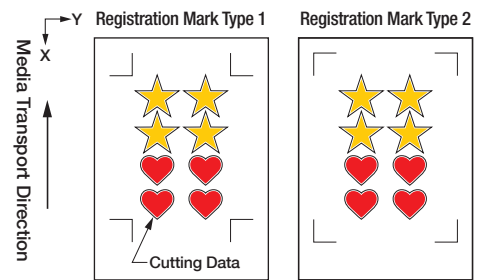

[3] Printing the created data

1. Print the created data.

Before printing the data, set the layer containing the cutting data to be hidden.

CAUTION

Be careful to observe the following items as doing otherwise will lead to not being able to scan the registration marks and perform the cutting.

- Set the enlargement/reduction scale to 100%.
- Set the printing position (center / bottom left, etc.) such that the relative positioning of the position of the created document and the printed results are the same.

[4] Cutting the printed media

1. Load the printed media onto CE LITE-50.
(Refer to "2.4 Loading Sheet Media")

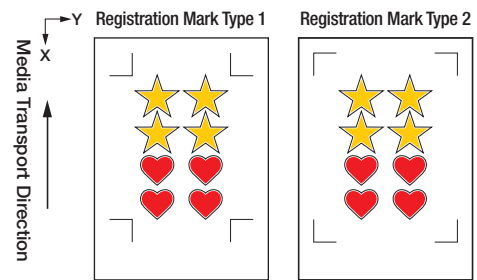

2. When using Illustrator, access the File menu and select "Cutting Master4" – "Cut / Plot".
When using CorelDRAW, go to the tool bar and select "Launch" – "Cut / Plot (CM4)".
 - When using a version of CorelDRAW that is X7 or earlier, this can be selected from the application launcher.
 Before selecting the cutting plot, set the layer containing the printing data to be hidden.

3. The "Cut / Plot" screen will launch.
In order to match the orientation in which the media has been loaded, set ROTATE to "0".
 - When the "Cut / Plot" screen is displayed for the first time, the "Add Device" screen will be displayed.
 Follow the on-screen instructions to select "CE LITE-50" for the model name and "Graphtec USB" for the connection destination.

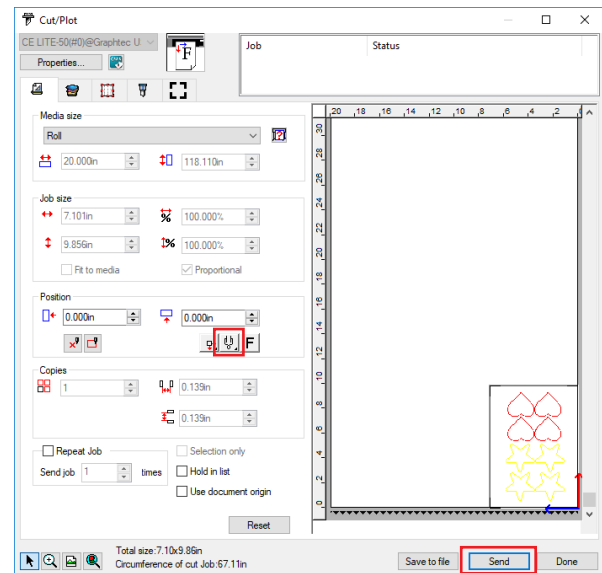

4. Click the "Send".

5. A confirmation screen will appear.
Move the tool to the registration mark (red square) at the top left and click the "OK".
Scanning of the registration marks will begin, and once all of the registration marks have been scanned, the cutting will begin.

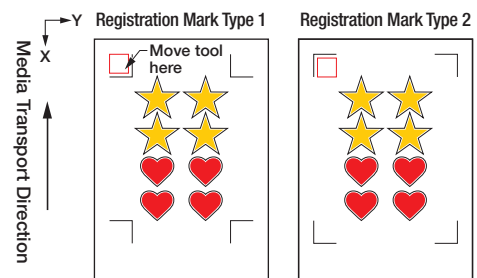

Graphtec Studio

[1] Creating the registration marks

1. From the "Registration Marks" tab in Graphtec Studio, create registration marks over the design.
A margin is required at the edge of the media when creating the registration marks. As the printing position may vary depending on the printer used to print the design, it is recommended that a few extra millimeters be allowed for the margin.

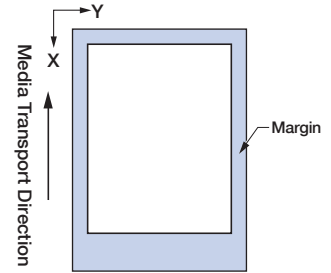

2. Specify the registration mark pattern, length, line thickness, and arrangement positions.

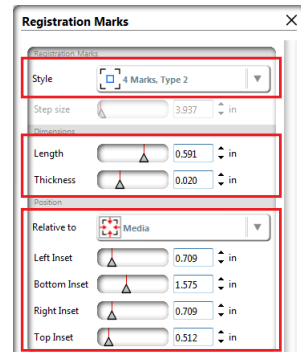

3. Registration marks will be created over the design.

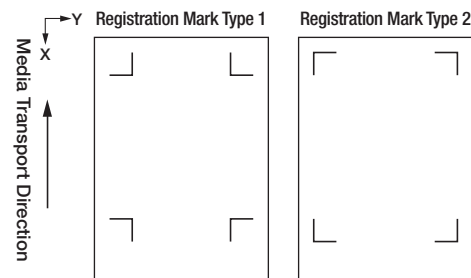

[2] Creating data for printing & cutting

1. Create printing data and cutting data for printing & cutting. Create the cutting data upon specifying a color that is not used in the printing data.

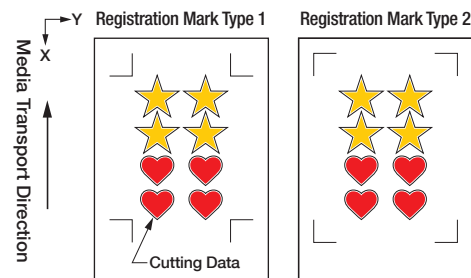

[3] Printing the created data

1. Print the created data.

⚠ CAUTION

Be careful to observe the following items as doing otherwise will lead to not being able to scan the registration marks and perform the cutting.

- Set the enlargement/reduction scale to 100%.
- Set the printing position (center / bottom left, etc.) such that the relative positioning of the position of the created document and the printed results are the same.

[4] Cutting the printed media

1. Load the printed media onto CE LITE-50.
(Refer to "2.4 Loading Sheet Media")

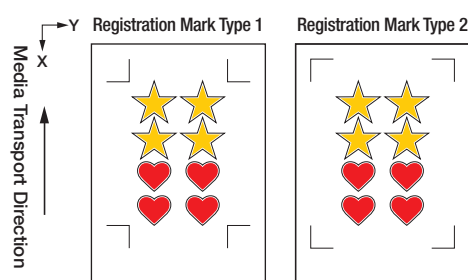

2. Open the "Configure Cut Job" panel.
From "Apply Conditions", select "By Color" and select the color to cut along.

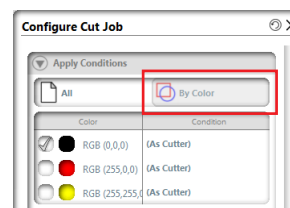

3. Open the "Page" panel.
In order to match the orientation in which the media has been loaded, set ROTATE to "180°".

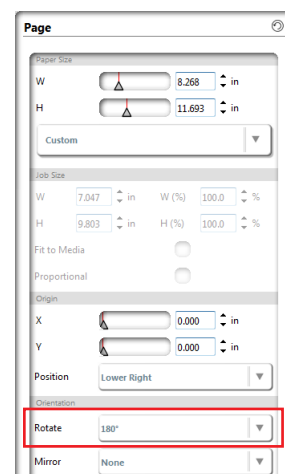

4. Open the "Cutters" panel.

5. Move the tool to the upper left registration mark (indicated in red).

6. Click the "Sent to Cutter".
Scanning of the registration marks will begin, and once all of the registration marks have been scanned, the cutting will begin.

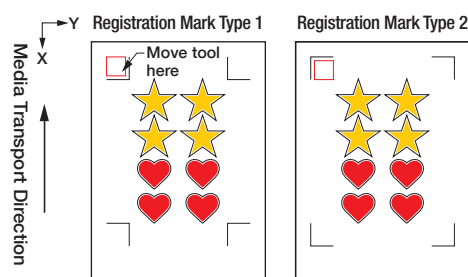

Chapter 4 Convenient Functions

Convenient cutting functions that this device is equipped with are explained in this chapter.

- 4.1 Cutting Roll Media
- 4.2 Cutting using the Carrier Sheet
- 4.3 Plotting with the Drawing Pen
- 4.4 Cutting from a USB Memory
- 4.5 Cutting Multiple Media using the Same Data (Copy Function)
- 4.6 Cutting upon Specifying the Cutting Position
- 4.7 Expanding the Cutting Area
- 4.8 Aborting and Pausing during a Cut
- 4.9 Withdrawing the Tool Carriage

4.1 Cutting Roll Media

To use roll media, load media to the roll media stoker. Roll media of standard media width can be used.

- Depending on the type of media (especially with high transparency), the media cannot be set because CE LITE-50 cannot detect the leading edge /width /position of the media. In this case, disable the Media width detection.
- Depending on the type of media, the center of the media may be lifted up because the push rollers cannot hold down the media sufficiently. In this case, move the Media holding rollers (movable) to the position where the media is lifted up. When the media is load flat, move them to the right push roller.
- Move the Media holding rollers (movable) after raising the Media set levers.
- Limp or too much thin media cannot be cut.

For more information on the media width detection, refer to "5.7 Setting the Media Width Detection."

Supported widths: A4 - 20 inch (refer to "1.5 Media Size and Cutting Area")

Mountable diameters: 2 inch media core Maximum diameter of 150 mm, Minimum diameter of 52.8 mm

3 inch media core Maximum diameter of 150 mm, Minimum diameter of 78.2 mm

Mountable weight: 2.5 kg or less

Assembling the Roll Media Stoker

Set the roll media stoker along the roll media stoker guide rail on the bottom of the main unit. Pay attention to the orientation of each part and set Part A on the left, Part C on the right, and Part B in a position that suits the width of the roll media.

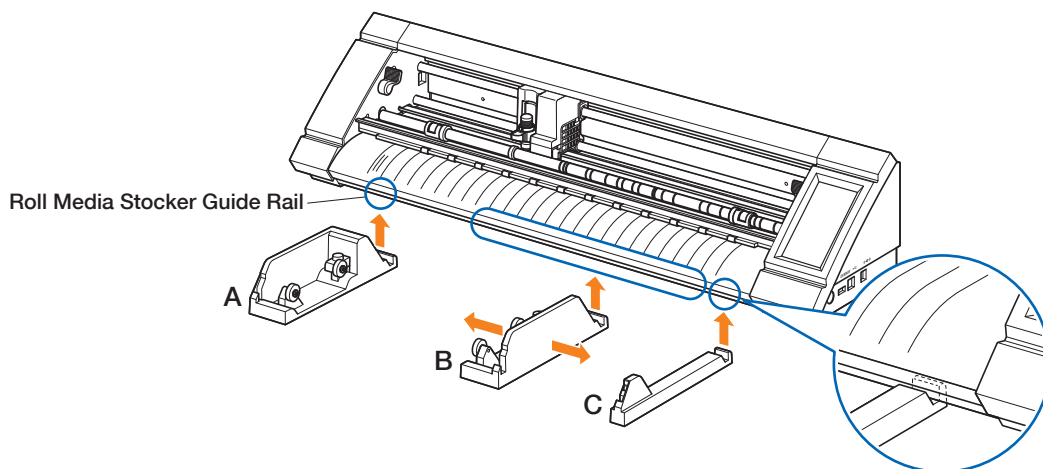

Set Part D to the groove on the edge of Part A, B, and C as shown in the figure below.

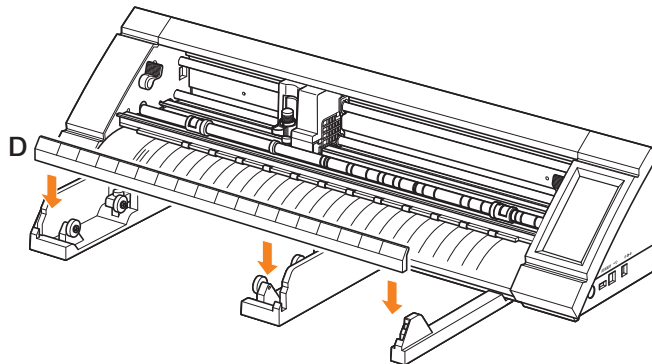

Slide the rollers toward forward when using a 2 inch media core or toward backward when using a 3 inch media core. Loosen the knob to move the roller and fasten the knob to fix the roller in place. Place the roll media on top of the rollers so that the media can be pulled out from the top.

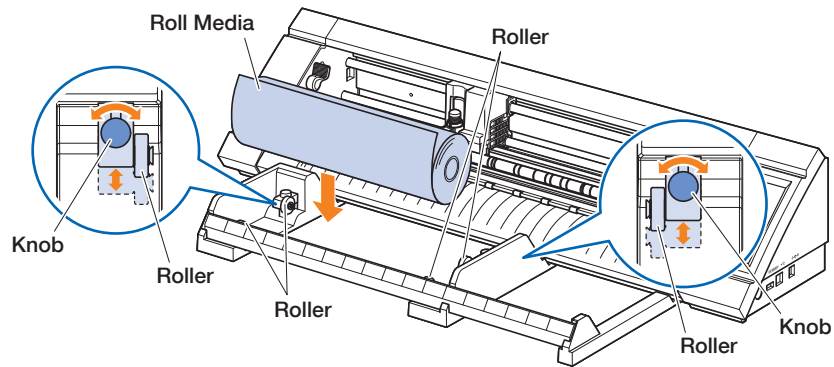

When using the roll media stoker, pay attention to the installation space so that the cutting operation is not affected (refer to "1.4 Installing the Main Unit").

Loading and Scanning Roll Media

There are two types of ways to load roll media with this device.

ROLL START EDGE

Use this option if you wish to cut from the edge of the roll media. The width and the leading edge of the roll media will be scanned.

ROLL CURRENT POSITION

Use this option if you wish to cut from the middle of the roll media. Only the width of the roll media will be scanned.

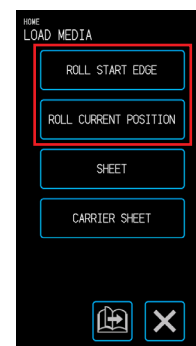

Loading the Media Up Against the Push Rollers

When loading the roll media up against the push rollers, the detection method will be "ROLL START EDGE".

1. Raise the media set levers on both sides and release the push rollers.
2. Set the push roller on the left side at the position of the "□" mark. Set the push roller on the right side according to the width of the roll media.
3. Lower the media set levers on both sides and lock the push rollers.
4. Pull out the roll media and create slack in the roll media that is the same amount as the length used at the front of the main unit.

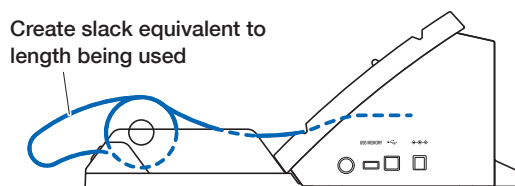

5. Press "LOAD MEDIA" on the "HOME" screen, and select "ROLL START EDGE".

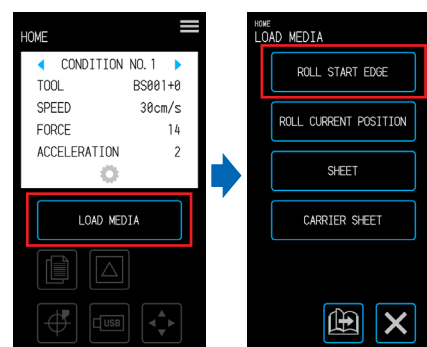

6. Evenly position the leading edge of the roll media up against the push rollers. Pass the roll media under the push roller positioning guide and load it so that it is parallel with the Front front guide.

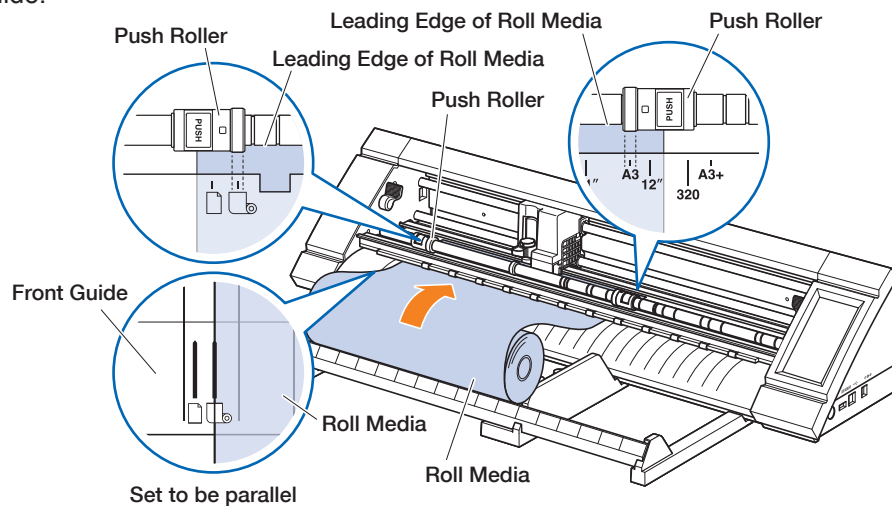

7. Align the left edge of the roll media with the "I" marking of the " " " mark on the front guide.

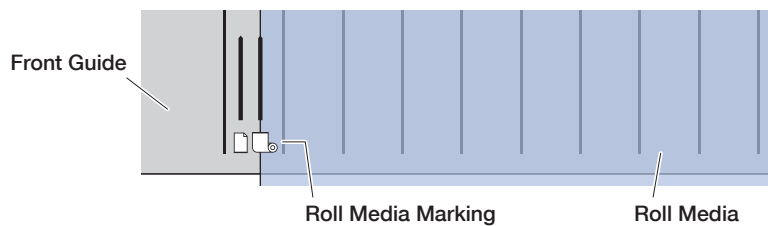

8. The roll media is set after detecting the width and leading edge. Operate the device by following the on-screen instructions when an error message appears.

CAUTION

When the "ROLL START EDGE" is touched, the media and tool carriage will start moving. Be careful to avoid contact with your body or any object.

Loading the Media upon Releasing the Push Rollers

When loading the roll media upon releasing the push rollers, there are two types of ways to scan the roll media - "ROLL START EDGE" and "ROLL CURRENT POSITION".

1. Raise the media set levers on both sides and release the push rollers.

2. Set the push roller on the left side at the position of the "□" mark.
Set the push roller on the right side according to the width of the roll media.

3. When Scanning at the Edge of the Roll Media

Insert the front edge of the roll media in until it reaches the cutting mat (white translucent mat) behind the push rollers.

Pass the roll media under the push roller positioning guide and load it so that it is parallel with the front guide.

If the roll media is inserted too far, there may be cases when the media cannot be scanned.

When Scanning the Roll Media at the Loaded Position

Insert the roll media until the position at which you wish to start cutting is at the home point.

Pass the roll media under the push roller positioning guide and load it so that it is parallel with the front guide.

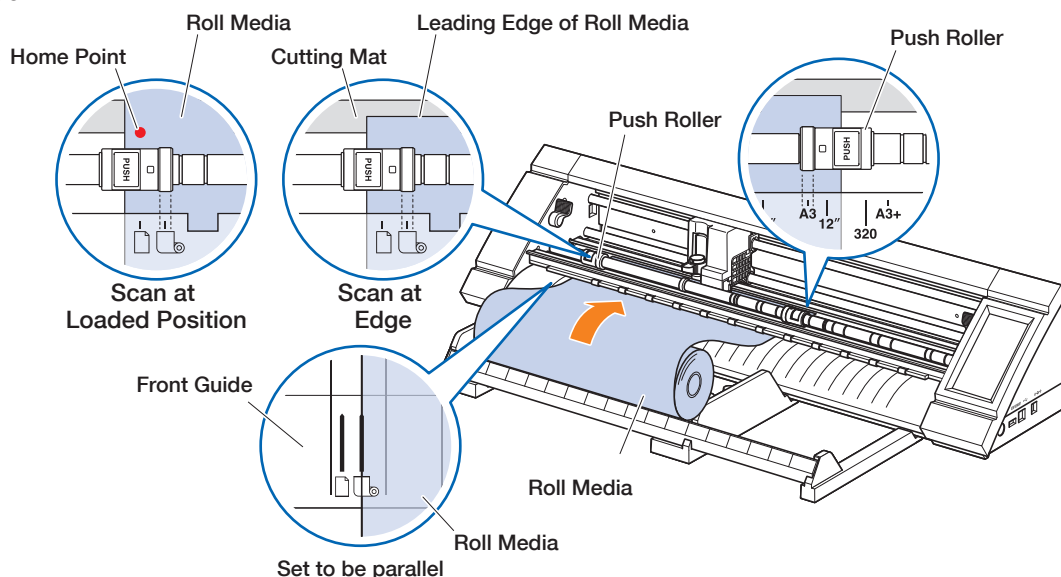

4. Align the left edge of the roll media with the "I" marking of the "□" mark on the front guide.

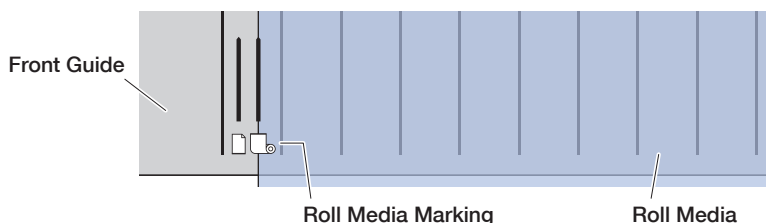

5. Lower the media set levers on both sides and lock the push rollers.

6. Pull out the roll media and create slack in the roll media that is the same amount as the length used at the front of the main unit.

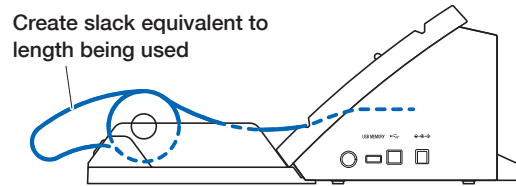

7. On the "HOME" screen, touch the "LOAD MEDIA".

When Scanning at the Edge of the Roll Media

By touching the "ROLL START EDGE", the width and the leading edge of the roll media will be scanned and the roll media will be loaded.

When Scanning the Roll Media at the Loaded Position

By touching the "ROLL CURRENT POSITION", only the width of the roll media will be scanned and the roll media will be loaded.

If an error is displayed, operate the device by following the on-screen instructions.

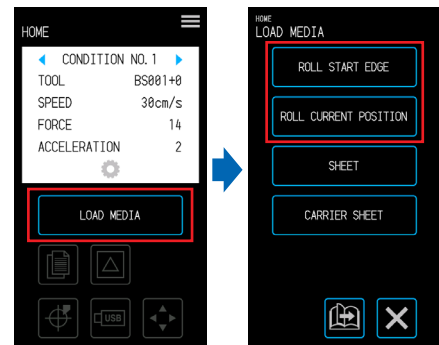

⚠ CAUTION

When the "ROLL START EDGE" or "ROLL CURRENT POSITION" is touched, the media and tool carriage will start moving. Be careful to avoid contact with your body or any object.

Setting the Page Length

When using roll media, set the length of a single page.

- The default setting value is 50 cm. Confirm the setting for the page length when cutting a long item.
- If the cutting data exceeds the page length that has been set, only the parts within the set area will be cutted and anything outside of this area will not be cutted.
- This device guarantees page feeding precision for up to 100 cm (when using media and setting conditions specified by Graphtec).
- When loading media to cut a long item, load the media so that the tension is even at both sides in the direction of the media's width. If the tension is uneven, the media may slip out from under the rollers holding the media in place while cutting.

Once you are done with the setting, touch the **X** (Exit) to return to the "HOME" screen.

Setting values: 10 - 300 (cm)

1. From the "MENU" screen, select "MEDIA 1/3" and proceed to the "MEDIA 2/3" screen.

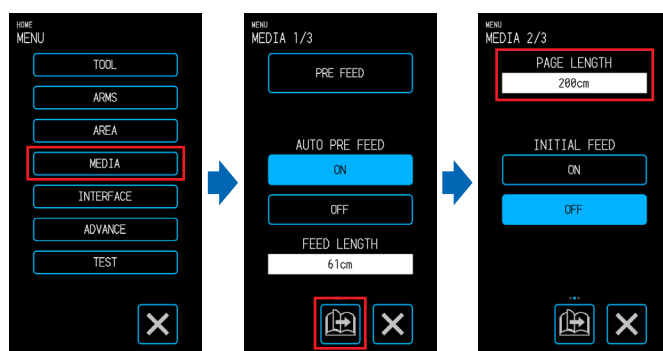

2. Touch the input box for "PAGE LENGTH".

3. Input the page length and confirm the input with the **✓** (Confirm).



Usage of the Cross Cutter

Cross cutter is used to cut in the middle of a long media.

1. Set the cross cutter in the cutter groove on the back of the device.
The arrow mark of the cross cutter indicates the cross-cutting direction.
If the cross cutter is set in the incorrect direction, the media can not be cut.

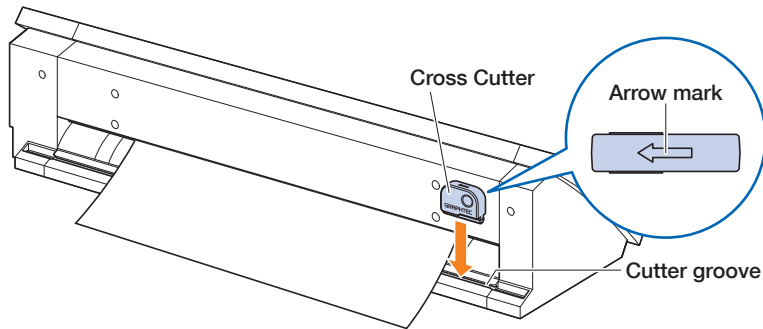

2. Slide the cross cutter along the groove to cut the media.
A cross cut can be performed from either end of the groove.

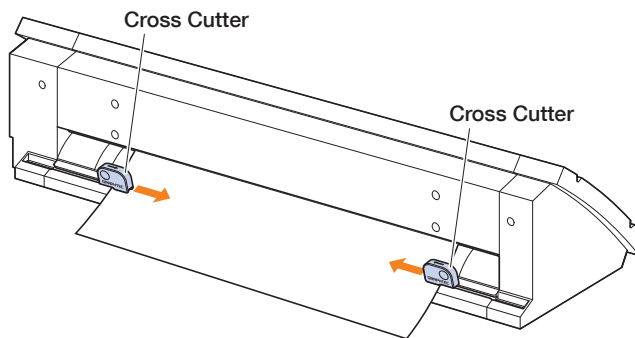

4.2 Cutting using the Carrier Sheet

lthough the carrier sheet (PM-CM-003) makes it possible to cut out the following media.

- When cutting (cutting out) media without a backing.
- When cutting out media (die cutting).
- Media smaller than A4-sized sheets (Do not use media smaller than the postcard [100 × 148 mm]).

Precautions

- lthough the carrier sheet is made to be re-peelable, the sheet will warp and lose its adhesion along with use. In such case, replace with a new carrier sheet.
- As media to attach to the carrier sheet, use media recommended by Graphtec. When using commercially available inkjet media, media coated on both sides cannot be used. When using inkjet media that is coated on a single side, attach the side that is not coated onto the carrier sheet. Attaching the coated side will lower the adhesion of the carrier sheet and may void the carrier sheet of use.
- When removing media from the carrier sheet after it has been cut, be sure to remove the media slowly and carefully.
- As the adhesive portion of the carrier sheet is of a design that easily absorbs moisture, refrain from taking it out of the bag until right before use.
- When storing the carrier sheet, attach the separator removed before use onto the adhesive surface and place it in the bag for storage.
- Refrain from storing the carrier sheet in a location subject to high temperature, high humidity, and direct sunlight.
- When using media with excellent smoothness (no roughness), traces of curling may be left on the media when it is removed.
- Thin media such as copying media may tear upon removal or may even be impossible to remove.

Cutting Area and Cutting Direction

The adhesive area of the carrier sheet, cutting area, and cutting direction are as shown below.

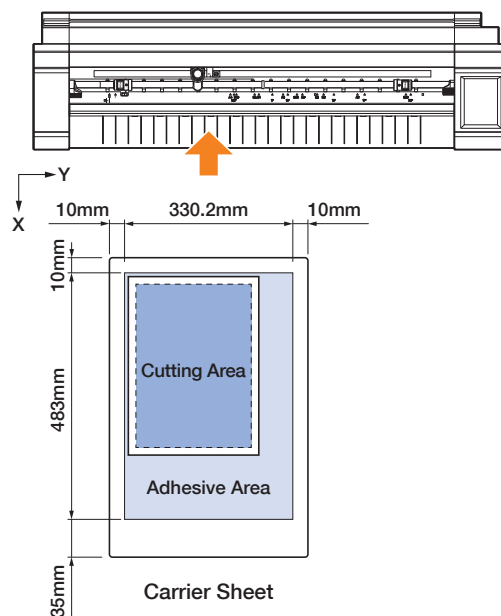

Loading Media onto the Carrier Sheet

- When loading media onto the carrier sheet, be sure to load the media within the range that can be cut (adhesive surface).
- Load the media so that it is parallel with the adhesive surface.
- When attaching the media, firmly press down to prevent bubbles, wrinkles, and peeling.
- Attach the media onto the carrier sheet upon making sure that the media is not excessively curled. Using stiff media that is curled can cause problems such as registration mark scanning errors and the media itself getting caught on something.

1. Peel the separator on the carrier sheet and expose the surface with adhesion.
Do not throw away the separator as it will be used for storage.

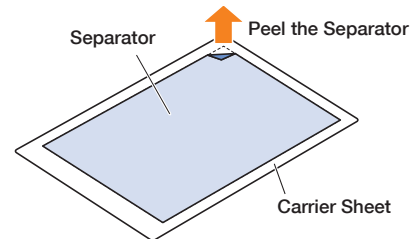

2. Attach the media to the adhesive area of the carrier sheet.
Attach the media so that it is straight in reference to the origin marking on the top left of the carrier sheet.

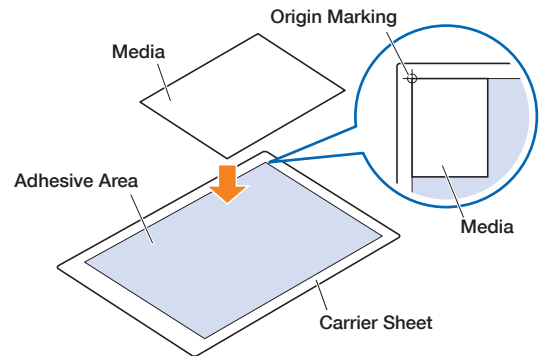

Loading the Carrier Sheet

- Depending on the type of media, the center of the media may be lifted up because the push rollers cannot hold down the media sufficiently. In this case, move the Media holding rollers (movable) to the position where the media is lifted up. When the media is load flat, move them to the right push roller.
- Move the Media holding rollers (movable) after raising the Media set levers.

Loading the Carrier Sheet Up Against the Push Rollers

1. Raise the media set levers and release the push rollers.
2. Set the push roller on the left side at the position of the "□" mark.
Set the push roller on the right side according to the width of the carrier sheet.
3. Lower the media set levers on both sides to lock the push rollers.
4. Press "LOAD MEDIA" on the HOME screen, and select "CARRIER SHEET".

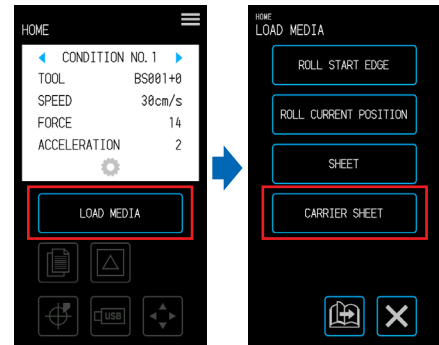

5. Evenly position the leading edge of the carrier sheet up against the push rollers.
Pass the sheet carrier sheet under the push roller positioning guide and load it so that it is parallel with the front guide.

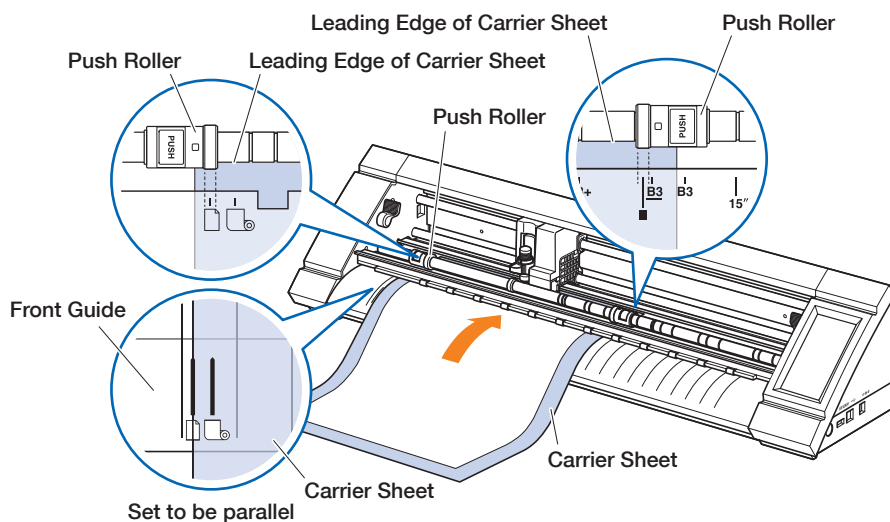

6. Align the left edge of the carrier sheet with the "I" marking of the "☐" mark on the front guide.

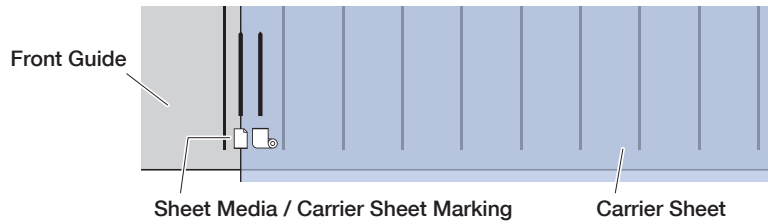

7. The device pulls the carrier sheet in to set.
If an error is displayed, operate the device by following the on-screen instructions.

⚠ CAUTION

When the "CARRIER SHEET" is touched, the media and tool carriage will start moving. Be careful to avoid contact with your body or any object.

Loading the Media upon Releasing the Push Rollers

1. Raise the media set levers and release the push rollers.
2. Set the push roller on the left side at the position of the "□" mark.
Set the push roller on the right side according to the width of the carrier sheet.
3. Insert the front edge of the carrier sheet in until it reaches the cutting mat (white translucent mat) behind the push rollers.
Pass the carrier sheet under the push roller positioning guide and load it so that it is parallel with the front guide.
If the carrier sheet is inserted too far, there may be cases when the media cannot be scanned.

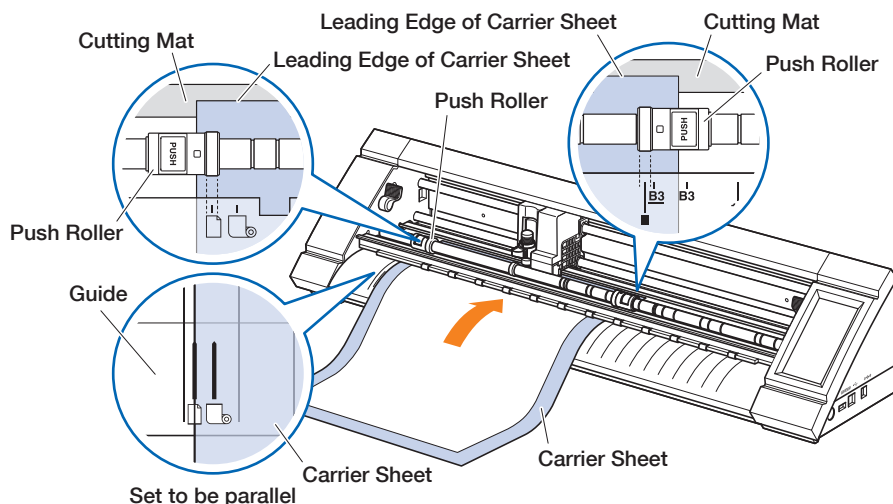

4. Align the left edge of the carrier sheet with the "I" marking of the "□" mark on the front guide.

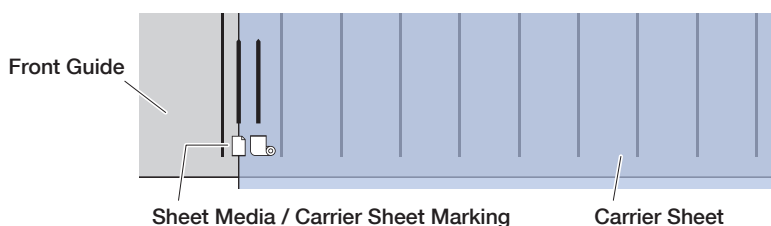

5. Lower the media set levers on both sides and lock the push rollers.

6. On the "HOME" screen, touch the "LOAD MEDIA".
When the "CARRIER SHEET" is touched, the device will perform the operation of bringing in the media and the carrier sheet will be loaded.
If an error is displayed, operate the device by following the on-screen instructions.

CAUTION

When the "CARRIER SHEET" is touched, the media and tool carriage will start moving. Be careful to avoid contact with your body or any object.

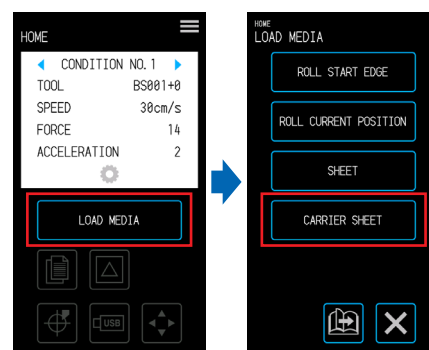

4.3 Plotting with the Drawing Pen

A commercially available drawing pen can be used for plotting by using the optional pen adapter.

Setting the Drawing Pen in the Pen Adapter

Three types of screws are included with the main body of the pen adapter. Use the screw appropriate for the thickness of the drawing pen being used.

S (light gray): $\phi 8 - 9\text{mm}$

M (dark gray): $\phi 9 - 10.2\text{mm}$

L (black): $\phi 10.2 - 11.3\text{mm}$

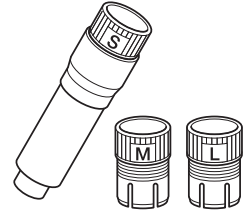

1. Insert the drawing pen into the pen adapter from its rear side.



2. Adjust the pen so that the pen tip is protruding from the pen adapter by approximately 3 mm and turn the fixing screw clockwise to fix the pen in place.

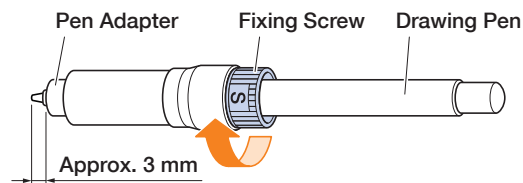

Setting the Pen Adapter

1. Pull the locking lever to open the lock.

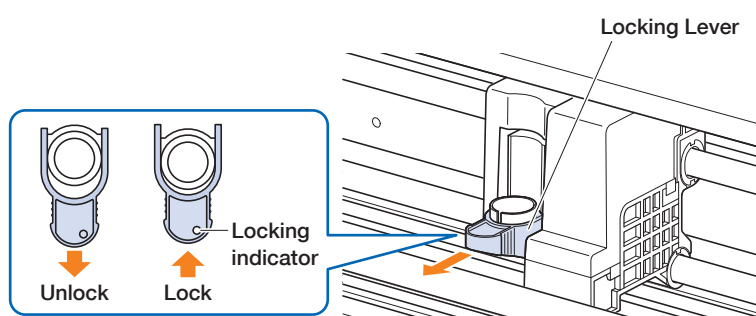

2. Insert the pen adapter to the tool holder while holding it.

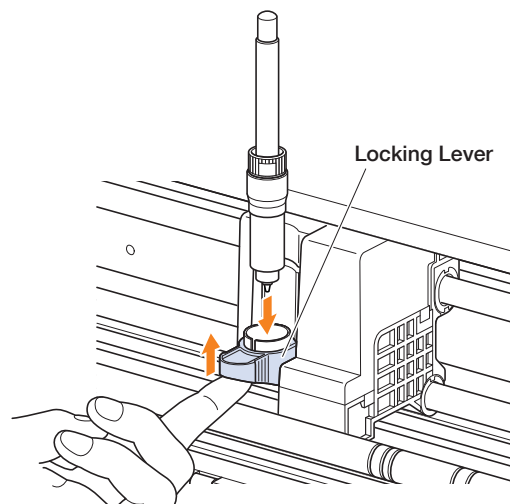

3. Push the locking lever until it clicks to hold the cutter pen. Confirm the locking indicator became the white.

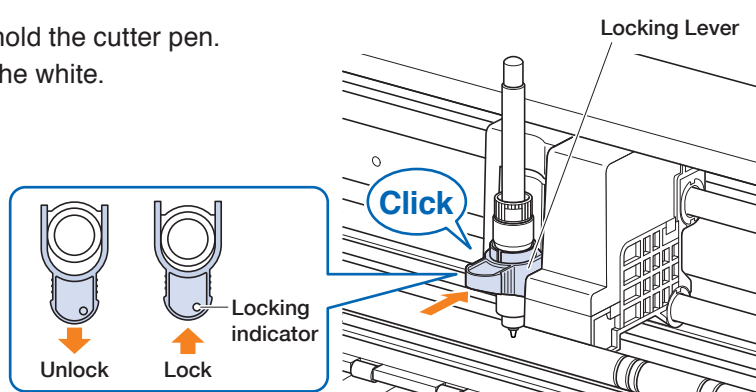

4. Touch the  (CONDITION) on the "HOME" screen to open the CONDITION NO. setting screen.

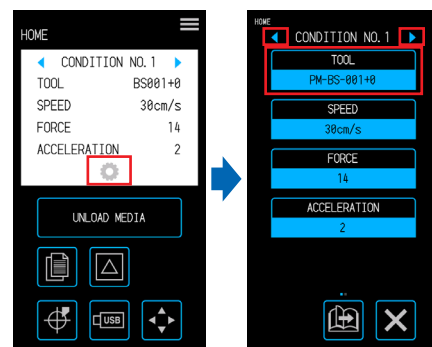

5. Select the CONDITION NO. to set by using the "◀" and "▶" and touch the "TOOL".

6. Touch the selection box for "TOOL".

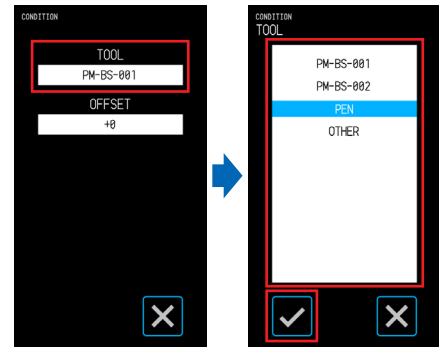

7. Select "PEN" and touch the (Confirm).

8. Configure various settings for the "PEN".



9. Load the media and send the cutting data from the computer.

4.4 Cutting from a USB Memory

Select an .xpf file / plot file saved on a USB memory to perform offline output.

Saving Data on a USB Memory

Create cutting data and save this on a USB memory.

- Files other than files with the extension ".xpf" created using Graphtec Pro Studio or Cutting Master 4 and ".plt" plot files for GP-GL-or HP-GL will not be displayed.
- Only single-byte alphanumeric characters (ASCII) are supported for the file names and folder names.
- Characters prohibited in Windows (¥ / : * ? " < > | \) cannot be used in the file names.
- The maximum number of characters that can be displayed is 25. Names exceeding this length will be scrolled to be displayed.
- Folders are indicated by a folder icon displayed at the beginning of the name.
- The folders and files are listed in order of their names in the ascending order.
- A maximum of 64 folders/files can be acquired.

Cutting upon Loading USB Memory Data

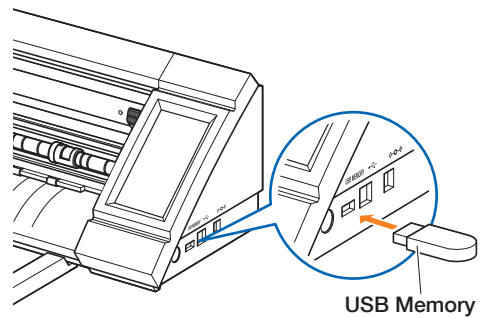

1. Insert a USB memory on which cutting data is saved into the device.





2. Load the media and the tool and select the CONDITION NO.



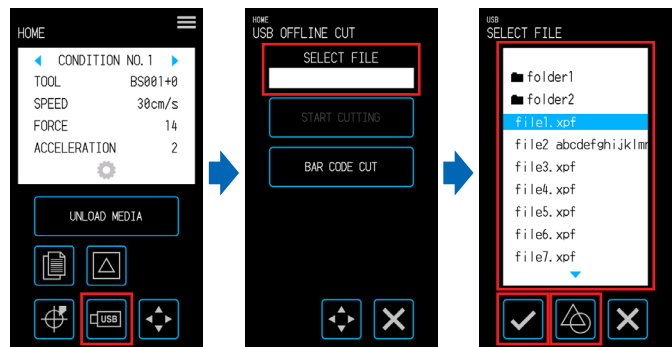

3. On the "HOME" screen, touch the  (USB).

4. Touch the "SELECT FILE".

5. Select a file and confirm the selection with the  (Confirm).
Touch the  (Thumbnail) to display thumbnails  (limited to ".xpf" files that contain thumbnail information).



6. Touch the  (Position) to open the "MOVE POSITION" screen.

7. Use the ", ", ", and "" to move the tool to the cut starting position and touch the  (Origin).

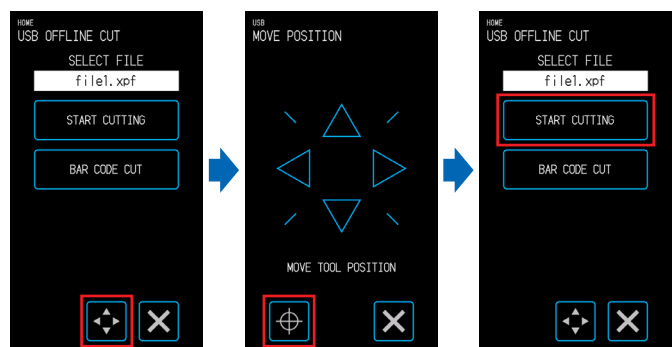

8. When the "START CUTTING" is touched, the device will start cutting.

Cutting Barcode-equipped Data

Barcodes for information regarding the output file can be created with Cutting Master 4 and Graphtec Pro Studio, etc. in order for it to be printed on the media together with the design and registration marks. The printed barcode is scanned when cutting that particular media and the corresponding cutting data (.xpf) within the USB memory is detected to perform the cut.

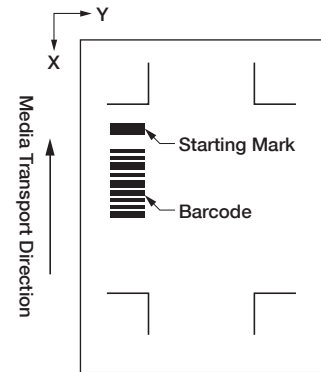

1. Insert a USB memory on which cutting data is saved into the device.

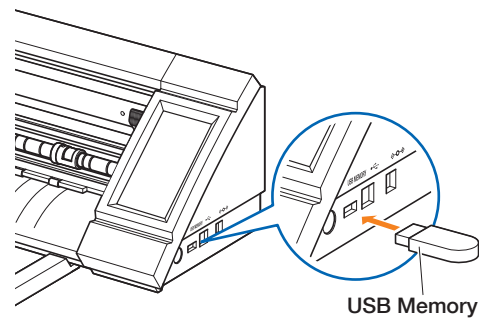



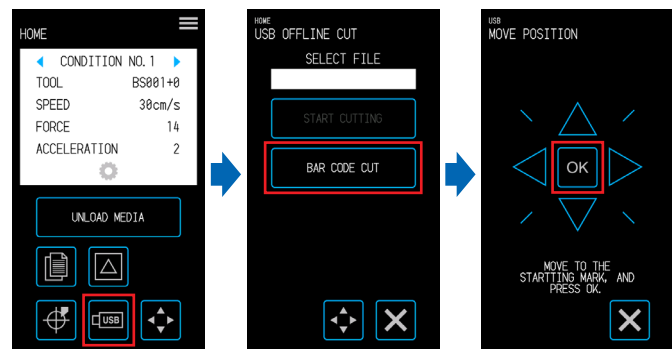

2. Load the tool and the media on which a barcode is printed and select the CONDITION NO.

3. On the "HOME" screen, touch the  (USB).

4. Touch the "BAR CODE CUT".



5. Use the "", "", "", and "" to move the tool to the position of the starting mark and touch the  (OK).

The corresponding file will be detected from the USB memory and the device will start cutting.

CAUTION

When the "OK" is touched, the media and tool carriage will start moving. Be careful to avoid contact with your body or any object.

4.5 Cutting Multiple Media using the Same Data (Copy Function)

Using cutting data retained in the buffer memory, a cut can be repeated for a specified number of times.

- Refrain from sending new data while copying is in progress. Doing so will erase the cutting data in the buffer memory.
- Data with a size of 1.6 MB or larger cannot be copied as it will not fit in the buffer memory of this device.
- If the position of the cutting data at the copying source is far away from the origin, the copied cutting will similarly consist of cutting far away from the origin. In order to eliminate wasteful margins, create cutting data to be as close as possible to the origin.
- The data of layout registration marks cannot be copied.

Copying Multiple Cuts on a Single Media

A cut can be performed for a set number of times on a single media.



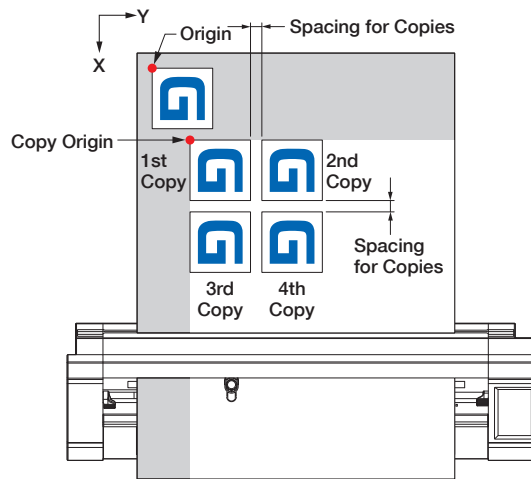

- Be careful so that the cut does not overflow from the media.

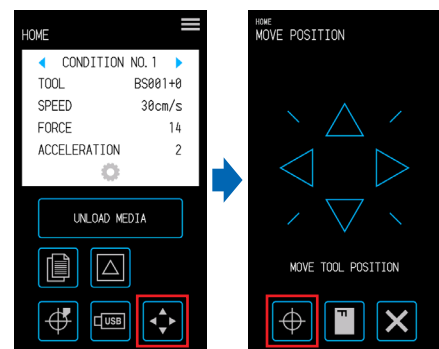

1. Perform the cut once with the data to copy. The cutting data will be retained in the buffer memory.

2. Touch the  (Position) to open the "MOVE POSITION" screen.



3. Use the ", ", ", and "" to move the tool to the copy starting position and touch the  (Origin) to set the position.

4. On the "HOME" screen, touch the  (COPY).





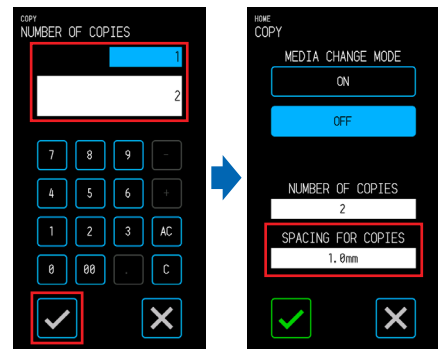

5. Touch the "OFF" in "MEDIA CHANGE MODE" and touch the "NUMBER OF COPIES".

6. Input the number of copies and confirm the input with the  (Confirm).



7. Touch the "SPACING FOR COPIES".

8. Use the "" and "" to select the spacing for copies and confirm the selection with the  (Confirm).

9. When the  (Execute) is touched, the device will start cutting.

 **CAUTION**

When the "Execute" is touched, the media and tool carriage will start moving. Be careful to avoid contact with your body or any object.

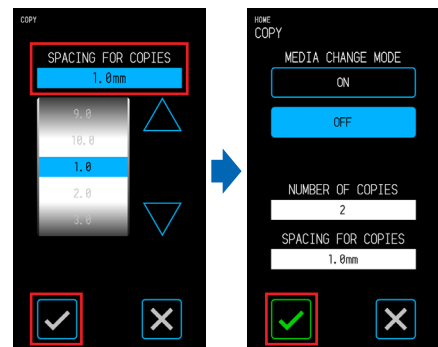

Copying Repeatedly on Multiple Media

The same cut can be performed for a set number of times on multiple media.

- Sheet media or the carrier sheet is used for this procedure.
- At the end of every cut, a message prompting the user to change the media will appear. When the **✕** (Exit) is touched, the copying will be aborted and the display will return to the "HOME" screen.
- Once the media has been changed, the device will immediately scan the media and cut the copy.
- When changing the media, the type of media used for the 2nd copy and thereafter will be the same as that which has been selected for the 1st copy.
- If there is no data in the buffer memory, the message "NO DATA FOR COPY IN BUFFER!" will appear. In such case, send cutting data.
- If data of a size that cannot be contained in the buffer memory is sent, the message "COPY MODE BUFFER FULL!" will appear.

1. Perform the cut once with the data to copy. The cutting data will be retained in the buffer memory.

2. On the "HOME" screen, touch the **📄** (COPY).

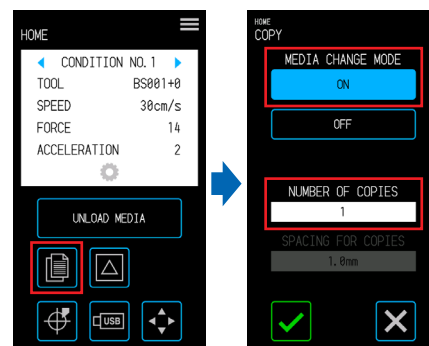

3. Touch the "ON" in "MEDIA CHANGE MODE" and touch the "NUMBER OF COPIES".

4. Input the number of copies and confirm the input with the **✓** (Confirm).

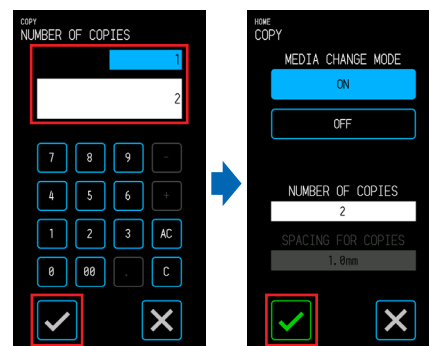

5. When the **✓** (Execute) is touched, the media will be discharged.

6. Load the media to perform the copy with and touch the "LOAD MEDIA".

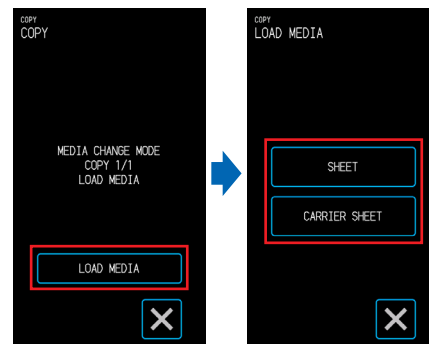

7. When the corresponding to the media that has been set is touched, the media will be loaded and the device will start cutting the copy.

⚠ CAUTION

When the button corresponding to the media is touched, the media and tool carriage will start moving. Be careful to avoid contact with your body or any object.

8. Once the 1st copy has been cut, the message "MEDIA CHANGE MODE COPY LOAD MEDIA" will be displayed until the set number of copies is reached. After each copy is cut, change the media and repeat steps 6 and 7. In the "LOAD MEDIA" for the 2nd copy and thereafter, the media type selection screen will not be displayed and that which was selected for the 1st copy will be used.

4.6 Cutting upon Specifying the Cutting Position

Set the position at which to start cutting (cutting origin). The cutting origin can be set at any position. Once you are done with the setting, touch the **X** (Exit) to return to the "HOME" screen.

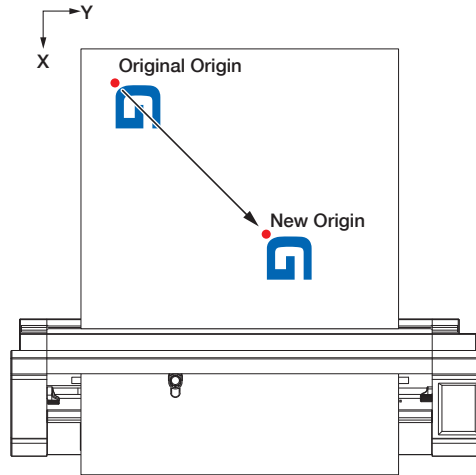

1. Touch the **+** (Position) to open the "MOVE POSITION" screen.

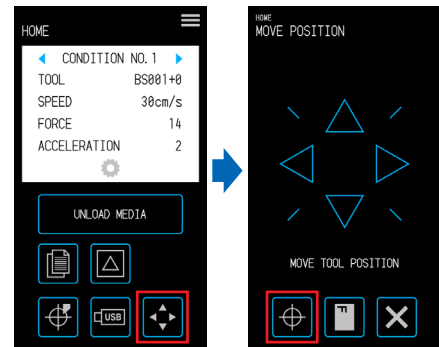

2. Use the "**△**", "**▽**", "**◀**", and "**▶**" to move the tool to the position of the new origin and touch the **+** (Origin) to set the cutting origin.

4.7 Expanding the Cutting Area

The cutting area can be expanded by setting the margin for the media width.

When "EXPAND" is selected, the cutting area is expanded on the left and right sides compared to when "NORMAL" is selected.

- Although cutting at positions that overlap with the push rollers is possible when "EXPAND" is selected, the push roller will be moving within the cutting area and this may prevent normal transport with certain types of media.
- Send cutting data after setting the margin. The cutting data in the buffer memory will be erased when the margin is changed.

Once you are done with the setting, touch the **X** (Exit) to return to the "HOME" screen.

Sheet Media

When margin is normal

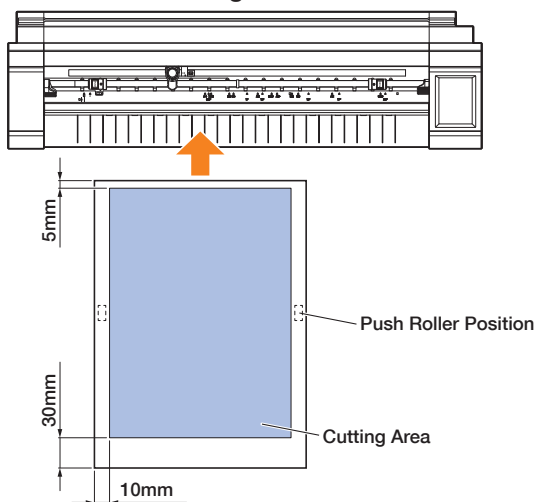

When margin is narrowed

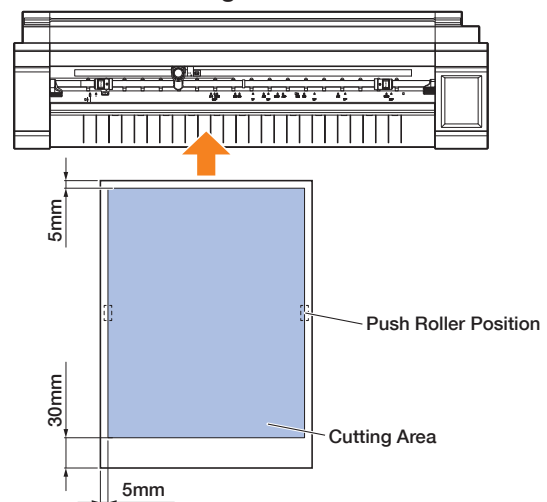

Roll Media

When margin is normal

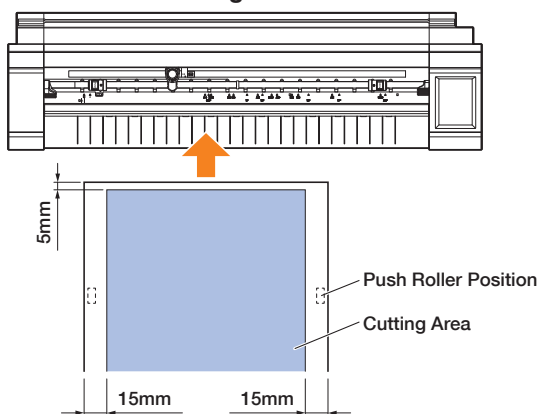

When margin is narrowed

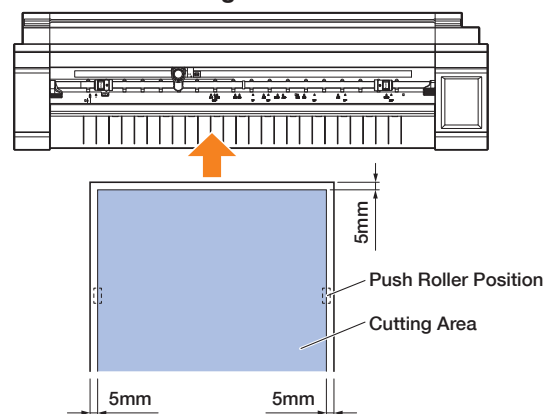

1. From the "MENU" screen, open the "AREA 1/2" screen.

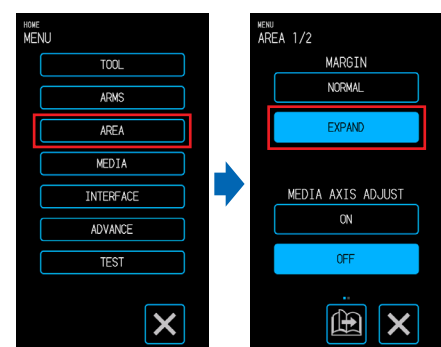

2. For the margin, select "EXPAND".

4.8 Aborting and Pausing during a Cut

The cutting operation of a cut or test, etc. can be aborted or paused.

1. To stop a cut while it is in progress, touch the  (Stop).

2. As the operation method accompanying confirmation of whether to exit the operation will appear, make a selection according to the situation.

"CHANGE SETTING" button:

Used to change the setting for the CONDITION NO. (cutting condition).

 (Confirm) button: Aborts the cutting process.

 (Exit) button: Resumes the cutting process.



4.9 Withdrawing the Tool Carriage

The tool carriage can be withdrawn to the home point. Withdrawing the tool carriage after a cut has been completed will make it easier to confirm the results of the cut.

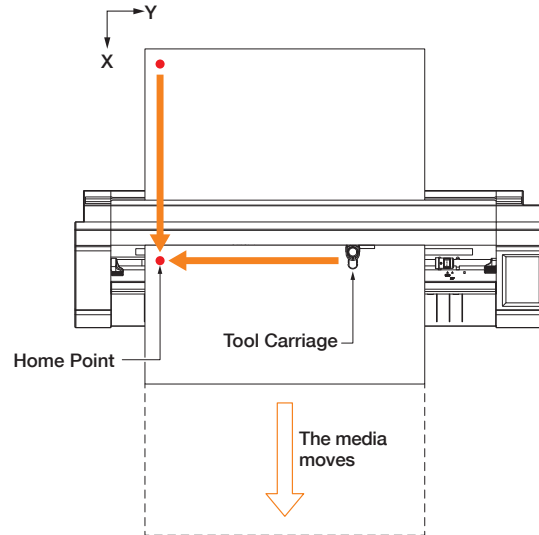

1. When the  (HOME) is touched, the tool carriage will move to the home point.

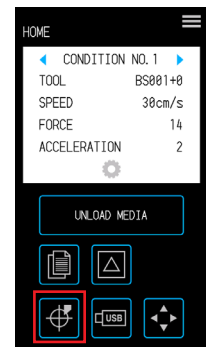

Chapter 5 Detailed Settings

Adjustments in regard to cutting and settings for operation of the device are explained in this chapter.

- 5.1 Individually Registering Settings for Cutting Conditions
- 5.2 Adjusting the Cutting Quality
- 5.3 Adjusting the Cutting Time
- 5.4 Cutting Thick Media
- 5.5 Performing Cut Tests
- 5.6 Registration Mark Scan Settings
- 5.7 Adjusting the Media Operation
- 5.8 Setting Commands
- 5.9 Setting the Operation Panel

5.1 Individually Registering Settings for Cutting Conditions

With settings for cutting conditions, eight types of cutting conditions from CONDITION NO. 1 through 8 can be set and registered.

Set and register conditions according to the type of tool and media to be cut.

TOOL: Select the type of tool to be used.

SPEED: Set the cutting speed.

FORCE: Set the cutting force to be used.

ACCELERATION: Set the acceleration.

TANGENTIAL MODE: Used when cutting thick media.

OVERCUT START: Used to prevent uncut corners.

OVERCUT END: Used to prevent uncut corners.

DISTANCE ADJUST: Corrects the displacement by the length of the cutting line that occurs depending on the type and thickness of the media.

Refer to the sections that follow for details on how to set each item.

1. On the "HOME" screen, touch the  (CONDITION) to open the CONDITION NO. (Cutting condition) setting screen.

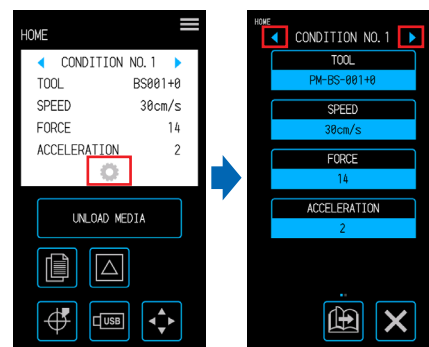

2. As the setting items and details will be displayed, touch the "◀" and "▶" to select the CONDITION NO. to set. Set each item and touch the  (Exit) to return to the "HOME" screen.

5.2 Adjusting the Cutting Quality

The quality of the cut can be adjusted by setting the cutting conditions.

Confirm the quality of the cut in relation to the setting by actually performing a cut. For more details, refer to "5.5 Performing Cut Tests".

Once you are done with the settings, touch the  (Exit) to return to the "HOME" screen.

Selecting the Tool and Setting the Offset Value

Select the tool according to the media to be cut.

Selectable items: "PM-BS-001 (standard accessory)", "PM-BS-002 (optional)"
"Pen (drawing)", "Other"

The offset value is the positional error between the center of the cutter pen body and the center of the blade tip. Adjust this value if the corners of a cut are being cut excessively or not being cut properly. A standard offset value is set for each type of pen. Make fine adjustments based on these standard offset values (make adjustments in reference to 0 being the standard offset value).

Configurable range: -5 to +5

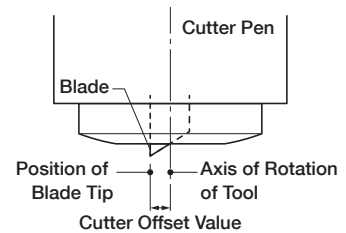



1. Touch the  (CONDITION) on the "HOME" screen to open the CONDITION NO. setting screen.

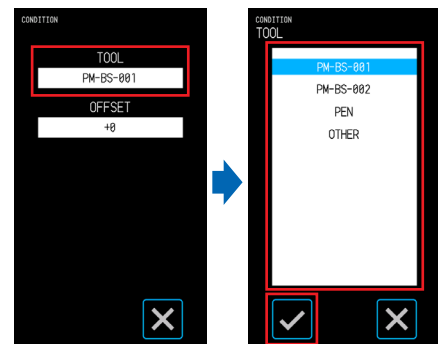

2. Select the CONDITION NO. to set by using the "◀" and "▶" and touch the "TOOL".

3. Touch the "TOOL".



4. Select the tool to use and touch the  (Confirm).

5. Touch the "OFFSET".
The "OFFSET" will not be displayed when "PEN" is selected for the tool.

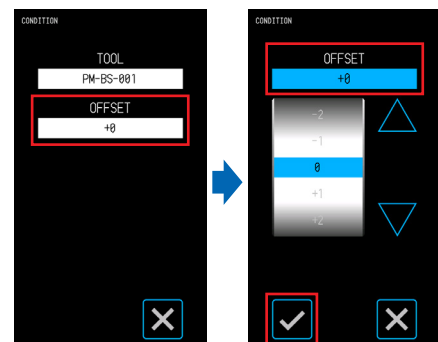



6. Use the "▲" and "▼" to select the offset value and confirm the selection with the  (Confirm).

Setting the Cutting Force

Set the cutting force to use the tool with. Adjust this value if the cuts are too shallow or too deep.

Configurable range: 1 - 26

1. Touch the  (CONDITION) on the "HOME" screen to open the CONDITION NO. setting screen.
2. Select the CONDITION NO. to set by using the "◀" and "▶" and touch the "FORCE".
3. Use the "△" and "▽" to select the cutting force and confirm the selection with the  (Confirm).

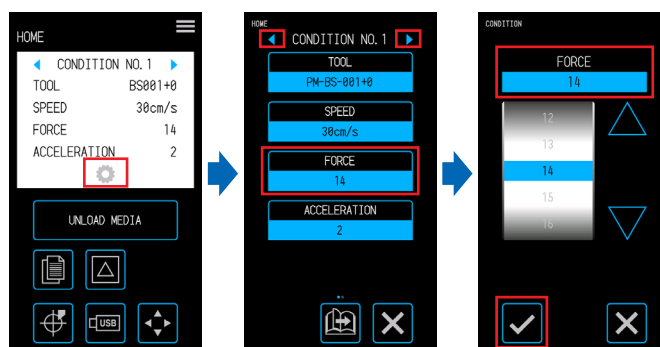

Setting the Offset Force

Set the cutting force for initial control (offset force) that is performed during initial operations in order to confirm the orientation of the blade tip. If the offset force is too weak, the orientation of the blade may be unstable at the beginning of the cut and cause the starting point and ending point to not match up.

The offset force is also used as the cutting force when performing rotary control of the blade tip when operating in the tangential mode.

Configurable range: 1 - 26

1. From the "MENU" screen, open the "TOOL 1/2" screen.
2. Touch the "OFFSET FORCE".
3. Use the "△" and "▽" to select the offset force and confirm the selection with the  (Confirm).

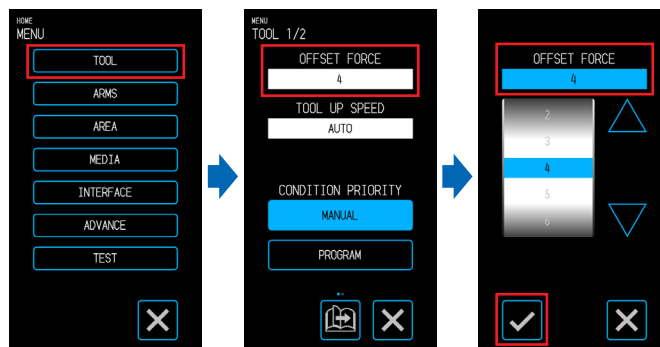

Setting the Condition Priority

Select "MANUAL" or "PROGRAM" for the condition of the tool.

MANUAL: Cutting conditions sent from the software are invalidated while the conditions set with the operation panel are made valid.

PROGRAM: The cutting conditions can be changed from both the operation panel and the software making it possible to overwrite the setting with new cutting conditions at any time.

1. From the "MENU" screen, open the "TOOL 1/2" screen.

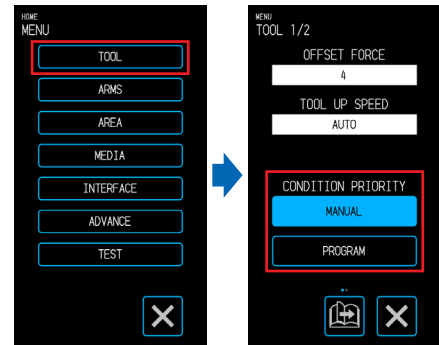



2. For the condition priority, select "MANUAL" or "PROGRAM".

Setting the Distance Adjustment

Corrects the displacement by the length of the cutting line that occurs depending on the type and thickness of the media being used. The value for distance adjustment is input as a percentage for the amount of displacement for the length of the line. For example, if +0.1% is set as the correction value, the length of a line that is 1 m (1000 mm) will increase by 1 mm (= 1000 × 0.1%) and become 1001 mm.

This distance adjustment can be configured for each CONDITION NO.

1. Touch the  (CONDITION) on the "HOME" screen to open the CONDITION NO. setting screen.

2. Select the CONDITION NO. to set by using the "◀" and "▶" buttons and touch the  (PAGE) button to proceed to the next page.

3. Touch the "DISTANCE ADJUST" button.

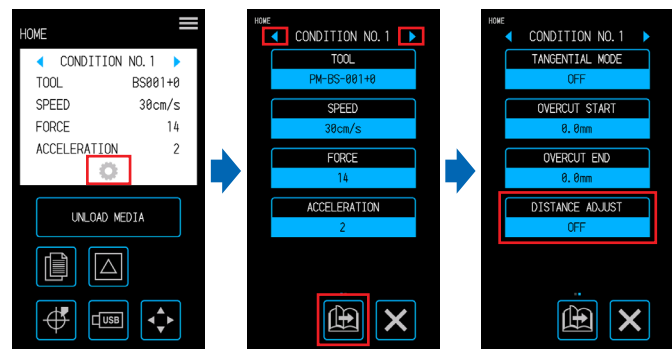

4. Select "ON" or "OFF" for "DISTANCE ADJUST".
When "ON" is selected, it will be possible to input a value in the "DISTANCE ADJUST X" box and "DISTANCE ADJUST Y" box.

5. Touch the "DISTANCE ADJUST X" box.

6. Input the value for distance adjustment and confirm the input with the  (Confirm) button.



7. Similarly input "DISTANCE ADJUST Y".

Setting the Blade Tip Orientation Initialization Position

Place the blade against the media either immediately after turning the power ON or prior to cutting after setting the pen conditions and adjust the orientation of the blade tip.

As this operation involves putting the blade on the media, set the position at which the blade tip orientation is initialized so that the initialization is performed at a position that will not scratch the cut.

OUTSIDE: The blade tip orientation initialization will be performed at a position that is outside of the cutting area.

2mm BELOW: The blade tip orientation initialization will be performed at a position that is 2 mm downwards from the cut starting position (2 mm towards the edge in the media transport direction).

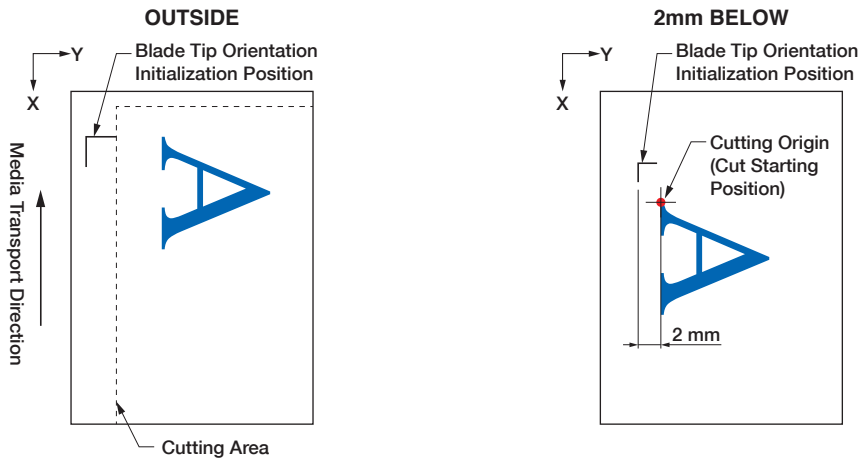

1. From the "MENU" screen, open the "TOOL 1/2" screen and proceed to the "TOOL 2/2" screen.

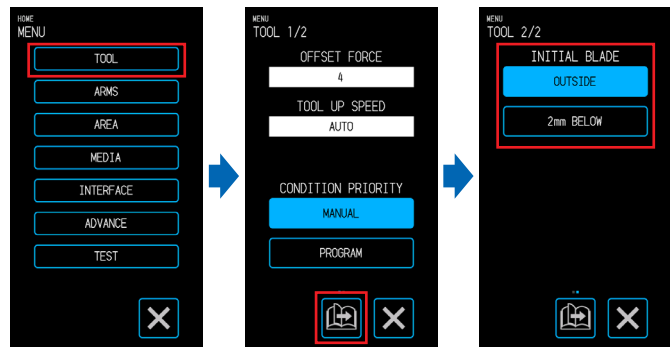

2. Select "OUTSIDE" or "2 mm BELOW" for the INITIAL BLADE.

5.3 Adjusting the Cutting Time

The cutting time can be adjusted by setting the "cutting speed", "speed when starting the cut (acceleration)", and "moving speed when the tool is lifted".

As setting a speed that is too fast can affect the cutting quality, set values that suit the type of tool and media to be used.

Once you are done with the settings, touch the **X** (Exit) to return to the "HOME" screen.

Setting the Speed

Set the cutting speed.

Although setting a faster speed will shorten the cutting time, doing so may also lower the quality of the finish.

Configurable values: 1, 2, 3, 4, 5, 6, 7, 8, 9, 10, 15, 20, 25, 30, 35, 40, 45, 50

1. Touch the **⚙** (CONDITION) on the "HOME" screen to open the CONDITION NO. setting screen.
2. Select the CONDITION NO. to set by using the "**◀**" and "**▶**" and touch the "SPEED".
3. Use the "**▲**" and "**▼**" to select the speed and confirm the selection with the **✓** (Confirm).

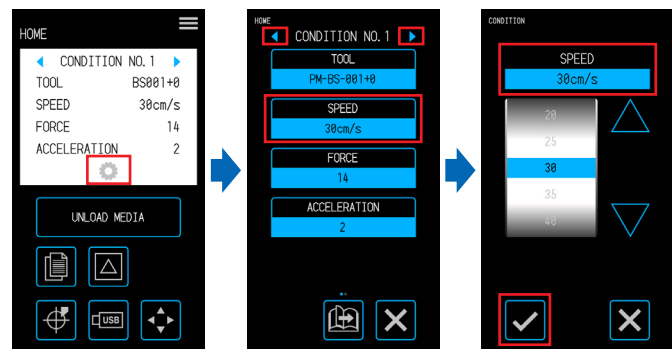

Setting the Acceleration

Set the acceleration. This setting is applied to all operations when starting the cut after the tool has been lowered.

Although setting a greater value will shorten the cutting time, doing so may also lower the quality of the finish.

Configurable range: 1 - 2

1. Touch the **⚙** (CONDITION) on the "HOME" screen to open the CONDITION NO. setting screen.
2. Select the CONDITION NO. to set by using the "**◀**" and "**▶**" and touch the "ACCELERATION".
3. Use the "**▲**" and "**▼**" to select the acceleration and confirm the selection with the **✓** (Confirm).

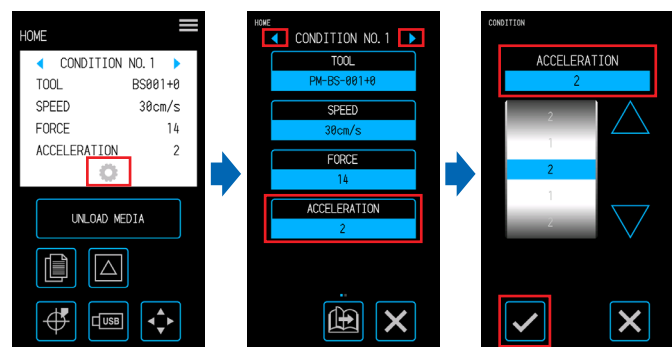

Setting the Tool Up Speed

Set the moving speed of the tool when it is raised during cutting.

The AUTO setting will apply the same speed as the cutting speed (when the tool is lowered).

Configurable values: AUTO, 10, 20, 30, 40, 50 (cm/s)

1. From the "MENU" screen, open the "TOOL 1/2" screen.

2. Touch the "TOOL UP SPEED".

3. Use the " \triangle " and " ∇ " to select the moving speed and confirm the selection with the (Confirm).

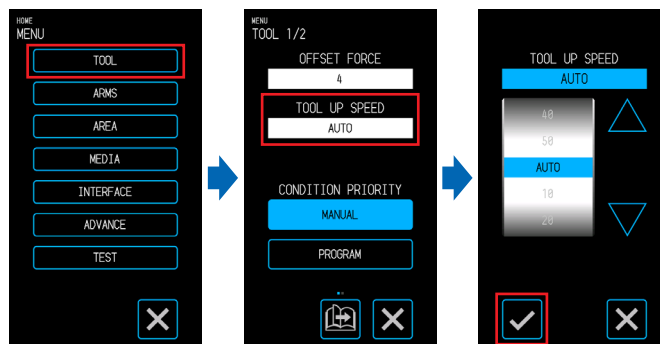

5.4 Cutting Thick Media

Configure settings for when cutting cutting thick media.

- Media having a total thickness of 0.3 mm or more (inclusive of the carrier sheet) cannot be cut.

Once you are done with the settings, touch the **X** (Exit) to return to the "HOME" screen.

What is the Tangential Mode?

The tangential mode is a function used to cleanly cut the corners when working with thick media. When cutting the media, it is necessary for the blade tip to always be facing the direction in which the tool is traveling. With this device, the blade tip is controlled to automatically face the direction in which the tool is traveling even when cutting curves and corners.

When cutting corners in thick media, the cutting becomes more difficult as it is harder for the blade to rotate in the direction in which the tool is traveling. With the tangential mode, the tool is lifted upon creating an excessive cut at each corner (up to the overcut ending point). The tool is also lowered before the cutting line for the next straight line to create an excessive cut (from the overcut starting point) before proceeding to cut the original cutting line.

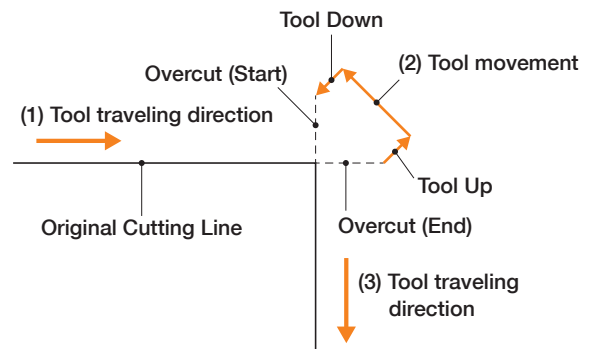

Setting the Tangential Mode

The tangential mode consists of two modes.

Mode 1: Overcuts the starting and ending positions of cutting lines as well as corners having a sharp angle. The blade tip is controlled when the blade needs to largely rotate so the cuts can be made without being affected by the hardness or thickness of the media.

Mode 2: Overcuts only the starting and ending positions of cutting lines. As the blade tip is only controlled at cut starting positions, the cutting time will be shorter compared to Mode 1.

Configurable values: OFF, 1, 2

1. Touch the **⚙** (CONDITION) on the "HOME" screen to open the CONDITION NO. setting screen.

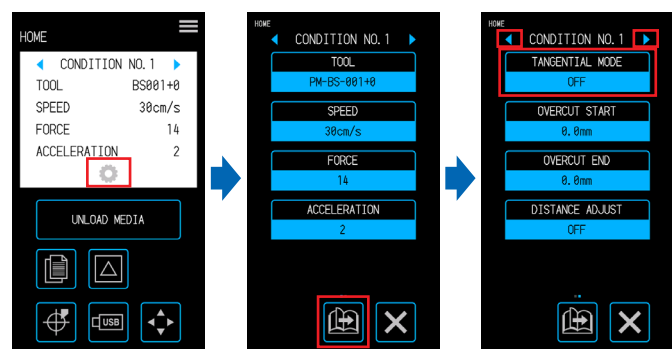

2. Select the CONDITION NO. to set by using the "◀" and "▶" and touch the "TANGENTIAL MODE".

3. Select a setting value.

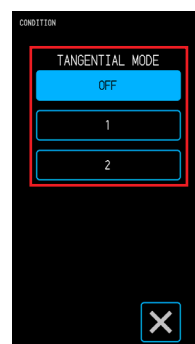

Setting the Overcuts

Set the lengths of the overcuts created when using the tangential mode.

An overcut length can be set for each the start and end of the lines.

Configurable range: 0.0 - 0.9 (mm)

1. Touch the  (CONDITION) on the "HOME" screen to open the CONDITION NO. setting screen.

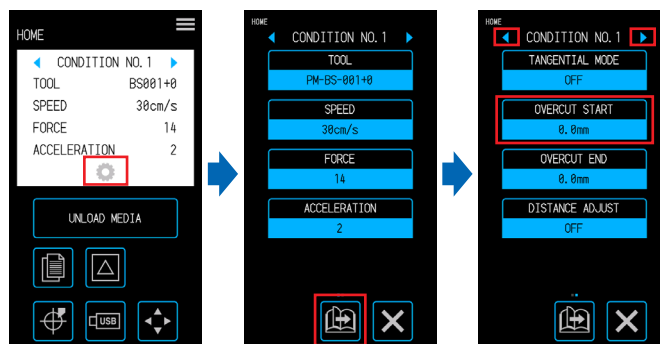

2. Select the CONDITION NO. to set by using the "◀" and "▶" and touch the "OVERCUT START".

3. Use the "△" and "▽" to select the setting value and confirm the selection with the  (Confirm).

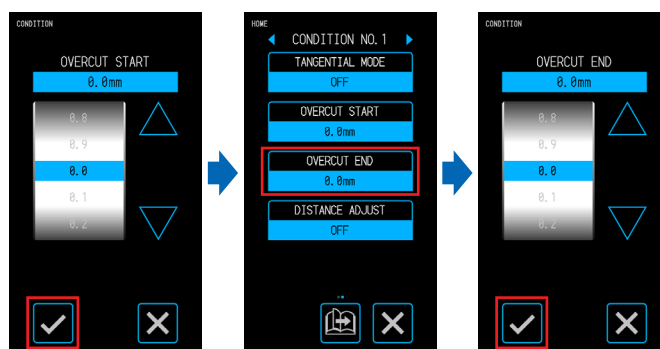

4. Touch the "OVERCUT END".

5. Use the "△" and "▽" to select the setting value and confirm the selection with the  (Confirm).

5.5 Performing Cut Tests

Confirm the quality of the cut with the setting values of the CONDITION NO. (cutting condition) by looking at how nicely the media has been cut and the rounding of corners.

- 1 PIECE: One "▲" mark (test pattern) will be cut using the setting values of the currently displayed CONDITION NO.
- 3 PIECES: Three "▲" marks (test patterns) will be cut using the setting values of the currently displayed CONDITION NO. as well as a cutting force or cutter offset value that is one less than or higher than the setting values.

Cutting 1 Test with the Setting Values

1. Set the same media and tool as the actual cut.

2. On the "HOME" screen, use the "◀" and "▶" to select the CONDITION NO. to perform the cut test with and touch the  (CUT TEST) to open the setting screen.

3. Select the "1 PIECES" for the cut test. Use the "▲", "▼", "◀" and "▶" to move the tool to the cut starting position and touch the  (OK) to cut one "▲" mark.

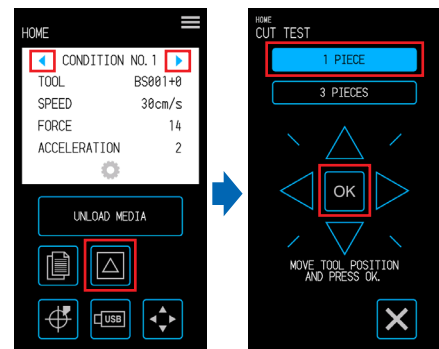



CAUTION

When the "OK" is touched, the media and tool carriage will start moving. Be careful to avoid contact with your body or any object.

Cutting 3 Tests to include Setting Values ± 1

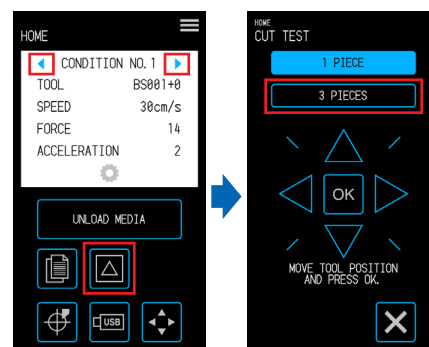
1. Set the same media and tool as the actual cut.
2. On the "HOME" screen, use the " \blacktriangleleft " and " \blacktriangleright " to select the CONDITION NO. to perform the cut test with and touch the  (CUT TEST) to open the setting screen.
3. Select the "3 PIECES" for the cut test.



4. Select the item ("FORCE" or "CUTTER OFFSET") you wish to confirm.
5. Use the " \blacktriangle ", " \blacktriangledown ", " \blacktriangleleft " and " \blacktriangleright " to move the tool to the cut starting position and touch the  (OK) to cut three "" marks.

CAUTION

When the "OK" is touched, the media and tool carriage will start moving. Be careful to avoid contact with your body or any object.

Cutting Order \rightarrow

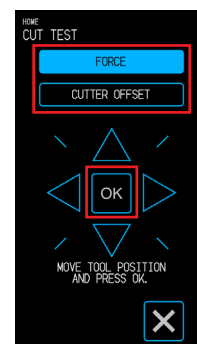
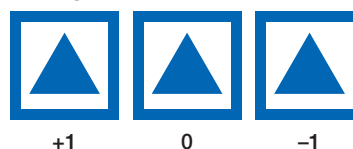

The cut test patterns will be created using setting values increased/decreased in the cutting order shown on the right.

Confirming the Cut Test

Confirm the results of the cut test and adjust various settings so that the settings are optimal. Repeat the process of performing cut tests and adjusting settings until settings for an excellent cut are established.

Adjusting the Offset Value

Confirm the corners of the triangle and square. If the corners are being cut excessively or not being cut properly, adjust the offset value.



The correction amount is insufficient. Increase the offset value.



The offset value is appropriate.



The correction is excessive. Lower the offset value.

Adjusting for Kiss Cuts

Peel off the triangle and make adjustments so that a light trace of the cut is left on the backing. If the backing has been cut all the way through, either the cutting force is too high or the blade depth is excessive. If there are parts where a trace of the cut is not left on the backing, either the cutting force is too low or the blade depth is insufficient.

Adjusting for Full Cuts

Make adjustments so that the media is cut all the way through. If the media is not cut all the way through, either the cutting force is too low or the blade depth is insufficient. Be sure to use the carrier sheet when creating full cuts.

Adjusting for Use of the Drawing Pen

Adjust the pen force so that the plot is not blurred. However, as increasing the pen force will shorten the life of the pen, lower the pen force yet only to a degree where the plot does not become blurred.

5.6 Registration Mark Scan Settings

Setting the Scan Mode

Select the scan mode for the sensors to use in order to scan the registration marks. Select a mode according to the media being used.

Once you are done with the setting, touch the  (Exit) to return to the "HOME" screen.

MODE 1: Select this mode when using common media with a white base.

MODE 2: Select this mode when using colored or glossy media.

MODE 3: Use this mode when using special materials and the registration marks cannot be scanned with either MODE 1 or MODE 2.

Use the "MEDIA CHECK" function to serve as a reference when selecting the scan mode.

Also set the registration mark adjustment values as necessary. The registration mark adjustment values can be set using "+" and "-".

When using MODE 1, decide the setting based on the darkness of the registration mark lines. Set "+" for dark registration mark lines and "-" for light registration mark lines.

When using MODE 2 or MODE 3, decide the setting based on the contrast between the base and the registration mark lines. Set "+" when the contrast is large and "-" when the contrast is small.

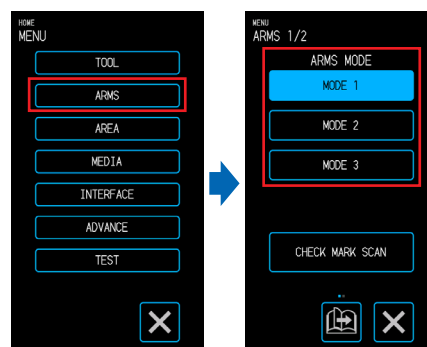

1. From the "MENU" screen, open the "ARMS 1/2" screen.



2. Under "ARMS MODE", touch the corresponding to the mode you wish to select.

3. To adjust the registration mark adjustment value, touch the "ADJUST LEVEL".

If there is no need to make changes, touch the  (Exit).

4. Use the "" and "" to select the setting value and confirm the selection with the  (Confirm).

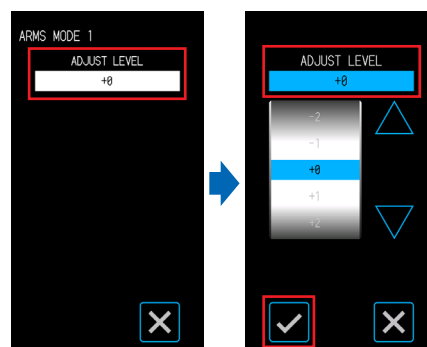

Confirming Registration

Detect the state of the media being used and display the recommended conditions for such as the scan mode, registration mark color, and registration mark base color to select. Once you are done with the setting, touch the **X** (Exit) to return to the "HOME" screen.

Confirming the Media

The appropriate registration mark scanning conditions are calculated based on the state of the media and then displayed.

1. Load media that is the same as the media that will actually be cut but has not yet been printed on.

2. From the "MENU" screen, open the "ARMS 1/2" screen.

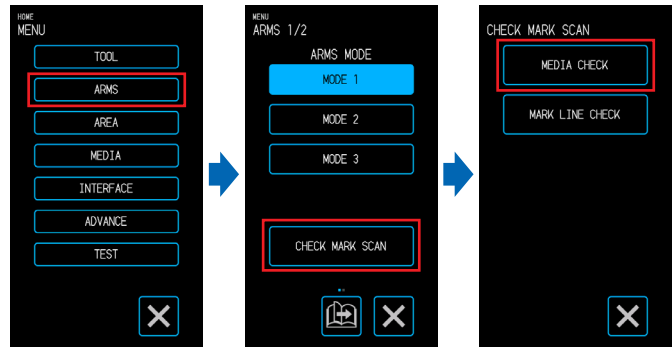

3. Touch the "CHECK MARK SCAN".

4. Touch the "MEDIA CHECK".

5. Use the " \triangle ", " ∇ ", " \triangleleft " and " \triangleright " to move the tool carriage to the scan starting position (any position in the top left corner) and touch the (OK).

6. The tool carriage will move and automatically detect the state of the media.

With the scan starting position as a reference, the sensor will move 50 mm along the Y-axis and 50 mm along the X-axis to detect the state of the media.

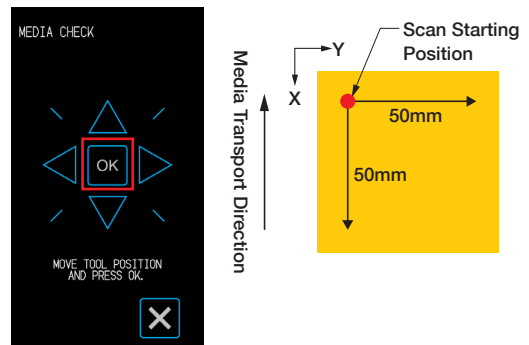

7. The appropriate registration mark color will be calculated based on the state of the media and then displayed on the screen.

ARMS MODE: The recommended scan mode of MODE 1/2/3 will be displayed.

ADJUST LEVEL: The recommended registration mark adjustment value will be displayed.

MARK LINE COLOR: The recommended registration mark color will be displayed.

BASE PAINT COLOR: The recommended base color for the registration marks will be displayed.

"BASE PAINT COLOR" may not be displayed depending on the results of the scan.

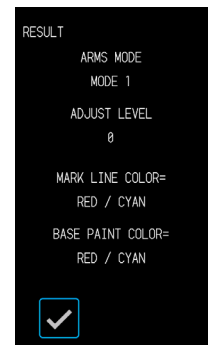

Confirming the Registration Marks

Actually detect the registration marks to confirm operation of registration mark detection.

1. Load the media on which the registration marks have been drawn.

2. From the "MENU" screen, open the "ARMS 1/2" screen.

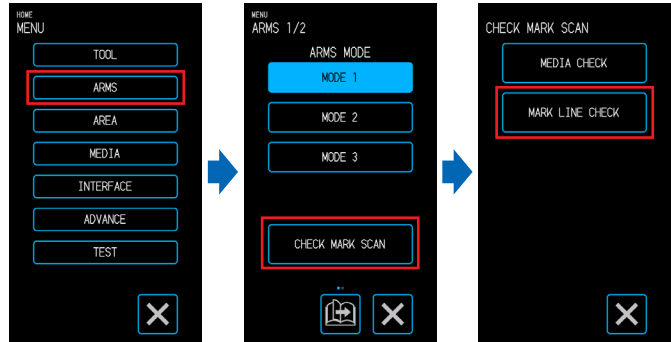

3. Touch the "CHECK MARK SCAN".

4. Touch the "MARK LINE CHECK".

5. Select the type of registration marks to scan, use the " \triangle ", " ∇ ", " \triangleleft " and " \triangleright " to move the tool carriage to the scan starting position (the position of the red circle in the image to the right) and touch the **OK** (OK).

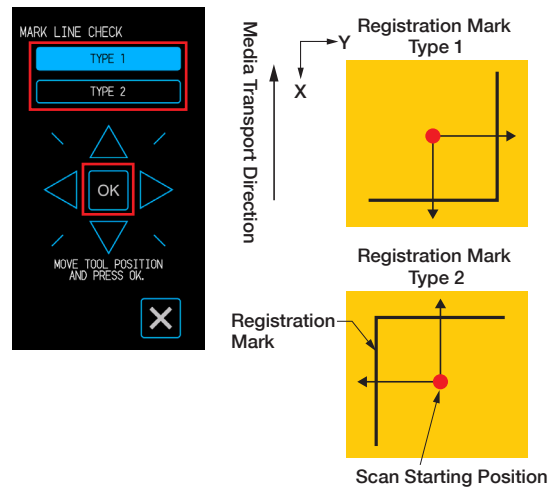

6. The tool carriage will move and automatically detect the registration marks.

7. The result of the scan will be displayed on the screen.
 MARK SCAN MODE: The currently set scan mode will be displayed.
 RESULT: The scan result (OK/NG) will be displayed.

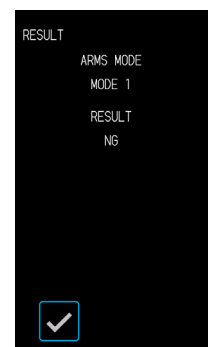

It may not be possible to detect the registration marks depending on the state of the base. In such case, run the "MEDIA CHECK" function and try again with the recommended conditions.

Correcting the Registration Mark Position

The sensor that scans the registration marks is located in a position that is away from the tip of the blade tool. For this reason, it is necessary to make a correction so that the position actually being cut matches the coordinates at which the registration marks were scanned.

If a registration mark has already been drawn on the media, scan that registration mark, draw another registration mark in the same position, and then measure the volume of displacement between the two registration marks. This volume of displacement will be used as the correction value.

If a registration mark has not been drawn on the media, plot a registration mark and scan this, and then draw a registration mark again to measure the volume of displacement between the two registration marks. This volume of displacement will be used as the correction value.

The accuracy of correction will increase when using media and the tool that are actually going to be used.

Once you are done with the setting, touch the **X** (Exit) to return to the "HOME" screen.

Scanning the Printed Registration Mark for Correction and Entering the Correction Value

Scan the registration drawn on the media and make a correction by using the displacement between the scanned position and the plotted position.

1. Load media on which a registration mark for correction (a 40 mm cross with a line thickness of 0.4 mm) has been drawn.

2. From the "MENU" screen, open the "ARMS 1/2" screen and proceed to the "ARMS 2/2" screen.

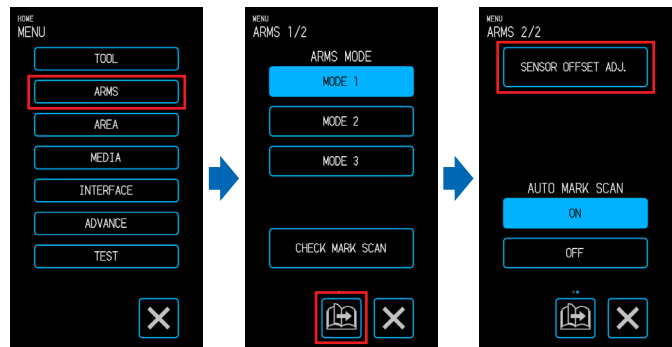

3. Touch the "SENSOR OFFSET ADJ.".

4. Touch the "SCAN".

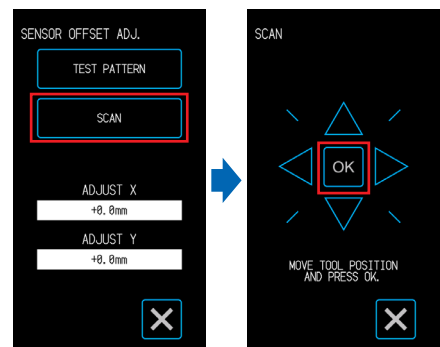

5. Use the " \triangle ", " ∇ ", " \triangleleft " and " \triangleright " to move the tool to the registration mark scan starting area and touch the **OK** (OK).

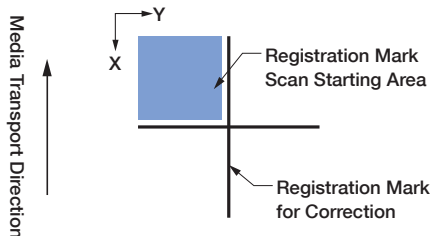

Scan the registration mark and then plot a registration mark to use for comparison.

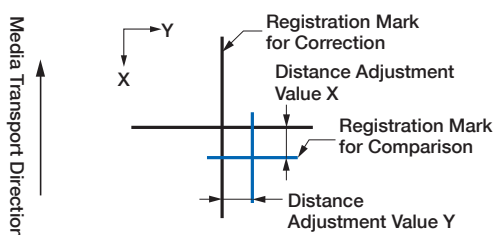

CAUTION
When the "OK" is touched, the media and pen carriage will start moving. Be careful to avoid contact with your body or any object.

6. Measure by how much the registration mark for comparison is displaced from the registration mark for correction.

Measure the distance between the center of each line.

In the case of the image on the bottom in Step 5, the correction needs to be made in the negative direction for both X and Y so the correction values for each will be a negative value.

7. Touch the "ADJUST X".

8. Input the value of X measured in Step 5.

Use the " \triangle " and " ∇ " to select the setting value and confirm the selection with the (Confirm).

9. Similarly input "ADJUST Y".

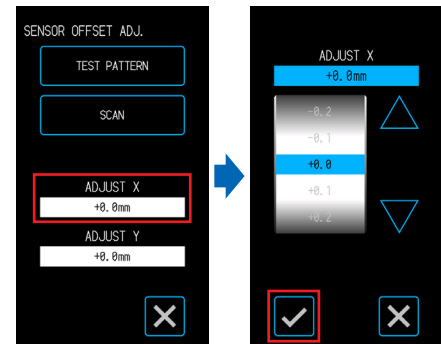

Adjusting after Cutting the Test Pattern (Registration Mark for Correction)

Plot a registration mark for adjustment of the registration mark position and make the adjustment using this registration mark.

1. Load white media for cutting.

2. Set a drawing pen in the tool holder and select a CONDITION NO.

3. From the "MENU" screen, open the "ARMS 2/2" screen.

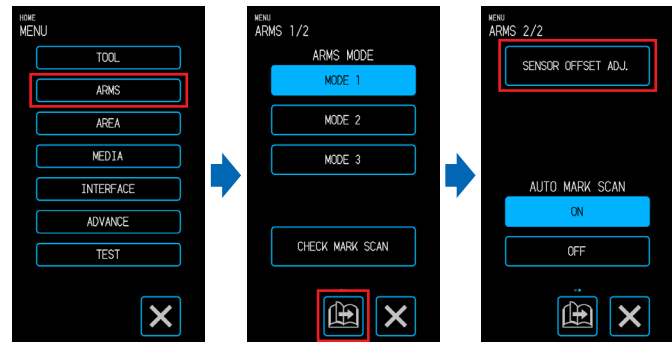

4. Touch the "SENSOR OFFSET ADJ.".

5. Touch the "TEST PATTERN".

6. Move to the registration mark cutting position by using the " \triangle " " ∇ " " \triangleleft " and " \triangleright ". When the (OK) is touched, the registration mark for correction will be plotted.

CAUTION

When the "OK" is touched, the media and pen carriage will start moving. Be careful to avoid contact with your body or any object.

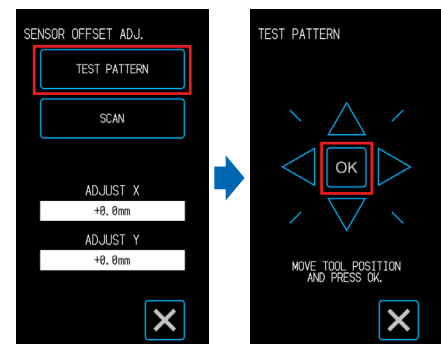

7. Touch the "SCAN".

8. Use the " \triangle ", " ∇ ", " \triangleleft " and " \triangleright " to move the tool to the registration mark scan starting area and touch the **OK** (OK).

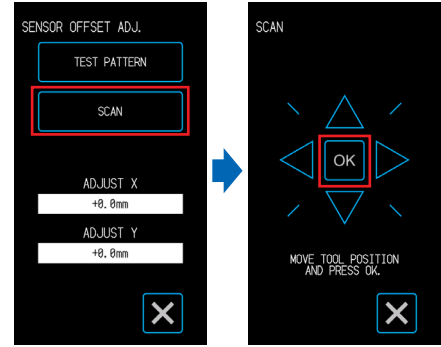
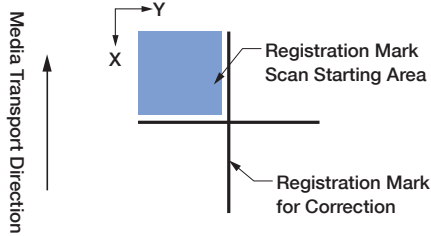

Scan the registration mark and then plot a registration mark to use for comparison.

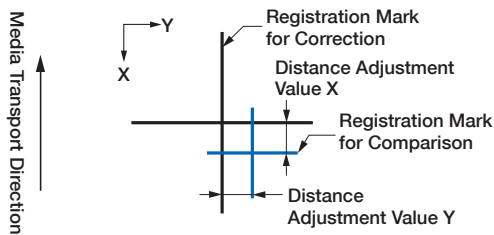

CAUTION
When the "OK" is touched, the media and pen carriage will start moving. Be careful to avoid contact with your body or any object.

9. Measure by how much the registration mark for comparison is displaced from the registration mark for correction.

Measure the distance between the center of each line.

In the case of the image on the bottom in Step 8, the correction needs to be made in the negative direction for both X and Y so the correction values for each will be a negative value.

10. Touch the "ADJUST X".

11. Input the value of X measured in Step 8. Use the " \triangle " and " ∇ " to select the setting value and confirm the selection with the **✓** (Confirm).

12. Similarly input "ADJUST Y".

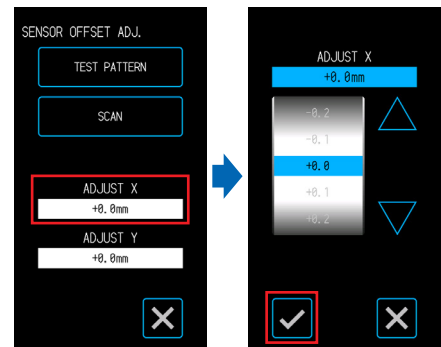

Setting Automatic Registration Mark Position Detection

When the position of the tool is close to the registration mark scan starting area while in a state where "AUTO MARK SCAN" is set to "ON", the registration mark positions will be automatically searched when starting automatic scanning of the registration marks.

If the current position of the tool is far away from the registration mark scan starting area, the search may take time or the process may even end in an error due to not being able to find the registration marks.

The above operation will not be performed when this item is set to "OFF".

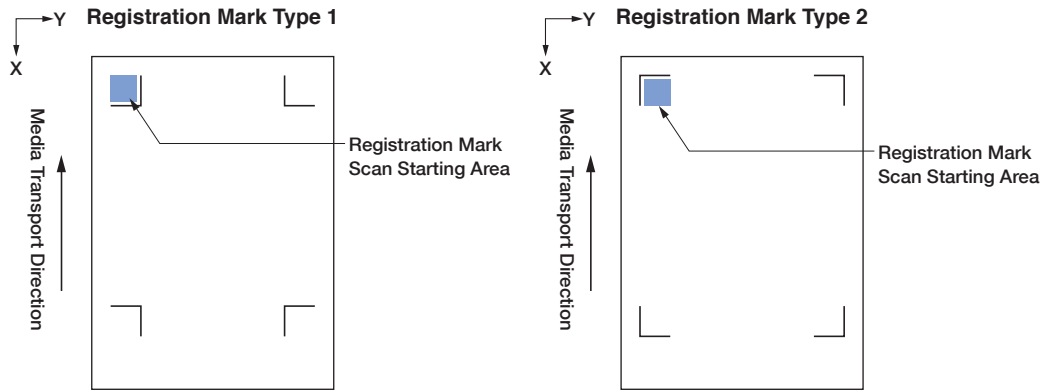

1. From the "MENU" screen, open the "ARMS 1/2" screen and proceed to the "ARMS 2/2" screen.

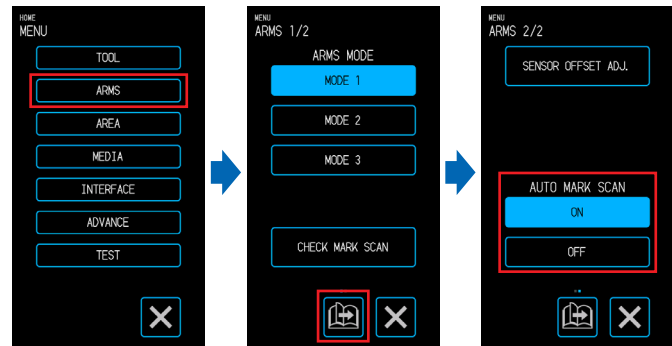

2. Select "ON" or "OFF" for "AUTO MARK SCAN".

5.7 Adjusting the Media Operation

Set items related to the operation of the media.

Once you are done with the settings, touch the **X** (Exit) to return to the "HOME" screen.

Setting the Pre Feed Operation

Set the operation for preventing displacement of the media by first transporting the media by a set amount and placing traces of the rollers on the media.

When feeding long media, breaking in the media to the environment removes expanded or contracted areas and enables the media to be fed in a stable manner.

Setting values: 10 - 300 (cm)

1. From the "MENU" screen, open the "MEDIA 1/3" screen.
2. Touch the "PRE FEED".
3. Input the distance by which to perform the pre feed operation.
When the **✓** (Execute) is touched, the media will be discharged the pre feed operation for the set distance will begin.

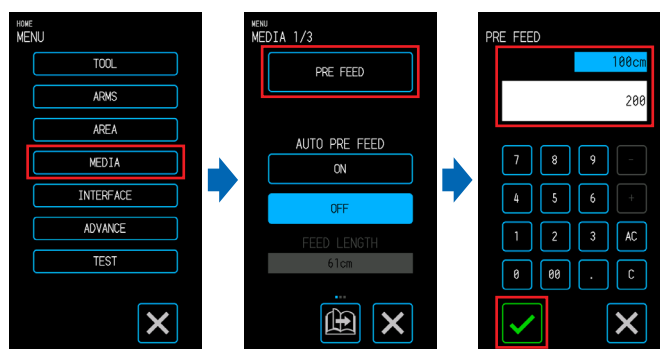

⚠ CAUTION

When the "Execute" is touched, the media and tool carriage will start moving.
Be careful to avoid contact with your body or any object.

Setting the Auto Pre Feed

Set the operation for preventing displacement of the media by first transporting the media by a set amount and placing traces of the rollers on the media.

When feeding long media, breaking in the media to the environment removes expanded or contracted areas and enables the media to be fed in a stable manner.

Setting values: 10 - 300 (cm)

1. From the "MENU" screen, open the "MEDIA 1/3" screen.

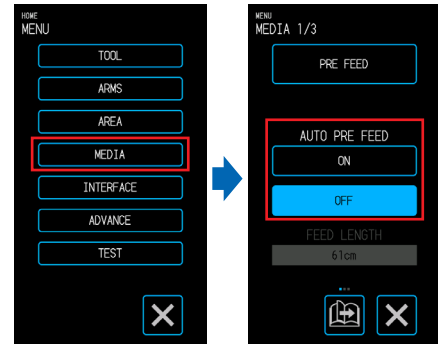

2. Select "ON" or "OFF" for "AUTO PRE FEED".
When "ON" is selected, it will be possible to input a value in the "FEED LENGTH".

3. Touch the "FEED LENGTH".

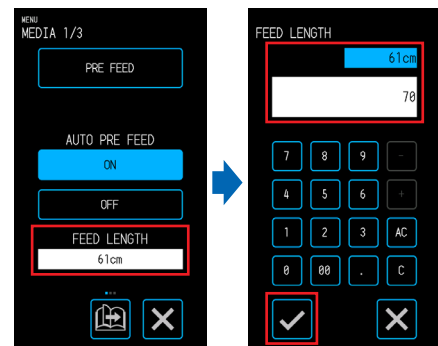

4. Input the distance by which to feed the media and confirm the input with the (Confirm).

Setting the Initial Feed

A setting can be made to automatically feed and then return the media by the length of a page when the media is loaded. This setting has the effect of automatically performing the "pre feed operation" for preventing displacement of the media.

For details on the setting for the "PAGE LENGTH", refer to "Setting the Page Length" under "4.1 Cutting Roll Media".

1. From the "MENU" screen, select "MEDIA 1/3" and proceed to the "MEDIA 2/3" screen

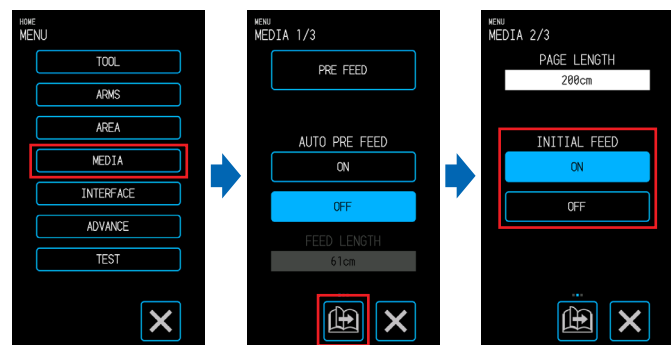

2. Select "ON" or "OFF" for "INITIAL FEED".

Setting the Media Width Detection

This device uses the width detection sensor to detect the leading edge/ width/ position of the media. Depending on the type of media (especially with high transparency), the media cannot be set correctly because of the detection error for the leading edge/ width/ position of the media. In such a case, use a carrier sheet or disable media width detection according to the following procedures. Remove the media before setting the media width detection. It cannot be set correctly when media is loaded.

1. From the "MENU" screen, select "MEDIA 1/3" and proceed to the "MEDIA 3/3" screen.

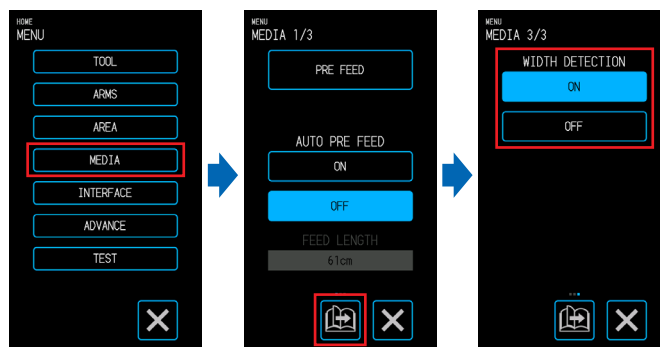

2. Select "ON" or "OFF" for "WIDTH DETECTION".

3. Depending on the setting, the display on the "LOAD MEDIA" screen on the "HOME" screen will change. When set to "ON", select the shape of the media. When set to "OFF", select the size of the media. The media size is treated as "A3" if "A4/A3/B4/8"/11"" is selected. The media size is treated as "A2" if "A3+/A2/B3/12"/15"" is selected. The media size is treated as "20"" if "B2/17"/20"" is selected.

⚠ CAUTION

When setting it to "OFF", do not cut the data exceeding the set media size. The device cuts the outside of the media, so that the cutter pen and the cutting mat may be damaged.

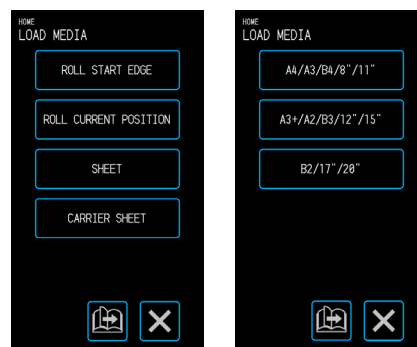

When "ON" is selected

When "OFF" is selected

<Note>

This setting can also be specified on the "LOAD MEDIA" screen.

1. Touch the "LOAD MEDIA" on the "HOME" screen.

2. Touch the "📄" (Page) to display the "WIDTH DETECTION" screen.



3. Select "ON" or "OFF" for "WIDTH DETECTION".

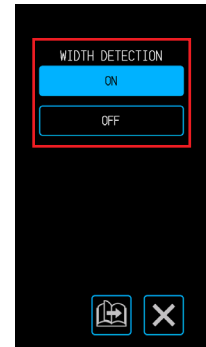

5.8 Setting Commands

There are two types of commands handled by this device. These are GP-GL and HP-GL. Match this with the setting value of the software being used or set this to AUTO. However, depending on the application being used, the device may not operate properly with the AUTO setting.

These items are available only when using the GP-GL or HP-GL commands.

Once you are done with the setting, touch the  (Exit) to return to the "HOME" screen.

Selecting the Command

Select the command to use.

1. From the "MENU" screen, open the "INTERFACE 1/3" screen.

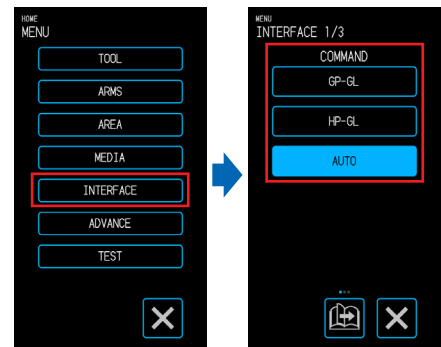

2. Select the command to use.

Setting the HP-GL Origin Point

This item is available only when using the HP-GL command.

1. From the "MENU" screen, open the "INTERFACE 1/3" screen and proceed to the "INTERFACE 2/3" screen.

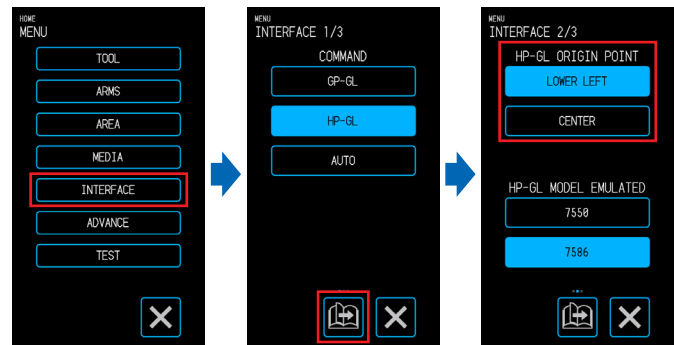

2. Under "HP-GL ORIGIN POINT", select "LOWER LEFT" or "CENTER".

Setting the HP-GL Model Emulated

This item is available only when using the HP-GL command.

1. From the "MENU" screen, open the "INTERFACE 1/3" screen and proceed to the "INTERFACE 2/3" screen.

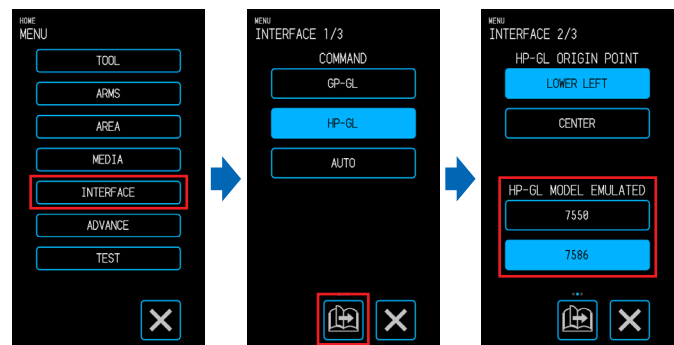

2. Under "HP-GL MODEL EMULATED", select "7550" or "7586".

Setting the GP-GL Step Size

The distance that the tool moves by for a single step of the command can be changed. If the setting values do not match, the size of the cutting may become irregular. Match this with the setting value of the software being used.

This item is available only when using the GP-GL command.

1. From the "MENU" screen, open the "INTERFACE 1/3" screen and proceed to the "INTERFACE 3/3" screen.

2. Under "GP-GL STEP SIZE", select "0.100 mm", "0.050 mm", "0.025 mm", or "0.010 mm".

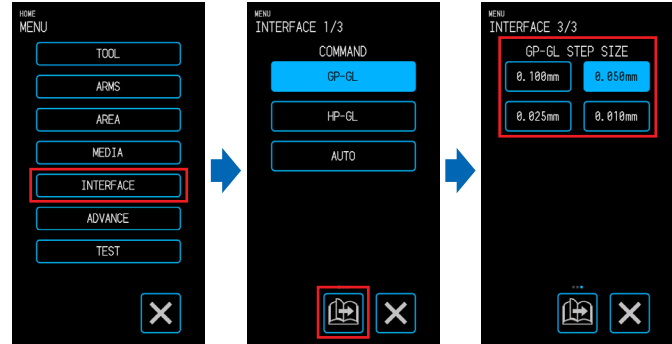

5.9 Setting the Operation Panel

Perform advanced settings for the operation panel.

Once you are done with the setting, touch the **X** (Exit) to return to the "HOME" screen.

Language Selection

Set the language that will be displayed in the operation panel.

1. From the "MENU" screen, open the "ADVANCE 1/3" screen.
2. Touch the input box for "LANGUAGE SELECTION".
3. Select the language to use and confirm the selection with the **✓** (Confirm).

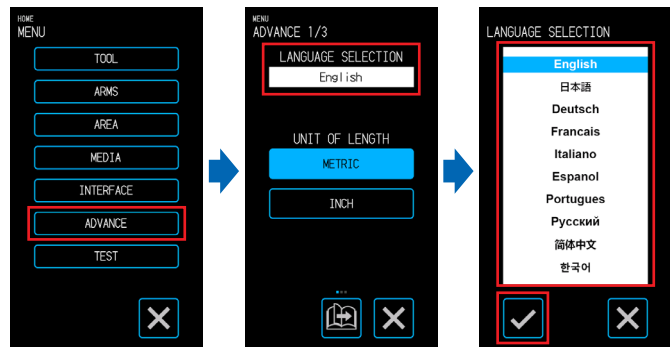

Selection of Unit for Lengths

Set the unit for lengths that will be displayed in the operation panel.

1. From the "MENU" screen, open the "ADVANCE 1/3" screen.
2. Under "UNIT OF LENGTH", select "METRIC" or "INCH".

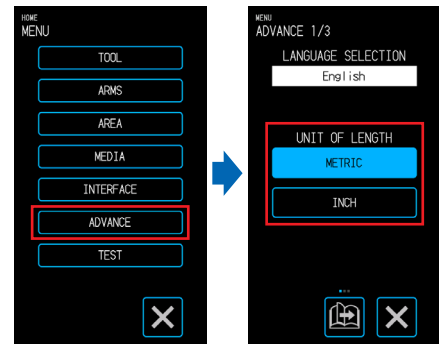

Setting the Beep for Key Operation

Set whether to sound a buzzer each time the keys on the operation panel are touched.

1. From the "MENU" screen, open the "ADVANCE 1/3" screen and proceed to the "ADVANCE 2/3" screen.
2. Select "ON" or "OFF" for "BEEP FOR KEY OPE.".

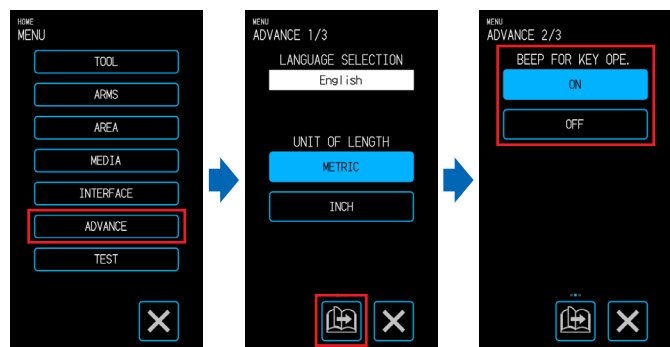

Chapter 6 Troubleshooting

Refer to this chapter when operation seems irregular or you are having trouble with the device. This chapter also explains how to confirm the settings of the device and cutting data as well as how to plot the test pattern.

- 6.1 Responding to Trouble
- 6.2 Confirming Error Messages
- 6.3 Confirming the Operation of the Main Unit
- 6.4 Confirming the Main Unit Firmware Version
- 6.5 How to Replace the Cutting Mat

6.1 Responding to Trouble

When the device does not operate even when the power is turned ON

Symptom	Possible Cause	Solution
There is nothing displayed on the LCD panel.	Power is not being supplied. Otherwise, the device may be broken.	Confirm that the power cable is properly plugged in to the connector on the device and an AC outlet. Confirm that power is coming to the AC outlet.
	The device is broken.	Contact your sales representative or nearest Graphtec dealer if the problem still exists.

Operation is Irregular

Symptom	Possible Cause	Solution
The device could not recognize the media.	The device may have been exposed to the intense light.	If direct sunlight is coming in from a nearby window, block the light. If a fluorescent lamp stand is located nearby, move this away from the device.
	The transparent media has been loaded.	Disable Media width detection. For the details, please refer to the User's Manual 5.7.
	There may be a problem with the Width detection sensor.	Adjust the Width detection sensor. For the details, please refer to the User's Manual 6.3.
	There may be a problem with the device.	Contact your sales representative or nearest Graphtec dealer if the problem still exists.
The media swerves.	The push rollers are not set properly.	Confirm the positions of the push rollers.
One of the push rollers does not stay on top of the media.	The front side or the rear side of the media is not cut straight in relation to the media.	Cut the edge of the media straight.

6.2 Confirming Error Messages

GP-GL Command Errors

Error No.	Displayed	Solution
E02001	An order that cannot be recognized was forwarded.	Touch the <input checked="" type="checkbox"/> (Confirm).
	Noise was input when the computer was turned ON.	In the menu of the software, perform settings for operating the device.
	The setting for the device the software will output to has changed.	Fix the setting of the software interface.
	The settings on the plotter's interface have changed.	Fix the settings on the plotter's interface.
E02004	A numerical parameter of a command has exceeded the acceptable range.	In the menu of the software, perform settings for operating the device.
	The setting for the device the software will output to has changed.	Fix the setting of the software interface.
	The settings on the plotter's interface have changed.	Fix the settings on the plotter's interface.
E02005	An error related to receipt of data has occurred within the interface.	In the menu of the software, perform settings for operating the device.
	The setting for the device the software will output to has changed.	Fix the setting of the software interface.
	The settings on the plotter's interface have changed.	Fix the settings on the plotter's interface.
E02006	Data that exceeds the cutting area has been received.	Confirm the data.
		Confirm the size and cutting area of the media.
		Confirm the settings for the scale.
		Confirm the settings for the size of steps.

HP-GL Command Errors

When an HP-GL command error is displayed, the cause of such in most cases is one of the two reasons listed below.

- The setting for the model the application software will output to has changed.
- The settings on the interface of the device have changed.

If one of these reasons has caused the error, take the measures listed below to resolve the problem.

- Fix the setting for the model the application software will output to.
- Fix the settings on the interface of the device.

Error No.	Displayed	Solution
E03001 Error 1	An order that cannot be recognized was executed.	Execute a command that can be used.
E03002 Error 2	The value of a parameter was incorrectly specified.	Execute the command with a proper value for the parameter.
E03003 Error 3	A parameter that cannot be used was executed.	Execute a parameter that can be used.
E03005 Error 5	A character set that cannot be used was specified.	Specify a character set that can be used.
E03006 Error 6	The coordinates of a command have been specified outside of the cutting area.	Execute the command with coordinates within the cutting area.
E03007 Error 7	An overflow of the buffer memory has occurred while processing the downloadable character buffer or polygon buffer, etc.	Adjust the buffer size.
E03010 Error 10	While executing an output order, another output order was executed.	Check the program.

Error No.	Displayed	Solution
E03011 Error 11	An invalid byte was received following an ESC code.	Check the program.
E03012 Error 12	An invalid byte was received amongst device control orders.	Check the program.
E03013 Error 13	A parameter outside of the acceptable range was specified for an I/O related command.	Check the program.
E03014 Error 14	There are too many parameters for an I/O related command.	Check the program.

ARMS Errors

Error No.	Cause	Solution
E04001	The tilt set with axis alignment is too large.	Reload the media.
E04002	The configurable range for distance adjustment has been exceeded.	Set a smaller distance adjustment value.
E04003	Sensor level adjustment failed.	That particular media cannot be used.
E04004	The configurable range for distance adjustment has been exceeded.	Set a smaller distance adjustment value.
E04005	Registration marks could not be scanned.	Confirm the registration mark scanning positions.
E04006	The data volume exceeded the I/O buffer with segment area registration marks.	Reduce the amount of data.
E04007	The test pattern cutting position is not fully contained in the cutting area with sensor position adjustment.	Plot the test pattern upon moving the media more towards the center.
E04008	The end of the media was scanned while scanning the registration marks.	Confirm the media.
		Review the positions where the registration marks are printed.
E04009 to E04017	The search range was exceeded while scanning the registration marks.	Confirm the media.
		Review the positions where the registration marks are printed.
E04018	The media set lever was raised.	Reload the media and try again.
E04019	The cancel operation was performed by the user.	Redo the process.
E04020	There is an error with the scan setting values.	Review the setting values.
E04021	Registration marks could not be found within the automatic scanning range.	Confirm the media.
		Review the positions where the registration marks are printed.
E04022	The cancel operation was performed by the user.	Redo the process.
E04023 to E04025	Registration marks could not be scanned.	Readjust the sensor levels.
		Change the color used to print the registration marks.
		Confirm the media.
		Review the positions where the registration marks are printed.

Other Error Displays

Error No.	Cause	Solution
E01001 to E01015	Failure of the device.	Contact the store of purchase or our company's customer service.
E05001	Data larger than the buffer size cannot be copied.	Cut the data normally without using the copy mode.
E05002	There is no data to copy.	Send data, perform normal cutting, and then use the copy mode.
E05003	The available area on the media to copy is too small.	Use a larger media.
		Confirm the copy starting position.

6.3 Confirming the Operation of the Main Unit

Plotting the Self Test Pattern

Plot the self test pattern to check the operation of the device.
Once the printing is started, the process cannot be paused or canceled midway.

1. Load media that is at least A3-sized.
2. Set a drawing pen in the tool holder and select a CONDITION NO.

3. From the "MENU" screen, open the "TEST" screen.

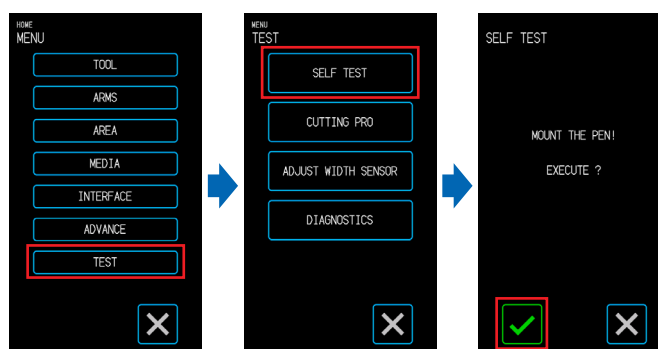

4. Touch the "SELF TEST".

5. When the  (Execute) is touched, printing of the self test pattern will start.

CAUTION

When the "Execute" is touched, the media and tool carriage will start moving. Be careful to avoid contact with your body or any object.

Plotting the Test Pattern

Plot the test pattern (a shape named CUTTING PRO) to check the operation of the device.
Once the printing is started, the process cannot be paused or canceled midway.

1. Load media that is at least A3-sized.
2. Set a drawing pen in the tool holder and select a CONDITION NO.

3. From the "MENU" screen, open the "TEST" screen.

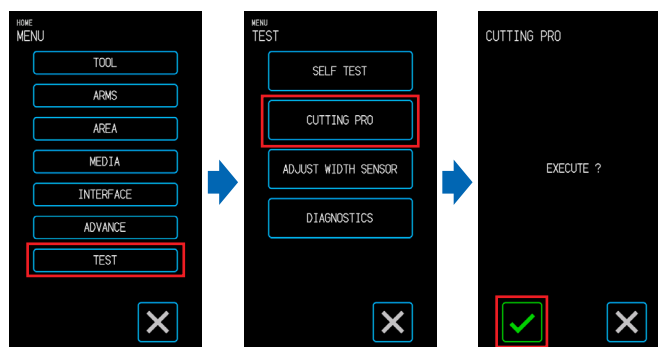

4. Touch the "CUTTING PRO".

5. When the  (Execute) is touched, printing of the test pattern will start.

CAUTION

When the "Execute" is touched, the media and tool carriage will start moving. Be careful to avoid contact with your body or any object.

Adjusting the Width Detection Sensor

This device uses the width detection sensor to detect the leading edge/ width/ position of the media.

Adjust the width detection sensor if errors related to the leading edge/ width/ position occur with media that could be loaded without any problem.

Remove the media before adjusting the width detection sensor. It cannot be adjusted correctly when media is loaded.

1. From the "MENU" screen, select "TEST" screen.

2. Select "ADJUST WIDTH SENSOR".

3. When (Execute) is touched, adjustment of width detection sensor will start.

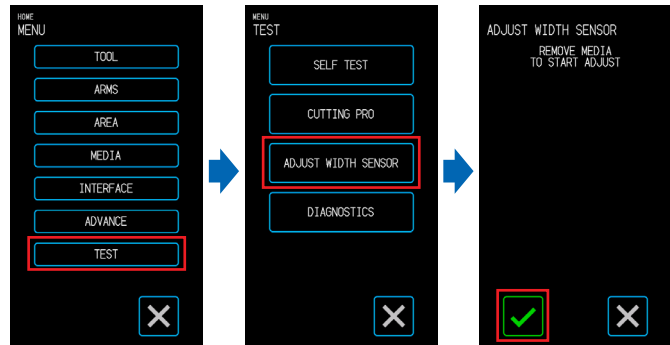

CAUTION

When the "Execute" is touched, the media and tool carriage will start moving. Be careful to avoid contact with your body or any object.

Main Unit Diagnosis Test

The operating status of the device can be checked by following instructions on the screen to operate each of the sensors and switches.

1. From the "MENU" screen, open the "TEST" screen.

2. Touch the "DIAGNOSTICS".

3. When the (Execute) is touched, messages for the test will appear on the screen.

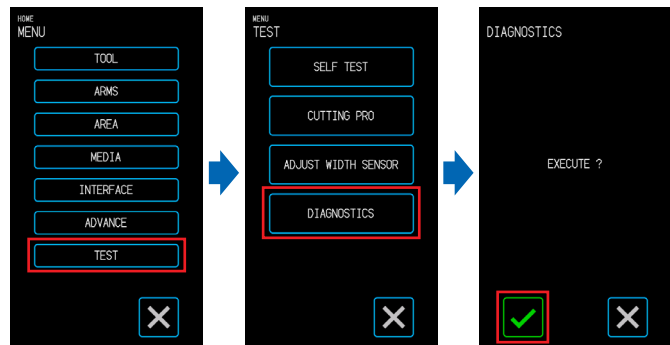

4. Operate the sensors and levers by following the instructions displayed on the screen. Touch the (Next) on the screen for each test item to proceed to the next test item. Touch the (Exit) to exit the main unit diagnosis and return to the "TEST" screen.

Test Items

"Media Sensor" – "Home Sensor" – "Raising and Lowering of the Tool" – "Intake Fan" – "Registration Mark LED" – "Media Set Levers"

The tests consist of detections of the operating status in relation to operations and visual confirmations.

For items subject to detection, "OK" will appear on the screen when detection is normal.

Once all test items have been completed, the system will return to the "TEST" screen.

6.4 Confirming the Main Unit Firmware Version

The version of the system within the device can be confirmed.
The version no. is displayed in the "ADVANCE 3/3" screen.

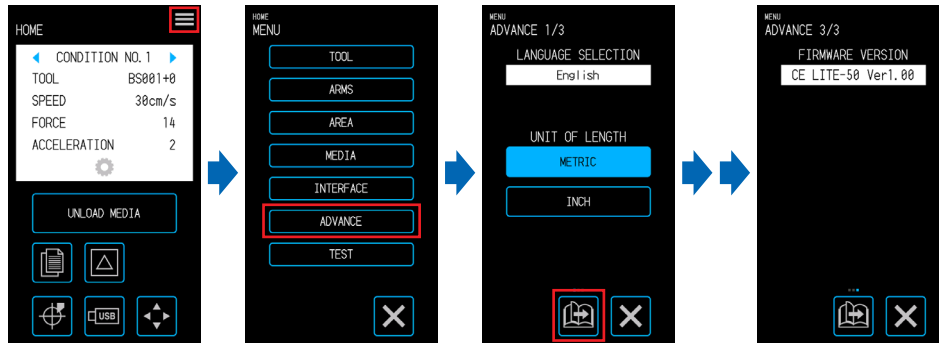

6.5 How to Replace the Cutting Mat

Check the cutting mat periodically and replace if scratched. Scratches on the cutting mat may affect the quality of cutting.

⚠ CAUTION

- Turn off the power when replacing the cutting mat.
- Be careful when replacing the cutting mat to avoid cutting your hands, etc.
- Move the tool carriage to a position allowing for ease of work.
- Install it so that there are no twists or bends. These can affect cut quality.
- Be sure that there are no foreign objects or air bubbles under the attached surface. Bumps due to foreign objects and air bubbles can affect cut quality.

1. Remove the cutting mat from the right side.

After removing the cutting mat, please make sure that there is no adhesive tape or other adhesives left on the cutting base.

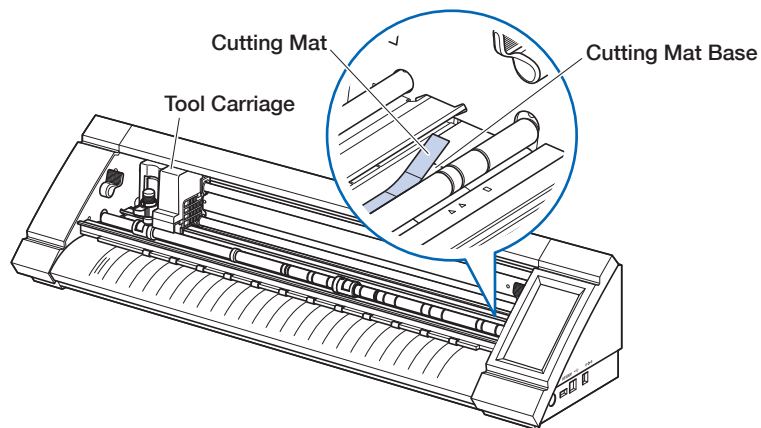

2. Paste the new cutting mat from the left side while peeling the liner little by little.

Appendix

The specifications, etc. of the device are explained in this chapter.

- A.1 Standard Specifications
- A.2 Supply Items
- A.3 Appearance Drawing
- A.4 Menu Tree
- A.5 List of Initial Values

A.1 Standard Specifications

Item		CE LITE-50
CPU		32-bit
Operating Method		Grit Rolling Method
Driving Method		Stepping Motor
Maximum Cutting Area*1		498 mm × 3 m
Precision Guaranteed Area (width × length)*1		478 mm × 1 m
Compatible Media Widths	Minimum	210 mm (A4, 8.27")
	Maximum	508 mm (20")
	Standardized*2	JIS A2/A3/A4/B3/B4, ISO A2/A3/A4/B2/B3/B4 8.5"/11"/12"/15"/17"/20", 220 mm / 320 mm / 329 mm (equivalent to A3+) / 500 mm
Number of Push Rollers		2
Maximum Cutting Speed		500 mm/s (All direction), 18 levels
Maximum Acceleration		1.0 G (9.8 m/s ²) (All direction) 2 levels
Maximum Cutting Force		2.1 N (210 gf) 26 levels
Mechanical Step Size		0.025 mm
Program Step Size		GP-GL: 0.1 / 0.05 / 0.025 / 0.01 mm, HP-GL™*4: 0.025 mm
Repetition Precision		0.1 mm or less/1 m*1
Number of Attachable Tools		1
Type of Cutter		Cemented Carbide Blade
Type of Compatible Pens		Supported with the specifically designed pen adapter*3
Compatible Media for Cutting		Marking films (PVC/fluorescence/reflective) with a thickness of 0.1 mm or less, excluding high luminance reflective films
Interface		USB 2.0 (Full Speed)
Buffer Memory Size		2 MB
Types of Commands		GP-GL / HP-GL*4 (switched with operation panel or automatically switched based on command)
LDC Display		4.3" color touch panel
Automatic Registration Mark Scanning*5		Available (equipped with ARMS7.0), 4-point correction, segment area correction, multiple registration mark correction, automatic registration mark detection, etc.
Key Features		Simple Printing & Cutting (with Media Tilt Correction), Offline Output, and Barcode Management Functions
Power Supply Rating		100 - 240 VAC dedicated adapter output, 24 VDC (2A)
Power Consumption		32 W or less
Usage Environment		10 to 35°C, 35 to 75% R.H. (no condensation)
Precision Guaranteed Environment		16 to 32°C, 35 to 70% R.H. (no condensation)
Outer Dimensions (approximate) [W × D × H]		784 × 227 × 164 mm (not including the roll media stocker)
Mass (Weight) (approximate)		8 kg (not including the roll media stocker)
Compatible OS*6		Windows 10 (Home/Pro/Enterprise/Education) Windows 8.1 (Windows 8.1/Pro/Enterprise) Windows 8 (Windows 8/Pro/Enterprise) Windows 7 (Ultimate/Enterprise/Professional/Home Premium) Mac OS X 10.6 - 10.13 (10.6 is compatible with only Graphtec Studio)
Standard Software		Graphtec Pro Studio, Graphtec Studio for Mac, Cutting Master 4, Windows Driver
Warranty Period		1 year (warranty registration is required)
Related Standards	Safety Standards	UL/cUL/CE Markings
	EMC Standards	VCCI Class A / FCC Class A / CE marking (EN55032 etc.)

*1: When using films and setting conditions specified by our company.

*2: For non-standardized sizes, use the carrier sheet.

*3: The specifically designed pen adapter (sold separately) is required. Three types of fixing screws to support different pen thicknesses are included.

Compatible pen diameters: 8.0 - 11.3 mm (there may be pens within this range that are not compatible)

*4: HP-GL™ is a registered trademark of the Hewlett-Packard Company in the United States.

*5: It may not be possible to scan registration marks depending on the color and texture of the media being used.

*6: Any OS for which support by the OS manufacturer has expired will not be applicable for support by our company either.

A.2 Supply Items

Product Name	Model No.
Cutter Set (Standard Blade)	PM-BS-001
Cutter Set (Thick Blade)	PM-BS-002
Carrier Sheet (13-inch)	PM-CM-003
Pen Adapter	PM-BH-001
Cutting Mat	PM-CR-001
Cross Cutter	PM-CC-001

A.3 Appearance Drawing

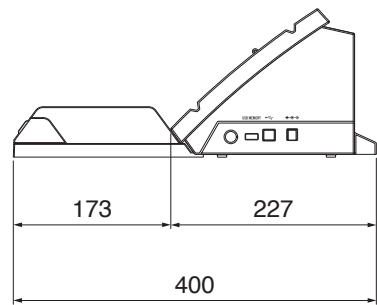
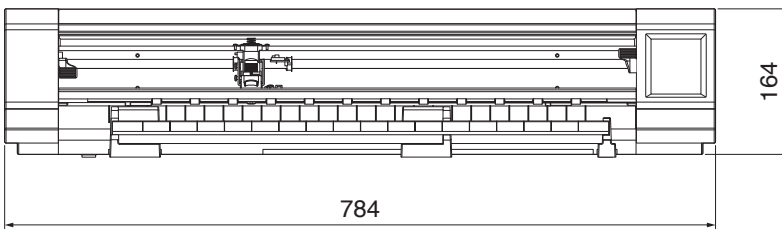
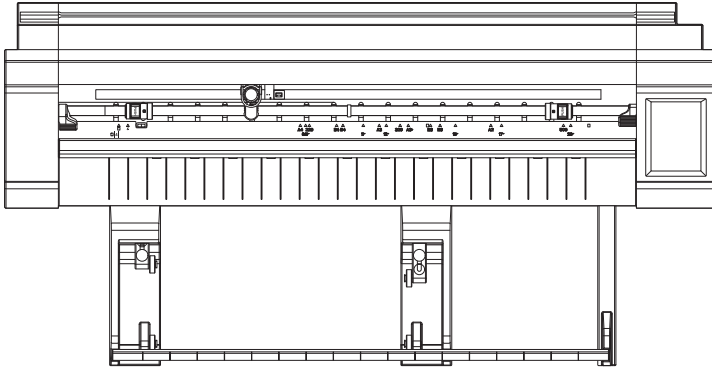

Units: mm
Dimension error: ± 5 mm

A.4 Menu Tree

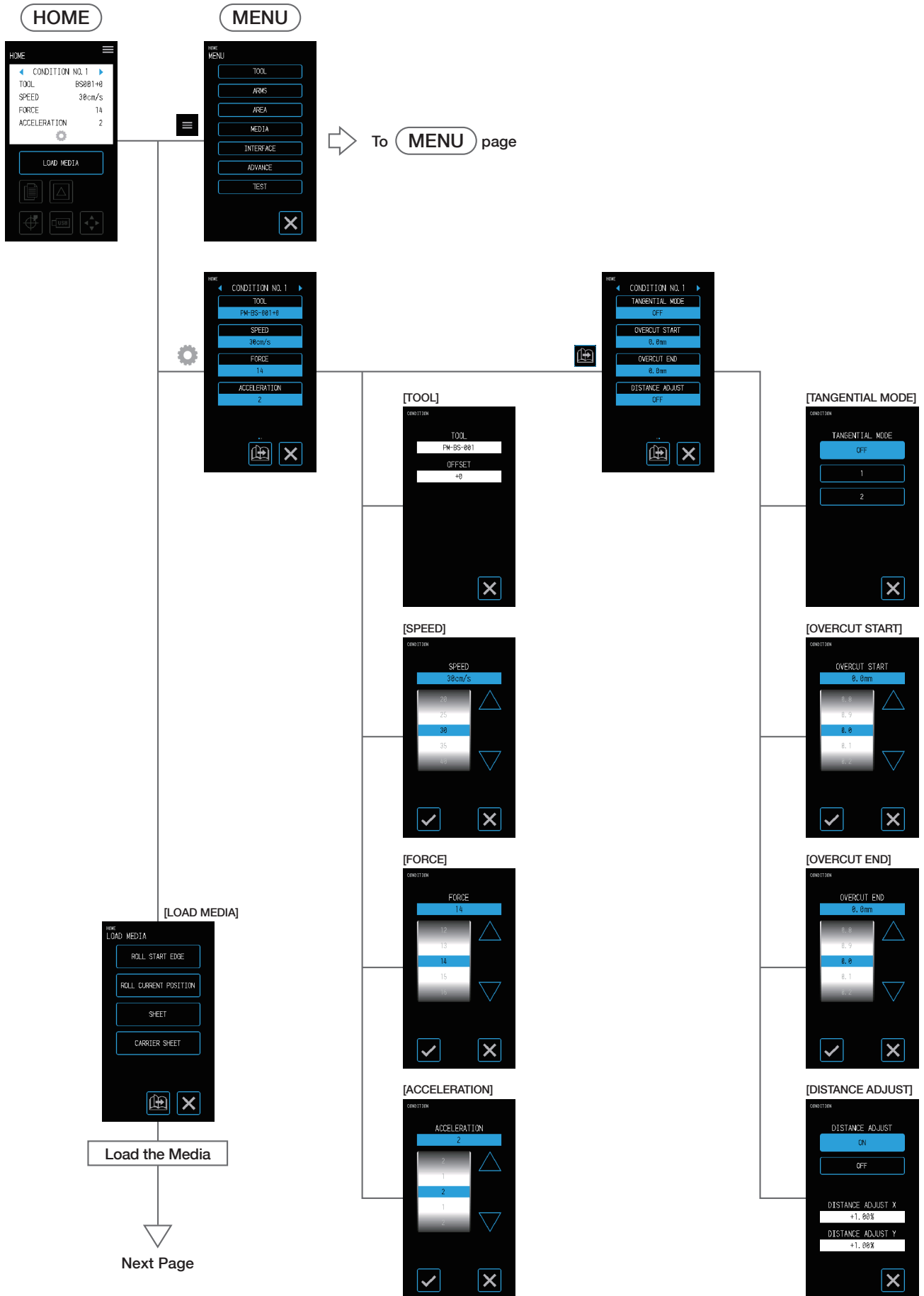

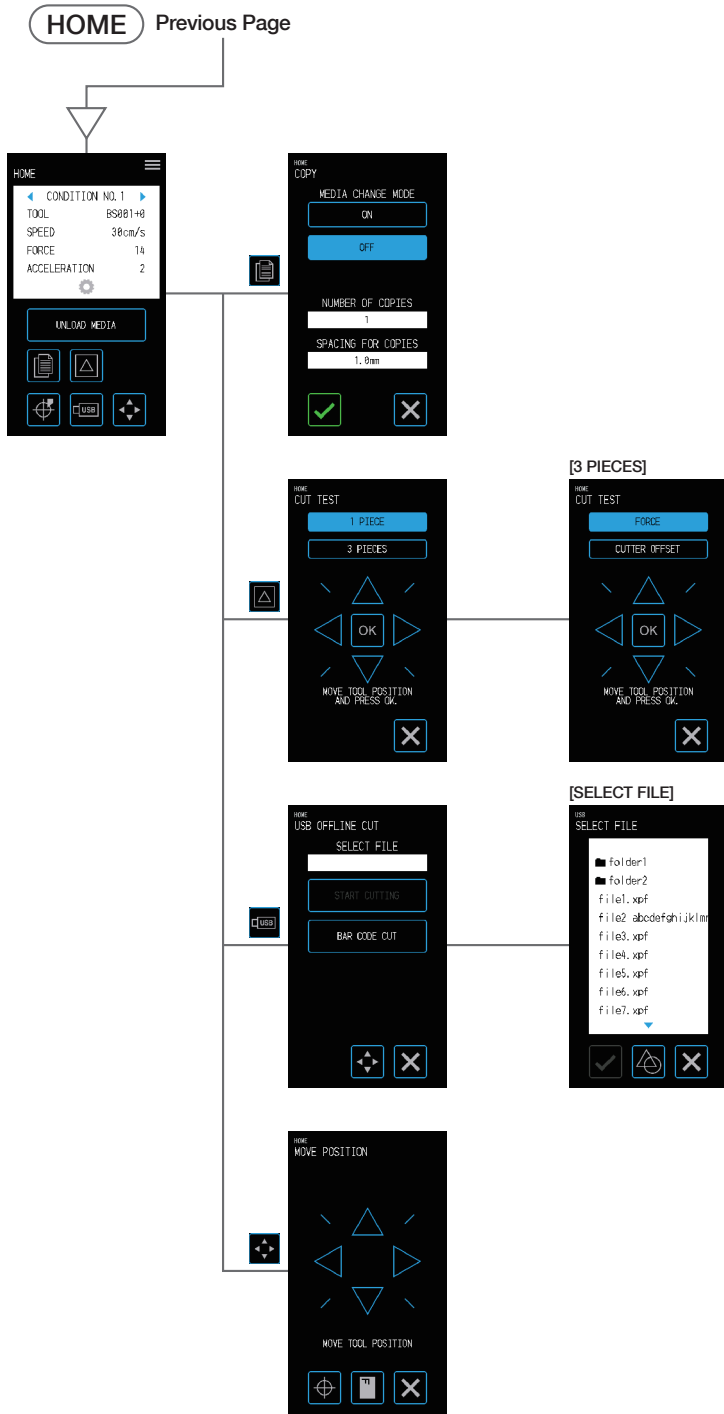

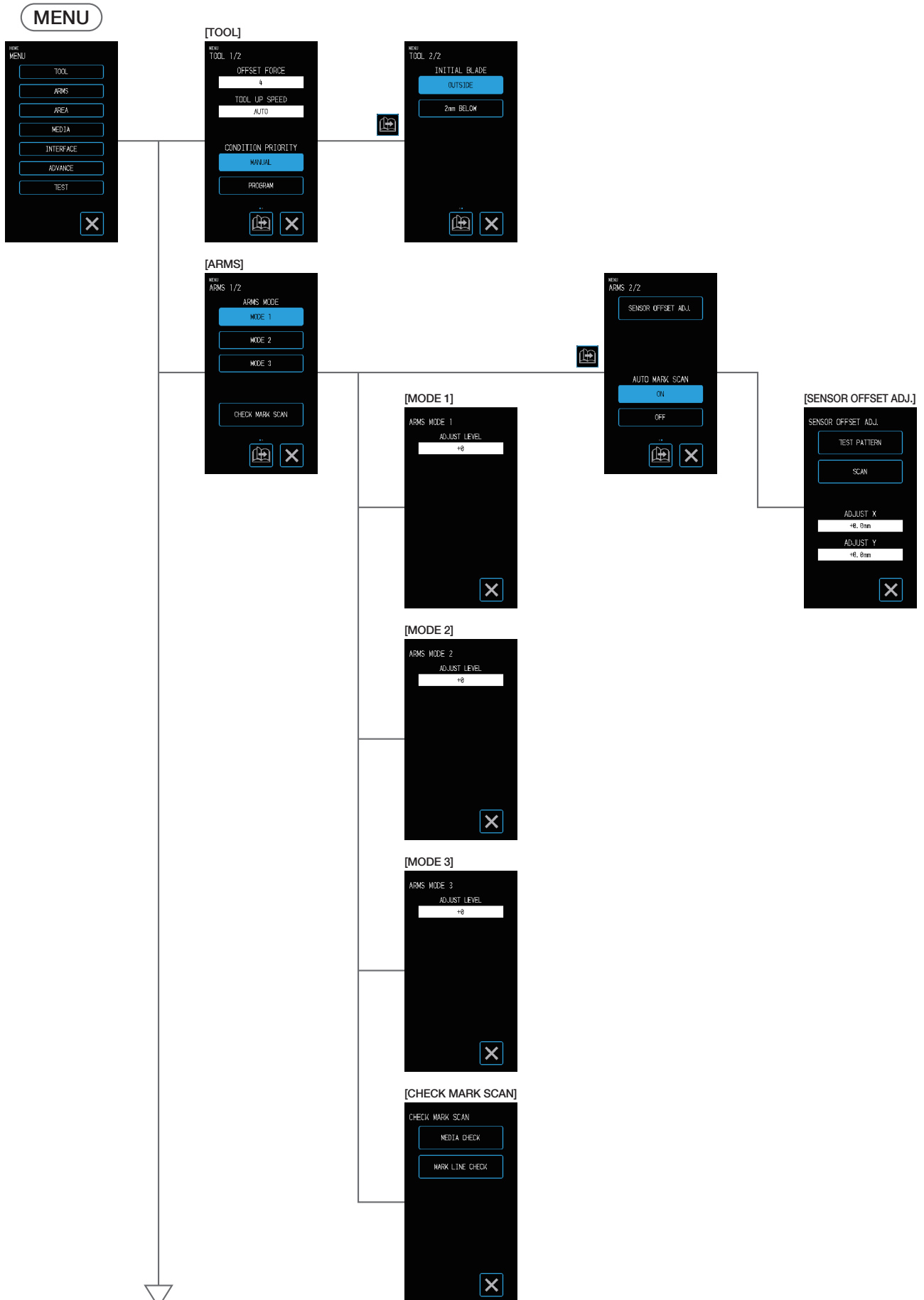

Next Page



A.5 List of Initial Values

HOME Screen

Menu Item	Setting Item	Initial Value
LOAD MEDIA	(No setting items)	–
COPY	MEDIA CHANGE MODE	OFF
	NUMBER OF COPIES	1
	SPACING FOR COPIES	1mm
CUT TEST	(No setting items)	–
MOVE TO ORIGIN	(No setting items)	–
USB	(No setting items)	–
MOVE POSITION	(No setting items)	–

MENU Screen

Menu Item	Setting Item	Initial Value
TOOL	OFFSET FORCE	10
	TOOL UP SPEED	AUTO
	CONDITION PRIORITY	PROGRAM
	INITIAL BLADE	2 mm BELOW
ARMS	ARMS MODE	MODE 1
	ADJUST LEVEL	MODE 1 (+0)
	CHECK MARK SCAN	–
	SENSOR OFFSET ADJ.	X=0, Y=0
	AUTO MARK SCAN	ON
AREA	MARGIN	NORMAL
	MEDIA AXIS ADJUST	OFF
	[MEDIA AXIS ADJUST] OFFSET X	0.0 mm
	[MEDIA AXIS ADJUST] OFFSET Y	0.0 mm
	[MEDIA AXIS ADJUST] DISTANCE ADJUST X	0.00%
	[MEDIA AXIS ADJUST] DISTANCE ADJUST Y	0.00%
MEDIA	PRE FEED	30 cm
	AUTO PRE FEED	OFF
	FEED LENGTH	30 cm
	PAGE LENGTH	50 cm
	INITIAL FEED	OFF
	WIDTH DETECTION	ON
INTERFACE	COMMAND	AUTO
	HP-GL ORIGIN POINT	LOWER LEFT
	HP-GL MODEL EMULATED	7586
	GP-GL STEP SIZE	0.100 mm
ADVANCE	LANGUAGE SELECTION	English / Japanese / German / French / Italian / Spanish / Portuguese / Russian / Chinese / Korean (selected when the power is turned ON for the first time)
	UNIT OF LENGTH	METRIC/INCH (selected when the power is turned ON for the first time)
	BEEP FOR KEY OPE.	ON
	FIRMWARE VERSION	–

Menu Item	Setting Item	Initial Value
TEST	SELF TEST	—
	CUTTING PRO	—
	ADJUST WIDTH SENSOR	—
	DIAGNOSTICS	—

TOOL COND. (CONDITION NO.) Setting Screen

Menu Item	Setting Item	Initial Value
CONDITION NO. 1	TOOL	PM-BS-001
	TOOL OFFSET	+0
	SPEED	30 cm/s
	ACCELERATION	2
	FORCE	14
	TANGENTIAL MODE	OFF
	OVERCUT (START)	0.0 mm
	OVERCUT (END)	0.0 mm
	DISTANCE ADJUST	OFF
	DISTANCE ADJUST X, Y	0.00%
CONDITION NO. 2	TOOL / TOOL OFFSET	PEN / (None)
	SPEED / ACCELERATION / FORCE	10 / 2 / 12
	From TANGENTIAL MODE to DISTANCE	Same as CONDITION NO. 1
CONDITION NO. 3	TOOL / TOOL OFFSET	PM-BS-001/+0
	SPEED / ACCELERATION / FORCE	30 / 2 / 12
	From TANGENTIAL MODE to DISTANCE	Same as CONDITION NO. 1
CONDITION NO. 4	TOOL / TOOL OFFSET	PM-BS-001/+0
	SPEED / ACCELERATION / FORCE	20 / 1 / 17
	From TANGENTIAL MODE to DISTANCE	Same as CONDITION NO. 1
CONDITION NO. 5	TOOL / TOOL OFFSET	PM-BS-001/+0
	SPEED / ACCELERATION / FORCE	20 / 2 / 17
	From TANGENTIAL MODE to DISTANCE	Same as CONDITION NO. 1
CONDITION NO. 6	TOOL / TOOL OFFSET	PM-BS-001/+0
	SPEED / ACCELERATION / FORCE	10 / 2 / 22
	From TANGENTIAL MODE to DISTANCE	Same as CONDITION NO. 1
CONDITION NO. 7	TOOL / TOOL OFFSET	PM-BS-001/+0
	SPEED / ACCELERATION / FORCE	30 / 2 / 17
	From TANGENTIAL MODE to DISTANCE	Same as CONDITION NO. 1
CONDITION NO. 8	TOOL / TOOL OFFSET	PM-BS-001/+0
	SPEED / ACCELERATION / FORCE	5 / 1 / 26
	From TANGENTIAL MODE to DISTANCE	Same as CONDITION NO. 1

INDEX

A

Aborting	4-25
AC Adapter	1-2
AC Cable	1-2
Adjusting for Full Cuts	5-12
Adjusting for Kiss Cuts	5-12
Adjusting for Use of the Drawing Pen	5-12
Adjusting the Blade Depth of the Cutter	2-2
Adjusting the Cutting Quality	5-3
Adjusting the Cutting Time	5-7
Adjusting the Media Operation	5-20
Adjusting the Offset Value	5-12
Adjusting the Width Detection Sensor	6-6
Appearance Drawing	A-4
ARMS Errors	6-4
Assembling the Roll Media Stocke	4-2
Automatic Registration Mark Position Detection	3-8

B

Blade Tip Cap Jig	1-2
-----------------------------	------------

C

Carrier Sheet	1-2
Cleaning the Cutter Pen	2-15
Compatible OS	1-8
CONDITION button	1-4
CONDITION NO. Selection buttons	1-4
Confirm button	1-4
Confirming Registration	5-14
Confirming the CONDITION NO. (Cutting Condition)	2-11
Confirming the Cut Test	5-12
Confirming the Media	5-14
Confirming the Operation of the Main Unit	6-5
Confirming the Registration Marks	5-15
Connecting a Computer	1-10
Connecting and Turning ON the Power	1-9
Copy button	1-4
Copy Function	4-20
Correcting the Registration Mark Position	5-16
Cross Cutter	1-2, A-3
Cutter groove	1-3
Cutter Set	1-2, A-3

Cut Test button	1-4
Cut Tests	5-11
Cutting Area	1-7, 2-13
Cutting Area button	1-4
Cutting Barcode-equipped Data	4-19
Cutting from a USB Memory	4-18
Cutting Mat	A-3
Cutting Origin Position	2-12
Cutting Roll Media	4-2
Cutting Thick Media	5-9
Cutting upon Specifying the Cutting Position	4-23
Cutting using the Carrier Sheet	4-10

E

Error Messages	6-3
Execute button	1-4
Exit button	1-4
Expanding the Cutting Area	4-24

F

Firmware Version	6-7
Flow of Creating Registration Marks to Cutting	3-9
Front Guide	1-3

G

GP-GL Command Errors	6-3
--------------------------------	------------

H

Home button	1-4
How to Replace the Cutting Mat	6-8
HP-GL Command Errors	6-3

I

Individually Registering Settings for Cutting Conditions	5-2
Input Screen	1-5
Installation Space	1-6
Installing the Driver and Software	1-8

L

Language Selection	1-11, 5-26
List of Initial Values	A-9
Loading and Scanning Roll Media	4-4

- Loading Media onto the Carrier Sheet **4-11**
- Loading Sheet Media **2-7**
- Loading the Carrier Sheet **4-12**
- Load Media button **1-4**

- M**
- Main Unit Diagnosis Test **6-6**
- Media holding roller **1-3**
- Media sensor **1-3**
- Media set lever **1-3**
- Media Size **1-7**
- Menu button **1-4**
- Menu Tree **A-5**

- N**
- Names and Functions of Each Component **1-3**

- O**
- OK button **1-4**
- Operation panel **1-3**
- Operation Panel **1-4**
- Ordinary Care **2-15**
- Origin button **1-4**

- P**
- Page button **1-4**
- Pausing during a Cut **4-25**
- Pen Adapter **4-15, A-3**
- Plotting the Self Test Pattern **6-5**
- Plotting the Test Pattern **6-5**
- Plotting with the Drawing Pen **4-15**
- Position key **1-4**
- Position Keys **1-5**
- Position of right side Media Set Lever **1-7**
- Positions for Registration Mark Arrangement **3-7**
- Power supply connector **1-3**
- Power switch **1-3**
- Precautions when Creating Data **2-12**
- Printing & Cutting **3-2**
- Push roller positioning guide **1-3**
- Push rollers **1-3**

- R**
- Reference and Precautions regarding
Blade Depth Adjustment **2-3**
- Registration Mark Scanned Printing & Cutting **3-5**
- Registration Mark Scan Settings **5-13**
- Registration Mark Shapes **3-6**
- Responding to Trouble **6-2**
- Roll media stocker **1-3**
- Roll Media Stocker **1-2**

- S**
- Selecting the Command **5-24**
- Selecting the Tool **5-3**
- Selection of Unit for Lengths **5-26**
- Sending Cutting Data **2-14**
- Setting Automatic
Registration Mark Position Detection **5-19**
- Setting the Acceleration **5-7**
- Setting the Auto Pre Feed **5-21**
- Setting the Beep for Key Operation **5-26**
- Setting the Blade
Tip Orientation Initialization Position **5-6**
- Setting the Condition Priority **5-5**
- Setting the Cutting Force **5-4**
- Setting the Distance Adjustment **5-5**
- Setting the GP-GL Step Size **5-25**
- Setting the HP-GL Model Emulated **5-24**
- Setting the HP-GL Origin Point **5-24**
- Setting the Initial Feed **5-21**
- Setting the Media Set Levers **2-5**
- Setting the Media Width Detection **5-22**
- Setting the Offset Force **5-4**
- Setting the Offset Value **5-3**
- Setting the Operation Panel **5-26**
- Setting the Overcuts **5-10**
- Setting the Page Length **4-8**
- Setting the Pen Adapter **4-16**
- Setting the Pre Feed Operation **5-20**
- Setting the Push Rollers **2-6**
- Setting the Scan Mode **5-13**
- Setting the Speed **5-7**
- Setting the Tool **2-4**
- Setting the Tool Up Speed **5-8**
- SETUP MANUAL **1-2**
- Simple Printing & Cutting **3-3**
- Sleep Release **1-5**
- Software Activation Code **1-2**
- Standard Accessories **1-2**

Standard Specifications	A-2
Stop button	1-4
Storage Method	2-15
Supply Items	A-3

T

Tangential Mode	5-9
TO ENSURE SAFE AND CORRECT USE	1-2
Tool carriage	1-3
Tool holder	1-3
Turning the Power ON for the First Time	1-11

U

Unit for Lengths	1-11
Unloading Sheet Media	2-10
Unload Media button	1-4
Usage of the Cross Cutter	4-9
USB button	1-4
USB Cable	1-2
USB interface	1-3
USB memory-dedicated port	1-3

W

Withdrawing the Tool Carriage	4-26
-------------------------------------	-------------

Specifications are subject to change without notice.

CE LITE-50 User's Manual

CE LITE-50-UM-151

March 16, 2018 2nd edition

GRAPHTEC CORPORATION

GRAPHTEC