

CE7000 SERIES

CUTTING PLOTTER

USER'S MANUAL

MANUAL NO.CE7000-UM-152



GRAPHTEC

Preface

Thank you for choosing a Graphtec CE7000 Series Cutting Plotter. The CE7000 Series Cutting Plotters employ a digital servo drive system to achieve high-speed and high-precision cutting. In addition to cutting marking film and other media, an CE7000 series plotter can also be used as a pen plotter. To ensure high cutting quality and optimal productivity, be sure to read this User's Manual thoroughly prior to use.

Notes on this Manual

- (1) No part of this publication may be reproduced, stored in a retrieval system, or transmitted, in any form or by any means, without the prior written permission of Graphtec Corporation.
- (2) The product specifications and other information in this manual are subject to change without notice.
- (3) While every effort has been made to provide complete and accurate information, please contact your sales representative or nearest Graphtec vendor if you find any unclear or erroneous information or wish to make other comments or suggestions.
- (4) Not with standing the stipulations in the preceding paragraph, Graphtec Corporation assumes no liability for damages resulting from either the use of the information contained herein or the use of the product.

Registered Trademarks

All names of companies, brands, logotypes, and products appearing in this manual are the trademarks or registered trademarks of their respective companies.

Copyright

This User's Manual is copyrighted by Graphtec Corporation.

About the words and phrases in this text

- In this instruction manual, the word "plot" refers to operating the machine and using either the plotting pen or the cutter pen to cut.
- In this instruction manual, the word "media" refers to paper, roll media, sheet media, or marking film.

Prior to use

- Be sure to read the attached TO ENSURE SAFE AND CORRECT USE prior to use. Otherwise, it may cause an unexpected accident or fire.

Special Precautions on Handling Blades

Sharp cutter blades are used with this plotter. Handle the cutter blades and holders with care to prevent bodily injury.

Cutter Blades

Cutter blades are very sharp. While handling a cutter blade or cutter pen, be careful to avoid cutting your fingers or other parts of your body. Promptly return used blades to the cutter case provided.

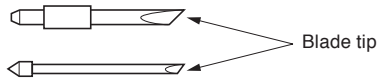

For the used blade, put it in the supplied cutter blade case and discard them in accordance with the local regulations.

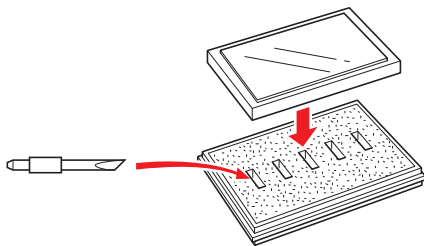

Cutter plungers

The tip consists of a sharp blade. Be sure not to extend it too far. Moreover, when you are not using the cutter plungers, make sure that the blade is fully retracted.

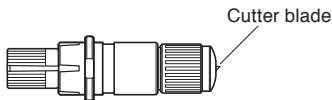

After Mounting the Cutter Plungers

After the power has been turned on, and during operation, do not touch the pen tip. It is dangerous.

After Turning on the Plotter

During the course of turning on the plotter, be sure to observe the following precautions. The tool carriage and loaded media may suddenly move during the cutting operation, immediately afterward and when setting the plotter's functions. Keep hands, hair, clothing and other objects out of the vicinity of the tool carriage, grit rollers and loaded media. To prevent operator injury and poor cutting results, be careful not to allow hands, hair, clothing or other foreign objects to become entangled with the tool carriage or loaded media while the plotter is operating.

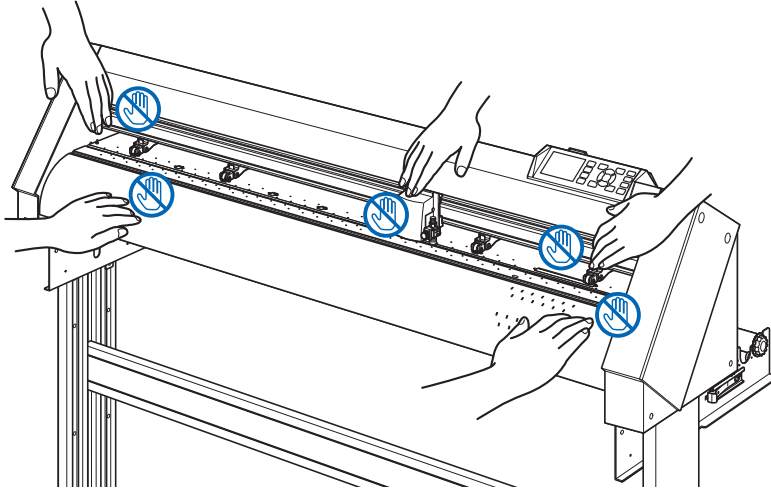

Machine Caution Label

The Caution Label is located on the machine. Be sure to observe all the cautions on the label.



Notes on the Stand

Be sure to use only the stand designed for the CE7000 Series with your CE7000 Series plotter. The use of a different stand may cause a plotter malfunction or bodily injury.

Notes on the basket (option)

Plotting/cutting longer than 2 m may affect the quality if the dedicated basket is not used. Be sure to use the dedicated basket.

Notes on the paper (media)

Please use the paper (media) in accordance with the following precautions.

- The paper is sensitive to temperature and humidity, and can start to stretch or contract immediately upon removal from the roll. Cutting/plotting the media immediately after taking it off causes it to stretch and may blur or cause deviations in the images.
- Please make sure to store the paper at the same environment (temperature/humidity) as this machine.
- Please always line up the edge of the paper.
Misalignment may cause paper skewing and mis-cuts.
Paper skewing can cause plotting deviation and cut offs.
- About the end of the roll media and the paper roll:
The cutting or plotting may differ depending on how the roll media ended or how the paper roll was stopped.
- About the paper roll:
This machine uses rolls with an internal diameter of 3 inches, or 76.2 mm. Mis-cuts or plotting deviations may occur if the paper roll is warped or has a larger internal diameter.
- About the use of thin media (70 g /m² or less)
If the cutting speed is fast, there may be paper skewing. In that case, please lower the cutting speed.
Especially when using in low humidity environment, please use lower cutting speed.

Precautions when using the curled media

- Especially upward curl will cause media jam even with weak curl.
- Please use uncurled media, or rework to make it curl weak downward to the extent that follows the plotter.

Notes on the specifications and accessories

Specifications and accessories depend on the sales area. For details, please contact your dealer.

WARNING

The United States Federal Communications Commission has specified that the following notice must be brought to the attention of users of this product.

FEDERAL COMMUNICATIONS COMMISSION RADIO FREQUENCY INTERFERENCE STATEMENT

NOTE: This equipment has been tested and found to comply with the limits for a Class A digital device, pursuant to part 15 of the FCC Rules. These limits are designed to provide reasonable protection against harmful interference when the equipment is operated in a commercial environment.

This equipment generates, uses, and can radiate radio frequency energy and, if not installed and used in accordance with the instruction manual, may cause harmful interference to radio communications. Operation of this equipment in a residential area is likely to cause harmful interference in which case the user will be required to correct the interference at his own expense.

USE SHIELDED CABLES

To comply with FCC Class A requirements, all external data interface cables and connectors must be properly shielded and grounded. Proper cables and connectors are available from GRAPHTEC's authorized dealers or manufacturers of computers or peripherals. GRAPHTEC is not responsible for any interference caused by using cables and connectors other than those recommended or by unauthorized changes or modifications to this equipment. Unauthorized changes or modifications could void the user's authority to operate the equipment.

Installation space

Please secure a space for installation as according to the below illustration.

CAUTION

Frontward and backward the machine, please take enough space for operation.

<CE7000-40>

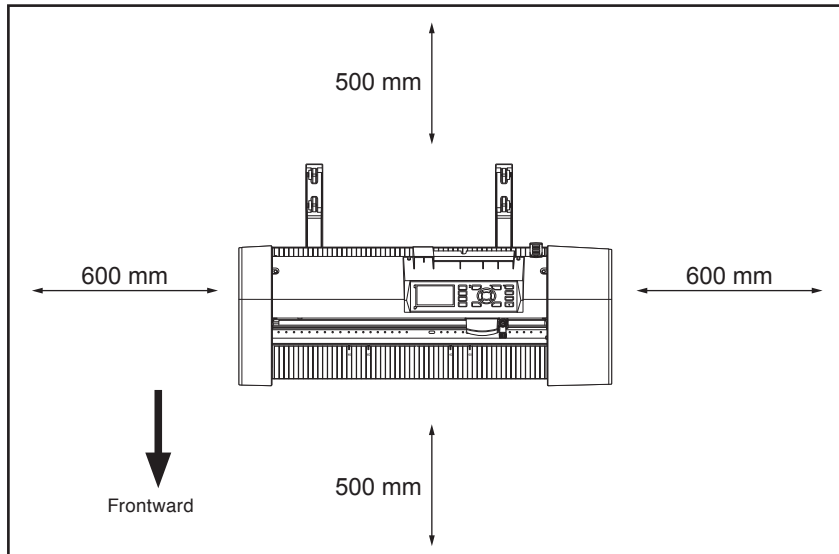

Seen from above

<CE7000-60/130/160>

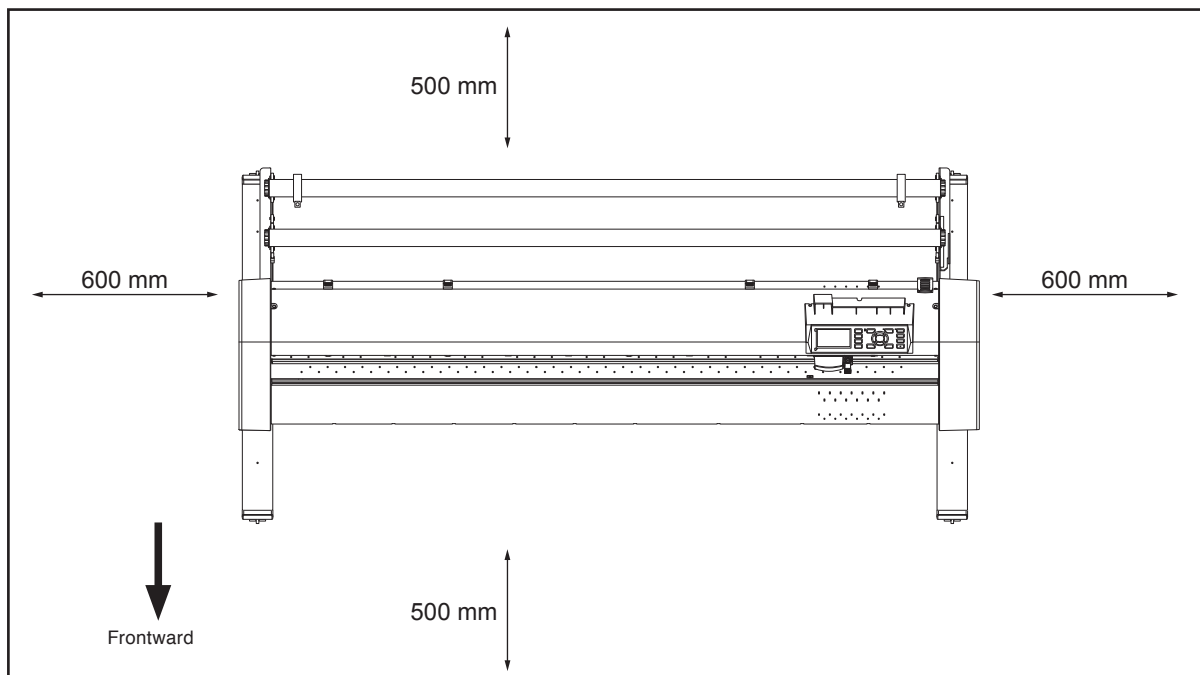

Seen from above

Selecting a power cable

Be sure to refer to the following tables if you wish to use a cable other than the one supplied as an accessory.

Table 1. 100 V to 120 V Power Supply Voltage Range

Plug Configuration	Plug Type	Supply Voltage Selector Settings	Reference Standards	Power Cable
	North America 125 V 10 A	100/120 V	ANSI C73.11 NEMA 5-15 UL498/817/62 CSA22.2 NO.42/21/49	UL Listed Type SJT No.18AWG × 3 300 V, 10 A

Table 2. 200 V to 240 V Power Supply Voltage Range

Plug Configuration	Plug Type	Supply Voltage Selector Settings	Reference Standards	Power Cable
	Europe 250 V 10 A	200 V	CEE(7)VII IEC320 CEE13	TYPE: H05VV-F 3 × 1.0 mm ²
	UK 250 V 5 A	200 V	BS1363 BS4491 BS6500	TYPE: H05VV-F 3 × 1.0 mm ²
	Australia 250 V 10 A	200 V	AS3112 AS3109 AS3191	TYPE: OD3CFC 3 × 1.0 mm ²
	North America 250 V 15 A	200 V	ANSI C73.20 NEMA 6-15 UL 198.6	UL Listed Type SJT No.18AWG × 3 300 V, 10 A
	Switzerland 250 V 6 A	200 V	SEV1011 SEV1004 SEV1012	TYPE: H05VV-F 3 × 0.75 mm ²
	China 250 V 6 A	200 V	GB15934 GB2099.1 GB1002 GB/T 5023.5	TYPE: H05VV-F 3 × 1.0 mm ²

CONTENTS

Preface	I
Notes on this Manual	I
Registered Trademarks	I
Copyright	I
About the words and phrases in this text	II
Prior to use	II
Special Precautions on Handling Blades	III
Cutter Blades	III
Cutter plungers	III
After Mounting the Cutter Plungers	III
After Turning on the Plotter	IV
Machine Caution Label	IV
Notes on the Stand	IV
Notes on the basket (option)	IV
Notes on the paper (media)	V
Precautions when using the curled media	V
Notes on the specifications and accessories	V
WARNING	VI
FEDERAL COMMUNICATIONS COMMISSION RADIO FREQUENCY INTERFERENCE STATEMENT	VI
USE SHIELDED CABLES	VI
Installation space	VII
Selecting a power cable	VIII

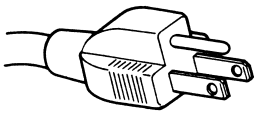
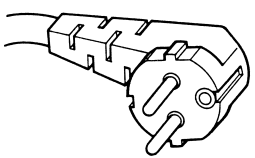
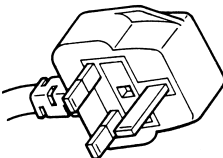
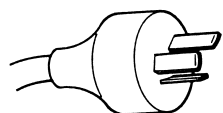
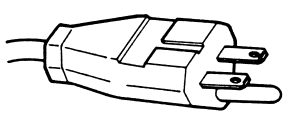
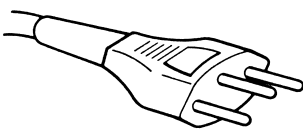
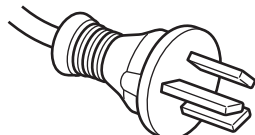
Chapter 1: Product Summary

1.1	Checking the Accessories	1-2
	Accessories	1-2
	Dedicated accessories	1-3
1.2	Nomenclature	1-4
	Front view : CE7000-40	1-4
	Rear view : CE7000-40	1-5
	Front view : CE7000-60	1-6
	Rear view : CE7000-60	1-7
	Front view : CE7000-130/160	1-8
	Rear view : CE7000-130/160	1-9
1.3	Assembling	1-10
	Mounting the Roll-medium tray	1-10
	Mounting the stock shafts	1-11
1.4	Connecting to the Computer	1-13

Chapter 2: Preparing to Cut

2.1	Preparation of Cutter Plunger	2-2
	Cutter plunger nomenclature	2-2

Structure of cutter plunger	2-3
Adjusting the blade length	2-4
Blade application and features	2-4
2.2 Attaching a Tool	2-5
Attaching a tool	2-5
Removing the tool	2-6
2.3 Loading Media (Paper or Marking Film)	2-7
Loading roll media (CE7000-40)	2-7
Loading roll media (CE7000-60/130/160)	2-10
Loading sheet media (CE7000-40/60)	2-16
Loading sheet media (CE7000-130/160)	2-18
Carrier Sheet (for Affixing Media for Cutting)	2-21
Loading the Medium	2-22
Effective Cutting Area	2-22
Mounting the Carrier Sheet Table (Option: OPH-A45)	2-23
Setting method of carrier sheet (Carrier Sheet Table: Option)	2-23
2.4 Aligning the Push Rollers	2-25
Aligning the push roller	2-25
When feeding long media (2 meters or more)	2-25
When feeding long media (2 meters or less)	2-26
When narrow media (160 mm or less) is used	2-26
Changing the hold-down force	2-27
Switching	2-27
Assignment	2-28
2.5 About the Default Screen	2-29
2.6 Connecting to the Power	2-30
2.7 How to Use Control Panel	2-31
Indicator lamp	2-31
Operation key	2-31
Reading the screen (LCD)	2-32
Contents of Operation from MENU Screen	2-34
Simple mode	2-34
Normal mode	2-35
Operation from [COND/TEST] key	2-36
Simple mode	2-36
Normal mode	2-36
2.8 Setting Feeding Method	2-37
2.9 Pre Feed of Media (Paper or Marking Film)	2-39
2.10 Selecting Tool Condition	2-40
Simple mode	2-40
Normal mode	2-41
Setting the tool condition	2-42
Setting the Speed and Force (Simple mode)	2-44
Setting the tool	2-46
Setting the speed	2-48
Setting the force	2-50
Setting the acceleration	2-51
Setting tool No.	2-53
Adjust the blade length manually	2-55

2.11	Running Cutting Tests	2-56
	Cutting test	2-56
	To make 1 cut with set value	2-56
	To make 3 cuts with set value and ± 1 of set value	2-57
	Confirm the results of the cutting test	2-59
	Adjustment of Offset	2-59
	Adjustment for Half Cutting	2-59
	Adjustment for cutting out	2-59
	Adjustment when using plotting pen	2-59
	Adjust the blade length (Automatic Height Adjust)	2-60
2.12	About Simple mode	2-63
	Changing Mode	2-64
	2.12.1 Setting Page Length (Simple mode)	2-65
	2.12.2 Origin Point Settings When configuring HP-GL (Simple mode)	2-67
	2.12.3 GP-GL Step Size (Simple mode)	2-68
	2.12.4 Display Language Settings (Language) (Simple mode)	2-69
	2.12.5 Display Length Unit Settings (Length Unit) (Simple mode)	2-70
2.13	Displaying Cutting Area	2-71

Chapter 3: Basic Operations

3.1	Raise or Lower the Tool	3-2
3.2	Move the Tool Carriage and Media	3-3
	Move in steps manually	3-3
	Continuously move manually	3-3
	Setting step movement distance	3-4
	Move away the tool carriage	3-5
	Change the cutting condition (Condition No.)	3-6
	Reset (Revert to the initial state when the power was turned on.)	3-6
3.3	Setting the Origin Point	3-7
	When coordinate axes rotation are set	3-8
	When coordinate axes are rotated after origin point is set	3-8
	Setting origin point when HP-GL is set	3-9
3.4	Setting the Cutting Direction	3-10
3.5	Stop Cutting	3-12
	Pause and resume cutting	3-12
	Stop cutting	3-13

Chapter 4: Convenient Functions

4.1	Settings for Cutting	4-2
	Setting cutting area	4-2
	Setting cutting width (EXPAND)	4-4
	Setting length of the page	4-5
	Setting mirror	4-7
	Set the enlarge/shrink scale (Scale)	4-8
4.2	Copy (Duplicate Cutting)	4-10
	When media change mode is OFF	4-10
	When media change mode is ON	4-13
4.3	Panel Cutting	4-15

Chapter 5: ARMS (Advanced Registration Mark Sensing System)

5.1	Outline of ARMS	5-2
	Shape (Pattern) of the Registration Mark and Origin Point	5-3
	Scan range necessary to detect the registration mark	5-4
	Positioning of the media and the registration mark	5-6
	Cutting area when adjusting the registration mark	5-6
	Automatic detection of registration mark position	5-7
	Media that registration mark cannot be detected	5-7
5.2	Setting and Adjustment of ARMS	5-8
	Set the MARK SCAN Mode	5-8
	Checking the recommended setting of registration mark	5-10
	Check the lines of registration mark	5-12
	Test the registration mark sensor	5-14
	Adjusting for the registration mark scan position	5-16
	Adjust after plotting the adjustment registration mark	5-16
	Detect the registration mark for adjustment on the media and enter the value	5-20
	Setting the registration mark automatic detection	5-23
	Setting speed of the registration mark scan	5-25

Chapter 6: Manual Position Adjust

6.1	Outline of Manual Position Adjust	6-2
	Setting mark scan mode and number of adjustment marks	6-2
	Adjust with 2POINTS	6-2
	Adjust with 3POINTS	6-3
	Adjust with 4POINTS	6-3
6.2	Manual Position Adjust	6-4

Chapter 7: Setting Regarding Cutting Quality

7.1	Cutting the Corner of Thick Media Sharp	7-2
	Outline of tangential mode	7-2
	Setting the tangential mode	7-3
	Setting the length of overcut	7-4
	Setting of the Initial Down Force	7-6
7.2	Setting the Step Pass	7-8
7.3	Setting the Offset Angle	7-10
7.4	Setting the Distance Adjust	7-12
7.5	Setting Cut Line Pattern	7-15
7.6	Setting Initial Blade Control Position Adjust	7-19
7.7	Setting the OFFSET FORCE	7-21
7.8	Setting Adjustment Between the Tools	7-22
	In the case of Tool 1 - Tool 3	7-22

Chapter 8: Settings Regarding Cutting Time

8.1	Sorting the Cutting Data	8-2
8.2	Perform Automatic Pre Feed When Cut Data is Received	8-4
8.3	Perform Automatic Pre Feed When Media is Set (Initial Feed)	8-6
8.4	Setting Feed Speed for Pre Feed	8-7
8.5	Setting the MOVING SPEED	8-9
8.6	Setting the Tool Up Move	8-11
8.7	Setting the Tool Up Height	8-13

Chapter 9: Setting Regarding Interface

9.1	Setting Interface	9-2
	USB interface	9-2
	Network (LAN) interface	9-3
	RS-232C interface	9-3
9.2	Clearing the Buffer Memory	9-4
9.3	I/F (LAN)	9-5
	Setting the DHCP	9-5
	Set IP address, subnet mask, gateway	9-7
9.4	Connecting with RS-232C	9-10
	Switching the setting number you want to use	9-10
	Changing/storing the RS-232C setting	9-11

Chapter 10: Settings Regarding Operation Environment

	Related to menu display	10-2
	Display language setting (LANGUAGE SELECTION)	10-2
	Display Length Unit Setting (LENGTH UNIT)	10-3
	Related to sensor	10-4
	Enabling/Disabling the media sensors (MEDIA SENSOR)	10-4
	Enabling/Disabling the push roller sensors (PUSH ROLLER SENSOR)	10-5
	Related to plotter environment	10-7
	Fan suction setting (FAN POWER)	10-7
	Enabling/Disabling the beep setting (BEEP FOR KEY OPERATION)	10-8
	Pause key select setting (Selecting PAUSE key)	10-9
	Simple mode / Normal mode setting (Simple mode / Normal mode)	10-10
	LCD contrast setting (LCD contrast)	10-11

Chapter 11: Settings of Controls from Computer

	Related to command processing	11-2
	Setting the command (COMMAND)	11-2
	Priority of tool condition selection (CONDITION PRIORITY)	11-3
	Related to GP-GL command	11-4
	Setting the step size (GP-GL STEP SIZE)	11-4
	Enabling/Disabling the ':' and ';' commands (COMMAND ':', ';')	11-5
	Moving the pen while raised or lowered in Response to the 'W' command (COMMAND 'W')	11-6
	Related to HP-GL command	11-7
	Model ID response (HP-GL MODEL EMULATED)	11-7
	Circle-command resolution setting (CIRCLE RESOLUTION)	11-8

Chapter 12: Data Link

12.1	Select Connection Destination.....	12-2
12.2	Data Link with USB Memory.....	12-3
12.3	Output with a Bar Code.....	12-5
12.4	Start Mark Auto Scan.....	12-8
12.5	Communication Timeout.....	12-10
12.6	Skew Scanning.....	12-12

Chapter 13: Cutting with supplied application software

Chapter 14: Maintenance

14.1	Daily Maintenance.....	14-2
	Daily maintenance.....	14-2
	Storing the plotter.....	14-2
14.2	Replacing Cutter Blade.....	14-3
14.3	Cleaning the Cutter Pen.....	14-5
14.4	Cutter Plunger Exchange.....	14-6
14.5	Setting the Alarm for Degree of Wear (BLADE WEAR ALARM).....	14-7

Chapter 15: Troubleshooting

15.1	Troubleshooting.....	15-2
	When the plotter does not operate after turning the power on.....	15-2
	When it does not work right.....	15-3
	When the Cutting Result is Not Good.....	15-5
	Error Messages in GP-GL Command Mode.....	15-6
	Error Messages in HP-GL Command Mode.....	15-7
	ARMS Error Messages.....	15-9
	Other Error Messages.....	15-12
	Caution Message.....	15-15
15.2	Printing the Setting of the Plotter.....	15-16
15.3	Creating Test Pattern.....	15-18
15.4	Creating CUTTING PRO.....	15-20
15.5	Confirm the Cutting Data.....	15-22
15.6	Self Diagnostic Test.....	15-24
	Reading the error message.....	15-26

Appendix

A.1	Main Specifications	A-2
A.2	Options and Supplies	A-3
	Supplies	A-3
	Options	A-3
A.3	External Dimensions	A-4
	CE7000-40	A-4
	CE7000-60	A-5
	CE7000-130/160	A-6
A.4	Menu Tree	A-7
	Simple mode	A-7
	Normal mode	A-8
A.5	Initial Setting	A-17
	Simple mode	A-17
	Normal mode	A-18

INDEX	I-1
--------------------	------------

Chapter 1: Product Summary



This chapter explains how to connect this machine to your computer.

PRODUCT SUMMARY

- 1.1** *Checking the Accessories*
- 1.2** *Nomenclature*
- 1.3** *Assembling*
- 1.4** *Connecting to the Computer*

1.1 Checking the Accessories

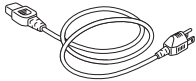
Accessories

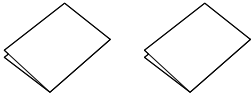
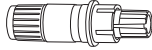
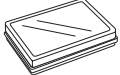
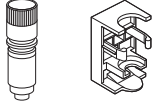
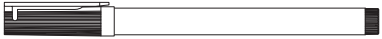
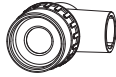
Item	Q'ty	Item	Q'ty
Power cable 	1 pc.	USB cable 	1 pc.
SETUP MANUAL TO ENSURE SAFE AND CORRECT USE 	1 of each	Cutter plunger (PHP33-CB09N-HS) 	1 pc.
Cutter blade (CB09UB (1P)) 	1 pc.	Water-based fiber pen adapter (PHP31-FIBER)  * Plunger/Height adjustment tool.	1 set
Water-based fiber pen (KF700-BK [1P]) 	1 pc.	Cutter blade adjustment magnifier (PM-CT-001) 	1 pc.

* In addition, various information may be attached.

* Accessories may vary depending on the sales area.

* For details, please contact the distributor where you purchased.

Dedicated accessories

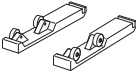
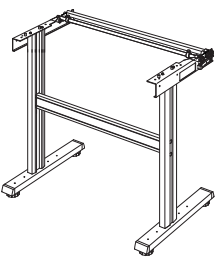
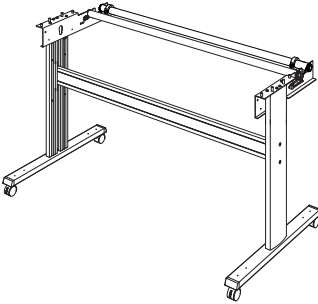
CE7000-40		CE7000-60		CE7000-130/160	
Item	Q'ty	Item	Q'ty	Item	Q'ty
Roll-medium tray 	1 set	Stand * 	1 set	Stand 	1 set

* It depends on the sales area. For details, please contact your dealer.

1.2 Nomenclature

Front view : CE7000-40

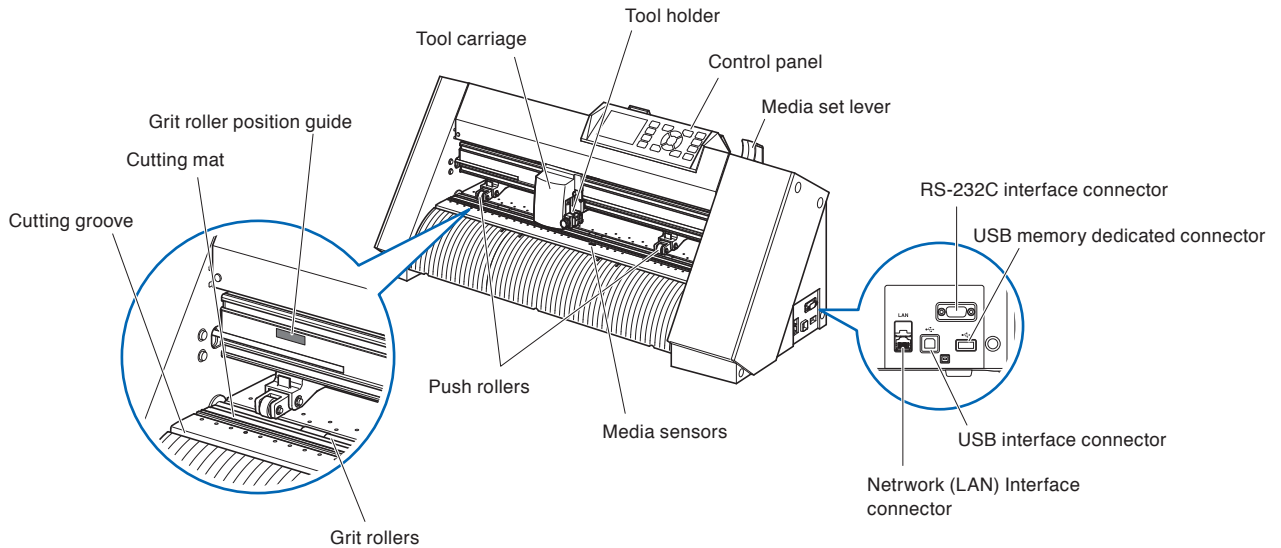

- Control panel**.....Used to access various plotter functions.
- Push rollers**Rollers that push the media against the grit rollers.
- Grit rollers**Feeds the media back and forth.
- Media sensors**The front sensor is used to sense the leading edge of the media. The rear sensor is used to sense the trailing edge of the media.
- Tool carriage**Moves the cutter-pen or plotting pen across the media during cutting or plotting.
- Tool holder**Holds the cutter-pen or plotting pen and moves it up or down.
- Grit roller position guide**A roller position guide is affixed to the front side of the rail, which shows the position of each grit roller. Use these alignment marks as an aid in locating the Push rollers.
- Cutting mat**The cutter blade moves on this cutting mat.
- Cutting groove**Use this groove to cut out (die cut) or cross cut.
- Media set lever**Used to raise or lower the Push rollers during the loading or unloading of media.
- USB interface connector**Used to connect the plotter to the computer with a USB interface cable.
- RS-232C interface connector**
Used to connect the plotter to the computer with a RS-232C interface cable. It depends on the sales area. For details, please contact the distributor where you purchased.
- Network (LAN) Interface connector**
Used to connect this plotter with a network (LAN) I/F.
- USB memory dedicated connector**
USB memory dedicated connector.

Rear view : CE7000-40

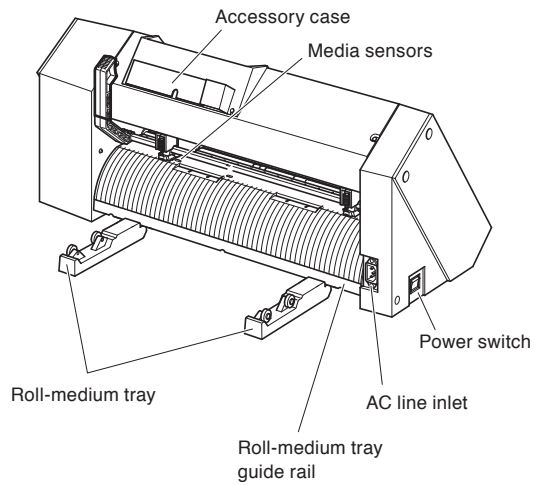

Roll-medium tray.....A tray to set media in.

Roll-medium tray guide rail....A rail to set the roll media tray in.

Power switchUsed to turn the plotter on and off.

AC line inlet Inlet where the power cable is connected.

Accessory caseSpace for temporary storage of accessories such as cutter blades and cutter plungers.

Front view : CE7000-60

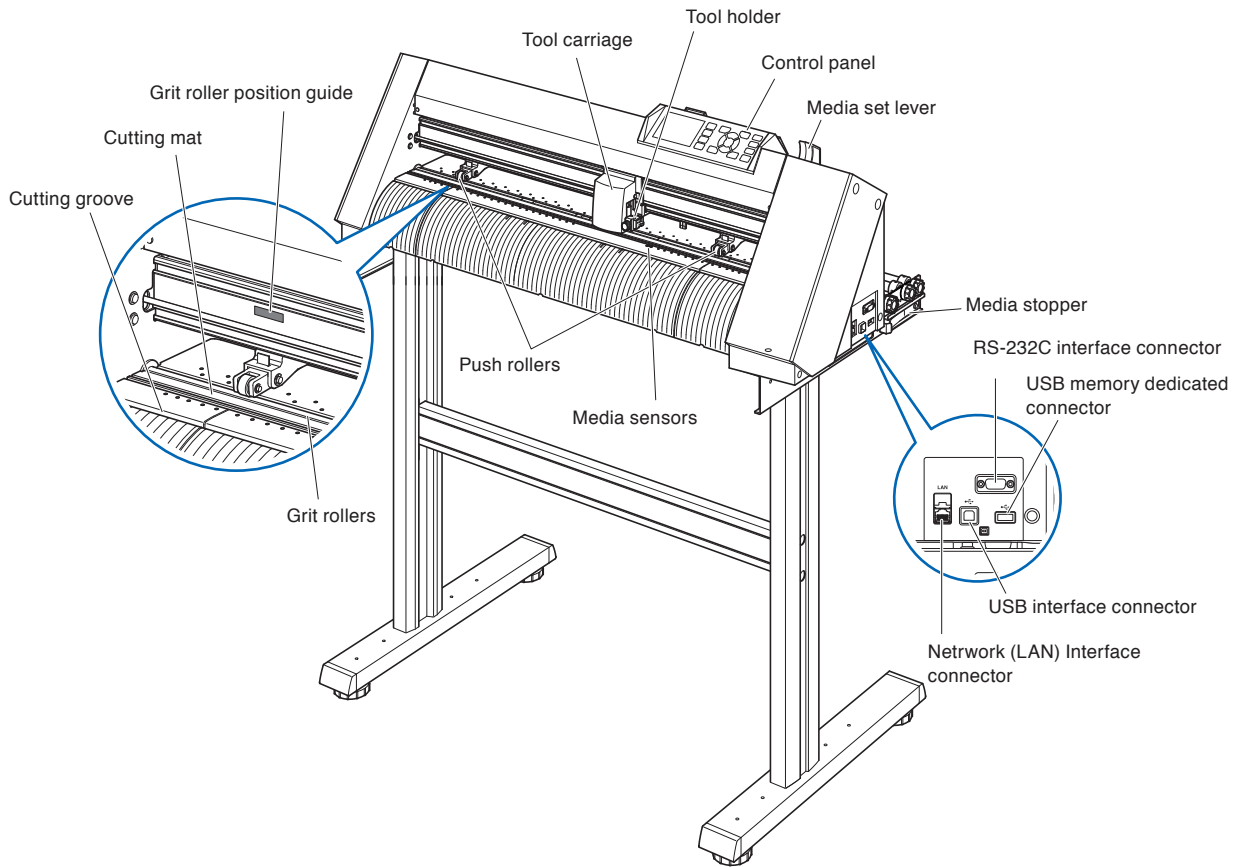

- Control panel**.....Used to access various plotter functions.
- Push rollers**Rollers that push the media against the grit rollers.
- Grit rollers**Feeds the media back and forth.
- Media sensors**The front sensor is used to sense the leading edge of the media. The rear sensor is used to sense the trailing edge of the media.
- Tool carriage**Moves the cutter-pen or plotting pen across the media during cutting or plotting.
- Tool holder**Holds the cutter-pen or plotting pen and moves it up or down.
- Grit roller position guide**A roller position guide is affixed to the front side of the rail, which shows the position of each grit roller. Use these alignment marks as an aid in locating the Push rollers.
- Cutting mat**The cutter blade moves on this cutting mat.
- Cutting groove**Use this groove to cut out (die cut) or cross cut.
- Media set lever**Used to raise or lower the Push rollers during the loading or unloading of media.
- USB interface connector**Used to connect the plotter to the computer with a USB interface cable.
- RS-232C interface connector**
Used to connect the plotter to the computer with a RS-232C interface cable. It depends on the sales area. For details, please contact the distributor where you purchased.

- Media stopper**This stops the stock shaft from spinning when setting in media. It is utilized when pulling roll media straight out.
- Network (LAN) Interface connector**
.....Used to connect this plotter with a network (LAN) I/F.
- USB memory dedicated connector**
.....USB memory dedicated connector.

Rear view : CE7000-60

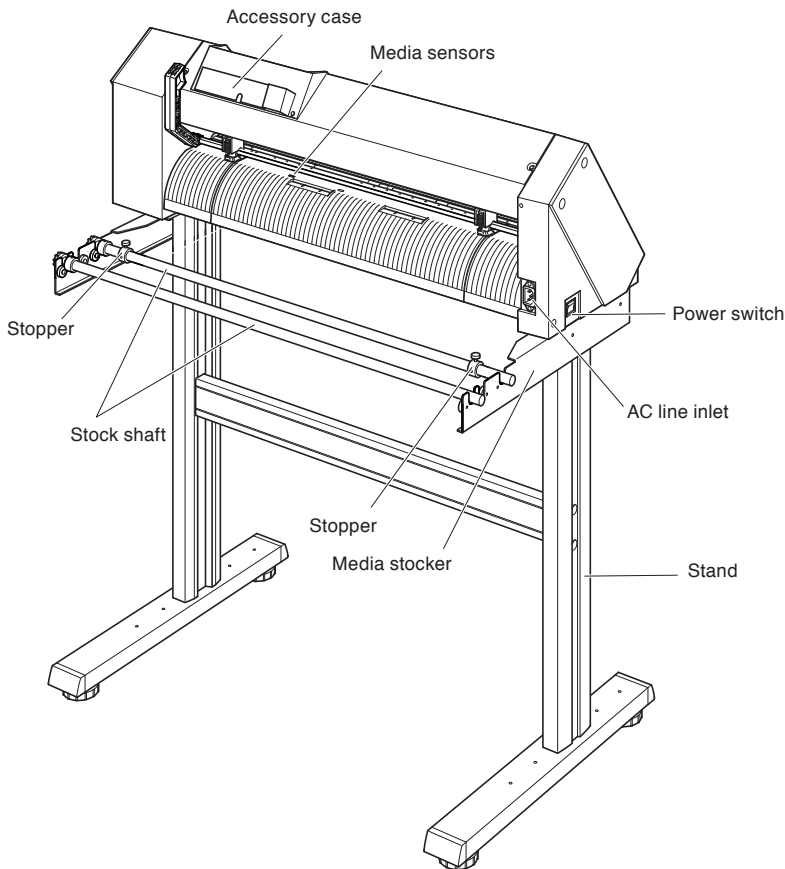

- Power switch**Used to turn the plotter on and off.
- AC line inlet** Inlet where the power cable is connected.
- Media stocker**A stock to set roll media in.
- Stock shaft**A roller that takes in roll media.
- Stopper**Keeps set roll media in place.
- Stand**A stand to put the machine on.
- Accessory case**Space for temporary storage of accessories such as cutter blades and cutter plungers.

Front view : CE7000-130/160

This section explains in the CE7000-130.

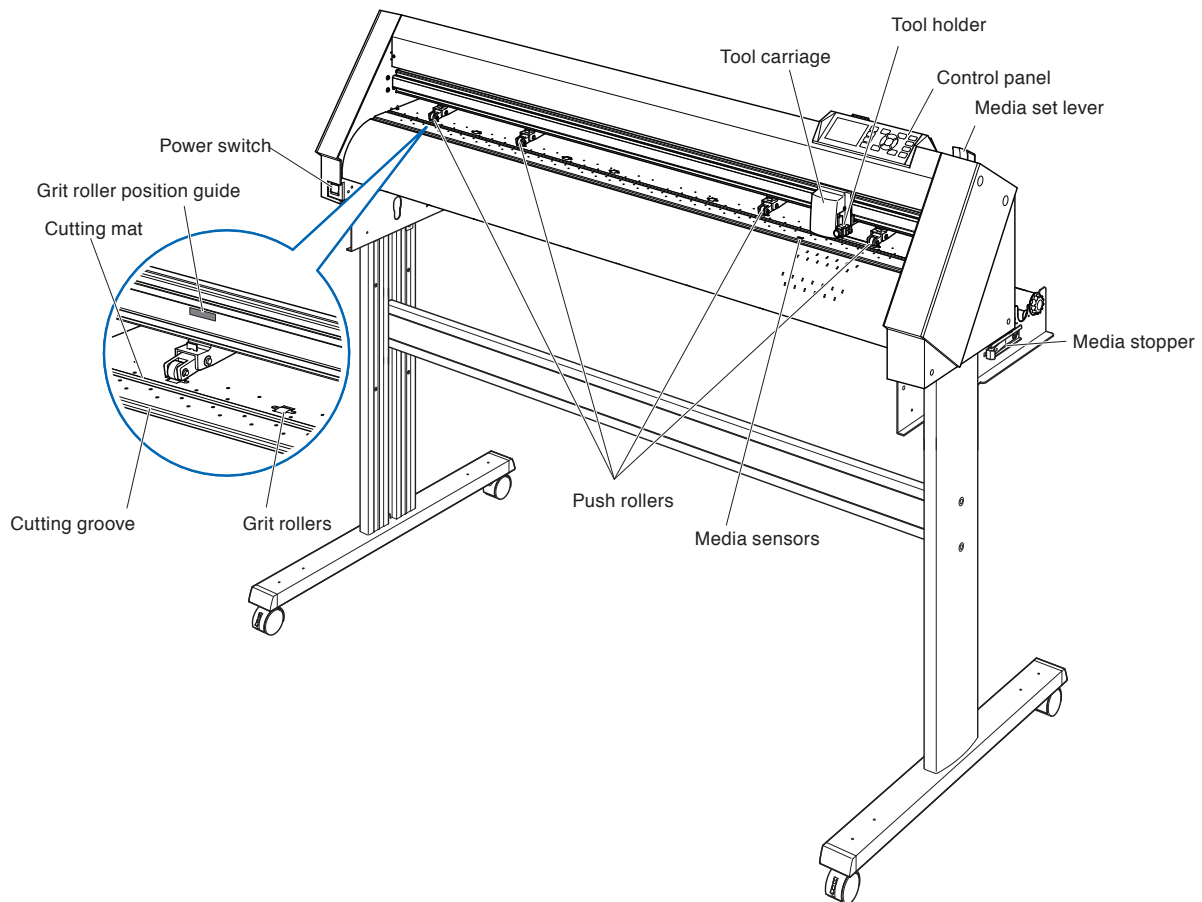

Control panel.....Used to access various plotter functions.

Push rollersRollers that push the media against the grit rollers.

Grit rollersFeeds the media back and forth.

Media sensorsThe front sensor is used to sense the leading edge of the media. The rear sensor is used to sense the trailing edge of the media.

Tool carriageMoves the cutter-pen or plotting pen across the media during cutting or plotting.

Tool holderHolds the cutter-pen or plotting pen and moves it up or down.

Grit roller position guideA roller position guide is affixed to the front side of the rail, which shows the position of each grit roller. Use these alignment marks as an aid in locating the Push rollers.

Cutting matThe cutter blade moves on this cutting mat.

Cutting grooveUse this groove to cut out (die cut) or cross cut.

Media set leverUsed to raise or lower the Push rollers during the loading or unloading of media.

Media stopperThis stops the stock shaft from spinning when setting in media. It is utilized when pulling roll media straight out.

Power switchUsed to turn the plotter on and off.

Rear view : CE7000-130/160

This section explains in the CE7000-130.

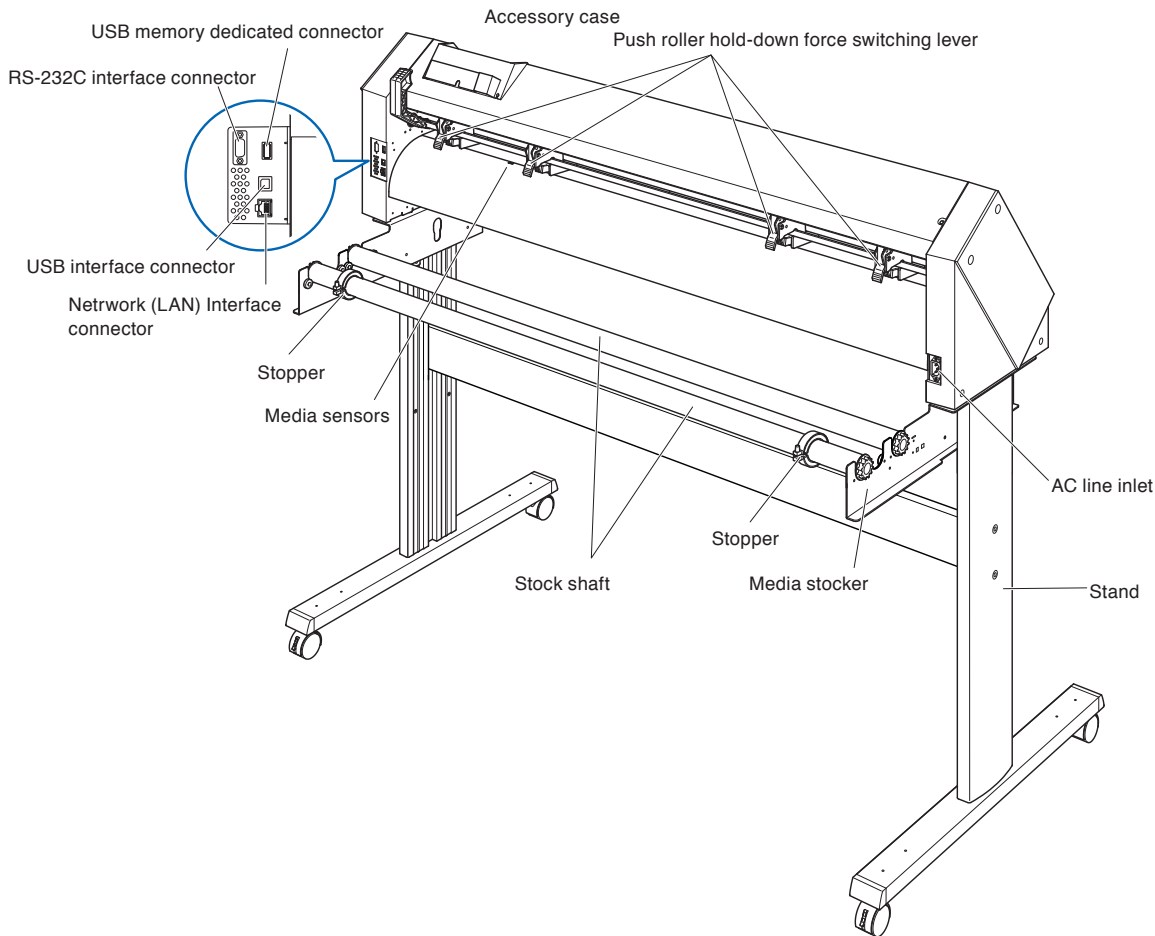

AC line inlet Inlet where the power cable is connected.

Push roller hold-down force switching lever

.....Switches the hold-down force of the push roller to 3 stages of strong, medium and weak.

Media stockerA stock to set roll media in.

Stock shaftA roller that takes in roll media.

StopperKeeps set roll media in place.

StandA stand to put the machine on.

USB interface connectorUsed to connect the plotter to the computer with a USB interface cable.

RS-232C interface connector

.....Used to connect the plotter to the computer with a RS-232C interface cable. It depends on the sales area. For details, please contact the distributor where you purchased.

Network (LAN) Interface connector

.....Used to connect this plotter with a network (LAN) I/F.

USB memory dedicated connector

.....USB memory dedicated connector.

Accessory caseSpace for temporary storage of accessories such as cutter blades and cutter plungers.

1.3 Assembling

Mounting the Roll-medium tray

Mounting (CE7000-40)

- 1 Insert the roll paper tray into the roll paper tray guide rail according to the media width you want to use.

Make sure the rollers on the roll media tray are on the outside on both sides.

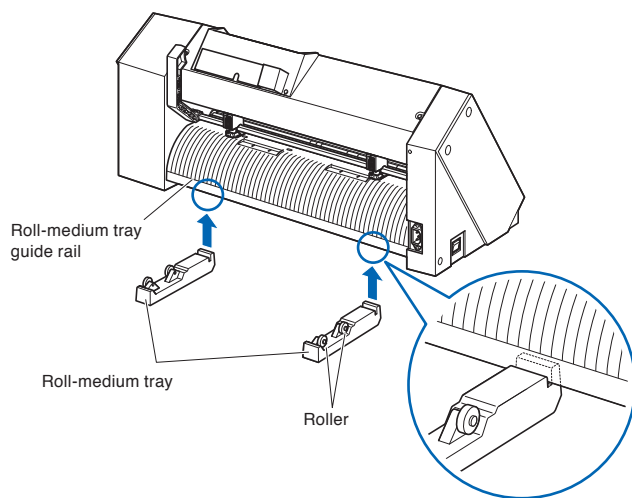

Mounting the stock shafts

Mounting (CE7000-60)

- 1 Set one stopper in the stock shaft.
(Keep the stopper screws slightly loose.)

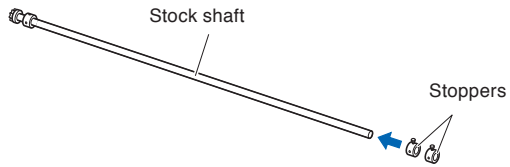

- 2 Put the side with the gear on the left side of the machine (looking from the back) and then slide the stock shaft into the media stocker.

Slide the media stocker in so that it is bookended by the gear and the fixed stopper. Make sure the stock shaft touches the roller.

Change the insertion position of the rear stock shaft according to the roll diameter of the media you want to use.

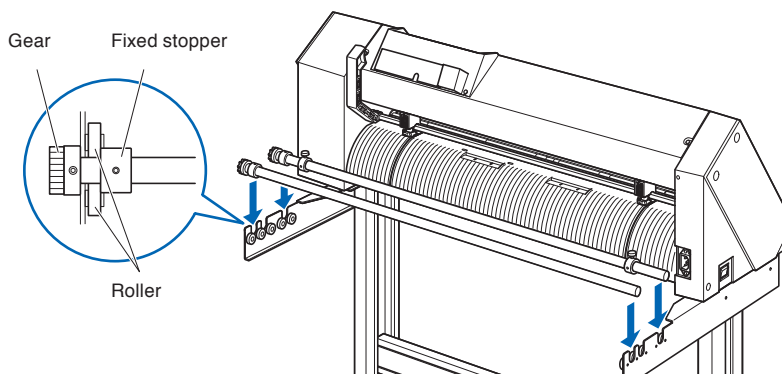

Mounting (CE7000-130/160)

This section explains in the CE7000-130.

- 1 Set one stopper in the stock shaft.
(Keep the stopper screws slightly loose.)

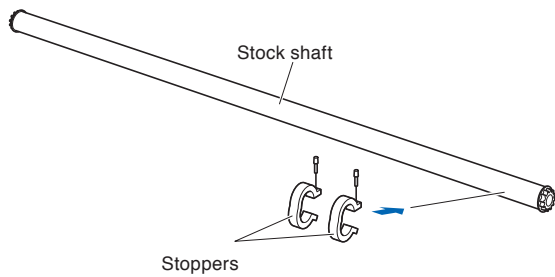

- 2 Slide the stock shaft into the media stocker.
Change the insertion position of the rear stock shaft according to the roll diameter of the media you want to use.

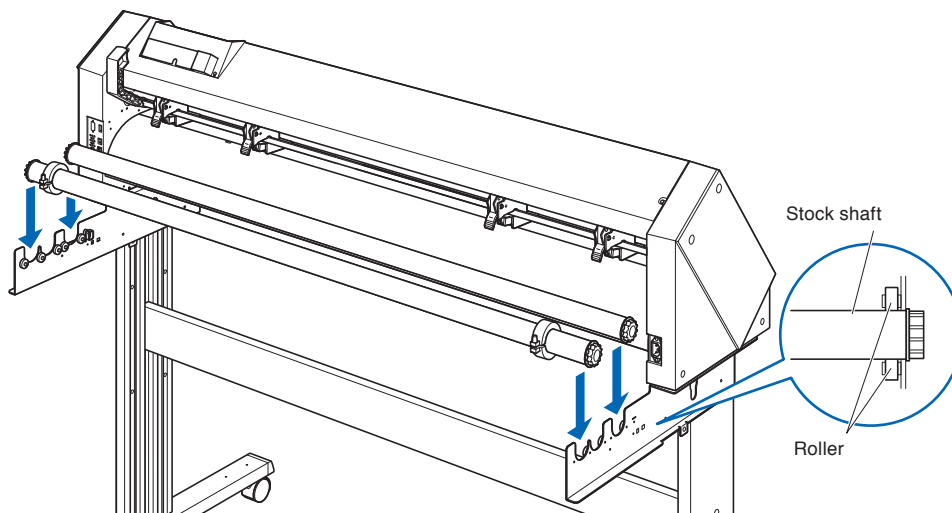

1.4 Connecting to the Computer

Connect the plotter to the computer using the interface cable. Use one of the USB ports, the network (LAN) interface or the RS-232C port to connect the plotter to the computer. Select the port depending on the specification of the software to be used and the availability of the interface port on the computer.

Please install driver software before connecting.

Depending on the port used, use one of the USB cable (standard accessories), the network (LAN) cable (commercially available product) or the RS-232C cable (commercially available product) to connect. Use the cables specified by Graphtec, matching the computer that is to be connected.

* RS-232C interface depends on the sales area. For details, please contact the distributor where you purchased.

Connection

- 1 Check that the power switch is turned off (the "O" side is pressed down).

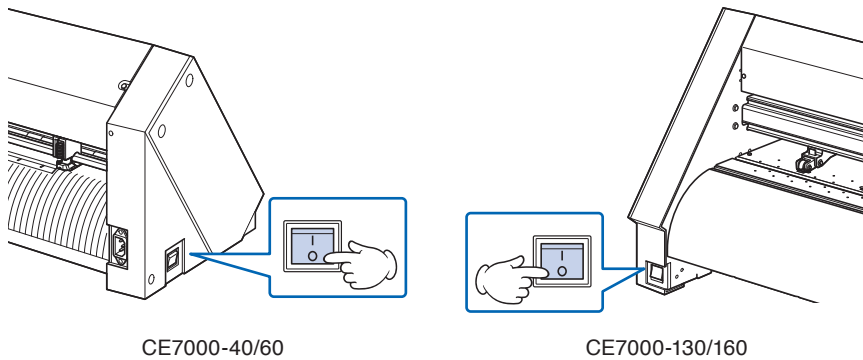

- 2 Connect the plotter to the computer using the interface cable.

* This section explains in the CE7000-130.

Supplement

See the "Setting Interface" for setting the interface.

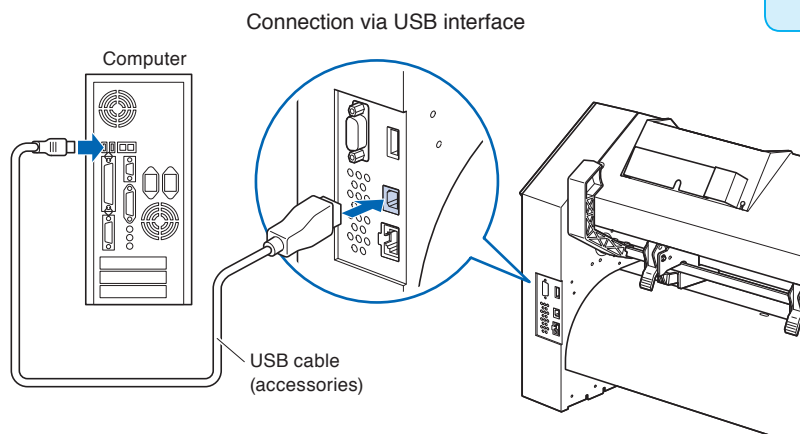

Connection via network (LAN) interface

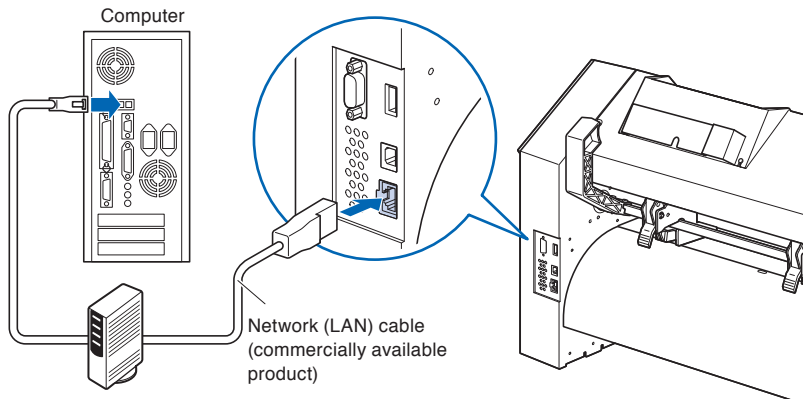

Connection via RS-232C interface

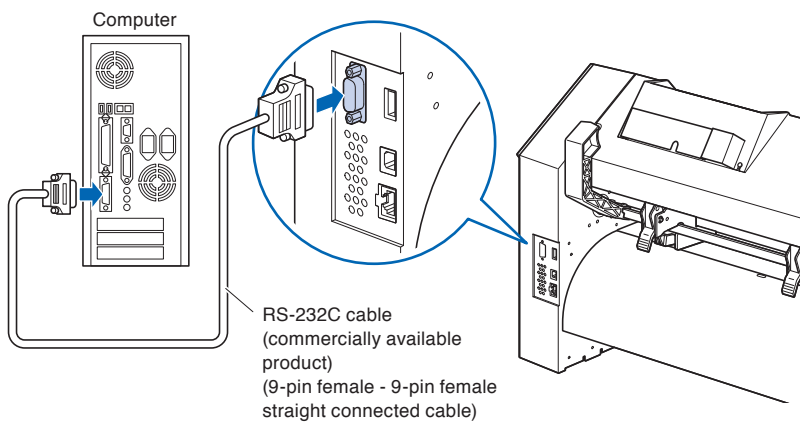

Chapter 2: Preparing to Cut

This chapter describes how to prepare to start the cutting.

PRODUCT SUMMARY

- 2.1 Preparation of Cutter Plunger**
- 2.2 Attaching a Tool**
- 2.3 Loading Media (Paper or Marking Film)**
- 2.4 Aligning the Push Rollers**
- 2.5 About the Default Screen**
- 2.6 Connecting to the Power**
- 2.7 How to Use Control Panel**
- 2.8 Setting Feeding Method**
- 2.9 Pre Feed of Media (Paper or Marking Film)**
- 2.10 Selecting Tool Condition**
- 2.11 Running Cutting Tests**
- 2.12 About Simple mode**
 - 2.12.1 Setting Page Length (Simple mode)**
 - 2.12.2 Origin Point Settings When configuring HP-GL (Simple mode)**
 - 2.12.3 GP-GL Step Size (Simple mode)**
 - 2.12.4 Display Language Settings (Language) (Simple mode)**
 - 2.12.5 Display Length Unit Settings (Length Unit) (Simple mode)**
- 2.13 Displaying Cutting Area**

2.1 Preparation of Cutter Plunger

This chapter describes the structures and types of the cutter plungers (cutter pens).

Cutter plunger nomenclature

The plotter cuts using a cutter blade mounted in a plunger. There are two different plungers to suit the diameter of the cutter blade to be mounted (the $\phi 0.9$ mm cutter plunger is provided as a standard accessory). Be sure to mount the cutter blade in the corresponding cutter plunger.

PHP33-CB09N-HS/PHP33-CB15N-HS

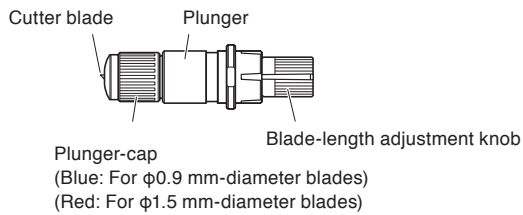

CAUTION

To avoid bodily injury, handle cutter blades with care.

Structure of cutter plunger

PHP33-CB09N-HS/
PHP33-CB15N-HS

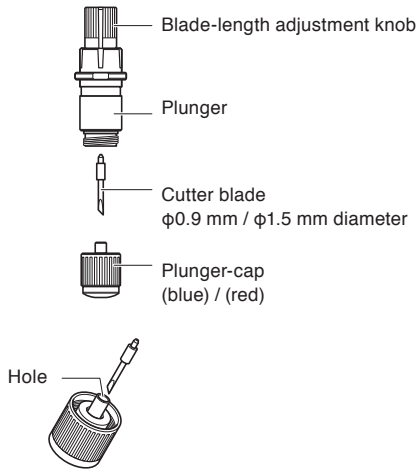

CAUTION

<PHP33-CB09N-HS/PHP33-CB15N-HS>

- Please fully insert the cutter blade straight into the plunger cap.

If the cutter blade cannot be inserted straight, please insert the cutter blade after pressing the insertion port of the cutter blade several times.

Insertion port of the cutter blade



If not installed correctly, it may result in damage to the cutter blade or the plotter itself.

Adjusting the blade length

Blade length needs to be adjusted to perform optimal cut. Perform few test cuts and set the optimal blade length.

CAUTION

- To avoid bodily injury, handle cutter blades with care.
- It may result in damaging the cutter blade or the cutting mat if the blade is extended too much. Make sure the blade length is set less than the thickness of the media.
After adjustment, please always perform "test cut".

Supplement

- See "Running Cutting Tests" for cutting tests.
- If a thin media such as a film is used, use the supplied magnifier to adjust it.

Adjust the blade length by turning the blade-length adjustment knob. Turn the knob in direction "A" to extend the blade, or in direction "B" to retract the blade. When the knob is turned by one scale unit, the blade moves approximately 0.1 mm. One full turn of the knob moves the blade approximately 0.5 mm.

PHP33-CB09N-HS/PHP33-CB15N-HS

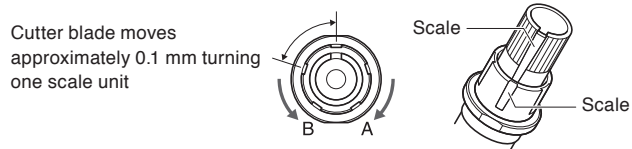

Blade application and features

Select the optimal cutter blade and medium to be cut.

Refer to the Cutter Blade Manual.

CAUTION

To avoid bodily injury, handle cutter blades with care.

2.2 Attaching a Tool

Attach a tool (cutter plunger, plotter pen) to the plotter.

Attaching a tool

When mounting the tool in the tool holder, please note the following.

- Push the tool all the way into the holder until its flange contacts the upper part of the holder and then tighten the screw firmly.
- To prevent injury, avoid absolutely touching the tool immediately after the cutting plotter is turned on or whenever the tool is moving.

It is explained here using cutter plunger as an example.

CAUTION

When pushing the tool holder with your fingers, the blade tip may be protruding. Take care not to cut your fingers.

Supplement

- When using with half cutting and plotter pen, set the seal in Tool Holder (backward), and when using cutting out (perforated cut), set the seal in Tool Holder (forward).
- Half cutting means that only the marking film is cut out, leaving the backing sheet uncut.
- Cutting out means that the media is cut out completely.
- Structure of Marking film

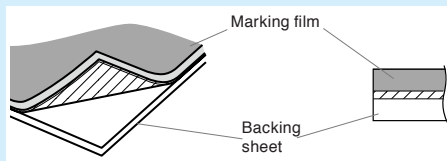

Mounting

- 1 Loosen the tool holder screw.

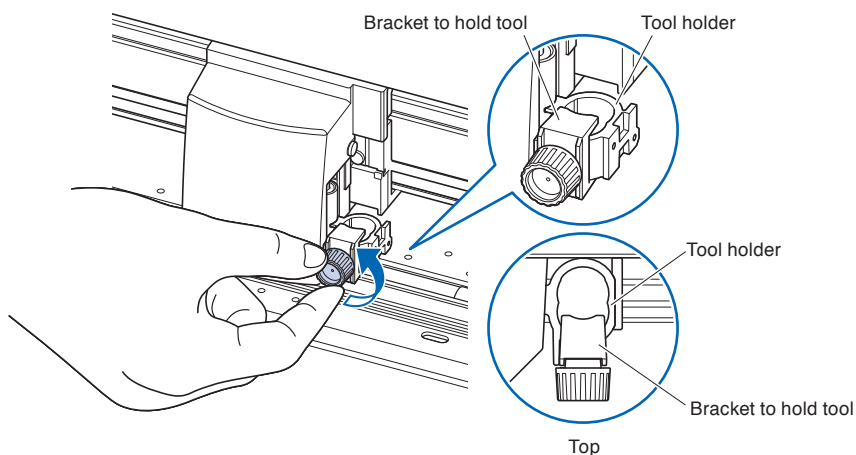

- 2 While pushing up the tool holder, push until its flange completely touches the upper part of the holder.

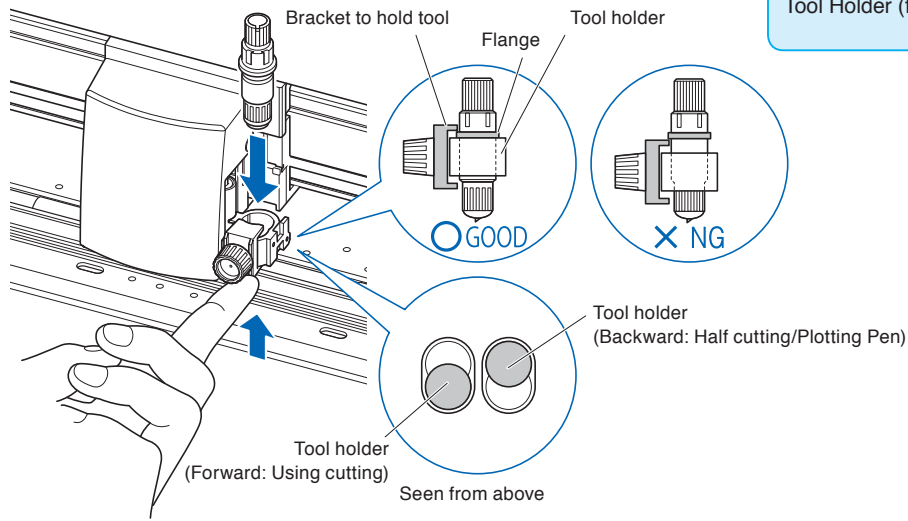

Supplement

When using with half cutting and plotter pen, set the seal in Tool Holder (backward), and when using cutting out (perforated cut), set the seal in Tool Holder (forward).

- 3 Make sure that the bracket is engaged on the tool's flange, and then tighten the screw.

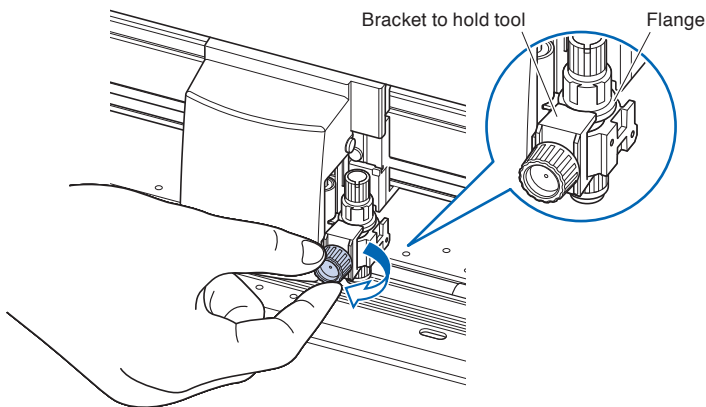

Removing the tool

When removing the tool, turn it counterclockwise to remove the tool.

2.3 Loading Media (Paper or Marking Film)

Both roll media and sheet media can be used with the CE7000. Load the media according to the instructions given for each type.

Use the grit roller on the right side of the media (looking from the front) as a guide when setting it in the media sensor. Afterwards, adjust the push roller so that it's lined up with the side of the media.

- Loading Roll Media
- Loading Sheet Media

Loading roll media (CE7000-40)

Operation

- 1 Lower the media set lever to raise the push rollers.

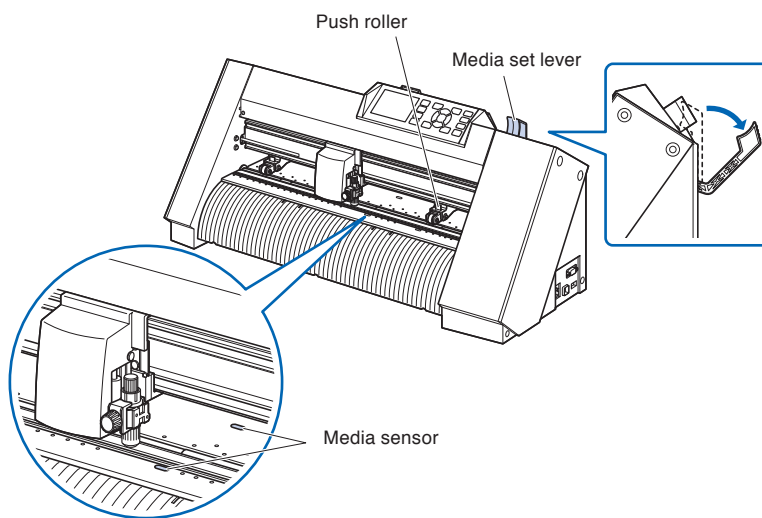

- 2 Put the roll media on the roll media tray and then push the tip of the roll media forward from the back of the machine. Make sure to pull it so that there is no slackening across the roll media's route.

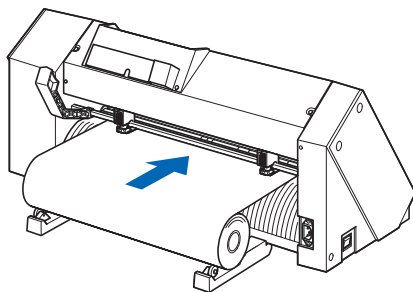

- 3 Push the tip of the roll media forward from the back of the CE7000. Make sure to pull it so that there is no slackening across the roll media's route.

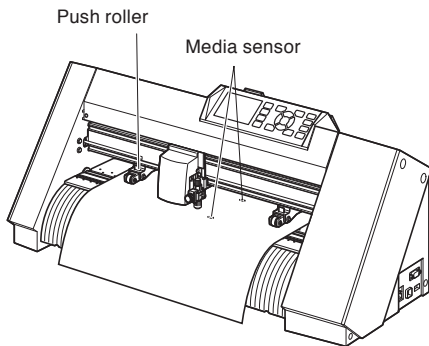

- 4 Position the media and the push rollers to correspond with the width of the media.
- The push rollers push down on either side of the media. Use the grit roller position guide to make sure the push rollers are set on top of the grit rollers.
- You can adjust the center push roller's hold-down force.

Supplement

- The media must always be positioned over the media sensor.
- See "Aligning the Push Rollers" for the position of the push rollers.

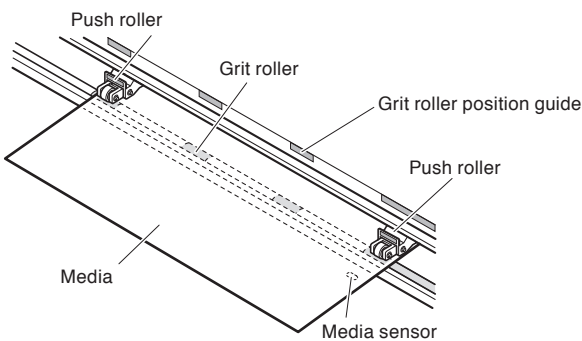

When feeding long media (2 meters or more)

Position the push rollers at least 15 mm inside the edges of the media.

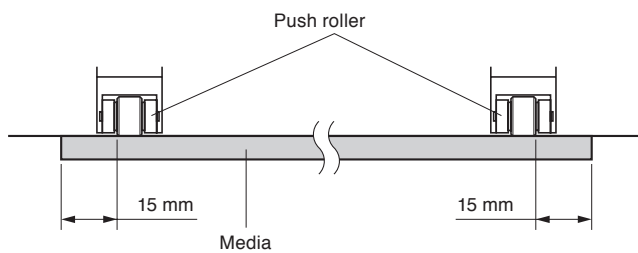

When feeding long media (2 meters or less)

Position the push rollers at least 5 mm inside the edges of the media.

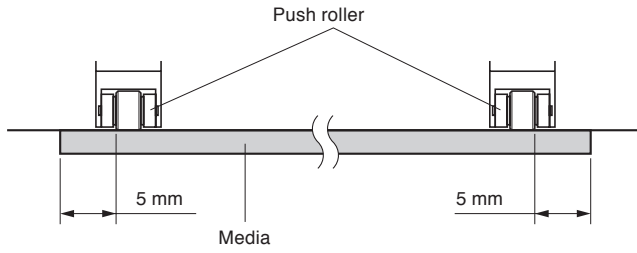

- 5 Pull the media taut to make sure that there is no slack in the conveyance path, and then raise the media set lever to lower the push rollers.

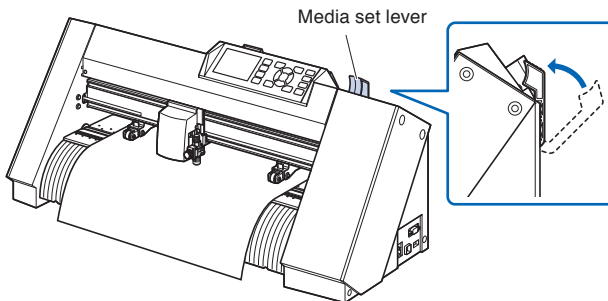

Create the same amount of slack in the media as will be used for the back of the machine.

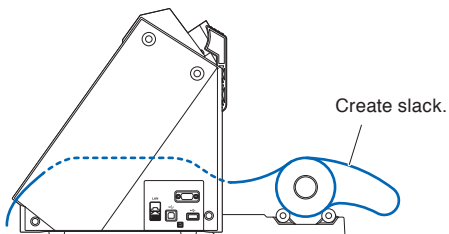

Loading roll media (CE7000-60/130/160)

This section explains in the CE7000-130.

Operation

- 1 Lower the media set lever to raise the push rollers.

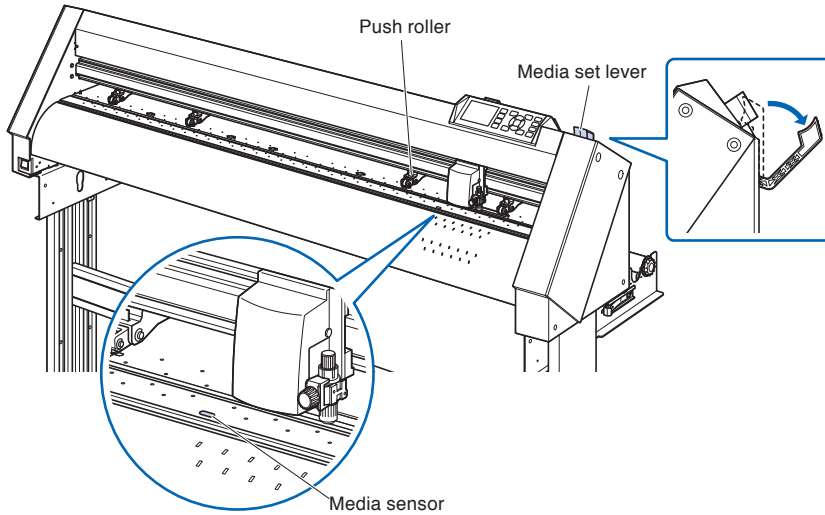

- 2 Set the roll media on top of the stock shaft, and then clip the roll paper with a stopper. Once it's set, tighten the stopper's screws.

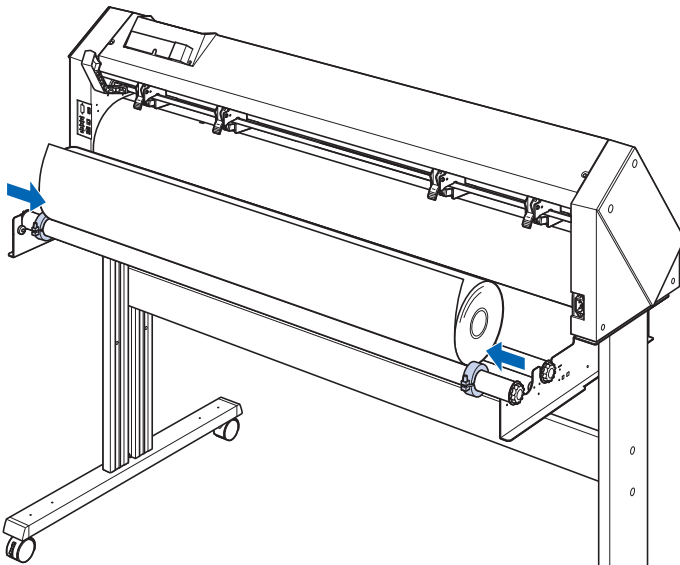

- 3 Push the tip of the roll media forward from the back of the CE7000. Make sure to pull it so that there is no slackening across the roll media's route.

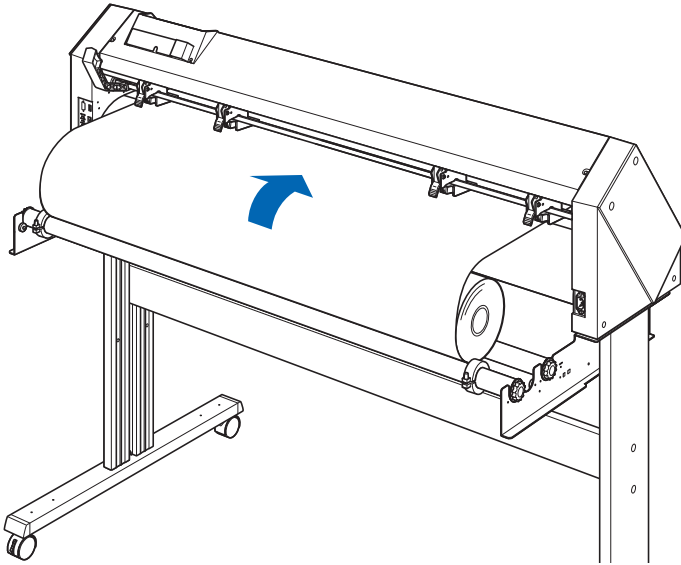

- 4 Lock the media stopper (Slide it backward.) and pull it out evenly so that the roll paper is straight. Please load so that the roll paper always rests on the media sensor.

Supplement

When actually cutting, please release the lock from the media stopper (While pulling the media stopper to the exterior, slide it forward.).

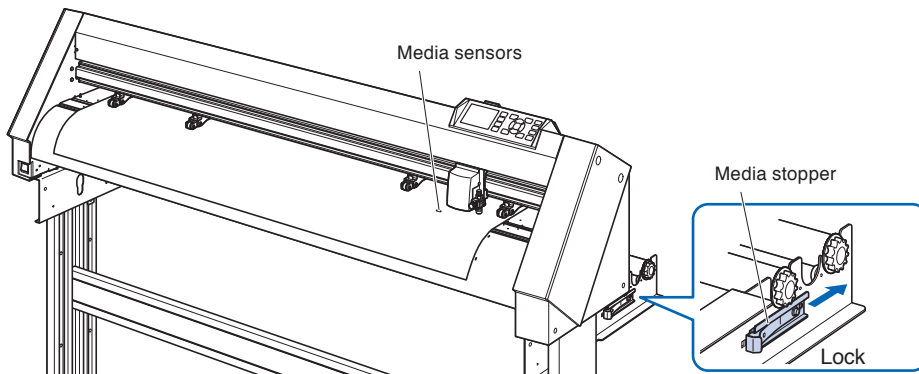

- 5 Position the media and the push rollers to correspond with the width of the media.

When using CE7000-60

The push rollers push down on either side of the media. Use the grit roller position guide to make sure the push rollers are set on top of the grit rollers.

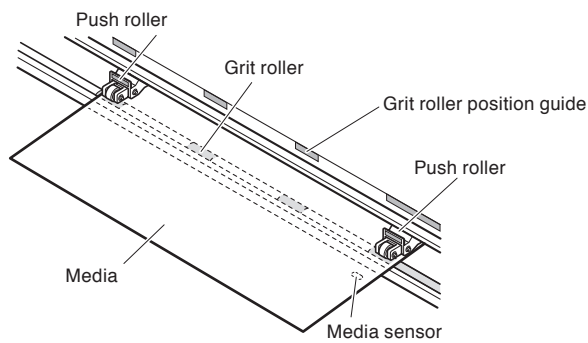

Supplement

- The media must always be positioned over the media sensor.
- See "Aligning the Push Rollers" for the position of the push rollers.

When using CE7000-130/160

Use the 4 push rollers to push down the sides and center of the media. Use the grit roller position guide and make sure the push rollers are on top of the grit rollers.

You can adjust the push roller's hold-down force.

Supplement

- The media must always be positioned over the media sensor.
- See "Aligning the Push Rollers" for the position of the push rollers.
- See "Aligning the Push Rollers" for information about push roller hold-down force.

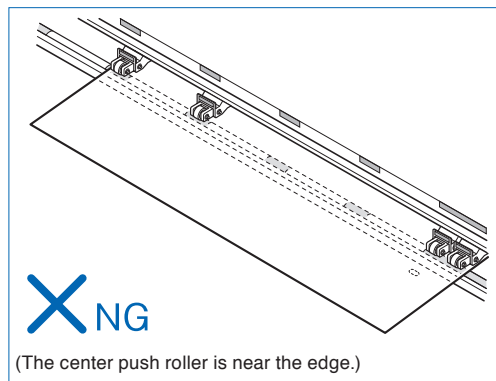
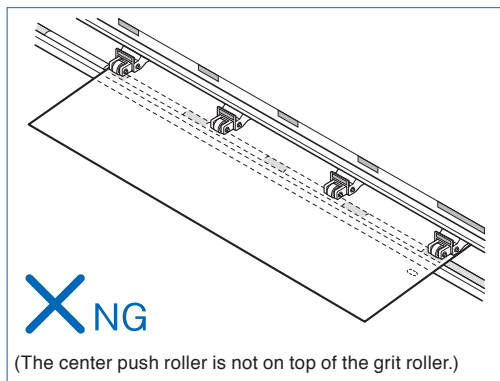
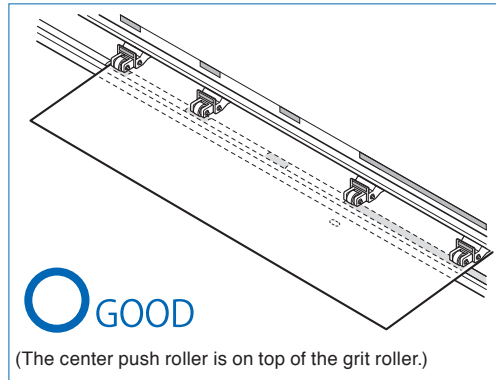
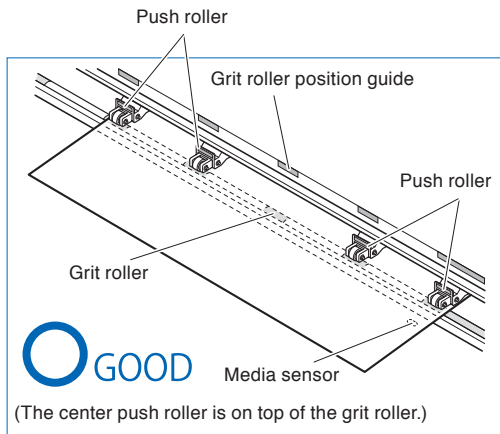

When feeding long media (2 meters or more)

Position the push rollers at least 15 mm inside the edges of the media.

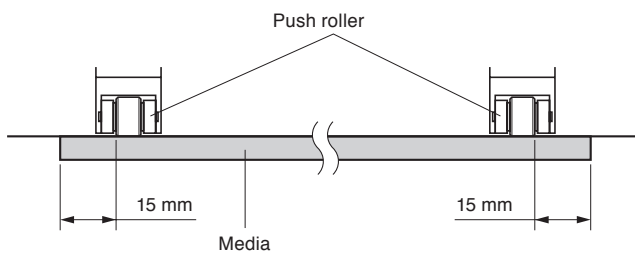

When feeding long media (2 meters or less)

Position the push rollers at least 5 mm inside the edges of the media.

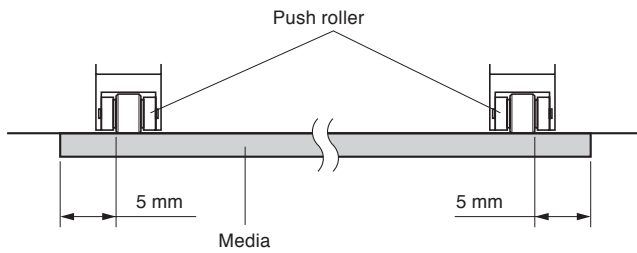

- 6 Pull the media taut to make sure that there is no slack in the conveyance path, and then raise the media set lever to lower the push rollers.

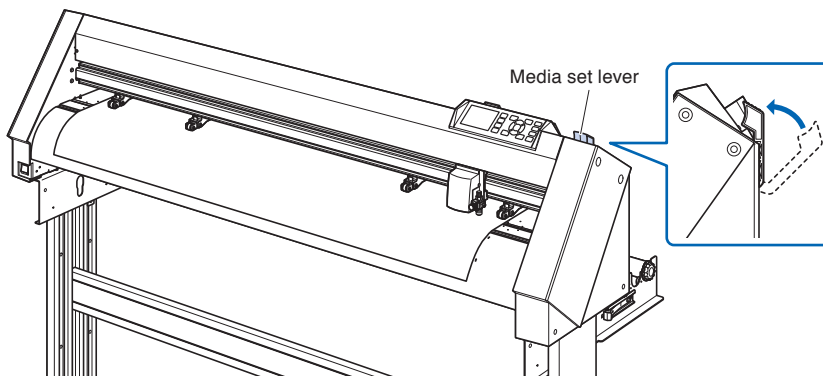

- 7 Release the lock from the media stopper (while pulling to the exterior, slide it forward).

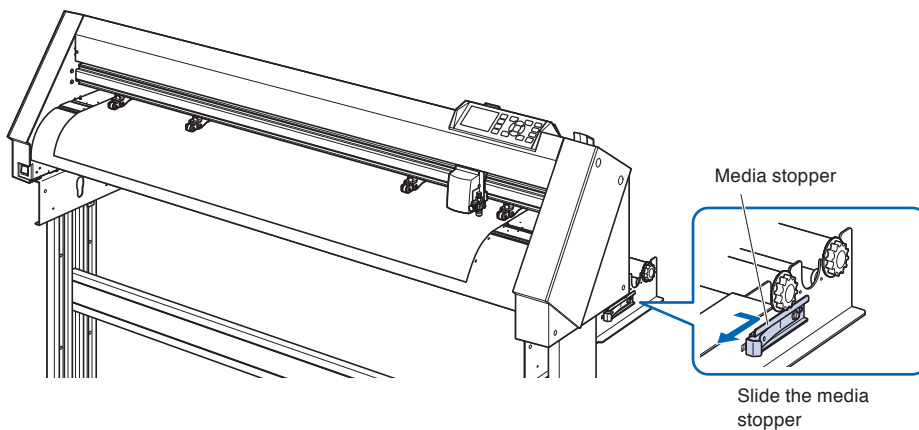

- 8 When the set lever is up (and the media is held down by the push rollers) and the media stopper is unlocked, pull out the roll media and give it slack.

Create the same amount of slack in the media as will be used for the back of the machine.

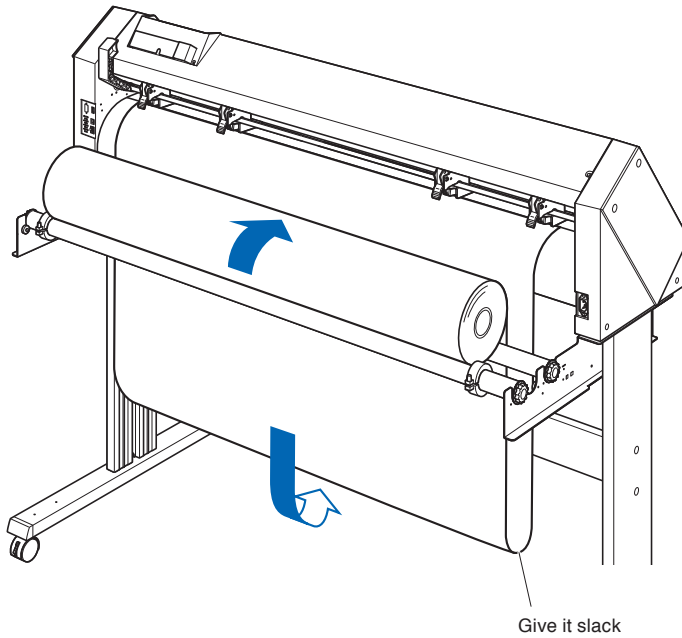

Supplement

- Dirt from the floor may stick to the media when giving it slack, so please be careful.
- During continuous operation with roll media, do not make a media slack at the rear of the cutting plotter.

Loading sheet media (CE7000-40/60)

This will be explained in CE7000-60.

Operation

- 1 Lower the media set lever to raise the push rollers.

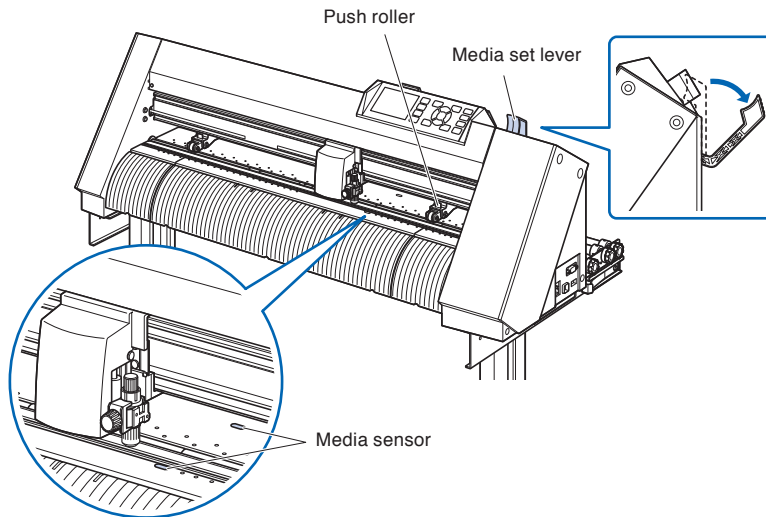

- 2 Set the sheet media so that the paper's edges line up with the guideline on the front side. Make sure that the sheet media completely covers the media sensor.

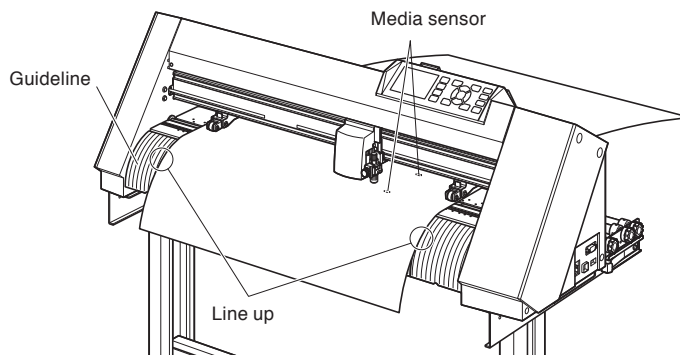

3 Position the media and the push rollers to correspond with the width of the media.

The push rollers push down on either side of the media. Use the grit roller position guide to make sure the push rollers are set on top of the grit rollers.

You can adjust the center push roller's hold-down force.

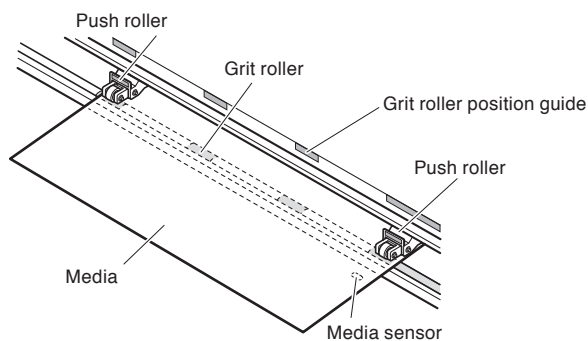

Supplement

- The media must be at least 125 mm in length.
- The media must always be positioned over the media sensor. (For the location of media sensor, see "Nomenclature".)
- See "Aligning the Push Rollers" for information about the position of the push rollers.

4 Pull the media taut to make sure that there is no slack in the conveyance path, and then raise the media set lever to lower the push rollers.

Set the sheet media so that the paper's edges line up with the guideline on the front side.

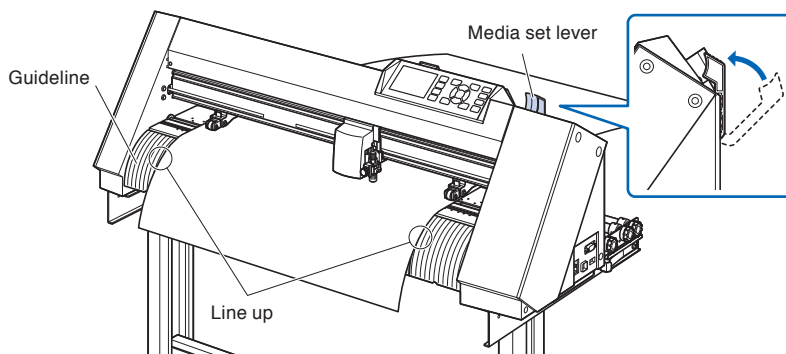

Loading sheet media (CE7000-130/160)

This will be explained in CE7000-130.

Operation

- 1 Lower the media set lever to raise the push rollers.

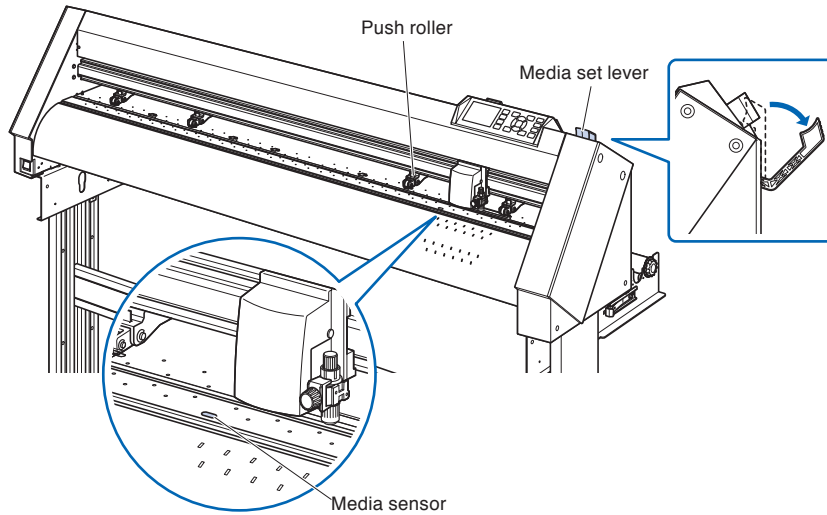

- 2 Make sure that the sheet media completely covers the media sensor.

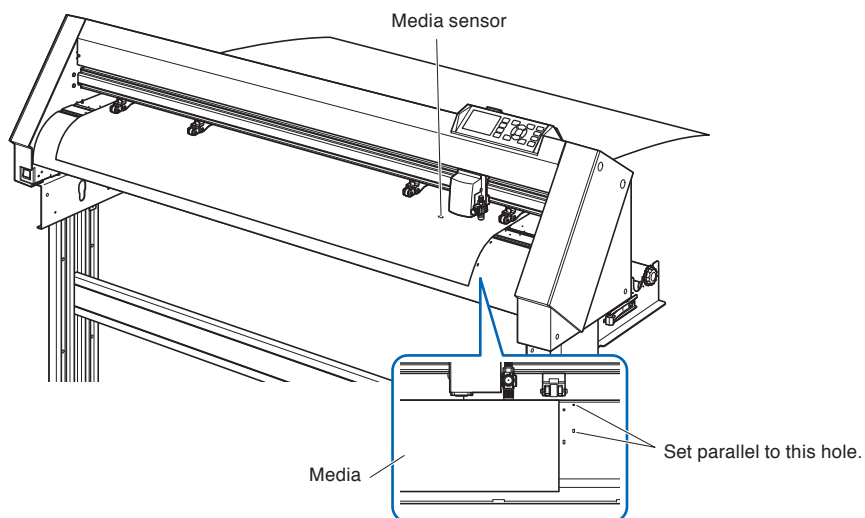

3 Position the media and the push rollers to correspond with the width of the media.

Use the 4 push rollers to push down the sides and center of the media. Use the grit roller position guide and make sure the push rollers are on top of the grit rollers.

Use the grit roller position guide and make sure the push rollers are on top of the grit rollers.

You can adjust the center push roller's hold-down force.

Supplement

- The media must always be positioned over the media sensor.
- See "Aligning the Push Rollers" for information about the position of the push rollers.
- See "Aligning the Push Rollers" for information about push roller hold-down force.

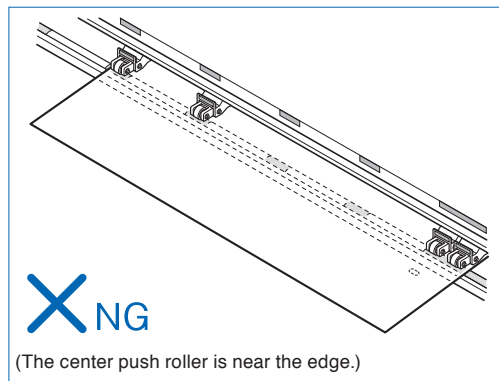
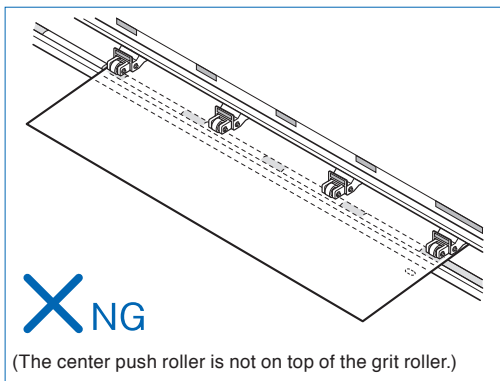
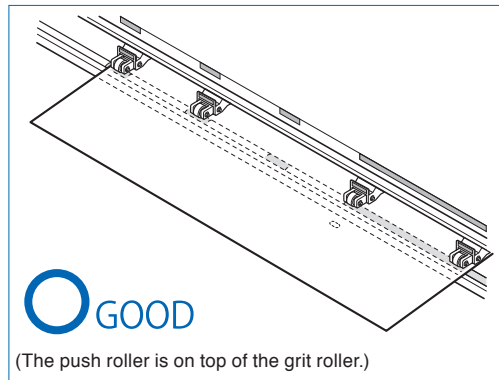
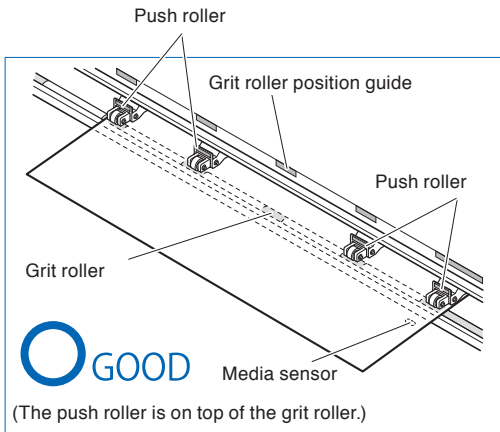

- 4 Set straight parallel to the hole of the guide.
Raise the set lever to fix the position of the push roller and the sheet media.

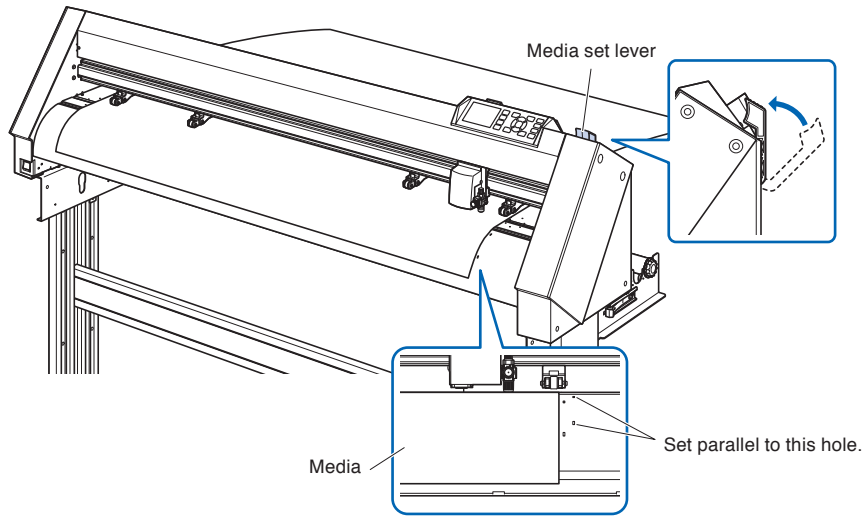

Carrier Sheet (for Affixing Media for Cutting)

Using the carrier sheet (CR09300-A3) enables designs to be cut out of the following media types:

- Media without an adhesive liner (peel-off backing sheet)
- Media without a backing sheet
- Media that is smaller than A3 size
- Only CE7000-40/60 supports it.

Usage Precautions

- Be sure to use the carrier sheet when cutting around a printed design on the medium to create a cutout.
- The carrier sheet is a reusable adhesive sheet that can be used repeatedly. However, if the carrier sheet become warped or loses its adhesive strength, it can no longer be used. In such cases, please replace it with a new carrier sheet. As a guideline, replace the carrier sheet after cutting 10 sheets. The cutting quality when the same carrier sheet is used for cutting more than 10 sheets is not guaranteed.
- When affixing a medium to the carrier sheet, be sure to press down on it firmly to ensure that it does not float up or peel away from the carrier sheet.
- Make sure that media affixed to the carrier sheet has very little curl. A strongly-curved medium may cause registration mark reading errors to occur, and it may get caught up in the pen carriage.
- Affix only Graphtec-specified media to the carrier sheet. If using commercially-available inkjet media, please note that media that is coated on both sides cannot be used. If the media is coated on one side only, affix the non-coated side to the carrier sheet. If the coated side is affixed, the carrier sheet's adhesive strength will be weakened and may make the carrier sheet unusable.
- If very smooth paper (paper that does not feel rough to the touch) is affixed to the carrier sheet, it will tend to curl up when removed from the carrier sheet. Do not use such media.
- When removing a medium from the carrier sheet after cutting it, be sure to remove it slowly and carefully.
- The adhesive surface of the carrier sheet absorbs moisture easily. To prevent this occurring, do not remove the carrier sheet from its package until just before use.
- After use, reattach the separator that was removed from the adhesive surface prior to use, and then return the carrier sheet to its package for storage.
- For optimum storage, avoid locations where there is high humidity or where the package will be exposed to direct sunlight.
- There may be cases in which thin materials such as copy paper can no longer be peeled or torn.

Loading the Medium

How to load a medium with a width of less than 297mm

- 1 Peel off the separator (yellow) from the carrier sheet to expose the adhesive surface. (Do not discard the separator, as it will be used again when the carrier sheet is returned to its package for storage.)

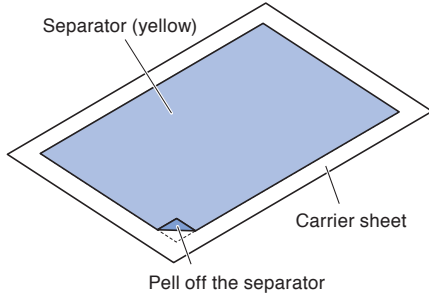

- 2 Affix the medium for cutting to the adhesive surface of the carrier sheet, making sure that the edges of the medium are parallel with those of the carrier sheet.

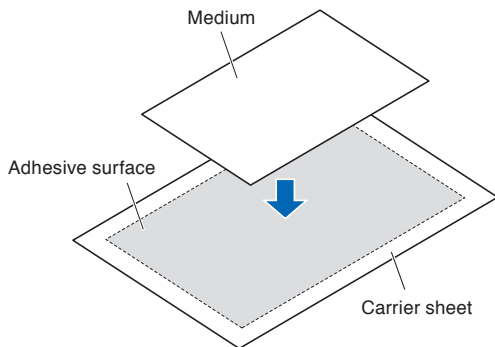

Supplement

- Do not use media that is smaller than postcard size.
- When affixing the medium, take care not to cause any air bubbles or creases.

Effective Cutting Area

- 1 The effective cutting area on the carrier sheet is shown in the diagram below. When loading a medium that is smaller than A3 size in the cutting plotter, be sure to affix it within the cutting area (the adhesive surface). Moreover, make sure that the edges of the medium are parallel with the edges of the carrier sheet.

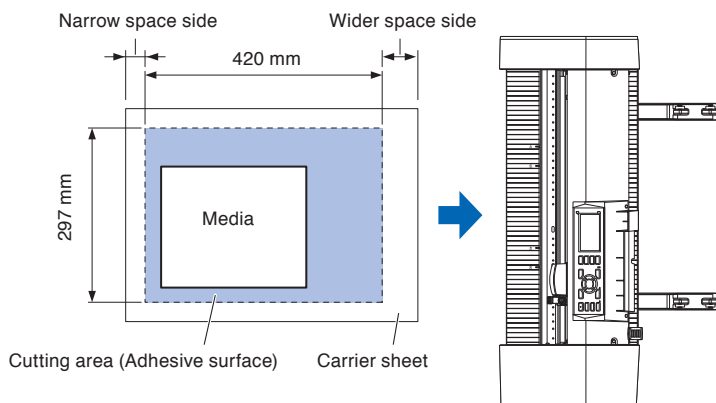

Supplement

- Do not use media that is smaller than postcard size.
- The cutting plotter recognizes the width of the carrier sheet as the cutting area. Be sure to load a medium that is the same size as the media setting that was made in the application software.
- Be sure to use the (ORIGIN) key to specify the start position of the cutting operation.

Mounting the Carrier Sheet Table (Option: OPH-A45)

- 1 Mount the carrier sheet table to the front and back of the cutting plotter.

Insert the projection under the carrier sheet table into the dent part for each the model.

("40" for CE7000-40 and "60" for CE7000-60)

(The figure below is the CE7000-40.)

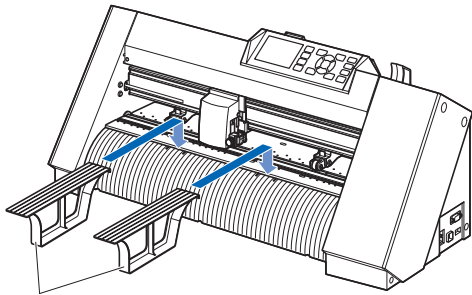

Carrier Sheet Table

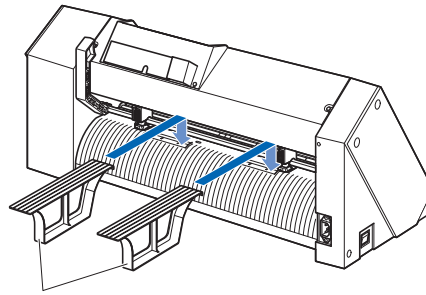

Carrier Sheet Table

Setting method of carrier sheet (Carrier Sheet Table: Option)

- 1 When setting the carrier sheet, insert it so that the narrowest margin (transparent part) of the carrier sheet is at the top, and make sure that the carrier sheet is in front of the cutting plotter as shown in the figure.

Make sure that the carrier sheet does not come out behind the cutting plotter.

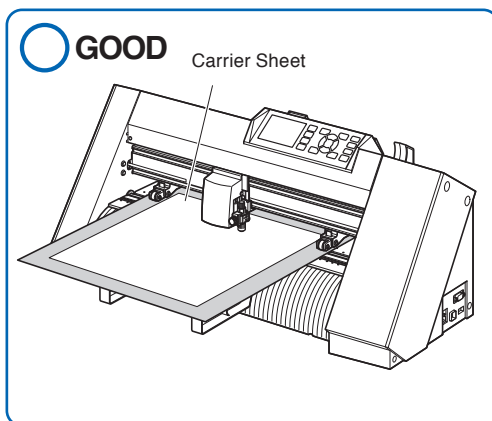

GOOD Carrier Sheet

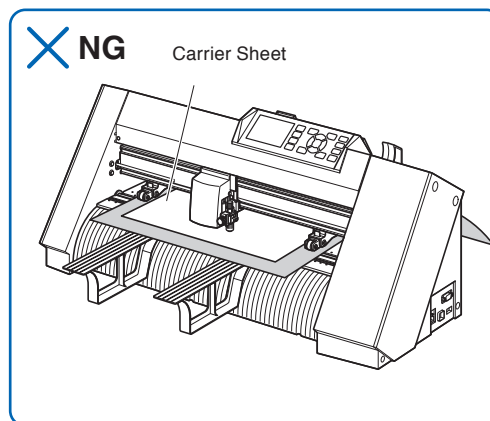

NG Carrier Sheet

Set it so that the right edge of the carrier sheet aligns with the guidelines on the front guide.

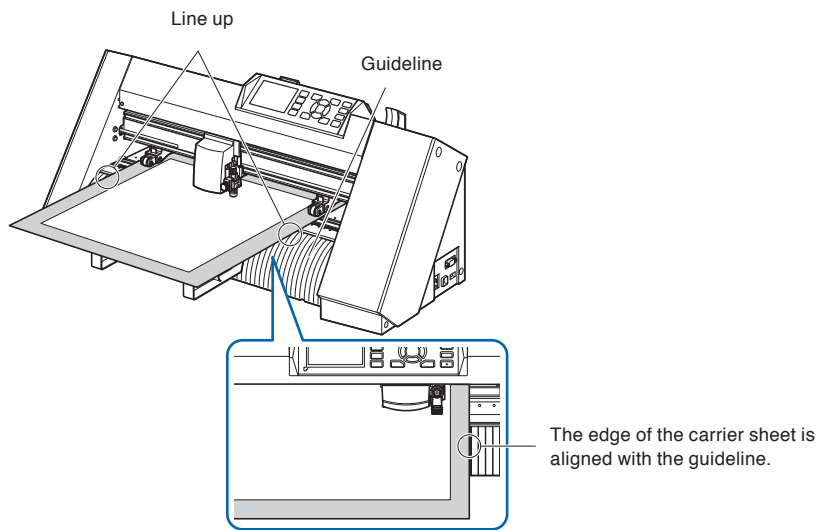

- 2 When the set lever is raised, the push roller lowers and the carrier sheet is fixed.

2.4 *Aligning the Push Rollers*

This section describes how to alignment of the push rollers.

Aligning the push roller

Position the left and right push rollers to correspond with the width of the media. Adjust the push rollers so that they are positioned above both the media and the grit rollers.

Positioning the push rollers within the grit roller position guides ensures that they are above the grit rollers.

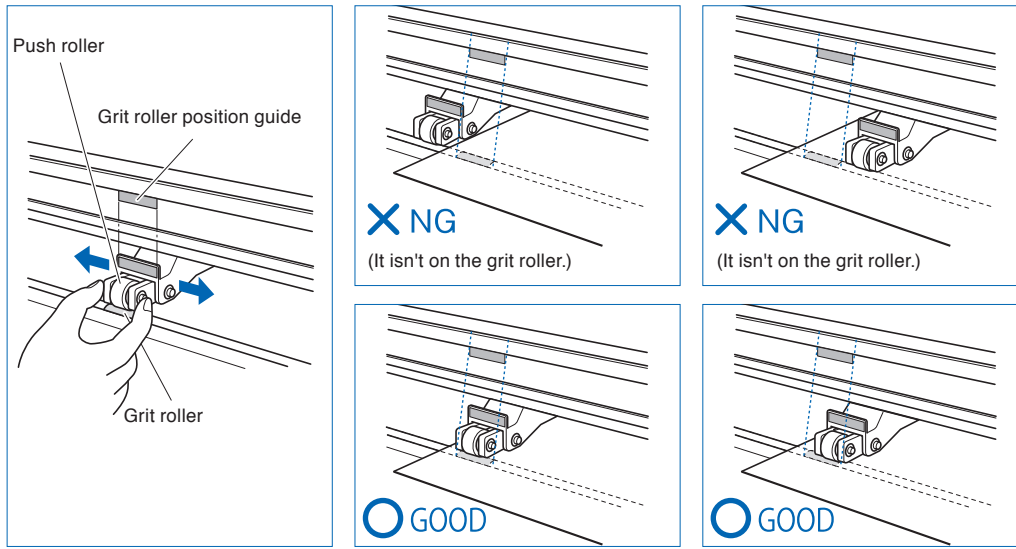

CAUTION

To move the push rollers, the media set lever must be in the lowered position.

Supplement

If a [confirming push roller point] message appears after setting the media and raising the media set lever, it means the right push roller is not on the right grit roller, or that the left or center push roller is not on the proper grit roller. Make sure everything is set correctly.

When feeding long media (2 meters or more)

Position the push rollers at least 15 mm inside the edges of the media.

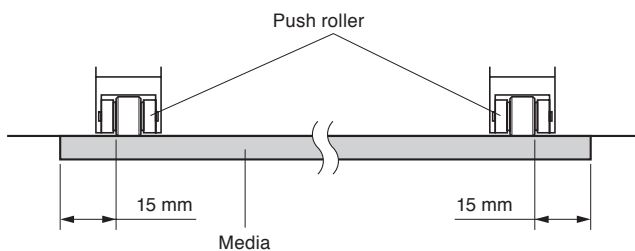

When feeding long media (2 meters or less)

Position the push rollers at least 5 mm inside the edges of the media.

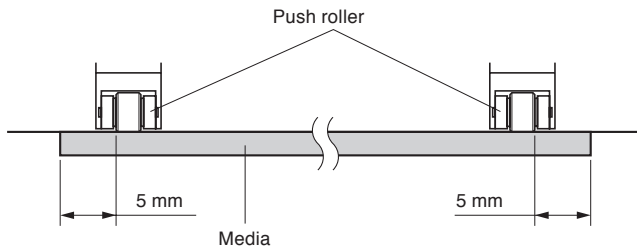

When narrow media (160 mm or less) is used

Make sure that all push rollers are on the long right grit roller. Use the left side of the grit roller as a starting point and then set the push rollers so that they're on both sides of the media.

The CE7000 can take media width of 50 mm or more.

* When using CE7000-130/160, set it to "NARROW(160MM OR LESS)" in "ADVANCE" - "MEDIA WIDTH".

Please use only 2 push rollers on the right side. The hold-down force switching of the third and subsequent push rollers should be set to be Low (OFF) and not on the grit roller. (The push roller position is not detected.) Please set the same hold-down force of the push roller to be used. Move the third and subsequent push rollers away from the media position.

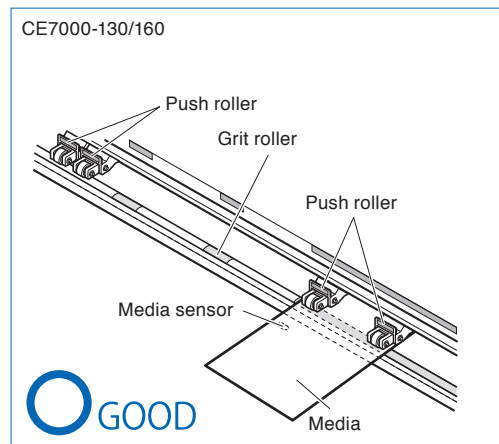
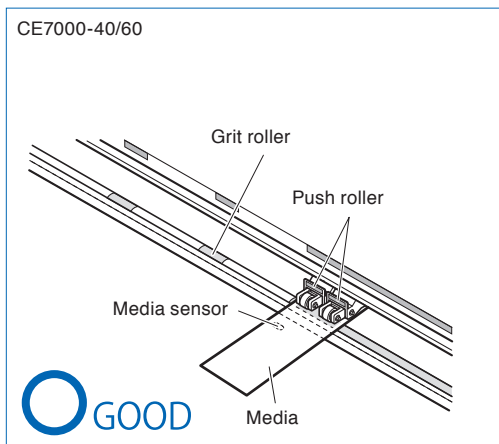
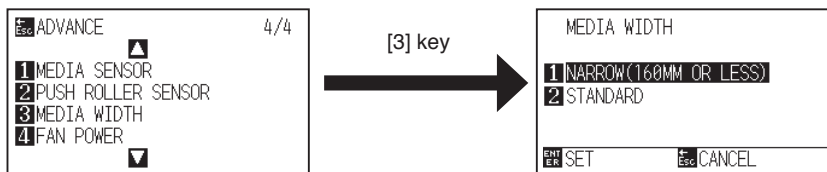

CAUTION

- The media must be at least 125 mm in length in media feed direction.
- The media must always be positioned over the media sensor.

Changing the hold-down force

The CE7000 requires the push roller hold-down force to be set based on the media's width and material type in order to keep the media in place.

(CE7000-130/CE7000-160 only)

Switching

- (1) Raise the media set lever to lower the push rollers.
- (2) Use the push roller hold-down force switching lever on the back of the push roller to adjust the center push roller's hold-down force. It can be set to Strong, Medium or Low (OFF).
- (3) When the push roller hold-down force switching lever is lower, it is in Strong mode. When it is upper it's in Low (OFF) mode.

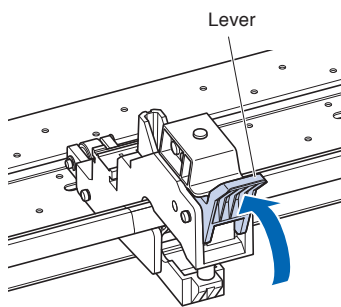

Hold-down force: Low (OFF)

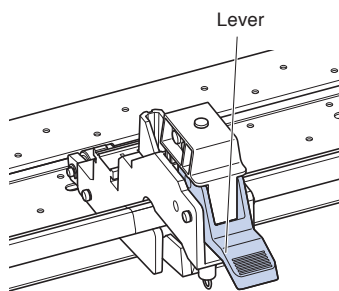

Hold-down force: Medium

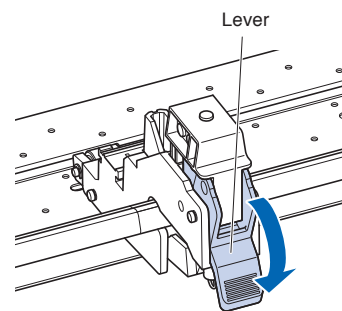

Hold-down force: Strong

CAUTION

- Please switch the hold-down force of the push rollers at both ends to Strong or Medium and keep the same hold-down force.
- If the hold-down force is changed with the media set lever lowered, the lever operation will be heavier. Always raise the media set lever and then change the hold-down force.

Supplement

- Low (OFF) of hold-down force is the standard setting for cutting thin film like car film.
- Switch the hold-down force as necessary for different types of media.

Assignment

The hold-down force of push rollers on both ends (left/right) should set to the same force in Strong or Medium. However, when using three or more push rollers, set the hold-down force of the push rollers inside both ends to lower than both ends.

When using two push rollers

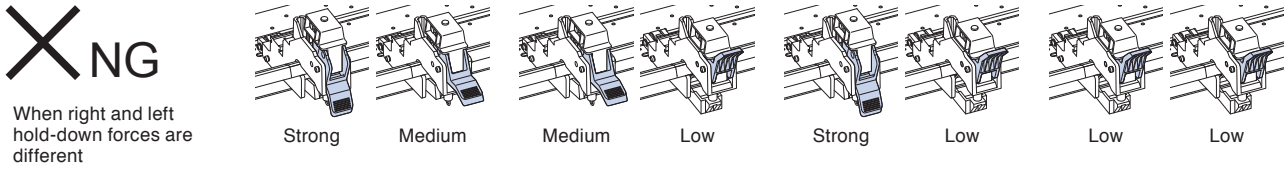
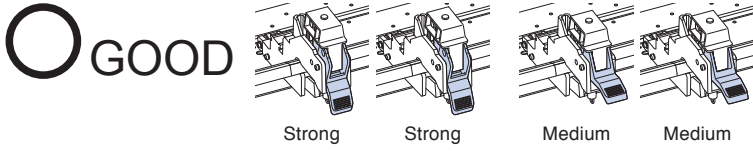

When using four push rollers

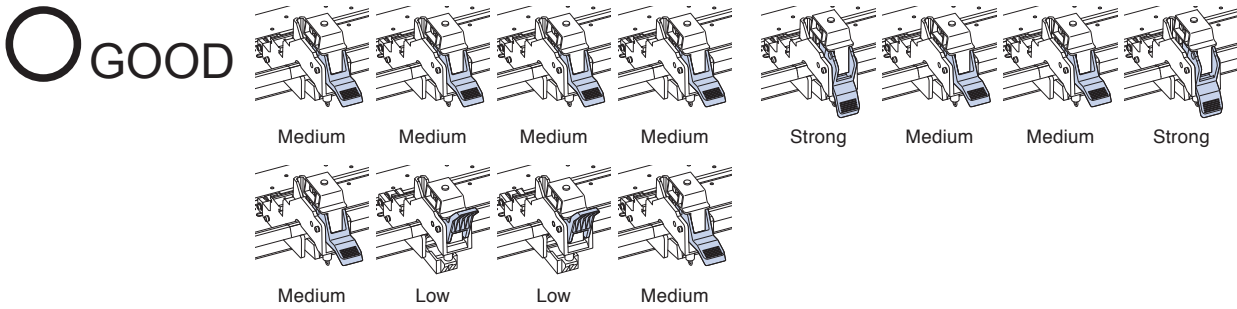

2.5 About the Default Screen

The Initial Setup Screen appears only when powering up the machine for the first time after purchase. Here, you can set the display language and length unit.

Also, after setup, you can select the menu even from the READY status.

See "Display Language Setting (LANGUAGE SELECTION)" and "Display Length Unit Setting (LENGTH UNIT)" in Chapter 10".

See "2.6 Connecting to the Power" for turning on the power.

Operation

- 1 Once the machine is powered on (with the "I" switch) a message will be displayed after the version is displayed.

▶ Here, LANGUAGE setting screen is displayed.



- 2 Use the POSITION (▲▼◀▶) keys to select the language.
(This manual assumes you chose the English language setting.)

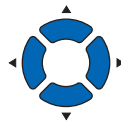

- 3 Press the [ENTER] key.

▶ After the DISPLAY LANGUAGE is selected, the LENGTH UNIT screen will appear.

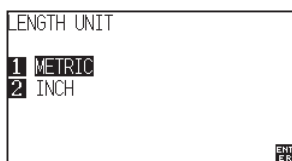

- 4 Press the [1] key (METRIC) or the [2] key (INCH) to select the length unit setting.

- 5 Confirm the setting and press the [ENTER] key.

▶ Setting will be confirmed and it will return to default screen.

2.6 Connecting to the Power

Turning on the power of the plotter.

Operation

- 1 Check that the power switch is turned off. (the "O" side is pressed down)

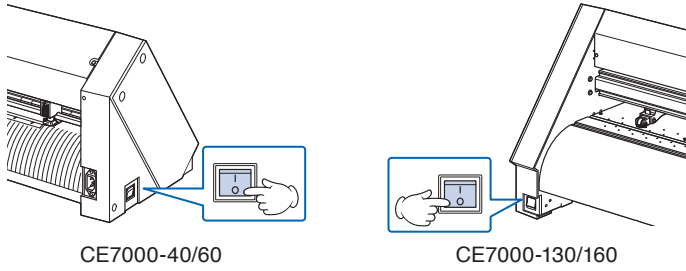

- 2 Connect one end of the provided power cord to the CE7000 AC line inlet and the other end to an electrical socket of the rated supply voltage.

* The figure below is CE7000-130.

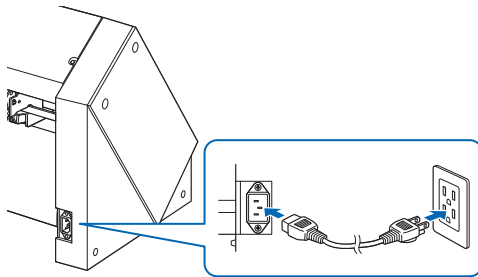

- 3 Turn on the CE7000 by pressing the "I" side of the switch. LCD on the control panel is lit.

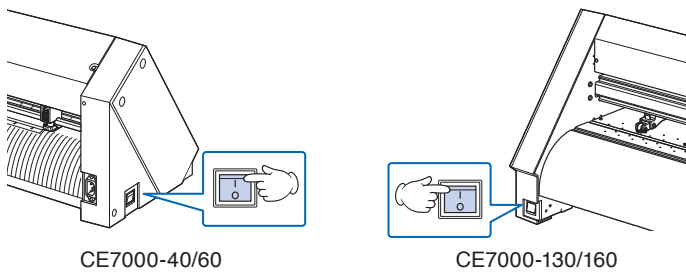

Supplement

When turning the power off, wait over 20 seconds before turning it on again, otherwise problems may occur with the display.

- 4 If media has not been loaded, the firmware version number is displayed, followed by a prompt to load media.

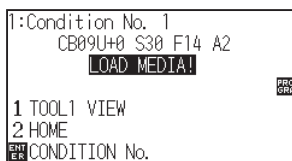

Media set lever raised
(The push roller is up)

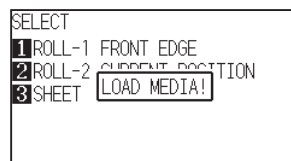

Media set lever lowered
(The push roller is down)

Supplement

- The Default Screen will appear after purchasing the machine. See "About the Default Screen" for more information.
- This screen is described as "default screen" in this document.
- Settings such as initial media feed speed and communication conditions can be performed.

2.7 How to Use Control Panel

This section explains the function of lamps and keys on the control panel.

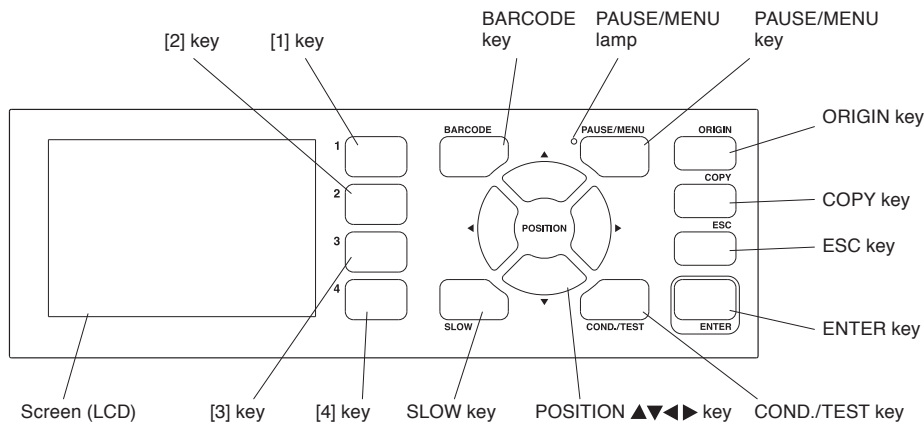

Indicator lamp

PAUSE/MENU lamp

..... When in MENU mode, the lamp lights up.

Operation key

BARCODE The continuous operation of data link is started.

PAUSE/MENU Switches to the MENU mode.

It will go into MENU mode if it is pressed once, and MENU mode will be turned off when it is pressed again.

Different function are set in the MENU mode.

When the PAUSE/MENU key is pressed during the operation, the cutting/plotting operation stops.

ORIGIN It will set the current position as an origin point.

On the READY screen, pressing the [ENTER] and [ORIGIN] keys at the same time will allow you to reset the machine. (Only in Normal mode)

COPY Copy of data in the buffer memory is output.

ESC Cancels the setting change and then returns to the previous screen. Returns to the previous screen in the MENU screen.

ENTER Saves the settings, and then returns to the setting screen in various function or CONDITION setting screen of the MENU screen.

On the READY screen, pressing the [ENTER] and [ORIGIN] keys at the same time will allow you to reset this machine.

COND./TEST Displays the screen to set the tool conditions.

Use this when checking tool conditions to activate a cutting test.

SLOW When pressing the POSITION key at the same time, the tool carriage moves slowly.

When the "SLOW" icon is displayed on the screen, it works as a menu key.

When the [SLOW] key is pressed in the READY screen, the current cutting/plotting area and the position of tool carriage are displayed.

1, 2, 3, 4 Select the menu number displayed in the screen.

POSITION (▲, ▼, ◀, ▶) key

..... Adjusts various settings, selects numerical value changes, moves the cursor, and changes the positions in the MENU screen.

Reading the screen (LCD)

Information reflecting the status will be displayed in the screen of the control panel.

Name of the button and corresponding function are displayed on the screen when a function is allocated to the button on the control panel. Button name will be displayed in reverse when the button is enabled.

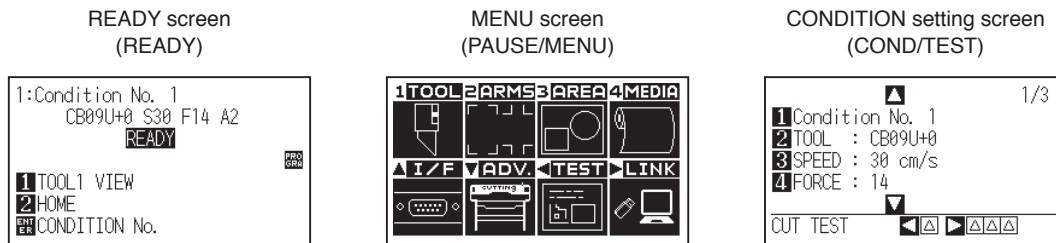

Media set lever raised

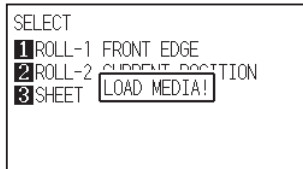

Media set lever lowered

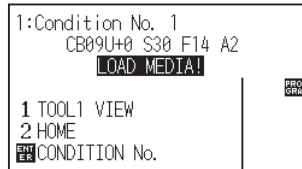

Set condition of media (READY status:
It will display "READY" when the media is loaded)

Tool conditions currently used

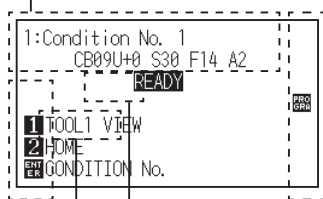

User number

Tool number currently used

Corresponding button name of control panel
(Valid button is displayed in reverse)

Display of setting condition

		Command	: GP-GL	: GP-GL Command
			HP-GL	: HP-GL Command
			(No Display)	: Command Auto
				Step size
				: 0.1 : 0.1mm
				: 0.05 : 0.05mm
				: 0.025 : 0.025mm
				: 0.01 : 0.01mm
				Rotate/Mirror
				: R90 : Rotation (Rotate 90°)
				: Mir : Mirror
				: R90 Mir : Mirror and Rotate
				Priority
				: MANUL : Manual priority
				: PROGRA : Pogram priority
				Sort
				: Sort ON : Display when sort is on
				Prefeed
				: Pre FEED : Display when automatic media feed is onMedia

Default screen (Ready Screen): READY

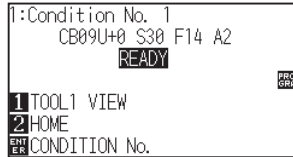

Display of Default Screen (Normal mode)

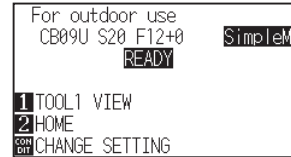

Display of Default Screen (Simple mode)

The condition number (Cut Condition) that has been set is displayed.

Supplement

- In this manual, this screen is referred as READY screen or READY status.
- In this READY status, you can set the cutting and communication conditions by pressing [PAUSE/MENU] or [COND/TEST] key.

Screen to set the corresponding conditions is displayed when the [PAUSE/MENU] key or [COND/TEST] key are pressed.

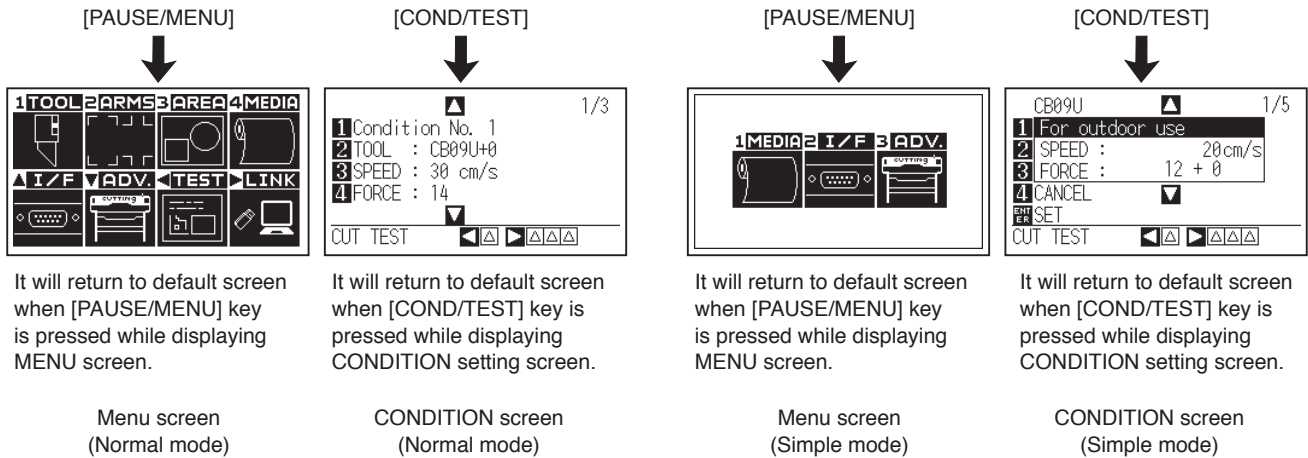

Page number is displayed in the upper right corner of the screen if there are too many settings or selection that will need multiple pages to display.

Press the POSITION (▲▼) keys to move to different page.

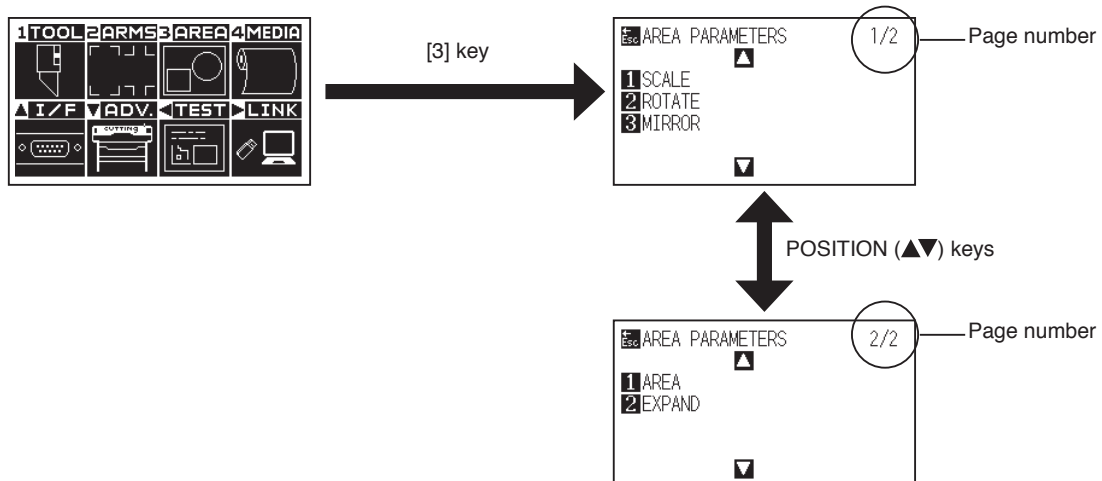

Example of moving page and operation button (Normal mode)

Icon of the corresponding operation button is displayed in the screen to change the setting values.

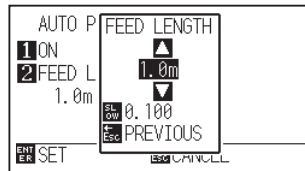

Increase or decrease the setting value using POSITION (▲▼) keys.
Select the change unit by [SLOW] key.

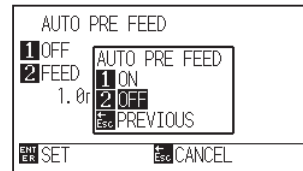

Select the setting by number keys (1, 2, 3, 4).

Example of screen to change the settings value

Contents of Operation from MENU Screen

In [Simple mode] on the ADVANCE (ADV.) menu, switch between Simple mode and Normal mode.
In Normal mode, you will be able to change more detailed settings.

Simple mode and Normal mode are independent from one another. The settings of the mode you're currently in will take precedence.

Simple mode

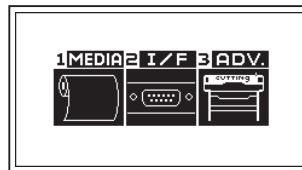

Menu screen
(Simple mode)

Contents of the operation and settings that is displayed in MENU screen with [PAUSE/MENU] key are as following:

- [1] (MEDIA) : Set the setting of the condition for the media.
- [2] (I/F) : Set the settings of the condition for the interfacing with the computer.
- [3] (ADV.) : Set the conditions for the basic operation of the cutting plotter, such as display language and unit of length.
- [PAUSE/MENU] : MENU screen will be closed and return to default screen.
- [SLOW] : Displays the position key screen. When media is set, the tool point can be moved

See the "Menu Tree" in the Appendix A.4 for list of the descriptions about each settings.

Normal mode

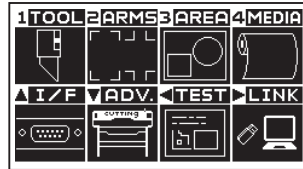

Menu screen
(Normal mode)

Contents of the operation and settings that is displayed in MENU screen with [PAUSE/MENU] key are as following:

- [1] (TOOL) : Set the setting for the operation of the tool.
- [2] (ARMS) : Perform settings and operations related to alignment of tool and media, such as automatic registration mark scanning by ARMS.
- [3] (AREA) : Set the settings for area, scale, rotation, reverse, etc., of the cutting.
- [4] (MEDIA) : Set the setting of the condition for the media.
- [▲] (I/F) : Set the settings of the condition for the interfacing with the computer.
- [▼] (ADV.) : Set the conditions for the basic operation of the cutting plotter, such as display language, unit of the measurements and sensor.
- [◀] (TEST) : Does the operation necessary for maintenance, such as self diagnostic test or printout of the condition settings list.
- [▶] (LINK) : Performs operations necessary for output such as data link.
- [PAUSE/MENU] : MENU screen will be closed and return to default screen.
- [SLOW] : Displays the position key screen. When media is set, the tool point can be moved

See the "Menu Tree" in the Appendix A.4 for list of the descriptions about each settings.

Operation from [COND/TEST] key

Simple mode

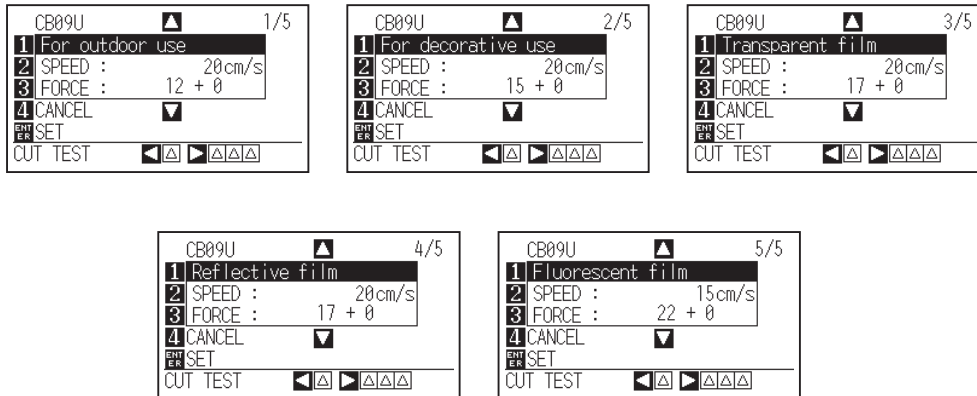

CONDITION screen (1-5): (Simple mode)

The [COND/TEST] key brings up the SETTING screens, where you can change the media type and tool conditions.

The preset cutting condition is used when the media type is selected.

[COND/TEST] : This will clear the CONDITION screen and return to default screen.

See "Selecting Tool Condition" for the detailed tool condition.

Normal mode

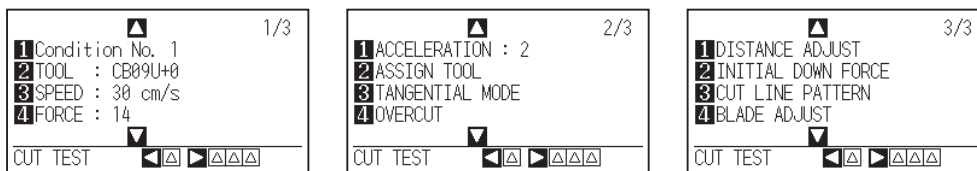

CONDITION screen (1-3) : (Normal mode)

The [COND/TEST] key brings up the SETTING screens, where you can change the media type and tool conditions.

Up to 8 CONDITION settings can be saved with different settings in numbers 1 through 8.

[COND/TEST] : This will clear the CONDITION setting screen and return to default screen.

See "Selecting Tool Condition" for the detailed tool condition.

2.8 Setting Feeding Method

Feeding method for the loaded media is set.

Operation

- 1 If you have already loaded the media, the MEDIA TYPE menu appears. Select the media type to suit the loaded media.

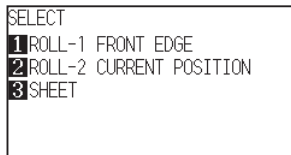

Check that the media stopper is unlocked (CE7000-60/CE7000-130/CE7000-160) and then select a media type on the MEDIA SELECT screen.

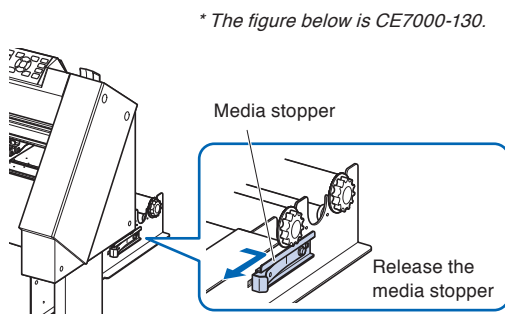

CAUTION

Before doing the media set selection, make sure to release the media lock.

Supplement

- The CONTINUE menu parameter appears when the media set lever is raised and then lowered again after media was previously loaded, making it possible to select the previous settings.

When pressing the [4] key to select "CONTINUE".

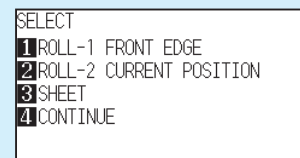

When using the same media without changing the position of the media, the CONTINUE function enables the continued use of the plotting area, pen position and origin position that were specified before the media set lever was lowered. If the current media is the same size as the last media that was loaded, the plotter does not detect the media's edges.

When selecting [ROLL-1 FRONT EDGE] pressing the [1] key

Select this when you have loaded a roll media and you wish to start cutting or plotting from the leading edge.

The width and leading edge of the roll media are detected.

When selecting [ROLL-2 CURRENT POSITION] pressing the [2] key

Select this when you have loaded a roll media and you wish to start cutting or plotting from a point beyond the leading edge.

Only the width of the roll media is detected.

When pressing the [3] key to select [SHEET]

Select this when a cut sheet has been loaded. The width, leading edge, and trailing edge of the sheet are detected.

2 After the media is detected, the plotter is ready to receive data for cutting or plotting. This status is called "READY status" of the default screen.

When setting is finished, the tool carriage's location will become the initial point.

If the interface or command settings have not been made, make these settings before sending the data.

If the settings have been made, tool adjustment is performed.

When the pen adjustments have been made, the plotter is ready to start cutting.

Send the cutting or plotting data from the application software.

▶ Default screen is displayed.

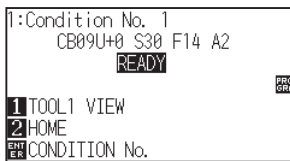

Menu screen
(Normal mode)

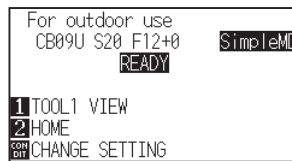

Menu screen
(Simple mode)

Supplement

The screen below shows that the plotter is currently detecting media.

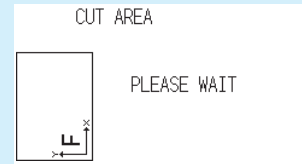

2.9 Pre Feed of Media (Paper or Marking Film)

The PRE FEED function is used to prevent the loaded media from slipping by automatically advancing the media the specified length and imprinting it with grit roller marks. This function can also be used to acclimate long media lengths to the operating environment in order to minimize media expansion and contraction, and to ensure stable media feed operations.

When performing plotting/cutting longer than 2 m in CE7000-60/130/160, be sure to use a basket (option).

Operation

- 1 Press the [PAUSE/MENU] key in READY status.

▶ MENU screen is displayed.



- 2 Press the [4] key (MEDIA).

▶ MEDIA SETING screen (1/2) is displayed.

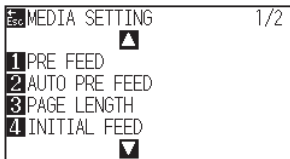

- 3 Press the [1] key (PRE FEED).

▶ FEED LENGTH setting screen is displayed.

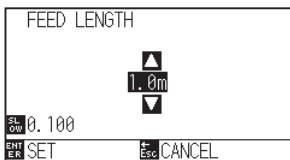

- 4 Press the POSITION (▲▼) keys and increase or decrease the setting value.

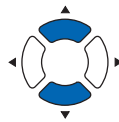

- 5 Confirm the setting and press the [ENTER] key.

▶ Pre feed will start, and it will return to MEDIA SETING screen (1/2) .

- 6 Press the [PAUSE/MENU] key.

▶ It will return to default screen.

Supplement

- It will return to MEDIA SETING screen (1/2) without changing the settings when you press the [ESC] key (CANCEL).
- Press the [SLOW] key to select the setting digits.
- You can set the range between 0.5 m and 50 m.
- When you select "SHEET" for paper feeding, pre feed will be not performed.

Supplement

When Pre Feed of Media is performed, the following screen is displayed.

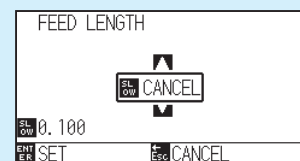

To cancel Pre Feed, press the [SLOW] key (CANCEL).

2.10 Selecting Tool Condition

Set the "TOOL CONDITION (CUT CONDITION) No.", "TOOL", "OFFSET", "SPEED", "FORCE", and "ACCEL (ACCELERATION)".

In Simple mode, you can switch to the settings for each of the five preset media types.

Normal mode can remember up to 8 settings.

Changing these settings allows you to make the proper settings for each different type of media.

In [Simple mode / Normal mode] on the ADVANCE (ADV.) menu, switch between Simple mode and Normal mode. When switching the mode, this cutting plotter will be reset.

Selecting the TOOL CONDITION number (Condition No.)

Simple mode

Operation

- 1 Press the [COND/TEST] key in the READY status.

▶ CONDITION setting screen (1/5) is displayed.

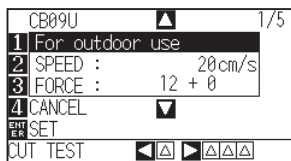

- 2 Press the POSITION (▲▼) key and select the setting.

▶ Select previously registered media types (tool conditions).

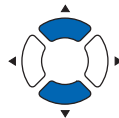

- 3 Confirm the setting and press the [ENTER] key (SET).

▶ Setting will be set, and it will return to default screen.

Supplement

- Use Normal mode for changing the type of blade, offset, and acceleration.
- Pushing the [4] key (RETURN) allows you to return to the conditions screen without changing the settings.

Normal mode

Operation: Operation with the [COND/TEST] key

- 1 Press the [COND/TEST] key in the READY status.

▶ CONDITION setting screen (1/3) is displayed.

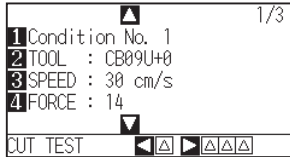

- 2 Press the [1] key (Condition No.).

▶ CONDITION No. selection screen is displayed.

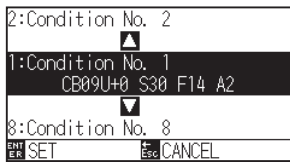

- 3 Press the POSITION (▲▼) keys and select the setting (CONDITION No.).

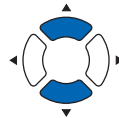

- 4 Confirm the setting and press the [ENTER] key.

▶ Setting will be confirmed and it will return to CONDITION setting screen (1/3)

Supplement

It will return to CONDITION setting screen without changing the settings when you press the [ESC] key before pressing the [ENTER].

- 5 Press the [COND/TEST] key.

▶ It will return to default screen.

Operation: Operation with the [ENTER] key

- 1 Press the [ENTER] key in the READY status.

▶ CONDITION No. selection screen is displayed.

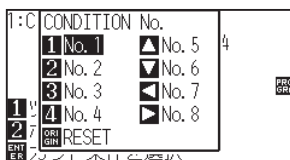

- 2 Press the [1] to [4] keys, or the POSITION (▲▼◀▶) keys, while simultaneously pressing the [ENTER] key.

- 3 Confirm the setting and release the [ENTER] key.

▶ It will return to the default screen.

Setting the tool condition

This section describes how to make the tool, speed, force and acceleration settings. Before cutting media, the following four cutter-pen conditions must be specified.

- FORCE
- SPEED
- ACCELERATION
- OFFSET



CAUTION

- It may result to damaging the cutter blade or the cutting mat if the blade is extended too much. Make sure the blade length is set less than the thickness of the media.

Tool Conditions (Cutter Blade) for Each Media Type

See the Cutter Blade Manual.

Blade Part Nos., Displayed Blade Types, and CUTTER OFFSET Values

See the Cutter Blade Manual.

Reference Pen Conditions for Plotting Pen

Pen type	Part no.	Cut/Force	Speed (cm/s)	Acceleration
Water-based fiber-tip pen	KF700 series	10 tp 12	30	2
Oil-based ballpoint pen	KB700-BK	12 tp 31	30	2

To prolong the pen life, set the FORCE to the lowest setting, and set the SPEED after checking to confirm that there are no faint lines or other problems during plotting.

CAUTION

How to Improve Weed ability

We recommend that you observe the following points to improve the weed ability of media.

- Select the correct blade for the application.
See the Cutter Blade Manual.
- Use blades that are not worn.
If the blade is worn, it will not cleanly and the cut results will be difficult to weed.
- Adjust the blade-length and FORCE settings until only traces of the blade are left on the backing sheet.
Specify a FORCE value that is as low as possible, but that still leaves faint traces on the backing sheet.
- Set the SPEED and ACCELERATION values as low as possible.
- Weed the cut results right after cutting has been completed.
If time is allowed to elapse, adhesive along the cut edges will cause the edges to stick together.
- Select media with good weedability.
Recommended film types: 3M Scotchcal Series 7725.
Weeding refers to the removal of un wanted areas of vinyl from the background after the media has been cut.
<Supplement>
Weeding is when excess from the cut media is removed from the blade.

Supplement

- Finish will become coarser, but the cut time is decreased when the settings for the speed and acceleration is set higher.
Especially with the large media, good cut quality might not be achieved by rumbling media. Decrease the values for the speed and acceleration settings in that case.
- Finish will become good, but the cut time will increase when the settings for the speed and acceleration is set smaller.

Setting the Speed and Force (Simple mode)

In Simple mode, set the speed and force to be used with each tool condition.

Setting range (SPEED) : 5 to 60 (in 5cm/s increment)

Setting range (FORCE) : Standard Value + Adjusted Value

The value of (reference value + adjustment value) is 1 to 38.

Operation

- 1 Press the [COND/TEST] key in the default screen.

▶ CONDITION setting screen (1/5) is displayed.

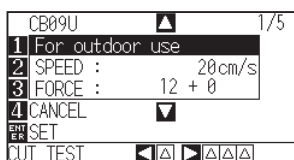

Supplement

- Use Normal mode for changing the type of blade, offset, and acceleration.
- It will return to CONDITION screen without changing the settings when you press the [4] key (CANCEL).

- 2 Press the POSITION (▲▼) key and select the setting.

▶ Select the preset Media Type (Tool Conditions).

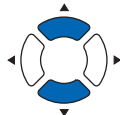

- 3 Press the [2] key (SPEED) to change the speed.

▶ The screen below will appear.

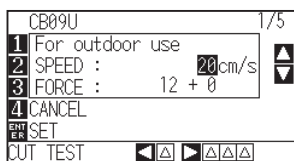

- 4 Press the POSITION (▲▼) key and increase or decrease the current value.

You can enter any value between 5 and 60 (in increments of 5cm/s).

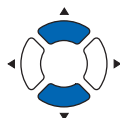

Supplement

- Press the [ENTER] key (SET), confirm the settings, and then return to the READY screen.
- Press the [4] key (RETURN) to return to the READY screen without changing any settings.

If you only want to change the speed, press the [ENTER] key (SET). Setting will be set, and it will return to default screen.

▶ Setting will be set, and it will return to default screen.

- 5 When you want to change the force, press the [3] key (FORCE).

▶ The screen below will appear.

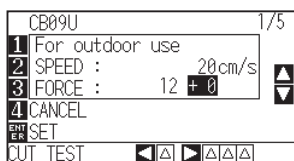

- 6 Press the POSITION (▲▼) key and increase or decrease the adjustment value from the current number.
The force setting can be modified with the ± adjusted value.

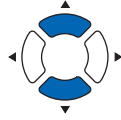

Supplement

- Press the [ENTER] key (SET) to confirm the settings and return to the READY screen.
- Press the [4] key (RETURN) to return to the READY screen without changing any settings.
- The +0 value allows you to use the standard force setting. If adjustment is necessary, you can enter the ± adjusted value.

When confirming the setting, press the [ENTER] key (SET).

▶ Setting will be set, and it will return to default screen.

Setting the tool

Set the type and offset value of the tool that is used.

Operation

- 1 Press the [COND/TEST] key in the default screen.

▶ CONDITION setting screen (1/3) is displayed.

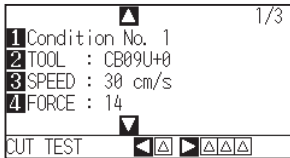

- 2 Press the [2] key (TOOL).

▶ TOOL setting screen is displayed.

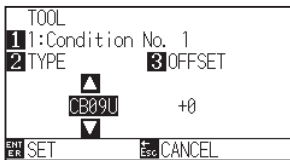

- 3 Press the POSITION (▲▼) keys and set the tool.

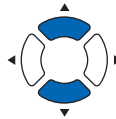
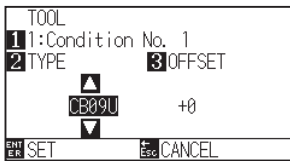

- 4 Press the [3] key (OFFSET).

▶ OFFSET setting screen is displayed.

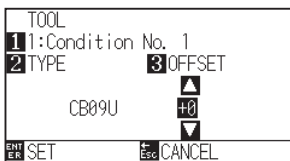

Supplement

- Perform the settings in Normal mode.
- In Simple mode, it is locked.

Supplement

Press the [1] key to change the CONDITION No.

It will return to CONDITION setting screen without changing the settings when you press the [ESC] key (CANCEL).

Supplement

- What is Offset

It will adjust the difference between the tip of the blade in the plunger and the center of the plunger. There are standard adjustment values for each cutter blades.

Fine adjustment will be made to that standard values here. (Adjustment will be made with standard value as 0.)

It is not necessary to set the offset if "PEN", was selected in the tool settings. (not displayed)

- Guideline to Set Offset

See the Cutter Blade Manual

- You can set the range between -5 and +5. The other range is +1 to +45.
- To continue the settings of other tool condition number, return to step 3 by pressing the [1] key.

- 5 Press the POSITION (▲▼) keys and increase or decrease the setting value.

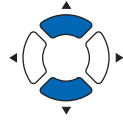

- 6 Confirm the setting and press the [ENTER] key (SET).

▶ Setting will be confirmed and it will return to CONDITION setting screen (1/3).

- 7 Press the [COND/TEST] key.

▶ It will return to default screen

Setting the speed

Set the speed of the tool that is used in each of the condition numbers.

Setting range : CE7000-40 1 to10 (in 1 cm/s increment), 10 to 60 (in 5 cm/s increment)
 : CE7000-60 1 to10 (in 1 cm/s increment), 10 to 60 (in 5 cm/s increment), 64
 : CE7000-130 1 to10 (in 1 cm/s increment), 10 to 70 (in 5 cm/s increment), 71
 : CE7000-160 1 to10 (in 1 cm/s increment), 10 to 70 (in 5 cm/s increment), 71

Supplement

- In the CE7000-60, if speed is set to 64 and acceleration to 3 at the same time, the "*" will be displayed in the acceleration. In this case, both values will be automatically calculated and the cutting plotter works with the values.
- In the CE7000-130/160, if acceleration is set to 2, the speed cannot be set to 65 or more (65, 70, or 71). In this case, the "+" will be displayed in the acceleration and both values of the speed and acceleration will be automatically calculated and the cutting plotter works with the values.

Operation

- 1 Press the [COND/TEST] key in the default screen.

▶ CONDITION setting screen (1/3) is displayed.

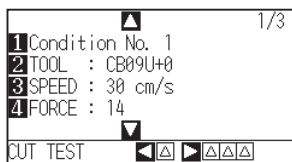

Supplement

Perform the settings in Normal mode.

- 2 Press the [3] key (SPEED).

▶ SPEED setting screen is displayed.

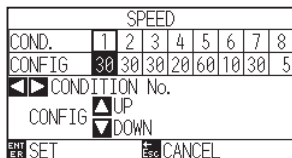

Supplement

It will return to CONDITION setting screen (1/3) without changing the settings when you press the [ESC] key (CANCEL).

* Display may vary depending on the selected tool condition number.

- 3 Press the POSITION (◀▶) keys and select the tool condition number (CONDITION No.).

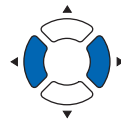

- 4 Press the POSITION (▲▼) keys and increase or decrease the setting value.

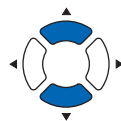

5 Confirm the setting and press the [ENTER] key (SET).

▶ Setting will be confirmed and it will return to CONDITION setting screen (1/3).

6 Press the [COND/TEST] key.

▶ It will return to default screen.

Supplement

Depending on media width, speed and acceleration settings, the acceleration of the default screen is displayed as [*].

In this case, it operates with the value of the calculated acceleration automatically.

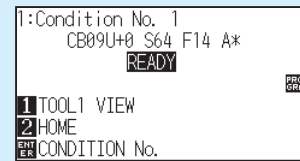

1:Condition No. 1
CB09U+0 S64 F14 A*
READY
PRO
GRN
1 TOOL1 VIEW
2 HOME
ENT CONDITION No.

Setting the force

Set the cutting force that is used in each of the condition numbers.

Setting range : 1 to 38

Operation

- 1 Press the [COND/TEST] key in the default screen.

▶ CONDITION setting screen (1/3) is displayed.

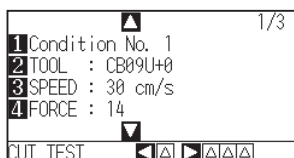

Supplement

Perform the settings in Normal mode.

- 2 Press the [4] key (FORCE).

▶ FORCE setting screen is displayed.

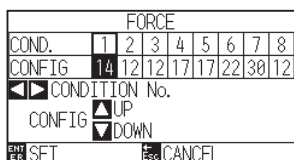

Supplement

It will return to CONDITION setting screen (1/3) without changing the settings when you press the [ESC] key (CANCEL).

* Display may vary depending on the selected condition number.

- 3 Press the POSITION (◀▶) keys and select the condition number (CONDITION No.).

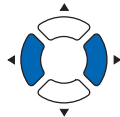

- 4 Press the POSITION (▲▼) keys and increase or decrease the setting value.

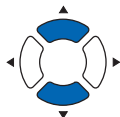

Supplement

You can set the range between 1 and 38.

- 5 Confirm the setting and press the [ENTER] key (SET).

▶ Setting will be confirmed and it will return to CONDITION setting screen (1/3).

- 6 Press the [COND/TEST] key.

▶ It will return to default screen.

Setting the acceleration

Set the acceleration of the tool that is used in each of the tool condition numbers.

Setting range : CE7000-40 : 1 to 3
 : CE7000-60 : 1 to 3
 : CE7000-130 : 1 to 2
 : CE7000-160 : 1 to 2

Operation

- 1 Press the [COND/TEST] key in the default screen.

▶ CONDITION setting screen (1/3) is displayed.

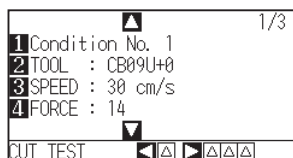

Supplement

Perform the settings in Normal mode.

- 2 Press the POSITION (▲) key.

▶ CONDITION setting screen (2/3) is displayed.

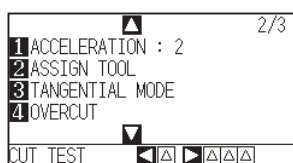

- 3 Press the [1] key (ACCELERATION).

▶ ACCELERATION setting screen is displayed.

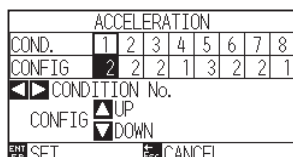

Supplement

It will return to CONDITION setting screen (2/3) without changing the settings when you press the [ESC] key (CANCEL).

* Display may vary depending on the selected tool condition number.

- 4 Press the POSITION (◀▶) keys and select the tool condition number (CONDITION No.).

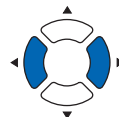

- 5 Press the POSITION (▲▼) keys and increase or decrease the setting value.

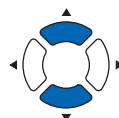

6 Confirm the setting and press the [ENTER] key (SET).

▶ Setting will be confirmed and it will return to CONDITION setting screen (2/3).

7 Press the [COND/TEST] key.

▶ It will return to default screen.

Supplement

Depending on media width, speed and acceleration settings, the acceleration of the default screen is displayed as [*].

In this case, It operates with the value of the calculated acceleration automatically.

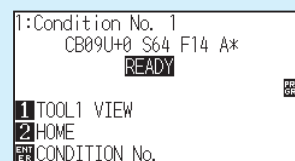

1:Condition No. 1
CB09U+0 S64 F14 A*
READY
PRO
GRN
1 TOOL1 VIEW
2 HOME
ENT CONDITION No.

Setting tool No.

Set the tool that is used in each of the tool condition numbers.

Setting range : 1, 3

Operation

- 1 Press the [COND/TEST] key in the default screen.

▶ CONDITION setting screen (1/3) is displayed.

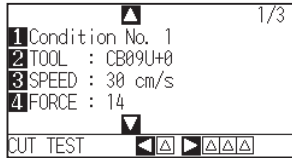

- 2 Press the POSITION (▲) key.

▶ CONDITION setting screen (2/3) is displayed.

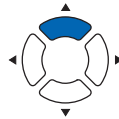
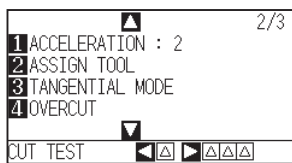

- 3 Press the [2] key (ASSIGN TOOL)

▶ ASSIGN TOOL setting screen is displayed.

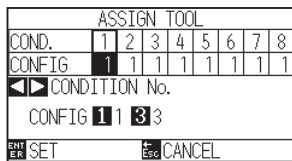

Supplement

It will return to CONDITION setting screen (2/3) without changing the settings when you press the [ESC] key (CANCEL).

* Display may vary depending on the selected tool condition number.

- 4 Press the POSITION (◀▶) keys and select the tool condition number (CONDITION No.).

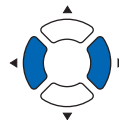

- 5 Press the [1] key (1) or the [3] key (3).
- 6 Confirm the setting and press the [ENTER] key (SET).
 - ▶ Setting will be confirmed and it will return to CONDITION setting screen (2/3).
- 7 Press the [COND/TEST] key.
 - ▶ It will return to default screen.

Supplement

- Tool number and installed position

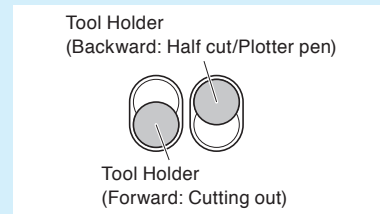

Tool 1: When using a tool installed behind the tool holder

Tool 3: When using a tool attached in front of the tool holder

- For information on how to install the tool, see "Attaching a Tool".

Adjust the blade length manually

Optimal cut is not achieved unless the blade length is adjusted in accordance to the used media and the cutter blade. Perform further adjustment by performing cutting test after adjusting the blade length manually.

CAUTION

- To avoid bodily injury, handle cutter blades with care.
- It may result to damaging the cutter blade or the cutting mat if the blade is extended too much. Make sure the blade length is set less than the thickness of the media.

Supplement

- See "Running Cutting Tests" for cutting tests.
- When a thin media such as a film is used, use the supplied magnifier to adjust it.

Operation

- 1 Align the blade tip to the tip of the cutter pen, and make it touch the surface of the media.

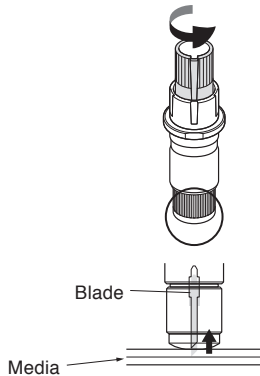

- 2 Extend the blade little by little to the thickness of the media. Optimal blade length is less than the thickness of film and backing sheet combined, but more than the thickness of the film.

Try cutting the film, and adjust so there is slight cutting on the backing sheet. If the backing sheet gets cut completely, reduce the blade length, and if the film does not get cut completely, increase the blade length.

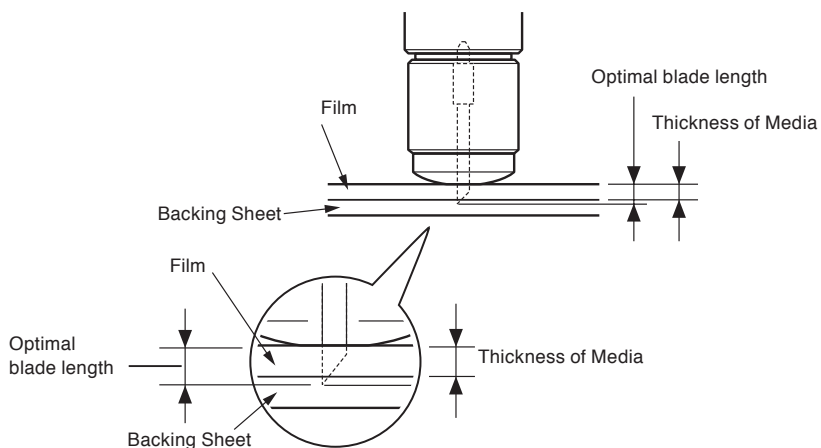

Supplement

- Blade length can be changed by spinning the adjuster on the blade. Spinning it in the A direction pushes it out, while spinning it in the B direction pulls it in. One scale unit is equal to 0.1 mm.

Cutter blade moves approximately 0.1 mm turning one scale unit.

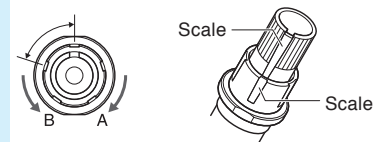

- Guideline to Set the Blade Length
See "Setting the Tool Condition" for the thickness of the media.

2.11 Running Cutting Tests

Test cutting can be performed after making the tool, speed, force, and acceleration settings to ensure that the selected cutting conditions actually produce the desired cutting results. Check how far the blade cuts into the media and how the corners are being cut. If the cutting results are not satisfactory, adjust the various settings and repeat the test cutting until the optimal settings are achieved.

Cutting test

Here, you can either cut one test pattern based on the current values, or do three tests with ± 1 values added.

To make 1 cut with set value

Operation

- 1 Load the media for test cutting in the plotter.
- 2 Press the [COND/TEST] key in the default screen.
 - ▶ CONDITION setting screen (1/3) is displayed.

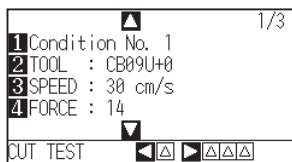

CONDITION screen
(Normal mode)

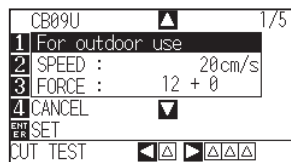

CONDITION screen
(Simple mode)

- 3 Press the POSITION (◀) key (CUT TEST).

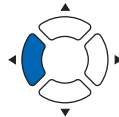
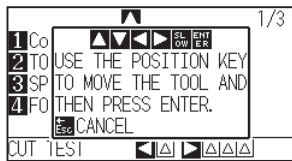

Supplement

It will return to CONDITION setting screen when you press the [ESC] key (CANCEL).

- 4 Press the POSITION (▲▼◀▶) keys to move the tool carriage to the location you wish to perform the test cutting.

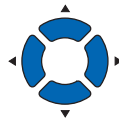

Supplement

Pressing the POSITION and [SLOW] keys at the same time will move the tool carriage slower.

- 5 Press the [ENTER] key.

▶ 1 cut test pattern is cut.

- 6 Press the [ENTER] key after completion.

▶ CONDITION setting screen is displayed.

- 7 Press the [COND/TEST] key.

▶ It will return to default screen.

CAUTION

When the [ENTER] key is pressed, the tool carriage will start moving, so take care not to get injured by the cutter blade.

To make 3 cuts with set value and ± 1 of set value

Operation

- 1 Load the media for test cutting in the plotter.
- 2 Press the [COND/TEST] key in the default screen.
 - ▶ CONDITION setting screen (1/3) is displayed.

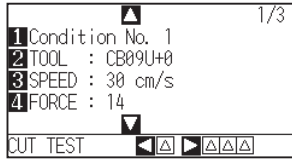

CONDITION screen
(Normal mode)

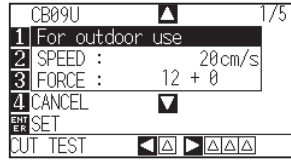

CONDITION screen
(Simple mode)

- 3 Press the POSITION (▶) key (CUT TEST).
 - ▶ CUT TEST screen is displayed.

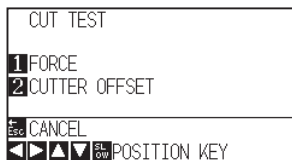
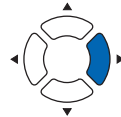

CONDITION screen
(Normal mode)

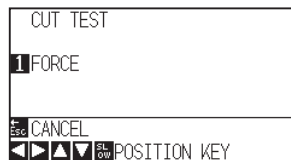

CONDITION screen
(Simple mode)

Supplement

It will return to CONDITION setting screen when you press the [ESC] key (CANCEL).

- 4 Press the POSITION (▲▼◀▶) keys to move the tool carriage to the location you wish to perform the test cutting.

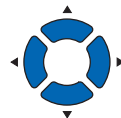

Supplement

Pressing the POSITION and [SLOW] keys at the same time will move the tool carriage slower.

- 5 Press the [1] key (FORCE).
 - ▶ 3 cutting test patterns are cut, with current FORCE in the center, and 1 each of FORCE increased and decreased for 1.

CAUTION

When the [1] key (FORCE) is pressed, the tool carriage will start moving, so take care not to get injured by the cutter blade.

Supplement

Test cut patterns can have their cut order and force changed as shown below.

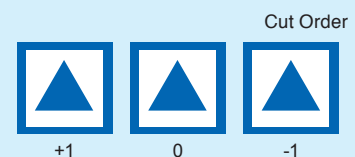

- 6 Press the [ENTER] key after completion.
 - ▶ It will return to CUT TEST menu screen.

- 7** Press the [2] key (CUTTER OFFSET).
 - ▶ 3 cutting test patterns are cut, with current CUTTER OFFSET in the center, and 1 each of CUTTER OFFSET increased and decreased for 1.
- 8** Press the [ENTER] key after completion.
 - ▶ It will return to CUT TEST menu screen.
- 9** Press the [ESC] key (CANCEL).
 - ▶ It will return to CONDITION setting screen.
- 10** Press the [COND/TEST] key.
 - ▶ It will return to default screen.

**CAUTION**

When the [2] key (CUTTER OFFSET) is pressed, the tool carriage will start moving, so take care not to get injured by the cutter blade.

Confirm the results of the cutting test

Confirm the cutting test results, and adjust to optimal setting. Repeat cutting test and adjustment until optimal cut is achieved.

Adjustment of Offset

Check the corners of the triangles and rectangles. See "Setting the Tool Condition" and adjust the offset value if the corner is not cut or if it is cut too much.

Adjust the offset value.

Supplement

How to check offset

Check if the offset value is set correctly by following.

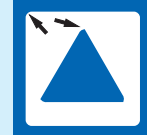

Not enough adjustment
Increase the offset value.

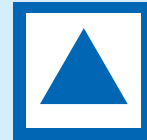

Optimal offset value.

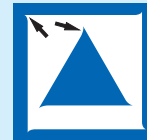

Too much adjustment.
Decrease the offset value.

Adjustment for Half Cutting

Peel off the triangle area, and adjust so it cuts slightly into the backing sheet.

If the backing sheet has been cut through, either the FORCE setting is too high or the cutter-blade tip is extended too far. If the backing sheet shows only a few traces of the cutter blade, either the FORCE setting is too low or the cutter blade tip is not sufficiently extended.

Adjustment for cutting out

Adjust so the media is completely cut out.

If the media is not completely cut, either the FORCE setting is too low or the cutter blade tip is not sufficiently extended.

See "Adjusting the Blade Length" and "Setting the Force" and adjust the settings.

Adjustment when using plotting pen

Adjust the FORCE so there will be no faint lines. To prolong the pen life, set the FORCE to the lowest setting without any faint lines. See "Setting the Force" or setting the FORCE.

Supplement

See "Adjusting the Blade Length" and "Setting the Force" and adjust the settings.

Adjust the blade length (Automatic Height Adjust)

Test cutting must be performed several times in order to confirm the optimal blade length setting. However, if the blade length adjustment function is used, the optimal length can be easily set.

Supplement

- In the case of the less than 1 mm adjustment, please use the supplied magnifier.
- The measured height is a guideline only. After attempting to cut the actual media, please adjust blade length accurately.

Operation

- 1 Load the media for test cutting in the plotter.
- 2 Press the POSITION (▲▼◀▶) keys to move the tool carriage to the location you wish to perform the blade length adjustment.

Supplement

Perform the settings in Normal mode.

- 3 Press the [COND/TEST] key in the default screen.

▶ CONDITION setting screen (1/3) is displayed.

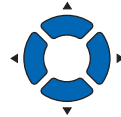
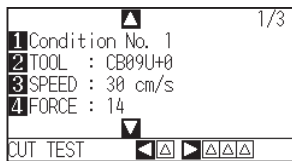

- 4 Press the POSITION (▼) key.

▶ CONDITION setting screen (3/3) is displayed.

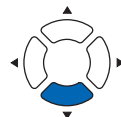
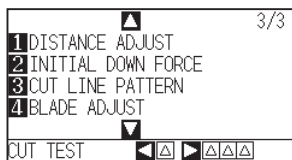

- 5 Press the [4] key (BLADE ADJUST).

▶ Message prompting to turn the blade-length adjustment knob is displayed.

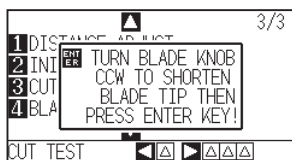

- 6 As instructed, turn the blade length adjustment knob to the left to fully retract the blade.

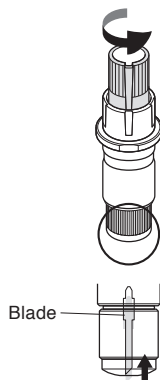

Supplement

See "Structure of Cutter Plunger" for blade length adjustment knob.

- 7 Set the cutter plunger in Tool Holder (Backward).

Supplement

Adjustment is only possible for the cutter pen set in Tool Holder (Backward). It does not apply to Tool Holder (Forward). See "Attaching a Tool" for instructions on setting.

- 8 Press the [ENTER] key.

The height is calculated by moving the tool up and down.

▶ TO ACHIEVE THE TARGET LENGTH screen is displayed.

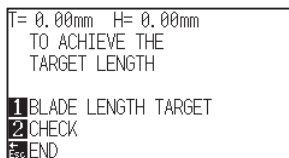

- 9 Press the [1] key (BLADE LENGTH TARGET).

▶ BLADE LENGTH TARGET screen (TARGET) is displayed.

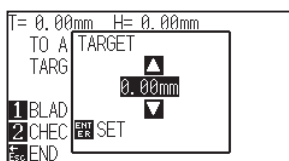

- 10 Press the POSITION (▲▼) keys and increase or decrease the setting value.

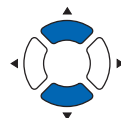

- 11 Confirm the settings and press the ENTER key (SET).

▶ The Blade Length Target will be selected, and it will return to the TO ACHIEVE THE TARGET LENGTH screen.

12 Press the [2] key (CHECK).

The height is calculated by moving the tool up and down.

▶ The amount and direction to turn the adjustment knob is displayed.

```
T= 0.00mm H= 0.25mm
TURN THE KNOB
APPROX 0.5 TURNS
IN CCW DIRECTION
1 BLADE LENGTH TARGET
2 CHECK
Esc END
```

13 Turn the blade-length adjustment knob and adjust the cutter blade length.

Current blade length is displayed by pressing the [2] key (CHECK) , so adjust the blade length until it matches the thickness of the media.

14 Press the [ESC] key (END).

▶ Adjustment is completed and it will return to CONDITION setting screen (3/3).

15 Press the [COND/TEST] key.

▶ I will be return to default screen. After completing the settings, press [ENTER] key.

Supplement

"T" is the target value of the blade length, and "H" is the current blade height (amount).

Turning the blade-length adjustment knob displays the number of turns and direction.

 **CAUTION**

Depending on the loaded media, the blade might sink in to the media, making accurate measurement impossible.

2.12 About Simple mode

Simple settings can be made from the menu in Simple mode.

Five different tool conditions can be switched on for different media. Copying can also be done from Simple mode. Simple mode and Normal mode are independent from each other. When a different mode is activated, the new mode's settings will take precedence.

In [Simple mode / Normal mode] on the ADVANCE (ADV.) menu, switch between Simple mode and Normal mode. When switching the mode, it will start from the MEDIA SELECT screen.

Supplement

- In Simple mode, network (LAN) interface and RS-232C interface are not available.
- In Simple mode, ARMS settings cannot be used. Even in Simple Mode (performing operations) commands for specifying the registration marks can be used. For items with no specified commands, the specified ARMS settings in Normal mode will be used.

You can choose the following settings on Simple mode's default screen.

See "How to Use Control Panel" for detailed information.

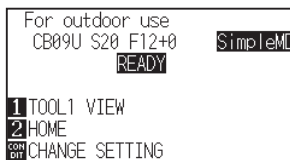

READY screen
(Simple mode)

[COND/TEST] : Set [Tool Conditions]. (See : Selecting Tool Condition)

[COPY] : Make a copy. (See : Copy)

You can choose the following settings on the Simple mode menu screen.

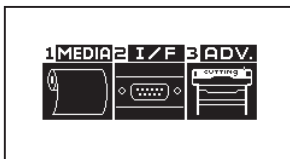

MENU screen
(Simple mode)

[1] (MEDIA) : Set Page Length.

[2] (I/F) : Set "HP-GL ORIGIN POINT" and "GP-GL STEP SIZE".

[3] (ADV.) : Set Language and Length Unit.

That concludes the Simple mode menu screen setting explanation.

Changing Mode

Operation

- 1 Press the [PAUSE/MENU] key.

▶ MENU screen is displayed.



Normal mode

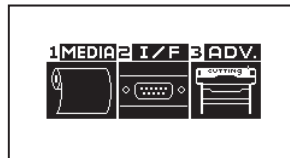

Simple mode

- 2 In Normal mode, press the (▼) key (ADV.) and then press the POSITION (▲) key twice on the ADVANCE (ADV.) screen.

In Simple mode, press the [3] key (ADV.).

▶ ADVANCE screen is displayed.

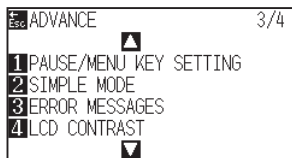

Normal mode

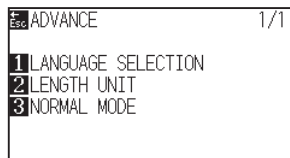

Simple mode

- 3 Press the [2] key (SIMPLE MODE) in the Normal mode, or press the [3] key (NORMAL MODE) in the Simple mode.

▶ USER switch selecting screen is displayed.

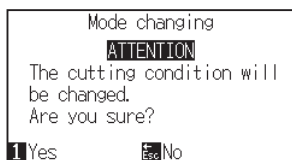

- 4 The [1] key (Yes) allows you to change the mode after resetting the CE7000.

The [ESC] key (No) allows you to return to the previous screen without changing the mode.

- 5 When the user is switched, the cutting plotter will be reset.

2.12.1 Setting Page Length (Simple mode)

Use 1 Page Length when using Roll media.

If the machine receives data for a cut longer than the set page length, it will only cut for the set area parameters. The excess area will not be cut.

This can also be set in Normal mode.

Reference

- Default setting for page length is 2 m for CE7000-40, and 5 m for CE7000-60/130/160. Check the setting of the page length when cutting long length.
 - * Please be sure to use the basket (option) when cutting something over 2 m long.
- Page ejection quality assurance goes up to 2 m for the CE7000-40 and up to 5m for the CE7000-60/130. (It depends on the media specified by Graphtec and setting conditions.)
 - Use the basket (option).
 - Use 3M Scotchcal Series 7725.
 - Set the speed below 30 and the acceleration below 2 (In Simple mode, there is no need to set anything, so it is not available.)
 - Perform pre feed for the amount to be used before cutting.
 - Leave the media in environment to use for adequate time if the deviation of temperature and humidity is big.
 - Set the both push rollers at least 15mm inside the edge of media.
- Set the sideways tension of the media uniform when setting the media when cutting long length. Media might come off the rollers while cutting if it is not uniform.
- Pull out the amount to use before cutting when you are using the roll media.
- To reduce the shifting of the media, perform the pre feed to the full length to be cut (see "Pre Feed of Media (Paper or Marking Film)"). Also, pre feeding can be done automatically when the data is received (see "Perform Automatic Pre Feed When Cut Data is Received"), or done automatically when the media is loaded (see "Perform Automatic Pre Feed When Media is Set (Initial Feed)").
 - * Pre feeding will stabilize the feed by acclimating the media, taking out the slack.
- This setting is maintained even after the power is turned off.

Operation

1 Press [PAUSE/MENU] key.

▶ MENU screen is displayed.

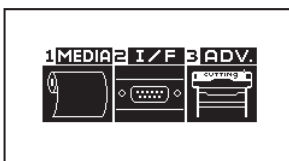

2 Press [1] key (MEDIA).

▶ MEDIA SETTING screen is displayed.

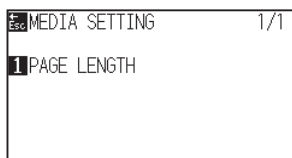

3 Press [1] key (PAGE LENGTH).

▶ PAGE LENGTH screen is displayed.

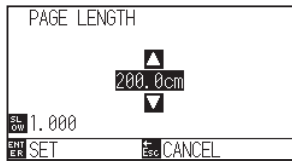

4 Press the POSITION (▲▼) keys to change the current setting.

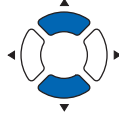

Supplement

- Press the [SLOW] key to change the setting digits.
- You can enter any digit between 20.0cm and 5000.0cm.

5 Confirm the setting and press the [ENTER] key (SET).

▶ Setting will be set, and it will return to MEDIA SETTING screen.

6 Press [PAUSE/MENU] key.

▶ It will return to default screen.

Supplement

It will return to MEDIA SETTING screen without changing the settings when you press the [ESC] key (CANCEL).

2.12.2 Origin Point Settings When configuring HP-GL (Simple mode)

When using the HP-GL command, the origin point is set to either the lower left of the cutting area or the center. When using the GP-GL command, this setting does not affect the operation. Command settings are automatic in Simple mode. This can also be set in Normal mode.

Supplement

See "Settings of Controls from Computer" for more information.

Operation

- 1 Press [PAUSE/MENU] key.

▶ MENU screen is displayed.

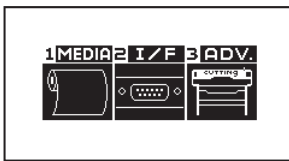

- 2 Press [2] key (I/F).

▶ INTERFACE screen is displayed.

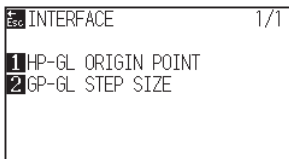

- 3 Press [1] key (HP-GL ORIGIN POINT).

▶ HP-GL ORIGIN POINT setting screen is displayed.

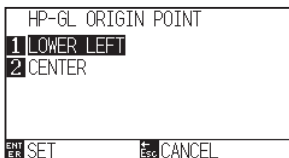

- 4 Press [1] key (LOWER LEFT) or [2] (CENTER).

- 5 Confirm the setting and press the [ENTER] key (SET).

▶ Setting will be set, and it will return to INTERFACE screen.

- 6 Press [PAUSE/MENU] key.

▶ It will return to default screen.

Supplement

It will return to INTERFACE screen without changing the settings when you press the [ESC] key (CANCEL).

2.12.3 GP-GL Step Size (Simple mode)

Here you can change the distance of 1 Step. Match it to the software you are using.
"Command setting" is only for GP-GL commands.

Operation

- 1 In default screen, press [PAUSE/MENU] key.

▶ MENU screen is displayed.

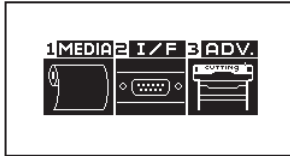

- 2 Press [2] key (I/F) .

▶ INTERFACE screen is displayed.

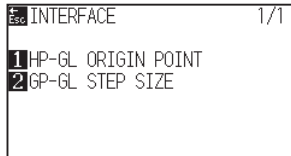

- 3 Press [2] key (GP-GL STEP SIZE).

▶ STEP SIZE setting screen is displayed.

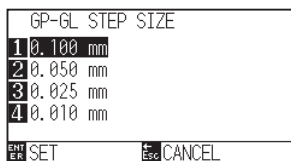

- 4 Press [1] key (0.100 mm), [2] key (0.050 mm), [3] key (0.025 mm), or [4] key (0.010 mm).

- 5 Confirm the setting and press the [ENTER] key (SET).

▶ Setting will be set, and it will return to INTERFACE screen.

- 6 Press [PAUSE/MENU] key.

▶ It will return to default screen.

Supplement

It will return to INTERFACE screen without changing the settings when you press the [ESC] key (CANCEL).

2.12.4 Display Language Settings (Language) (Simple mode)

Here you can change the display language.

You can choose from 10 languages: English, Japanese, German, French, Italian, Spanish, Portuguese, Russian, Korean, and Chinese.

This can be changed in Normal mode.

Operation

- 1 In default screen, press [PAUSE/MENU] key.

▶ MENU screen is displayed.

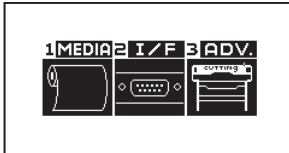

- 2 Press [3] key (ADV.).

▶ ADVANCE setting screen is displayed.

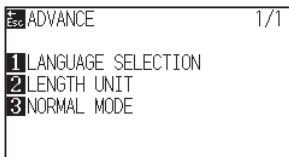

- 3 Press [1] key (LANGUAGE SELECTION).

▶ LANGUAGE SELECTION screen is displayed.

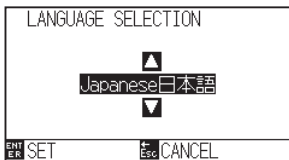

- 4 Pressing POSITION (▲▼) keys, select the desired language.

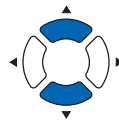

- 5 Confirm the setting and press the [ENTER] key (SET).

▶ Setting will be set, and it will return to ADVANCE setting screen.

- 6 Press [PAUSE/MENU] key.

▶ It will return to default screen.

Supplement

It will return to ADVANCE screen without changing the settings when you press the [ESC] key (CANCEL).

2.12.5 Display Length Unit Settings (Length Unit) (Simple mode)

You can choose to have length units displayed in either meters or inches.
This can be changed in Normal mode.

Operation

- 1 In default screen, press [PAUSE/MENU] key.

▶ MENU screen is displayed.

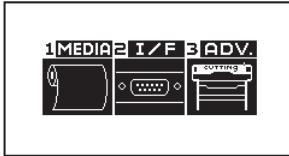

- 2 Press [3] key (ADV.).

▶ ADVANCE setting screen is displayed.

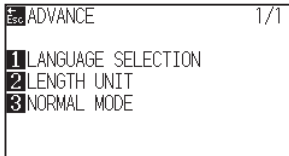

- 3 Press [2] key (LENGTH UNIT).

▶ LENGTH UNIT setting screen is displayed.

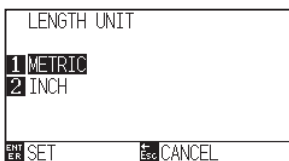

- 4 Press [1] key (METRIC) or [2] key (INCH).

- 5 Confirm the setting and press the [ENTER] key (SET).

▶ Setting will be set, and it will return to ADVANCE setting screen.

- 6 Press [PAUSE/MENU] key.

▶ It will return to default screen.

Supplement

It will return to ADVANCE screen without changing the settings when you press the [ESC] key (CANCEL).

2.13 Displaying Cutting Area

Check the width of cutting area.

Operation

1 Press the [SLOW] key in the default screen.

▶ The cutting area is displayed.

When a rewinding device is not installed

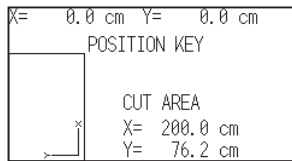

2 Release the [SLOW] key.

▶ I will be return to default screen.

Chapter 3: Basic Operations

This chapter describes the basic methods to operate the plotter manually.

All the operations described in this chapter is to start from the READY status (media is set) as a general condition.

Perform the operation described in this chapter after making the plotter in READY status referring to previous chapter.

PRODUCT SUMMARY

- 3.1 Raise or Lower the Tool***
- 3.2 Move the Tool Carriage and Media***
- 3.3 Setting the Origin Point***
- 3.4 Setting the Cutting Direction***
- 3.5 Stop Cutting***

3.1 Raise or Lower the Tool

This is a function to raise or lower the tool (pen).

Operation

- 1 Press the [PAUSE/MENU] key.

▶ MENU screen is displayed.



Supplement

Perform the settings in Normal mode.

- 2 Press the [1] key (TOOL).

▶ TOOLS SETTING (1/4) screen is displayed.

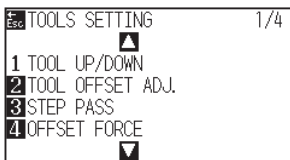

- 3 Tool is raised or lowered every time the [1] key (TOOL UP/DOWN) is pressed.

- 4 Press the [PAUSE/MENU] key.

▶ It will return to default screen.

3.2 Move the Tool Carriage and Media

Tool carriage and media can be moved manually using the POSITION key.

It also can move the tool carriage and media to the origin, or move it certain distance to keep it away.

Move in steps manually

It can manually move in steps when the screen is displaying "READY", or when the POSITION (▲▼◀▶) key is displayed.

Operation

- 1 Press the POSITION (▲▼◀▶) key once to move in the desired direction.

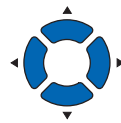

- ▶ Tool carriage or the media will move toward the direction of the pressed POSITION key for 1 step.

Supplement

- It will move in steps every time POSITION (▲▼◀▶) key is pressed.
- Distance of step movement can be changed. See "Setting of Step Movement Distance".

Continuously move manually

It can manually move continuously when the screen is displaying "READY", or when the POSITION (▲▼◀▶) keys are displayed.

Operation

- 1 Hold the POSITION (▲▼◀▶) key down to keep moving in the desired direction.

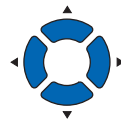

- ▶ Tool carriage or the media keeps on moving continuously in the direction of the pressed POSITION key.

- 2 Release the POSITION (▲▼◀▶) key.

- ▶ Movement of the tool carriage or the media will stop.

Supplement

Pressing the POSITION and [SLOW] keys at the same time will move the tool carriage slower.

Setting step movement distance

The parameters when setting the cutting direction are determined by the distance of the cutting direction.

Operation

- 1 Press the [PAUSE/MENU] key.

▶ MENU screen is displayed.

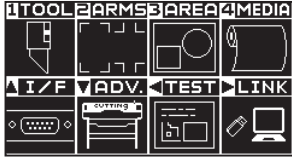

- 2 Press the POSITION (▼) key (ADV.).

▶ ADVANCE screen (1/4) is displayed.

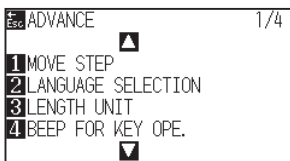

- 3 Press the [1] key (MOVE STEP).

▶ MOVE STEP screen is displayed.

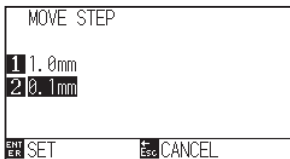

- 4 Press the [1] key (1.0mm) or the [2] key (0.1mm).

- 5 Confirm the setting and press the [ENTER] key (SET).

▶ Setting will be confirmed and it will return to ADVANCE screen (1/4) screen (1/4).

- 6 Press the [PAUSE/MENU] key.

▶ It will return to default screen.

Supplement

Perform the settings in Normal mode.

Supplement

Value chosen here will be the movement distance for the step movement.

Supplement

It will return to ADVANCE screen (1/4) without changing the settings when you press the [ESC] key (CANCEL).

Move away the tool carriage

It is possible to move the tool carriage toward upper right. It makes it easier to confirm the cutting results if you perform this operation after the cutting is completed.

<When using Roll Media>: Seen from above

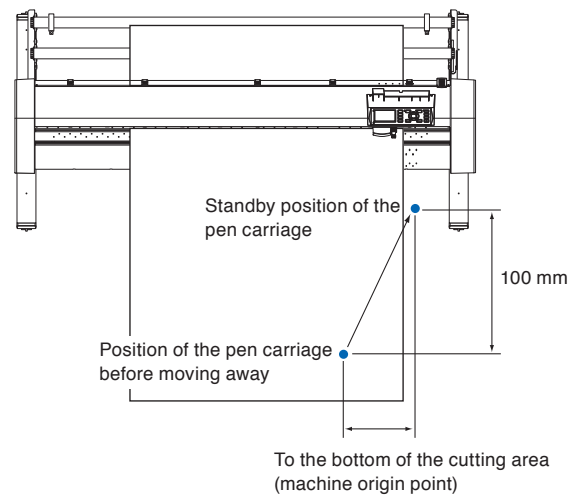

<When using Sheet Media>: Seen from above

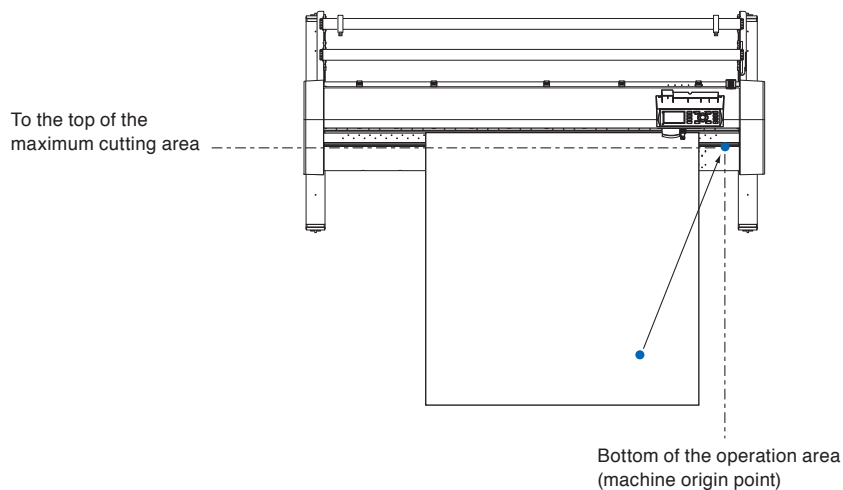

Operation

- 1 Press the [1] key (TOOL1 VIEW) in READY status.
 - ▶ Tool carriage will move away.

To move the tool carriage to the origin point, do following:

Operation

- 1 Press the [2] key (HOME) in READY status.
 - ▶ Tool carriage will move to the origin point.

Supplement

When the tool number setting is set to "1", press the "TOOL 1 MOVE AWAY", and when set to "3", press the "TOOL 3 MOVE AWAY".

Change the cutting condition (Condition No.)

Go through the following steps to change the Cutting Condition (Condition No.):

Operation

- 1 Press the [ENTER] key in READY status.
▶ CONDITION No. selection screen is displayed.



- 2 Press the [1] key (No.1), the [2] key (No.2), the [3] key (No.3), the [4] key (No.4), the [▲] key (No.5), the [▼] key (No.6), the [◀] key (No.7), or the [▶] key (No.8), while simultaneously pressing the [ENTER] key.
▶ Setting will be confirmed and it will return to default screen.

Supplement

It will return to state when the power is turned on when the [ORIGIN] key (RESET) is pressed.
Please refer to for Reset (Revert to the initial state when the power was turned on.).

Reset (Revert to the initial state when the power was turned on.)

To revert to the initial state when the power was turned on, do following:

Operation

- 1 Press the [ENTER] key in READY status.
▶ CONDITION No. selection screen is displayed.

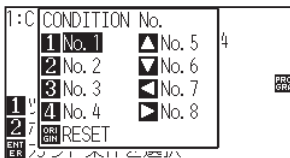

- 2 Press the [ORIGIN] key (RESET), while simultaneously pressing the [ENTER] key.
▶ Initialization is performed, and MEDIA SETTING screen is displayed.

3.3 Setting the Origin Point

Point where the cutting starts is called origin point. The origin point can be set at any location.

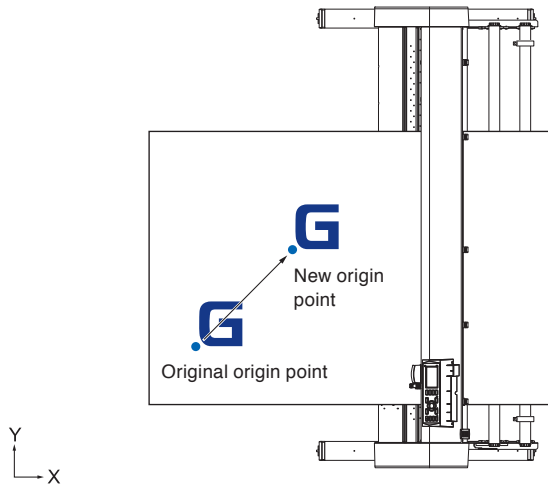

How to set the current position to the new origin point

- 1 Move the tool to the new origin point by pressing the POSITION (\blacktriangle \blacktriangledown \blacktriangleleft \blacktriangleright) keys when it is in READY status.

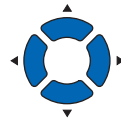

- 2 Press the [ORIGIN] key.

► New origin point is confirmed and "NEW ORIGIN POINT IS SET !" is displayed for few seconds in the screen.



When coordinate axes rotation are set

If the origin point is moved while the coordinate axes are rotated, the origin point will move as shown below.

Supplement

See "Setting the Cutting Direction" about the rotation of the coordinate axes.

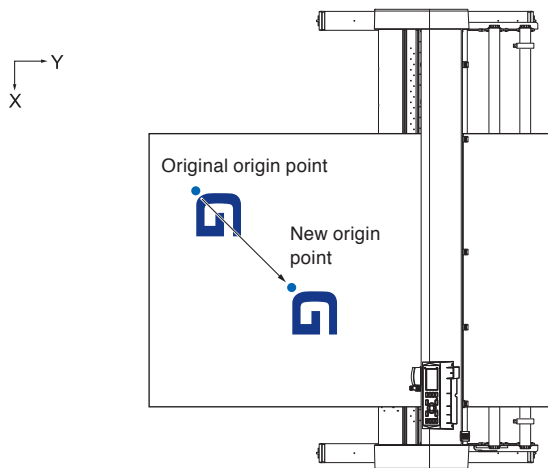

When coordinate axes are rotated after origin point is set

The origin point will be initialized as shown below if the coordinate is rotated after moving the origin point. Distance "a" will be maintained, but distance "b" will be initialized.

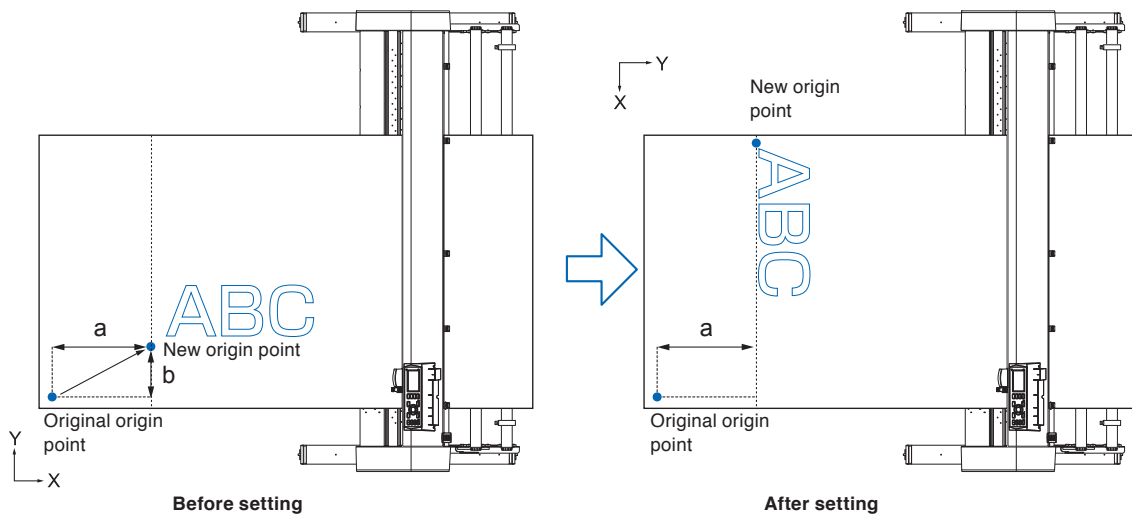

Supplement

- To use the origin point movement and coordinate axes rotation together, always rotate the coordinate axes first, and then move the origin point.
- Coordinate value displayed after setting new origin point is a distance from the new origin point.

Setting origin point when HP-GL is set

When using the HP-GL command, the origin point is set to either the lower left of the cutting area or the center.

Supplement

- When using the GP-GL command, this setting does not affect the operation.
- See "Settings of Controls from Computer" for setting the COMMAND.

Operation

- 1 Press the [PAUSE/MENU] key.

▶ MENU screen is displayed.



Menu screen
(Normal mode)

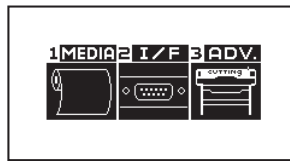

Menu screen
(Simple mode)

- 2 Press the POSITION (▲) key (I/F) in Normal mode, or press the [2] key (I/F) in Simple mode.

▶ INTERFACE screen is displayed.

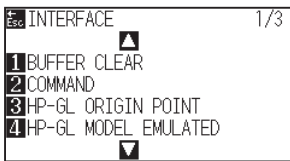

INTERFACE screen
(Normal mode)

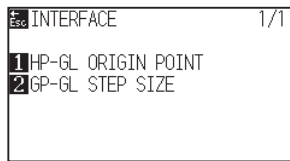

INTERFACE screen
(Simple mode)

- 3 Press the [3] key (HP-GL ORIGIN POINT) in Normal mode, or press the [1] key (HP-GL ORIGIN POINT) in Simple mode.

▶ HP-GL ORIGIN POINT setting screen is displayed.

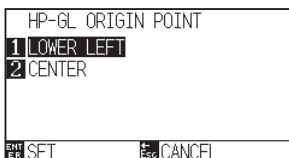

- 4 Press the [1] key (LOWER LEFT) or the [2] key (CENTER).

- 5 Confirm the setting and press the [ENTER] key (SET).

▶ Setting will be confirmed and it will return to INTERFACE screen (1/3).

- 6 Press the [PAUSE/MENU] key.

▶ It will return to the default screen.

Supplement

It will return to INTERFACE screen without changing the settings when you press the [ESC] key (CANCEL).

3.4 Setting the Cutting Direction

Rotate the coordinate axes to change the cutting direction.

Reference

The rotation settings will be saved even if the power is shut off.

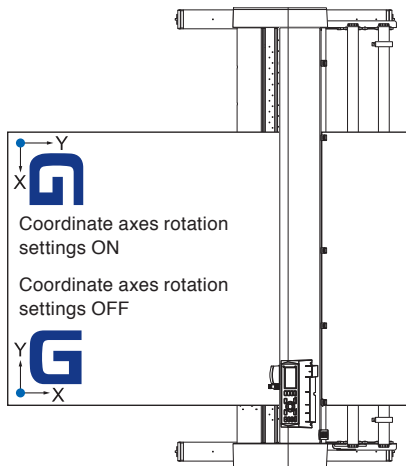

Operation

- 1 Press the [PAUSE/MENU] key.

▶ MENU screen is displayed.



- 2 Press the [3] key (AREA).

▶ AREA PARAMETERS screen (1/2) is displayed.

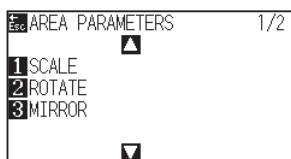

- 3 Press the [2] key (ROTATE).

▶ ROTATE screen is displayed.

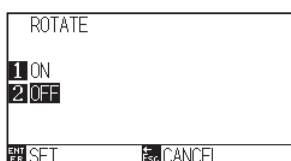

Supplement

Perform the settings in Normal mode.

- 4 Press the [1] key (ON) or the [2] key (OFF).

- 5 Confirm the setting and press the [ENTER] key (SET).
 - ▶ Setting will be confirmed and it will return to AREA PARAMETERS screen (1/2).

- 6 Press the [PAUSE/MENU] key.

The tool carriage moves to the coordinate position you set.

 - ▶ It will return to default screen.

Supplement

It will return to AREA PARAMETERS screen (1/2) without changing the settings when you press the [ESC] key (CANCEL).

3.5 Stop Cutting

It will stop cutting when the [PAUSE/MENU] key is pressed while cutting. Operation selection menu is displayed on the screen of the control panel while it is stopped. It is possible to choose either to continue or stop the operation.

It is also possible to exchange or reset the media while it is stopped.

Pause and resume cutting

Operation

- 1 Press the [PAUSE/MENU] key.
▶ Cutting will stop and following screen is displayed.

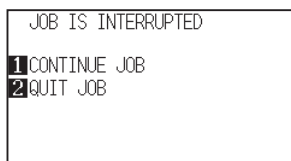

- 2 Perform necessary operation, such as exchanging the media.

Supplement

There is no effect on the selection of media type when the media set lever is moved up and down while pausing the cutting. It is also possible to exchange or reset the media.

- 3 Press the [1] key (CONTINUE JOB).
▶ Cutting will start and the screen will resume to operation.



Supplement

It will stop cutting by pressing [2] key (QUIT JOB).

See "Stop Cutting".

Stop cutting

Operation

1 Press the [PAUSE/MENU] key.

▶ Operation will stop and following screen is displayed.

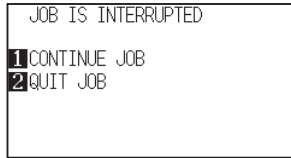

2 Press the [2] key (QUIT JOB).

▶ Following screen is displayed.

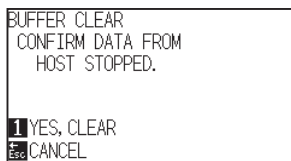

3 Confirm if the data transfer from the computer is stopped and press the [1] key (YES, CLEAR).

▶ Following screen is displayed, the buffer memory is cleared, and it will return to default screen.

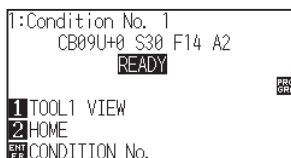

Supplement

It will resume cutting by pressing [1] (CONTINUE JOB) key.

See "Pause and Resume Cutting".

Supplement

- It will return to operation stop screen without clearing buffer memory when [ESC] key (CANCEL) is pressed.

- In the case that the operation is interrupted and the buffer is cleared, make sure that the data transfer is stopped.

If the data transfer continues, abnormal operations where data is processed from the middle may occur.

Chapter 4: Convenient Functions

This chapter describes about the convenient functions of the plotter.

PRODUCT SUMMARY

- 4.1** *Settings for Cutting*
- 4.2** *Copy (Duplicate Cutting)*
- 4.3** *Panel Cutting*

4.1 Settings for Cutting

Settings such as area and width of cutting, page length, mirrored, enlarged, shrunk, etc., can be set.

Setting cutting area

Origin point will be set at lower left of the AREA once the AREA is set. It is possible to set the origin point at the center when the HP-GL is selected.

Move the origin point to change the cutting position.

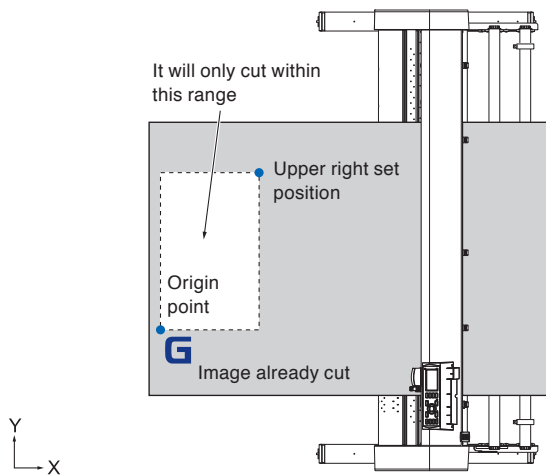

Supplement

- See "Setting the Origin Point" about the moving the origin point.
- See "Setting Origin Point When HP-GL is Set" for setting the origin point with HPGL command.

Operation

1 Press the [PAUSE/MENU] key in READY status.

▶ MENU screen is displayed.



2 Press the [3] key (AREA).

▶ AREA PARAMETERS screen (1/2) is displayed.

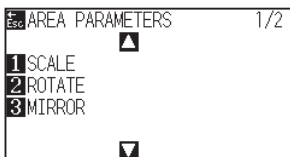

Supplement

Perform the settings in Normal mode.

3 Press the POSITION (▲) key.

▶ AREA PARAMETERS screen (2/2) is displayed.

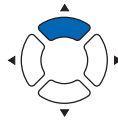
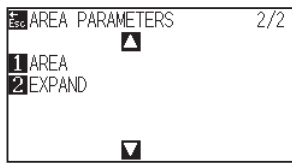

4 Press the [1] key (AREA).

▶ SET LOWER LEFT screen is displayed.

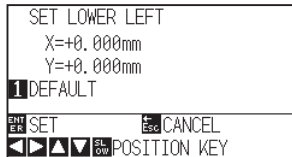

5 Press the POSITION (▲▼◀▶) keys and move the tool carriage to the position to be the lower left of the AREA.



6 Press the [ENTER] key (SET) once the tool carriage is in correct position.

▶ SET UPPER RIGHT screen is displayed.

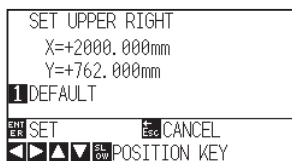

7 Press the POSITION (▲▼◀▶) keys and move the tool carriage to the upper right position of the AREA.

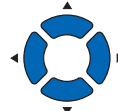

8 Press the [ENTER] key (SET) once the tool carriage is in correct position.

▶ Setting will be confirmed and it will return to AREA PARAMETERS screen (2/2).

9 Press the [PAUSE/MENU] key.

▶ It will return to default screen.

Supplement

- Coordinate value displayed here is the distance to the tool carriage from the origin point.
- Press [1] key (DEFAULT) if the cutting area is not to change.

Supplement

Please set the X and Y cut range for the areas on the upper right and lower left points to at least 10 mm.

An error message will appear for areas that are too small.



You will need to reset the settings for the upper right and lower left points.

Supplement

It will return to AREA PARAMETERS screen (2/2) without changing the settings when you press the [ESC] key (CANCEL).

Setting cutting width (EXPAND)

Set the cutting width. It is possible to set that it will cut to the area outside of the push rollers, or not to cut at the ends of the media.

Default setting is to the internal edge of the push rollers. It can be set up to 10 mm outside (positive value) or 10 mm inside (negative value) from the default position. The width will enlarge if the value is set to positive, and the width will decrease if the value is set to negative. Setting will affect both ends, resulting the total width change will be double the set value.

CAUTION

Do not set the "INITIAL BLADE CONTROL POSITION" of the tool setting to "OUTSIDE" when the setting value is set to more than 8 mm. The blade might be damaged by moving the carriage outside the media under this condition.

Supplement

- If the value is set to positive, it is able to cut over where the push rollers are, but the push rollers passes where it is cut, creating a chance of bad feeding depending on the media
- Set the width of cutting area, and then send the cutting data to the plotter. Cutting data in the buffer memory will be cleared when cutting area width is changed.

Operation

- 1 Press the [PAUSE/MENU] key in READY status.

▶ MENU screen is displayed.



Supplement

Perform the settings in Normal mode.

- 2 Press the [3] key (AREA).

▶ AREA PARAMETERS screen (1/2) is displayed.

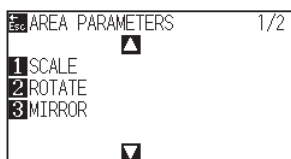

- 3 Press the POSITION (▲) key

▶ AREA PARAMETERS screen (2/2) is displayed.

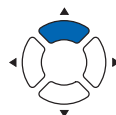
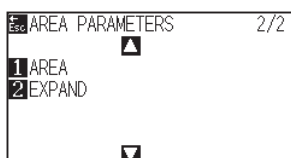

4 Press the [2] key (EXPAND).

▶ SET EXPAND LIMIT screen is displayed.

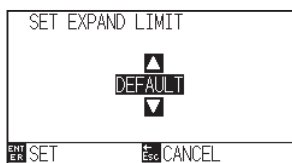

5 Press the POSITION (▲▼) keys and increase or decrease the setting value.

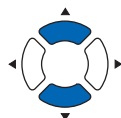

6 Confirm the setting and press the [ENTER] key (SET).

▶ Setting will be confirmed and it will return to AREA PARAMETERS screen (2/2).

7 Press the [PAUSE/MENU] key.

▶ It will return to default screen.

Supplement

- If the settings value is set to an area between +1.0 mm and +10.00 mm, transfer direction of the cutting area will also expand 5 mm forward.
- You can set the range between +10.0 and -10.0 mm.

Supplement

It will return to AREA PARAMETERS setting screen (2/2) without changing the settings when you press the [ESC] key (CANCEL).

Setting length of the page

Length of 1 page when using the roll media is set.

Only the part that will fit in to the set page length will be cut for the cutting data that is longer than the set page length, and the exceeding part will not be cut.

Reference

- Default setting for page length is 2 m for CE7000-40, and 5 m for CE7000-60/130/160. Check the setting of the page length when cutting long length.
 - * Please be sure to use the basket (option) when cutting something over 2 m long.
- Page ejection quality assurance goes up to 2 m for the CE7000-40 and up to 5m for the CE7000-60/130/160. (It depends on the media specified by Graphtec and setting conditions.)
 - Use the basket (option).
 - Use 3M Scotchcal Series 7725.
 - Set the speed below 30 and the acceleration below 2 (In Simple mode, there is no need to set anything, so it is not available.)
 - Perform pre feed for the amount to be used before cutting.
 - Leave the media in environment to use for adequate time if the deviation of temperature and humidity is big.
 - Set the both push rollers at least 15mm inside the edge of media.
- Set the sideways tension of the media uniform when setting the media when cutting long length. Media might come off the rollers while cutting if it is not uniform.
- Pull out the amount to use before cutting when you are using the roll media.
- To reduce the shifting of the media, perform the pre feed to the full length to be cut (see "Pre Feed of Media (Paper or Marking Film)"). Also, pre feeding can be done automatically when the data is received (see "Perform Automatic Pre Feed When Cut Data is Received", or done automatically when the media is loaded (see "Perform Automatic Pre Feed When Media is Set (Initial Feed)").
 - * Pre feeding will stabilize the feed by acclimating the media, taking out the slack.
- This setting will be saved even if the power is shut off.

Operation

- 1 Press the [PAUSE/MENU] key.

▶ MENU screen is displayed.



- 2 Press the [4] key (MEDIA).

▶ MEDIA SETTING screen (1/2) is displayed.

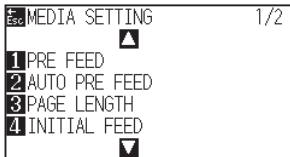

- 3 Press the [3] key (PAGE LENGTH).

▶ PAGE LENGTH screen is displayed.

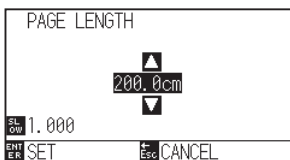

- 4 Press the POSITION (▲▼) keys and increase or decrease the setting value.

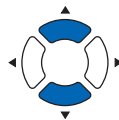

- 5 Confirm the setting and press the [ENTER] key (SET).

▶ Setting will be confirmed and it will return to MEDIA SETTING screen (1/2).

- 6 Press the [PAUSE/MENU] key.

▶ It will return to default screen.

Supplement

Perform the settings in Normal mode.

Supplement

- Press the [SLOW] key to select the setting digits.
- You can set the range between 20.0 and 5000.0 cm.

Supplement

It will return to MEDIA SETTING screen (1/2) without changing the settings when you press the [ESC] key (CANCEL).

Setting mirror

There is a function to mirror the cutting by reversing the origin point and coordinate axes.
Set the MIRROR setting to ON to do mirroring.

Reference

This setting will be saved even if the power is shut off.

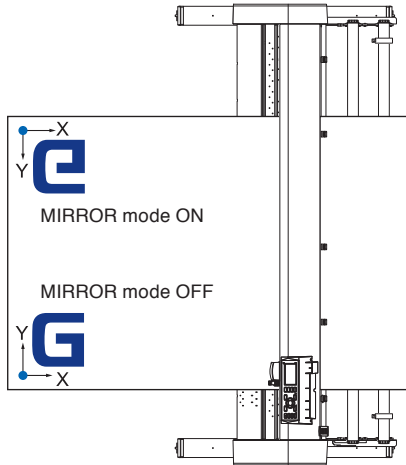

Operation

- 1 Press the [PAUSE/MENU] key.
▶ MENU screen is displayed.



- 2 Press the [3] key (AREA).
▶ AREA PARAMETERS screen (1/2) is displayed.

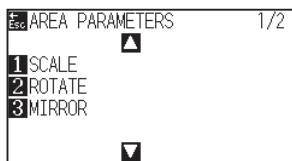

- 3 Press the [3] key (MIRROR).
▶ MIRROR screen is displayed.



Supplement

Perform the settings in Normal mode.

4 Press the [1] key (ON).

Supplement

To cancel the MIRROR, press the [2] key (OFF).

5 Confirm the setting and press the [ENTER] key (SET).

▶ Setting will be confirmed and it will return to AREA PARAMETERS screen (1/2).

Supplement

It will return to AREA PARAMETERS setting screen (1/2) without changing the settings when you press the [ESC] key (CANCEL).

6 Press the [PAUSE/MENU] key.

The tool carriage moves to the coordinate position you set.

▶ It will return to default screen.

Set the enlarge/shrink scale (Scale)

It can enlarge or shrink cutting.

The rate of enlargement or shrinkage of the cutting data can be changed by settings.

Reference

This setting will be saved even if the power is shut off.

Operation

1 Press the [PAUSE/MENU] key.

▶ MENU screen is displayed.



Supplement

Perform the settings in Normal mode.

2 Press the [3] key (AREA).

▶ AREA PARAMETERS screen (1/2) is displayed.

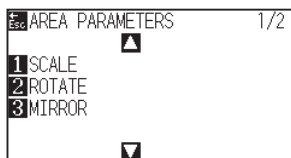

3 Press the [1] key (SCALE).

▶ SCALE screen is displayed.

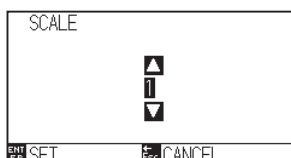

- 4 Press the POSITION (▲▼) key and increase or decrease the setting value.

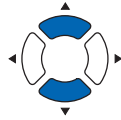

- 5 Confirm the setting and press the [ENTER] key (SET).

▶ Setting will be confirmed and it will return to AREA PARAMETERS screen (1/2).

- 6 Press the [PAUSE/MENU] key.

▶ It will return to default screen.

Supplement

Values that can be set are 1/8, 1/4, 1/2, 1, 2, 3, 4, 5, 6, 7, and 8 (multiplications).

Supplement

It will return to AREA PARAMETERS screen (1/2) without changing the settings when you press the [ESC] key (CANCEL).

4.2 Copy (Duplicate Cutting)

The function to cut specified numbers of cutting data stored in the buffer memory is called COPY.

Supplement

- Do not send new data to plotter while copying. Cutting data in the buffer memory will be cleared.
- Previous cutting data will be cleared and newly sent data will be stored as cutting data if you send new data with 10 seconds or more interval from the time it finished cutting.
- It can not copy if data is more than 1.6 MB because it cannot be stored in the buffer memory of the plotter.
- Buffer memory that can be used for copy will decrease if you turn on the data sort. Turn off the data sort when you need to copy cutting with large data. See "Sorting the Cutting Data" for data sort.
- Watch out that it does not fall out of media when cutting with copy function.
- If the original cutting data to be copied starts away from the origin point, copied cutting will also start away from the origin point.
To avoid wasted space, create the cutting data close to the origin point.
- When copying using a roll paper barcode, be sure to scan the bar code on the the leading edge.

When media change mode is OFF

Copy is performed in following order.

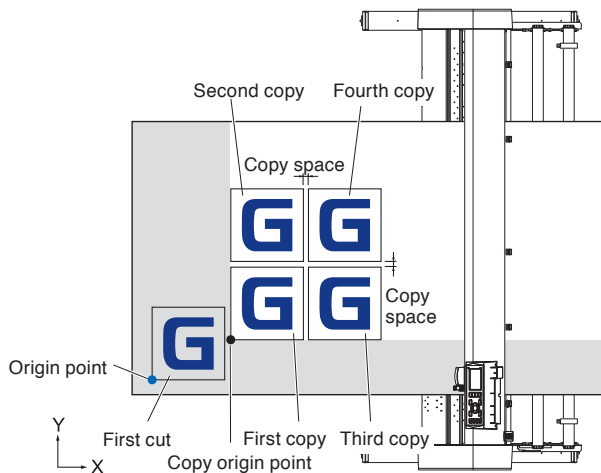

It will copy in following order when MIRROR is set.

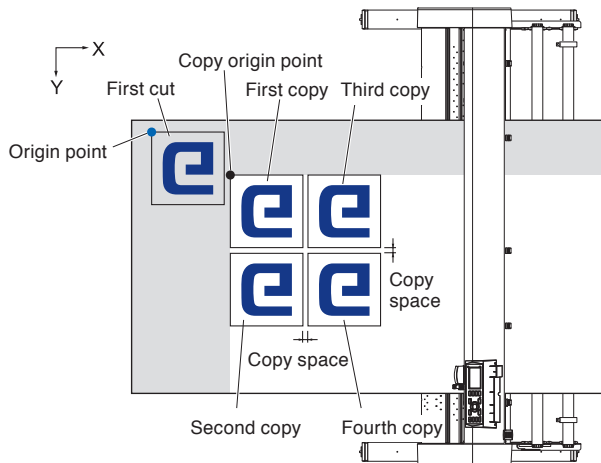

It will copy in following order when COORDINATE AXES ROTATION is set.

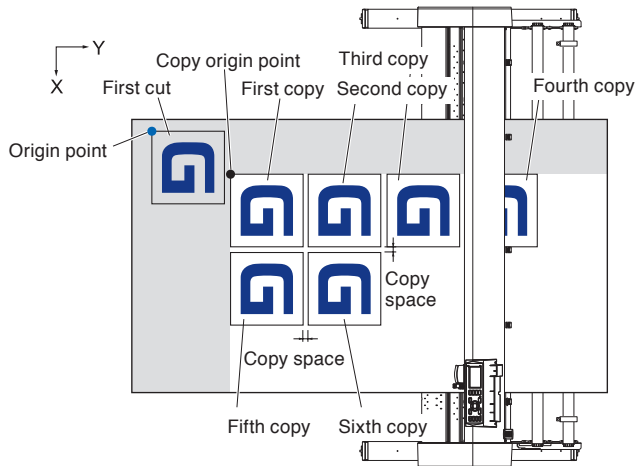

Operation

- 1 Plot (cut) the data you want to copy once.
▶ Cutting data is stored in the buffer memory.
- 2 Press the POSITION (▲▼◀▶) keys and move the tool carriage to the position to copy.

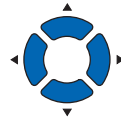

- 3 Press the [COPY] key
▶ COPY MODE screen is displayed.

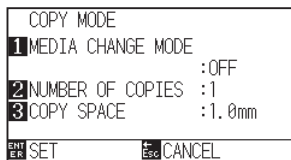

- 4 Press the [1] key (MEDIA CHANGE MODE).
▶ MEDIA CHANGE MODE screen is displayed.

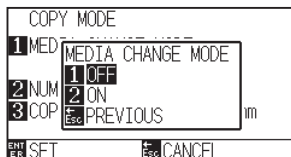

- 5 Press the [1] key (OFF).
▶ Confirm the settings and it will return to the COPY MODE screen.

Supplement

- When setting the copy interval, set "MEDIA CHANGE MODE" to OFF.
- "NO DATA FOR COPY IN BUFFER!" is displayed if there is no data in the buffer memory. Send the cutting data.
- If too much data is sent from the buffer memory, "1 copy in the Copy mode buffer!" will be displayed.
- If the data to be copied is larger than the cutting area, "Cannot copy, the valid area is too small" will be displayed.

6 Press the [2] key (NUMBER OF COPIES).

▶ NUMBER OF COPIES screen is displayed.

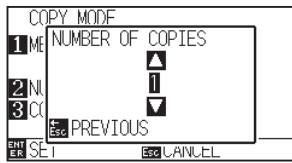

7 Press the POSITION (▲▼) keys and increase or decrease the setting value.

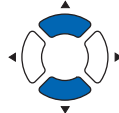

8 Confirm the setting and press the [ESC] key (PREVIOUS).

▶ Number of copies will be selected, and it will return to COPY MODE screen.

Supplement

- Number of copies can be set as much as it can fit in the media set on the printer.
- The initial value for the number of copies is always 1.

9 Press the [3] key (COPY SPACE).

▶ COPY SPACE screen is displayed.

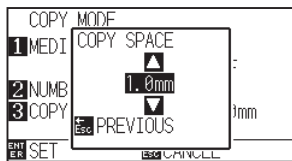

Supplement

"CANNOT COPY CUT AREA TOO SMALL!" is displayed if the cutting area is smaller than the copy data. Either expand the cutting area, or set the media that is big enough to copy.

10 Press the POSITION (▲▼) keys and increase or decrease the setting value.

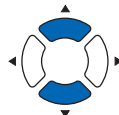

11 Confirm the setting and press the [ESC] key (PREVIOUS).

▶ Copy space will be selected, and it will return to COPY MODE screen.

12 Confirm the setting and press the [ENTER] key (SET).

▶ "COPY" is displayed on the screen, and it will copy as much as specified.

Supplement

- Copy interval can be set when MEDIA CHANGE MODE is turned OFF.
- Copy space can be set from 1.0 mm to 10.0 mm.
- This setting is maintained even if the power is turned off.

Supplement

Cutting data is stored even if the media is exchanged. It can be copied as many times until the buffer memory is cleared. It can be copied again after exchanging the media by pressing [COPY] key.

When media change mode is ON

The Change Media message appears each time when ending a single cut in Media Change mode.

Choosing to change media will instantly detect the media and proceed to a copy area (cut).

Media switch copies can be made up to the set copy number (designated number).

Operation

- 1 Plot (cut) the data you want to copy once.

▶ Cutting data is stored in the buffer memory.

- 2 Press the [COPY] key.

▶ COPY MODE screen is displayed.

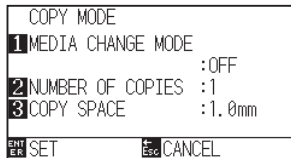

- 3 Press the [1] key (MEDIA CHANGE MODE).

▶ MEDIA CHANGE MODE screen is displayed.

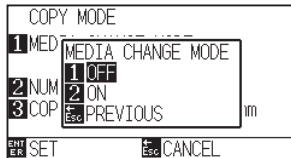

- 4 Press the [2] key (ON).

▶ Confirm the settings and it will return to the COPY MODE screen.

- 5 Press the [2] key (NUMBER OF COPIES).

▶ NUMBER OF COPIES setting screen is displayed.

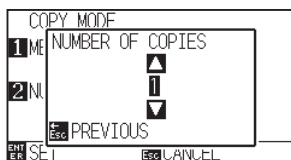

- 6 Press the POSITION (▲▼) keys and increase or decrease the setting value.

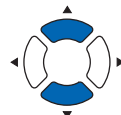

Supplement

- Turning MEDIA CHANGE MODE on will display the CHANGE MEDIA message each time after a single cut.

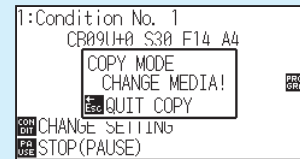

"If the [ESC] key (QUIT COPY) is pressed, copying will be suspended and it will return to the default screen.

- When exchanging media, the media selection will be chosen from what was selected before copying.
- If there is no data in the buffer memory, "There is no data for copying in the buffer" will be displayed. Please send cutting data.
- If too much data is sent from the buffer memory, "1 copy in the Copy mode buffer!" will be displayed.

Supplement

It will return to COPY MODE screen without changing the settings when you press the [ESC] key (PREVIOUS).

Supplement

The copy number can be set from 1 to 100.

- 7 Confirm the setting and press the [ESC] key (PREVIOUS).
▶ NUMBER OF COPIES will be selected and it will return to COPY MODE screen.

- 8 Confirm the setting and press the [ENTER] key (SET).
▶ The plotter starts a copy immediately.

- 9 Replace the media. (When the number of copies is "2" or more)
▶ "COPY MODY CHANGE MEDIA!" will be displayed on the screen.

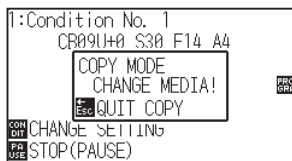

- 10 The plotter starts a copy immediately after replacing the media.

This operation's specified number of copies will be repeated.
To suspend, press the [ESC] key (QUIT COPY).

Supplement

"CANNOT COPY CUT AREA TOO SMALL!" is displayed if the cutting area is smaller than the copy data. Either expand the cutting area, or set the media that is big enough to copy.

Supplement

Cutting data is stored even if the media is exchanged. It can be copied as many times until the buffer memory is cleared. It can be copied again after exchanging the media by pressing [COPY] key.

4.3 Panel Cutting

To prevent skew of long media, utilize Panel Cutting when cutting.

Supplement

- When Panel Cutting is on, the machine will begin by dividing up partition length and continue cutting until one of the following data breaks appears. When the first partitioned area cut is finished, the machine will move to the next area, and repeat this until all areas have been cut.
- Data Breaks:
 - (1) No data sent for a few second after finishing cutting. (Time Out)
 - (2) A feed-related command is set. (GP-GL: F, FS commands, HP-GL: AF, AH, PG commands)
 - (3) HP-GL: SP0, NR, GP-GL: J0, SO.
 - (4) When commands from data breaks (2) and (3) appear, that command work will begin after the Panel Cutting is finished.
- Panel Cutting will continue for each piece of data when a data break is caused by a command, even if multiple pieces of data are sent in before the cutting finishes (even when numerous pieces of Panel Cutting data are in the plotter buffer).
- When Panel Cutting and auto media transfer are both turned on, the machine will ignore automatic media transfer length settings and continue working with priority of partition length plus something minutes ago (with footprints).
- When Panel Cutting is on, and registration marks will not be seen ignored, and copy, initial feed, and cutting area cannot be changed.
- Panel Cutting cannot be done when one file of data makes the buffer full. Make sure to always send in data lower than the buffer size.

Reference

This setting will be saved even if the power is shut off.

Operation

1 Press the [PAUSE/MENU] key.

▶ MENU screen is displayed.



2 Press the [4] key (MEDIA).

▶ MEDIA SETTING screen (1/2) is displayed.

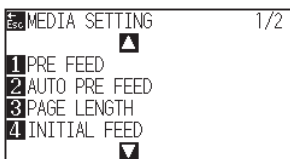

Supplement

Perform the settings in Normal mode.

3 Press the POSITION (▲) key

▶ MEDIA SETTING screen (2/2) is displayed.

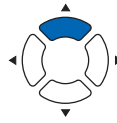
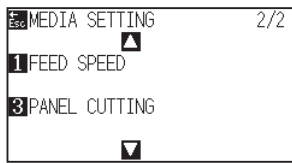

4 Press the [3] key (PANEL CUTTING).

▶ PANEL CUTTING screen is displayed.

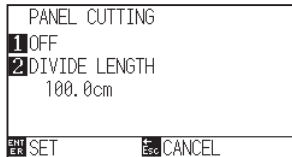

5 Press the [1] key (OFF).

▶ PANEL CUTTING setting screen is displayed.

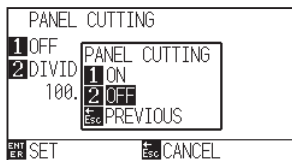

6 Press the [1] key (ON) or the [2] key (OFF).

▶ Setting will be confirmed and it will return to the PANEL CUTTING screen.

7 Press the [2] key (DIVIDE LENGTH).

▶ DIVIDE LENGTH screen is displayed.

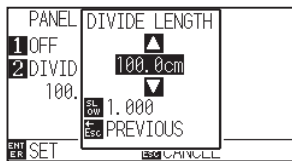

8 Press the POSITION (▲▼) keys and increase or decrease the setting value.

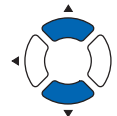

9 Confirm the setting and press the [ENTER] key (SET).

▶ Setting will be confirmed and it will return to the MEDIA SETTING screen (2/2).

10 Press the [PAUSE/MENU] key.

▶ It will return to default screen.

Supplement

- Press the [SLOW] key to select the setting digits.
- The partition length can be set from 1.0 to 2000.0 cm.

Supplement

It will return to MEDIA SETTING screen (2/2) without changing the settings when you press the [ESC] key (PREVIOUS).

Chapter 5: ARMS

(Advanced Registration Mark Sensing System)

ARMS (Advanced Registration Mark Sensing System) is a function to scan the registration mark drawn on the media using sensors.

Tilt of the axes and distance can be adjusted with 2POINTS or 3 POINTS. 2 axes warp adjustment can be adjusted in addition to axes adjustment (tilt) and distance adjustment with 4POINTS.

When cutting the outlines of the printed figure, and when re-cutting media, using ARMS to adjust for printing position discrepancies, high precision cutting can be done.

It is possible to perform a multiple registration mark adjustment or segment area adjustment by linking with the application software on the computer. See the operation guides of the application software about the registration mark adjustment function linked with the application software.

This chapter describes the outline of the ARMS (Advanced Registration Mark Sensing System) and how to setup and use the ARMS on the control panel.

PRODUCT SUMMARY

5.1 Outline of ARMS

5.2 Setting and Adjustment of ARMS

5.1 ***Outline of ARMS***

ARMS (Advanced Registration Mark Sensing System) will scan the registration mark (reference line) written on the media using sensors.

Registration mark scanning accuracy when a designated registration mark is being scanned by this machine is within 0.3 mm.

Please take note of the following when scanning a registration mark.

- Shape (Pattern) of the Registration Mark and Origin Point (Cutting Point)
- Scan Range Necessary to Detect the Registration Mark
- Positioning of the Media and the Registration Mark
- Cutting area when adjusting the registration mark
- Automatic detection of registration mark position
- Media That Registration Mark Cannot be Detected

Shape (Pattern) of the Registration Mark and Origin Point

The shapes (patterns) of the registration mark the plotter can scan are following 4 types.

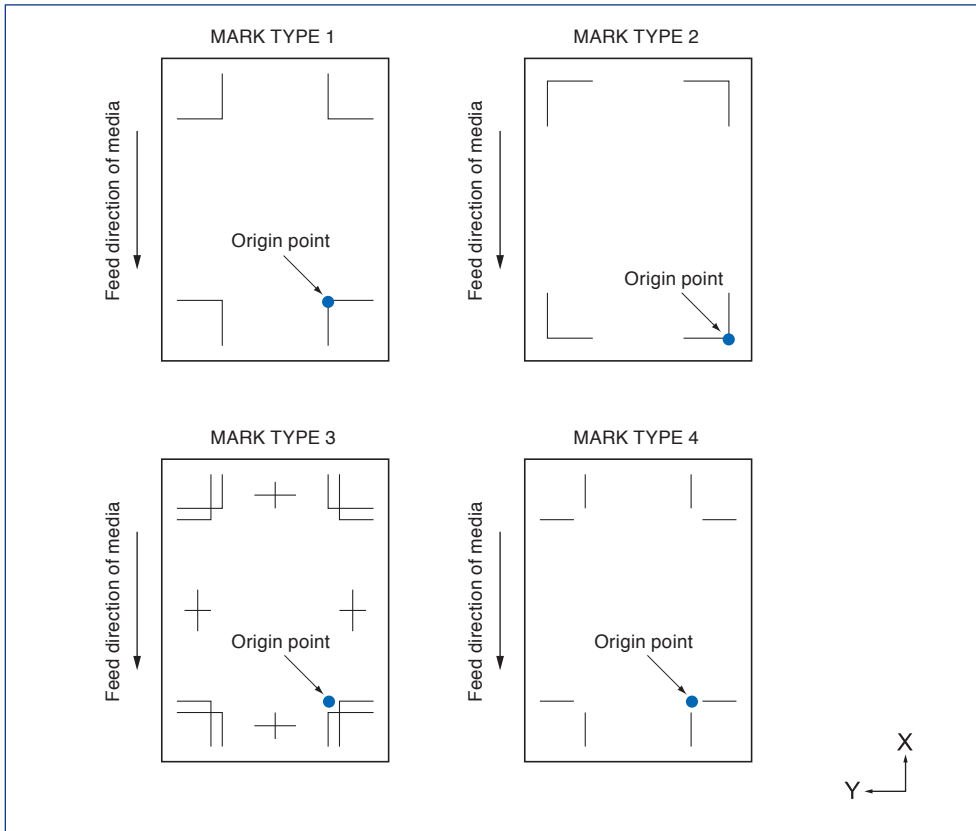

Supplement

- Create the registration mark as a plotting data with the application software. Registration mark pattern 3 and 4 should be created using Adobe Illustrator.
- Create the registration mark in accordance with following conditions.
 - Thickness of the line is between 0.3 to 1.0 mm.
 - Size of the registration mark is between 5 to 20 mm (see "Setting Registration Mark Size").
 - Use pattern 1, pattern 2, pattern 3 or pattern 4 for the shape of the registration mark.
 - Create the registration mark with single line, and specify the thickness of line to necessary thickness. Double line cannot be used.
- Panel Cutting should be switched to OFF.

Scan range necessary to detect the registration mark

The range of tool carriage and media movement needed to scan the registration mark is as following.
Do not print in the shaded area shown in the Figure below.

<For 3POINTS>

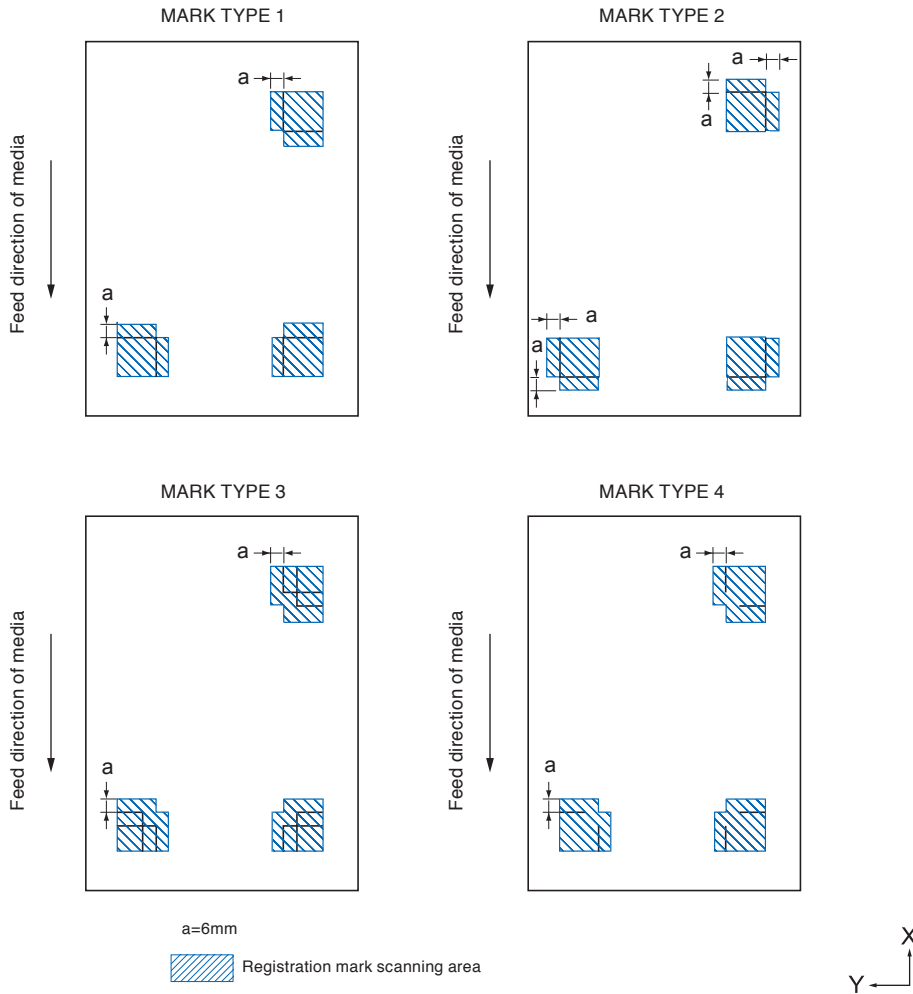

<For 4POINTS>

MARK TYPE 1

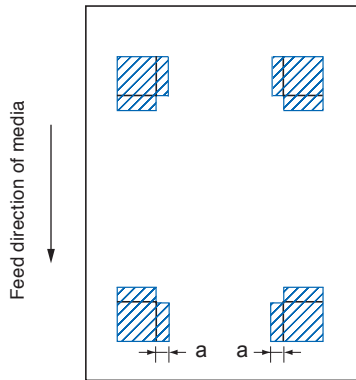

MARK TYPE 2

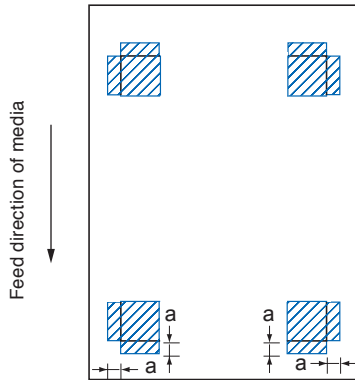

MARK TYPE 1
(There are central registration marks.)

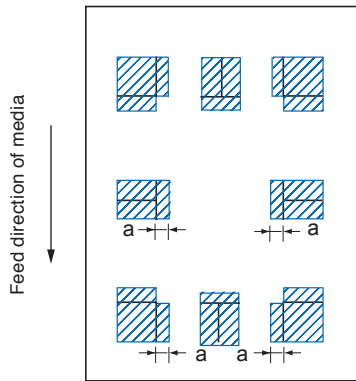

MARK TYPE 2
(There are central registration marks.)

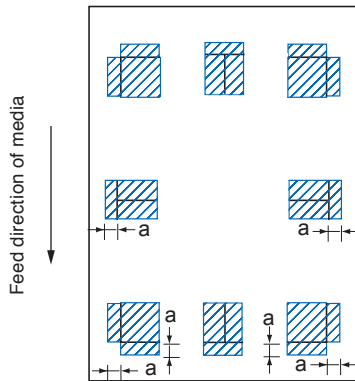

MARK TYPE 3

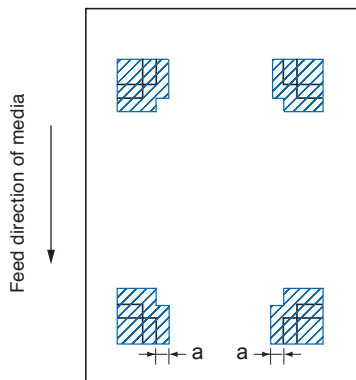

MARK TYPE 4

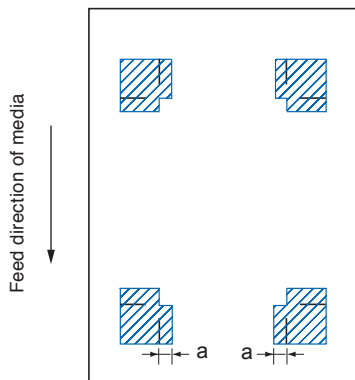

a=6mm

 Registration mark scanning area



Supplement

- Clean any dirt or foreign objects from the media. Any dirt or foreign object might be scanned mistakenly as registration mark.
- Plot the registration mark in contrast easy to scan, such as black lines on white background. Adjust the scanning level of the sensor if you need to use the colored or glossy media. (See "Setting MARK SCAN Mode".)

Positioning of the media and the registration mark

Place the registration mark away from the edge of media to scan the registration mark.
 Make sure the push roller location is outside of the registration mark.
 Draw the registration mark as shown in the next image.

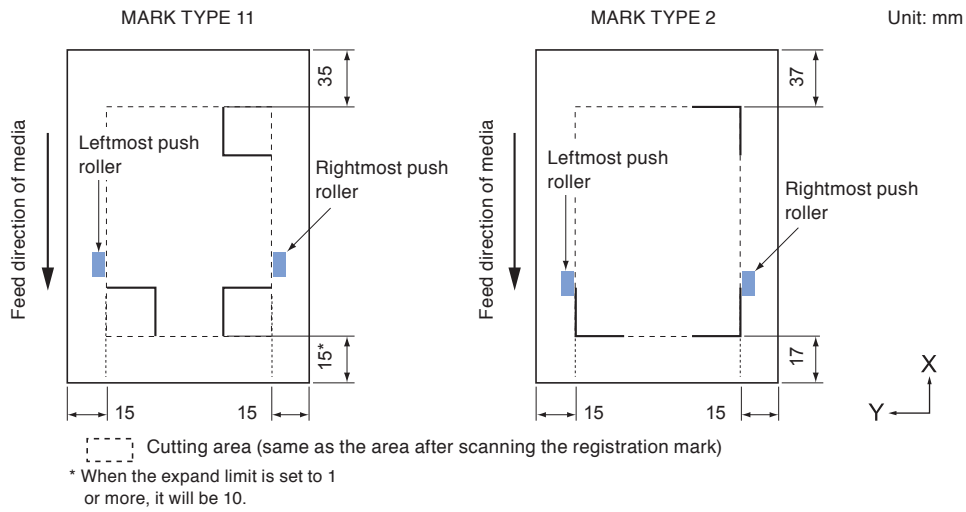

Cutting area when adjusting the registration mark

Even when the registration marks are being adjusted, you can cut the outside of the registration mark (cutting area).

Supplement

If the distortion due to the adjustment is large, there is a possibility that the cutting area is reduced.

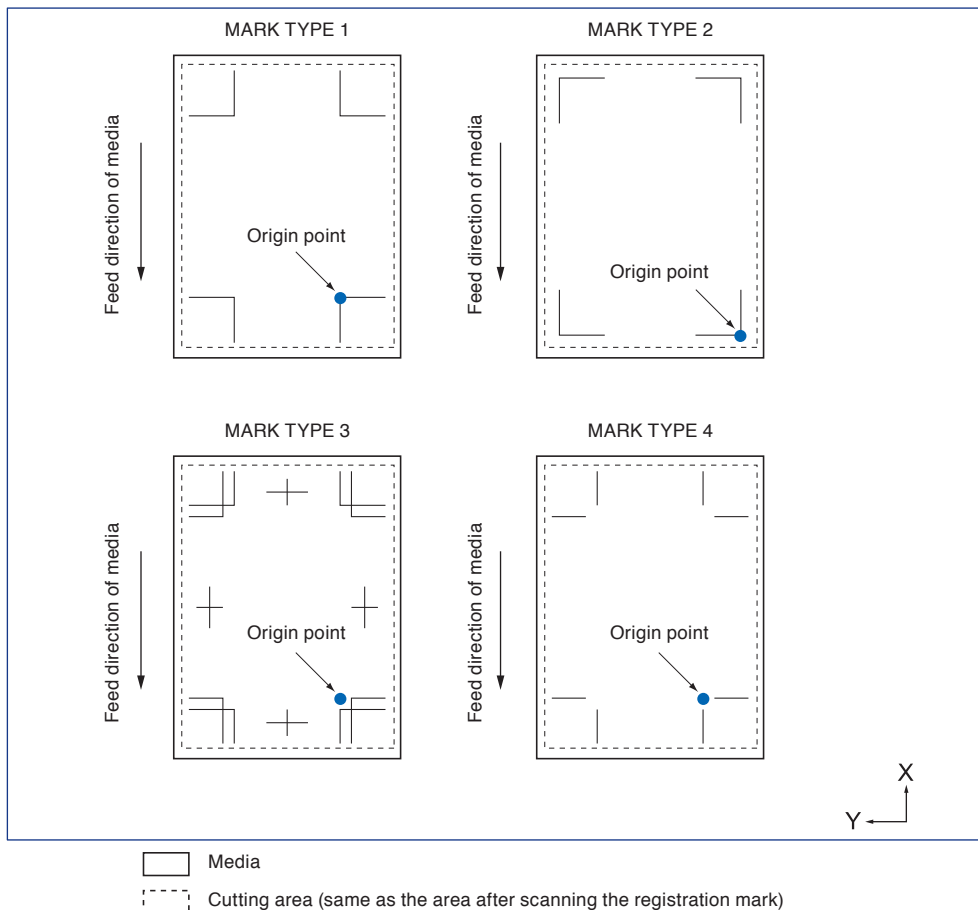

Automatic detection of registration mark position

The registration mark is detected within area A from the registration mark scanning start position (tool position).
When the registration mark is not detected within the area A, then within area B is detected. Only when the registration mark is present in area A or B, it is possible to recognize as the mark.

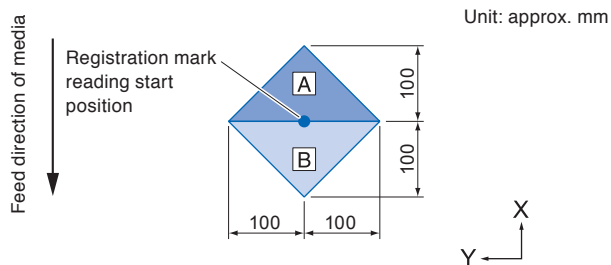

Media that registration mark cannot be detected

It may be hard to scan the registration mark as following, depending on the media conditions.

- Transparent media
- Lines of registration marks are blurred
- Media that does not become an expected color due to the color of the background after printing
- Folded media
- Surface is dirty
- Laminated media (Depending on the type and condition of the laminate)

If you use media that does not have registration marks printed in black on white background, set the automatic detection of registration mark position to OFF. (See "Setting registration mark automatic detection")

In addition, set the MARK SCAN Mode. (See "Set the MARK SCAN Mode".)

5.2 Setting and Adjustment of ARMS

This section describes the necessary adjustment and settings to correctly scan the registration mark with ARMS.

- Set the MARK SCAN Mode
- Checking the recommended setting of registration mark
- Check the lines of registration mark
- Test the registration mark sensor
- Adjust for the registration mark scan position
- Adjust after plotting the adjustment registration mark
- Detect the registration mark for adjustment on the media and enter the value
- Set the registration mark automatic detection
- Set speed of the registration mark scan

Set the MARK SCAN Mode

Select the SCAN Mode of the sensor to scan the registration marks. Select according to the media condition.

Mode 1: Select when using a general medium of white background.

Mode 2: Select when using colored media or glossy media.

Mode 3: Select when the plotter cannot scan in Mode 1 or Mode 2 with a special material.

Use the "RECOMMENDED SETTINGS" function to check the guideline for selecting a SCAN Mode.

In addition, set the registration mark adjustment value as necessary. Set the registration mark adjustment value with "+" or "-".

For Mode 1, judgment is made based on the density of the registration mark. Please set "+" for dark registration marks and "-" for pale registration marks.

For Mode 2 and Mode 3, judgment is made based on the contrast between the background and the register mark. Set it to "+" when the contrast is large, and "-" when it is small.

Operation

- 1 Press the [PAUSE/MENU] key.

▶ MENU screen is displayed.



Supplement

Perform the settings in Normal mode.

- 2 Press the [2] key (ARMS).

▶ ARMS SETTING screen (1/3) is displayed.

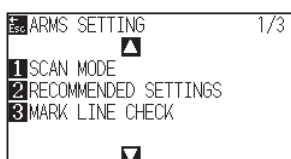

3 Press the [1] key (SCAN MODE).

▶ SCAN MODE screen is displayed.

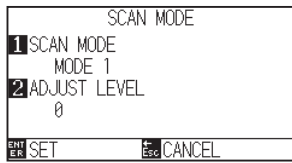

4 Press the [1] key (SCAN MODE).

▶ SCAN MODE screen is displayed.

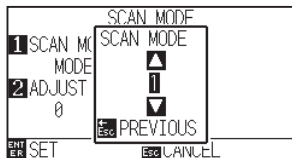

5 Press the POSITION (▲▼) keys and select the mode.

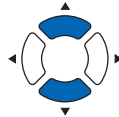

Press the [ESC] key (PREVIOUS).

6 Press the [2] key (ADJUST LEVEL).

▶ ADJUST LEVEL screen is displayed.

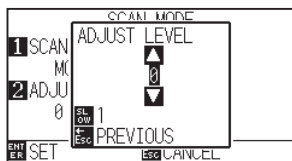

7 Press the POSITION (▲▼) keys and increase or decrease the setting value.

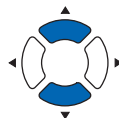

Press the [ESC] key (PREVIOUS).

8 Confirm the setting and press the [ENTER] key (SET).

▶ Setting will be confirmed and it will return to ARMS SETTING screen (1/3).

9 Press the [PAUSE/MENU] key.

▶ It will return to default screen.

Supplement

It will return to ARMS SETTING screen without changing the settings when you press the [ESC] key (PREVIOUS).

Supplement

The adjustment range of SCAN Mode 1 and 2 is -50 to 100, and the adjustment range of SCAN Mode 3 is -50 to 50.

Supplement

Press the [SLOW] key to select the setting digits.

Supplement

It will return to ARMS SETTING screen (1/3) without changing the settings when you press the [ESC] key (CANCEL).

Checking the recommended setting of registration mark

The media condition to be used is detected and then recommended conditions such as scan mode / registration mark color / color of background of registration mark are displayed.

Operation

- 1 Press the [PAUSE/MENU] key.

▶ MENU screen is displayed.

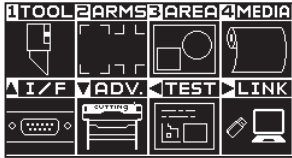

- 2 Press the [2] key (ARMS).

▶ ARMS SETTING screen (1/3) is displayed.

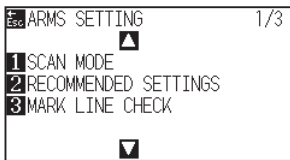

- 3 Press the [2] key (RECOMMENDED SETTINGS).

▶ The following message is displayed.

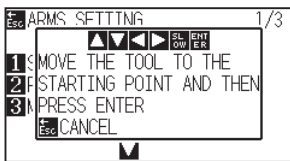

- 4 Press the POSITION (▲▼◀▶) keys to move the tool to the scanning start position (any position).

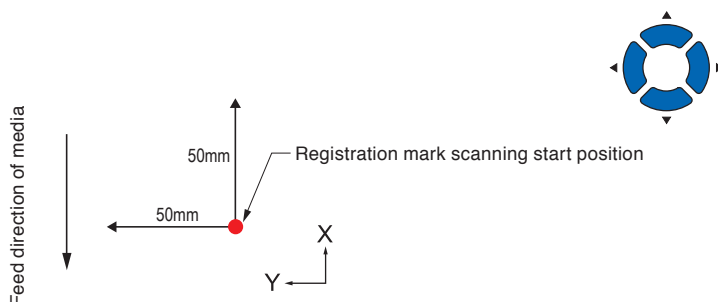

- 5 Confirm the position of the tool and press the [ENTER] key (SET).

- 6 The tool carriage moves and automatically detects the media condition.

The media condition is detected by moving 50 mm in the Y direction and 50 mm in the X direction with respect to the scanning start position.

Supplement

Perform the settings in Normal mode.

Supplement

Do not move the tool carriage to the printed area.

- 7 The appropriate registration mark color is calculated from the detected media condition and the color is displayed.

RECOMMENDED SETTINGS	
SCAN MODE	1
ADJUST LEVEL	0
MARK LINE COLOR	K
BASE PAINT COLOR	-

 CANCEL

SCAN MODE: Recommended scanning mode 1/2/3 is displayed.

ADJUST LEVEL: Recommended registration mark adjustment value is displayed.

MARK LINE COLOR: Recommended color is displayed.

BASE PAINT COLOR: Recommended color is displayed.

Supplement

The display color of "MARK LINE COLOR" is Y: yellow, M: magenta, C: cyan, K: black, W: white, R: red, G: green or B: blue.

- 8 Confirm the setting and press the [ESC] key (CANCEL).

▶ It will return to ARMS SETTING screen (1/3).

- 9 Press the [PAUSE/MENU] key.

▶ It will return to default screen.

Check the lines of registration mark

After detecting registration marks actually, confirm mark scanning operation.

Operation

- 1 Press the [PAUSE/MENU] key.

▶ MENU screen is displayed.

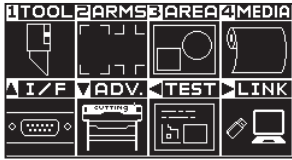

- 2 Press the [2] key (ARMS).

▶ ARMS SETTING screen (1/3) is displayed.

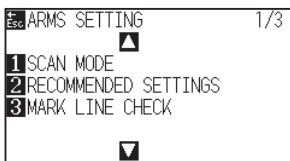

- 3 Press the [3] key (MARK LINE CHECK).

▶ MARK LINE CHECK screen is displayed.

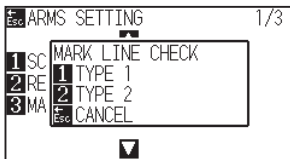

- 4 Press the [1] key (TYPE1) or the [2] key (TYPE2).

▶ The following message is displayed.

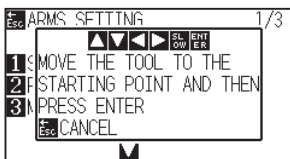

- 5 Press the POSITION (▲▼◀▶) keys to move the tool to the scanning start position (red circle).

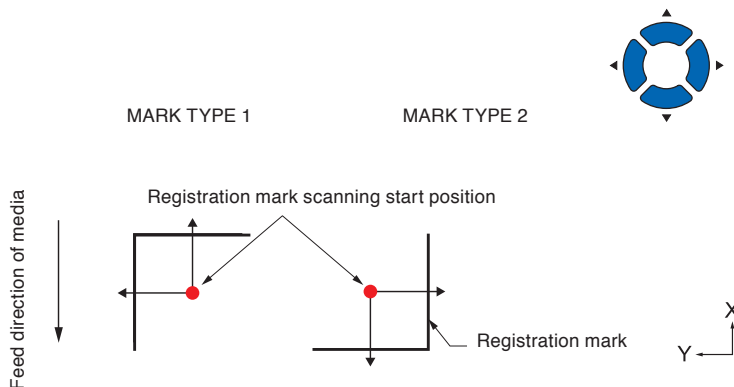

Supplement

Perform the settings in Normal mode.

Supplement

This function is not available when MARK TYPE 3 or MARK TYPE 4 is used.

Supplement

When checking the lines of registration mark using the mask registration mark, set the mask width to 20 mm on the application software.

If it is 20 mm or less, the registration mark lines cannot be checked properly.

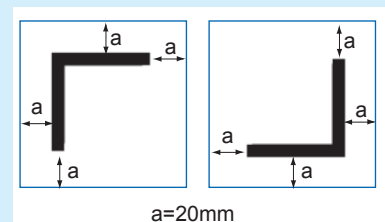

6 Confirm the position of tool and press the [ENTER] key (SET).

7 The scanning result is displayed on the screen.

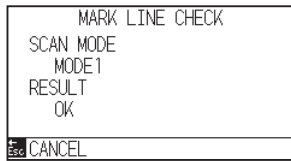

SCAN MODE:

The currently set scanning mode is displayed.

RESULT:

The scanning result (Good / Bad) is displayed.

8 Confirm the setting and press the [ESC] key (CANCEL).

▶ It will return to ARMS SETTING screen (1/3).

9 Press the [PAUSE/MENU] key.

▶ It will return to default screen.

Supplement

In the case of "not good", check the following.

- Check if the registration mark type is correct.
- Check if the SCAN Mode and adjustment value are correct.
- Check the recommended value setting again.
- Make the registration mark line thicker.
- Check the above-mentioned "Media That Registration Mark Cannot be Detected".

Even if the above is done, if it is "not good", the registration mark cannot be used.

Test the registration mark sensor

If there still is a difference in the cutting, even after performing an adjustment using the registration mark, it is possible to check if there is a problem with the registration mark itself or the application by evaluating the position of the registration mark plotted and detected only using the plotter.

CAUTION

This function performs cutting after the registration mark is scanned. If a cutter is used as the tool, it may harm the plotter.

Operation

- 1 Print the standard registration mark.

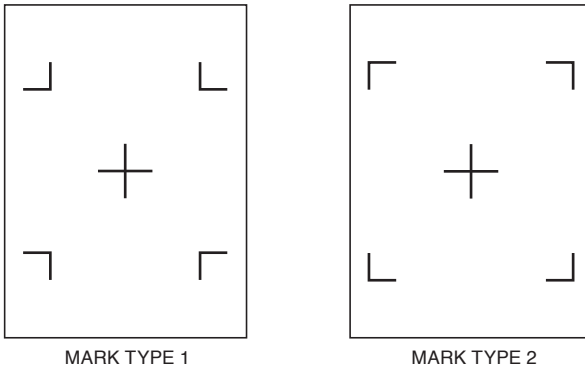

- 2 Load the printed media onto the plotter.

- 3 Press the [PAUSE/MENU] key.

▶ MENU screen is displayed.



- 4 Press the [2] key (ARMS).

▶ ARMS SETTING screen (1/3) is displayed.

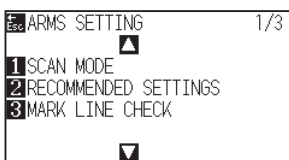

- 5 Press the POSITION (▲) key.

▶ ARMS SETTING screen (2/3) is displayed.

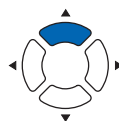
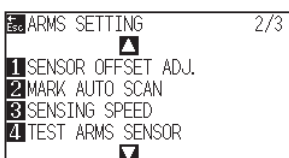

Supplement

- Print the "Test Pattern 1" to test MARK TYPE 1, and "Test Pattern 2" to test MARK TYPE 2.
- Please download the standard registration mark pattern from our website.

Registration Mark Pattern	File Format	File Name
MARK TYPE 1	pdf	ARMStest_type1.pdf
	eps	ARMStest_type1.eps
MARK TYPE 2	pdf	ARMStest_type2.pdf
	eps	ARMStest_type2.eps

Supplement

See "Loading Media (Paper or Marking Film)" for loading the media.

Supplement

Perform the settings in Normal mode.

6 Press the [4] key (TEST ARMS SENSOR).

▶ TEST ARMS SENSOR screen is displayed.

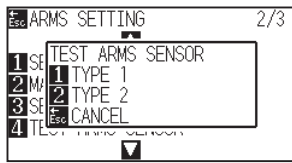

Supplement

It will return to ARMS SETTING screen (2/3) without changing the settings when you press the [ESC] key (CANCEL).

7 Press either the [1] key (TYPE 1) or the [2] key (TYPE 2) depending on the type of the registration mark to be used.

▶ Following message is displayed.

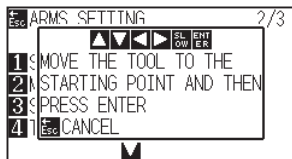

Supplement

It will return to TEST ARMS SENSOR screen without changing the settings when you press the [ESC] key (CANCEL).

8 Move the tool to the position to start scanning of the registration mark by pressing the POSITION (▲▼◀▶) key.

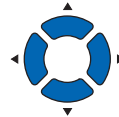

Registration mark scan area

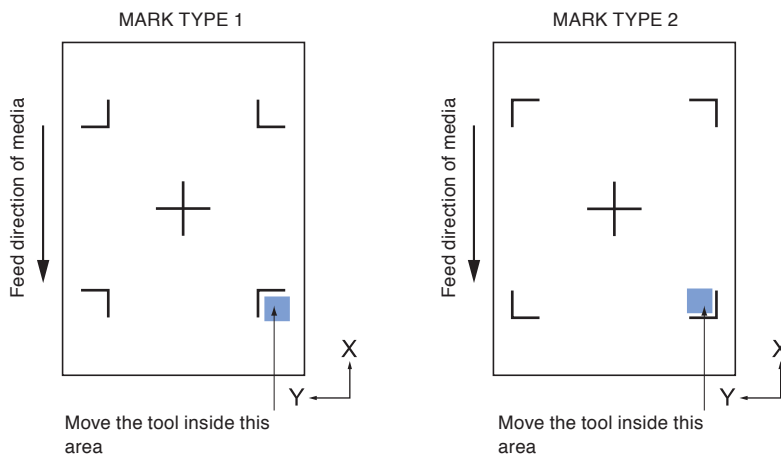

9 Confirm the position of the tool and press the [ENTER] key.

▶ The plotter will automatically detect the registration mark and cut the peak of each registration mark.

Supplement

Following error is displayed when the registration mark was not scanned properly.

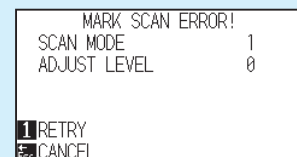

Press the [1] key (RETRY) to scan again, or the [ESC] key (CANCEL) to exit.

10 Confirm the cutting result.

▶ See "Adjusting for the Registration Mark Scan Position" and adjust if the cutting position is shifted.

Adjusting for the registration mark scan position

Sensor to scan the registration mark is positioned away from the tip of the tool (pen tip). Therefore, it is necessary to adjust the coordinate values of the scanned registration mark so it will match with the cutting position.

If the registration mark is already marked on the media, scan that registration mark, plot another registration mark in the same position, and measure the difference between them. This difference is entered as an adjustment value.

If there is no registration mark on the media, plot a registration mark first, scan that registration mark, plot another registration mark, and measure the difference of them. This difference is entered as an adjustment value. When using media and tools for actual use, the adjustment accuracy will be higher.

Reference

There is a restriction on the shape (style) of the registration marks that can be scanned. See "Shape (Pattern) of Registration Mark".

Adjust after plotting the adjustment registration mark

This section describes the steps to plot the registration mark.

Registration mark is to be plotted if there is no registration mark on the media to adjust the registration mark scan position. Subsequently, it continues to "Adjusting the registration mark position".

Reference

Proceed to "Setting the Position Using ARMS" without plotting the registration mark if the registration mark is already drawn on the media.

Operation

- 1 Load white media.
- 2 Set the water-based fiber pen (black) on the tool holder (Backward).
- 3 Press the [PAUSE/MENU] key.
 - ▶ MENU screen is displayed.



Reference

See "Loading Media (Paper or Marking Film)" for loading white media.

Reference

See "Attaching a Tool" for setting the water-based fiber pen. If the water-based fiber-tip pen has been scratched, then it may not be scanned.

Supplement

Perform the settings in Normal mode.

4 Press the [2] key (ARMS).

▶ ARMS SETTING screen (1/3) is displayed.

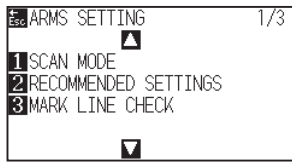

5 Press the POSITION (▲) key.

▶ ARMS SETTING screen (2/3) is displayed.

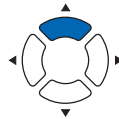
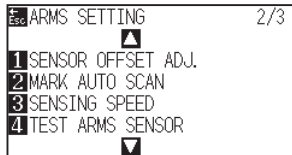

6 Press the [1] key (SENSOR OFFSET ADJ.).

▶ SENSOR OFFSET ADJ. screen is displayed.

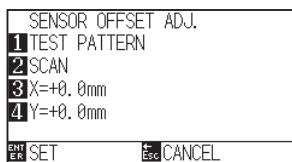

Reference

It will return to ARMS SETTING screen (2/3) without changing the settings when you press the [ESC] key (CANCEL).

7 Press the [1] key (TEST PATTERN).

▶ Following message is displayed.

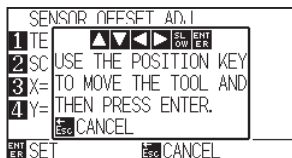

8 Press the POSITION (▲▼◀▶) keys and move the tool carriage to the position to plot the registration mark (position nothing is printed).

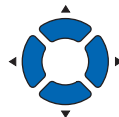

9 Press the [ENTER] key.

▶ A adjustment registration mark is created, and then it will return to SENSOR OFFSET ADJ. screen.

Reference

It will return to SENSOR OFFSET ADJ. screen without plotting by pressing the [ESC] key (CANCEL).

10 Press [2] key (SCAN). The following message is displayed.

► Following message is displayed.

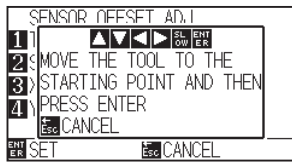

11 Confirm that the tool is at the position shown in the left image (grey square area), and press the [ENTER] key.

► It will scan the registration mark, and then plot the registration mark for comparison. It will return to SENSOR OFFSET ADJ. screen once the plotting is completed.

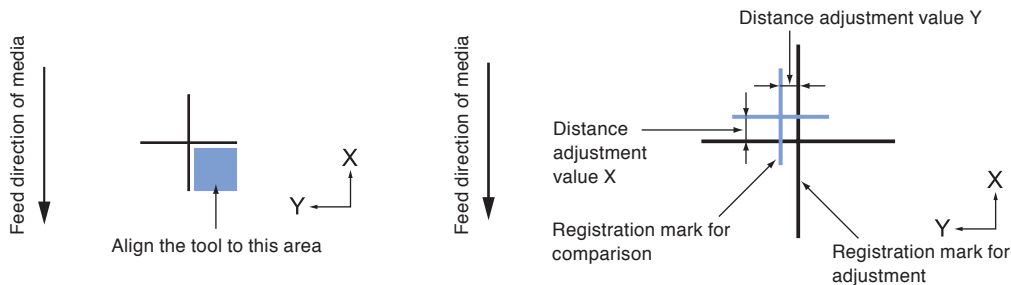

12 Using the registration mark plotted in step 9, measure the distance of how much the adjustment registration mark needs to be moved so both will overlap, and record the value. As an example, in the figure above, it needs to move in negative directions for both X and Y directions, so both of the adjustment values will be negative values.

Supplement

Position of the registration mark is measured at the center of the line.

13 Press the [3] key (X).

► SENSOR OFFSET ADJ. X screen is displayed.

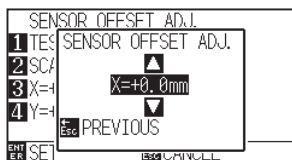

14 Press the POSITION (▲▼) keys and increase or decrease the setting value. Set the X value measured in step 12.

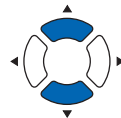

Supplement

You can set the range between -3.0mm and +3.0mm.

15 Confirm the setting and press the [ESC] key (PREVIOUS).

► SENSOR OFFSET ADJ. will be confirmed and it will return to SENSOR OFFSET ADJ. screen.

16 Press the [4] key (Y).

▶ SENSOR OFFSET ADJ. Y screen is displayed.

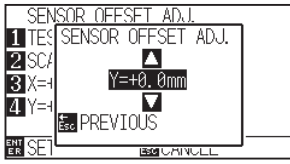

17 Press the POSITION (▲▼) keys and increase or decrease the setting value.

Set the Y value measured in step 12.

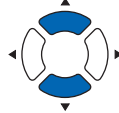

Supplement

You can set the range between -3.0mm and +3.0mm.

18 Confirm the setting and press the [ESC] key (PREVIOUS).

▶ SENSOR OFFSET will be conformed and it will return to SENSOR OFFSET ADJ. screen.

19 Confirm the setting and press the [ENTER] key (SET).

▶ Setting will be confirmed and it will return to ARMS SETTING screen (2/3).

Supplement

It will return to ARMS SETTING screen (2/3) without changing the setting when you press the [ESC] key (CANCEL).

20 Press the [PAUSE/MENU] key.

▶ It will return to the default screen.

Detect the registration mark for adjustment on the media and enter the value

Method to enter the adjustment value, which is the difference between the scanned registration mark on the media and the cutting position, is described here.

Supplement

Plot the registration mark before going to following steps if there is no registration mark drawn on the media. See "Adjust After Plotting the Adjustment Registration Mark" to plot registration marks.

Operation

- 1 Load the media with adjustment registration mark in the plotter.

Supplement

See "Loading Media (Paper or Marking Film)" for loading the media.

- 2 Press the [PAUSE/MENU] key.

▶ MENU screen is displayed.



Supplement

Perform the settings in Normal mode.

- 3 Press the [2] key (ARMS).

▶ ARMS SETTING screen (1/3) is displayed.

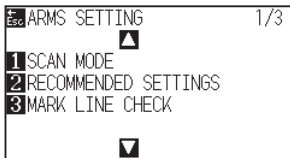

- 4 Press the POSITION (▲) key.

▶ ARMS SETTING screen (2/3) is displayed.

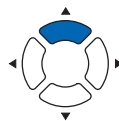
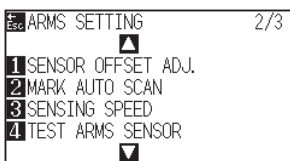

- 5 Press the [1] key (SENSOR OFFSET ADJ.).

▶ SENSOR OFFSET ADJ. screen is displayed.

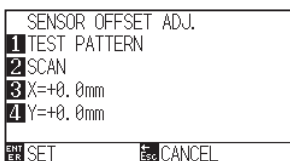

Supplement

It will return to ARMS SETTING screen (3/4) without changing the settings when you press the [ESC] key (CANCEL).

6 Press the [2] key (SCAN).

► Following message is displayed.

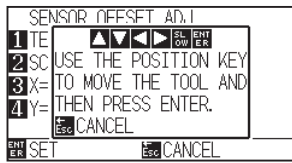

7 Press the POSITION (▲▼◀▶) keys and move the tool carriage to the area to start scanning of the registration mark.

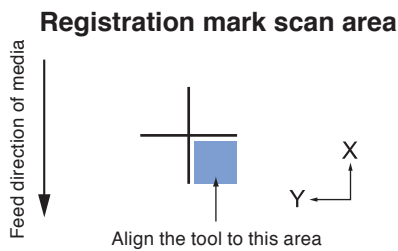
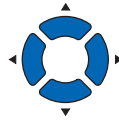

8 Confirm the position of the tool, and if it is OK, press the [ENTER] key.

► The registration mark for comparison is plotted after scanning the registration mark (see below). It will return to SENSOR OFFSET ADJ. screen once the plotting is completed.

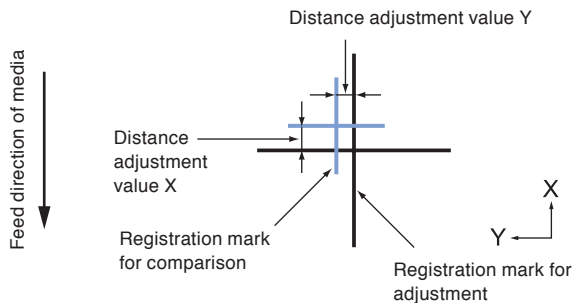

9 Using the scanned registration mark for adjusting, measure the distance of how much the comparison registration mark needs to be moved so both will overlap, and record the value. As an example, in the figure above, it needs to move in negative directions for both X and Y directions, so both of the adjustment values will be a negative values.

10 Press the [3] key (X).

► SENSOR OFFSET ADJ. X screen is displayed.

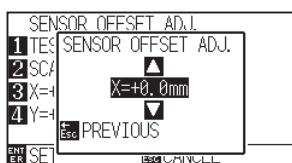

Supplement

It will return to ARMS SETTING screen (3/4) without plotting when you press the [ESC] key (CANCEL).

Supplement

Position of the registration mark is measured at the center of the line.

- 11** Press the POSITION (▲▼) keys and increase or decrease the setting value
Set the X value measured in step 9.

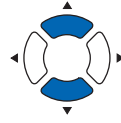

Supplement

You can set the range between -3.0mm and +3.0mm.

- 12** Confirm the setting and press the [ESC] key (PREVIOUS).
▶ SENSOR OFFSET ADJ. is selected and it will return to SENSOR OFFSET ADJ. screen.

- 13** Press the [4] key (Y).
▶ SENSOR OFFSET ADJ. Y screen is displayed.

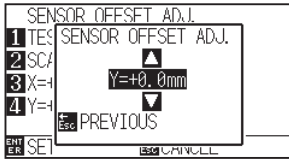

- 14** Press the POSITION (▲▼) keys and increase or decrease the setting value.
Set the Y value measured in step 9.

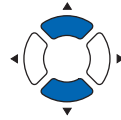

Supplement

You can set the range between -3.0mm and +3.0mm.

- 15** Confirm the setting and press the [ESC] key (PREVIOUS).
▶ SENSOR OFFSET is selected and it will return to SENSOR OFFSET ADJ. screen.

- 16** Confirm the setting and press the [ENTER] key (SET).
▶ Setting will be confirmed and it will return to ARMS SETTING screen (2/3).

- 17** Press the [PAUSE/MENU] key.
▶ It will return to the default screen.

Supplement

It will return to ARMS SETTING screen (2/3) without changing the setting when you press the [ESC] key (CANCEL).

Setting the registration mark automatic detection

When setting the registration mark automatic detection to on, the following operations will be performed.

If the current position of the tool is close to the position of the first registration mark (Point 1) at the time of registration mark automatic detection, the registration mark is automatically scanned without moving the detect start position of tool.

Supplement

If the current position of the tool is distanced from the first registration mark, detection may take a long time, and errors due to not finding anything may occur.

When setting to OFF, the operation above is not performed.

Operation

- 1 Press the [PAUSE/MENU] key.

▶ MENU screen is displayed.



Supplement

Perform the settings in Normal mode.

- 2 Press the [2] key (ARMS).

▶ ARMS SETTING setting screen (1/3) is displayed.

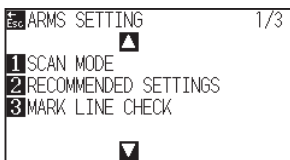

- 3 Press the POSITION (▲) key.

▶ ARMS SETTING screen (2/3) is displayed.

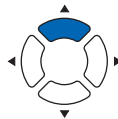
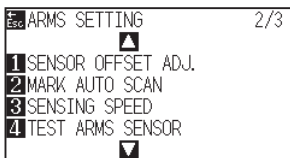

- 4 Press the [2] key (MARK AUTO SCAN).

▶ MARK AUTO SCAN screen is displayed.

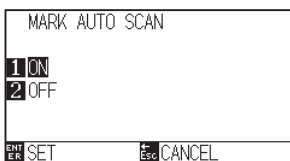

- 5 Press the [1] key (ON) or the [2] key (OFF).

- 6 Confirm the setting and press the [ENTER] key (SET).
 - ▶ Setting will be confirmed and it will return to ARMS SETTING screen (2/3).
- 7 Press the [PAUSE/MENU] key.
 - ▶ It will return to the default screen.

Supplemen

It will return to ARMS SETTING screen (2/3) without changing the settings when you press the [ESC] key (CANCEL).

Setting speed of the registration mark scan

Speed of the tool carriage and media to scan the registration mark is set.

It may not scan the registration marks or the difference may become large when the speed is too high, but the cutting time becomes longer when the speed is too slow. Adjust the setting value considering the balance.

If the registration mark cannot be scanned or the error is large, setting a low (slower) value may improve the scanning.

Operation

- 1 Press the [PAUSE/MENU] key.

▶ MENU screen is displayed.



Supplement

Perform the settings in Normal mode.

- 2 Press the [2] key (ARMS).

▶ ARMS SETTING screen (1/3) is displayed.

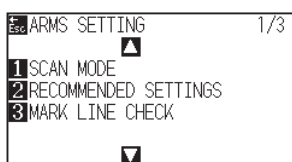

- 3 Press the POSITION (▲) key.

▶ ARMS SETTING screen (2/3) is displayed.

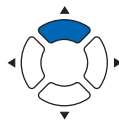
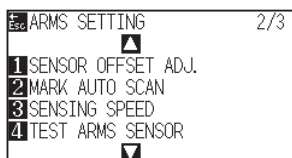

- 4 Press the [3] key (SENSING SPEED).

▶ SENSING SPEED screen is displayed.

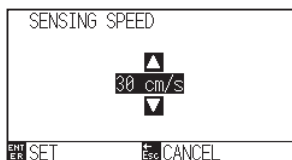

Supplement

It will return to ARMS SETTING screen (2/3) without changing the settings when you press the [ESC] key (CANCEL).

- 5 Press the POSITION (▲▼) keys and increase or decrease the setting value.

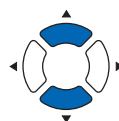

Supplement

You can set the range between 1 and 30 (cm/s).

- 6 Confirm the setting and press the [ENTER] key (SET).
 - ▶ Setting will be confirmed and it will return to ARMS SETTING screen (2/3).
- 7 Press the [PAUSE/MENU] key.
 - ▶ It will return to default screen.

Supplement

It will return to ARMS SETTING screen (2/3) without changing the settings when you press the [ESC] key (CANCEL).

Chapter 6: Manual Position Adjust

Here, we will explain how to match up points while manually confirming the media and tool (cutter pen or plotting pen) points.

The ARMS function can be used for accurately matching up points.

PRODUCT SUMMARY

6.1 *Outline of Manual Position Adjust*

6.2 *Manual Position Adjust*

6.1 Outline of Manual Position Adjust

With manual position adjust, tilt of the axes are adjusted using the 2POINTS, 3POINTS, or 4POINTS adjustment marks (grits or registration marks) as a standard. The distance between each point can also be entered to adjust the distance.

Move the tip of each tool to the appropriate point.

Use the media with prints (adjustment marks such as grits or registration marks) necessary to get XY axes and origin point.

Setting mark scan mode and number of adjustment marks

To perform the AXIS ALIGNMENT, set the MARK SCAN MODE to "AXIS ALIGNMENT".

Select the number of the registration marks (adjustment marks) from 2POINTS, 3POINTS, or 4POINTS when the MARK SCAN MODE is set to "AXIS ALIGNMENT". Position of each adjustment marks are as following.

Adjust with 2POINTS

2POINTS adjustment will scan 2 registration marks aligned in the media transportation direction, where the adjustment is done measuring the tilting of the axis and the distance between the registration marks. This adjustment is 1-axis adjustment (tilt adjustment).

If the loaded media is tilted as shown below, position of the scanned registration mark is shifted from the position where it should be. Tilt and distance can be adjusted by comparing these coordinate values.

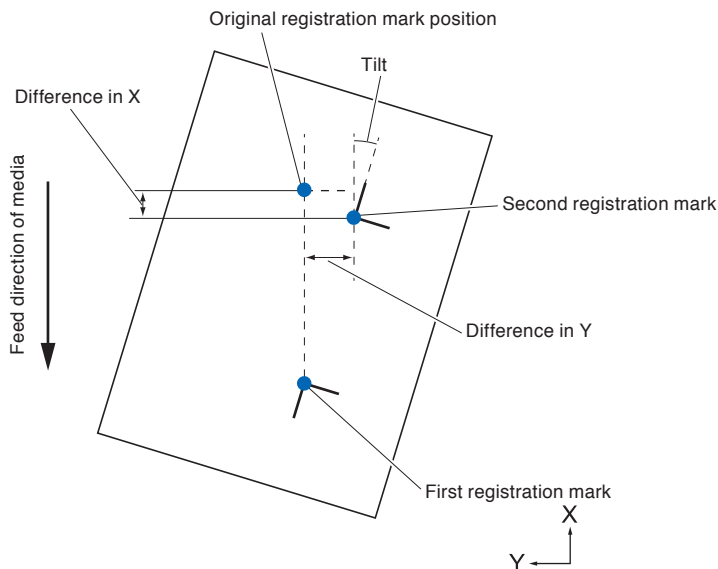

Adjust with 3POINTS

3POINTS adjustment will scan 3 registration marks as shown below, where the adjustment is done measuring the tilting of the X and Y axes and the distance between the registration marks (horizontal and vertical directions). This adjustment is called 2-axis adjustment (tilt adjustment).

If the loaded media is tilted as shown below, position of the scanned registration mark is shifted from the position where it should be. Tilt and distance can be adjusted by comparing these coordinate values.

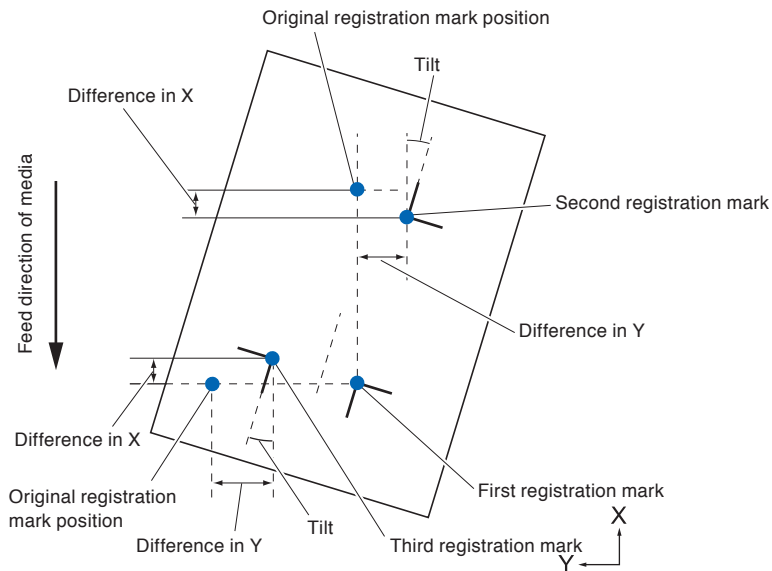

Adjust with 4POINTS

4POINTS adjustment will scan 4 registration marks in the corners, where the adjustment is done measuring the tilting of the X and Y axes and the distance between each of the registration marks. It will perform 2 axes warp adjustment in addition to the 2 axes (tilt) adjustment and distance adjustment, so it can adjust more precisely than other methods.

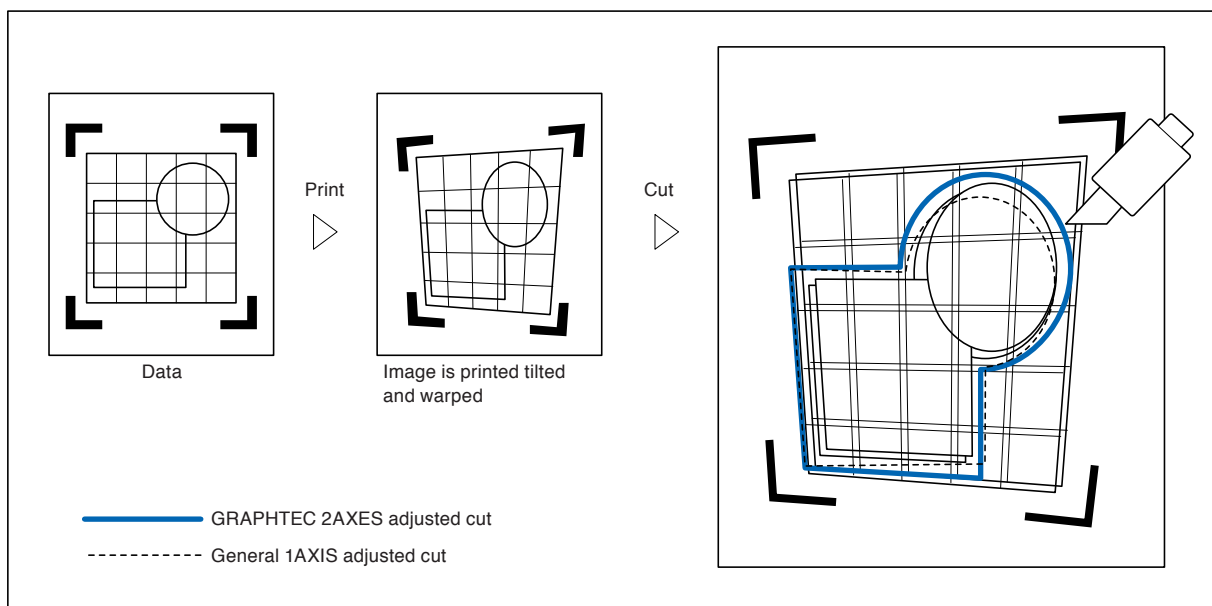

6.2 Manual Position Adjust

Method of manual position adjust is described here.

Supplement

- Adjustment will be cleared if following is done after setting the adjustment.
 - Set new origin point.
 - Set the media again.
 - Set rotation or mirror. (Set the rotation or mirror prior to the axis adjustment)
 Axis adjustment will convert in accordance with rotation or mirror in this case.
- When the inclination of the axis is too large when setting the first and second point, the first and third point, the third and fourth point, or the second and fourth point, "Angle adjustment error, please reset" will be displayed. After setting the media so as to make the inclination small, please perform adjustment operations.
- Axis adjustment will be cleared when point 1 and point 2 is set to same point.

Operation

- 1 Load the media on which the registration mark patterns are printed.

(See "Loading Media (Paper or Marking Film)".)

Supplement

Confirm that the push roller is steadily on the media within the range of media movement. This adjustment is based on assumption that media is slightly tilted. Media might fall off if the tilting of the media is too large.

- 2 Set a cutter plunger or a pen in the tool holder.

- 3 Press the [PAUSE/MENU] key.

▶ MENU screen is displayed.



Supplement

Perform the settings in Normal mode.

- 4 Press the [2] key (ARMS).

▶ ARMS SETTING screen (1/3) is displayed.

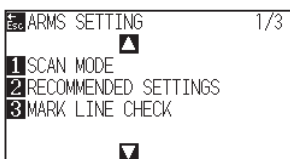

5 Press the POSITION (▼) key.

▶ ARMS SETTING screen (3/3) is displayed.

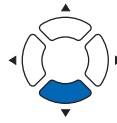
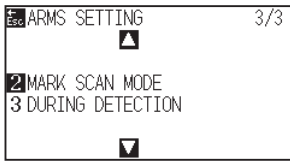

6 Press the [2] key (MARK SCAN MODE).

▶ MARK SCAN MODE screen is displayed.

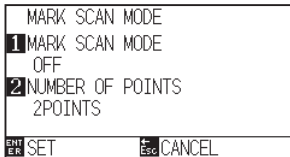

7 Press the [1] key (MARK SCAN MODE).

▶ MARK SCAN MODE setting screen is displayed.

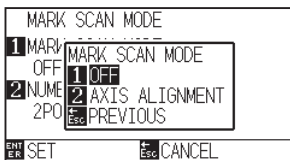

8 Press the [2] key (AXIS ALIGNMENT).

▶ Axis Adjustment Mode will be activated and it will return to the MARK SCAN MODE setting screen.

9 Press the [2] key (NUMBER OF POINTS).

▶ NUMBER OF POINTS screen is displayed.

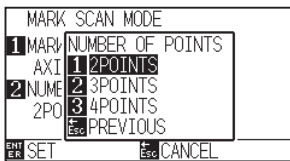

10 Press the [1] key (2POINTS), the [2] key (3POINTS), or the [3] key (4POINTS).

▶ The number of registration marks will be selected and it will return to MARK SCAN MODE screen.

11 Confirm the setting and press the [ENTER] key (SET).

▶ Setting will be confirmed and it will return to ARMS SETTING screen (3/3).

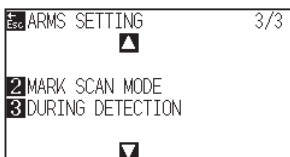

Supplement

It will return to ARMS SETTING screen without changing the setting when you press the [ESC] key (PREVIOUS).

Supplement

It will return to MARK SCAN MODE screen without changing the setting when you press the [ESC] key (PREVIOUS).

12 Press the [3] key (DURING DETECTION).

▶ The following message is displayed.

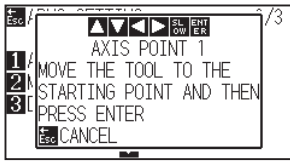

Supplement

If the MARK SCAN MODE screen does not appear, press the [2] key (ARMS) in the MENU screen.

13 Press the POSITION (▲▼◀▶) key to move it to the adjustment mark position.

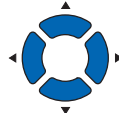

Supplement

Pressing the POSITION and [SLOW] keys at the same time will move the tool carriage slower.

14 Confirm the position of the tool, and if it is OK, press the [ENTER] key (SET).

▶ Once all the adjustment marks are specified, DISTANCE screen is displayed.

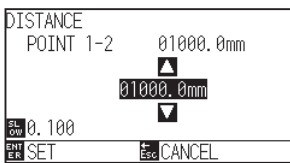

Supplement

- Repeat steps 13 to 14 when the message prompting to move to the next registration mark is displayed.
- Number of times to repeat steps 13 to 14 differs depending on the specified number of the registration mark positions. Follow the message that is displayed.
- It will return to default screen without scanning the settings when you press the [ESC] key (CANCEL).

15 Press the POSITION (▲▼) keys to set the original distance on the data.

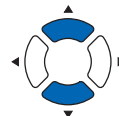

Supplement

- Measured distance is displayed in the top line in the DISTANCE input screen. Input value (initially same as measured value) is displayed under that.
- If the input value is not changed, it will assume that there is no difference between measured distance and the distance in the data.
- Press the [SLOW] key to select the setting digits.

16 Confirm the setting and press the [ENTER] key (SET).

- ▶ The adjustments based on the registration mark scanning will be completed, and it will return to default screen.

Supplement

- It will return to default screen without changing the settings when you press the [ESC] key (CANCEL).
- DISTANCE input screen for point 3 is displayed if it is set to 3POINTS or more, so repeat steps 14 to 16 to set.

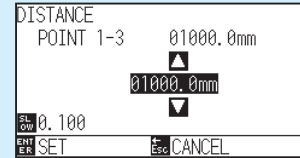

Supplement

Please refer to the following for adjustments when matching the manual position.

- 2 point matching, ["Point 1" settings] ["Point 2" settings] ["Origin point of the axis adjustment" settings] [Finish]
- 3 point matching, ["Point 1" settings] ["Point 2" settings] ["Point 3" settings] ["Distance between Point 1-2" settings] ["Distance between Point 1-3" settings] ["Origin point of the axis adjustment" settings] [Finish]
- 4 point matching, ["Point 1" settings] ["Point 2" settings] ["Point 3" settings] ["Point 4" settings] ["Distance between point 1-2" settings] ["Distance between point 1-3" settings] [Finish]

Chapter 7:

Setting Regarding Cutting Quality

There are times that ideal cutting may not be possible, such as the lines may shift, corners deform, or uncut sections occur, due to the characteristics of the media (thickness, how hard it is, etc.) or the shape of the blades, when the actual cutting is done. Adjust the moving speed and force of the tool, and the control method to prevent these problems.

This chapter describes the setting regarding the quality of the cutting.

PRODUCT SUMMARY

- 7.1 Cutting the Corner of Thick Media Sharp***
- 7.2 Setting the Step Pass***
- 7.3 Setting the Offset Angle***
- 7.4 Setting the Distance Adjust***
- 7.5 Setting Cut Line Pattern***
- 7.6 Setting Initial Blade Control Position Adjust***
- 7.7 Setting the OFFSET FORCE***
- 7.8 Setting Adjustment Between the Tools***

7.1 Cutting the Corner of Thick Media Sharp

Outline of tangential mode

The blade needs to be facing toward the direction of cut when cutting the media. The tip of the blade is shaped as shown so the blade is facing the cutting direction even when it is cutting curved lines or corners. The tip of the blade is off from the rotation axis of the blade (CUTTER OFFSET). The blade will automatically turn and face the cutting direction when the tool carriage moves, because the blade is forced to move from the rotation center, and the blade tip gets resistance by the media.

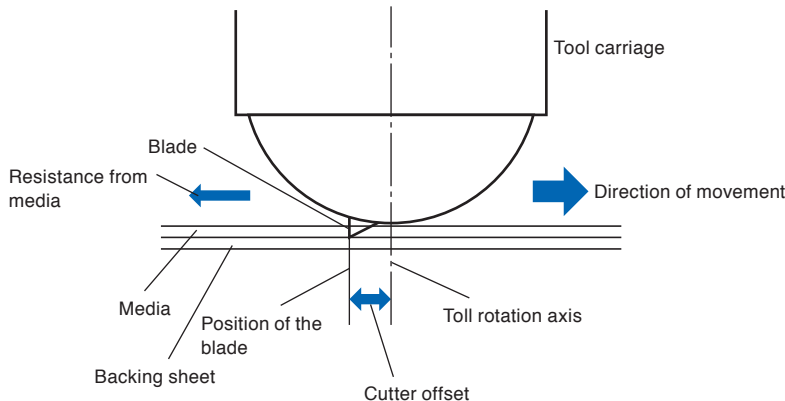

The blade tip gets sunk into the media with 0.3 mm or thicker, making the blade hard to rotate. Especially for the corners where two straight lines meet, cutting becomes very hard because it cannot rotate smoothly.

Tangential mode is a control method to precisely cut corners where two straight lines meet. (See below) With the tangential mode, the blade is advanced so it will overcut at the corners before raising the tool. Then, it will be lowered at the position slightly before the next line, and start to cut with slight overcut.

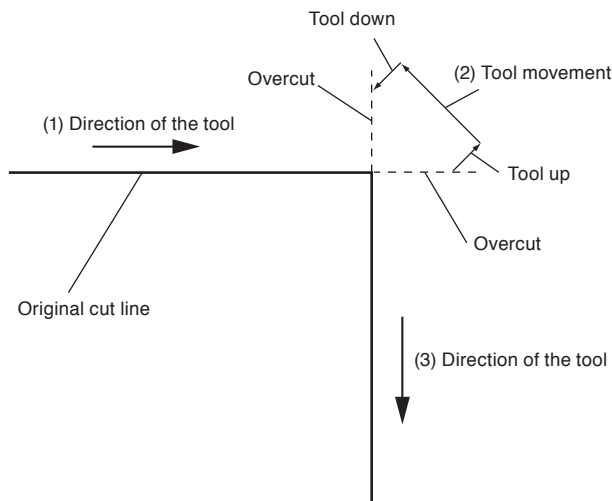

There are 2 modes for tangential mode.

Mode 1 : Overcuts the start and end points and acute-angle corners to eliminate uncut sections. In addition, the cutter blade is moved on the surface of the medium during cutting when it is rotated significantly, ensuring sharp cutting unaffected by the hardness or thickness of the media.

Mode 2 : Overcuts the start and end points only. In addition, the cutter blade is rotated on the medium surface for the start cutting position only. Mode 2 uses simpler cutter control than Mode 1, and provides a shorter cutting time.

The length of the overcuts by tangential mode can be set individually for start of the line and for end of the line.

Setting the tangential mode

Enabled (Mode 1 and Mode 2) and OFF of the tangential mode can be set individually for each of tool condition No. 1 to 8.

Operation

- 1 Press the [COND/TEST] key.

▶ CONDITION setting screen (1/3) is displayed.

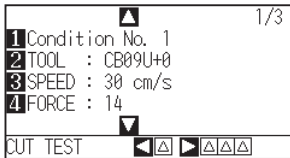

Supplement

Perform the settings in Normal mode.

- 2 Press the POSITION (▲) key.

▶ CONDITION setting screen (2/3) is displayed.

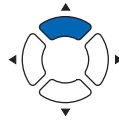
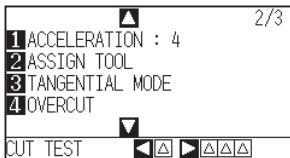

- 3 Press the [3] key (TANGENTIAL MODE).

▶ TANGENTIAL MODE screen is displayed.

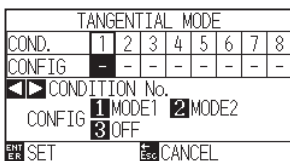

- 4 Press the POSITION (◀▶) keys and select the tool condition number (CONDITION No.).

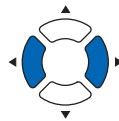

- 5 Press the [1] key (MODE1), the [2] key (MODE2), or the [3] key (OFF) to select the mode.

- 6 Confirm the setting and press the [ENTER] key (SET).

▶ Setting will be confirmed and it will return to CONDITION setting screen (2/3).

- 7 Press the [COND/TEST] key.

▶ It will return to default screen.

Supplement

It will return to CONDITION setting screen (2/3) without changing the settings when you press the [ESC] key (CANCEL).

Setting the length of overcut

Set the length of overcut with tangential mode.

Operation

- 1 Press the [COND/TEST] key.

▶ CONDITION setting screen (1/3) is displayed.

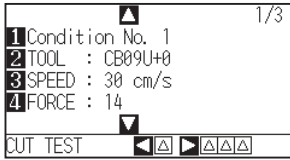

- 2 Press the POSITION (▲) key.

▶ CONDITION setting screen (2/3) is displayed.

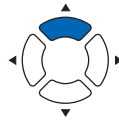
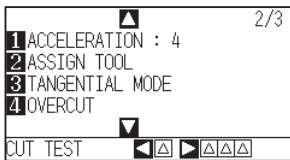

- 3 Press the [4] key (OVERCUT).

▶ OVERCUT screen is display

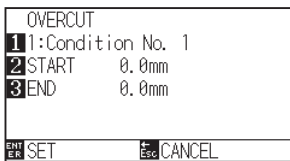

- 4 Press the [1] key (Condition No.)

▶ CONDITION No. screen is displayed.

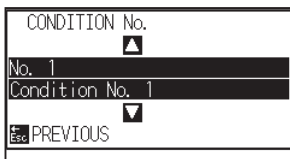

- 5 Press the POSITION (▲▼) keys and select the CONDITION No.

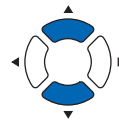

- 6 Confirm the setting, and press the [ESC] key (PREVIOUS).

▶ Condition No. will be selected and it will return to OVERCUT screen.

Supplement

Perform the settings in Normal mode.

Supplement

It is enabled when Tangential Mode is set.

When it is set to OFF, the screen below will be displayed.

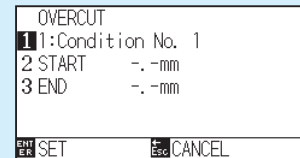

7 Press the [2] key (START).

▶ START screen is displayed.

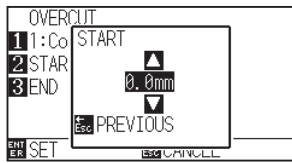

8 Press the POSITION (▲▼) keys and increase or decrease the setting value.

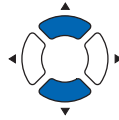

Supplement

You can set the range between 0.0 mm and 0.9 mm.

9 Confirm the setting and press the [ESC] key (PREVIOUS).

▶ Length for overcut START is selected and return to OVERCUT setting screen.

10 Press the [3] key (END).

▶ Overcut length for END setting screen is displayed.

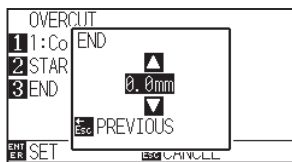

11 Press the POSITION (▲▼) keys and increase or decrease the setting value.

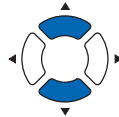

Supplement

You can set the range between 0.0 mm and 0.9 mm.

12 Confirm the setting and press the [ESC] key (PREVIOUS).

▶ Length for overcut END will be selected and it will return to OVERCUT screen.

13 Repeat steps 3 to 12 as necessary to set multiple tool CONDITION No.

14 Confirm the setting and press the [ENTER] key (SET).

▶ Setting will be confirmed and it will return to CONDITION setting screen (2/3).

Supplement

It will return to CONDITION setting screen (2/3) without changing the settings when you press the [ESC] key (CANCEL).

15 Press the [COND/TEST] key.

▶ It will return to default screen.

Setting of the Initial Down Force

The initial down-force setting is effective when tangential mode is selected.

Tangential mode is generally used for the cutting of thick media. With thick film, additional time is required for the cutter blade to penetrate the media fully, even when the necessary cutting force is applied.

The cutting operation starts before the cutter blade has fully penetrated the media, causing uncut sections to be left.

When the initial down force is specified, this force is used as the cutting force immediately after the lowering of the tool when tangential mode is selected, enabling the cutter blade to penetrate the media rapidly. (As an example, if the cutting force is 25 and the initial down force is 4, for example, the cutting force applied immediately after the pen is lowered will be 29.) The upper limit for added value is 38.

Operation

- 1 Press the [COND/TEST] key.

▶ CONDITION setting screen (1/3) is displayed.

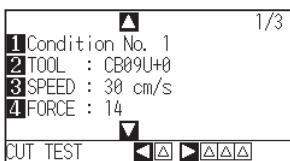

Supplement

Perform the settings in Normal mode.

- 2 Press the POSITION (▼) key.

▶ CONDITION setting screen (3/3) is displayed.

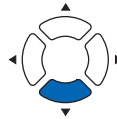
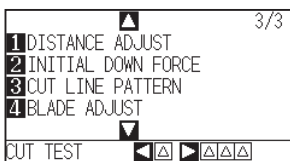

- 3 Press the [2] key (INITIAL DOWN FORCE).

▶ INITIAL DOWN FORCE screen is displayed.

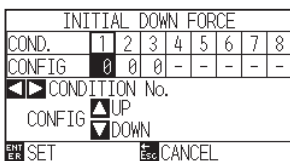

- 4 Press the POSITION (◀▶) keys and select the CONDITION No.

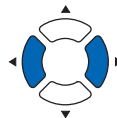

- 5 Press the POSITION (▲▼) keys and increase or decrease the setting value.

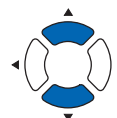

Supplement

You can set the range between 0 and 20.

- 6 Confirm the setting and press the [ENTER] key (SET).
 - ▶ Setting will be confirmed and it will return to CONDITION setting screen (3/3).

- 7 Press the [COND/TEST] key.
 - ▶ It will return to default screen.

Supplement

It will return to CONDITION setting screen (3/3) without changing the settings when you press the [ESC] key (CANCEL).

7.2 Setting the Step Pass

It may not cut the curved line smoothly if there is very short lines in the curve.

It will cut in the units of the specified value when the STEP PASS is used, which allows to control the short lines with certain length, resulting to stable rotation of the blade for higher cut quality.

Setting range of STEP PASS is from 0 to 20.

Actual length of the STEP PASS is the value of the STEP PASS multiplied by the distance set in the "STEP SIZE".

Supplement

- This setting will be saved even if the power is shut off.
- The cut image may not be what you intended if the set value is too large. It is recommended to set to "1" for normal use.

Operation

1 Press the [PAUSE/MENU] key.

▶ MENU screen is displayed.

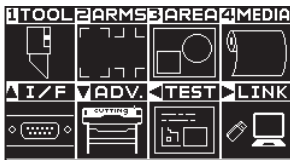

Supplement

Perform the settings in Normal mode.

2 Press the [1] key (TOOL).

▶ TOOLS SETTING screen (1/4) is displayed.

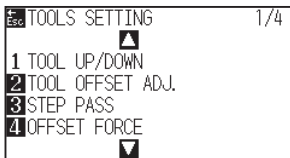

3 Press the [3] key (STEP PASS).

▶ STEP PASS screen is displayed.

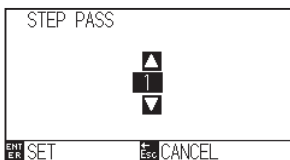

4 Press the POSITION (▲▼) keys and increase or decrease the setting value.

Supplement

You can set the range between 0 and 20.

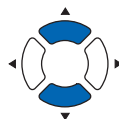

- 5 Confirm the setting and press the [ENTER] key (SET).
 - ▶ Setting will be confirmed and it will return to TOOLS SETTING screen (1/4).

- 6 Press the [PAUSE/MENU] key.
 - ▶ It will return to default screen.

Supplement

It will return to TOOLS SETTING screen (1/4) without changing the settings when you press the [ESC] key (CANCEL).

7.3 Setting the Offset Angle

The CE7000 analyzes the cutting data, and controls the angle of the cutter blade tip if the change in the angles of the corner is large.

Angle control is applied if there is larger angle change than the angle specified as reference angle.

The time to cut is shortened by setting large value for the reference angle, since it will only apply blade control when there are angles with large angle change, hence reducing the time to make the blade control.

But, if it is set too large, there will be not enough angle control of the blade, and the cut result may differ from what was expected. Set the reference angle in good balance.

Supplement

The setting will be saved even if the power is shut off.

Operation

- 1 Press the [PAUSE/MENU] key.

▶ MENU screen is displayed.

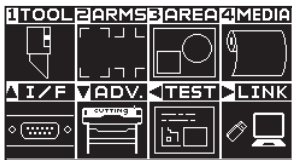

Supplement

Perform the settings in Normal mode.

- 2 Press the [1] key (TOOL).

▶ TOOLS SETTING screen (1/4) is displayed.

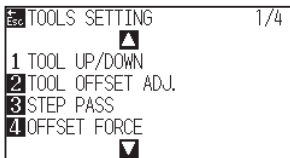

- 3 Press the POSITION (▲) key.

▶ TOOLS SETTING screen (2/4) is displayed.

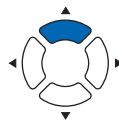
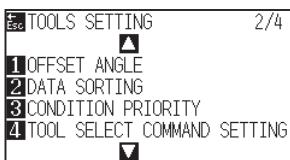

- 4 Press the [1] key (OFFSET ANGLE).

▶ OFFSET ANGLE screen is displayed.

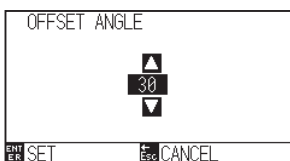

- 5 Press the POSITION (▲▼) keys and increase or decrease the setting value.

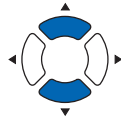

- 6 Confirm the setting and press the [ENTER] key (SET).
▶ Setting will be confirmed and it will return to TOOLS SETTING screen (1/4).

- 7 Press the [PAUSE/MENU] key.
▶ It will return to default screen.

Supplement

You can set the range between 0 and 60.

Supplement

It will return to TOOLS SETTING screen (1/4) without changing the settings when you press the [ESC] key (CANCEL).

7.4 Setting the Distance Adjust

DISTANCE ADJUST value corrects any deviation in the length of cut or plotted line segments, which occurs depending on the media being used. DISTANCE ADJUST value for the deviation is specified as a percentage of the total distance. For example, a setting of +0.05% adjusts a distance of 2 m (2,000 mm) by $2,000 \times 0.05\% = 1$ mm, making 2,001 mm. DISTANCE ADJUST can be specified for each CONDITION No.

Supplement

This setting will be saved even if the power is shut off.

Operation

- 1 Press the [COND/TEST] key.

▶ CONDITION setting screen (1/3) is displayed.

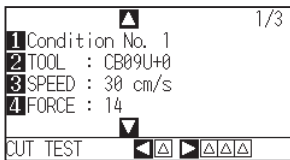

Supplement

Perform the settings in Normal mode.

- 2 Press the POSITION (▼) key.

▶ CONDITION setting screen (3/3) is displayed.

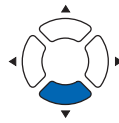
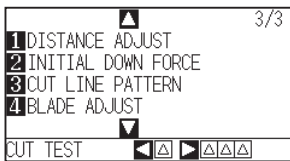

- 3 Press the [1] key (DISTANCE ADJUST).

▶ D. ADJ. screen is displayed.

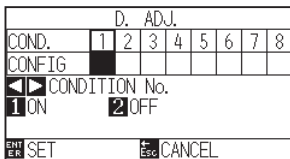

- 4 Press the POSITION (◀▶) keys and select the CONDITION No.

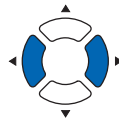

5 Press the [1] key (ON).

▶ DISTANCE ADJUST becomes ON and [3] key (X) and [4] key (Y) becomes enabled.

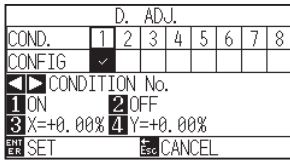

6 Press the [3] key (X).

▶ X DISTANCE ADJUST screen is displayed.

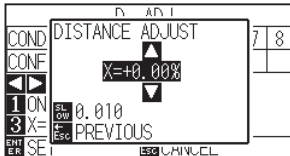

7 Press the POSITION (▲▼) keys and increase or decrease the setting value.

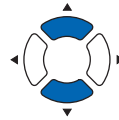

8 Confirm the setting and press the [ESC] key (PREVIOUS).

▶ X DISTANCE ADJUST will be confirmed and it will return to D. ADJ. screen

9 Press the [4] key (Y).

▶ Y DISTANCE ADJUST screen is displayed.

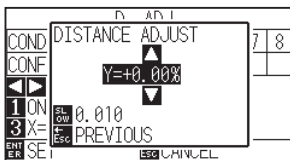

10 Press the POSITION (▲▼) keys and increase or decrease the setting value.

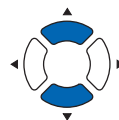

11 Confirm the setting and press the [ESC] key (PREVIOUS).

▶ Y DISTANCE ADJUST will be confirmed and it will return to D. ADJ. screen.

Supplement

- You can set the range between -2.00% and +2.00%.
- Press the [SLOW] key to select the setting digits.

Supplement

- You can set the range between -2.00% and +2.00%.
- Press the [SLOW] key to select the setting digits.

- 12** Confirm the setting and press the [ENTER] key (SET).
- ▶ Setting will be confirmed and it will return to CONDITION setting screen (3/3).

- 13** Press the [PAUSE/MENU] key.
- ▶ It will return to default screen.

Supplement

It will return to CONDITION setting screen (3/3) without changing the settings when you press the [ESC] key (CANCEL).

7.5 Setting Cut Line Pattern

Lines can be cut with perforated lines so the cut parts will not fall off. There are 8 different patterns of perforated lines set as 0 to 7, and the ratio of cut and uncut part differs in each (tool is raised or the force is decreased for following length every 8 mm of the cut). The uncut part becomes shorter with smaller value, making it easier to separate the cut parts.

- Pattern 0: 0.15 mm • Pattern 1: 0.20 mm • Pattern 2: 0.25 mm • Pattern 3: 0.30 mm
- Pattern 4: 0.35 mm • Pattern 5: 0.40 mm • Pattern 6: 0.45 mm • Pattern 7: 0.50 mm

In addition to above 8 patterns, "OFF" which cuts by the solid line without perforation patter and "USER" where user can specify a unique pattern are provided.

The processing in the part is not cut with perforation patter is adjusted in "UP mode".

The perforation patter can be set for each condition number.

Supplement

- Normally use it with default value OFF. It will cut with solid line.
- Use Tool Holder (forward) when cutting with any perforation pattern (aside from turning it off).

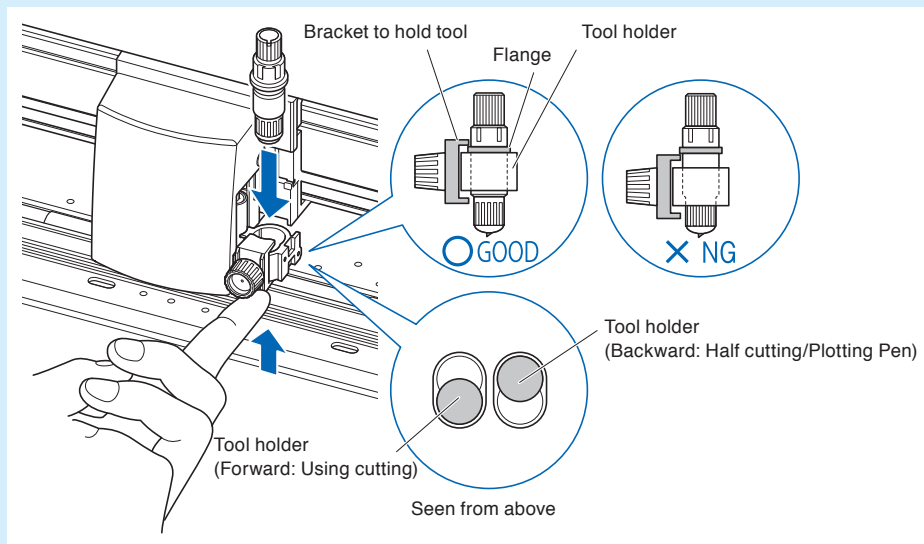

- Doing a cut-out (cutting out) with a perforated pattern instead of a normal film cut (half cutting) can damage the cutting mat and the quality of a normal cut. Please make sure to use Tool Holder (backward).
- Replacing a cutting mat that was damaged by doing a perforated cut with use of Tool Holder (backward) will require a service fee.
- When the tool number is switched between the Tool No. 1 and the Tool No. 3 using the command from the computer, the following message will appear.

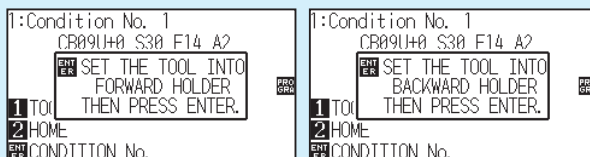

Please follow the message's instructions.

- The cut on the perforation pattern is shortened by 5 mm on the +X side (back of the media).

Operation

- 1 Press the [COND/TEST] key.

▶ CONDITION setting screen (1/3) is displayed.

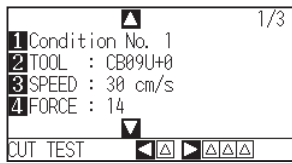

Supplement

Perform the settings in Normal mode.

- 2 Press the POSITION (▼) key.

▶ CONDITION setting screen (3/3) is displayed.

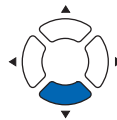
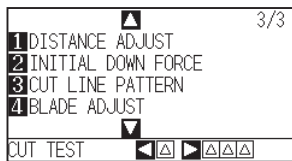

Supplement

It will return to default screen without changing the settings when you press the [CONDITION] key.

- 3 Press the [3] key (CUT LINE PATTERN).

▶ CUT LINE PATTERN screen is displayed.

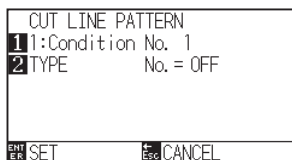

- 4 Press the [1] key (Condition No.).

▶ CONDITION No. screen is displayed.

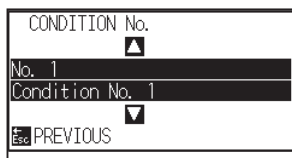

- 5 Press the POSITION (▲▼) key and select the CONDITION No.

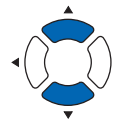

- 6 Confirm the setting and press the [ESC] key (PREVIOUS).

▶ CONDITION No. will be selected and it will return to CUT LINE PATTERN screen.

7 Press the [2] key (TYPE No.).

▶ TYPE No. screen is displayed.

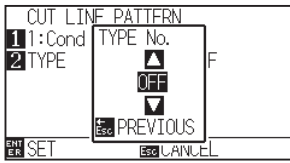

8 Press the POSITION (▲▼) keys and select the TYPE No.

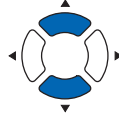

9 Confirm the setting and press the [ESC] key (PREVIOUS).

▶ TYPE No. will be selected and it will return to CUT LINE PATTERN screen.

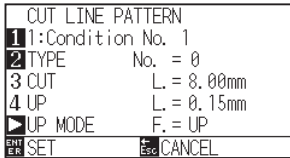

Supplement

- CUT L and UP L is displayed when the TYPE No. 0-7 is selected. Also, you will be able to set the UP MODE.
- Setting for all becomes enabled when USER is selected.
- Nothing will be displayed when "OFF" is selected.

10 Press the POSITION (▶) key (UP MODE).

▶ UP MODE screen is displayed.

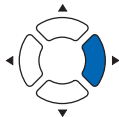
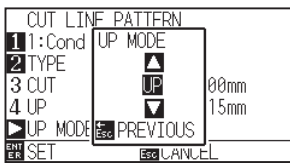

Supplement

You can set the range between 1 and 38, and "UP".

11 Press the POSITION (▲▼) keys and set the UP MODE.

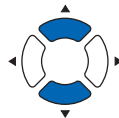

12 Confirm the setting and press the [ESC] key (PREVIOUS).

▶ It will return to UP MODE screen.

Supplement

- Value set here will be the cut force for the uncut part of the perforated lines. Tool will be raised when set to "UP".
- Normally, input the smaller value than the FORCE for cutting to make it half cutting.

- 13** If the "USER" is chosen in step 8, press the [3] key (CUT L.) and the [4] key (UP L.) to set the cut length and tool up length.

Follow steps 10 to 12 for this operation.

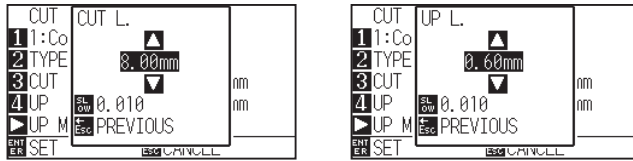

- 14** Confirm the setting and press the [ENTER] key (SET) in the CUT LINE PATTERN screen.

▶ Setting will be confirmed and it will return to CONDITION setting screen (2/3).

- 15** Press the [COND/TEST] key.

▶ It will return to the default screen.

Supplement

- If the TYPE No. 0 to 7 is selected in step 8, CUT L and UP L is only displayed, and not possible to change. Skip this step, and proceed.
- Range possible to set for the CUT L is 0.1 mm to 100.0 mm.
- Range possible to set for the UP L is 0.1 mm to 10.0 mm.
- Press the [SLOW] key to select the setting digits.

Supplement

It will return to CONDITION setting screen (3/3) without changing the settings when you press the [ESC] key (CANCEL).

7.6 Setting Initial Blade Control Position Adjust

After turning on the power or changing pen condition settings, touch the blade to the media and adjust the blade direction. The Initial Blade Control Position will need to be set in order to make sure the area is not damaged and that the blade properly makes contact with the media.

Selecting "2mm BELOW" will change the Initial Blade Control Position to 2 mm below the cutting start point (2 mm from the edge of the point from which the media will be shifted.)

Selecting "Y OUTSIDE" will initialize Initial Blade Direction Setting outside the cutting area.

Selecting "SPECIFIED POSITION" will initialize Initial Blade Direction Setting at the Y direction fixed position that has been set.

* When media narrower than the set Y position is set, it will be the Y maximum value.

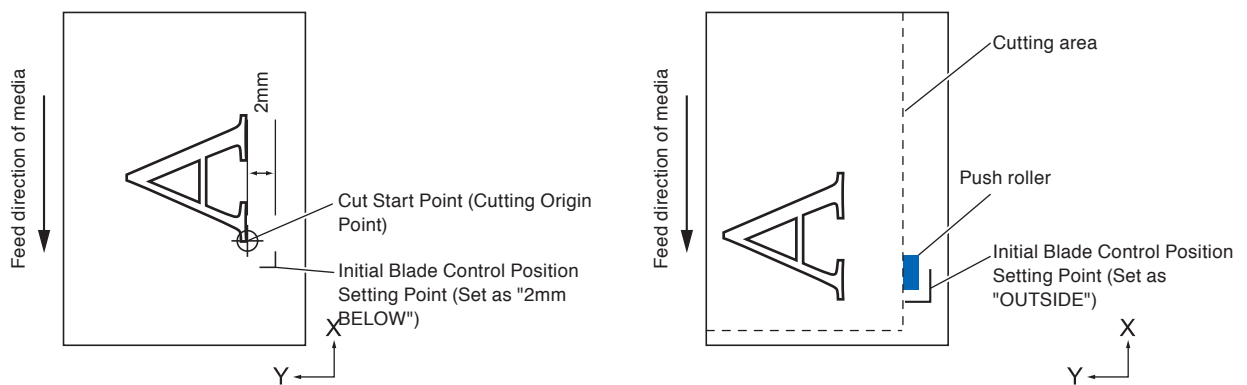

CAUTION

Selecting [Y OUTSIDE] and then changing the expand setting to a positive digit (8 mm ABOVE) can damage the cutting mat.

Operation

1 Press the [PAUSE/MENU] key.

► MENU screen is displayed.



2 Press the [1] key (TOOL).

► TOOLS SETTING screen (1/4) is displayed.

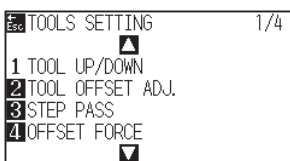

Supplement

Perform the settings in Normal mode.

3 Press the POSITION (▼) key.

▶ TOOLS SETTING screen (4/4) is displayed.

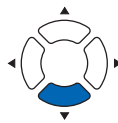
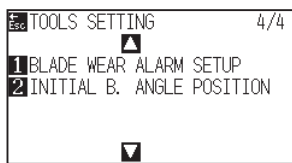

4 Press the [2] key (INITIAL B. ANGLE POSITION).

▶ INITIAL BLADE ANGLE POSITION setting screen is displayed.

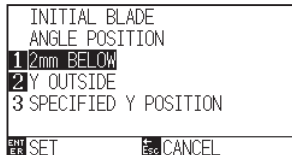

5 Press the [1] key (2 mm BELOW), the [2] key (Y OUTSIDE) or the [3] key (SPECIFIED Y POSITION).

Supplement

When the [3] key (SPECIFIED Y POSITION) is selected, the following message is displayed.

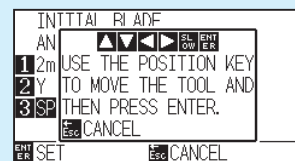

Press the POSITION (▲▼◀▶) keys to move the tool position and then press the [ENTER] key to make the setting.

6 Confirm the setting and press the [ENTER] key (SET).

▶ Setting will be confirmed and it will return to TOOLS SETTING screen (4/4).

Supplement

It will return to TOOLS SETTING screen (4/4) without changing the settings when you press the [ESC] key (CANCEL).

7 Press the [PAUSE/MENU] key.

▶ It will return to default screen.

7.7 Setting the OFFSET FORCE

Slight cut operation is performed before the actual cut operation to align the blade toward the cutting direction. Lower FORCE is necessary compared with the normal cutting, so it is possible to set lower FORCE as an OFFSET FORCE.

OFFSET FORCE is used to control the rotation of the blade with the tangential mode in addition to control the blade direction at the beginning of the cut.

Operation

- 1 Press the [PAUSE/MENU] key.

▶ MENU screen is displayed.



- 2 Press the [1] key (TOOL).

▶ TOOLS SETTING screen (1/4) is displayed.

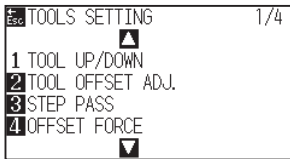

- 3 Press the [4] key (OFFSET FORCE).

▶ OFFSET FORCE screen is displayed.

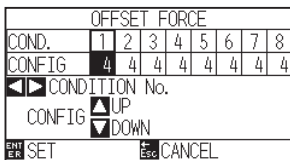

- 4 Press the POSITION (◀▶) keys to select the Condition No.

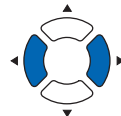

- 5 Press the POSITION (▲▼) keys and increase or decrease the setting value.

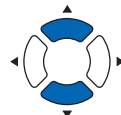

- 6 Confirm the setting and press the [ENTER] key (SET).

▶ Setting will be confirmed and it will return to TOOLS SETTING screen (1/4).

- 7 Press the [PAUSE/MENU] key.

▶ It will return to default screen.

Supplement

Perform the settings in Normal mode.

Supplement

You can set the range between 1 and 38.

Supplement

It will return to TOOLS SETTING screen (1/4) without changing the settings when you press the [ESC] key (CANCEL).

7.8 Setting Adjustment Between the Tools

If there is a misalignment between the tools, you can correct the misalignment by using this function.

In the case of Tool 1 - Tool 3

If there is a misalignment in the cutting/plotting between Tool 1 (tool attached to the backward of the tool holder) and Tool 3 (tool attached to the forward of the tool holder), you can correct it by entering the adjustment value.

Supplement

Set "TOOL NO. SETTING" of tool condition 1 to 1 and set "TOOL" to Pen.
Set "TOOL NO. SETTING" of tool condition 2 to 3 and set "TOOL" to Cutter.

Operation

- 1 Press the [PAUSE/MENU] key.

▶ MENU screen is displayed.



Supplement

Perform the settings in Normal mode.

- 2 Press the [1] key (TOOL).

▶ TOOL SETTING (1/4) screen is displayed.

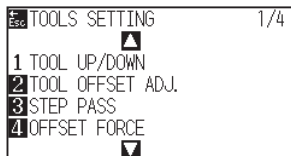

- 3 Press the [2] key (TOOL OFFSET ADJ.).

▶ TOOL OFFSET ADJ. screen is displayed.

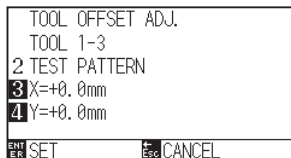

- 4 Press the [2] key (TEST PATTERN).

▶ The following message is displayed.

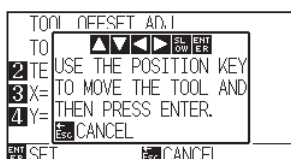

- 5 Press the POSITION (▲▼◀▶) keys to move the tool carriage to the position where the test pattern is plotted.

Move it inside of a cutting area greater than 50 mm on both the X and Y axes.

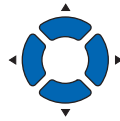

Supplement

- It will return to TOOL OFFSET ADJ. screen without changing the settings when you press the [ESC] key (CANCEL).
- Pressing the POSITION and [SLOW] keys at the same time moves the tool carriage slowly.

- 6 Confirm the tool position and press the [ENTER] key.

► Using the pen plunger (Tool 1), plot a "+" mark.

Next, using the pen plunger (Tool 3), plot a "+" mark.

When plotting is completed, TOOL OFFSET ADJ. screen is displayed.

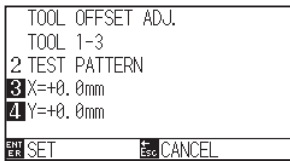

- 7 Using "+" plotted with the pen plunger (Tool 1) as a reference, measure how much the "+" cut by the cutter plunger (Tool 3) deviates. (For example, in the case shown in the figure, it is deviated in the -X direction / + Y direction, so enter X = + * mm, Y = - * mm.)

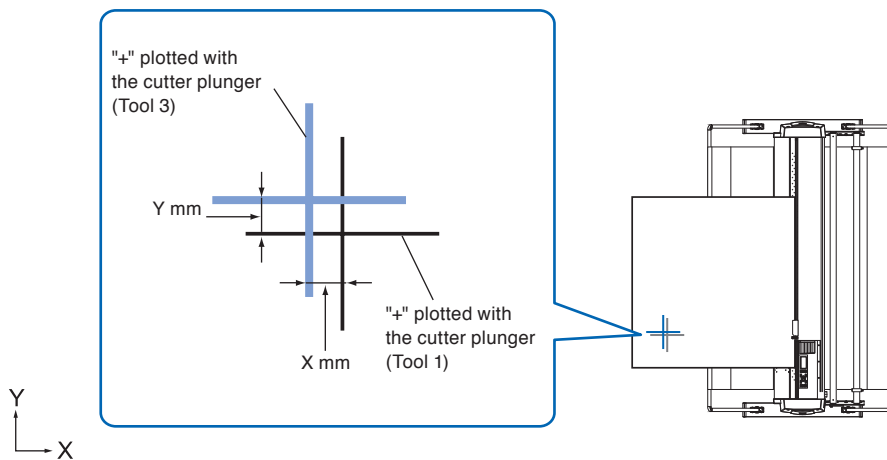

- 8 Press the [3] key (X=+0.0mm).

► Tool 1-3 Interval Adjustment (X) screen is displayed.



- 9 Press the POSITION (▲▼) keys and increase or decrease the setting value.

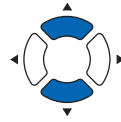

Supplement

You can set the range between -3.0 mm and +3.0 mm.

- 10 Confirm the setting and press the [ESC] key (PREVIOUS).

▶ Tool Interval Adjustment screen is displayed.

- 11 Press the [4] key (Y=+0.0mm).

▶ Tool 1-3 Interval Adjustment (Y) screen is displayed.

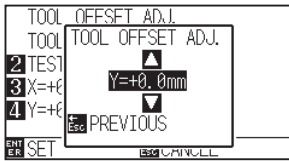

- 12 Press the POSITION (▲▼) keys and increase or decrease the setting value.

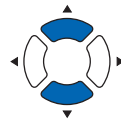

Supplement

You can set the range between -3.0 mm and +3.0 mm.

- 13 Confirm the setting and press the [ESC] key (PREVIOUS).

▶ TOOL OFFSET ADJ. screen is displayed.

- 14 Repeat steps 4 to 13 until the misalignment between the two tools is corrected.

- 15 Confirm the interval and press the [ENTER] key (SET).

▶ Setting will be confirmed and it will return to TOOL SETTING (1/4) screen.

Supplement

It will return to TOOLS SETTING screen (1/4) without changing the settings when you press the [ESC] key (CANCEL).

- 16 Press the [PAUSE/MENU] key.

▶ It will return to default screen.

Chapter 8:

Settings Regarding Cutting Time

Time necessary for cutting depends on the speed to move the tool and media, and efficiency of the operation.

It is best to cut slowly and carefully to cut precisely, but the speed is required to enhance the operational efficiency. The setting needs to be in good balance considering the characteristics of the media and tools, and the contents of the cutting data.

This chapter describes the settings affecting the cutting time.

In addition to this chapter, there are settings affecting the cutting times in following places.

PRODUCT SUMMARY

- 8.1 Sorting the Cutting Data***
- 8.2 Perform Automatic Pre Feed When Cut Data is Received***
- 8.3 Perform Automatic Pre Feed When Media is Set (Initial Feed)***
- 8.4 Setting Feed Speed for Pre Feed***
- 8.5 Setting the MOVING SPEED***
- 8.6 Setting the Tool Up Move***
- 8.7 Setting the Tool Up Height***

8.1 *Sorting the Cutting Data*

When sorting cutting data, cutting is performed collectively so that the amount of movement in the media feed direction and the tool replacement time are minimized, so cutting operation is improved efficiently.

Sorting data simply sorts the area parameter data so that media movement can be minimized. It is much more efficient than cutting at intervals with data that forces tools to jump from point to point.

Supplement

- Sorting will start the process after all the data are stored in the buffer memory, so it takes time to start the cutting.
- Sorting might not be effective for the data that is created efficiently.
- Process may be faster to turn off the sorting on the plotter, if the data is already sorted using the software on the PC.

Operation

1 Press the [PAUSE/MENU] key.

▶ MENU screen is displayed.



Supplement

Perform the settings in Normal mode.

2 Press the [1] key (TOOL).

▶ TOOLS SETTING screen (1/4) is displayed.

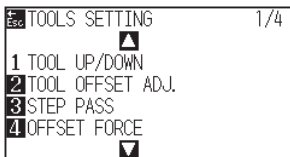

3 Press the POSITION (▲) key.

▶ TOOLS SETTING screen (2/4) is displayed.

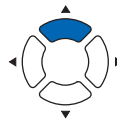
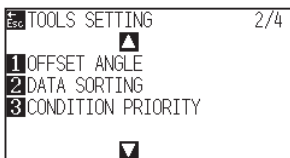

4 Press the [2] key (DATA SORTING).

▶ DATA SORTING screen is displayed.



5 Press the [1] key (ON) or the [2] key (OFF).

6 Press the [ESC] key (PREVIOUS).

▶ DATA SORTING screen is displayed.

7 Confirm the setting and press the [ENTER] key (SET).

▶ Setting will be confirmed and it will return to TOOLS SETTING screen (2/4).

8 Press the [PAUSE/MENU] key.

▶ It will return to default screen.

Supplement

It will return to TOOLS SETTING screen (2/4) without changing the settings when you press the [ESC] key (CANCEL).

Supplement

 mark is displayed at the right of the screen when SORT MODE is set. See "How to Use Control Panel".

8.2 Perform Automatic Pre Feed When Cut Data is Received

It is possible to feed and reverse the media automatically for specified amount when the plotter receives the cutting data.

"Pre feeding" to prevent the shifting of media can be done automatically. Also, the media will be unrolled from the roll before cutting when rolled media is to be used.

- "Pre Feed of Media (Paper or Marking Film)"
- "Perform Automatic Pre Feed When Media is Set (Initial Feed)"

Supplement

- The setting for AUTO PRE FEED when cutting data is received is maintained even if the power is turned off.
- Setting of the AUTO PRE FEED length is not linked to the setting of the page length. Change the setting for the page length if the cutting area is to be long.
- If data is received and auto media transfer is performed once, even if (cut in the same area) data is received again, auto media transfer will not take place.

Operation

1 Press the [PAUSE/MENU] key.

▶ MENU screen is displayed.



2 Press the [4] key (MEDIA).

▶ MEDIA SETTING screen (1/2) is displayed.

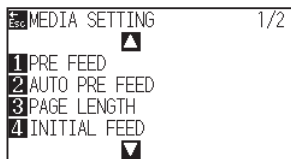

3 Press the [2] key (AUTO PRE FEED).

▶ AUTO PRE FEED screen is displayed.



Supplement

Perform the settings in Normal mode.

4 Press the [1] key (OFF).

▶ AUTO PRE FEED setting screen is displayed.

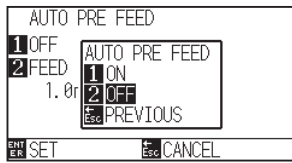

5 Press the [1] key (ON) or the [2] key (OFF).

▶ AUTO PRE FEED will be selected and it will return to AUTO PRE FEED screen.

6 Press the [2] key (FEED LENGTH).

▶ FEED LENGTH screen is displayed.

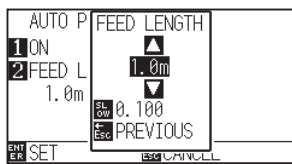

7 Press the POSITION (▲▼) keys and increase or decrease the setting value.

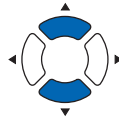

8 Confirm the setting and press the [ESC] key (PREVIOUS).

▶ FEED LENGTH is selected and return to AUTO PRE FEED screen.

9 Confirm the setting and press the [ENTER] key.

▶ Setting will be confirmed and it will return to MEDIA SETTING screen (1/2).

10 Press the [PAUSE/MENU] key.

▶ It will return to default screen.

Supplement

It will return to MEDIA SETTING screen (1/2) without changing the settings when you press the [ESC] key (CANCEL).

Supplement

- Feed length can be set in 0.1 m units.
- You can set the range between 0.5 m and 50.0 m.
- Press the [SLOW] key to select the setting digits.

Supplement

It will return to MEDIA SETTING screen (1/2) without changing the settings when you press the [ESC] key (CANCEL).

Supplement

 mark is displayed at the right of the screen when AUTO PRE FEED is set. See "How to Use Control Panel".

8.3 Perform Automatic Pre Feed When Media is Set (Initial Feed)

It can be set to automatically feed and return the length of the page when the media is loaded and the media set lever is raised.

This is equal to automatically perform the "Pre Feed" to prevent the shifting of the media.

- "Pre Feed of Media (Paper or Marking Film)"
- "Perform Automatic Pre Feed When Cut Data is Received"
- "Setting Feed Speed for Media Set"

Supplement

This setting will be saved even if the power is shut off.

Operation

- 1 Press the [PAUSE/MENU] key.

▶ MENU screen is displayed.



Supplement

Perform the settings in Normal mode.

- 2 Press the [4] key (MEDIA).

▶ MEDIA SETTING screen (1/2) is displayed.

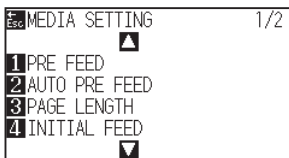

- 3 Press the [4] key (INITIAL FEED).

▶ INITIAL FEED screen is displayed.

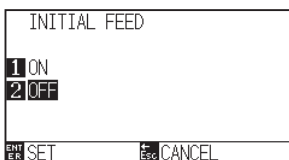

- 4 Set the [1] key (ON) or the [2] key (OFF).

- 5 Confirm the setting and press the [ENTER] key (SET).

▶ Setting will be confirmed and it will return to MEDIA SETTING screen (1/2).

- 6 Press the [PAUSE/MENU] key.

▶ It will return to default screen.

Supplement

It will return to MEDIA SETTING screen (1/2) without changing the settings when you press the [ESC] key (CANCEL).

8.4 Setting Feed Speed for Pre Feed

Set the speed of media transfer during the feed (media carry) of auto media transfer of received cut data, leveling of the initial feed etc.

Set the feed speed to "SLOW" if the media shifts during the pre feed if the media is heavy or slippery. It is normally set to "NORMAL".

- "Pre Feed of Media (Paper or Marking Film)"
- "Perform Automatic Pre Feed When Media is Set (Initial Feed)"
- "Perform Automatic Pre Feed When Cut Data is Received"

Supplement

This setting will be saved even if the power is shut off.

Operation

1 Press the [PAUSE/MENU] key.

▶ MENU screen is displayed.



Supplement

Perform the settings in Normal mode.

2 Press the [4] key (MEDIA).

▶ MEDIA SETTING screen (1/2) is displayed.

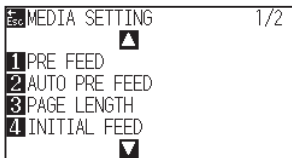

3 Press the POSITION (▲) key.

▶ MEDIA SETTING screen (2/2) is displayed.

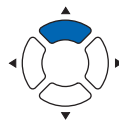
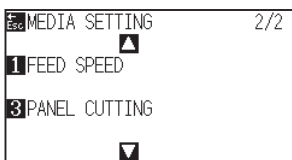

4 Press the [1] key (FEED SPEED).

▶ FEED SPEED screen is displayed.

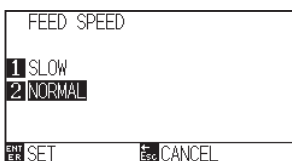

- 5 Press the [1] key (SLOW) or the [2] key (NORMAL).
- 6 Confirm the setting and press the [ENTER] key (SET).
 - ▶ Setting will be confirmed and it will return to MEDIA setting screen (2/2).
- 7 Press the [PAUSE/MENU] key.
 - ▶ It will return to default screen.

Supplement

It will return to MEDIA SETTING screen (2/2) without changing the settings when you press the [ESC] key (CANCEL).

8.5 Setting the MOVING SPEED

MOVING SPEED is the speed the tool moves when it is raised (tool up state).

The cutting time in total becomes short if you set the MOVING SPEED to fast speed even though the speed of the tool when it is cutting (lowered) is set to slow speed for the hard to cut media (hard or sticky).

Supplement

This setting will be saved even if the power is shut off.

Operation

- 1 Press the [PAUSE/MENU] key.

▶ MENU screen is displayed.



Supplement

Perform the settings in Normal mode.

- 2 Press the [1] key (TOOL).

▶ TOOLS SETTING screen (1/4) is displayed.

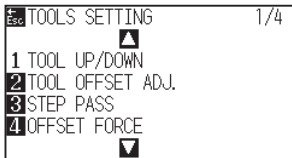

- 3 Press the POSITION (▲) key twice.

▶ TOOLS SETTING screen (3/4) is displayed.

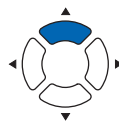
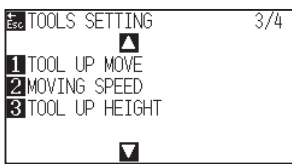

- 4 Press the [2] key (MOVING SPEED).

▶ MOVING SPEED screen is displayed.

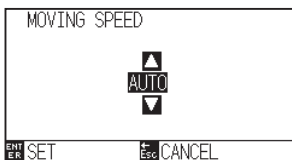

- 5 Press the POSITION (▲▼) keys and increase or decrease the setting value.

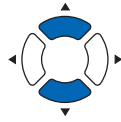

- 6 Confirm the setting and press the [ENTER] key (SET).
▶ Setting will be confirmed and it will return to TOOLS SETTING screen (3/4).

- 7 Press the [PAUSE/MENU] key.
▶ It will return to default screen.

Supplement

- You can set to AUTO, 10, 20, 30, 40, 50 or 60 cm/s.
- It will be same speed as tool is lowered when AUTO is selected.

Supplement

It will return to TOOLS SETTING screen (3/4) without changing the settings when you press the [ESC] key (CANCEL).

8.6 Setting the Tool Up Move

"Tool up movement" is when you continuously receive tool up movement coordinate news from the computer connected to the CE7000 and set whether to move to every coordinate in order or go directly to the last one. There are following 2 settings for "TOOL UP MOVE".

ENABLED : If several coordinates are received continuously, it will move to each in order it is received.

DISABLED : If several coordinates are received continuously, it will directly move to the last coordinate received.

Cutting time can be reduced if it is set to "DISABLED", if the time to move the tool in raised status is wasteful.

Supplement

This setting will be saved even if the power is shut off.

Operation

- 1 Press the [PAUSE/MENU] key.

▶ MENU screen is displayed.



Supplement

Perform the settings in Normal mode.

- 2 Press the [1] key (TOOL).

▶ TOOLS SETTING screen (1/4) is displayed.

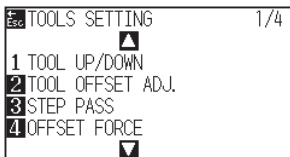

- 3 Press the POSITION (▲) key twice.

▶ TOOLS SETTING screen (3/4) is displayed.

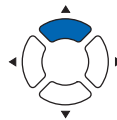
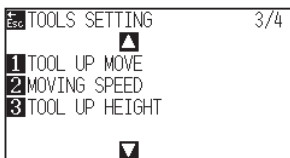

- 4 Press the [1] key (TOOL UP MOVE).

▶ TOOL UP MOVE setting screen is displayed.

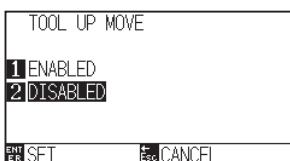

- 5 Press the [1] key (ENABLED) or the [2] key (DISABLED).

- 6 Confirm the setting and press the [ENTER] key (SET).
 - ▶ Setting will be confirmed and it will return to TOOLS SETTING screen (3/4).

- 7 Press the [PAUSE/MENU] key.
 - ▶ It will return to default screen.

Supplement

It will return to TOOLS SETTING screen (3/4) without changing the settings when you press the [ESC] key (CANCEL).

8.7 Setting the Tool Up Height

The TOOL UP HEIGHT is the height of the tool position when the tool is raised.

Set to "HIGHER POSITION" if the media is thick. Usually, set to the "NORMAL POSITION".

Supplement

This setting will be saved even if the power is shut off.

Operation

- 1 Press the [PAUSE/MENU] key.

▶ MENU screen is displayed.



Supplement

Perform the settings in Normal mode.

- 2 Press the [1] key (TOOL).

▶ TOOLS SETTING screen (1/4) is displayed.

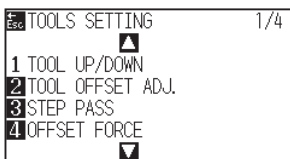

- 3 Press the POSITION (▲) key twice.

▶ TOOLS SETTING screen (3/4) is displayed.

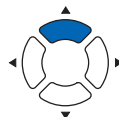
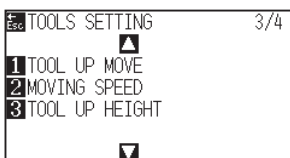

- 4 Press the [3] key (TOOL UP HIGHT).

▶ TOOL UP HIGHT screen is displayed.

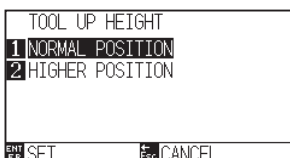

- 5 Press the [1] key (NORMAL POSITION) or the [2] key (HIGHER POSITION).

- 6 Confirm the setting and press the [ENTER] key (SET).
 - ▶ Setting will be confirmed and it will return to TOOLS SETTING screen (3/4).

- 7 Press the [PAUSE/MENU] key.
 - ▶ It will return to default screen.

Supplement

It will return to TOOLS SETTING screen (3/4) without changing the settings when you press the [ESC] key (CANCEL).

Chapter 9: Setting Regarding Interface

This chapter describes setting regarding interface.

PRODUCT SUMMARY

- 9.1** *Setting Interface*
- 9.2** *Clearing the Buffer Memory*
- 9.3** *I/F (LAN)*
- 9.4** *Connecting with RS-232C*

9.1 Setting Interface

This section describes how to set the interface.

The plotter has USB, network (LAN) and RS-232C* interfaces, and these interfaces are switched automatically. To use one of the interfaces on this plotter, you need to install the driver software on the PC.

* RS-232C interface depends on the sales area. For details, please contact the distributor where you purchased

USB interface

To use the USB interface, the driver software must be installed in the computer. Please the SETUP MANUAL to install the driver software.

For the plotter side, please perform command settings, step size settings (when using GP-GL commands), and origin point settings for HP-GL (when using HP-GL commands).

* There is no need to set a command in Simple mode. (There is no setting in Simple mode.)

CAUTION

Operation cannot be guaranteed in the following cases:

- When the plotter is connected to a USB hub or extension port.
- When the plotter is connected to a hand-built or modified computer.
- When a driver other than the one provided as a standard accessory is used.

Notes when using the USB 3.0 interface

- Because that some computer equipped with a USB 3.0 interface is not compatible with USB 2.0 or later interface, you need to check it.

Do not perform the followings:

- Do not connect or disconnect the USB cable while installing the USB driver on the computer.
- Do not connect or disconnect the USB cable when the computer or the plotter is performing an initialization routine. Do not disconnect the USB cable within a 5-second period of connecting it.
- Do not disconnect the cable during data transfer.
- Do not connect multiple plotters to a single computer using the USB interface.

Network (LAN) interface

To use the network (LAN) interface, the settings of the computer and the device such as a network hub have been completed and the environment that can connect the computer to the network must be established.

CAUTION

- To connect through a LAN, you need a network (LAN) cable and a network hub. Please purchase them separately.
- Configuration of network equipment and the presence or absence of the router function depends on your environment. For details, please see the equipment manual, or consult the manufacturer or network administrator.
- Ethernet is compliant with 10BASE-T/100BASE-TX. Please check your network environment.

Supplement

In Simple mode, network (LAN) interface is not available.

RS-232C interface

When using the RS-232C interface*, set the command settings, step size settings (when using GP-GL commands), origin point settings for HP-GL (when using HP-GL commands), and transfer conditions for the RS-232C interface. The transfer conditions for the RS-232C interface can be set from the operations panel. The transfer condition should be set to the same in the software used and in the CE7000. If there is a mistake in the settings an error may displayed in the plotter and lack of data can cause a malfunction. In such a case, please confirm the data transfer settings again.

* **RS-232C interface depends on the sales area. For details, please contact the distributor where you purchased.**

* **Be sure to connect to the serial port of the computer. If a USB conversion adapter is used, it may not function properly.**

Supplement

The RS-232C interface is not available in the Simple mode..

(See "Setting Origin Point When HPGL is Set")

(See "Setting the STEP SIZE")

(See "Setting the Command (COMMAND)")

(See "Connecting with RS-232C")

9.2 Clearing the Buffer Memory

This function allows you to clear all the output data in the plotter's buffer memory.

CAUTION

Do not execute the BUFFER CLEAR function until the operation of the plotter is stopped.

Operation

- 1 Press the [PAUSE/MENU] key.

▶ MENU screen is displayed.

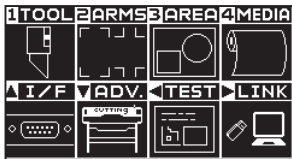

- 2 Press the POSITION (▲) key (I/F).

▶ INTERFACE screen (1/3) is displayed.

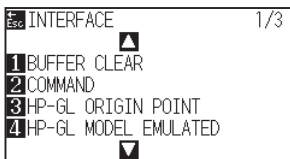

- 3 Press the [1] key (BUFFER CLEAR).

▶ BUFFER CLEAR screen is displayed.

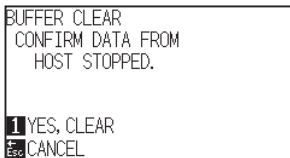

- 4 Press the [1] key (YES, CLEAR).

▶ Buffer will be cleared and it will return to default screen.

Supplement

Perform the settings in Normal mode.

Supplement

It will return to INTERFACE screen (1/3) without changing the settings when you press the [ESC] key (CANCEL).

9.3 I/F (LAN)

Set the network interface (LAN).

Supplement

When you change the settings of the network, the plotter is reset.

To connect through a network (LAN), it is necessary to set the following items.

- Set the DHCP
- Set the IP address
- Set the subnet mask
- Set the gateway
- Display the MAC address

Setting the DHCP

DHCP settings depend on the configuration of network equipment and the customer's environment. For details, please see the equipment manual, or consult the network administrator.

The default setting of DHCP is OFF.

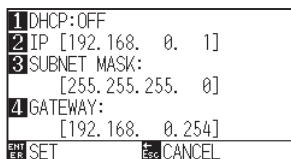

Operation

- 1 Press the [PAUSE/MENU] key.

▶ MENU screen is displayed.



- 2 Press the POSITION (▲) key (I/F).

▶ INTERFACE screen (1/3) is displayed.

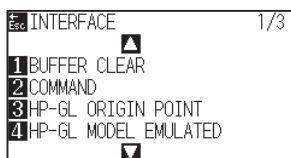

Supplement

Perform the settings in Normal mode.

3 Press the POSITION (▲) key.

▶ INTERFACE screen (2/3) is displayed.

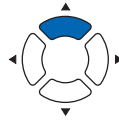

4 Press the [3] key (LAN).

▶ NETWORK (LAN) setting screen is displayed.

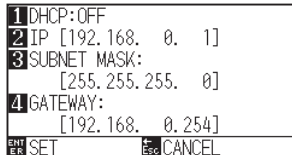

5 Press the [1] key (DHCP).

▶ DHCP screen is displayed.

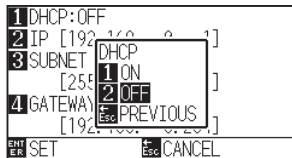

6 Press the [1] key (ON) or the [2] key (OFF).

7 Confirm the setting and press the [ENTER] key (SET).

▶ Setting will be confirmed and it will return to INTERFACE screen (2/3).

8 Press the [PAUSE/MENU] key.

▶ It will return to default screen.

Supplement

It will return to INTERFACE screen (2/3) without changing the settings when you press the [ESC] key (CANCEL).

Set IP address, subnet mask, gateway

When [OFF] is selected in DHCP setting, set these items.

When [ON] is selected in the DHCP setting, the IP address, subnet mask and gateway obtained from the DHCP server are displayed.

Operation

- 1 Press the [PAUSE/MENU] key.

▶ MENU screen is displayed.



- 2 Press the POSITION (▲) key (I/F).

▶ INTERFACE screen (1/3) is displayed.

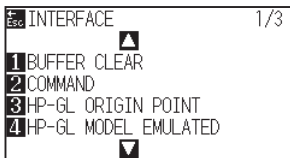

- 3 Press the POSITION (▲) key.

▶ INTERFACE screen (2/3) is displayed.

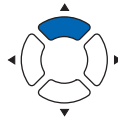

- 4 Press the [3] key (LAN).

▶ NETWORK (LAN) setting screen is displayed.

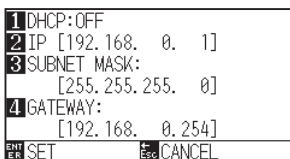

- 5 Press the [2] key (IP).

▶ IP setting screen is displayed.

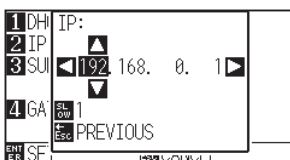

Supplement

Perform the settings in Normal mode.

6 Press the POSITION (▲▼◀▶) keys to set the IP address.

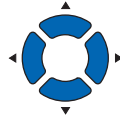

Supplement

Press the [SLOW] key to select the setting digits.

7 Confirm the setting and press the [ESC] key (PREVIOUS).

▶ It will return to NETWORK (LAN) setting screen.

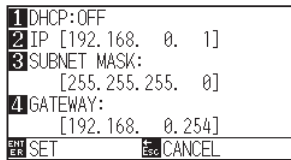

8 Press the [3] key (SUBNET MASK).

▶ SUBNET MASK setting screen is displayed.



9 Press the POSITION (▲▼◀▶) keys to set the subnet mask.

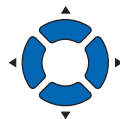

Supplement

Press the [SLOW] key to select the setting digits.

10 Confirm the setting and press the [ESC] key (PREVIOUS).

▶ It will return to NETWORK (LAN) setting screen.

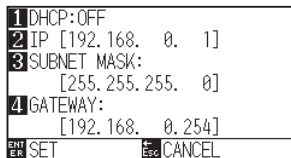

11 Press the [4] key (GATEWAY).

▶ GATEWAY setting screen is displayed.

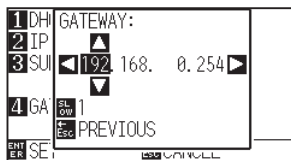

12 Press the POSITION (▲▼◀▶) keys to set the gateway.

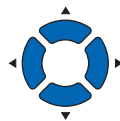

Supplement

Press the [SLOW] key to select the setting digits.

13 Confirm the setting and press the [ESC] key (PREVIOUS).

▶ It will return to NETWORK (LAN) setting screen.

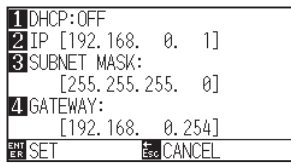

Supplement

When you press the [▶] key on the NETWORK (LAN) setting screen, the Mac address is displayed.

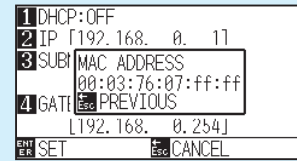

14 Confirm the setting and press the [ENTER] key (SET).

▶ When the setting is changed, the plotter will be reset and default screen will be displayed.

Supplement

It will return to INTERFACE screen (2/3) without changing the settings when you press the [ESC] key (CANCEL).

9.4 Connecting with RS-232C

For the RS-232C settings, you can recall any setting by storing the four different setting types of 1 to 4.

See "Switching the setting number you want to use" to recall the setting you want to use and See "Changing/ Storing the RS - 232C Setting" to change and store the settings.

* RS-232C interface depends on the sales area. For details, please contact the distributor where you purchased.

* When the RS-232C interface is not equipped, the menu will not be displayed.

Switching the setting number you want to use

Operation

1 Press the [PAUSE/MENU] key.

▶ MENU screen is displayed.



Supplement

Perform the settings in Normal mode.

2 Press the POSITION (▲) key (I/F).

▶ INTERFACE screen (1/3) is displayed.

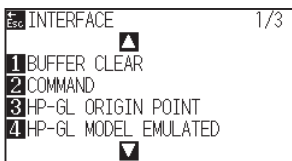

3 Press the POSITION (▲) key.

▶ INTERFACE screen (2/3) is displayed.

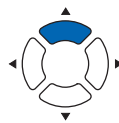

4 Press the [2] key (RS-232C).

▶ RS-232C setting screen is displayed.

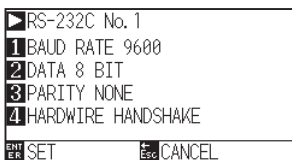

Supplement

It will return to INTERFACE screen (2/3) without changing the settings when you press the [ESC] key (CANCEL).

5 Press the POSITION (▶) key.

▶ RS-232C No. selecting screen will be displayed.

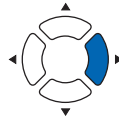
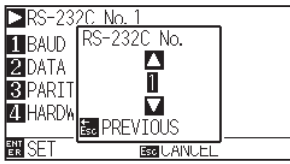

6 Press the POSITION (▲▼) keys to select the setting number.

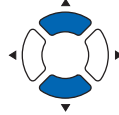

Supplement

You can set from setting no. 1 to 4.

7 Confirm the setting and press the [ESC] key (PREVIOUS).

▶ It will return to RS-232C setting screen.

8 Confirm the setting and press the [ENTER] key (SET).

▶ Setting will be confirmed and it will return to INTERFACE screen (2/3)

9 Press the [PAUSE/MENU] key.

▶ It will return to default screen.

Changing/storing the RS-232C setting

Operation

1 Press the [PAUSE/MENU] key.

▶ MENU screen is displayed.



Supplement

Perform the settings in Normal mode.

2 Press the POSITION (▲) key (I/F).

▶ INTERFACE screen (1/3) is displayed.

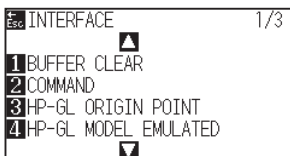

3 Press the POSITION (▲) key.

▶ INTERFACE screen (2/3) is displayed.

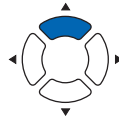

4 Press the [2] key (RS-232C).

▶ RS-232C setting screen is displayed.



Supplement

It will return to INTERFACE screen (2/3) without changing the settings when you press the [ESC] key (CANCEL).

5 Press the [1] key (BAUD RATE).

▶ BAUD RATE screen is displayed.

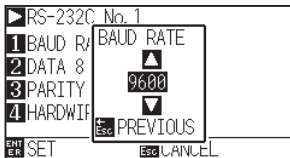

Supplement

Baud rate can be selected from 19200, 9600, 4800, 2400, 1200, 600 or 300.

6 Press the POSITION (▲▼) keys and increase or decrease the setting value.

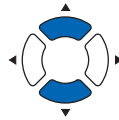

Supplement

Match it to the software you are using.

7 Confirm the setting and press the [ESC] key (PREVIOUS).

▶ The baud rate is selected and it will return to RS-232C setting screen.

8 Press the [2] key (DATA).

▶ DATA BIT screen is displayed.

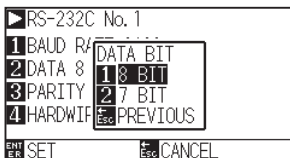

9 Press the [1] key (8 BIT) or the [2] key (7 BIT).

▶ The data bit will be selected and it will return to RS-232C setting screen.

Supplement

- Match it to the software you are using.
- It will return to RS-232C setting screen (2/3) without changing the settings when you press the [ESC] key (PREVIOUS).

10 Press the [3] key (PARITY).

▶ PARITY screen is displayed.

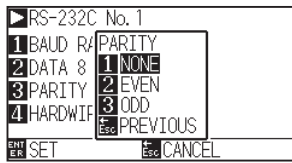

11 Press the [1] key (NONE), [2] key (EVEN) or the [3] key (ODD).

▶ The parity will be selected and it will return to RS-232C setting screen.

12 Press the [4] key (HANDSHAKE).

▶ HANDSHAKE screen is displayed.

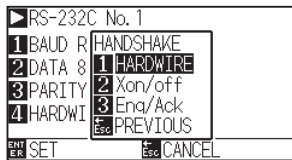

13 Press the [1] key (HARDWIRE), the [2] key (Xon/off) or the [3] key (Enq/Ack).

▶ The handshake will be selected and it will return to RS-232C setting screen.

14 Confirm the setting and press the [ENTER] key (SET).

▶ Setting will be confirmed and it will return to RS-232C setting screen.

15 Press the [PAUSE/MENU] key.

▶ It will return to default screen.

Supplement

- Match it to the software you are using.
- It will return to RS-232C setting screen (2/3) without changing the settings when you press the [ESC] key (PREVIOUS).

Supplement

- Match it to the software you are using.
- It will return to RS-232C setting screen (2/3) without changing the settings when you press the [ESC] key (PREVIOUS).
- Enq/Ack setting is available only for HP-GL. Even if you set to Enq/Ack during GP-GL, It is set to HARD WIRE..

Chapter 10: Settings Regarding Operation Environment

This chapter describes setting regarding the operation environment.

Related to menu display

Display language setting (LANGUAGE SELECTION)

This function sets the language used on the display.

One of ten languages can be selected: English, Japanese, German, French, Italian, Spanish, Portuguese, Russian, Korean, and Chinese.

Operation

- 1 Press the [PAUSE/MENU] key in the default screen.

▶ MENU screen is displayed.



Menu screen
(Normal mode)

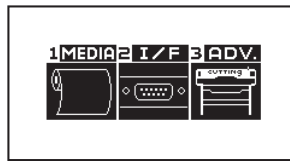

Menu screen
(Simple mode)

- 2 Press the POSITION (▼) key (ADV.) in Normal mode or press the [3] key (ADV.) in Simple mode.

▶ ADVANCE screen is displayed.

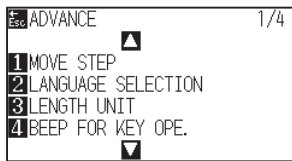

ADVANCE screen
(Normal mode)

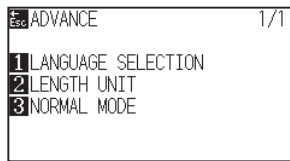

ADVANCE screen
(Simple mode)

- 3 Press the [2] key (LANGUAGE SELECTION) in Normal mode or press the [1] key (LANGUAGE SELECTION) in Simple mode.

▶ LANGUAGE SELECTION screen is displayed.

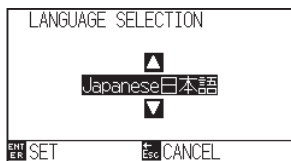

- 4 Press the POSITION (▲▼) keys and select the language.
(In these instructions it's explained for when it's set to English.)

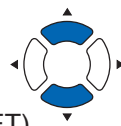

- 5 Confirm the setting and press the [ENTER] key (SET).

▶ Setting will be confirmed and it will return to ADVANCE screen.

- 6 Press the [PAUSE/MENU] key.

▶ It will return to default screen.

Supplement

It will return to ADVANCE screen without changing the settings when you press the [ESC] key (CANCEL).

Display Length Unit Setting (LENGTH UNIT)

The coordinate values that appear on the display and the other parameters for various settings can be changed to either meter or inch display.

Operation

- 1 Press the [PAUSE/MENU] key in the default screen.

▶ MENU screen is displayed.



Menu screen
(Normal mode)

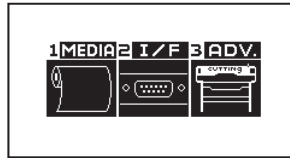

Menu screen
(Simple mode)

- 2 Press the POSITION (▼) key (ADV.) in Normal mode or press the [3] key (ADV.) in Simple mode.

▶ ADVANCE screen is displayed.

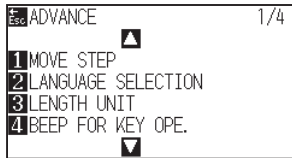

ADVANCE screen
(Normal mode)

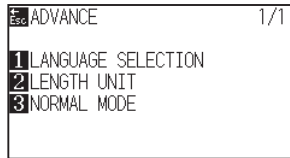

ADVANCE screen
(Simple mode)

- 3 Press the [3] key (LENGTH UNIT) in Normal mode or press the [2] key (LENGTH UNIT) in Simple mode.

▶ LENGTH UNIT screen is displayed.

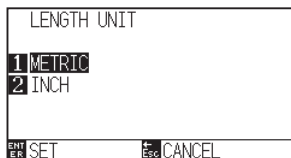

- 4 Press the [1] key (METRIC) or the [2] key (INCH).

- 5 Confirm the setting and press the [ENTER] key (SET).

▶ Setting will be confirmed and it will return to ADVANCE screen.

- 6 Press the [PAUSE/MENU] key.

▶ It will return to default screen.

Supplement

It will return to ADVANCE screen without changing the settings when you press the [ESC] key (CANCEL).

Related to sensor

Enabling/Disabling the media sensors (MEDIA SENSOR)

This function enables or disables the media sensors that detect the size of the medium in the feed direction.

CAUTION

Normally, please use it while set to "ENABLED". Turn it DISABLED when setting undetectable media with high transmittance. When set to "DISABLED", the cutting mat may be damaged. Please be sure to configure the "area".

Operation

- 1 Press the [PAUSE/MENU] key in the default screen.

▶ MENU screen is displayed.



Supplement

Perform the settings in Normal mode.

- 2 Press the POSITION (▼) key (ADV.).

▶ ADVANCE screen (1/4) is displayed.

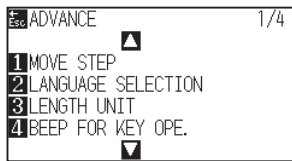

- 3 Press the POSITION (▼) key.

▶ ADVANCE screen (4/4) is displayed.

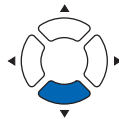
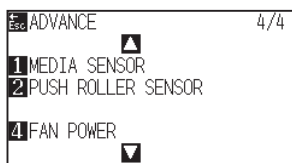

- 4 Press the [1] key (MEDIA SENSOR).

▶ MEDIA SENSOR screen is displayed.

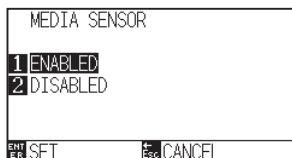

- 5 Press the [1] key (ENABLED) or the [2] key (DISABLED).
- 6 Confirm the setting and press the [ENTER] key (SET).
 - ▶ Setting will be confirmed and it will return to ADVANCE screen (4/4).
- 7 Press the [PAUSE/MENU] key.
 - ▶ It will return to default screen.

Supplement

It will return to ADVANCE screen (4/4) without changing the settings when you press the [ESC] key (CANCEL).

Enabling/Disabling the push roller sensors (PUSH ROLLER SENSOR)

This function enables or disables the push roller sensors that detect the width of the media.

CAUTION

Usually, please use it while set to "Enabled".

When set to "Disabled", the cutting mat may be damaged. Please always set the "Cutting Area".

Operation

- 1 Press the [PAUSE/MENU] key in the default screen.
 - ▶ MENU screen is displayed.

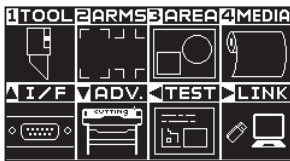

Supplement

Perform the settings in Normal mode.

- 2 Press the POSITION (▼) key (ADV.).
 - ▶ ADVANCE screen (1/4) is displayed.

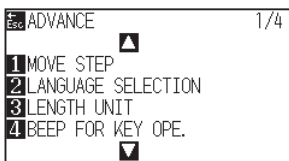

- 3 Press the POSITION (▼) key.
 - ▶ ADVANCE screen (4/4) is displayed.

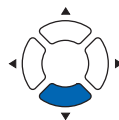
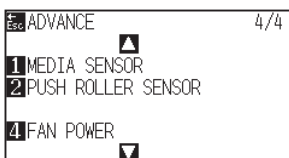

4 Press the [2] key (PUSH ROLLER SENSOR).

▶ PUSH ROLLER SENSOR screen is displayed.

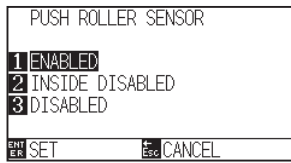

5 Press the [1] key (ENABLED), the [2] key (INSIDE DISABLED), or the [3] key (DISABLED).

Supplement

If "DISABLED" is selected, push roller detection is not performed.

It will not generate error even if the inner push rollers are not on the grit rollers when the "INSIDE DISABLED" is selected.

6 Confirm the setting and press the [ENTER] key (SET).

▶ Setting will be confirmed and it will return to ADVANCE screen (4/4).

Supplement

- When "DISABLE" has been set, the home sensor position is not detected, so depending on the data, a position error could occur.
- It will return to ADVANCE screen (4/4) without changing the settings when you press the [ESC] key (CANCEL).

7 Press the [PAUSE/MENU] key.

▶ It will return to default screen.

Related to plotter environment

Fan suction setting (FAN POWER)

This function sets the suction force used to affix media to the plotter. It may not feed properly if the media is thin, so set to "WEAK".

Operation

- 1 Press the [PAUSE/MENU] key in the default screen.

▶ MENU screen is displayed.



- 2 Press the POSITION (▼) key (ADV.).

▶ ADVANCE screen (1/4) is displayed.

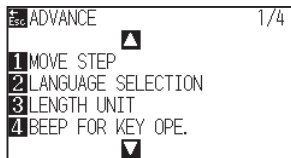

- 3 Press the POSITION (▼) key.

▶ ADVANCE screen (4/4) is displayed.

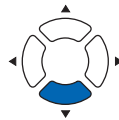
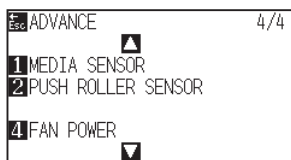

- 4 Press the [4] key (FAN POWER).

▶ FAN POWER screen is displayed.

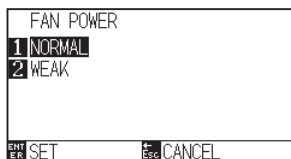

- 5 Press the [1] key (NORMAL) or the [2] key (WEAK).

- 6 Confirm the setting and press the [ENTER] key (SET).

▶ Setting will be confirmed and it will return to ADVANCE screen (4/4).

- 7 Press the [PAUSE/MENU] key.

▶ It will return to default screen.

Supplement

Perform the settings in Normal mode.

Supplement

It will return to ADVANCE screen (4/4) without changing the settings when you press the [ESC] key (CANCEL).

Enabling/Disabling the beep setting (BEEP FOR KEY OPERATION)

This function selects whether to enable or disable the beep that is emitted whenever a control panel key is pressed.

Operation

- 1 Press the [PAUSE/MENU] key in the default screen.

▶ MENU screen is displayed.



- 2 Press the POSITION (▼) key (ADV.).

▶ ADVANCE screen (1/4) is displayed.

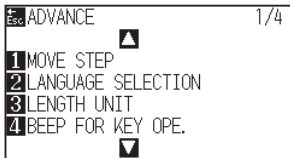

- 3 Press the [4] key (BEEP FOR KEY OPE.).

▶ BEEP FOR KEY OPE. setting screen is displayed.



- 4 Press the [1] key (ON) or the [2] key (OFF).

- 5 Confirm the setting and press the [ENTER] key (SET).

▶ Setting will be confirmed and it will return to ADVANCE screen (1/4).

- 6 Press the [PAUSE/MENU] key.

▶ It will return to default screen.

Supplement

Perform the settings in Normal mode.

Supplement

It will return to ADVANCE screen (1/4) without changing the settings when you press the [ESC] key (CANCEL).

Pause key select setting (Selecting PAUSE key)

Set the screen to be displayed when the [PAUSE / MENU] key is pressed during receiving data.

Operation

- 1 Press the [PAUSE/MENU] key in the default screen.

▶ MENU screen is displayed.



- 2 Press the POSITION (▼) key (ADV.).

▶ ADVANCE screen (1/4) is displayed.

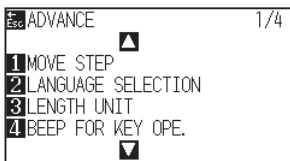

- 3 Press the POSITION (▲) key twice.

▶ ADVANCE screen (3/4) is displayed.

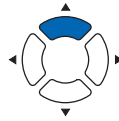
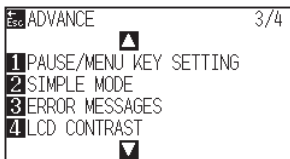

- 4 Press the [1] key (PAUSE/MENU KEY SETTING)

▶ PAUSE/MENU KEY SETTING screen is displayed.

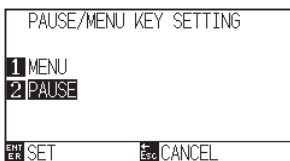

- 5 Press the [1] key (MENU) or the [2] key (PAUSE).

- 6 Confirm the setting and press the [ENTER] key (SET).

▶ Setting will be confirmed and it will return to ADVANCE screen (3/4).

- 7 Press the [PAUSE/MENU] key.

▶ It will return to default screen.

Supplement

Perform the settings in Normal mode.

Supplement

It will return to ADVANCE screen (3/4) without changing the settings when you press the [ESC] key (CANCEL).

Simple mode / Normal mode setting (Simple mode / Normal mode)

Set the switching between Simple mode and Normal mode.

Operation

- 1 Press the [PAUSE/MENU] key in the default screen.

▶ MENU screen is displayed.

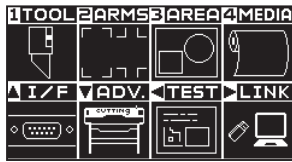

Menu screen
(Normal mode)

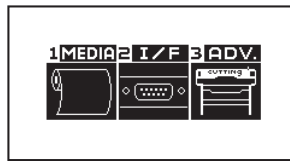

Menu screen
(Simple mode)

- 2 Press the (▼) key (ADV.) in Normal mode and press the POSITION (▲) key twice on the ADVANCE (ADV.) screen

Press the [3] key (ADV.) in Simple mode.

▶ ADVANCE screen is displayed.

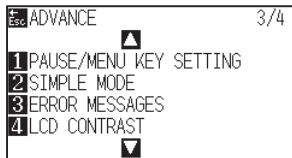

ADVANCE screen
(Normal mode)

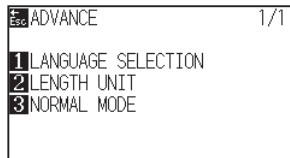

ADVANCE screen
(Simple mode)

- 3 Press the [2] key (SIMPLE MODE) in Normal mode or press the [3] key (NORMAL MODE) in Simple mode.

▶ USER CHANGING screen is displayed.

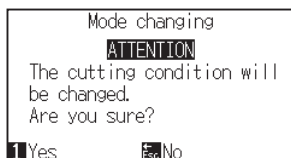

- 4 Press the [1] key (Yes) or the [ESC] key (No).

- 5 When the [1] key (Yes) is pressed, the user setting will be changed.

When the [ESC] key (No) is pressed, it will return to the ADVANCE screen (3/4).

LCD contrast setting (LCD contrast)

You can set the contrast of the LCD display on the control panel.

Operation

- 1 Press the [PAUSE/MENU] key in the default screen.

▶ MENU screen is displayed.



- 2 Press the POSITION (▼) key (ADV.).

▶ ADVANCE screen (1/4) is displayed.

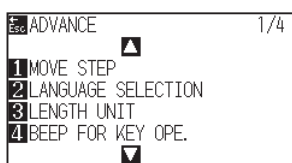

- 3 Press the POSITION (▲) key twice.

▶ ADVANCE screen (3/4) is displayed.

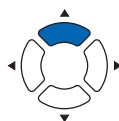
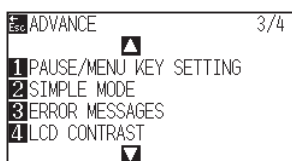

- 4 Press the [4] key (LCD CONTRAST)

▶ LCD CONTRAST screen is displayed.

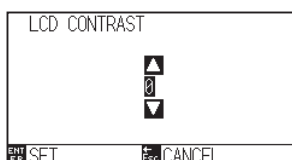

- 5 Press the POSITION (▲▼) keys and increase or decrease the setting value.

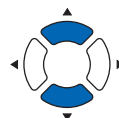

- 6 Confirm the setting and press the [ENTER] key (SET).

▶ Setting will be confirmed and it will return to ADVANCE screen (3/4).

- 7 Press the [PAUSE/MENU] key.

▶ It will return to default screen.

Supplement

Perform the settings in Normal mode.

Supplement

You can set the range between -30 and 30 (5-step).

Supplement

It will return to ADVANCE screen (3/4) without changing the settings when you press the [ESC] key (CANCEL).

Chapter 11: ***Settings of Controls from Computer***

This chapter describes setting regarding the controls from the computer.

Related to command processing

Setting the command (COMMAND)

There are 2 types of commands, the GP-GL and the HP-GL, that the plotter can use. Match the setting to the used software, or set it to AUTO.

Supplement

- Automatic detection of the command may make mistake depending on the data. It will give error or malfunction when it has made mistake. In that case, set the command before using.
- Always send the data when the plotter is in READY status when in the automatic detection of the command.
- Once the data is cut with the automatic detection of the command, it will be ready to automatically detect next command 10 seconds after completing the cutting. Send next data after 10 seconds has past after previous cutting when sending data with different command.

Operation

- 1 Press the [PAUSE/MENU] key in the default screen.

▶ MENU screen is displayed.



- 2 Press the POSITION (▲) key (I/F).

▶ INTERFACE screen (1/3) is displayed.

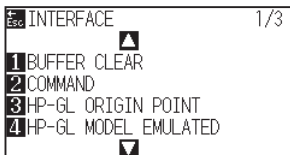

- 3 Press the [2] key (COMMAND).

▶ COMMAND screen is displayed.



- 4 Select the [1] key (GP-GL), the [2] key (HP-GL), or the [3] key (AUTO).

- 5 Confirm the setting and press the [ENTER] key (SET).

▶ Setting will be confirmed and it will return to INTERFACE screen (1/3).

- 6 Press the [PAUSE/MENU] key.

▶ It will return to default screen.

Supplement

Set in the Normal mode.

There is no setting in Simple mode. (It is in the state of automatic operation.)

If an incorrect judgment is made in the Simple mode, set the command in the Normal mode and then operate it in the Normal mode.

Priority of tool condition selection (CONDITION PRIORITY)

Select the priority of the setting created by different method when the tool condition is set.

All the tool condition that is received from the computer will be ignored, and only the setting and change of the tool condition from the control panel is accepted when MANUAL is selected. This setting set here is maintained even if the power is turned off.

On the other hand, it will set the most current tool condition either from the control panel or from the software when PROGRAM is selected. The values set from the control panel are maintained, and the values set from the software are erased when the power is turned off.

Operation

- 1 Press the [PAUSE/MENU] key in the default screen.

▶ MENU screen is displayed.



Supplement

Perform the settings in Normal mode.

- 2 Press the [1] key (TOOL).

▶ TOOLS SETTING screen (1/4) is displayed.

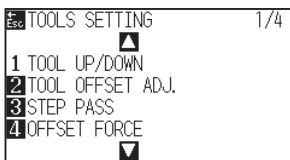

- 3 Press the POSITION (▲) key.

▶ TOOLS SETTING screen (2/4) is displayed.

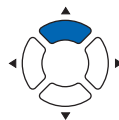
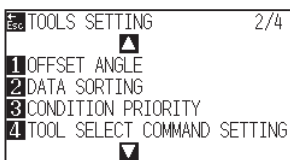

- 4 Press the [3] key (CONDITION PRIORITY).

▶ CONDITION PRIORITY screen is displayed.

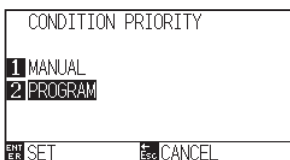

- 5 Press the [1] key (MANUAL) or the [2] key (PROGRAM).

- 6 Confirm the setting and press the [ENTER] key (SET).

▶ Setting will be confirmed and it will return to TOOLS SETTING screen (2/4).

- 7 Press the [PAUSE/MENU] key.

▶ It will return to default screen.

Related to GP-GL command

This section is useful only when using the GP-GL command.

Setting the step size (GP-GL STEP SIZE)

The distance to travel with 1 step can be changed. Match the setting value of the application to be used.

Operation

- 1 Press the [PAUSE/MENU] key in the default screen.

▶ MENU screen is displayed.



Menu screen
(Normal mode)

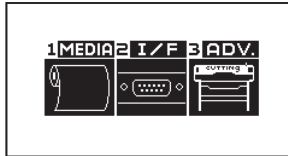

Menu screen
(Simple mode)

- 2 Press the POSITION (▲) key (I/F) in Normal mode and press the POSITION (▲) key in the INTERFACE (I/F) screen.

Press the [2] key (I/F) in Simple mode.

▶ INTERFACE screen is displayed.



INTERFACE screen
(Normal mode)

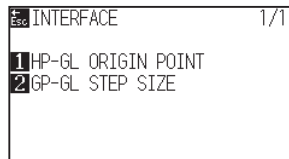

INTERFACE screen
(Simple mode)

- 3 Press the [1] key (GP-GL STEP SIZE) in Normal mode or press the [2] key (GP-GL STEP SIZE) in Simple mode.

▶ GP-GL STEP SIZE screen is displayed.

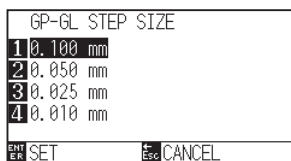

- 4 Press the [1] key (0.100 mm), the [2] key (0.050 mm), the [3] key (0.025 mm), or the [4] key (0.010 mm).

- 5 Confirm the setting and press the [ENTER] key (SET).

▶ Setting will be confirmed and it will return to INTERFACE screen.

- 6 Press the [PAUSE/MENU] key.

▶ It will return to default screen.

Enabling/Disabling the ':' and ';' commands (COMMAND ':', ';')

If the first part of the data is lost when the GP-GL command is set, these commands may be having an adverse effect. In this case, set the ':' and ';' commands to DISABLED.

Operation

- 1 Press the [PAUSE/MENU] key in the default screen.

▶ MENU screen is displayed.

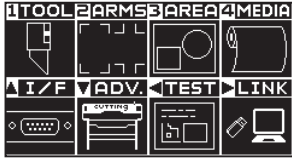

Supplement

Perform the settings in Normal mode.

- 2 Press the POSITION (▲) key (I/F).

▶ INTERFACE screen (1/3) is displayed.

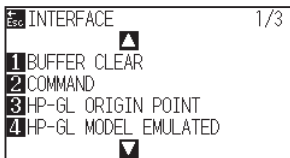

- 3 Press the POSITION (▲) key.

▶ INTERFACE screen (2/3) is displayed.



- 4 Press the [4] key (COMMAND ':', ';').

▶ COMMAND ':', ';' screen is displayed.

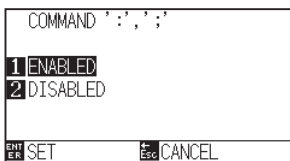

- 5 Press the [1] key (ENABLED) or the [2] key (DISABLED).

- 6 Confirm the setting and press the [ENTER] key (SET).

▶ Setting will be confirmed and it will return to INTERFACE screen (2/3).

- 7 Press the [PAUSE/MENU] key.

▶ It will return to default screen.

Moving the pen while raised or lowered in Response to the 'W' command (COMMAND 'W')

Here, you can change the settings for the 'W' command, which is a GP-GL arc cutting command.

This function set the operation upon receipt of the 'W' command for the drawing of arcs.

The pen will move to the specified starting position in the raised status when it is set to TOOL UP, regardless of the pen's conditions. The pen will move without changing its condition, to the specified starting position in the lowered status when it is set to TOOL DOWN.

Supplement

This has an effect on the tool cutter only. For the pen setting, always the pen is raised (PEN UP).

Operation

- 1 Press the [PAUSE/MENU] key in the default screen.

▶ MENU screen is displayed.

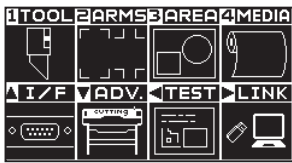

Supplement

Perform the settings in Normal mode.

- 2 Press the POSITION (▲) key (I/F).

▶ INTERFACE screen (1/3) is displayed.

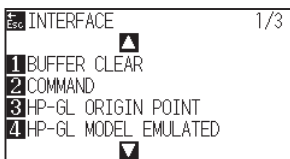

- 3 Press the POSITION (▼) key.

▶ INTERFACE screen (3/3) is displayed.

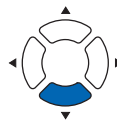
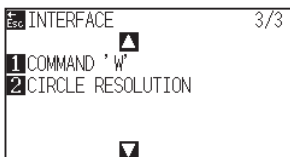

- 4 Press the [1] key (COMMAND 'W').

▶ COMMAND 'W' screen is displayed.

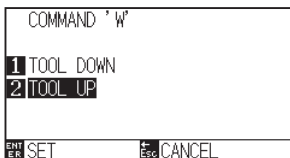

- 5 Press the [1] key (TOOL DOWN) or the [2] key (TOOL UP).

- 6 Confirm the setting and press the [ENTER] key (SET).

▶ Setting will be confirmed and it will return to INTERFACE screen (3/3).

- 7 Press the [PAUSE/MENU] key.

▶ It will return to default screen.

Related to HP-GL command

This section is useful only when using the HP-GL command

Model ID response (HP-GL MODEL EMULATED)

This function set the operation upon receipt of the "OI" command requesting for the model ID. The reply will be 7550 when set to 7550, and 7586 when set to 7586.

Operation

- 1 Press the [PAUSE/MENU] key in the default screen.

▶ MENU screen is displayed.



- 2 Press the POSITION (▲) key (I/F).

▶ INTERFACE screen (1/3) is displayed.

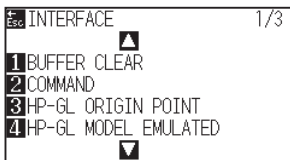

- 3 Press the [4] key (HP-GL MODEL EMULATED).

▶ HP-GL MODEL EMULATED screen is displayed.

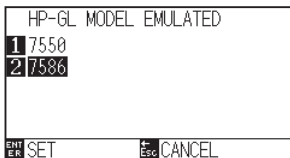

- 4 Press the [1] key (7550) or the [2] key (7586).

- 5 Confirm the setting and press the [ENTER] key (SET).

▶ Setting will be confirmed and it will return to INTERFACE screen (1/3).

- 6 Press the [PAUSE/MENU] key.

▶ It will return to default screen.

Supplement

Perform the settings in Normal mode.

Circle-command resolution setting (CIRCLE RESOLUTION)

This function set the sets the resolution upon receipt of the circle-command for the HP-GL pen plotter arc cutting command.

Select from "AUTO" or "DEFAULT" of 5 degrees.

Operation

- 1 Press the [PAUSE/MENU] key in the default screen.

▶ MENU screen is displayed.



Supplement

Perform the settings in Normal mode.

- 2 Press the POSITION (▲) key (I/F).

▶ INTERFACE screen (1/3) is displayed.

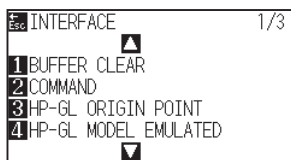

- 3 Press the POSITION (▼) key.

▶ INTERFACE screen (3/3) is displayed.

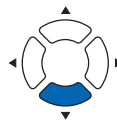
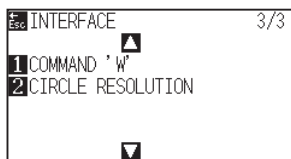

- 4 Press the [2] key (CIRCLE RESOLUTION).

▶ CIRCLE RESOLUTION screen is displayed.

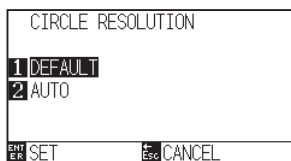

- 5 Press the [1] key (DEFAULT) or the [2] key (AUTO).

- 6 Confirm the setting and press the [ENTER] key (SET).

▶ Setting will be confirmed and it will return to INTERFACE screen (3/3).

- 7 Press the [PAUSE/MENU] key.

▶ It will return to default screen.

Chapter 12: Data Link

This chapter describes setting regarding the data link.

PRODUCT SUMMARY

- 12.1 Select Connection Destination*
- 12.2 Data Link with USB Memory*
- 12.3 Output with a Bar Code*
- 12.4 Start Mark Auto Scan*
- 12.5 Communication Timeout*
- 12.6 Skew Scanning*

12.1 Select Connection Destination

Dedicated data created previously with application software etc. is output to the cutting plotter.

It can be saved in USB memory and output the data saved in USB memory, or output via server (personal computer) using network (LAN) cable or USB cable.

Operation

- 1 Press the [PAUSE/MENU] key.

▶ MENU screen is displayed.



- 2 Press the POSITION (▶) key (LINK).

▶ DATA LINK screen (1/2) is displayed.

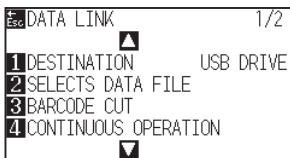

- 3 Press the [1] key (DESTINATION).

▶ DESTINATION screen is displayed.

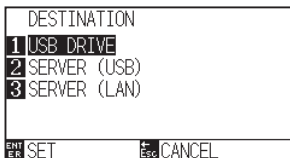

- 4 Press the [1] key (USB MEMORY), the [2] key (SERVER (USB)) or the [3] key (SERVER (LAN)).

- 5 Confirm the setting and press the [ENTER] key (SET).

▶ Setting will be confirmed and it will return to DATA LINK screen (1/2).

- 6 Press the [PAUSE/MENU] key.

▶ It will return to default screen.

Supplement

Perform the settings in Normal mode.

12.2 Data Link with USB Memory

Dedicated data created previously with application software etc. can be saved in the USB memory and output from the cutting plotter.

Data link can be performed by selecting data from the plotter menu.

Supplement

- File name
 - Only 1-byte alphanumeric characters (ASCII) are supported.
 - Windows prohibited characters (¥, /, \, :, *, ?, ", <, >, |, etc. are not available.
 - Limit of the number of display characters is 25 characters. More characters than 25 can be displayed by scrolling.
 - Extension is "xpf" and "plt".
- Scroll is displayed after a few moments after selecting the item.
- The folder is surrounded by '<' and '>'.
- Name is sorted in ascending order.
- Files and folders can be obtained up to 64.
- Files in the second level folder is not available.

Operation

1 Insert the USB memory that saved the dedicated data to the plotter.

2 Press the [PAUSE/MENU] key.

▶ MENU screen is displayed.



3 Press the POSITION (▶) key (LINK).

▶ DATA LINK screen (1/2) is displayed.

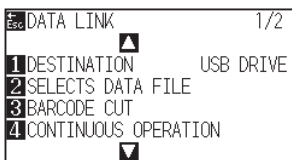

4 Press the [1] key (DESTINATION).

▶ DESTINATION screen is displayed.

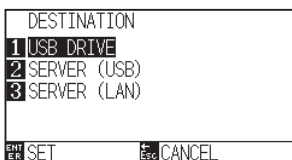

Supplement

Perform the settings in Normal mode.

5 Press the [1] key (USB DRIVE).

6 Confirm the setting and press the [ENTER] key (SET).

▶ Setting will be confirmed and it will return to DATA LINK screen.

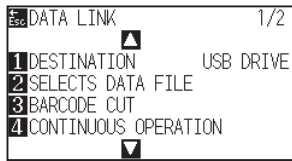

7 Press the [2] key (SELECTS DATA FILE).

▶ SELECTS DATA FILE screen is displayed.

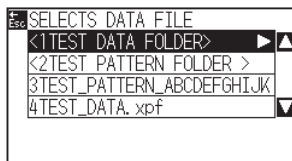

8 Press the POSITION (▲▼) keys to select the file.

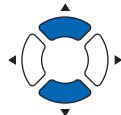

9 Press the [ENTER] key (START).

▶ Cutting starts with the selected file.

10 When the cutting is finished, it will become READY status.

Supplement

- If the USB memory is not inserted, the following is displayed.

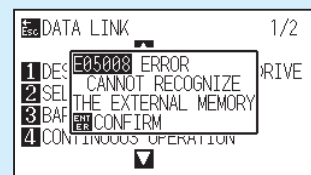

- If there is no data in the USB memory, the following screen is displayed.

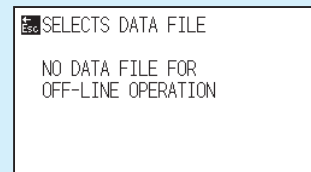

Supplement

Press the POSITION (▲▼) keys to change the folder.

12.3 Output with a Bar Code

The information related to the output file is bar-coded using the Cutting Master 5 and Graphtec Studio 2, etc. and the barcode can be printed with the design and the registration marks.

When cutting with the cutting plotter, the bar code is scanned and the cut data (XPF) that has been saved to a USB memory that matches the bar code is detected.

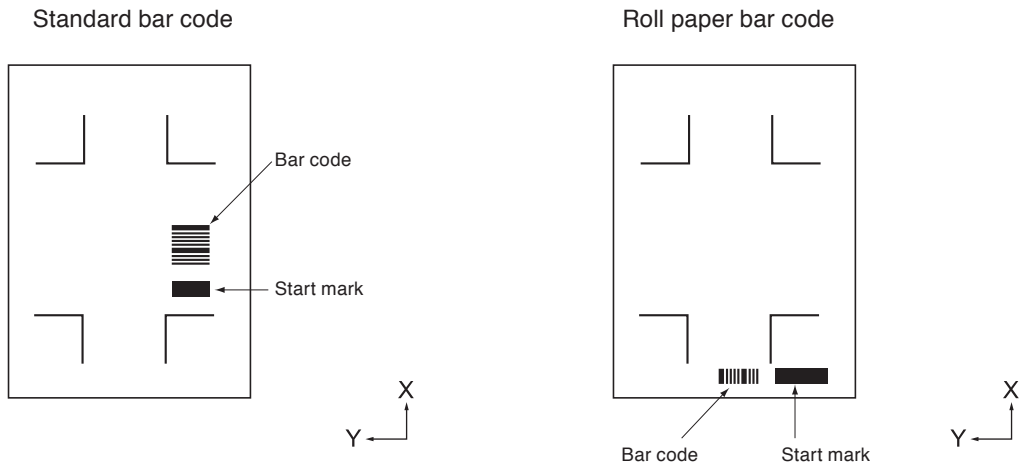

Operation

1 Insert the USB memory that saved the dedicated data to the plotter.

2 Press the [PAUSE/MENU] key.

▶ MENU screen is displayed.



3 Press the POSITION (▶) key (LINK).

▶ DATA LINK screen (1/2) is displayed.

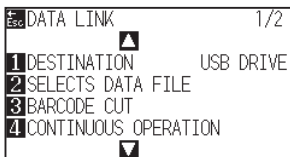

Supplement

Perform the settings in Normal mode.

4 Press the [3] key (BARCODE CUT).

▶ The following message is displayed.

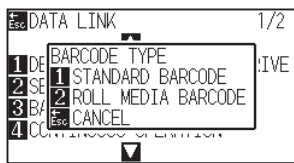

5 Press the [1] key (STANDARD BARCODE) or the [2] key (ROLL MEDIA BARCODE).

▶ The following display is displayed.

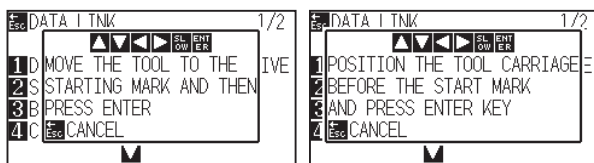

<Standard bar code>

<Roll media bar code>

6 Press the POSITION (▲▼◀▶) key to move the tool to the start mark position.

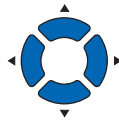

7 Confirm the tool position and press the [ENTER] key.

▶ The bar code is scanned. On completing it, the following screen is displayed.

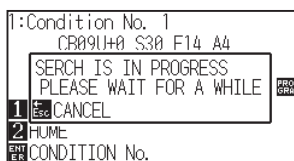

Supplement

- If the USB memory is not inserted, the following is displayed.

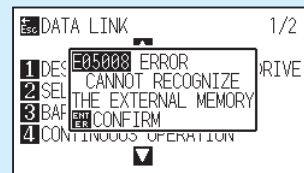

- When the Rotation is set to ON, the following display is displayed.

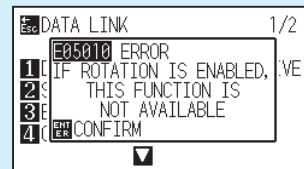

- When the Mirror is set to ON, the following display is displayed.

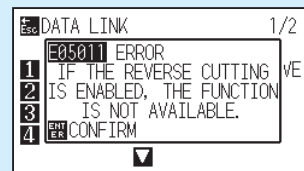

- When the Panel Cutting is set to ON, the following display is displayed.

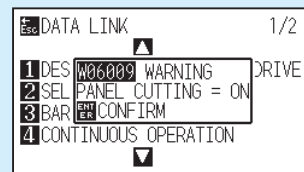

- In the case of a barcode of roll media, the following will be displayed for the second and subsequent sheets.

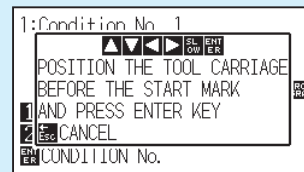

Supplement

- If the start mark is not scanned the following display is displayed.

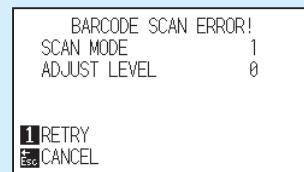

Check the print result of start mark and the detect start position etc.

8 Find the file, and then start cutting.

9 When cutting is completed, it will become READY status.

Supplement

- If the appropriate files are found, select the desired file.

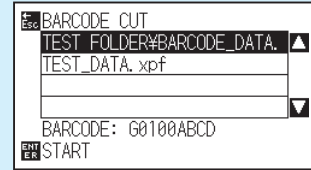

- If the appropriate files is not found, the following screen is displayed.

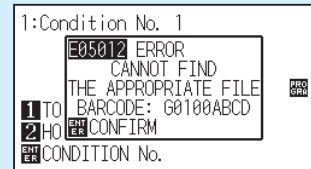

12.4 Start Mark Auto Scan

When the start mark auto scan is set to ON, the following operation is performed.

If the tool is close to the start mark, pressing the [ENTER] key will automatically scan the start mark without moving the tool to the scan start position.

Supplement

- It is available only for the start mark of "standard bar code". For "Roll Paper Barcode" it is not available.
- If a mask registration mark is being plotted, there is a possibility to recognize the mask registration mark as a start mark. If a mask registration mark is being plotted, set the start mark auto scan to OFF.

Operation

- 1 Press the [PAUSE/MENU] key.

▶ MENU screen is displayed.



Supplement

Perform the settings in Normal mode.

- 2 Press the POSITION (▶) key (LINK).

▶ DATA LINK screen (1/2) is displayed.

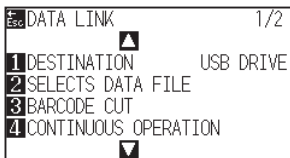

- 3 Press the POSITION (▲) key.

▶ DATA LINK screen (2/2) is displayed.

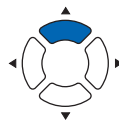
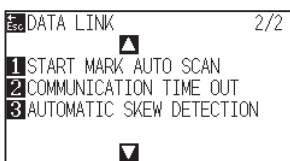

- 4 Press the [1] key (START MARK AUTO SCAN).

▶ START MARK AUTO SCAN screen is displayed.

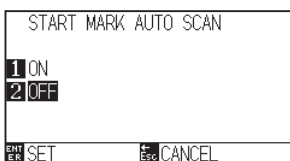

- 5 Press the [1] key (ON) or the [2] key (OFF).

- 6 Confirm the setting and press the [ENTER] key (SET).
 - ▶ Setting will be confirmed and it will return to DATA LINK screen (2/2).

- 7 Press the [PAUSE/MENU] key.
 - ▶ It will return to default screen.

Supplement

It will return to DATA LINK setting screen (2/2) without changing the settings when you press the [ESC] key (CANCEL).

12.5 Communication Timeout

When the communication is lost during connecting to the data link server, the connection will be canceled after a certain period of time has elapsed. You can set the time until it is canceled.

Operation

- 1 Press the [PAUSE/MENU] key.

▶ MENU screen is displayed.



- 2 Press the POSITION (▶) key (LINK).

▶ DATA LINK screen (1/2) is displayed.

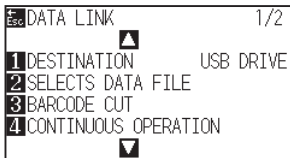

- 3 Press the POSITION (▲) key.

▶ DATA LINK screen (2/2) is displayed.

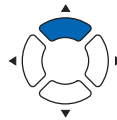
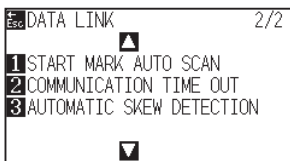

- 4 Press the [2] key (COMMUNICATION TIME OUT).

▶ COMMUNICATION TIME OUT screen is displayed.



- 5 Press the POSITION (▲▼) key and increase or decrease the setting value.

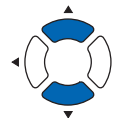

Supplement

Perform the settings in Normal mode.

Supplement

You can set the range between 5 and 15 sec.

- 6 Confirm the setting and press the [ENTER] key (SET).
 - ▶ Setting will be confirmed and it will return to DATA LINK screen (2/2).

- 7 Press the [PAUSE/MENU] key.
 - ▶ It will return to default screen.

Supplement

It will return to DATA LINK setting screen (2/2) without changing the settings when you press the [ESC] key (CANCEL).

12.6 Skew Scanning

When continuous operation is performed, it is possible to set how much skew is allowed by detecting media skew by comparing the start mark positions of the start page and the current page.

For continuous operation, see Instruction manual for each application software.

Operation

- 1 Press the [PAUSE/MENU] key.

▶ MENU screen is displayed.



- 2 Press the POSITION (▶) key (LINK).

▶ DATA LINK screen (1/2) is displayed.

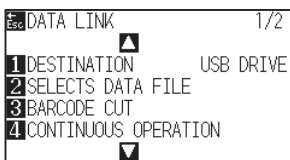

- 3 Press the POSITION (▲) key.

▶ DATA LINK screen (2/2) is displayed.

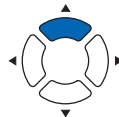
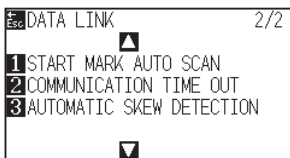

- 4 Press the [3] key (AUTOMATIC SKEW DETECTION).

▶ AUTOMATIC SKEW DETECTION screen is displayed.

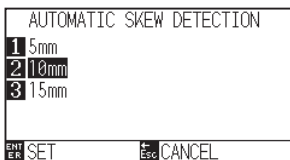

- 5 Press the [1] key (5 mm), the [2] key (10 mm) or the [3] key (15 mm).

Supplement

Perform the settings in Normal mode.

Supplement

During continuous operation, you can select from 5 mm, 10 mm or 15 mm for the skew tolerance.

- 6 Confirm the setting and press the [ENTER] key (SET).
 - ▶ Setting will be confirmed and it will return to DATA LINK screen (2/2).

- 7 Press the [PAUSE/MENU] key.
 - ▶ It will return to default screen.

Supplement

It will return to DATA LINK screen (2/2) without changing the settings when you press the [ESC] key (CANCEL).

Chapter 13: Cutting with supplied application software

For information on how to cut using application software, refer to the instruction manual for each application software.

Chapter 14: Maintenance

This chapter describes the settings for the maintenance.

PRODUCT SUMMARY

- 14.1 *Daily Maintenance***
- 14.2 *Replacing Cutter Blade***
- 14.3 *Cleaning the Cutter Pen***
- 14.4 *Cutter Plunger Exchange***
- 14.5 *Setting the Alarm for Degree of Wear
(BLADE WEAR ALARM)***

14.1 Daily Maintenance

Daily maintenance

During the course of daily plotter operation, be sure to observe the following precautions:

- (1) Never lubricate the mechanisms of the plotter.
- (2) Clean the plotter's casing using a dry cloth that has been moistened in a neutral detergent diluted with water.
Never use thinner, benzene, alcohol, or similar solvents to clean the casings; they will damage the casing's finish.
- (3) Clean the cutting mat using a dry cloth. In case of stubborn stains, use a cloth that has been moistened in alcohol or in a neutral detergent diluted with water.
- (4) Clean the plotter's paper sensors using a cloth moistened in a neutral detergent diluted with water.
* Never use thinner, benzene, alcohol, or similar solvents to clean the sensors; cleaners such as these will damage the sensors.
- (5) When the Y rail sliding surface gets dirty, gently wipe the dirt away with a clean, dry towel.
* The sliding surface has lubricant on it, so be sure not to wipe all the lubricant off as well.

Storing the plotter

When your plotter is not in use, be sure to observe the following points:

- (1) Remove the tool attached to the tool holder.
- (2) Cover the plotter with a cloth to protect it from dust and dirt.
- (3) Do not store the plotter in direct sunlight or in high temperatures.
- (4) Please lower the set lever so the push roller is in a risen state.

14.2 Replacing Cutter Blade

Replace the cutter blade by referring to the structure diagram of the cutter pen.

CAUTION

To avoid bodily injury, handle cutter blades with care.

PHP33-CB09N-HS/
PHP33-CB15N-HS

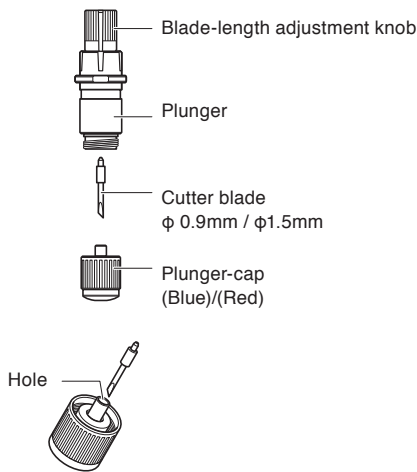

Operation

- 1 Turn the blade-length adjustment knob in the direction of the B arrow and pull the blade into the plunger.

PHP33-CB09N-HS/PHP33-CB15N-HS

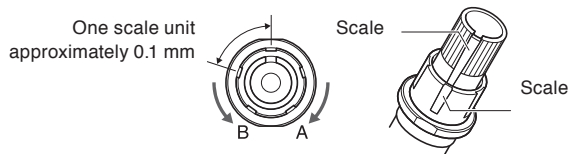

- 2 Turn the plunger cap in the counter-clockwise direction to remove it from the plunger.
- 3 Remove the blade from inside the plunger cap.
- 4 Take a new blade out of its pack. Insert the new blade into the hole provided in the plunger cap.
- 5 Insert the blade into the plunger cap and attach the plunger from above in that state.

6 Secure the plunger cap by turning it clockwise.

 **CAUTION**

<PHP33-CB09N-HS/PHP33-CB15N-HS>

- Please fully insert the cutter blade straight into the plunger cap..

If the cutter blade cannot be inserted straight, please insert the cutter blade after pressing the insertion port of the cutter blade several times.

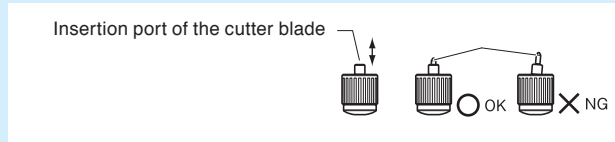

If not installed correctly, it may result in damage to the cutter blade or the plotter itself.

14.3 Cleaning the Cutter Pen

Letting leftover media and paper dust build up on blades can dull them and cause them to deteriorate. Be sure to clean the cutter pen regularly and remove build up.

CAUTION

To avoid bodily injury, handle cutter blades with care.

Cleaning

- 1 Please clean off paper dust and media powder build up from the blade.

After cleaning it, return it to its proper place.

Spin the plunger cap, remove it, and then clean the blade entrance area.

PHP33-CB09N-HS/
PHP33-CB15N-HS

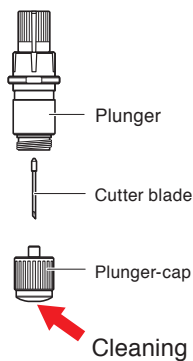

- 2 After completing cleaning, attach the plunger cap.

14.4 Cutter Plunger Exchange

The tip of the cutter plunger gets worn down due to friction with the media.

When the tip of the cutter plunger gets worn down, cut quality suffers.

When the tip of the plunger cap gets worn down, it is recommended that you exchange the cutter plunger.

PHP33-CB09N-HS/
PHP33-CB15N-HS

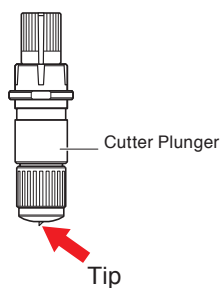

CAUTION

To avoid bodily injury, handle cutter blades with care.

14.5 Setting the Alarm for Degree of Wear (BLADE WEAR ALARM)

This function allows to measure the cut distance of pen or cutter blade and use it as a guide to determine when the cutter blade should be replaced.

BLADE WEAR DETECT ON/OFF, SET BLADE GROUP, ALARM DISTANCE and BLADE WEAR DETECT settings are required.

Operation

- 1 Press the [PAUSE/MENU] key.

▶ MENU screen is displayed.



- 2 Press the [1] key (TOOL).

▶ TOOLS SETTING screen (1/4) is displayed.

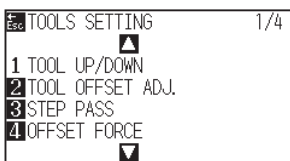

- 3 Press the POSITION (▼) key.

▶ TOOLS SETTING screen (4/4) is displayed.

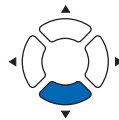
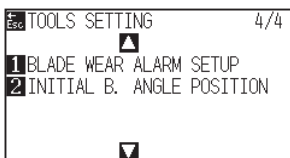

- 4 Press the [1] key (BLADE WEAR ALARM SETUP).

▶ BLADE WEAR ALARM SETUP screen is displayed.

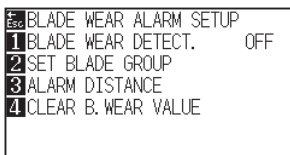

Supplement

Perform the settings in Normal mode.

5 Press the [1] key (BLADE WEAR DETECT.).

▶ BLADE WEAR DETECT. screen is displayed.



6 Press the [1] key (ON) or the [2] key (OFF).

7 Confirm the setting and press the [ENTER] key (SET).

▶ Setting will be confirmed and it will return to BLADE WEAR DETECT. screen.

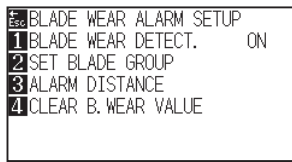

8 Press the [2] key (SET BLADE GROUP).

▶ SET BLADE GROUP screen is displayed.

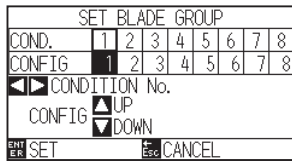

9 Press the POSITION (◀▶) key to select the Tool Condition No. (CONDITION No.).

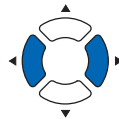

Supplement

You can set the range between 1 and 8.

10 Press the POSITION (▲▼) key and increase or decrease the setting value.

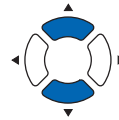

Supplement

You can set the range between 0 and 8. When set to 0, the alarm will not belong to any group.

11 Confirm the setting and press the [ENTER] (SET).

▶ Setting will be confirmed and it will return to BLADE WEAR ALARM SETUP screen

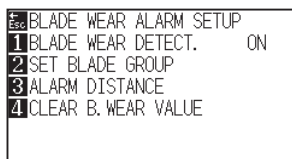

12 Press [3] key (ALARM DISTANCE).

▶ ALARM DISTANCE screen is displayed.

ALARM DISTANCE [m]					
GROUP	8	1	2	3	4
CONFIG	4000	4000	4000	4000	4000
◀▶ GROUP					
CONFIG ▲UP					
▼DOWN					
ENT SET	ESC CANCEL				

13 Press the POSITION (◀▶) key to select the tool condition number (CONDITION No.).

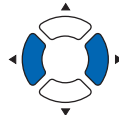

Supplement

You can set the range between 1 and 8.

14 Press the POSITION (▲▼) key and increase or decrease the setting value.

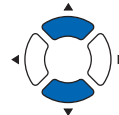

Supplement

You can set the range between 500 m and 5000 m (100m-step).

15 Confirm the setting and press the [ENTER] key (SET).

▶ Setting will be confirmed and it will return to BLADE WEAR ALARM SETUP screen

ESC	BLADE WEAR ALARM SETUP
1	BLADE WEAR DETECT. ON
2	SET BLADE GROUP
3	ALARM DISTANCE
4	CLEAR B. WEAR VALUE

16 Press the [4] key (CLEAR B. WEAR VALUE GROUP).

▶ CLEAR B. WEAR VALUE GROUP screen is displayed.

CLEAR B. WEAR VALUE GROUP	
▲	25%
1	
▼	
ENT SET	ESC CANCEL

17 Press the POSITION (▲▼) key to select the GROUP No.

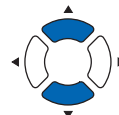

18 Confirm the setting and press the [ENTER] key (SET).

▶ CLEAR ? screen is displayed.

CLEAR B. WEAR VALUE GROUP	
▲	CLEAR?
1	YES; CLEAR
2	CANCEL
ENT SET	ESC CANCEL

Supplement

It will return to CLEAR B. WEAR VALUE GROUP screen without clearing it when you press the [ESC] key (CANCEL).

19 Press the [1] key (Yes, I clear).

- ▶ CLEAR B. WEAR is cleared, it will return to CLEAR B. WEAR VALUE GROUP screen.

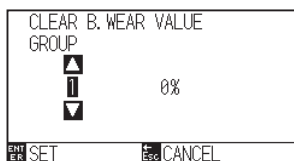

20 Press the [ESC] key (CANCEL).

- ▶ Setting will be confirmed and it will return to CLEAR B. WEAR VALUE GROUP screen.

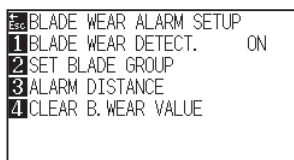

21 Press the [PAUSE/MENU] key.

- ▶ It will return to default screen.

Chapter 15: Troubleshooting

Refer to this chapter if you feel something is wrong, or it does not work right.

It also describes the settings of the plotter, confirming the cutting data, and method to create test patterns.

PRODUCT SUMMARY

- 15.1** *Troubleshooting*
- 15.2** *Printing the Setting of the Plotter*
- 15.3** *Creating Test Pattern*
- 15.4** *Creating CUTTING PRO*
- 15.5** *Confirm the Cutting Data*
- 15.6** *Self Diagnostic Test*

15.1 Troubleshooting

When the plotter does not operate after turning the power on

Symptom	Possible Cause	Solution
<ul style="list-style-type: none">Nothing is displayed on the LCD panel.	There is no power supplied. Or, the plotter is defective.	Check that the power cord is securely connected to the plotter's AC line inlet and the electrical outlet. Check that the power is supplied to the electrical outlet. Contact your Graphtec customer center if the problem still exists.
<ul style="list-style-type: none">"Sum-Ck ROM RAM ERR!!" is displayed on the LCD panel.	The ROM or RAM is defective.	Contact your Graphtec customer center if the problem still exists.

When it does not work right

Symptom	Possible Cause	Solution	Reference
• Drops the media while detecting.	Bright light might be shining onto the media sensor.	Block the light if there is direct sunlight shining on the plotter that is placed near the window. Move away the fluorescent lamps if there is one close to the plotter.	
	Media sensor may be defective.	Contact your sales representative or the Graphtec call center. Set the media sensor to DISABLED to use the plotter temporarily.	Enabling/Disabling the Media Sensors (MEDIA SENSOR)
• Media wobbles.	Push rollers are not set correctly on the grit rollers.	Check the position of the push rollers.	Loading Media (Paper or Marking Film)
	Changing of the hold-down force of the push roller is not suitable for the media.	Please set a media suitable for changing the hold-down force.	Changing the Hold-down Force
• Tool carriage hits the left side of the plotter and "POSITION ALARM" is displayed after selecting the media type. Or, it hits the right side of the plotter and "POSITION ALARM" is displayed.	Push roller sensor may be defective if it hits the left side of the plotter. Home sensor may be defective if it hits the right side of the plotter.	Contact your sales representative or the Graphtec call center. Set the push roller sensor to DISABLED to use the plotter temporarily.	Enabling/Disabling the Push Roller Sensors (PUSH ROLLER SENSOR)
• The plotter stops with "POSITION ALARM" displayed during initialization or cutting.	CONDITION setting for the media is invalid.	Slow down the speed or lower the FORCE.	Setting the Tool Condition
	The pen carriage does not move by hitting something.	Move the object disturbing the operation, and turn on the plotter after turning it off once.	
	External force is applied to the pen carriage while cutting.	Move the object disturbing the operation, and turn on the plotter after turning it off once.	
	Movement is disturbed by the media chaff in the operation area.	Move the object disturbing the operation, and turn on the plotter after turning it off once.	
	The plotter is defective.	Contact your sales representative or the Graphtec call center.	
• It is cutting with origin point shifting to center of the media.	Data created with lower left origin point is received when the plotter is set with center origin point. (With HP-GL command)	Reset the origin point to center on the application software, or reset the origin point of the plotter to lower left.	Setting Origin Point When HPGL is Set
• Media jumps out to forward side.	Selected wrong type of the media.	Check the type of media, "SHEET", "ROLL-1 FRONT EDGE", or "ROLL-2 CURRENT POSITION".	Setting Feeding Method
• Displays command error.	Data sent to the plotter is not correct.	Check the data.	Error Message in GP-GL Command Mode Error Message in HP-GL Command Mode
• It cannot cut above certain length.	Length of the cut is exceeding the length of the page set on the plotter.	Press the [SLOW] key and check the cutting area. Match the setting for the page length.	Setting Length of the Page
• There are too many tool up and down.	Setting for the tangential mode is set to ON.	Turn OFF the setting for the tangential mode unless you are cutting thick media.	Setting the TANGENTIAL MODE
• It is cutting on the grit roller imprint.	Cutting width is widened.	Please revert the expand limit to the default setting.	Setting Cutting Width
• Cannot change the tool condition.	Setting for the sorting is set to ON.	Normally, use the plotter with setting for the sorting OFF.	Sorting the Cutting Data

Symptom	Possible Cause	Solution	Reference
• Tool condition changes.	Setting of the priority is set to PROGRAM.	Change the setting of the priority to MANUAL.	Priority of Tool Condition Selection (CONDITION PRIORITY)
	[ENTER] key is not pressed after changing the TOOL CONDITION.	Check the TOOL CONDITION again.	Setting the Tool Condition
• Media travels tilted.	Media is loaded tilted.	Reload the media.	Loading Media (Paper or Making Film)
	Media is slipping.	Perform pre feed once and make impression to make it harder to slip.	Pre Feed of Media (Paper or Marking Film)
	Changing of the hold-down force of the push roller is not suitable for the media.	Please set a media suitable for changing the hold-down force.	Changing the Hold-down Force
• It does not become specified length. (Slight distance error)	Media is slipping.	Make the speed slower. Reduce the moving speed. Perform feeding.	Setting the Tool Condition Pre Feed of Media (Paper or Marking Film) Setting the Tool Up Speed
	Distance adjust value is not correct.	Perform distance adjust.	Setting the Distance Adjust
• "LOAD MEDIA!" is displayed even if the media is set and media set lever is moved up.	Media is close to transparent and media sensor makes false recognition. (This may happen depending on the media.)	Transparent media cannot be detected. DISABLE the media sensor and set the cut area when this kind of media is used.	Enabling/Disabling the Media Sensors (MEDIA SENSOR) Setting Cutting Area
	Media sensor malfunctions with strong scattered reflection.	Move the position of the light source. Make is so no direct sunlight shines.	
	There may be defective in the operation of the media set lever sensor.	Contact your sales representative or the Graphtec call center.	

When the Cutting Result is Not Good

Symptom	Possible Cause	Solution
<ul style="list-style-type: none"> • Corners are rounded. • Corners are too sharp. 	Blade and OFFSET does not match.	Change the OFFSET. → It is rounded: Increase the OFFSET → It is too sharp: Decrease the OFFSET
<ul style="list-style-type: none"> • The cut line starts out crooked. 	The blade inside the plunger doesn't turn smoothly.	Remove dirt from inside the plunger.
<ul style="list-style-type: none"> • The blade skips and does not completely cut lines that should be solid. • Straight cut lines seems to wobble. 	The blade is extended too far.	Adjust the blade length.
	The cutting speed is too high.	Lower the speed setting.
<ul style="list-style-type: none"> • Coarse resolution of curved lines. 	The software's resolution setting is too low.	Adjust the software's resolution setting.
	The blade offset angle is too low.	Increase the value for the blade offset angle.
<ul style="list-style-type: none"> • The media curls up at the corners. • Fine cut characters peels off. 	The blade is extended too far.	Adjust the blade length.
	Blade and OFFSET does not match.	Change the OFFSET.
	The cutting speed is too high.	Lower the speed setting.
	The blade is dull.	Replace the blade.
	The ACCELERATION setting is too high.	Lower the ACCELERATION setting.
<ul style="list-style-type: none"> • The blade is cutting into the backing sheet 	The blade is extended too far.	Adjust the blade length.
	The cutting FORCE is too high.	Lower the FORCE setting.
<ul style="list-style-type: none"> • The blade falls out of the tool plunger. 	The blade is too small for the tool plunger.	Use a blade that fits securely in the tool plunger.
<ul style="list-style-type: none"> • Media can be cut but it is hard to weed afterwards. • Cut media cannot be pulled up using retack sheet. 	The retack sheet is not sticky enough.	Switch to a stickier retack sheet.
	Media gets entangled during cutting.	Reduce the blade length.
		Lower the FORCE setting.
Cleaning of cut media was postponed too long.	Promptly weed cut media.	
<ul style="list-style-type: none"> • Abnormal noise generated from the tool carriage during cutting. • The media is discolored where the blade has passed. 	Media is rubbed by the tip of the tool plunger.	Adjust the blade length and the cutting FORCE settings.
<ul style="list-style-type: none"> • The cutting results differ from the specified size. 	The STEP SIZE has been set differently at the computer and the plotter.	Set the STEP SIZE to same value.
	Scaling has been specified on the computer.	Check whether scaling has been specified.
<ul style="list-style-type: none"> • Currently selected cutting conditions are disregarded or cannot be changed. 	The parameter priority setting is set to PROGRAM.	Change the setting of the priority to MANUAL.
	The [ENTER] key was not pressed after changing the settings.	Check the operation.
<ul style="list-style-type: none"> • Characters or lines are deformed during pen plotting. 	The plotter is in cutting mode.	Select PEN as the tool in the CONDITION setting.
<ul style="list-style-type: none"> • It does not become specified length. (Slight distance error) 	Distance adjust value is not correct.	Perform distance adjust.
<ul style="list-style-type: none"> • Characters are deformed. • Complex drawings are deformed. 	The STEP PASS setting is set too high.	Lower the STEP PASS setting.
<ul style="list-style-type: none"> • The starting and end points of cutting do not match. 	Coordinate points are incorrectly specified.	Check the coordinate data by plotting it with a pen.
	The media backing is too flimsy.	Switch to a media with a stronger backing.
	Blade rotation is not smooth.	Check that there is no dirt in the blade.

Error Messages in GP-GL Command Mode

Error Displayed	LCD Display	Cause	Solution
E02001	<p>The LCD display shows: 1:Condition No. 1, GP-GL ERROR 1, COMMAND ERROR!, and CONFIRM. Navigation options include 1) TOOL, 2) HOME, and CONFIRM.</p>	The plotter received an unrecognizable command.	Press the [ENTER] key.
		Noise came in when the computer was turned on.	Configure to drive the plotter from the menu of the software.
		The software configuration regarding the output device has been changed.	Reset the interface settings of the software.
		The plotter's interface conditions have changed.	Reset the interface settings of the plotter.
E02004	<p>The LCD display shows: 1:Condition No. 1, GP-GL ERROR 4, PARAMETER OVERFLOW!, and CONFIRM. Navigation options include 1) TOOL, 2) HOME, and CONFIRM.</p>	A command was received containing numeric parameters that exceed that command's permissible range.	Configure to drive the plotter from the menu of the software.
		The software configuration regarding the output device has been changed.	Reset the interface settings of the software.
		The plotter's interface conditions have changed.	Reset the interface settings of the plotter.
E02005	<p>The LCD display shows: 1:Condition No. 1, GP-GL ERROR 5, I/O ERROR!, and CONFIRM. Navigation options include 1) TOOL, 2) HOME, and CONFIRM.</p>	An error occurred in the receipt of data within the interface.	Configure to drive the plotter from the menu of the software.
		The software configuration regarding the output device has been changed.	Reset the interface settings of the software.
		The plotter's interface conditions have changed.	Reset the interface settings of the plotter.
E02006	<p>The LCD display shows: 1:Condition No. 1, GP-GL ERROR 6, OFF SCALE ERROR!, and CONFIRM. Navigation options include 1) TOOL, 2) HOME, and CONFIRM.</p>	The data out of cutting range has been received.	Check the data.
			Check the size of media and the cutting range.
			Check the magnification setting.
			Check the step size settings.

Error Messages in HP-GL Command Mode

If any of the following command errors occur, they are nearly always caused by following 2 reasons.

1. The configuration regarding the output device in the application software has changed.
2. The plotter's interface conditions have changed.

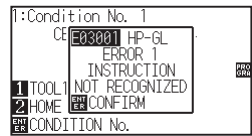
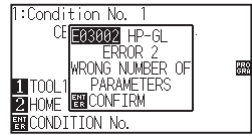
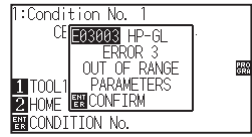
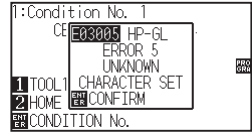
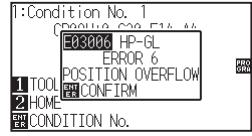
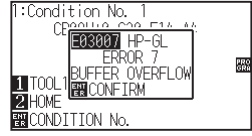
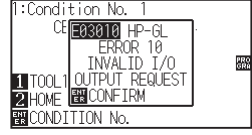
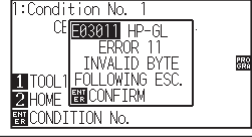
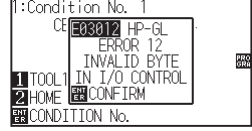

Perform following if these are the cause of the problem.

1. Reconfigure the output device of the application software to the plotter.
2. Reconfigure the plotter's interface conditions.

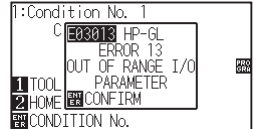
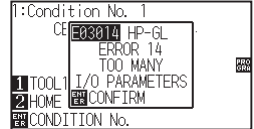
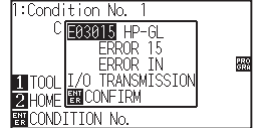
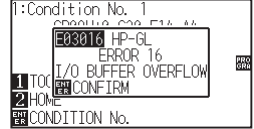
Error Displayed	LCD Display	Cause	Solution
E03001 Error 1		An unrecognizable instruction was executed.	Execute a recognizable command.
E03002 Error 2		Wrong number of parameters were specified.	Execute the command with the correct number of parameters.
E03003 Error 3		An unusable parameter was executed.	Execute a recognizable parameter.
E03005 Error 5		An unusable character set was specified.	Specify usable character set.
E03006 Error 6		Coordinates of command specified out of cutting area.	Execute coordinates within the cutting area.
E03007 Error 7		The data being input exceeds the capacity of the plotter's downloadable character buffer, polygon buffer, etc.	Adjust the buffer size.
E03010 Error 10		Other output command was executed while executing an output command.	Check the program.
E03011 Error 11		An invalid byte was received after ESC code.	Check the program.
E03012 Error 12		Invalid byte was received within device control command.	Check the program.

Error Displayed	LCD Display	Cause	Solution
E03013 Error 13		A parameter outside of the permissible range was specified in the I/O related command.	Check the program.
E03014 Error 14		Too many parameters in the I/O related command.	Check the program.
E03015 Error 15		Framing error, parity error, or overrun error has occurred.	Set the RS-232C transmission condition.
E03016 Error 16		Interface buffer memory has overflowed.	Set the RS-232C transmission condition.



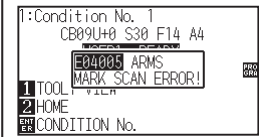
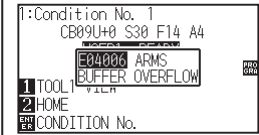
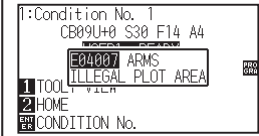
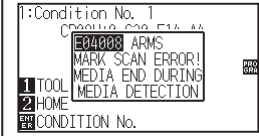
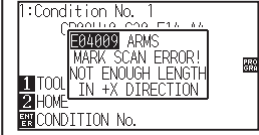
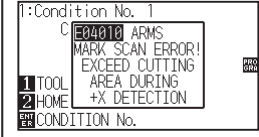
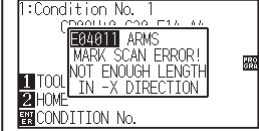

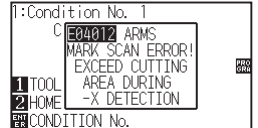
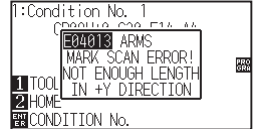
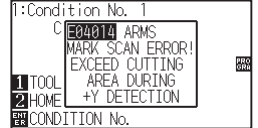
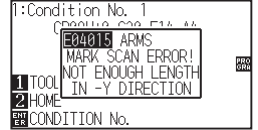
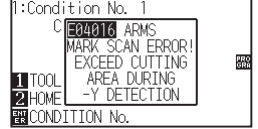
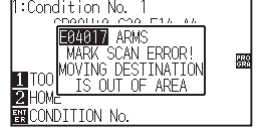
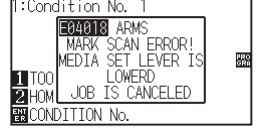
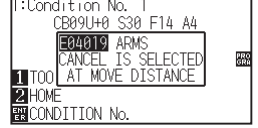
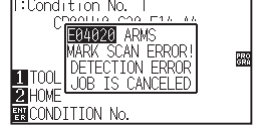
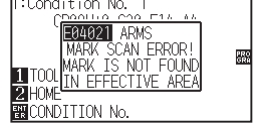
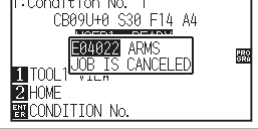
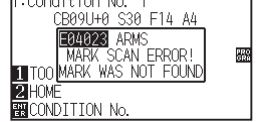

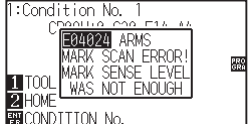
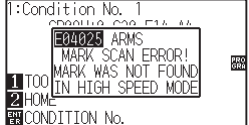
ARMS Error Messages



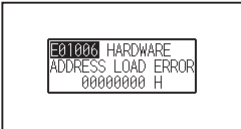

Error Displayed	LCD Display	Cause	Solution
E04001		Tilt to adjust with AXIS ALIGNMENT is too large.	Reload the media.
E04004		It is over the setting range of the distance adjust.	Reset to smaller value.
E04005		Could not scan the registration marks.	Check the registration scan position.
E04006		Amount of data has exceeded the I/O buffer size for the segment area registration mark.	Decrease the data.
E04007		Test pattern plotting position is not within the plotting area for sensor position adjustment.	Move the media toward center and plot the test pattern.
E04008		Media end was detected while detecting the registration mark.	Check the media. Check the print position of the registration mark.
E04009		It has exceeded detection area while detecting the registration mark.	Check the media. Check the print position of the registration mark.
E04010		It has exceeded detection area while detecting the registration mark.	Check the media. Check the print position of the registration mark.
E04011		It has exceeded detection area while detecting the registration mark.	Check the media. Check the print position of the registration mark.

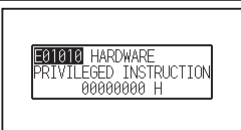
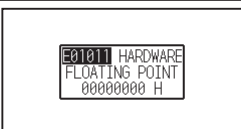
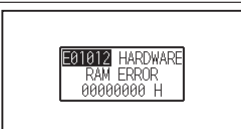
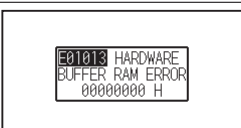
Error Displayed	LCD Display	Cause	Solution
E04012		It has exceeded detection area while detecting the registration mark.	Check the media. Check the print position of the registration mark.
E04013		It has exceeded detection area while detecting the registration mark.	Check the media. Check the print position of the registration mark.
E04014		It has exceeded detection area while detecting the registration mark.	Check the media. Check the print position of the registration mark.
E04015		It has exceeded detection area while detecting the registration mark.	Check the media. Check the print position of the registration mark.
E04016		It has exceeded detection area while detecting the registration mark.	Check the media. Check the print position of the registration mark.
E04017		It has exceeded detection area while detecting the registration mark.	Check the media. Check the print position of the registration mark.
E04018		Media set lever was lowered.	Reload the media and try again.
E04019		There was cancel operation by the user.	Redo the process.
E04020		There is a defect in the detection settings value.	Check the settings value.
E04021		Registration mark was not detected in the auto detection area.	Check the media. Check the print position of the registration mark.
E04022		There was cancel operation by the user.	Redo the process.
E04023		Registration mark was not detected.	Change the color of the registration mark. Check the media. Check the print position of the registration mark.

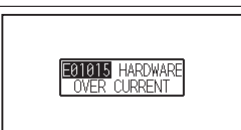
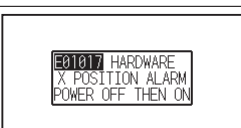
Error Displayed	LCD Display	Cause	Solution
E04024		Registration mark was not detected.	Change the color of the registration mark. Check the media. Check the print position of the registration mark.
E04025		Registration mark was not detected.	Change the color of the registration mark. Check the media. Check the print position of the registration mark.

Other Error Messages

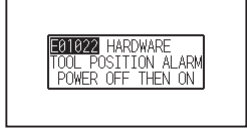
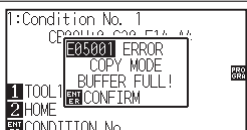
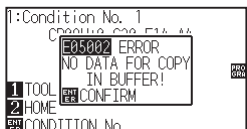
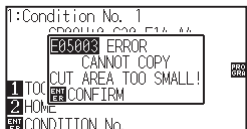
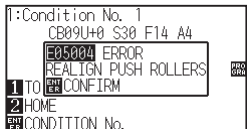
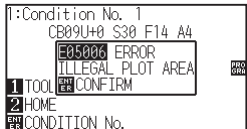
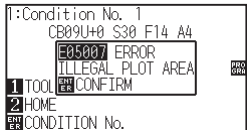
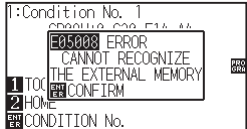
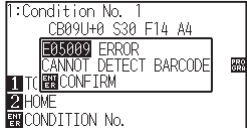
Error Displayed	LCD Display	Cause	Solution
E01001 to E01005		The plotter is defective.	Contact your sales representative or the Graphtec call center.
E01006		The plotter is defective.	Contact your sales representative or the Graphtec call center.
E01007		The plotter is defective.	Contact your sales representative or the Graphtec call center.
E01008		The plotter is defective.	Contact your sales representative or the Graphtec call center.
E01009		The plotter is defective.	Contact your sales representative or the Graphtec call center.
E01010		The plotter is defective.	Contact your sales representative or the Graphtec call center.
E01011		The plotter is defective.	Contact your sales representative or the Graphtec call center.
E01012		The plotter is defective.	Contact your sales representative or the Graphtec call center.
E01013		The plotter is defective.	Contact your sales representative or the Graphtec call center.
E01014		The plotter is defective.	Contact your sales representative or the Graphtec call center.
E01015		The plotter is defective.	Contact your sales representative or the Graphtec call center.
E01017		The plotter is defective. Load on the motor was too large.	Move the object disturbing the operation, and turn on the plotter after turning it off once. Do not use heavy media.

Error Displayed	LCD Display	Cause	Solution
E01019		The plotter is defective. Load on the motor was too large.	Move the object disturbing the operation, and turn on the plotter after turning it off once. Do not use heavy media.
E01021		The plotter is defective. Load on the motor was too large.	Move the object disturbing the operation, and turn on the plotter after turning it off once. Do not use heavy media.
E01022		The plotter is defective. There was a heavy load on the up and down function of the tool carriage.	Please clear any obstruction in the up and down function of the tool carriage and turn the power back on. If the error display continues to show, please contact the store where you bought the product or our Customer Center.
E05001		Data larger than the buffer size cannot be copied.	Perform normal cutting not using the copy mode.
E05002		There is no data to copy.	Perform normal cutting by sending the data, then use the copy mode.
E05003		Media valid area to copy is too small.	Use larger media. Confirm the copy start position.
E05004		The push roller is not on the grit roller.	Set the push roller on the grit roller.
E05006		Distance between the bottom left and top right of the AREA setting is less than 10 mm.	Perform the AREA setting again.
E05007		Test pattern for the TOOL OFFSET ADJ. cannot start plotting because the start position is at the edge of the media.	Set the start position inside the media.
E05008		External memory (USB memory) cannot be recognized.	Insert external memory (USB memory).
E05009		Bar Code cannot be scanned.	Check the print result of Bar Code.
E05010		Bar Code cutting is not available when Rotation is set to ON.	Set Rotation is set to OFF to use Bar Code cutting.

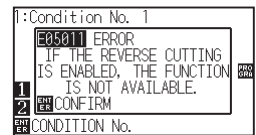
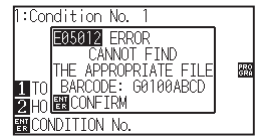
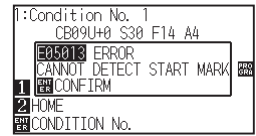
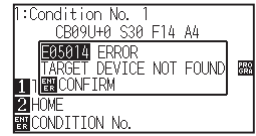
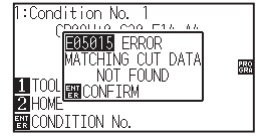
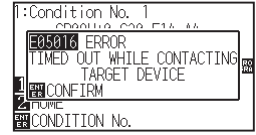
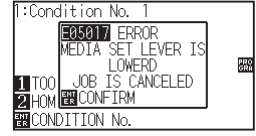
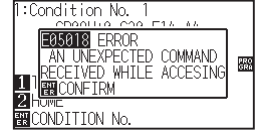
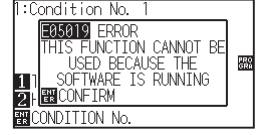
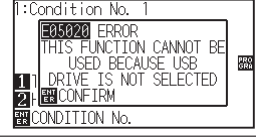
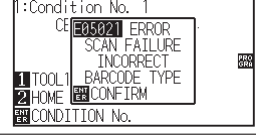
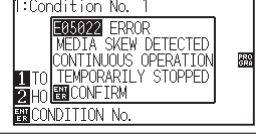
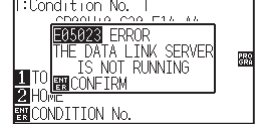
Error Displayed	LCD Display	Cause	Solution
E05011		Bar Code cutting is not available when Mirror is set to ON.	Set Mirror is set to OFF to use Bar Code cutting.
E05012		The desired file cannot be found in external memory (USB memory).	Save the desired file in external memory (USB memory).
E05013		Start mark cannot be scanned.	Check the print result of start mark. Move the tool carriage above the start mark.
E05014		The selected connection destination cannot be found.	Connect to the selected connection destination using USB or LAN cable.
E05015		There is no appropriate cutting data for the data link server.	Check the data link server.
E05016		The communication to the data link server is not established.	Check the data link server. Increase the time until the timeout.
E05017		Media set lever is lowered.	Set the media again.
E05018		A trouble occurs in the data link server.	Restart the data link server.
E05019		A trouble occurs in communication to the data link server.	Set the media again. Turn the power off and then on again
E05020		The connection destination is not USB memory	Set connection destination to USB memory.
E05021		The type of bar code is different.	Apply the appropriate bar code.
E05022		Media skew is detected.	Set the media again. Increase the skew detection set value.
E05023		Data link server is not activated.	Activate data link server.

Caution Message

Symptom	LCD Display	Description
W06008		When command is set to auto, the DUMP mode is not available.
W06009		When panel cutting has been set to ON, the following functions are not available. <ul style="list-style-type: none"> • ARMS function • AREA function • COPY function • BARCODE CUT function • CONTINUOUS OPERATION function

15.2 Printing the Setting of the Plotter

Condition setting list can be printed when you need to check the current setting of the plotter.

CAUTION

- Do not place your hand around the moving areas. The tool carriage will start moving, so there is a chance of injury. Tool carriage will start to move immediately after selecting to print the CONDITION list.
- Once you start printing, pause/cancel cannot be performed in the middle.

Operation

- 1 Load a media larger than A3 size.
- 2 Set the pen tool to the tool holder (Backward) and select the condition where the pen tool is set.

Supplement

See "Loading Media (Paper or Marking Film)" for loading the media.

- 3 Press the [PAUSE/MENU] key in the default screen.

▶ MENU screen is displayed.



Supplement

- See "Attaching a Tool" for setting the pen tool.
- For changing the tool conditions please refer to "Selecting Tool Condition", and for tool settings please refer to "Setting the Tool".

- 4 Press the POSITION (◀) key (TEST).

▶ TEST screen (1/2) is displayed.

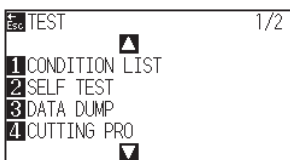

Supplement

Perform the settings in Normal mode.

- 5 Press the [1] key (CONDITION LIST).

▶ CONDITION LIST PRINT screen is displayed.

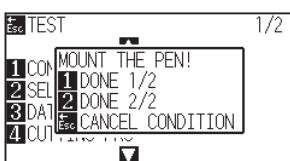

6 Press the [1] key (DONE 1/2) or the [2] key (DONE 2/2).

▶ Message to confirm tool position is displayed.

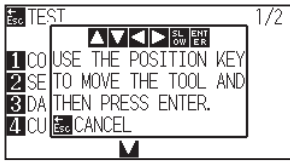

7 Move the tool carriage to print start position by pressing the POSITION (▲▼◀▶) keys.

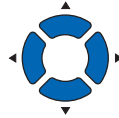

8 Confirm that movable parts of the tool and media can safely operate and press the [ENTER] key.

▶ Selected page of the CONDITION LIST is printed.

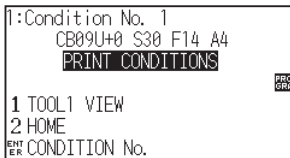

9 It will return to READY status when the printing is completed.

10 Press the [PAUSE/MENU] key.

▶ It will return to default screen.

Supplement

Press the [ESC] key (CANCEL CONDITION) to return to the TEST screen without printing the list.

CAUTION

Do not place your hand around the moving areas. The tool carriage will start moving, so there is a chance of injury.

Supplement

Load the media and repeat steps 6 to 8 to print different page at this point.

15.3 Creating Test Pattern

Create a self-test pattern to check the operation of the plotter.

CAUTION

Do not place your hand around the moving areas. The tool carriage will start moving, so there is a chance of injury. Tool carriage will start to move immediately after selecting to plot the test pattern.

Operation

- 1 Load a media larger than A3 size.
- 2 Set the pen tool to the tool holder (Backward) and select the condition where the pen tool is set.

Supplement

See "Loading Media (Paper or Marking Film)" for loading the media.

Supplement

- See "Attaching a Tool" for setting the pen tool.
- For changing the tool conditions please refer to "Selecting Tool Condition" , and for tool settings please refer to "Setting the Tool".

- 3 Press the [PAUSE/MENU] key in the default screen.

▶ MENU screen is displayed.



Supplement

Perform the settings in Normal mode.

- 4 Press the POSITION (◀) key (TEST).

▶ TEST screen (1/2) is displayed.

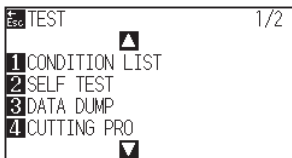

- 5 Press the [2] key (SELF TEST).

▶ NOUNT THE PEN! screen is displayed.

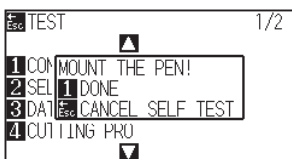

- 6 Confirm that the pen tool is set.
- 7 Confirm that operation area of tool and media is safe.

- 8 Press the [1] key (DONE).
▶ Plotting of the test pattern starts.

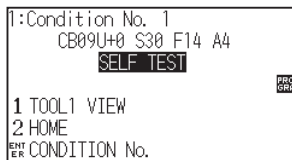

- 9 Turn the power off to stop the printing.

⚠ CAUTION

Do not place your hand around the moving areas. The tool carriage will start moving, so there is a chance of injury.

Supplement

It will return to TEST screen without printing by pressing the [ESC] key (CANCEL SELF TEST).

Supplement

It will keep on printing until the power is turned off once the printing is started by pressing the [1] key (DONE).

15.4 Creating CUTTING PRO

Create a test pattern to check the operation of the plotter.

⚠ CAUTION

Do not place your hand around the moving areas. The tool carriage will start moving, so there is a chance of injury. Tool carriage will start to move immediately after selecting to plot the test pattern.

Operation

- 1 Load a media larger than A3 size.

- 2 Set the pen tool to the tool holder (Backward) and select the condition where the pen tool is set.

- 3 Press the [PAUSE/MENU] key in the default screen.

▶ MENU screen is displayed.



- 4 Press the POSITION (◀) key (TEST).

▶ TEST screen (1/2) is displayed.

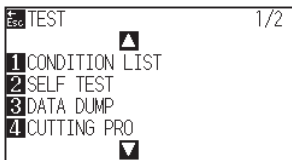

- 5 Press the [4] key (CUTTING PRO).

▶ CUTTING PRO start screen is displayed.

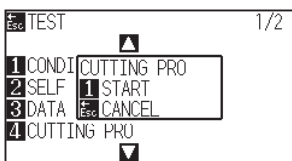

Supplement

See "Loading Media (Paper or Marking Film)" for loading the media.

Supplement

- See "Attaching a Tool" for setting the pen tool.
- For changing the tool conditions please refer to "Selecting Tool Condition", and for tool settings please refer to "Setting the Tool".

Supplement

Perform the settings in Normal mode.

- 6 Confirm that the pen tool is set.
- 7 Confirm that operation area of tool and media is safe.

8 Press the [1] key (START).

▶ Start the CUTTING PRO.

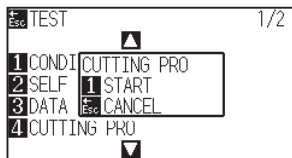

9 After the completion of print, the TEST screen (1/2) is displayed.

CAUTION

Do not place your hand around the moving areas. The tool carriage will start moving, so there is a chance of injury.

Supplement

It will return to TEST screen without printing by pressing the [ESC] key (CANCEL).

15.5 Confirm the Cutting Data

Output of the dump list of the cutting data received by the plotter is possible. It is used to check if the transmission of cutting data is performed correctly.

CAUTION

Do not place your hand around the moving areas. The tool carriage will start moving, so there is a chance of injury. Tool carriage will start to move immediately after selecting to print the dump list.

Supplement

- There may be a difference in the RS-232C transmission condition or the command setting when the printed output and the display of transmission data does not match. Check the transmission condition and the command.
- If the command setting is "Auto", the dump list of the cutting data is not output. Please set the command to "GP-GL" or "HP-GL".

Operation

- 1 Load a media larger than A4 size.
- 2 Set the pen tool to the tool holder (Backward) and select the condition where the pen tool is set.

Supplement

See "Loading Media (Paper or Marking Film)" for loading the media.

- 3 Press the [PAUSE/MENU] key in the default screen.

▶ MENU screen is displayed.

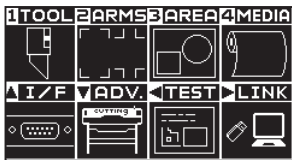

Supplement

- See "Attaching a Tool" for setting the pen tool.
- For changing the tool conditions please refer to "Selecting Tool Condition", and for tool settings please refer to "Setting the Tool".

- 4 Press the POSITION (◀) key (TEST).

▶ TEST screen (1/2) is displayed.

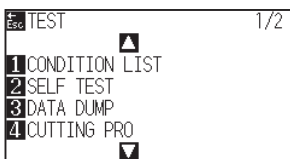

Supplement

Perform the settings in Normal mode.

5 Press the [3] key (DATA DUMP).

▶ DATA DUMP start screen is displayed.

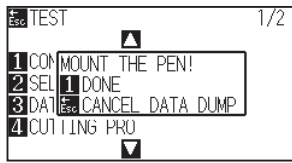

6 Confirm that the pen tool is set.

7 Confirm that operation area of tool and media is safe.

8 Press the [1] key (DONE).

9 Send the cutting data.

▶ The received cutting data (command) is output.

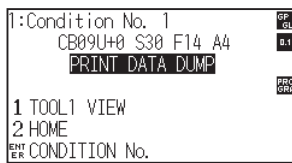

10 Turn the power off to stop the printing.

CAUTION

Do not place your hand around the moving areas. The tool carriage will start moving, so there is a chance of injury.

Supplement

It will return to TEST screen without printing by pressing the [ESC] key (CANCEL DATA DUMP).

Supplement

It will keep on printing until the power is turned off once the printing is started by pressing the [1] key (DONE).

15.6 Self Diagnostic Test

Operation status can be tested by self-diagnostic test by operating the sensors and switches following the instruction on the screen.

Supplement

Diagnostic test can be performed only right after the power is turned on. DIAGNOSTICS cannot be selected from the menu once any operation, such as loading media, is performed.

Operation

- 1 Confirm that the power is turned off.
- 2 Turn the power on without loading the media.
- 3 In the default screen, press the [PAUSE/MENU] key.

▶ MENU screen is displayed.



- 4 Press the POSITION (◀) key (TEST).

▶ TEST screen (1/2) is displayed.

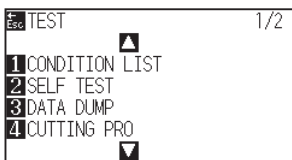

- 5 Press the POSITION (▲) key.

▶ TEST screen (2/2) is displayed.

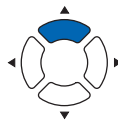
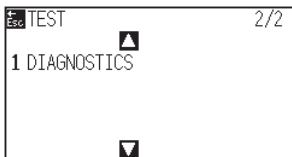

Supplement

Perform the settings in Normal mode.

6 Press the [1] key (DIAGNOSTICS).

▶ DIAGNOSTICS start screen is displayed.

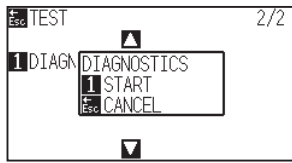

7 Press the [1] key (START).

▶ Messages for testing are displayed on the screen.

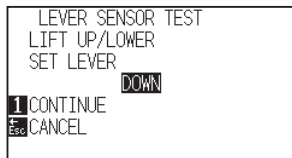

8 Operate the keys and the sensors following the instructions on the screen.

▶ "OK" will be displayed if the operation is detected correctly, and next test will start.

▶ It will return to TEST screen once all the test items are completed.

Test items are as following. (It may be changed.)

1	Set lever sensor	2	Home sensor	3	Push roller sensor	4	-X media sensor
5	+X media sensor	6	X motor signal	7	Y motor signal	8	Tool height signal
9	[1] key	10	[2] key	11	[3] key	12	[4] key
13	[BARCODE] key	14	[SLOW] key	15	POSITION [▲] key	16	POSITION [◀] key
17	POSITION [▼] key	18	POSITION [▶] key	19	[PAUSE/MENU] key	20	[COND/TEST] key
21	[ORIGIN] key	22	[COPY] key	23	[ESC] key	24	[ENTER] key

Reading the error message

Contents of most current 32 errors can be checked. Errors before that are not recorded.

Operation

- 1 Press the [PAUSE/MENU] key in the default screen.

▶ MENU screen is displayed.

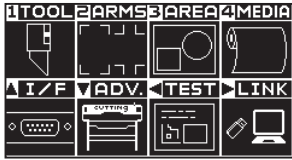

- 2 Press the POSITION (▼) key (ADV.).

▶ ADVANCE screen (1/4) is displayed.

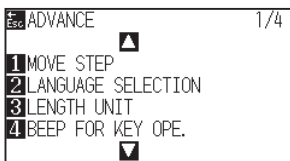

- 3 Press the POSITION (▲) key twice.

▶ ADVANCE screen (3/4) is displayed.

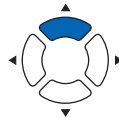
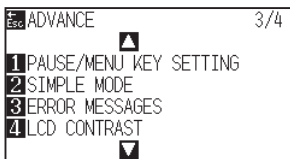

- 4 Press the [3] key (ERROR MESSAGES).

▶ ERROR MESSAGES screen is displayed. Left column is time the error occurred, and right column is the type of the error. 4 error messages are displayed at once. If there are more error messages, next 4 messages will be displayed by pressing the POSITION (▲▼) key.

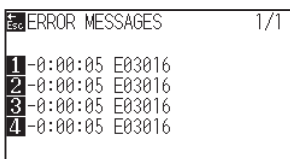

Supplement

Perform the settings in Normal mode.

Supplement

- "NO ERROR" will be displayed if there is no error.



- Up to 4 error messages will be displayed on the screen. Up to 32 error messages can be displayed by pressing the POSITION (▲▼) key.
- When displayed, while the power is on it indicates how long ago an error occurred. The lower the value, the more recently the error occurred.

5 Press the [1] to [4] keys to see the contents of the error.

▶ Error message corresponding to the pressed key is displayed.

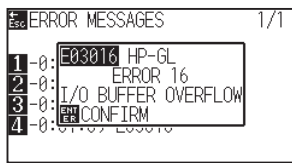

6 Press the [ENTER] key (CONFIRM) when the error message is confirmed.

▶ It will return to ERROR MESSAGES screen.

7 Press the [PAUSE/MENU] key.

▶ It will return to default screen.

Supplement

Press the POSITION (▲▼) key in the screen of step 4 as necessary and repeat steps 5 and 6 if there are multiple error messages you would like to see

Appendix

This chapter describes the specification of the plotter.

PRODUCT SUMMARY

- A.1** *Main Specifications*
- A.2** *Options and Supplies*
- A.3** *External Dimensions*
- A.4** *Menu Tree*
- A.5** *Initial Setting*

A.1 Main Specifications

	CE7000-40	CE7000-60	CE7000-130	CE7000-160
CPU	32bit CPU			
Configuration	Grit-rolling plotter			
Drive	Digital servo			
Max. Cut Area	375 mm × 50 m	603 mm × 50 m	1270 mm × 50 m	1524 mm × 50 m
Guaranteed precision cutting area ^{*1}	355 mm × 2 m	583 mm × 5 m ^{*2}	1250 mm × 5 m ^{*2}	1504 mm × 5 m ^{*2}
Mountable media width ^{*3}	Min: 50 mm Max: 484 mm	Min: 50 mm Max: 712 mm	Min: 50 mm Max: 1372 mm	Min: 50 mm Max: 1626 mm
Available roll media diameter	Max. diameter: 180 mm, Min. diameter: 76 mm			
The number of push rollers	2	2	4	4
Max. cutting speed	60 cm/s (All directions)	90 cm/s (45°direction)	100 cm/s (45°direction)	
Specifiable speeds (cm/s)	1 to 10, 15, 20, 25, 30, 35, 40, 45, 50, 55, 60,	1 to 10, 15, 20, 25, 30, 35, 40, 45, 50, 55, 60, 64	1 to 10, 15, 20, 25, 30, 35, 40, 45, 50, 55, 60, 65, 70, 71	
Max. cutting force	4.41N (450gf)			
Min. character size	5 mm (0.197 in.) alphanumeric Helvetica med. Font ^{*1}			
Mechanical resolution	0.005mm			
Programmable resolution	GP-GL : 0.1/0.05/0.025/0.01 mm HP-GL ⁴ : 0.025 mm			
Repeatable accuracy ^{*1}	0.1 mm/in unit of 2 m (Designated Film and Cut Conditions)			
Number of cutters/pens	1 pc.			
Usable pen type	Water-based fiber-tip and oil-based ballpoint			
Compatible media	Mono-vinyl chloride media, fluorescent media, and reflective media up to 0.25 mm thick (Excluding high-intensity reflective film)			
Interface	USB2.0 (Full Speed) , Ethernet 10BASE-T/100BASE-TX, RS-232C ^{*6}			
Buffer memory	2 MB			
Resident command sets	GP-GL/HP-GL ^{*4} (Control panel switching, Auto switching)			
LCD display	Graphic type (240 × 128 dot)			
Power supply	AC100-120V, AC200V-240V 50/60Hz			
Power consumption	100 VA or less			
Operating environment	10 to 35°C, 35 to 75 % R.H. (non-condensing)			
Guaranteed accuracy environment	16 to 32°C, 35 to 70 % R.H. (non-condensing)			
External dimensions (Approx.) (W × D × H)	772 mm × 460 mm × 313 mm	1005 mm × 582 mm × 1092 mm ^{*5}	1704 mm × 811 mm × 1215 mm ^{*5}	1916 mm × 811 mm × 1215 mm ^{*5}
Weight (Approx.)	13 kg ^{*5}	22 kg ^{*5}	51 kg ^{*5}	55 kg ^{*5}

*1: Varies depending on the type of Graphtec-authorized film and the cutting conditions.

*2: When using basket.

*3: Describes the usable paper width. The accuracy of minimum media width is the width in parentheses ().

*4: HP-GL is a registered trademark of the US Hewlett Packard Company.

*5: Roll-medium tray or stand is included.

*6: RS-232C interface is optional depending on region. For details, please contact the distributor where you purchased.

A.2 Options and Supplies

Supplies

Item	Model	Contents
Cutter plunger	PHP33-CB09N-HS	Used with ϕ 0.9 mm diameter cutter blades (for CB09)
	PHP33-CB15N-HS	Used with ϕ 1.5 mm diameter cutter blades (for CB15)
Water-based fiber-tip pen plunger	PHP31-FIBER	Plunger for water-based fiber-tip pen (set of 1)
Oil-based ballpoint pen plunger	PHP34-BALL	Plunger for oil-based fiber-tip pen (set of 1)
Water-based fiber-tip pen	KF700-BK	1 set (10 pcs. Black)
	KF700-RD	1 set (10 pcs. Red)
Oil-based ballpoint pen	KB700-BK	1 set (10 pcs. Black)
Carrier Sheet	CR09300-A3	2 sht.

For detailed information about the cutter blade, refer to the Cutter Blade Manual.

Please check our company's home page for the latest information on supplies.

Options

Item	Model	Contents	Quantity
Stand	ST0118	Used with CE7000-60	1 set
Basket	PG0103	Used with CE7000-60	1 set
	PG0104	Used with CE7000-130	1 set
	PG0105	Used with CE7000-160	1 set
Carrier Sheet Table	OPH-A45	Used with CE7000-40/60	1 set

Optional items may vary depending on the area. For details, please contact the distributor where you purchased.

Please check our company's home page for the latest information on supplies.

A.3 External Dimensions

CE7000-40

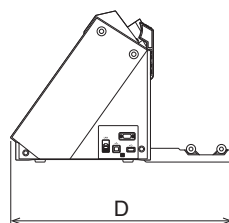
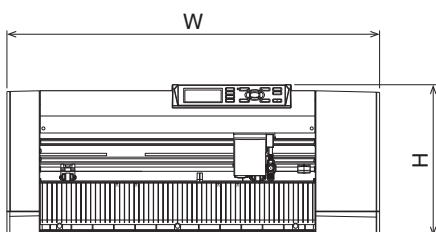
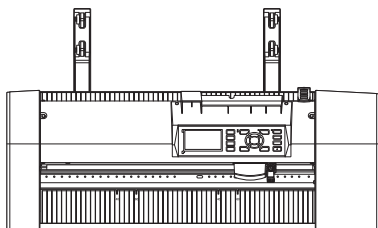

Unit: mm
Dimensional accuracy: ±5mm

	CE7000-40
External dimensions (approx.) (W × D × H)* Unit: mm	772×460×313

CE7000-60

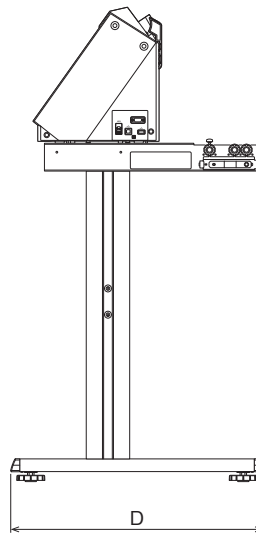
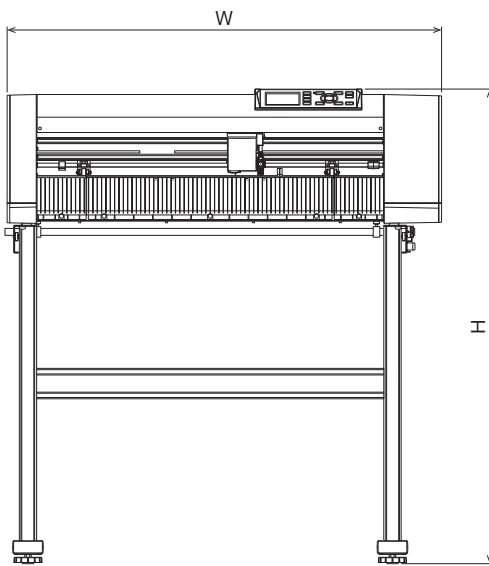
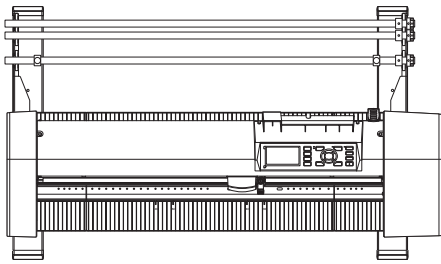

Unit: mm
Dimensional accuracy: ± 5 mm

	CE7000-60
External dimensions (approx.) (W × D × H)* Unit: mm	1005×582×1092

*: Stand are included.

CE7000-130/160

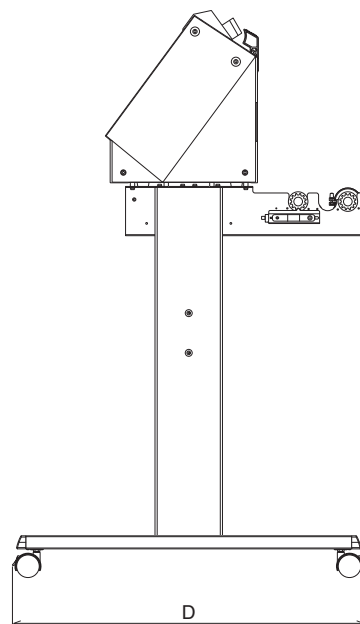
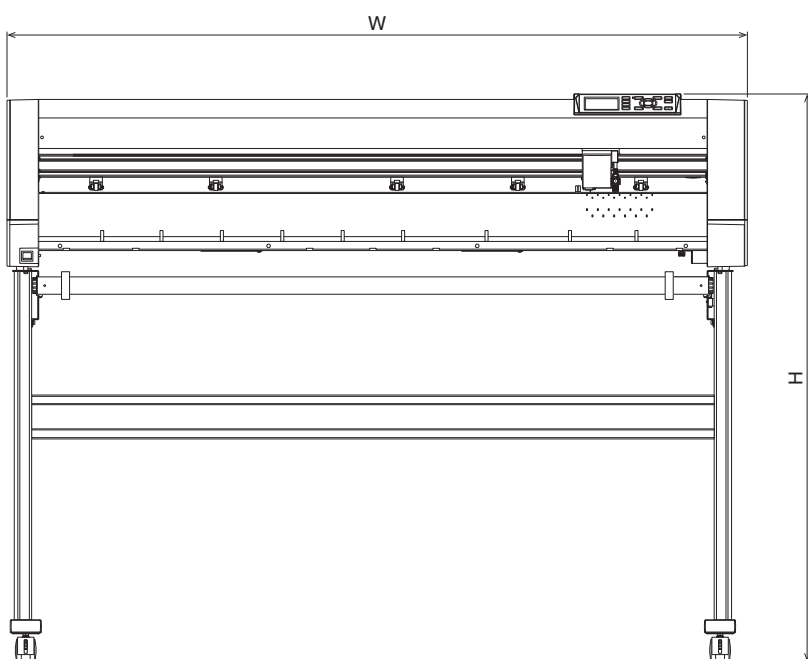
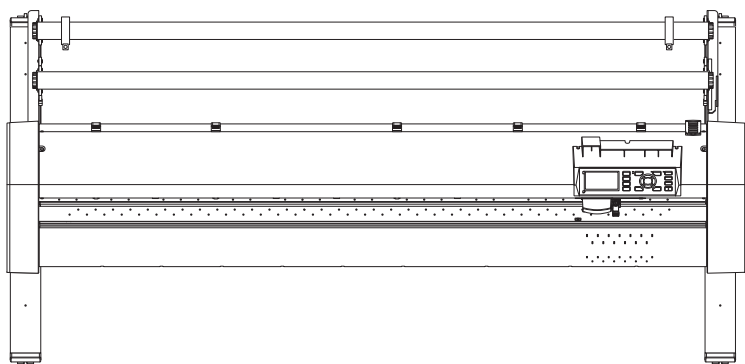

Unit: mm

Dimensional accuracy: ± 5 mm

	CE7000-130	CE7000-160
External dimensions (approx.) (W × D × H)* Unit: mm	1704×811×1215	1916×811×1215

*: Stand are included.

A.4 Menu Tree

Simple mode

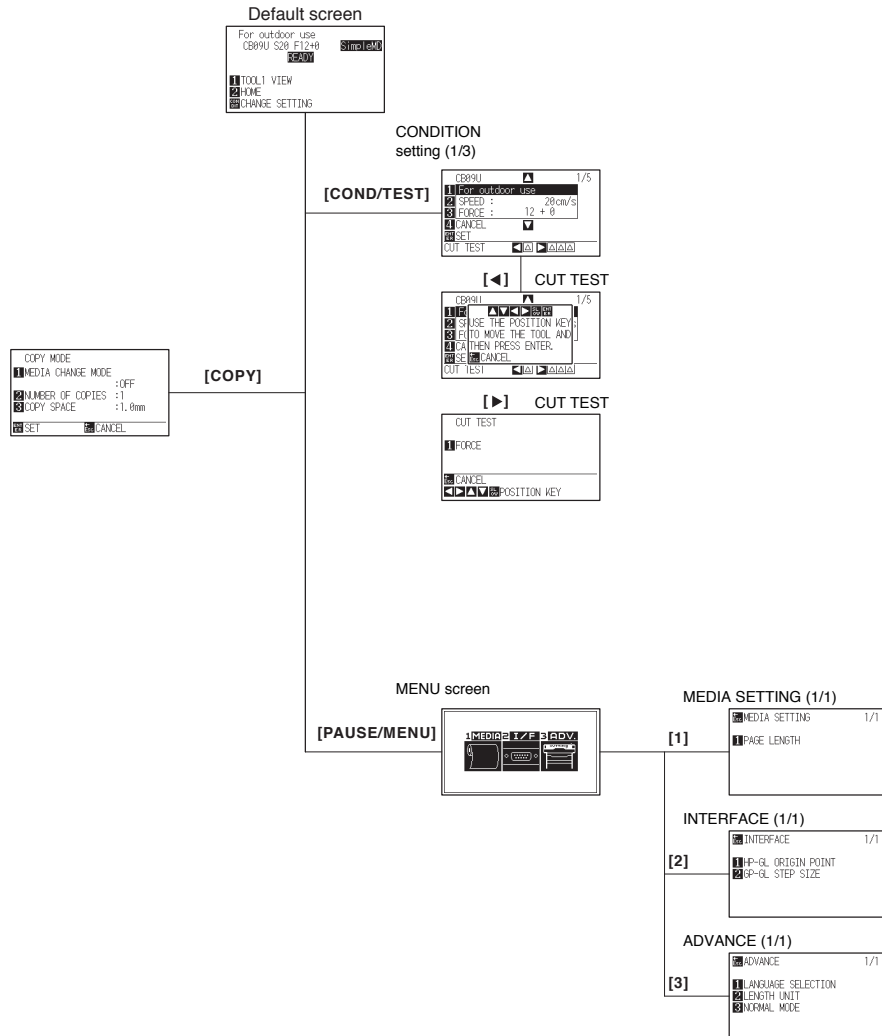

Normal mode

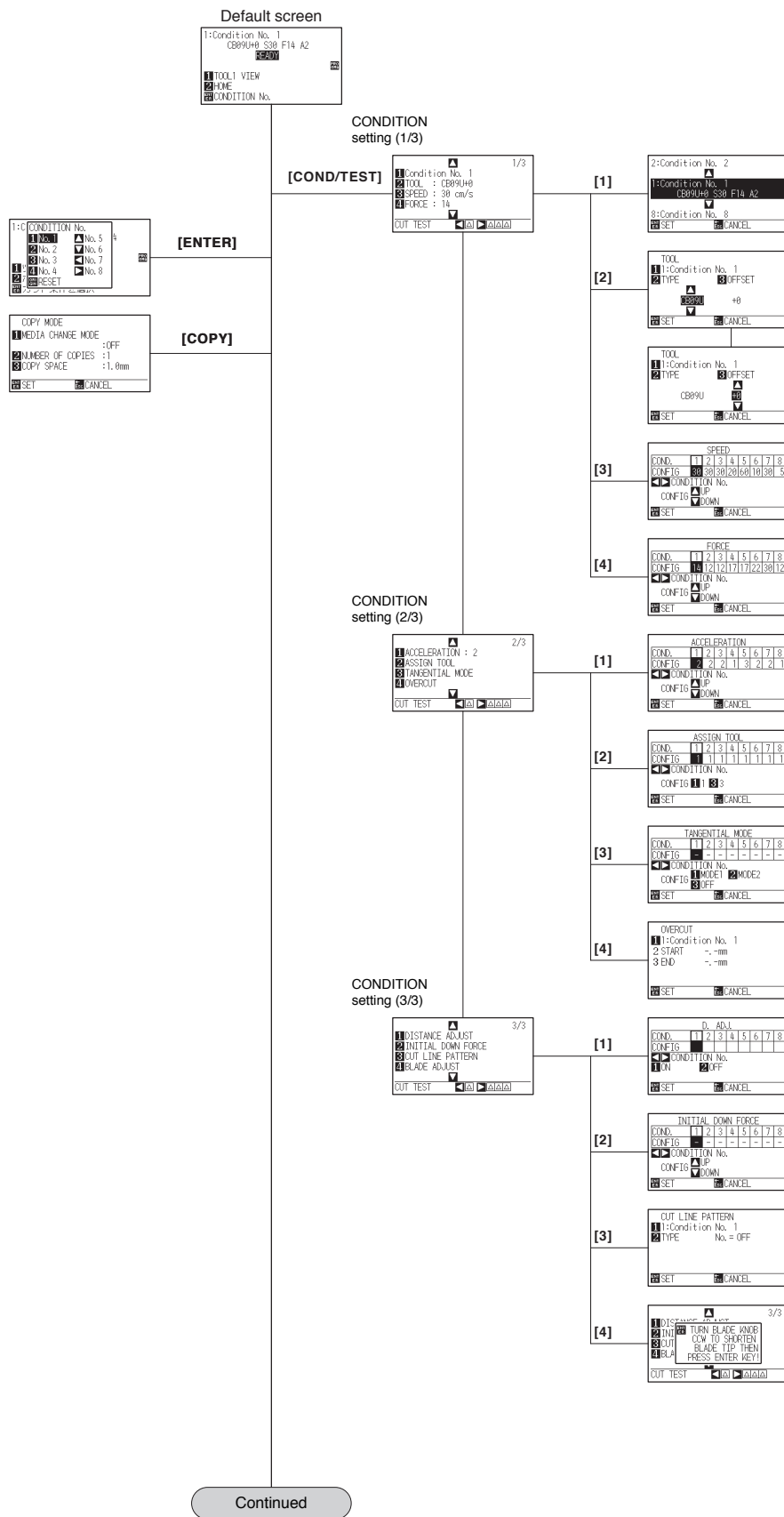

Default screen
(Continued)

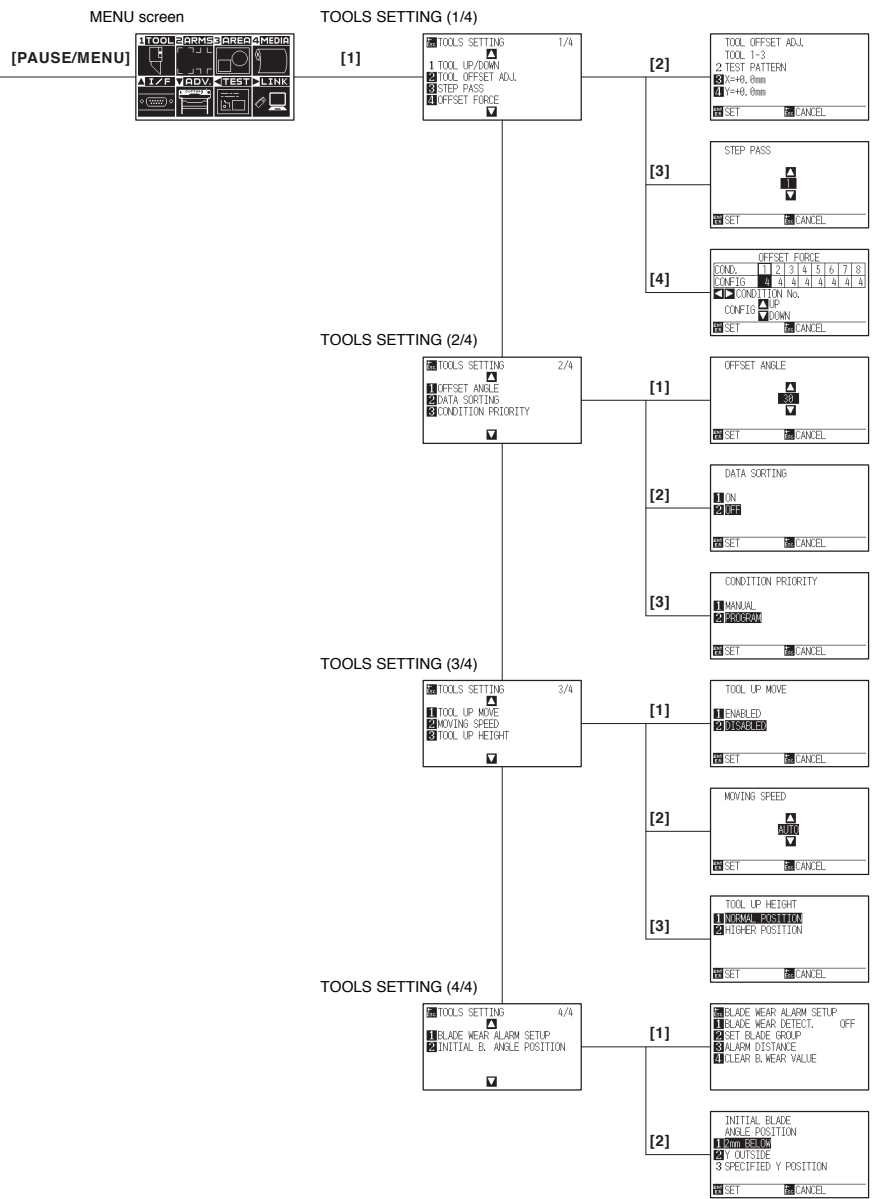

Continued

Default screen
(Continued)

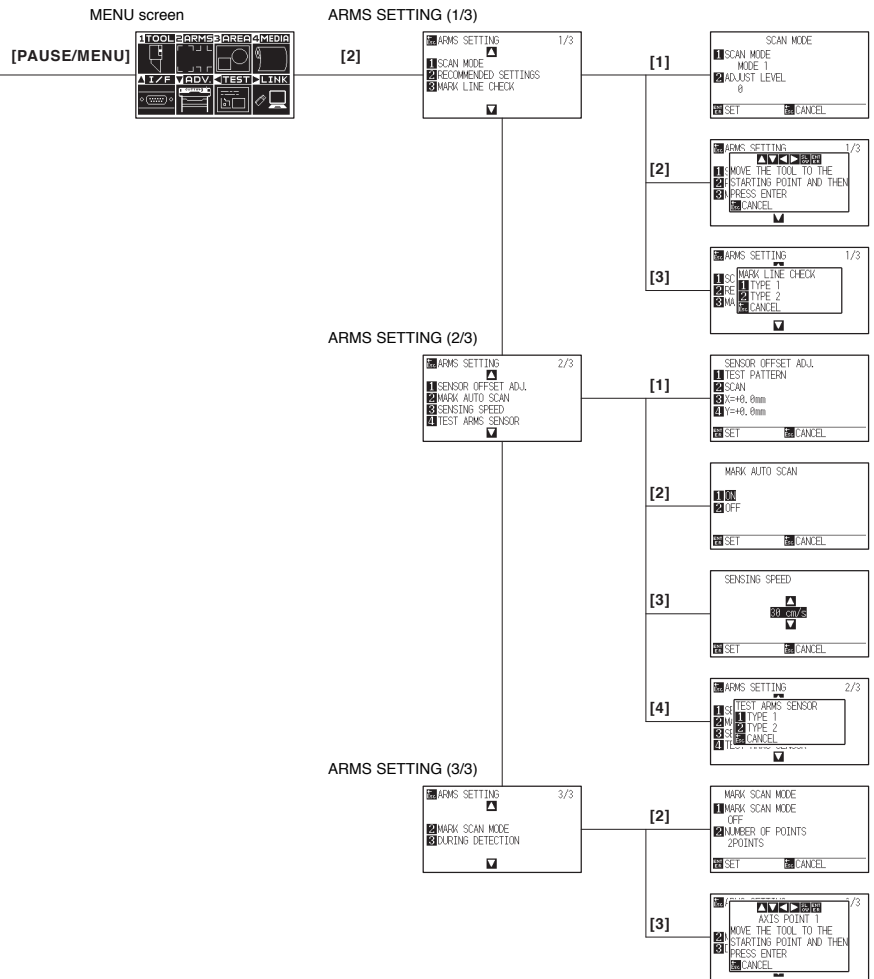

Continued

Default screen
(Continued)

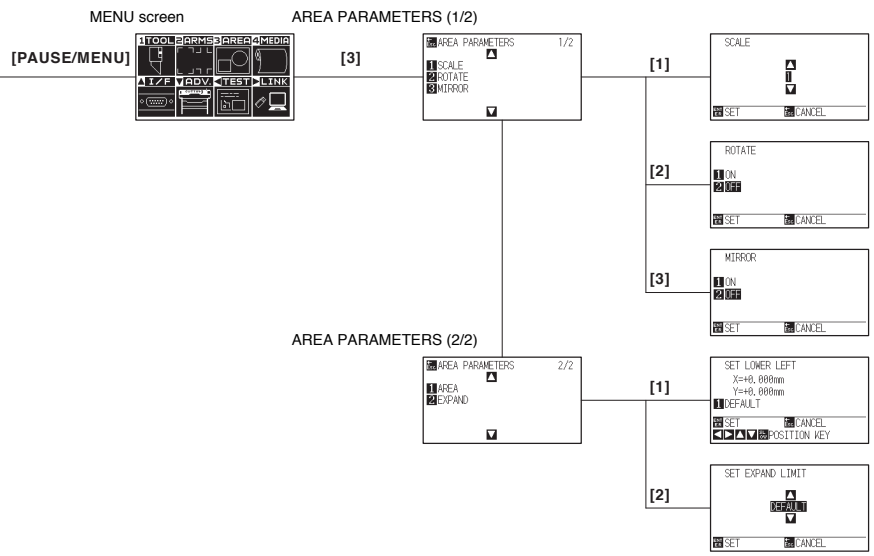

Continued

Default screen
(Continued)

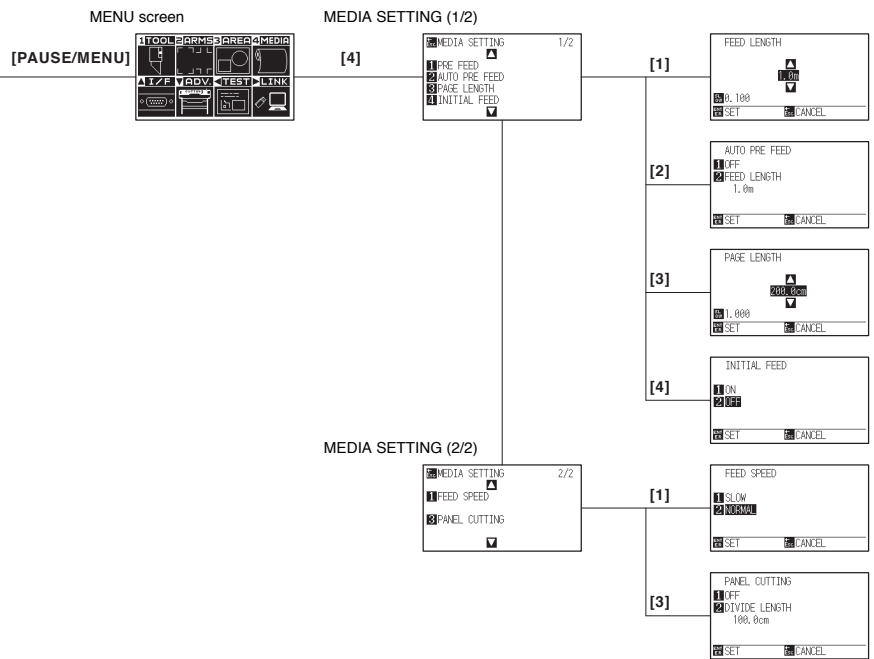

Continued

Default screen
(Continued)

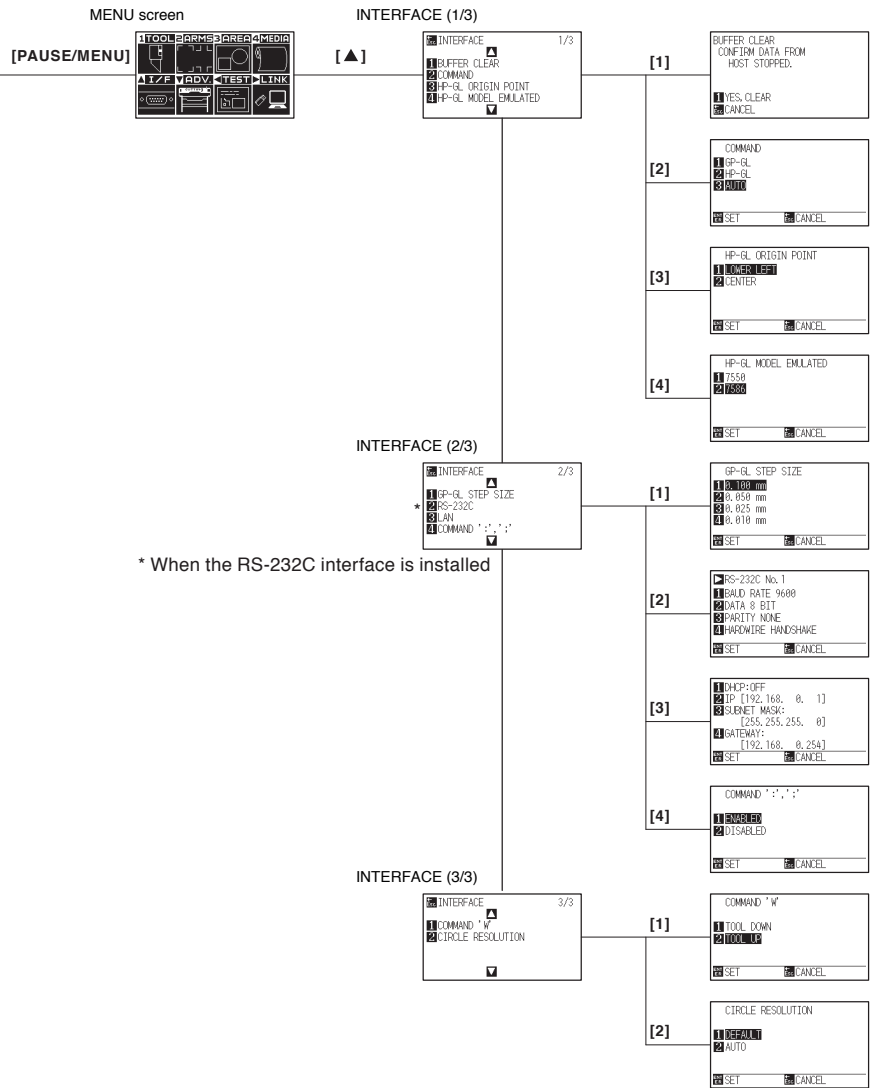

Continued

Default screen
(Continued)

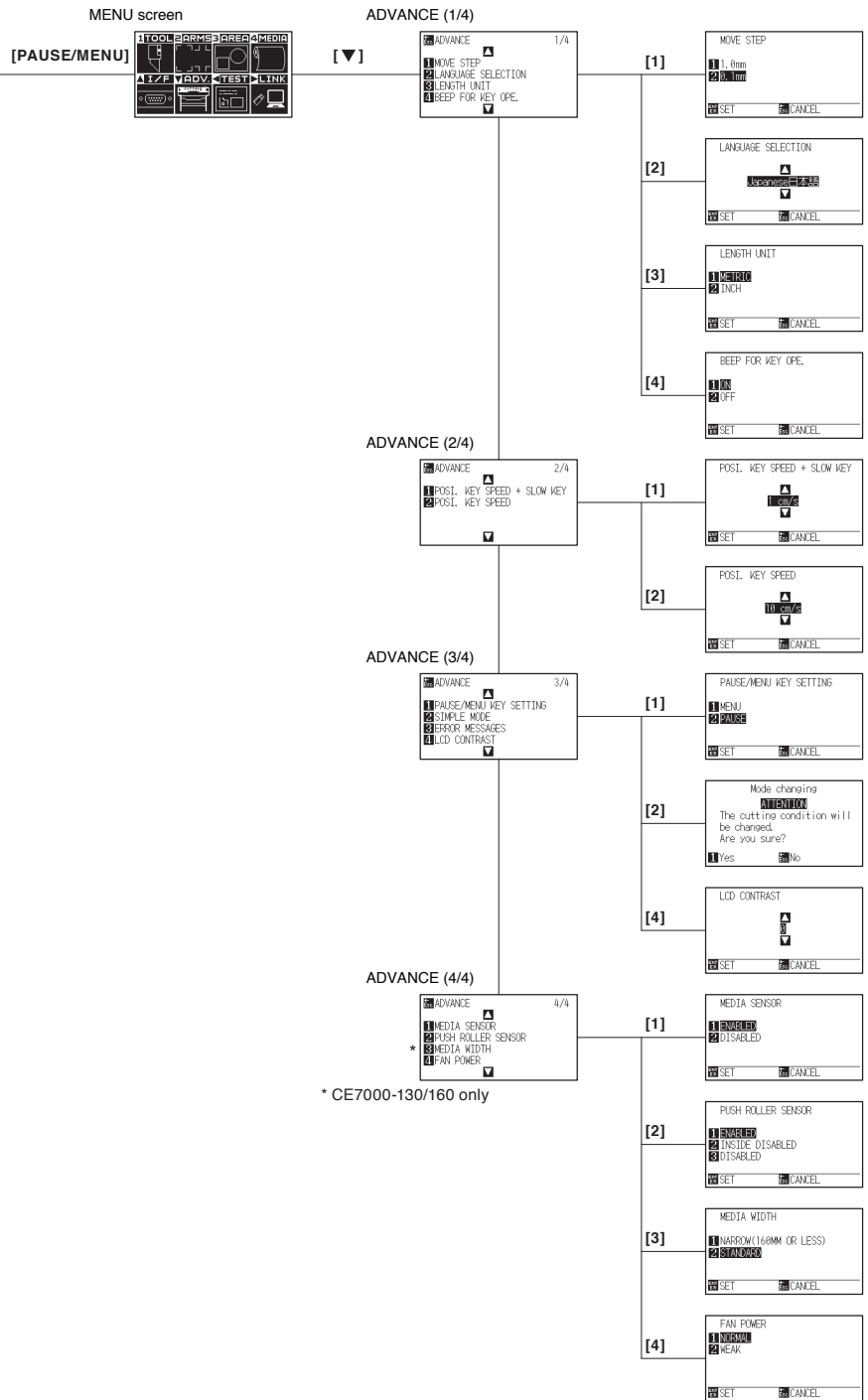

Continued

Default screen
(Continued)

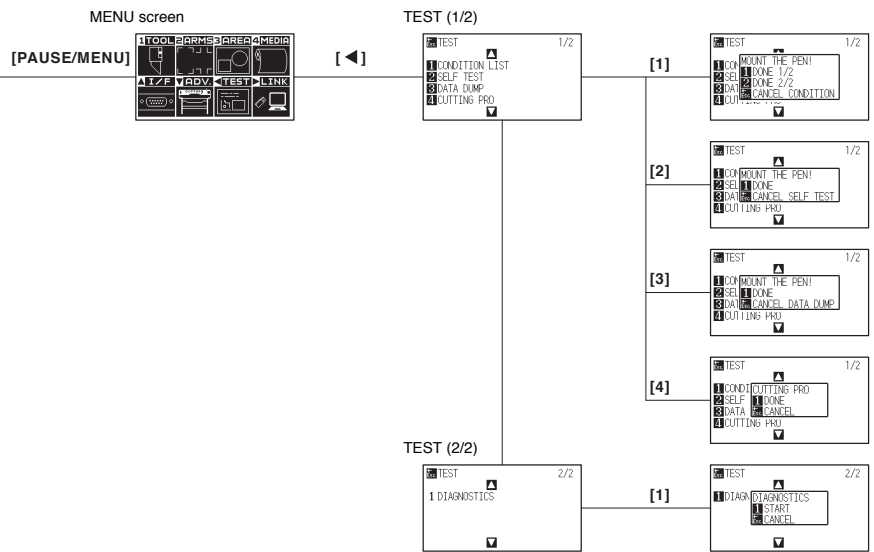

Continued

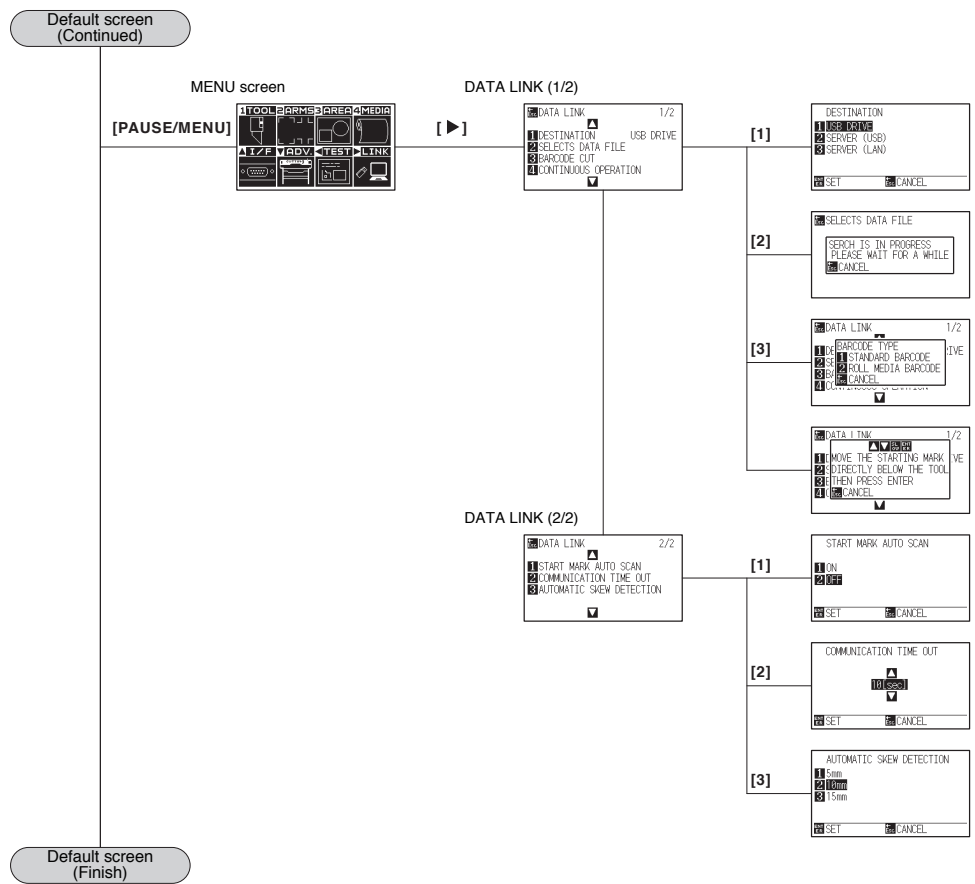

A.5 Initial Setting

Simple mode

Menu items		Setting item	Initial value
MEDIA SETTING (MEDIA)	PAGE LENGTH	200.0cm (CE7000-40) 500.0cm (CE7000-60/130/160)	
	HP-GL ORIGIN POINT	LOWER LEFT	
INTERFACE (I/F)	GP-GL STEP SIZE	0.100mm	
	LANGUAGE SELECTION	Select when initially turning on power	
ADVANCE (ADV.)	LENGTH UNIT	Select when initially turning on power	
	Media name	Speed (cm/s)	Force (Standard Value)
TOOL SETTING (Condition)	For outdoor use	20	(12) +0
	For decorative use	20	(15) +0
	Transparent film	20	(17) +0
	Reflective film	20	(17) +0
	Fluorescent film	15	(22) +0

* Setting items and initial values may be changed.

Normal mode

Menu items	Setting item	Initial value
TOOLS SETTING (TOOL)	TOOL OFFSET ADJ.	–
	STEP PASS	1
	OFFSET FORCE	7
	OFFSET ANGLE	30
	DATA SORTING	OFF
	CONDITION PRIORITY	PROGRAM
	TOOL UP MOVE	DISABLED
	MOVING SPEED	AUTO
	TOOL UP HEIGHT	NORMAL POSITION
	BLADE WEAR ALARM SETUP	OFF
	INITIAL B. ANGLE POSITION	2mm BELOW
ARMS SETTING (ARMS)	SCAN MODE	MODE1
	RECOMMENDED SETTINGS	–
	MARK LINE CHECK	–
	SENSOR OFFSET ADJ.(X)	0
	SENSOR OFFSET ADJ.(Y)	0
	MARK AUTO SCAN	ON
	SENSING SPEED	30cm/s
	TEST ARMS SENSOR	–
MARK SCAN MODE	OFF	
AREA PARAMETERS (AREA)	SCALE	1
	ROTATE	OFF
	MIRROR	OFF
	AREA SET LOWER LEFT	(DEFAULT)
	AREA SET UPPER RIGHT	(DEFAULT)
	EXPAND	(DEFAULT)
MEDIA SETTING (MEDIA)	PRE FEED FEED LENGTH	1m
	AUTO PRE FEED	OFF
	AUTO PRE FEED FEED LENGTH	1m
	PAGE LENGTH	200.0cm (CE7000-40) 500.0cm (CE7000-60/130/160)
	INITIAL FEED	OFF
	FEED SPEED	NORMAL POSITION
	PANEL CUTTING	OFF
	DIVIDE LENGTH	100.0cm
	TAKE-UP	OFF
	INTERFACE (I/F)	HP-GL ORIGIN POINT
HP-GL MODEL EMULATED		7586
GP-GL STEP SIZE		0.100mm
RS-232C (SWITCHING SETTING NUMBERS)		No.1
RS232C: FORWARDING CONDITION BAUD RATE/DATA BIT/ PARITY/HARDWARE HANDSHAKE		RS-232C No.1 : 9600/8/NONE//HARD RS-232C No.2 : 9600/7/EVEN//HARD RS-232C No.3 : 9600/8/EVEN/XonXoff RS-232C No.4 : 9600/8/EVEN/XonXoff
LAN DHCP		OFF
LAN IP		192.168.0.1
LAN SUBNET MASK		255.255.255.0
LAN GATEWAY		192.168.0.254
COMMAND ';;'		ENABLED
COMMAND 'W'		TOOL UP
CIRCLE RESOLUTION		DEFAULT
ADVANCE (ADV.)		MOVE STEP
	LANGUAGE SELECTION	Select when initially turning on power
	LENGTH UNIT	Select when initially turning on power
	BEEP FOR KEY OPE.	ON
	POSI. KEY SPEED + SLOW KEY	1cm/s
	POSI. KEY SPEED	10cm/s
	PAUSE/MENU KEY SETTING	PAUSE
	LCD CONTRAST	0
	MEDIA SENSOR	ENABLED
	PUSH ROLLER SENSOR	ENABLED
	FAN POWER	NORMAL POSITION
TEST (TEST)	NO SETTINGS	–

Menu items		Setting item	Initial value
DATA LINK (LINK)		DESTINATION	USB DRIVE
		START MARK AUTO SCAN	OFF
		COMMUNICATION TIME OUT	10sec
		AUTOMATIC SKEW DETECTION	10mm
TOOL SETTING (Condition)	CONDITION 1	Condition No.	Condition No. 1
		TOOL	CB09U
		SPEED	30
		FORCE	14
		ACCELERATION	2
		ASSIGN TOOL	1
		TANGENTIAL MODE	OFF
		OVERCUT (START)	0
		OVERCUT (END)	0
		DISTANCE ADJUST	OFF
		INITIAL DOWN FORCE	0
	CUT LINE PATTERN	OFF	
	CONDITION 2	Condition No.	Condition No. 2
		TOOL	PEN
		SPEED/FORCE/ACCELERATION	30/12/2
		Same as Condition No. 1 from CUT LINE PATTERN to INITIAL DOWN FORCE	Same as Condition No. 1
	CONDITION 3	Condition No.	Condition No. 3
		TOOL	CB09U
		SPEED/FORCE/ACCELERATION	30/12/2
		Same as Condition No. 1 from CUT LINE PATTERN to INITIAL DOWN FORCE	Same as Condition No. 1
	CONDITION 4	Condition No.	Condition No. 4
		TOOL	CB09U
		SPEED/FORCE/ACCELERATION	20/17/1
		Same as Condition No. 1 from CUT LINE PATTERN to INITIAL DOWN FORCE	Same as Condition No. 1
	CONDITION 5	Condition No.	Condition No. 5
		TOOL	CB09U
		SPEED/FORCE/ACCELERATION	60/17/3 (CE7000-40) 64/17/3 (CE7000-60) 71/17/2 (CE7000-130/160)
		Same as Condition No. 1 from CUT LINE PATTERN to INITIAL DOWN FORCE	Same as Condition No. 1
	CONDITION 6	Condition No.	Condition No. 6
		TOOL	CB09U
		SPEED/FORCE/ACCELERATION	10/22/2
		Same as Condition No. 1 from CUT LINE PATTERN to INITIAL DOWN FORCE	Same as Condition No. 1
	CONDITION 7	Condition No.	Condition No. 7
		TOOL	CB09U-K60
		SPEED/FORCE/ACCELERATION	30/17/2
		Same as Condition No. 1 from CUT LINE PATTERN to INITIAL DOWN FORCE	Same as Condition No. 1
	CONDITION 8	Condition No.	Condition No. 8
		TOOL	CB15U
		SPEED/FORCE/ACCELERATION	5/30/1
		Same as Condition No. 1 from CUT LINE PATTERN to INITIAL DOWN FORCE	Same as Condition No. 1

* Setting items and initial values may be changed.

INDEX

Sign

1, 2, 3, 4. 2-32

A

About the Default Screen 2-29
Accessories 1-2
Accessory case. 1-5, 1-7, 1-9
AC line inlet 1-5, 1-7, 1-9
Adjusting for the registration mark scan position 5-16
Adjusting the blade length. 2-4
Adjustment for cutting out 2-59
Adjustment for Half Cutting 2-59
Adjustment of Offset 2-59
Adjustment on the media 5-20
Adjustment registration mark 5-16
Adjustment when using plotting pen. 2-59
Adjust the blade length 2-60
Adjust the blade length manually 2-55
Adjust with 2POINTS 6-2
Adjust with 3POINTS 6-3
Adjust with 4POINTS 6-3
ADV. 2-34, 2-35
Aligning the push roller 2-25
Angle control 7-10
AREA. 2-35
ARMS 2-35, 5-2
ARMS Error Messages 15-9
Attaching a tool 2-5
Automatic detection of registration mark position. 5-7
Automatic Pre Feed. 8-4, 8-6
AXIS ALIGNMENT 6-2, 6-5

B

BARCODE. 2-31
Beep setting 10-8
Blade application and features 2-4

C

Carrier Sheet 2-21
Change the cutting condition 3-6
Changing the hold-down force 2-27
Check the lines of registration mark 5-12
CIRCLE RESOLUTION. 11-8
Communication Timeout. 12-10
COND/TEST 2-31, 2-36
Confirm the Cutting Data 15-22
Confirm the results of the cutting test. 2-59

Connecting to the Power. 2-30
Continuously move manually 3-3
Control panel. 1-4, 1-6, 1-8
Control Panel. 2-31
Copy 4-10
COPY 2-31
Cutter blade. 14-3
Cutter blade adjustment magnifier 1-2
Cutter blades. 1-2
Cutter plunger 1-2
Cutter Plunger Exchange 14-6
Cutter plunger nomenclature 2-2
Cutting area. 5-6
Cutting groove. 1-4, 1-6, 1-8
Cutting mat 1-4, 1-6, 1-8
CUTTING PRO 15-20
Cutting test 2-56

D

Daily maintenance. 14-2
DATA DUMP 15-23
Default screen 2-33
DIAGNOSTICS 15-25
Display language setting. 10-2
Display Language Setting. 2-69
Display Length Unit Setting. 2-70
DISTANCE ADJUST 7-12

E

Enabling/Disabling the ': ' and ' ; ' commands 11-5
ENTER 2-31
Error Messages in GP-GL Command Mode. 15-6
Error Messages in HP-GL Command Mode. 15-7
ESC 2-31
EXPAND 4-4

F

Fan suction setting 10-7
Feed Speed for Pre Feed 8-7

G

Gateway 9-7
GP-GL command 11-4
GP-GL Step Size. 2-68
GP-GL STEP SIZE 11-4
Grit roller position guide 1-4, 1-6, 2-25, 1-8
Grit rollers 1-4, 1-6, 1-8

H	
HP-GL command	11-7
HP-GL MODEL EMULATED	11-7
I	
I/F	2-34, 2-35
I/F (LAN)	9-5
Initial Setting	A-17
Installation space	VII
Interface	9-2
IP address	9-7
L	
Language	2-69
LANGUAGE SELECTION	10-2
LCD contrast setting	10-11
Length unit	2-70
LENGTH UNIT	10-3
LINK	2-35
Loading Media	2-7
M	
Main Specifications	A-2
Manual position adjust	6-2, 6-4
MARK SCAN Mode	5-8
Media	2-7, 5-6
MEDIA	2-34, 2-35
Media sensors	1-4, 1-6, 1-8
Media set lever	1-4, 1-6, 1-8
Media stocker	1-7, 1-9
Media stopper	1-7, 1-8
Media that registration mark cannot be detected	5-7
MENU Screen	2-34
Menu Tree	A-7
Model ID response	11-7
Mounting the Roll-medium tray	1-10
Mounting the stock shafts	1-11
Move away the tool carriage	3-5
Move in steps manually	3-3
Move the Tool Carriage and Media	3-3
MOVING SPEED	8-9
N	
Network (LAN) Interface connector	1-4, 1-7, 1-9
Network (LAN) interface	9-3
Nomenclature	1-4
Normal mode	2-35
Normal mode setting	10-10
O	
Operation key	2-31
Options	A-3
ORIGIN	2-31
Origin Point Settings When configuring HP-GL	2-67
P	
Page Length	2-65
Panel Cutting	4-15
Pause key select setting	10-9
PAUSE/MENU	2-31
POSITION	2-32
Positioning	5-6
Power cable	1-2
Power switch	1-5, 1-7, 1-8
Pre Feed of Media	2-39
Printing the Setting of the Plotter	15-16
Priority of tool condition selection	11-3
Push roller hold-down force switching lever	1-9
Push rollers	1-4, 1-6, 1-8
Push roller sensors	10-5
R	
Raise or Lower the Tool	3-2
Reading the error message	15-26
Reading the screen	2-32
Recommended setting of registration mark	5-10
Registration mark	5-4, 5-6
Registration Mark	5-3
Registration mark automatic detection	5-23
Removing the tool	2-6
Replacing Cutter Blade	14-3
Reset	3-6
Roll media	2-7, 2-10
Roll-medium tray	1-3, 1-5
Roll-medium tray guide rail	1-5
ROTATE	3-10
RS-232C	9-10
RS-232C interface	9-3
RS-232C interface connector	1-4, 1-6, 1-9
S	
Selecting Tool Condition	2-40
Self Diagnostic Test	15-24
SELF TEST	15-18
Set the enlarge/shrink scale	4-8
Setting Adjustment Between the Tools	7-22
Setting and Adjustment of ARMS	5-8
Setting Cut Line Pattern	7-15
Setting cutting area	4-2
Setting cutting width	4-4
Setting Feeding Method	2-37

Setting Initial Blade Control Position Adjust	7-19
Setting length of the page	4-5
Setting mirror	4-7
Setting of the Initial Down Force	7-6
Setting origin point when HP-GL is set	3-9
Settings for Cutting	4-2
Setting speed of the registration mark scan	5-25
Setting step movement distance	3-4
Setting the acceleration	2-51
Setting the command	11-2
Setting the Cutting Direction	3-10
Setting the DHCP	9-5
Setting the force	2-50
Setting the length of overcut	7-4
Setting the OFFSET FORCE	7-21
Setting the Origin Point	3-7
Setting the speed	2-48
Setting the step size	11-4
Setting the tangential mode	7-3
Setting the tool	2-46
Setting the tool condition	2-42
Setting tool No.	2-53
SETUP MANUAL	1-2
Sheet media	2-16, 2-18
Simple mode	2-34, 2-63
Simple mode setting	10-10
Skew Scanning	12-12
SLOW	2-32
Sorting	8-2
Speed and Force	2-44
Stand	1-7, 1-9
Start Mark Auto Scan	12-8
STEP PASS	7-8
Step Size	2-68
Stock shaft	1-7, 1-9
Stop Cutting	3-12
Stopper	1-7, 1-9
Subnet mask	9-7
Supplies	A-3

T

Tangential mode	7-2
TEST	2-35
Test pattern	15-20
Test Pattern	15-18
Test the registration mark sensor	5-14
TO ENSURE SAFE AND CORRECT USE Cutter	1-2
TOOL	2-35
Tool carriage	1-4, 1-6, 1-8
Tool holder	1-4, 1-6, 1-8
TOOL UP HEIGHT	8-13
Tool up movement	8-11

U

UP mode	7-15
USB cable	1-2
USB interface	9-2
USB interface connector	1-4, 1-6, 1-9
USB memory dedicated connector	1-4, 1-7, 1-9

W

Water-based fiber pen	1-2
Water-based fiber pen adapter	1-2
When media change mode is OFF	4-10
When media change mode is ON	4-13

Specifications are subject to change without notice.

CE7000 Series User's Manual
CE7000-UM-152
October 14, 2022 1st edition-01

GRAPHTEC CORPORATION

GRAPHTEC