



Model 3 Event Data Recorder Data Retrieval Guide For Vehicles Built Through 10/05/2020

Introduction

The Tesla Model 3 is equipped with an Event Data Recorder (EDR). The EDR records data related to vehicle dynamics and safety systems when the system senses a crash or a crash-like situation, such as hitting a road obstacle. This data is stored in the vehicle’s Restraints Control Module (RCM).

This guide describes how to retrieve EDR data from the RCM of a Tesla Model 3 built through October 5, 2020. For Model 3 vehicles built after October 5, 2020 refer to “Model 3 EDR Data Retrieval Guide – Vehicles Built Through 10/05/2020” (Tesla part number CD-20-20-003).

Contents

- Introduction..... 1
- Tools Required 2
- Connect to the CAN Bus 2
 - Power Up the Vehicle 10
 - Supply External Power to the RCM 12
 - Prepare to Retrieve Data 16
- Establish a Direct-to-RCM Connection 17
- Retrieve Data 28
- For Further Assistance 31

This guide and other Tesla EDR information can be found at <https://edr.tesla.com>.

There are two methods for connecting to the RCM:

1. A CAN Bus connection, which allows you to connect to the RCM through the Model 3 CAN bus, without removing the center console or removing the RCM from the vehicle. This type of connection may not be possible if the vehicle has extensive damage. If a CAN Bus connection can be established, data is retrieved with less vehicle disassembly than when using a direct-to-module connection. For more information about in-vehicle retrieval, refer to “Connect to the CAN Bus,” on page 2.
2. Direct-to-RCM connection, which requires that you physically remove the Model 3 center console to access the RCM, then connect cables directly to the RCM and retrieve data. For more information about direct-to-module retrieval, refer to “Establish a Direct-to-RCM Connection,” on page 17.

Tools Required

To retrieve the data from the RCM, you will need the following special tools:

- PCAN-USB Adapter
- A Windows computer running the Tesla EDR Retrieval Program, which you can download at <https://edr.tesla.com/download>
- An appropriate data retrieval cable:



Retrieval Method	Required Cable	
In-vehicle connection	Tesla In-Vehicle EDR Retrieval Cable: Tesla part number 1139996.	
Direct-to-module connection	Tesla Model 3 Direct-To-Module EDR Retrieval Cable: Tesla part number 1094601.	

Table 1. Retrieval cable requirements

Required cables and software are available at <https://edr.tesla.com>.

Connect to the CAN Bus

To connect to the RCM through the CAN bus:

1. Fully lower all door windows to avoid glass shatter and door lockout conditions.
2. Move the passenger seat fully rearward.

3. Disconnect 12V power.

a. Open the hood:

- If the vehicle owner is present, use the mobile app to open the front trunk by touching the **Front Trunk** button.



Figure 1. Opening the hood using the mobile app

- If the vehicle owner is not present, use the touchscreen to open the hood by touching **OPEN**.

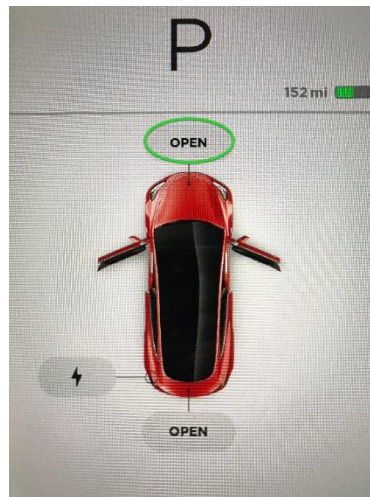

Figure 2. Opening the hood using the touchscreen

- If the Model 3 has no 12V power, the hood cannot be opened using the touchscreen or the mobile app. Use the following procedure to open the hood when the vehicle has no 12V power:

NOTE: This procedure requires an external source of 12V power, such as a jump starter. Do not connect an automobile 12V battery to the Model 3.

⚠ WARNING: Follow all manufacturer's instructions for safe use of the external 12V power source.

- a. Release the tow eye cover on the front fascia by pressing firmly on the top right perimeter of the cover until it pivots inward.

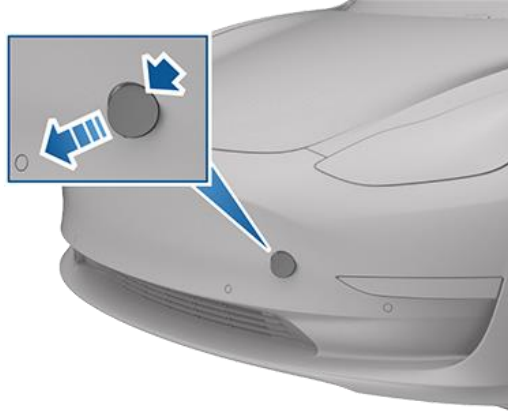

Figure 3. Remove the tow eye cover

NOTE: The tow eye cover is connected to a cable that connects to the vehicle's 12V battery positive (+) terminal.

- b. Gently pull the raised section outward to expose the terminals at the end of the Model 3 positive and negative cables.

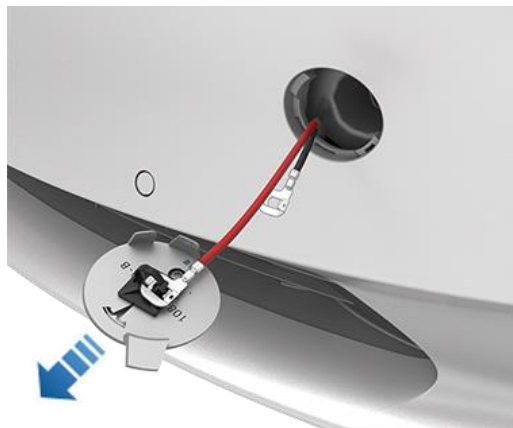

Figure 4. Extracting the cables

NOTE: The positive cable (red) is approximately 6 inches longer than the negative cable (black). The negative cable appears only after the positive cable has been partially pulled out of the tow eye opening.

- c. Connect the 12V power supply positive (+) cable to the Model 3 positive (+) terminal (on the red cable), and connect the 12V power supply's negative (-) cable to the Model 3 negative (-) terminal (on the black cable).

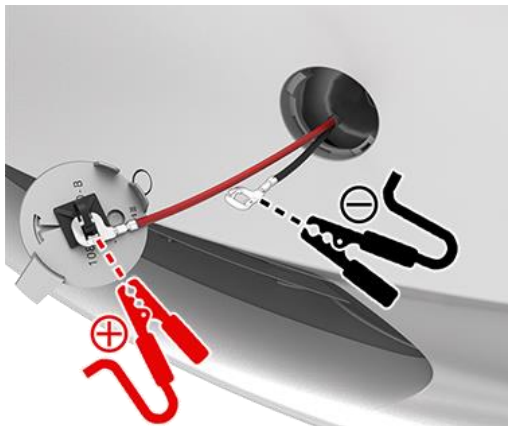

Figure 5. Connecting external 12V power to the Model 3 positive and negative terminals

- d. Turn on the external power supply (refer to the manufacturer's instructions). The hood latches should release immediately.
NOTE: Applying external 12V power to these terminals only releases the hood latches. You cannot charge the 12V battery using these terminals.
- e. Open the hood to access the front trunk area.
- f. Disconnect both cables, beginning with the black negative (-) cable.
- g. Starting from the RH side, lift the underhood apron. Release the clips (x12) that attach the rear underhood apron to the vehicle, and then remove the apron from the vehicle.



Figure 6. Rear underhood apron

- h. On the touchscreen, touch **Controls > Safety & Security > Vehicle Power > Power Off.**

- i. Loosen the nut that attaches the 12V battery negative cable to the battery, and then disconnect the cable from the battery.

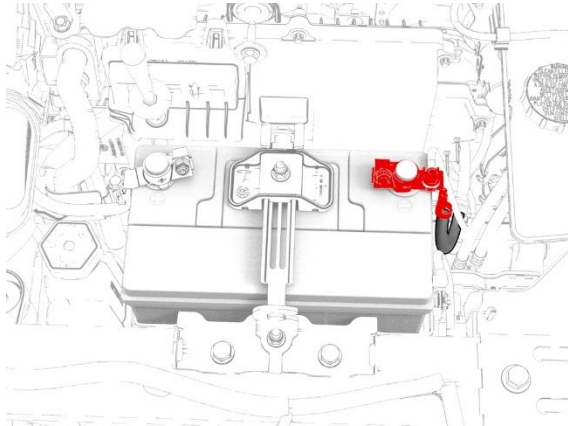

Figure 7. 12V battery negative cable

4. Access the CAN bus connector.

NOTE: The location of the CAN bus connector is under the RH B-Pillar trim.

- a. Remove the RH instrument panel end cap.
- b. Release the upper clip that attaches the RH middle A-Pillar trim, and then pull out the trim to remove it from the vehicle.



Figure 8. Removing the RH middle A-Pillar trim

- c. Release the topmost clip on the RH lower A-pillar trim.



Figure 9. Releasing the A-Pillar Lower trim

- d. Pull the rearmost part of the RH lower A-pillar trim upward to release the clips and tabs, and then pull the entire trim rearward to remove the trim from the vehicle.

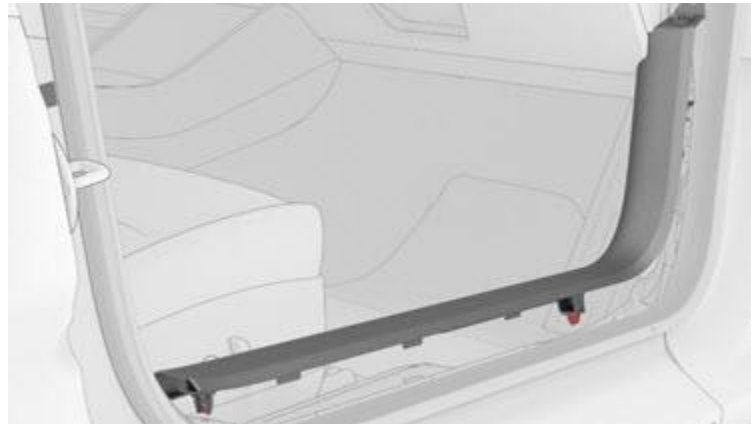

Figure 10. Removing the A-Pillar Lower trim

- e. Move the seatbelt shoulder adjustment to the fully down position.
- f. While wearing suitable gloves, spread the bottom of the RH upper B-pillar trim open, and then release the clips that attach the bottom of the trim to the RH lower B-pillar trim.

CAUTION: Do not pull the RH upper B-pillar trim too far, otherwise it might break the seatbelt shoulder adjustment mechanism.

NOTE: Move the body seals to aid removal.

- g. Separate the upper B-pillar trim from the body, starting from the seal at the top part of the upper B-pillar trim.

NOTE: Remove any remaining RH upper B-pillar trim clips from the RH B-pillar, and if the RH upper B-pillar trim is to be installed later, remove all clips from the trim.

- h. Release the clips that attach the RH lower B-pillar trim to the body, and remove the trim from the vehicle.



Figure 11. Removing the B-Pillar Lower trim

NOTE: Remove any remaining RH lower B-pillar trim clips from the RH B-pillar, and if the RH lower B-pillar trim is to be installed later, remove all clips from the trim.



Figure 12. B-Pillar Lower trim clips

- i. At the base of the RH B-pillar, move the carpet aside and locate the CAN bus connector.

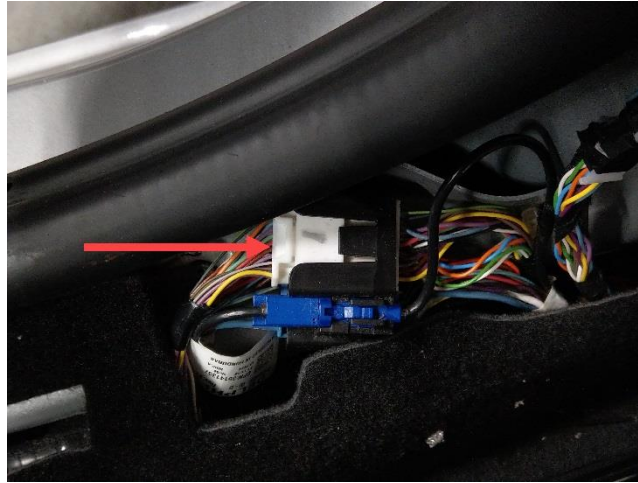

Figure 13. The Model 3 CAN bus connector

5. Press down on the retention clip of the CAN bus connector to release it from the wiring harness connector.

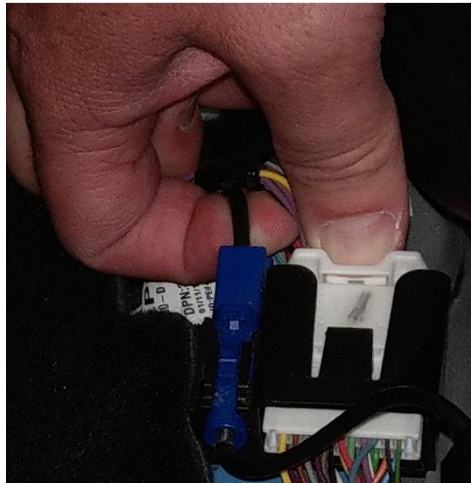

Figure 14. Releasing the Model 3 CAN bus connector

- Carefully pull the CAN bus connector out of the wire harness connector.

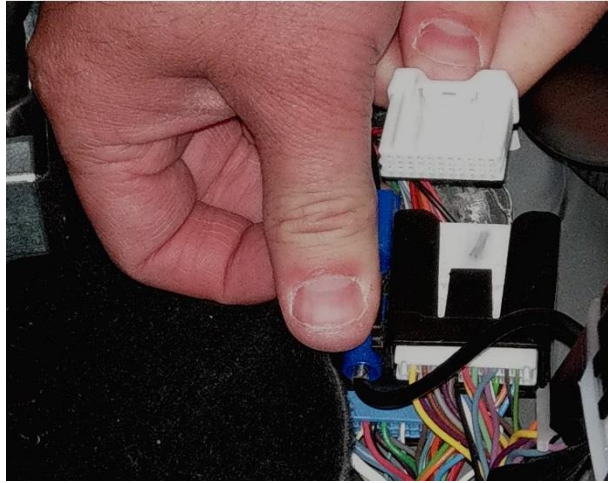

Figure 15. Removing the Model 3 CAN bus connector

- Insert the connector from In-Vehicle EDR Retrieval Cable into the CAN bus connector on the wire harness.
- Supply power to the RCM, as described in “Power Up the Vehicle.”

Power Up the Vehicle

To power up the Model 3:

- Connect the 12V battery negative cable to the battery and then tighten the nut that attaches the cable to the battery (torque the nut to 6 Nm).

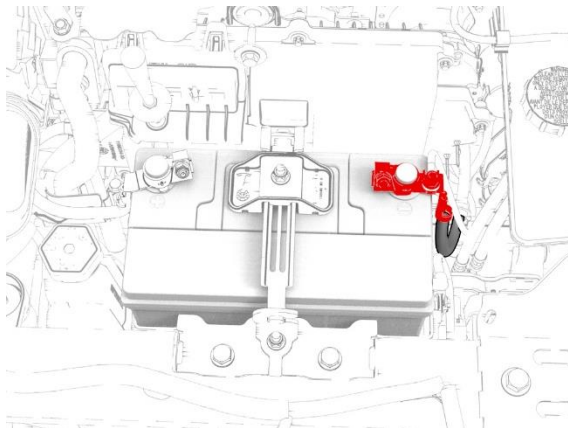

Figure 16. 12V battery negative cable

2. Sit in the driver's seat.
3. Scan the keycard by placing it on the card reader located to the rear of the cup holders in the center console.



Figure 17. Scanning the key card

4. Press and hold down the brake pedal until the center screen shows the P R N D icons (1). The airbag warning indicator (2) should flash on (and perhaps stay on) to indicate that the RCM is powered up.

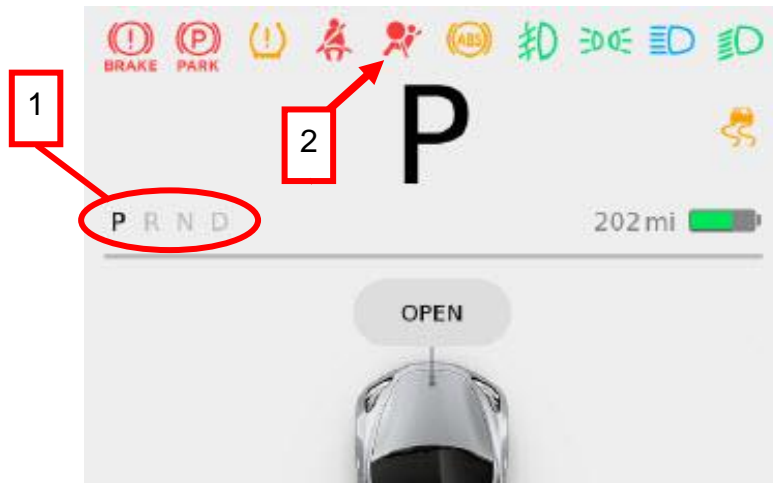

Figure 18. Scanning the key card

NOTE: If you do not press the brake pedal within two minutes of scanning the key card, the vehicle will not start. Rescan the key card and press the brake pedal within two minutes to start the vehicle.

If the vehicle powers up, proceed to “Prepare to Retrieve Data,” on page 16.

If the vehicle does not power up, rescan the key card and press the brake pedal within two minutes to start the vehicle. If, after the second attempt to power up the vehicle, it does not power up, you must supply external 12 volt power to the RCM, as described in “Supply External Power to the RCM.”

Supply External Power to the RCM

To supply external 12V power to the RCM, you must use the First Responder Loop, which is a section of the vehicle wiring harness.

1. Choose which First Responder Loop to use (front or rear):

The front First Responder Loop is located under the front hood, near the windshield washer fluid reservoir.



Figure 19. Front First Responder Loop

The rear First Responder Loop is located under the RH (passenger side) quarter glass trim (inside the body of the vehicle).

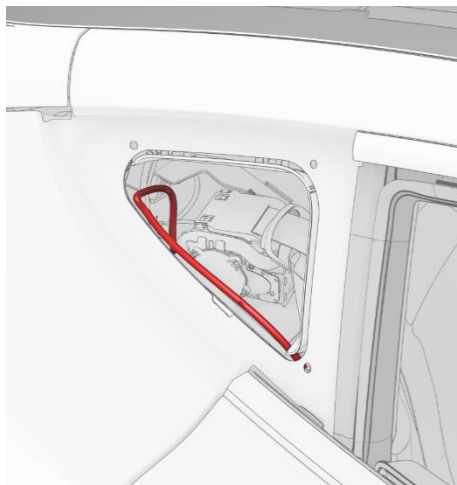

Figure 20. Rear First Responder Loop (exterior view)

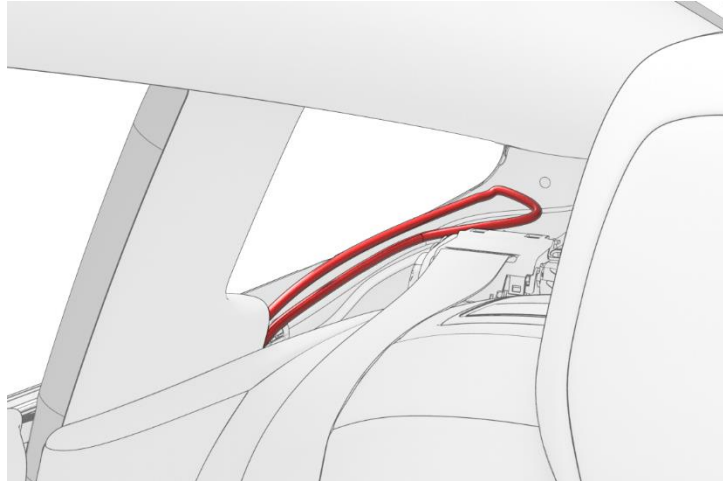

Figure 21. Rear First Responder Loop (interior view)

2. Expose the First Responder Loop you want to use:
 - **Front First Responder Loop:** open the hood.
 - **Rear First Responder Loop** (from outside the vehicle):
 - 1) Carefully remove the quarter glass.
 - 2) Remove a section of the trim under the quarter glass at least 6 inches long to expose the rear First Responder Loop.
 - **Rear First Responder Loop** (from inside the vehicle):
 - 1) Remove the 2nd row lower seat cushion.
 - 2) Remove the RH 2nd row seat side bolster.
 - 3) Remove the RH side rail trim.
 - 4) Remove the RH upper C-pillar trim.
 - 5) Release the clip and tabs that attach the RH rear C-pillar trim to the body, and move the trim aside.
3. Cut the First Responder Loop in the area shown.

NOTE: Cut only one First Responder Loop.

- Front First Responder Loop cut location:

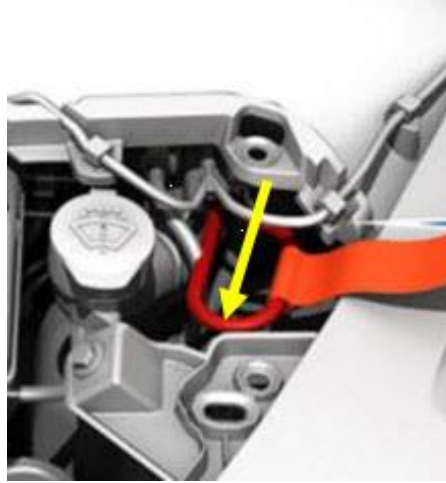

Figure 22. Cut the Front First Responder Loop

- Rear First Responder Loop cut location:

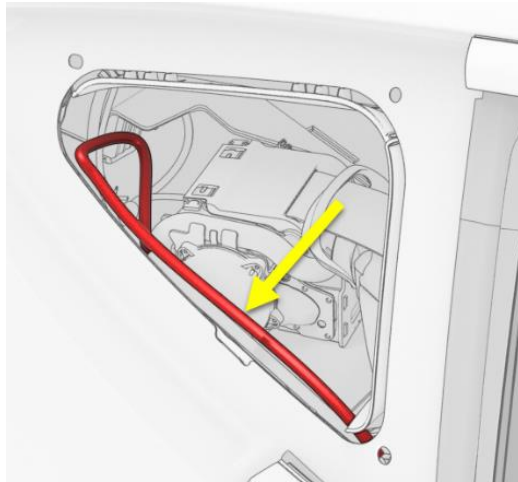

Figure 23. Cut the Rear First Responder Loop

4. Remove enough of the harness sheathing from each side of cut to expose approximately 2 inches of the wires in the harness.
5. Separate the yellow wire from the other three wires.

- Strip ½ inch of wire from the end of the yellow wire indicated by the green arrow:



Figure 24. Front First Responder Loop

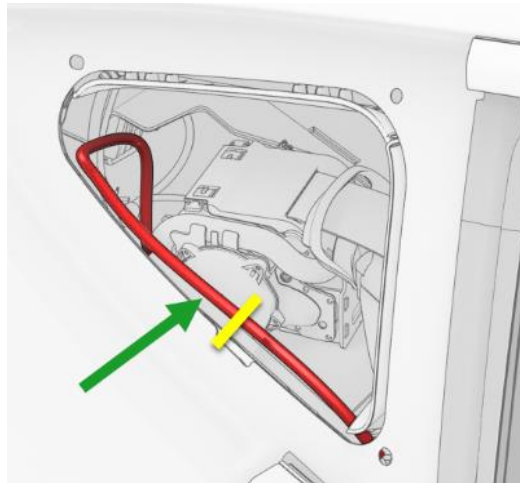

Figure 25. Rear First Responder Loop

- Use an alligator clip to connect the ground/negative output of the external 12V power supply to the vehicle frame.
- Use an alligator clip to connect the positive output of the external 12V power supply to the bare portion of the yellow wire.
- Turn on the external power supply.
- Prepare to connect the computer to the RCM, as described in “Prepare to Retrieve Data.”

Prepare to Retrieve Data

1. Connect the Tesla In-Vehicle EDR Retrieval Cable to the PCAN-USB adapter.



Figure 26. Connecting the EDR retrieval cable to the PCAN

2. Connect the PCAN-USB adapter to the computer used for data retrieval.

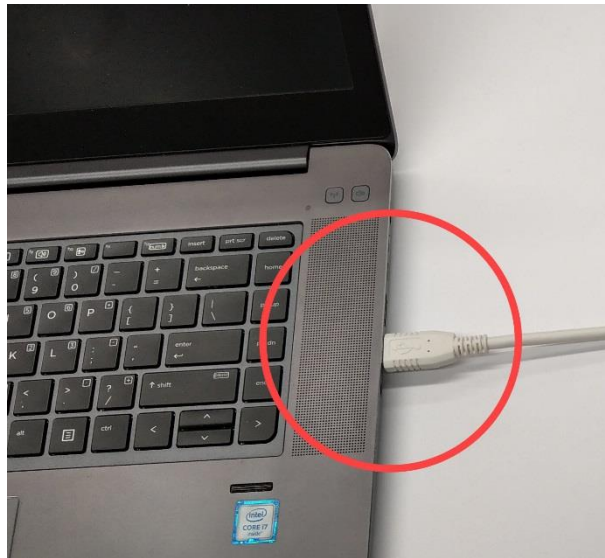

Figure 27. Connecting the PCAN to the computer

3. Proceed to “Retrieve Data” on page 28 to complete the data retrieval procedure.

Establish a Direct-to-RCM Connection

If the CAN Bus connection procedure is unsuccessful, you might be able to connect directly to the RCM and establish a direct-to-module connection. The RCM is located forward of the center console, below the instrument panel and center screen.

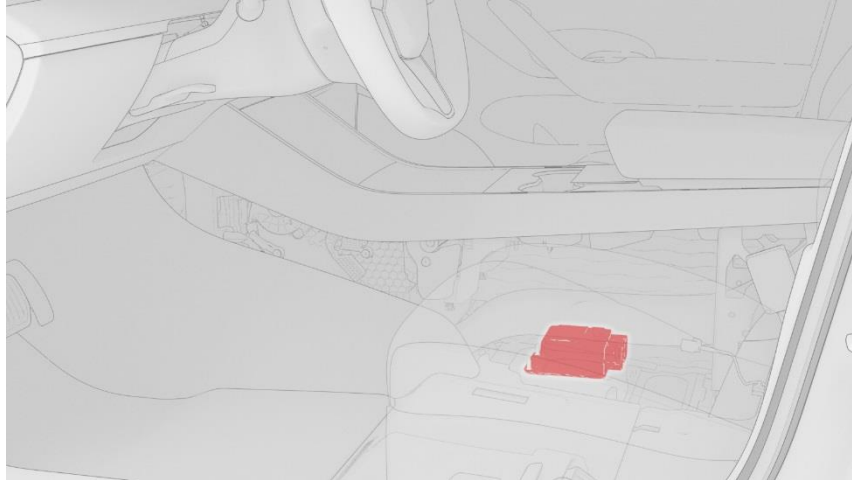

Figure 28. Model 3 RCM location

To directly access the RCM, you must remove the center console. Once the center console has been removed, the RCM can be accessed in-place, or it can be removed from the vehicle.

To connect to the RCM while it is still in the Model 3:

1. Move the front LH front seat fully rearward.
2. Remove the front LH floor mat from the vehicle.
3. Release the clips and tabs that attach the center console LH side panel carpet to the center console, and then remove the side panel from the vehicle.

NOTE: Release the rearmost clips first and work toward the front of the vehicle. Transfer any clips that remain in the center console and the cross car beam to the center console side panel carpet.

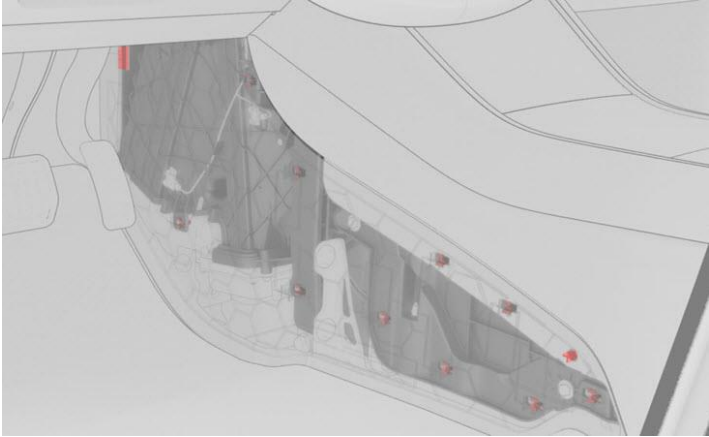

Figure 29. Center console side panel opening

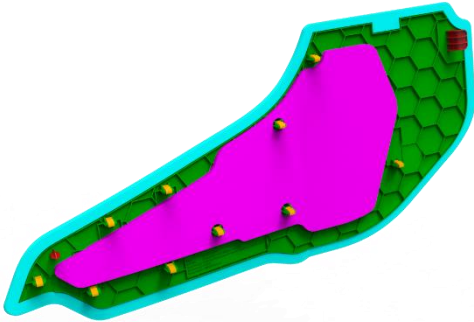

Figure 30. Center console side panel (rear view)

- 4. Release the clips that secure the center console lower rear panel to the center console, and remove the panel from the console.

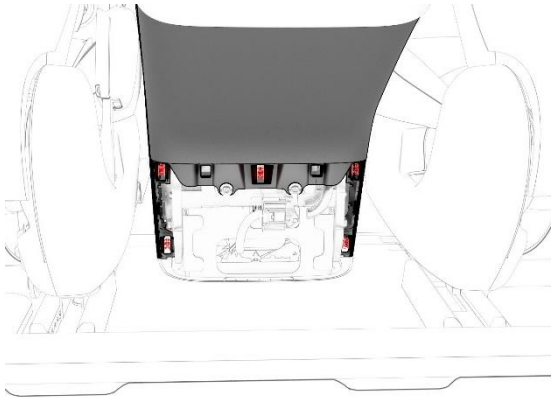

Figure 31. Center console lower rear panel

5. Remove the phone tray.

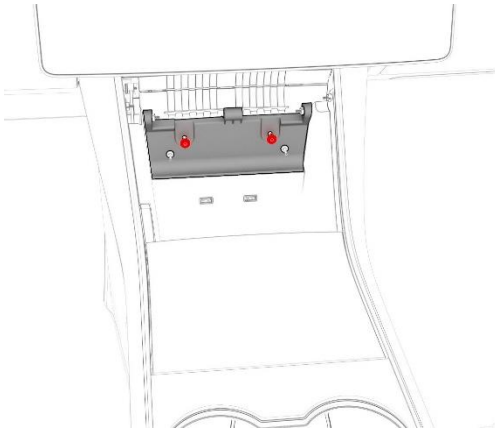

Figure 32. Center console phone tray

- a. Open the front bin doors.
 - b. Pivot the center console phone tray up to access the screws.
 - c. Remove the screws that secure the center console phone tray to the center console.
 - d. Release the clips (x5) that secure the center console phone tray to the center console, and remove the tray from the vehicle.
6. Remove the fasteners that secure the front of the center console to the body.



Figure 33. Center console front fasteners

7. Remove the fasteners that secure the LH front of the center console to the body.

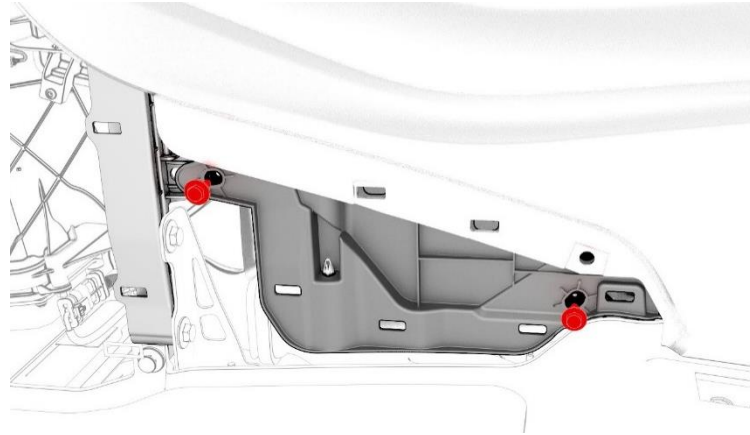

Figure 34. Center console side fasteners (front)

8. Remove the fastener that secures the LH rear of the center console to the body.

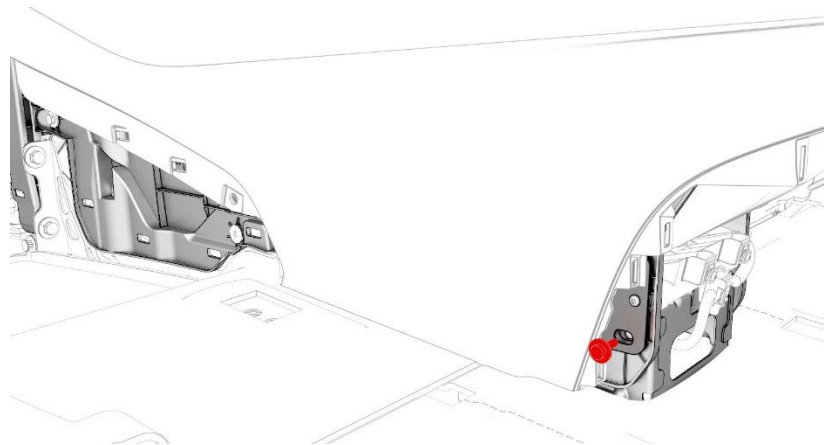

Figure 35. Center console side fasteners (rear)

9. Release the clips and tabs that attach the center console RH side panel carpet to the center console, and then remove the side panel from the vehicle.

NOTE: Release the rearmost clips first and work toward the front of the vehicle. Transfer any clips that remain in the center console and the cross car beam to the center console side panel carpet.

10. Remove the fasteners that secures the RH front of the center console to the body.
11. Remove the fastener that secures the RH rear of the center console to the body.
12. On the touchscreen, select **Control** > **Safety & Security** > **Vehicle Power** > **Power Off** to power off the vehicle.
13. Disconnect 12V power.
 - a. Fully lower all door windows to avoid glass shatter and door lockout conditions.
 - b. Open the hood:

- If the vehicle owner is present, use the mobile app to open the front trunk by touching the **Front Trunk** button.



Figure 36. Opening the hood using the mobile app

- If the vehicle owner is not present, use the touchscreen to open the hood by touching **OPEN**.

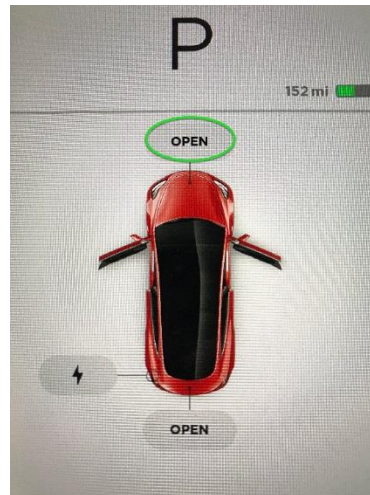

Figure 37. Opening the hood using the touchscreen

- If the Model 3 has no 12V power, the hood cannot be opened using the touchscreen or the mobile app. Use the following procedure to open the hood when the vehicle has no 12V power:

NOTE: This procedure requires an external source of 12V power, such as a jump starter. Do not connect an automobile 12V battery to the Model 3.

⚠ WARNING: Follow all manufacturer's instructions for safe use of the external 12V power source.

- c. Release the tow eye cover on the front fascia by pressing firmly on the top right perimeter of the cover until it pivots inward.

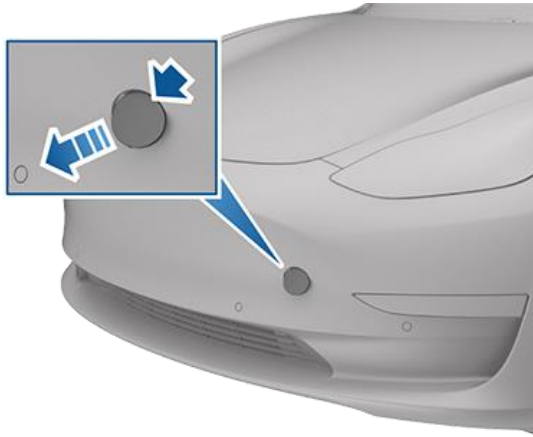

Figure 38. Remove the tow eye cover

NOTE: The tow eye cover is connected to a cable that connects to the vehicle's 12V battery positive (+) terminal.

- d. Gently pull the raised section forward outward to expose the terminals at the end of the Model 3 positive and negative cables.

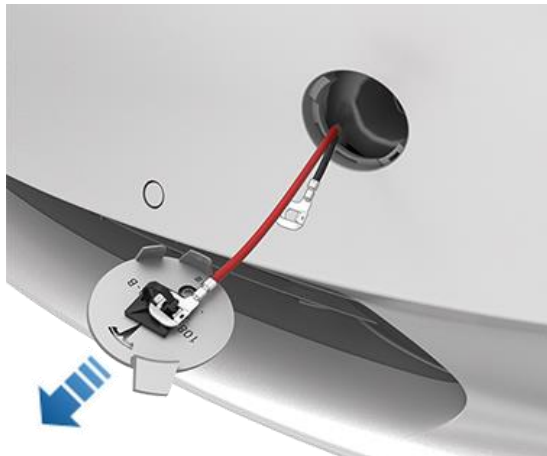

Figure 39. Extracting the cables

NOTE: The positive cable (red) is approximately 6 inches longer than the negative cable (black). The negative cable appears only after the positive cable has been partially pulled out of the tow eye opening.

- e. Connect the 12V power supply's positive (+) cable to the Model 3 positive (+) terminal (on the red cable), and connect the 12V power supply negative (-) cable to the Model 3 negative (-) terminal (on the black cable).

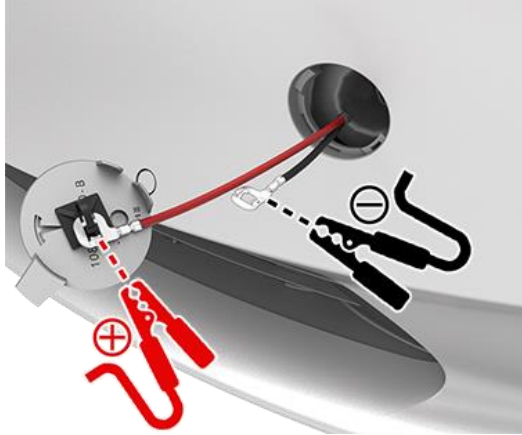

Figure 40. Connecting external 12V power to the Model 3 positive and negative terminals

- f. Turn on the external power supply (refer to the manufacturer's instructions). The hood latches should release immediately.

NOTE: Applying external 12V power to these terminals only releases the hood latches. You cannot charge the 12V battery using these terminals.

- g. Open the hood to access the front trunk area.
- h. Disconnect both cables, beginning with the black negative (-) cable.
- i. Starting from the RH side, lift the underhood apron. Release the clips (x12) that attach the rear underhood apron to the vehicle, and then remove the apron from the vehicle.



Figure 41. Rear underhood apron

- j. On the touchscreen, touch **Controls > Safety & Security > Vehicle Power > Power Off**.
- k. Loosen the nut that attaches the 12V battery negative cable to the battery, and then disconnect the cable from the battery.

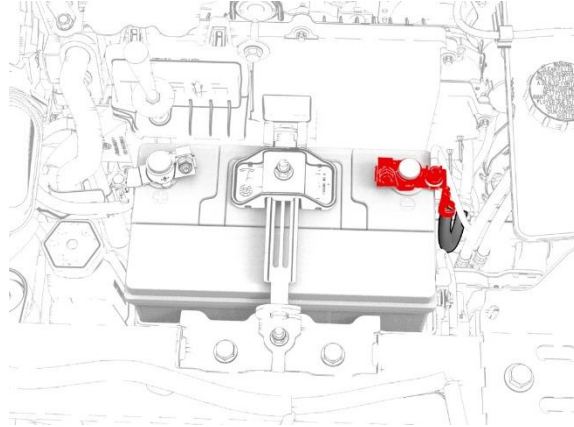

Figure 42. 12V battery negative cable

14. Disconnect the electrical connector located at the RH front of the center console.

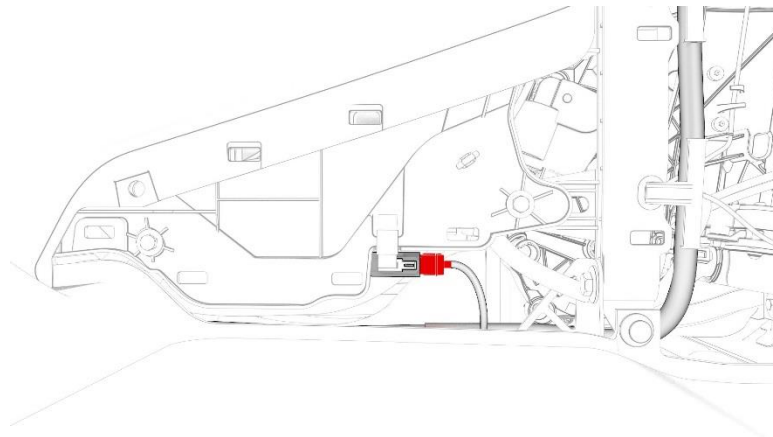

Figure 43. Center console front electrical connector

15. Disconnect the electrical connector from the rear of the center console.

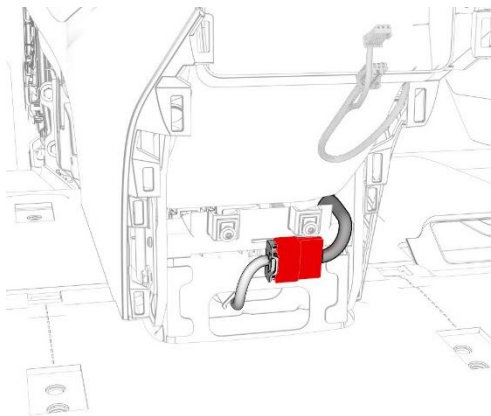

Figure 44. Center console rear electrical connector

16. With an assistant, remove the center console from the vehicle.

17. Remove the electrical connectors from the RCM.

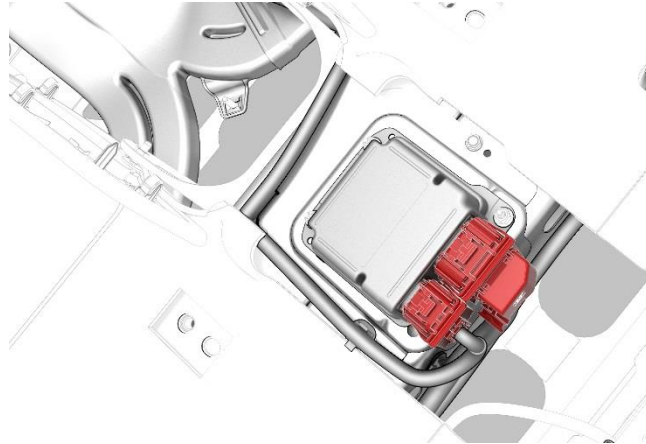

Figure 45. RCM electrical connectors

- a. Carefully pull the locking latch away from the RCM to release the connector from the RCM.



Figure 46. Release the RCM connectors

- b. Remove the connector from the RCM.



Figure 47. Remove the RCM connectors 2/2

- c. Repeat steps 17a and 17b to remove the other connector from the RCM.
18. Optionally, to remove the RCM from the Model 3:
 - a. Remove the nuts that attach the restrain control module to the body.
 - b. Remove the RCM from the vehicle.

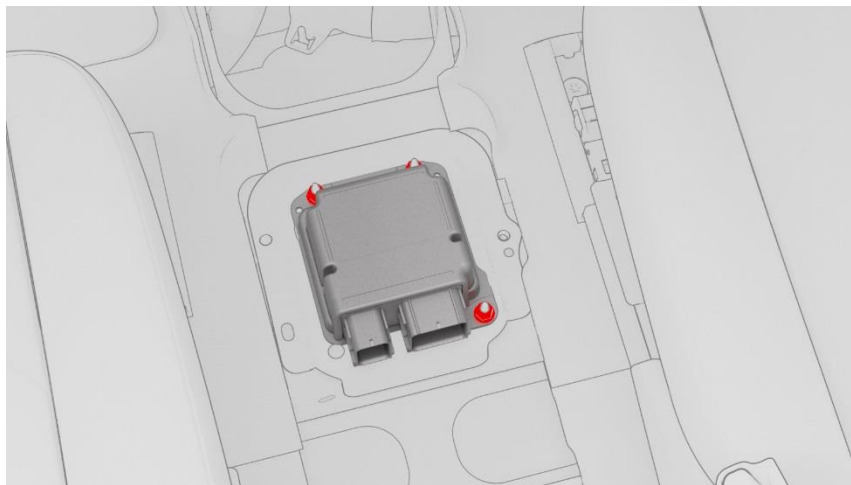

Figure 48. RCM ready for removal

19. Connect the Tesla Model 3 Direct-To-Module EDR Retrieval Cable to the RCM.

20. Connect the Tesla Model 3 Direct-To-Module EDR Retrieval Cable to the PCAN-USB adapter.

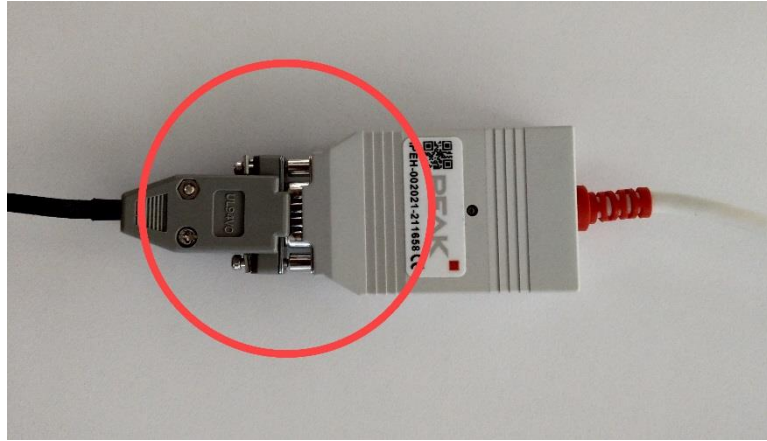

Figure 49. Connecting the EDR retrieval cable to the PCAN

21. Connect the PCAN-USB adapter to the computer used for data retrieval.

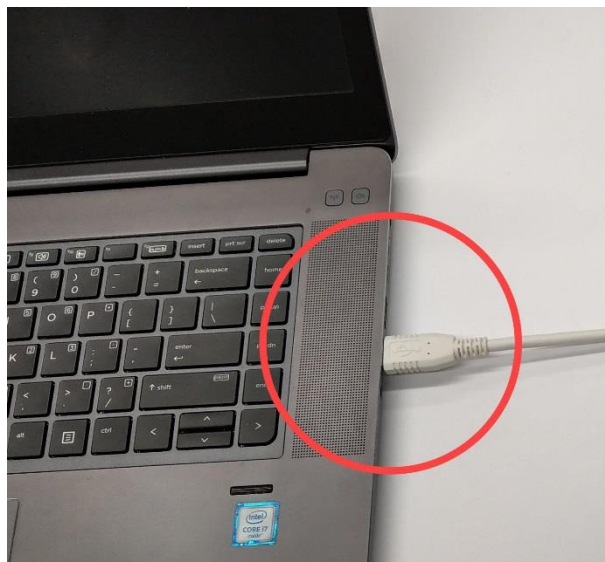

Figure 50. Connecting the PCAN to the computer

22. Connect 12V power to the Tesla Model 3 Direct-To-Module EDR Retrieval Cable.

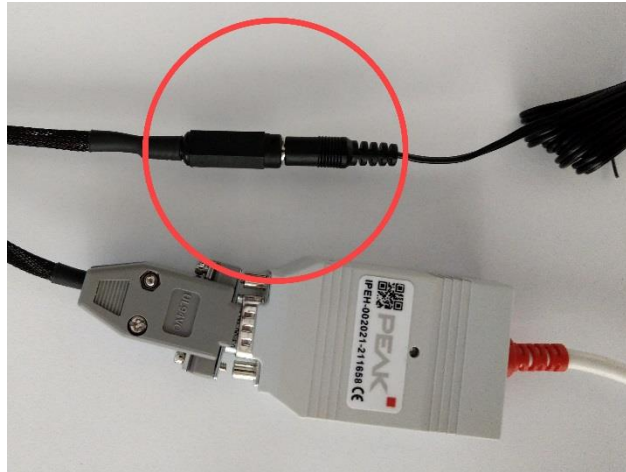

Figure 51. Connecting 12V power to the EDR retrieval cable

23. Proceed to “Retrieve Data” on page 28 to complete the data retrieval procedure.

Retrieve Data

Open the Tesla EDR Retrieval Program. The program automatically attempts to connect to the RCM.

- When connected properly, a green circle and the message “Connected to RCM” displays on the bottom left corner of the window (Figure 52).

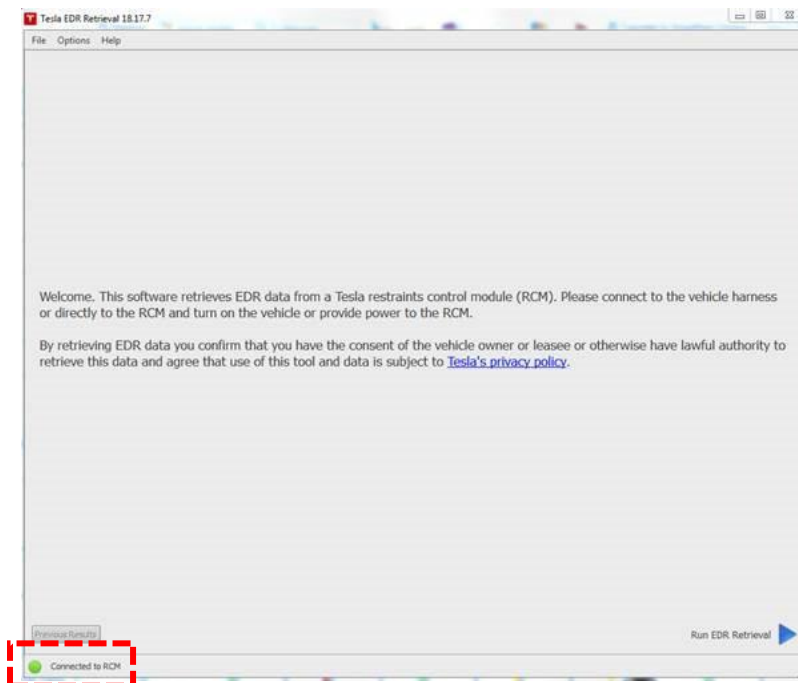

Figure 52. EDR program successful connection

Model 3 EDR Data Retrieval Guide For Vehicles Built Through 10/05/20

- If the Tesla EDR Retrieval Program is not communicating with the PCAN-USB adapter, a message displays “Not Connected to PCAN.” Check the connection to the PCAN-USB adapter.
- If the Tesla EDR Retrieval Program is communicating with the PCAN-USB adapter, but is not communicating with the RCM, a message displays “Not Connected to RCM” (Figure 53)

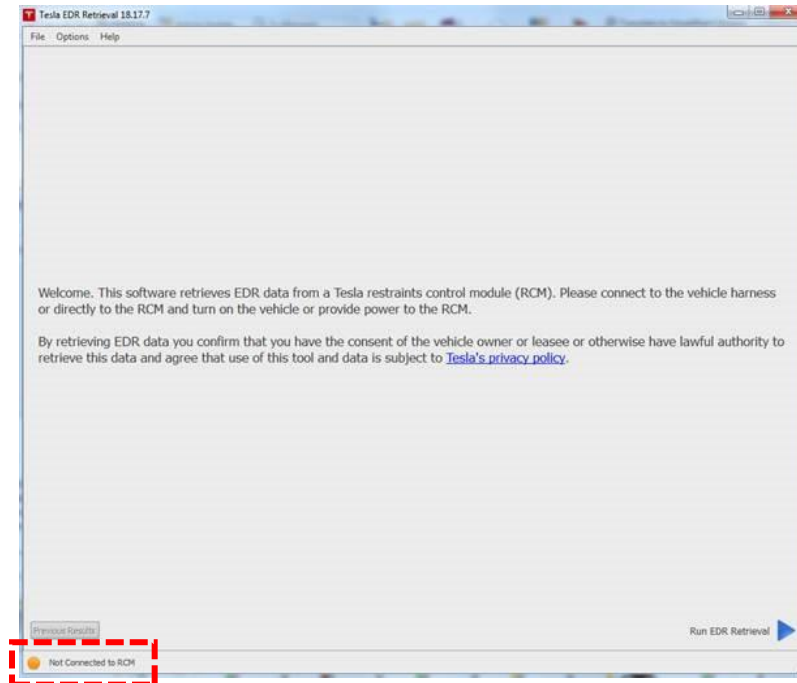

Figure 53. EDR program not successfully connected

Try the following steps to establish communication:

- If power is being supplied by the vehicle 12V system, check the connection to the vehicle harness.
- If power is being supplied by an external 12V power supply, check the connections to the power supply. If the power supply connections are correct:
 - a. Turn off the external power supply.
 - b. Disconnect the positive output of the external 12V power supply from the bare portion of the yellow wire.

- c. For the First Responder Loop you are using to power the RCM, strip ½ inch of wire from the unused end of the yellow wire (indicated by the green arrow).

If you are using the front First Responder Loop:



Figure 54. Front First Responder Loop

If you are using the rear First Responder Loop:

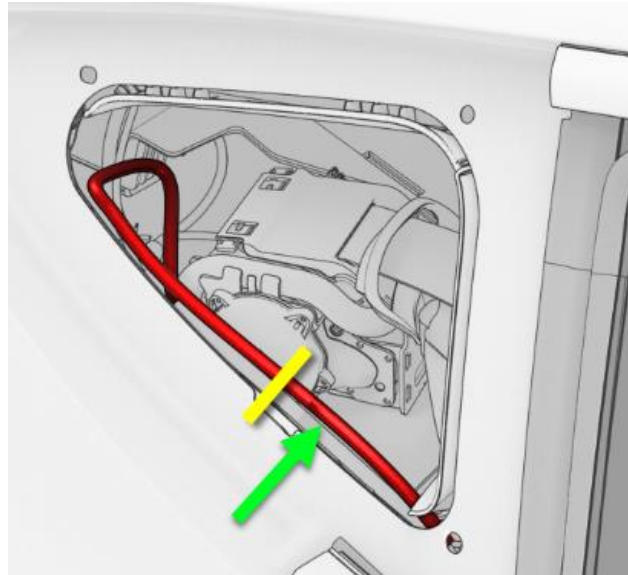

Figure 55. Rear First Responder Loop

- d. Use an alligator clip to connect the ground/negative output of the external 12V power supply to the vehicle frame.
- e. Use an alligator clip to connect the positive output of the external 12V power supply to the bare portion of the yellow wire.

- f. Turn on the external power supply.
 - g. Open the Tesla EDR Retrieval Program. The program automatically attempts to connect to the RCM.
 - If a connection is established, proceed to the next step.
 - If a connection cannot be established, connect to the RCM using the procedure described in “Establish a Direct-to-RCM Connection” on page 17.
2. Once connected to the EDR, click “Run EDR Retrieval” and follow the on-screen prompts to retrieve and save EDR data.



Figure 56. Retrieving data using the Tesla EDR retrieval program

The retrieved *.edr data file can be used to generate a Tesla EDR Report at <https://edr.tesla.com>.

For Further Assistance

For technical support, please contact the exclusive Tesla EDR hardware distributor, Crash Data Group:

Email: crash@crashdatagroup.com

Phone: (951) 252-9254

Toll Free: (800) 280-7940