

Instant Pot®

DUO™

Mini, 6 and 8 Quart
Multi-Use Pressure Cookers



User Manual

Important Safeguards
Product Specifications
Initial Setup
Product, Parts and Accessories
Smart Program Settings
Cleaning Before First Use
Overview of Pressure Control
Features
Initial Test Run (Water Test)
Cooking with the Duo
Pressure Cooking Timetable
Grain-to-Water Ratios
Care and Cleaning
Troubleshooting
Warranty
Contact Information

Welcome to the world of Instant cooking.

Thank you for welcoming us into your kitchen.

Having families ourselves, we developed the Instant Pot® Duo™ pressure cookers to allow busy families and professionals alike to cook healthy, delicious meals more easily and in less time.

We have partnered with chefs, authors and bloggers to compile a collection of recipes that we hope you enjoy!

Happy cooking,



Robert J. Wang
Founder and Chief Innovation Officer



Download the Instant Pot App

- Original Recipes
- New User Tips
- Getting Started Videos



Find helpful [how-to videos](#), [download the app](#), or visit our [recipe](#) site.

Table of Contents

IMPORTANT SAFEGUARDS	5-10
Special Cord Set Instructions	10
Product Specifications	10
Initial Setup	11
Product, Parts and Accessories	12-14
Control Panel	15-16
Smart Program Settings	17-19
Adjust and Save Pressure Cooking Temperature	17
Adjust and Save Pressure Cooking Time.....	17
Adjust and Save Non-Pressure Cooking Temperatures	17
Adjust and Save Non-Pressure Cooking Time	17
Cancel and Standby Mode	18
Turn Sound On/Off	18
Set a Delay Start Timer	18
Automatically Keep Food Warm for Long Periods	19
Reheat Food or Keep Warm for Long Periods.....	19
Reset Smart Programs to Factory Default Settings	19
Status Messages	20
Cleaning Before First Use	21
Overview of Pressure Control Features	22-29
Pressure Cooking Lid.....	22
Steam Release Handle	23-24
Anti-Block Shield	25
Sealing Ring.....	26
Float Valve.....	27-28
Condensation Collector	29

Table of Contents

Introduction to Pressure Cooking	30
Cooking with the Duo.....	30-31
Depressurizing the Cooker (Venting Methods).....	32-34
Initial Test Run (Water Test)	35
Using Pressure Cooking Smart Programs	36-42
Pressure Cooking Settings.....	39-40
Pressure Cooking Tips.....	41-42
Pressure Cooking Timetable and Grain-to-Water Ratios	43-44
Using Non-Pressure Cooking Smart Programs.....	45-49
Slow Cook.....	46
Sauté.....	47
Yogurt.....	48-49
Care and Cleaning	50-51
Troubleshooting.....	52-54
Warranty.....	55-56
Contact Information	57



IMPORTANT SAFEGUARDS

When using electrical appliances, basic safety precautions should always be followed:

1. READ THE *GETTING STARTED GUIDE* AND ALL INSTRUCTIONS, SAFEGUARDS, AND WARNINGS BEFORE OPERATING THE APPLIANCE. FAILURE TO FOLLOW THESE SAFEGUARDS AND INSTRUCTIONS MAY RESULT IN INJURY AND/OR PROPERTY DAMAGE.
2. Use only the Instant Pot Duo lid with the Instant Pot Duo pressure cooker base. Using any other pressure cooker lids may cause injury and/or damage.
3. To reduce the risk of pressure leakage, cook only in an authorized stainless steel Instant Pot inner pot. DO NOT use the appliance without the removable inner pot installed.
4. Always operate the appliance on a stable, non-combustible, level surface.
5. Do not use the appliance for anything other than its intended use. Failure to follow these instructions may result in injury or property damage.
6. For household use only. Do not use outdoors. Not for commercial use.
7. **⚠ CAUTION** Do not place the appliance on or in close proximity to a hot gas or electric burner, or a heated oven. Heat from an external source will damage the appliance. Failure to follow these instructions may result in injury or property damage.
8. **⚠ CAUTION** Do not use the appliance near water or flame. Keep out of direct sunlight. Failure to follow these instructions may result in injury or property damage.
9. **⚠ CAUTION** Do not touch hot surfaces. Only use side handles for carrying or moving. Extreme caution must be used when moving the appliance containing hot liquids. Do not move the appliance when it is under pressure.
10. The cooker base contains electrical components. To avoid electrical shock, do not put liquid of any kind into cooker base, and do not immerse power cord, plug, or the appliance in water or other liquid. Do not rinse the appliance under tap.
11. **⚠ CAUTION** Do not fill over **PC MAX – 2/3** as indicated on the inner pot. When cooking foods that expand during cooking such as rice or dried vegetables, do not fill the inner pot over **–1/2** line. Overfilling may cause a risk of clogging the steam release pipe and developing excess pressure.

IMPORTANT SAFEGUARDS

12. **⚠️ WARNING** This appliance cooks under pressure. Inappropriate use may result in burns, injury and/or property damage. Make certain the appliance is properly closed before operating. Refer to [Pressure Control Features– Pressure Cooking Lid](#).
13. When cooking meat with skin (e.g. sausage with casing), the skin can swell when heated. Do not pierce the skin while it is swollen; this could result in scalding injury.
14. **⚠️ CAUTION** When pressure cooking food with a doughy or thick texture, or a high fat/oil content, contents may splatter when opening the lid. Please follow recipe instructions for pressure release method. Refer to [Depressurizing the Cooker \(Venting Methods\)](#).
15. **⚠️ CAUTION** Before each use, check the steam release valve/handle, steam release pipe, anti-block shield and float valve for clogging. Failure to do so may result in injury or property damage.
16. **⚠️ DANGER** Do not open the appliance until it has depressurized and all internal pressure has been released. If the float valve is still up and/or the lid is difficult to open, this indicates that the appliance is still pressurized – do not force it open. Any pressure in the appliance can be hazardous. Refer to [Depressurizing the Cooker \(Venting Methods\)](#) for information on releasing pressure. Opening appliance while it is still pressurized may lead to sudden release of hot contents and may cause burns or other injuries.
17. Do not use this appliance for deep frying or pressure frying with oil.
18. Do not lean over or place your hands or face over the steam release valve/handle or float valve when the appliance is in operation or has residual pressure. Do not touch the metal portion of the lid when the appliance is in operation; this could result in injury.
19. Do not cover or obstruct the steam release valve/handle and/or float valve with cloth or other objects. Obstructing the steam release valve/handle and/or float valve can create a safety issue and may cause injury.
20. Turn the appliance off if steam escapes from the steam release valve/handle and/or float valve in a steady stream for longer than 3 minutes. There may be residual pressure in the appliance. Allow the appliance to depressurize naturally or release all excess pressure before opening. For more information on how to release pressure, refer to [Depressurizing the Cooker \(Venting Methods\)](#).



Read this manual carefully and completely, and retain for future reference. Failure to adhere to safety instructions may result in serious injury.

IMPORTANT SAFEGUARDS

21. Turn the appliance off if steam escapes from the sides of the lid and ensure sealing ring is properly installed. [Overview of Pressure Control Features– Sealing Ring](#) for more information.
22. To disconnect, select **Cancel**, then remove plug from power source.
23. Unplug from the outlet when not in use, as well as before adding or removing parts or accessories, and before cleaning. To unplug, grasp the plug and pull from the outlet. Never pull from the power cord.
24. Regularly inspect the appliance and power cord. Do not operate the appliance if the power cord or plug is damaged, or after the appliance malfunctions or is dropped or damaged in any manner. For assistance, contact Customer Care at support@instantpot.com or **1-800-828-7280**.
25. **⚠ CAUTION** Do not let the power cord hang over edges of tables or counters, or touch hot surfaces or open flame, including the stovetop.
26. **⚠ CAUTION** Spilled food can cause serious burns. A short power-supply cord is provided to reduce the hazards resulting from grabbing, entanglement and tripping.
 - Keep the appliance and cord away from children.
 - Never drape the power cord over edges of tables or counters.
 - Never use below-counter power outlets, and never use with an extension cord.
27. Intended for countertop use only. Keep the appliance on a stable, heat-resistant platform. Do not place on anything that may block the vents on the bottom of the appliance. Do not place on a hot stove.
28. **⚠ CAUTION** Do not use any accessories or attachments not authorized by Instant Brands™ Inc. The use of attachments not recommended by the manufacturer, may cause a risk of injury, fire or electric shock.
29. **⚠ CAUTION** Before inserting the inner pot into the appliance, clean the outer surface of the inner pot and the heating element located on the inner surface of the outer pot with a clean, dry cloth. Ensure they are dry and free of food debris.
30. Do not attempt to repair, replace, or modify components of the appliance, as this may cause electric shock, fire or injury, and will void the warranty.



WARNING Read this manual carefully and completely, and retain for future reference. Failure to adhere to safety instructions may result in serious injury.

IMPORTANT SAFEGUARDS

31. Do not tamper with any of the safety mechanisms, as this may result in injury or property damage.
32. Do not use the appliance in electrical systems other than 120 V/60 Hz for North America. Do not use with power converters or adapters.
33. This appliance is NOT to be used by children or by persons with reduced physical, sensory, or mental capabilities. Close supervision is necessary when any appliance is used near children and these individuals. Children should not play with this appliance.
34. To prevent personal injury and damage to the appliance, only replace the sealing ring with an authorized Instant Pot sealing ring.
35. The use of accessory attachments not recommended by the appliance manufacturer may cause injuries.
36. Proper maintenance is recommended after each use. Refer to [Care and Cleaning](#). Let the appliance cool to room temperature before cleaning or storage.
37. Never connect this appliance to an external timer switch or separate remote-control system.
38. **⚠ CAUTION** DO NOT touch accessories during or immediately after cooking. To avoid personal injury,
 - Always use oven mitts when removing accessories, and to handle the inner pot.
 - Always place hot accessories on a heat resistant surface or cooking plate.
 - Use extreme caution when disposing of hot grease.

Failure to follow these instructions may result in serious injury or property damage.

39. Do not leave the appliance unattended while in use.
40. **⚠ CAUTION** Extreme caution must be used when the inner pot contains hot oil, hot food, or hot liquids. Improper use, including moving the cooker base, may result in personal injury. Do not move the appliance while it is in use.
41. Oversized foods and/or metal utensils must not be inserted into the inner pot as they may cause risk of fire and/or personal injury.
42. Do not store any materials in the cooker base or inner pot when not in use.



Read this manual carefully and completely, and retain for future reference. Failure to adhere to safety instructions may result in serious injury.

IMPORTANT SAFEGUARDS

43. Do not place any combustible materials in the cooker base or inner pot, such as paper, cardboard, plastic, Styrofoam or wood.
44. Do not use the included accessories in a microwave, toaster oven, convection or conventional oven, or on a ceramic cooktop, electric coil, gas range, or outdoor grill.
45. The removable inner pot can be extremely heavy when full of ingredients. Care should be taken when lifting the inner pot from the cooker base to avoid burn injury.
46. Use caution when removing the lid. Heat and steam escapes as soon as the lid is removed. Never place your face, hands or exposed skin over the appliance opening where heat and steam escapes when removing the lid.

SAVE THESE INSTRUCTIONS



Read this manual carefully and completely, and retain for future reference.
Failure to adhere to safety instructions may result in serious injury.

IMPORTANT SAFEGUARDS

WARNING

To avoid injury, read and understand instruction manual before using this appliance. Failure to do so may result in injury.

WARNING

Electrical shock hazard. Use grounded outlet only. DO NOT remove ground. DO NOT use an adapter. DO NOT use an extension cord. Failure to follow instructions can cause electric shock or death.

WARNING

THE FAILURE TO FOLLOW ANY OF THE IMPORTANT SAFEGUARDS AND THE IMPORTANT INSTRUCTIONS FOR SAFE USE IS A MISUSE OF YOUR APPLIANCE THAT CAN VOID YOUR WARRANTY AND CREATE THE RISK OF SERIOUS INJURY.

Special Cord Set Instructions

As per safety requirements, a short power supply cord (0.6 m to 0.9 m / 24" to 35") is provided to reduce the hazards resulting from grabbing, entanglement and tripping.

This appliance has a 3-prong grounding plug. To reduce the risk of electric shock, plug the power cord into a grounded (earthed) electrical outlet that is easily accessible.

Product Specifications



Duo Mini	3 Quart 2.8 Litres	700 watts	120 V / 60 Hz	3.9 kg 8.6 lbs.	in: 11.4 L × 10 W × 11.2 H cm: 29 L × 25.5 W × 28.5 H
Duo 60 V3	6 Quart 5.7 Litres	1000 watts	120 V / 60 Hz	5.35 kg 11.80 lbs.	in: 13.4 L × 12.2 W × 12.5 H cm: 34 L × 31 W × 31.7 H
Duo 80 V2	8 Quart 7.6 Litres	1200 watts	120 V / 60 Hz	7.16 kg 15.79 lbs.	in: 14.8 L × 13.3 W × 14.2 H cm: 37.6 L × 33.8 W × 36.1 H

WARNING

Read this manual carefully and completely, and retain for future reference. Failure to adhere to safety instructions may result in serious injury.

Initial Setup

- Read all the [Important Safeguards](#) before using the appliance. Failure to read and follow the Important Safeguards may result in damage to the appliance, property damage or personal injury.
- Use only the Instant Pot Duo lid with the Instant Pot Duo pressure cooker base. Using any other pressure cooker lids may cause injury and/or damage.
- Remove all packaging material and accessories from within and around the appliance.
- Place the appliance on a stable, level surface, away from combustible material and external heat sources.
- Do not remove safety warning stickers from the lid or rating label from back of the cooker base.
- Follow [Cleaning Before First Use](#) instructions to clean the appliance before first use.

CAUTION

Do not place the appliance on a stovetop. Heat from an external source will damage the appliance.

Do not place anything on top of the appliance, and do not cover or block the steam release valve or anti-block shield located on the appliance lid.

Product, Parts and Accessories

Duo Mini, 6 and 8 Quart Pressure Cookers

Before using the Instant Pot Duo, verify that all parts are accounted for.

Top of Lid

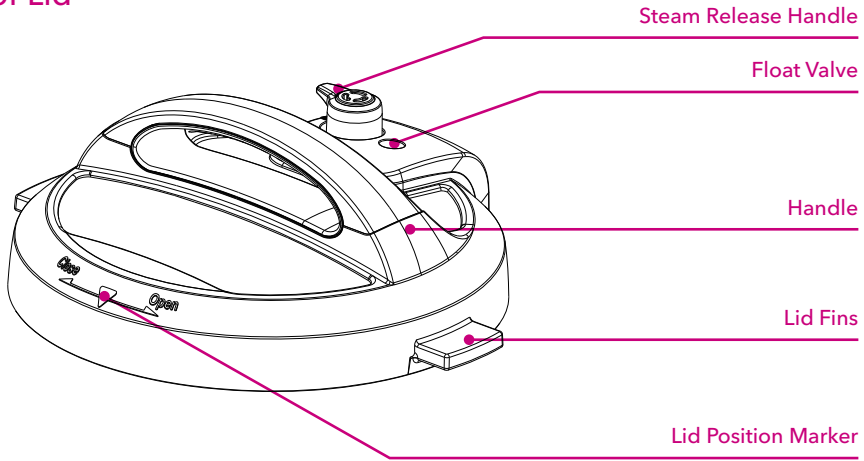

Bottom of Lid

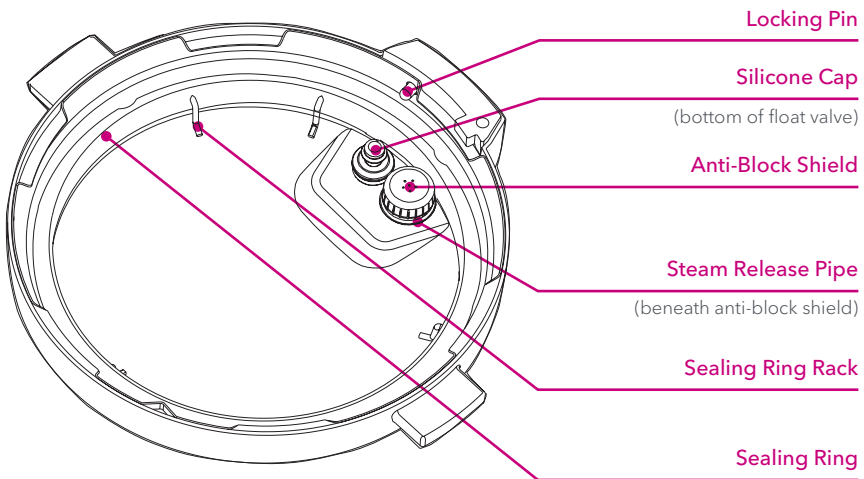

Illustrations are for reference only and may differ from the actual product.

Instant Tip: The lid has been designed with lid fins that fit perfectly inside the handles on the left and right sides of the cooker base to help keep your countertop dry!

Product, Parts and Accessories

Inner Pot

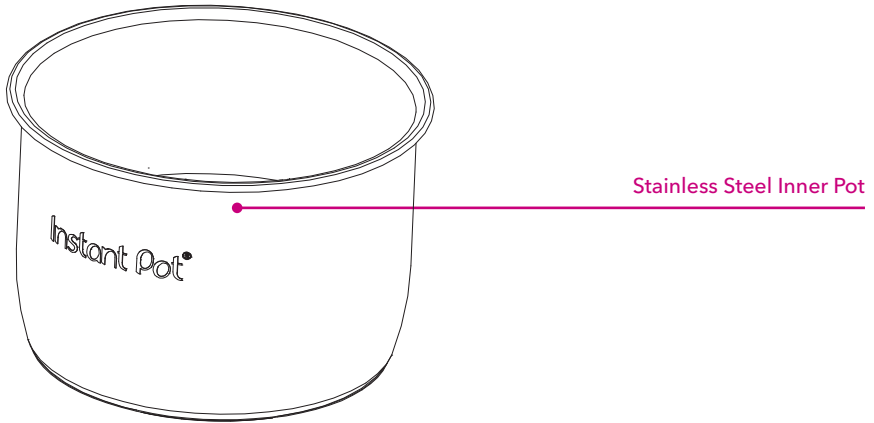

Cooker Base

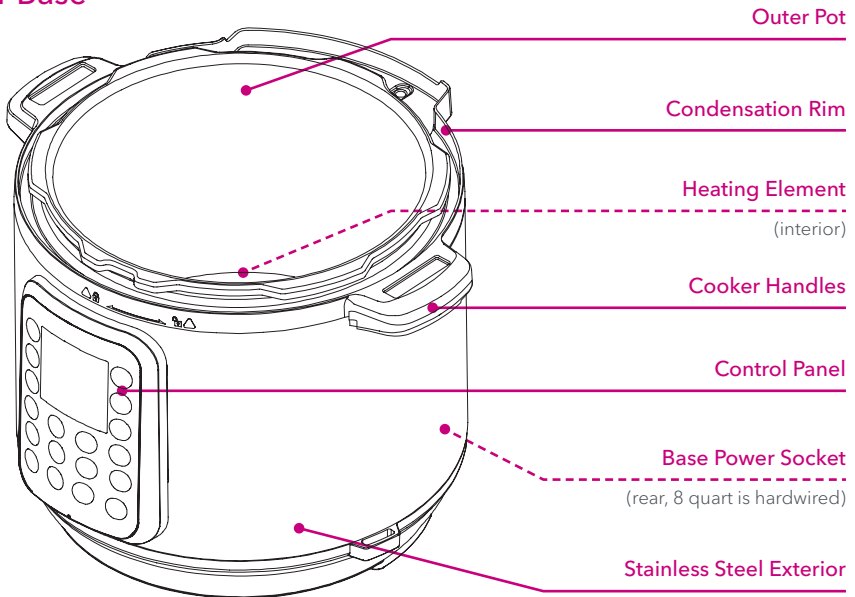

Illustrations are for reference only and may differ from the actual product.

Product, Parts and Accessories

Accessories

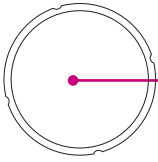

Sealing Ring

(installed in lid)

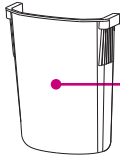

Condensation Collector

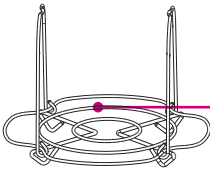

Steam Rack with Handles

(Mini steam rack may not have handles)

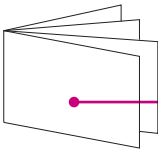

Getting Started Guide

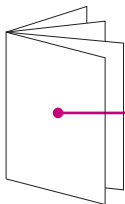

Safety, Maintenance and Warranty

Illustrations are for reference only and may differ from the actual product.



Control Panel

The Instant Pot Duo multi-use pressure cooker features an intuitive control panel to help make cooking fast and easy.

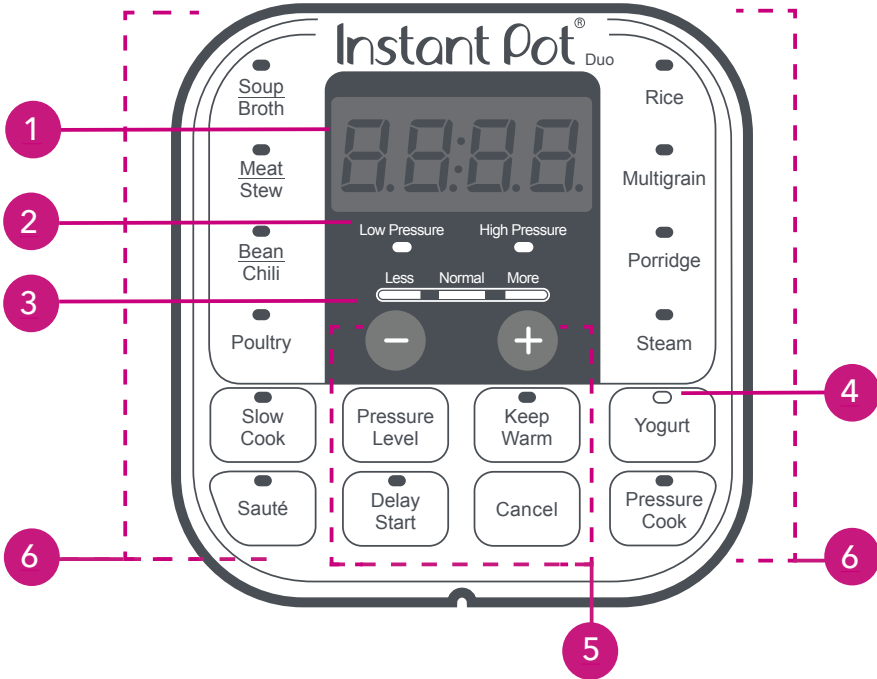

1 Time Display

- Countdown timer indicates cooking and Delay Start time in hour format: **05:20** is 5 hours, 20 minutes.
- **Keep Warm** timer counts up.
- Display also shows [Status Messages](#) as described below.

2 Pressure Field

- LED indicators illuminate to indicate **Low** or **High** pressure level.

3 Less - Normal - More

- **Pressure cooking**: 3 preset time options.
- **Non-Pressure cooking**: 3 temperature levels.

4 LED Indicators

- Illuminate to indicate the active Smart Program and settings selected.

Control Panel

5 Smart Program Settings

- Pressure Level
- Keep Warm
- – / + buttons
- Delay Start
- Cancel

See [Smart Program Settings](#) for more information.

6 Smart Programs

Pressure Cooking:

- Pressure Cook
- Soup/Broth
- Meat/Stew
- Bean/Chili
- Poultry (Not available on Duo Mini)
- Rice
- Multigrain (Not available on Duo Mini)
- Porridge
- Steam

Non-Pressure Cooking:

- Slow Cook
- Sauté
- Yogurt
- Keep Warm

Smart Program Settings

Adjust and Save Pressure Cooking Temperature

Select a pressure cooking Smart Program, then press **Pressure Level** to toggle between **High** (10.2-11.6 psi) and **Low** (5.8-7.2 psi) pressure levels.

Note: A higher pressure results in higher cooking temperature.

When cooking begins, the pressure level you selected is saved and remembered the next time the Smart Program is selected.

The cooking temperature may be adjusted at any time during pressure cooking by pressing **Pressure Level**, but adjustments made after cooking has begun will not be saved.

Adjust and Save Pressure Cooking Time

Select a pressure cooking Smart Program, then press the Smart Program button again to cycle through the **Less**, **Normal** and **More** cooking time options.

If desired, use the **- / +** buttons to further customize the time.

When cooking begins, your customizations are saved and remembered the next time the Smart Program is selected.

The cooking time may be adjusted at any time during pressure cooking, but adjustments made after cooking has begun will not be saved.

Adjust and Save Non-Pressure Cooking Temperatures

Select a non-pressure cooking Smart Program, then press the Smart Program button again to cycle through the **Less**, **Normal** and **More** cooking temperature levels.

When cooking begins, the temperature level is saved and remembered the next time the Smart Program is selected.

The cooking temperature may be adjusted at any time during non-pressure cooking by pressing the Smart Program button, but adjustments made after cooking has begun will not be saved.

Adjust and Save Non-Pressure Cooking Time

Select a non-pressure cooking Smart Program, then use the **- / +** buttons to adjust the cooking time.

The cooking time may be adjusted at any time during non-pressure cooking, but adjustments made after cooking has begun will not be saved.

Smart Program Settings

Cancel and Standby Mode

When the cooker is plugged in but not in operation, the display reads **OFF** to indicate Standby mode.

Press **Cancel** to stop a Smart Program at any time. The cooker returns to Standby mode.

Turn Sound On/Off

Sound On: When in Standby, press and hold **+** button until display indicates **S On**.

Sound Off: When in Standby, press and hold **-** button until display indicates **SOFF**.

Note: Audible safety alerts (beeps) cannot be turned off.

Set a Delay Start Timer

Delay Start can be set to a minimum of **10** minutes or a maximum of **24** hours.

1. Select a Smart Program and adjust the settings as you desire, then press **Delay Start**.

*Note: Once **Delay Start** has been selected, there is no way to return to the cooking settings. To adjust Smart Program settings, press **Cancel** and enter new selections.*

2. When the **hours field** flashes, use the **- / +** buttons to adjust the delay time. E.g., **02:00** indicates that cooking will start after 2 hours.
3. Press **Delay Start** again to toggle to the **minutes field** and follow the same process as the previous step.
4. Delay Start begins automatically after 10 seconds and the timer counts down.
5. When Delay Start ends, the Smart Program begins, and the display indicates **On**.

Delay Start is not available with the Sauté or Yogurt Smart Programs.

Smart Program Settings

Automatically Keep Food Warm After Cooking

The Keep Warm setting turns on automatically after cooking on all Smart Programs except Sauté and Yogurt.

When automatic warming begins, the timer begins counting from **00:00** to indicate the time passed, up to **10** hours.

To turn automatic warming off, press **Keep Warm**. The LED above the button dims to indicate that it is off and will not turn on after cooking completes.

Reheat Food or Keep Warm for Long Periods

When in Standby, select **Keep Warm**. Press **Keep Warm** again to cycle through **Less**, **Normal** and **More** warming temperature levels.

Use the **- / +** buttons to set a warming timer up to **99** hours and **50** minutes.

Reset Smart Programs to Factory Default Settings

Reset Individual Smart Programs

With the cooker in Standby mode, press and hold one Smart Program button until the cooker returns to Standby and displays **OFF**.

The Smart Program's pressure level, cooking time and temperature are restored to the factory default setting.

Reset All Smart Programs

With the cooker in Standby mode, press and hold **Cancel** until the cooker beeps.

All Smart Program pressure levels, cooking times and temperatures are restored to the factory default setting.

Status Messages

OFF

Indicates that the cooker is in Standby mode.

Lid

Indicates that the pressure cooker lid is not properly secured or missing.

On

Indicates that the cooker is in Preheat mode.

05:20

Display timer indicates one of the following:

- When a Smart Program is running, the display timer counts down to indicate the cooking time remaining in the Smart Program.
- When Delay Start is running, the display timer counts down until the Smart Program begins.
- When Keep Warm is running, the display timer counts up to indicate how long food has been warming.

Auto

Indicates that the Rice Smart Program is running.

boil

Indicates that the Yogurt Smart Program is in the pasteurizing cycle (i.e., the Yogurt Smart Program is set to More).

Hot

Indicates that the Sauté Smart Program has reached cooking temperature and food may be added to the inner pot.

End

Indicates that a Smart Program has ended and Keep Warm is off.

Food
burn

Indicates overheating in the cooking chamber. Refer to [Troubleshooting](#).

E

Indicates that an error has occurred. Refer to [Troubleshooting](#).

Cleaning Before First Use

Remove the inner pot from the cooker base and wash it with hot water and dish soap. Rinse with warm, clear water and use a soft cloth to dry the outside of the inner pot.

Note: The inner pot is dishwasher safe.

Wipe the heating element to ensure it is free of stray packaging particles before returning the inner pot to the cooker base. Failure to do so may damage the cooker.

The inner pot is an integral part of product safety. Food must be placed in the inner pot, and never directly in the cooker base.

To avoid personal injury or damage to the appliance, replace a deformed or damaged inner pot. Use only authorized Instant Pot inner pots made for this model when cooking.

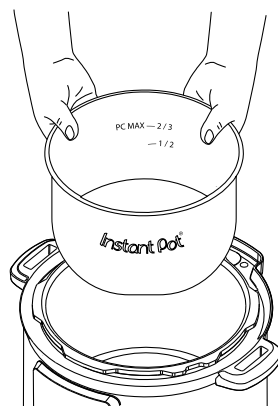
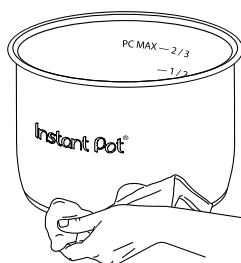

Illustrations are for reference only and may differ from the actual product.

CAUTION

To avoid risk of personal injury and/or property damage, do not pour food or liquid into cooker base.

WARNING

Do not fill the inner pot higher than the **PC MAX — 2/3 line** (Pressure Cooking Maximum), as indicated on the inner pot.

Exercise extreme caution when cooking and venting food such as applesauce, cranberries, pearl barley, oatmeal, split peas, noodles, etc., as these foods may foam, froth, or spatter, and may clog the steam release pipe and/or steam release valve. Do not fill the inner pot higher than the **— 1/2 line** when cooking these foods, as indicated on the inner pot.

Overview of Pressure Control Features

Pressure Cooking Lid



The stainless steel lid included is necessary for most cooking processes, and is essential for pressure cooking. Always ensure to use the Duo pressure cooking lid with the Duo cooker base.

For replacement parts and accessories, visit [our store](#).

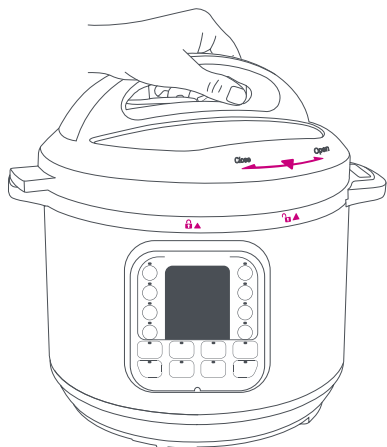
When plugged in, the cooker plays a jingle when the lid is opened and closed.





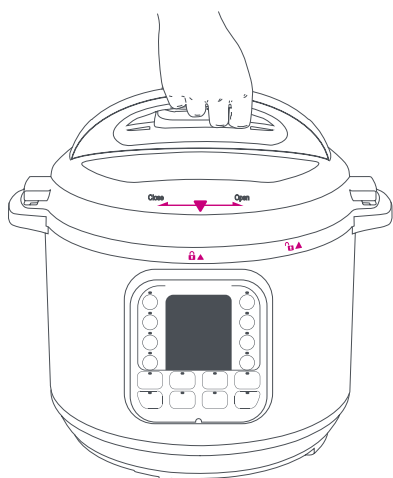

Open and Remove the Lid

Grip the lid handle and turn it counter-clockwise to align the  symbol on the lid with the  symbol on the rim of the cooker base, then lift the lid up and off the cooker base.



Close the Lid

Align the  symbol on the lid with the  symbol on the cooker base and lower the lid onto the track. Turn the lid clockwise until the  symbol on the lid aligns with the  symbol on the cooker base.

Illustrations are for reference only and may differ from the actual product.

CAUTION

Always check the lid for damage and excessive wear prior to cooking.

WARNING

The Duo pressure cooking lid is not compatible with all Instant Pot pressure cookers. Always ensure to use an authorized Instant Pot pressure cooking lid compatible with Duo pressure cookers when pressure cooking. Using any other pressure cooker lid may cause injury and/or property damage.

Overview of Pressure Control Features

Steam Release Handle

Turning the handle from Sealing to Venting and vice versa manually opens and closes the steam release valve, sealing and venting the cooker as you desire. When the cooker releases pressure, steam ejects from the top of the steam release handle.

Refer to [Depressurizing the Cooker \(Venting Methods\)](#) for details on safe depressurization.

The steam release handle is integral to product safety and necessary for pressure cooking. It should be installed before use and cleaned regularly.

Remove the Steam Release Handle

Pull steam release handle up and off steam release pipe.

Steam release handle must be installed before use and cleaned frequently.

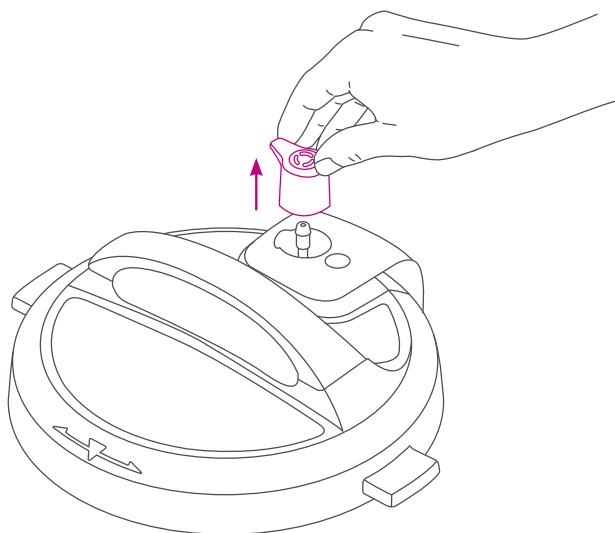

Illustrations are for reference only and may differ from the actual product.



WARNING Do not cover or block the steam release handle.

Overview of Pressure Control Features

Install the Steam Release Handle

Place the steam release handle on the steam release pipe and press down firmly.

The steam release handle sits loosely on the steam release pipe in order to pivot easily while the cooker is pressurized. It should remain in place when the lid is turned over.

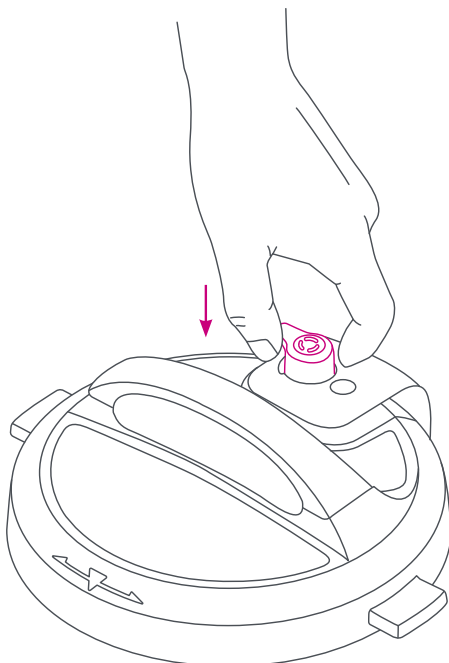

Illustrations are for reference only and may differ from the actual product.



WARNING

Do not cover or block the steam release handle.

Overview of Pressure Control Features

Anti-Block Shield

The anti-block shield prevents food particles from coming up through the steam release pipe, assisting with pressure regulation.

As an integral part of product safety, the anti-block shield must be installed before use and cleaned frequently.

Remove the Anti-Block Shield

Grip the lid like a steering wheel and use your thumbs to press firmly against the side of the anti-block shield (pressing towards the side of the lid and up) until it pops off the prongs underneath.

Install the Anti-Block Shield

Place anti-block shield over prongs and press down until it snaps into position.

Do not attempt to operate the pressure cooker without the anti-block shield installed.

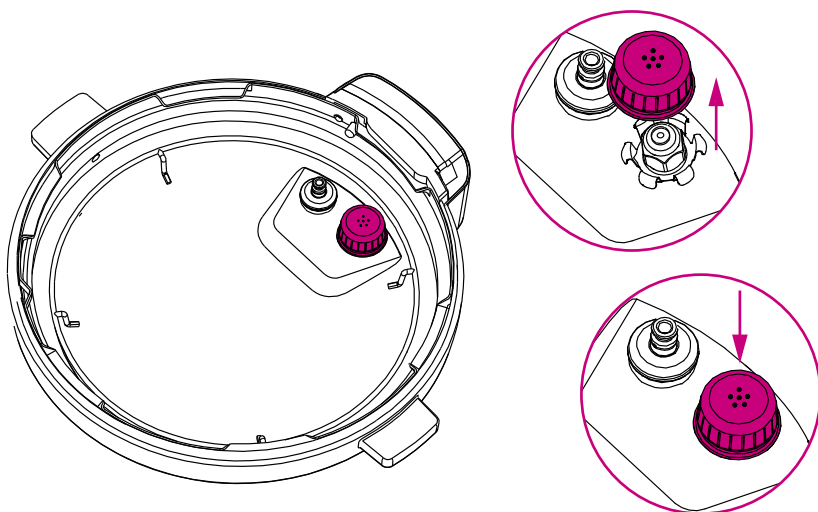

Illustrations are for reference only and may differ from the actual product.

Overview of Pressure Control Features

Sealing Ring

When the pressure cooking lid is closed, the sealing ring installed on the underside of the lid creates an air-tight seal between the lid and the cooker base.

The sealing ring must be installed before using the cooker and should be cleaned after each use. Only 1 sealing ring should be installed in the lid when using the cooker.

Sealing rings stretch over time with normal use. As an integral part of product safety, the sealing ring should be replaced every 12-18 months or sooner if stretching, deformation, or damage is noticed.

Remove the Sealing Ring

Grip the edge of the silicone rubber and pull the sealing ring out from behind the circular stainless steel sealing ring rack.

With the sealing ring removed, inspect the rack to ensure it is secured, centered, and at an even height all the way around the lid. Do not attempt to repair a deformed sealing ring rack.

Install the Sealing Ring

Place the sealing ring over the sealing ring rack and press it into place. Press down firmly to ensure there is no puckering.

When installed properly, the sealing ring is snug behind the sealing ring rack and should not fall out when the lid is turned over.

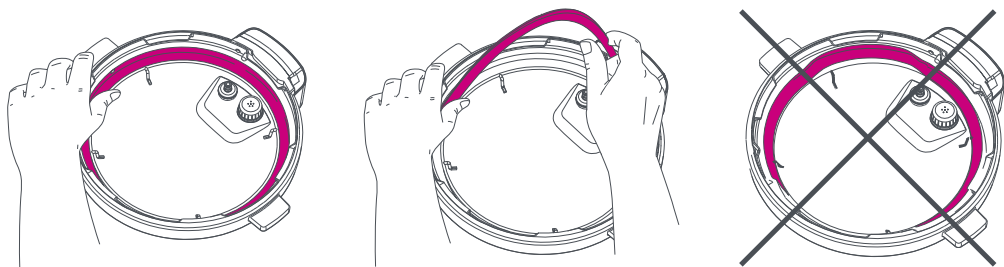

Illustrations are for reference only and may differ from the actual product.

Instant Tip: Silicone is porous, so it may absorb strong aromas and certain flavors. Keep extra sealing rings on hand to limit the transfer of those aromas and flavors between dishes. Visit our [store](#) to color code your cooking.

CAUTION

Always check for cuts, deformation, and correct installation of the sealing ring prior to cooking. Do not use a stretched or damaged sealing ring. Only use authorized Instant Pot sealing rings. Failure to follow these instructions may cause food to discharge, which may lead to personal injury or property damage.

Overview of Pressure Control Features

Float Valve

The float valve provides a visual indication of pressure within the cooker and appears in 2 positions.

Pressurized

The float valve is visible and flush with the lid.

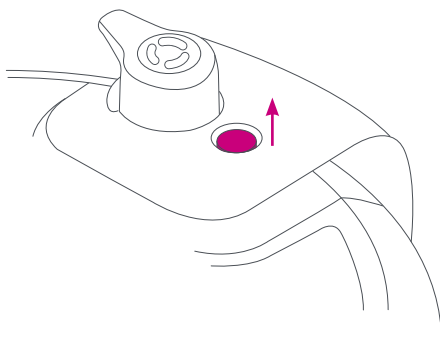

Depressurized

The float valve is sunken into the lid.

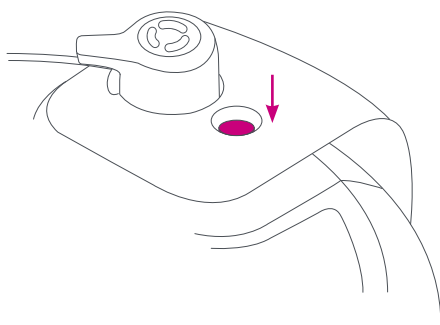

The float valve and silicone cap work together to seal in pressurized steam. These parts must be installed before use and should be cleaned after each use.

Illustrations are for reference only and may differ from the actual product.

⚠ WARNING

Do not lean over or touch the steam release assembly.

Do not place unprotected skin over the steam release assembly.

Do not cover or obstruct the steam release valve or cover.

Overview of Pressure Control Features

Remove the Float Valve from the Lid

Place one finger on the flat top of the float valve, then turn the lid over. Detach the silicone cap from the bottom side of the float valve.

Remove the float valve from the top of the lid. Do not discard the float valve or silicone cap.

Install the Float Valve

Drop the narrow end of the float valve into the float valve hole on the top of the lid. Place one finger on the flat top of the float valve, then turn the lid over. Firmly attach the silicone cap to the bottom of the float valve.

Do not attempt to operate the pressure cooker without the float valve and/or silicone cap properly installed in the pressure cooking lid.

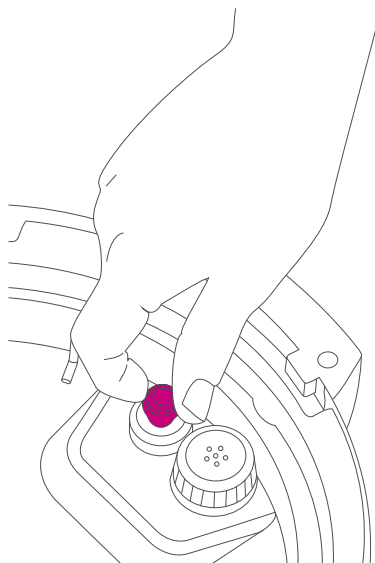

Illustrations are for reference only and may differ from the actual product.

⚠ DANGER

While the float valve is up, contents of cooker are under **extreme pressure**.

Do not attempt to remove the lid. All pressure **must** be released, and float valve **must** be down. Refer to [Depressurizing the Cooker \(Venting Methods\)](#) for information on releasing pressure. Failure to follow these instructions may result in property damage and/or personal injury.

Overview of Pressure Control Features

Condensation Collector

The condensation collector sits at the back of the cooker base and accumulates overflow moisture from the condensation rim. It should be installed before cooking, then emptied and rinsed out after each use.

Remove the Condensation Collector

Pull the condensation collector **away** from the cooker base; do not pull down. Note the tabs on the cooker base and the grooves on the condensation collector.

Install the Condensation Collector

Align the grooves on the condensation collector over the tabs on the back of the cooker base and slide the condensation collector into place.

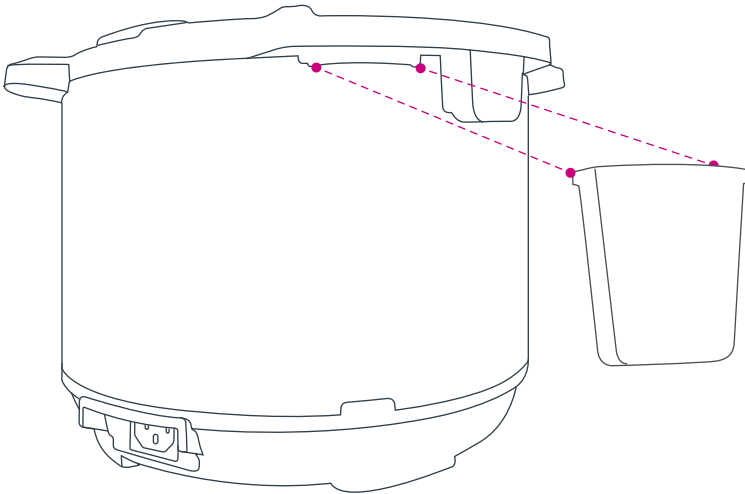

Illustrations are for reference only and may differ from the actual product.

Introduction to Pressure Cooking

Cooking with the Duo

Pressure cooking uses steam pressure to raise the boiling point of water above 100°C / 212°F. This energy-efficient cooking method is the *fastest* way to thoroughly cook a variety of your favorite meals.

Pressure cookers go through 3 stages when pressure cooking:

1. Pre-Heating and Pressurization

The cooker waits 10 seconds to ensure you have finished inputting your selections, then displays **On** to indicate it has begun pre-heating. While the cooker pre-heats, it vaporizes liquid in the inner pot to create steam. Once enough steam has built up inside the inner pot, the float valve pops up and locks the lid of the cooker in place for safe pressure cooking.

When the float valve pops up, the silicone cap attached to the bottom of the float valve (on the underside of the lid) seals the steam inside the cooking chamber (the inner pot) and allows the pressure to rise even higher. A higher pressure means a higher cooking temperature.

While it is normal to see some steam escaping through the float valve during pre-heating, if you see steam escaping from around the sides of the lid, press **Cancel** and refer to [Troubleshooting](#).

Note: *The time it takes your cooker to pressurize is determined by a variety of factors, including food and liquid volume.*

2. Cooking

After the float valve pops up, the cooker needs a few minutes to finish building pressure. When the required pressure level is reached, cooking begins. The display switches from **On** to the cooking countdown timer, and is displayed in **HH:MM** (hours : minutes) format.

Smart Program settings (e.g., cooking time, temperature and/or pressure level, and whether Keep Warm will come on automatically or not) can be adjusted at any time during cooking. Refer to [Smart Program Settings](#) for details.

Introduction to Pressure Cooking

3. Depressurization

After pressure cooking completes, follow your recipe instructions for depressurizing the cooker.

If automatic **Keep Warm** is on after cooking completes, the timer counts up from **00:00** to indicate the elapsed time up to 10 hours. If not, the cooker returns to Standby and displays **End**.

***Note:** The cooker cools and depressurizes faster if automatic Keep Warm is off.*

See [Depressurizing the Cooker \(Venting Methods\)](#) for information on releasing pressure after cooking.

⚠ DANGER

While the float valve is up, contents of cooker are under **extreme pressure**.

Do not attempt to remove the lid while the float valve is still up. All pressure **must** be released, and float valve **must** be down before attempting to remove the lid. Never attempt to force the lid open. Failure to follow the instructions may result in property damage and/or personal injury.

Depressurizing the Cooker (Venting Methods)

Always follow recipe instructions for depressurizing the cooker.

Natural Release (NR)

Leave the steam release handle in the **Sealing** position. As the temperature within the cooker drops, the cooker depressurizes naturally over time.

Depressurization time varies based upon the volume and type of food and liquid. When the cooker has completely depressurized, the float valve drops into the lid.

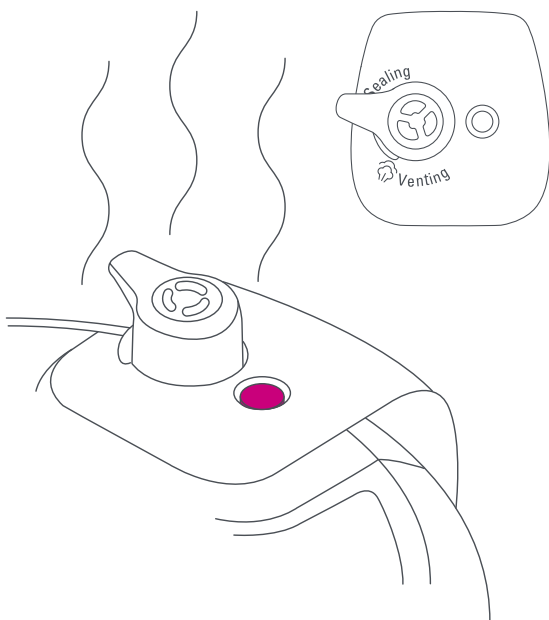

Illustrations are for reference only and may differ from the actual product.

NOTICE

Use NR to depressurize the cooker after cooking high-starch foods (e.g., soups, stews, chilis, pasta, oatmeal and congee) or when cooking foods that expand when cooked (e.g., beans and grains).

Depressurizing the Cooker (Venting Methods)

Quick Release (QR)

Quickly and carefully turn the steam release handle from the **Sealing** position to the **Venting** position.

A stream of steam releases through the top of the steam release handle.

Note: Steam may range in opacity but is always loud!

If continuous spatter occurs while venting, turn the steam release handle back to the **Sealing** position and try again after a few minutes.

If spatter continues, use NR to vent the remaining pressure.

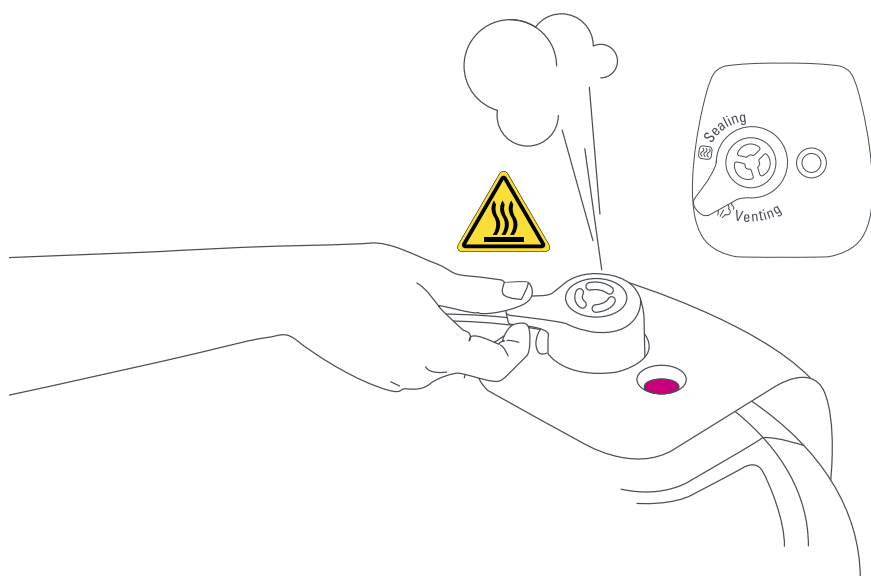

Illustrations are for reference only and may differ from the actual product.

NOTICE

Do not use QR when cooking high-starch foods (e.g., stews, chilis, pasta and congee) or when cooking foods that expand when cooked (e.g., beans and grains).

WARNING

Steam is hot. Do not place hands or face over steam release handle when venting.

Depressurizing the Cooker (Venting Methods)

10-Minute NR

Leave the steam release handle in the **Sealing** position for 10 minutes after cooking has completed, then turn the steam release handle to the **Venting** position.

A stream of steam releases through the top of the steam release handle.

If continuous spatter occurs while venting, turn the steam release handle back to the **Sealing** position and try again after a few minutes.

If spatter continues, use NR to vent the remaining pressure.

DANGER

While the float valve is up, contents of cooker are under extreme pressure. Do not attempt to remove the lid while the float valve is still up. All pressure must be released, and float valve must be down before attempting to remove the lid. Never attempt to force the lid open. Failure to follow the instructions may result in property damage and/or personal injury.

WARNING

Do not lean over or touch the steam release assembly.

Do not place unprotected skin over the steam release assembly.

Do not cover or obstruct the steam release valve or cover.



Initial Test Run (Water Test)

Follow these steps to familiarize yourself with your Instant Pot Duo.

Total test time: Approximately 20 minutes.

1. Remove the inner pot from the cooker base.
2. Add 3 cups (24 oz / 750 mL) of water to the inner pot.
3. Insert the inner pot into the cooker base.
4. **Mini and 6 Quart only:** Secure the power cord to the base power socket at the back of the cooker base. Ensure the connection is tight.
All: Connect the power cord to a 120 V power source.
The display indicates **OFF**.
5. Place and close the lid as described in [Pressure Control Features— Pressure Cooking Lid](#).
6. Turn the steam release handle to the **Sealing** position.
7. Press **Pressure Cook** to select the Pressure Cook Smart Program.
8. Use the **- / +** buttons to adjust the cooking time to **00:05** minutes.
Note: Cooking time adjustments are saved to the Smart Program when cooking begins.
9. Press **Keep Warm** to deactivate the automatic Keep Warm setting.
After 10 seconds, the display reads **On** to indicate that **Preheating** has begun.
10. The float valve rises when the cooker pressurizes.
After a few minutes the cooker reaches the target pressure level and **Cooking** begins.
The display changes from **On** to the cooking time countdown.
11. When the Smart Program is complete, the display indicates **End**.
12. Turn the steam release handle to **Venting**. Pressurized steam releases through the top of the steam release valve.
13. The float valve drops when the pressure has been fully released.
14. Open and remove the lid as described in [Pressure Control Features— Pressure Cooking Lid](#).
15. Carefully remove the inner pot from the cooker base, discard the water and thoroughly dry the inner pot.

You're ready to start cooking!



The inner pot will be hot after cooking. Always use appropriate heat protection when handling a hot inner pot.

Using Pressure Cooking Smart Programs

Whether you are a novice cook or a culinary expert, the Duo provides Smart Programs to get you cooking with the touch of a button.

The steps below follow the safest procedure for using the cooker and can be applied to the following Smart Programs: Soup/Broth, Meat/Stew, Bean/Chili, Poultry*, Rice, Multigrain*, Porridge, Steam (pressure and non-pressure) and Pressure Cook.

*Not available on Duo Mini. Use Pressure Cook instead.



Always inspect your Instant Pot pressure cooking lid, inner pot and cooker base carefully to ensure they are clean and in good working condition before use.

Instant Pot Size	Minimum Liquid for Pressure Cooking*
3 Quarts / 2.8 Litres	1 cup (8 oz / 250 mL)
6 Quarts / 5.7 Litres	1 ½ cups (12 oz / 375 mL)
8 Quarts / 7.6 Litres	2 cups (16 oz / 500 mL)

*Unless otherwise specified in recipe.

Pressure cooking liquids should be water-based, such as broth, stock, soup or juice. If using canned, condensed, or cream-based soup, add water as directed above.

CAUTION

To avoid scorching or scalding injury, be cautious when cooking with more than 1/4 cup (2 oz / 60 mL) oil, oil-based sauces, condensed cream-based soups, and thick sauces. Add suitable liquid to thin sauces. Avoid recipes that call for more than 1/4 cup (2 oz / 60 mL) of oil or fat content.

Using The Pressure Cooking Smart Programs

1. Open and remove the lid as described in [Pressure Control Features—Pressure Cooking Lid](#).
2. Add food and liquid ingredients to the inner pot.
Note: Cold or frozen food items take longer to generate steam and slow down pressurization. For the fastest results, thaw frozen ingredients before cooking.
3. Insert the inner pot into the cooker base.
4. **Mini and 6 Quart:** Secure the power cord to the base power socket at the back of the cooker base. Ensure the connection is tight.
All: Connect the power cord to a 120 V power source. The cooker goes to Standby mode and the display indicates **OFF**.
5. Place and close the lid as described in [Pressure Control Features—Pressure Cooking Lid](#).
6. Turn the steam release handle to the **Sealing** position.
7. Select your desired pressure cooking Smart Program.
8. Press the same Smart Program button again to cycle through **Less**, **Normal** and **More** time options.
9. For custom cooking, use the **- / +** buttons to adjust the cooking time.
10. Press **Pressure Level** to toggle between **Low** and **High** pressure.

Note: When pressure cooking, the pressure level controls the temperature. A higher pressure results in a higher cooking temperature.

Note: Cooking time and pressure level adjustments are saved to the Smart Program when cooking begins.

Using The Pressure Cooking Smart Programs

11. Press **Keep Warm** to toggle the automatic Keep Warm setting off and on.
12. After 10 seconds, the display reads **On** and indicates that **Pre-heating** has begun.
13. When cooking completes, follow recipe directions to select the appropriate venting method. Refer to [Depressurizing the Cooker \(Venting Methods\)](#).

Instant Tip: Use the steam rack to lift foods out of the cooking liquid. This ensures even heat distribution, prevent nutrients from leeching into the cooking liquid, and stop food items from scorching on the bottom of the inner pot.

⚠ DANGER

While the float valve is up, contents of cooker are under **extreme pressure**.

Do not attempt to remove the lid while the float valve is still up. All pressure **must** be released, and float valve **must** be down before attempting to remove the lid. Never attempt to force the lid open. Failure to follow the instructions may result in property damage and/or personal injury.

⚠ WARNING

Do not fill inner pot higher than the **PC MAX — 2/3** line as indicated on the inner pot.

When cooking foods that expand (e.g.; rice, beans, pasta) do not fill the inner pot higher than the **— 1/2** line as indicated on the inner pot.

Always cook with the inner pot in place. Do not pour food or liquid into the cooker base.

To avoid risk of personal injury and/or property damage, place food and liquid ingredients in the inner pot, then insert the inner pot into the cooker base.



Pressure Cooking Settings

Smart Program		Settings		
Soup/Broth	Pressure	Low (35-55 kPa / 5.8-7.2 psi) High (65-85 kPa / 10.2-11.6 psi)		
	Time Setting	Less	Normal	More
	Default Cooking Time (adjustable)	00:20	00:30	04:00
	Cooking Time Range	00:01-04:00		
Meat/Stew	Pressure	Low (35-55 kPa / 5.8-7.2 psi) High (65-85 kPa / 10.2-11.6 psi)		
	Time Setting	Less	Normal	More
	Default Cooking Time (adjustable)	00:20	00:35	00:45
	Cooking Time Range	00:01-04:00		
Bean/Chili	Pressure	Low (35-55 kPa / 5.8-7.2 psi) High (65-85 kPa / 10.2-11.6 psi)		
	Time Setting	Less	Normal	More
	Default Cooking Time (adjustable)	00:25	00:30	00:40
	Cooking Time Range	00:01-04:00		
Poultry*	Pressure	Low (35-55 kPa / 5.8-7.2 psi) High (65-85 kPa / 10.2-11.6 psi)		
	Time Setting	Less	Normal	More
	Default Cooking Time (adjustable)	00:05	00:15	00:30
	Cooking Time Range	00:01-04:00		
Rice	Pressure	Low (35-55 kPa / 5.8-7.2 psi) High (65-85 kPa / 10.2-11.6 psi)		
	Time Setting	Less	Normal	More
	Default Cooking Time (not adjustable)	00:08	00:12	00:15
	Cooking Time Range	Cook time adjusts automatically depending on the volume of rice: 8-15 minutes. Display indicates Auto .		

*Not available on Duo Mini. Use Pressure Cook instead.

Pressure Cooking Settings

Smart Program		Settings		
Multigrain*	Pressure	Low (35-55 kPa / 5.8-7.2 psi) High (65-85 kPa / 10.2-11.6 psi)		
	Time Setting	Less	Normal	More
	Default Cooking Time (adjustable)	00:20	00:40	01:00 (+ 00:45 soaking time)
	Cooking Time Range	00:01-04:00		
Porridge	Pressure	Low (35-55 kPa / 5.8-7.2 psi) High (65-85 kPa / 10.2-11.6 psi)		
	Time Setting	Less	Normal	More
	Default Cooking Time (adjustable)	00:05	00:20	00:30
	Cooking Time Range	00:01-04:00		
Steam	Pressure	Low (35-55 kPa / 5.8-7.2 psi) High (65-85 kPa / 10.2-11.6 psi)		
	Time Setting	Less	Normal	More
	Default Cooking Time (adjustable)	00:03	00:10	00:15
	Cooking Time Range	00:01-04:00		
Pressure Cook	Pressure	Low (35-55 kPa / 5.8-7.2 psi) High (65-85 kPa / 10.2-11.6 psi)		
	Time Setting	Less	Normal	More
	Default Cooking Time (adjustable)	00:20	00:35	00:45
	Cooking Time Range	00:01-04:00		

*Not available on Duo Mini. Use Pressure Cook instead.



Pressure Cooking Tips

Smart Program	Setting	Suggested Use	Notes
Soup/Broth	Less	Soup without meat	Liquid remains clear due to lack of boiling motion. Always use NR to release pressure when cooking soup with a high starch content.
	Normal	Soup with meat	
	More	Rich bone broth	
Meat/Stew	Less	Soft texture	Choose setting based on meat texture desired, or adjust cook time manually. Allow meat to “rest” for 5-30 minutes, depending on size. It will retain cooking juices for tender, succulent meat.
	Normal	Very soft texture	
	More	Fall-off-the-bone	
Bean/Chili	Less	Firmer texture	Choose setting based on bean texture desired, or adjust cook time manually. When cooking beans or legumes, always use NR to release pressure. Ensure dry beans are completely submerged in water.
	Normal	Soft texture	
	More	Very soft texture	
Poultry*	Less	Soft texture	Choose setting based on meat texture desired, or adjust cook time manually. Allow poultry to “rest” for 5-10 minutes, depending on size. It will retain cooking juices for tender, succulent meat.
	Normal	Very soft texture	
	More	Fall-off-the-bone texture	
Rice	Less	Tender but firm to bite	Automated cooking Smart Program. Displays Auto before cook time countdown. Depending on the volume of rice, cook time may range from 8 to 15 minutes. After cooking, wait 10 minutes, then use QR to release pressure, or allow to depressurize with NR.
	Normal	Normal texture white rice	
	More	Softer texture white rice	
Multigrain*	Less	Brown rice, wild rice, black beans, chickpeas, etc.	Select Less or Normal based on type of grain and desired texture.
	Normal	Brown rice, wild rice, mung beans, etc.	
	More	Tough grains or a mixture of grains and beans	Begins with 45 minutes of warm water soaking time prior to 60 minutes of pressure cooking.

*Not available on Duo Mini. Use Pressure Cook instead.

Pressure Cooking Tips

Smart Program	Setting	Suggested Use	Notes
Porridge	Less	Oatmeal, steel cut or rolled	Adjust time as directed in recipe. Always use NR to release pressure when cooking foods that expand.
	Normal	White rice, porridge/congee	
	More	Rice porridge/congee with a mixture of various grains	
Steam	Less	Vegetables	Use steam rack provided to elevate food from cooking liquid. Use QR to prevent food from overcooking.
	Normal	Fish and Seafood	
	More	Meat	
Pressure Cook	Less	Manual Programming	Press Pressure Level to toggle between High and Low pressure. Use - / + buttons to adjust cook time. Adjust according to recipe or desired results.
	Normal		
	More		

Pressure Cooking Timetable

The following cooking times are recommendations only. Always follow a trusted recipe.

	Food	Time
Vegetables	Asparagus, Beans (Yellow and Green), Broccoli	1-2 minutes
	Brussels Sprouts, Cabbage (Whole or Wedges), Cauliflower (Florets)	2-3 minutes
	Butternut Squash	4-6 minutes
	Carrots (Whole or Chunks)	6-8 minutes
	Corn (on the Cob)	3-5 minutes
	Potatoes (Large, Whole)	12-15 minutes
	Potatoes (Small, Whole)	8-10 minutes
	Potatoes (Cubed)	3-4 minutes
	Sweet Potatoes (Whole)	12-15 minutes
Sweet Potatoes (Cubed)	2-4 minutes	
Meat & Eggs	Beef (Stew)	20 minutes (per 450 g / 1 lb)
	Beef (Large Pieces), Beef (Ribs)	20-25 minutes (per 450 g / 1 lb)
	Chicken (Breasts)	6-8 minutes (per 450 g / 1 lb)
	Chicken (Whole)	8 minutes (per 450 g / 1 lb)
	Chicken (Bone Stock)	40-50 minutes
	Lamb (Leg), Pork (Butt Roast)	15 minutes (per 450 g / 1 lb)
	Pork (Baby Back Ribs)	15-20 minutes (per 450 g / 1 lb)
	Eggs	Hard: 5 mins
Beans & Lentils (Dry & Soaked)	Black Beans	D: 20-25 mins / S: 6-8 mins
	Black-Eyed Peas	D: 14-18 mins / S: 4-5 mins
	Chickpeas	D: 35-40 mins / S: 10-15 mins
	Kidney Beans (Red), Navy Beans	D: 20-25 mins / S: 7-8 mins
	Kidney Beans (White), Pinto Beans	D: 25-30 mins / S: 6-9 mins
	Lentils (Green)	D: 8-10 mins / S: N/A
	Lentils (Yellow)	D: 1-2 mins / S: N/A
	Lima Beans	D: 12-14 mins / S: 6-10 mins
Soybeans	D: 35-45 mins / S: 18-20 mins	

Pressure Cooking Timetable

	Food	Time
Seafood	Fish (Whole)	4-5 minutes
	Fish (Fillet), Lobster	2-3 minutes
	Mussels	1-2 minutes
	Shrimp (Or Prawn)	1-3 minutes
	Seafood Stock	7-8 minutes

CAUTION

Always use a meat thermometer to ensure the internal temperature reaches a safe minimum temperature. Refer to the USDA's Safe [Minimum Internal Temperature Chart](#) for more information.

Grain-to-Water Ratios

Rice and Grain	Grain : Water Ratio
White or Brown Rice	1:1 cup
Quinoa	1:3/4 cup
Oatmeal	1:3 cups
Risotto	1:2 cups—add additional wine to taste
Porridge	1:10 cups

Visit our [website](#) for a complete list of cooking timetables.

Using Non-Pressure Cooking Smart Programs

The Duo is much more than a pressure cooker. These non-pressure cooking Smart Programs get you cooking quickly and easily. Always ensure the lid is set to **Venting** when using non-pressure cooking programs.

The following sections provide the safest steps for using the cooker.



Always inspect your Instant Pot pressure cooking lid, inner pot and cooker base carefully to ensure they are clean and in good working condition before use.

⚠ WARNING

Do not fill inner pot higher than the **PC MAX — 2/3** line as indicated on the inner pot.

When cooking foods that expand (e.g.; rice, beans, pasta) do not fill the inner pot higher than the **— 1/2** line as indicated on the inner pot.

Always cook with the inner pot in place. Do not pour food or liquid into the cooker base.

To avoid risk of personal injury and/or property damage, place food and liquid ingredients in the inner pot, then insert the inner pot into the cooker base.

Using Non-Pressure Cooking Smart Programs

Slow Cook

Slow Cook is a non-pressure cooking program that is compatible for use with any common slow cooker recipe.

Setting	Suggested Use	Notes
Less	Low setting on common slow cookers	Follow recipe directions for slow cooking. Less is commonly used for low and slow, all-day cooking, and should be set for a minimum of 10:00 hours for best results.
Normal	Medium setting on common slow cookers	
More	High setting on common slow cookers	

1. Remove inner pot from cooker base.
2. Add food and liquid ingredients to the inner pot.
3. Insert the inner pot into the cooker base.
4. **Mini and 6 Quart:** Secure the power cord to the base power socket at the back of the cooker base. Ensure the connection is tight.
All: Connect the power cord to a 120 V power source. The cooker goes to Standby mode and the display indicates **OFF**.
5. Place and close the lid as described in [Pressure Control Features-Pressure Cooking Lid](#), or use a **glass lid** with a venting hole.
6. Turn the steam release handle to the **Venting** position.
7. Press **Slow Cook** to select the Slow Cook Smart Program.
8. Press **Slow Cook** again to cycle through the **Less, Normal** and **More** temperature options.
9. Use the **- / +** buttons to adjust the cooking time.
Note: Cooking time and temperature level adjustments are saved to the Smart Program when cooking begins.
10. Press **Keep Warm** to toggle the automatic Keep Warm setting off or on.
11. After 10 seconds, cooking begins and the display timer counts down.
12. When cooking completes, the display indicates **End** if Keep Warm is turned off. If not, the timer begins counting from **00:00** up to 10 hours.

Note: The float valve should not rise during Slow Cook. The lid is removable throughout the cooking process for easy access. If the float valve rises, ensure the steam release handle is set to the Venting position. Refer to [Depressurizing Your Cooker \(Venting Methods\)](#).

Using Non-Pressure Cooking Smart Programs

Sauté

Sauté is a non-pressure cooking program that can be used in place of a frying pan or flat-top grill.

Setting	Suggested Use	Notes
Less	Simmering, thickening and reducing liquids	The display switching from Hot to On indicates the cooker is maintaining the cooking temperature.
Normal	Pan searing or sautéing	
More	Stir-frying or browning meat	As a safety precaution, 30 minutes is the maximum cooking time and cannot be adjusted.

1. Insert the inner pot into the cooker base. **Do not use a lid.**
2. **Mini and 6 Quart:** Secure the power cord to the base power socket at the back of the cooker base. Ensure the connection is tight.
All: Connect the power cord to a 120 V power source. The cooker goes to Standby mode and the display indicates **OFF**.
3. Press **Sauté** to select the Sauté Smart Program.
4. Press **Sauté** again to cycle through the **Less**, **Normal** and **More temperature** options.
Note: Cooking temperature adjustments are saved to the Smart Program when cooking begins.
5. After 10 seconds, the cooker displays **On** to indicate that it has begun heating.
6. When display switches from **On** to **Hot**, add recipe ingredients.
*Note: If recipe ingredients are added before the **Hot** message appears, it may not appear at all. This is normal.*
7. When cooking completes, the display indicates **End**.
Note: Automatic Keep Warm cannot be turned on for the Sauté Smart Program.

Deglazing the Inner Pot (Pressure Cooking After Sauté)

Sautéing meat and vegetables before pressure cooking is the perfect way to boost flavors, as sugars caramelize from the high heat of the Sauté Smart Program.

To pressure cook after using Sauté, deglaze the inner pot to ensure food items do not scorch. **To deglaze**, remove food items from the inner pot and add a thin liquid (e.g., water, broth, wine) to the hot surface. Use a wooden or silicone scraper to loosen anything that may be stuck to the bottom of the inner pot.

WARNING

The Sauté Smart Program reaches high temperatures. If unmonitored, food may burn on this setting. Do not use the lid and do not leave your cooker unattended while using Sauté.

Cooking Tips

Yogurt

Yogurt is a non-pressure cooking Smart Program made for easy fermented dairy and non-dairy recipes.

Instant Pot Size	Minimum Milk Volume	Maximum Milk Volume
3 Quarts / 2.8 Litres	2 cups (16 oz / 500 mL)	2 quarts (64 oz / 1.9 L)
6 Quarts / 5.7 Litres	4 cups (32 oz / 1000 mL)	4 quarts (128 oz / 3.8 L)
8 Quarts / 7.6 Litres	6 cups (48 oz / 1500 mL)	6 quarts (192 oz / 5.7 L)

Pasteurize Milk

1. Add unpasteurized milk to the inner pot then insert the inner pot into the cooker base.
2. **Mini and 6 Quart:** Secure the power cord to the base power socket at the back of the cooker base. Ensure the connection is tight.
All: Connect the power cord to a 120 V power source. The cooker goes to Standby mode and the display indicates **OFF**.
3. Place and close the lid as described in [Pressure Control Features—Pressure Cooking Lid](#).
4. Press **Yogurt** to select the Yogurt Smart Program.
5. Press **Yogurt** again to cycle to the **More** option. The display indicates **boil**.
6. After **10 seconds** the cooker begins heating.
7. When pasteurization completes, the display indicates **End**.
8. Remove the lid and use a thermometer to check the temperature.

Note: Milk must reach a minimum of 72°C (161°F) for pasteurization to occur.

Add Starter Culture

1. Allow pasteurized milk to cool to just below 43°C (110°F).
2. Add a starter culture to the milk according to package instructions.
Note: If using plain yogurt as a starter, ensure that it contains an **active culture**. Mix in 2 tsp of yogurt per gallon of milk, or follow a trusted recipe.
3. Place and close the lid as described in [Pressure Control Features—Pressure Cooking Lid](#).

Recommended Cooking Times

Ferment Yogurt

Setting	Suggested Use	Notes
Less	For lower temperature fermentation (e.g., Jiu Niang, a sweet fermented glutinous rice dessert)	Default fermentation time is 24 hours. Adjust fermentation time based on recipe.
Normal	Fermenting milk after culture has been added	A longer fermentation will result in tangier yogurt. Adjust as desired up to 99 hours and 30 minutes..
More	Pasteurizing milk	Pasteurization time is preset and cannot be adjusted. Display indicates boiL while program is running. For extra thick yogurt, pasteurize milk twice.

1. Press **Yogurt** to select the Yogurt Smart Program.
2. Press **Yogurt** again to cycle to the Normal option.
The display indicates **08:00**.
3. Use the **- / +** buttons to adjust the fermentation time if desired.
4. After **10 seconds** the cooker begins heating. The display timer counts up to the set time from **00:00**.
5. When fermentation completes, the cooker beeps and displays **End**.

Yogurt Cups

Yogurt cups are a convenient way to portion out your yogurt for serving.

1. After adding the starter culture to the pasteurized milk, carefully pour the milk into your yogurt cups and seal them tightly.
2. Clean the inner pot thoroughly and place the steam rack on the bottom of the inner pot.
3. Place the sealed yogurt cups on the steam rack and add water to the inner pot until the cups are submerged halfway.
4. Follow steps in "Ferment Yogurt" above.

Care and Cleaning

Clean your Duo after each use.

Always unplug your Duo and let it cool to room temperature before cleaning.

Let all surfaces dry thoroughly before use, and before storage.

Part	Instruction	Cleaning Method
Accessories <ul style="list-style-type: none">• Steam Rack• Condensation Collector	<ul style="list-style-type: none">• Wash after each use.• Never use harsh chemical detergents, powders or scouring pads on accessories.• For dishwasher, place on top rack.• Empty and rinse condensation collector after each use.	Dishwasher Safe* and Hand Washable
Lid and Parts <ul style="list-style-type: none">• Anti-Block Shield• Sealing Ring• Steam Release Valve• Float Valve• Silicone Cap	<ul style="list-style-type: none">• Wash after each use with hot water and mild dish soap and allow to air dry, or place in top rack of dishwasher.• Remove all small parts from lid before washing.• With steam release valve and anti-block shield removed, clean interior of steam release pipe to prevent clogging.• To drain water from the lid after dishwashing, grasp the lid handle and hold the lid vertically over a sink, then turn it 360°—such as turning a steering wheel.• After cleaning, store the lid upside down on the cooker base.• Store sealing rings in a well-ventilated area to decrease residual odor of flavorful meals. To eliminate odors, add 1 cup (8 oz / 250 mL) water and 1 cup (8 oz / 250 mL) white vinegar to inner pot, and run Pressure Cook for 5-10 minutes, then QR pressure.	
Inner Pot	<ul style="list-style-type: none">• More acute hard water staining may require a vinegar-dampened sponge and some scrubbing to remove.• If there is tough or burned food residue at the bottom, soak in hot water for a few hours for easy cleaning.• Wash after each use.• Ensure all exterior surfaces are dry before placing in cooker base.	

**Some discoloration may occur after machine washing, but this will not affect the cooker's safety or performance.*

Care and Cleaning

Part	Instruction	Cleaning Method
Detachable Power Cord (3 and 6 Quart Only)	<ul style="list-style-type: none">Use a barely-damp cloth to wipe any particles off power cord.	Damp Cloth Only
Cooker Base	<ul style="list-style-type: none">Wipe the inside of the outer pot as well as the condensation rim with a barely-damp cloth, and allow to air dry.Clean cooker base and control panel with a soft, barely-damp cloth or sponge.	

WARNING

Ensure heating element remains dry at all times.

Do not immerse cooker base in water or attempt to cycle through dishwasher.

Do not submerge power cord at any time.

Do not wet prongs of power cord.

Troubleshooting

Register your product today.

Contact Customer Care:

1-800-828-7280

support@instantapot.com

instantpot.com/#Chat

Problem	Possible Reason	Solution
Difficulty closing lid	Sealing ring not properly installed	Reposition sealing ring, ensure it is snug behind sealing ring rack.
	Float valve in the popped-up position	Gently press the float valve downward with a long utensil.
	Contents in cooker are still hot	Turn steam release handle to Venting position, then lower lid onto cooker base slowly, allowing heat to dissipate.
Difficulty opening lid	Pressure inside the cooker	Release pressure according to recipe; only open lid after float valve has dropped down.
	Float valve stuck at the popped-up position due to food debris or residue	Ensure steam is completely released by quick releasing pressure, then press float valve gently with a long utensil. Open lid cautiously and thoroughly clean float valve, surrounding area, and lid before next use.
	 WARNING Contents may be under pressure; to avoid scalding injury, do not attempt to force lid open.	
Inner pot is stuck to lid when cooker is opened	Cooling of inner pot may create suction, causing inner pot to adhere to the lid	To release the vacuum, turn steam release handle to Venting position.
Steam leaks from side of lid	No sealing ring in lid	Install sealing ring.
	Sealing ring damaged or not properly installed	Replace sealing ring.
	Food debris attached to sealing ring	Remove sealing ring and clean thoroughly.
	Lid not closed properly	Open, then close lid.
	Sealing ring rack is warped or off-centre	Remove sealing ring from lid, check sealing ring rack for bends or warps. Contact Customer Care .
	Inner pot rim may be misshapen	Check for deformation and contact Customer Care .



Troubleshooting

Problem	Possible Reason	Solution
Float valve does not rise	Food debris on float valve or float valve silicone cap	Remove float valve from lid and clean thoroughly; perform Initial Test Run to check for function and record findings. Contact Customer Care .
	Too little liquid in the inner pot	Check for scorching on bottom of inner pot. Add thin, water-based liquid to the inner pot according to its size: 3 Quart: 1 cup / 250 mL 6 Quart: 1 1/2 cups / 375 mL 8 Quart: 2 cups / 500 mL
	Silicone cap damaged or missing	Install or replace float valve.
	Float valve obstructed by lid-locking mechanism	Tap float valve with a long utensil. If the float valve does not drop, turn the cooker off. Contact Customer Care .
	No heat in the inner pot	Perform Initial Test Run to check for function and record findings. Contact Customer Care .
	Inner pot base may be damaged	Perform Initial Test Run to check for function and record findings. Contact Customer Care .
Minor steam leaking/hissing from steam release during cook cycle	Steam release handle not in Sealing position	Turn steam release handle to Sealing position.
	Cooker is regulating excess pressure	This is normal; no action required.
Steam gushes from steam release when steam release handle is in Sealing position	Not enough liquid in the inner pot	Add thin, water-based liquid to the inner pot according to its size: 3 Quart: 1 cup / 250 mL 6 Quart: 1 1/2 cups / 375 mL 8 Quart: 2 cups / 500 mL
	Pressure sensor control failure	Contact Customer Care .
	Steam release valve not seated properly	Turn steam release handle and ensure it is in Sealing position.
Display remains blank after connecting the power cord	Bad power connection or no power	Inspect power cord for damage. If damage is noticed, contact Customer Care . Check outlet to ensure it is powered.
	Cooker's electrical fuse has blown	Contact Customer Care .

Troubleshooting

Problem	Possible Reason		Solution
Error code appears on display and cooker beeps continuously	C1 C2 C6 C6H C6L	Faulty sensor	Contact Customer Care: 1-800-828-7280 support@instantapot.com instantpot.com/#Chat
	C5	Temperature is too high because inner pot is not placed in the cooker base	Press Cancel and wait for heating element to cool; ensure there are no foreign objects in cooker base; insert or reposition inner pot in cooker base and re-enter commands.
		Temperature is too high because there is no water in inner pot	Check for scorching on bottom of inner pot. Add thin, water-based liquid to the inner pot according to its size: 3 Quart: 1 cup / 250 mL 6 Quart: 1 1/2 cups / 375 mL 8 Quart: 2 cups / 500 mL
	C7 or NoPr	Heat element has failed	Contact Customer Care
		Not enough liquid	Add thin, water-based liquid to the inner pot according to its size: 3 Quart: 1 cup / 250 mL 6 Quart: 1 1/2 cups / 375 mL 8 Quart: 2 cups / 500 mL
		Steam release handle is in the Venting position	Turn steam release handle to Sealing position.
	Lid	Lid is not in the correct position for the selected program	Open and close the lid. Do not use a lid when using Sauté .
	OvHt / Burn / Food burn	High temperature detected at bottom of inner pot; cooker automatically reduces temperature to avoid overheating	Starch deposits at the bottom of the inner pot may have blocked heat dissipation. Turn the cooker off, release pressure according to the recipe, and inspect the bottom of the inner pot.
	PrSE	Pressure has accumulated during a non-pressure cooking program	Turn steam release handle to Venting position.
	Occasional clicking or light cracking sound	The sound of power switching and expanding pressure board when changing temperatures	
Bottom of the inner pot is wet		Wipe exterior surfaces of inner pot. Ensure heating element is dry before inserting inner pot into cooker base.	



Warranty

Limited Warranty

This Limited Warranty is effective for one year from the date of original consumer purchase. Proof of original purchase date and, if requested by an authorized representative of Instant Brands Inc. ("Instant Brands"), return of your appliance, is required to obtain service under this Limited Warranty. Provided that this appliance is operated and maintained in accordance with written instructions attached to or furnished with the appliance, Instant Brands will, in its sole and exclusive discretion, either: (i) repair defects in materials or workmanship; or (ii) replace the appliance. In the event that your appliance is replaced, the Limited Warranty on the replacement appliance will expire 12 months from the date of original consumer purchase.

This Limited Warranty extends only to the original purchaser and use of the appliance in the United States of America and Canada. This warranty does not cover units that are used outside of the United States of America and Canada.

Any modification or attempted modification to your appliance may interfere with the safe operation of the appliance and will void this Limited Warranty. This Limited Warranty does not apply in respect of any appliance or any part thereof that has been altered or modified unless such alterations or modifications were expressly authorized by an Instant Brands representative.

Limitation and Exclusions

The liability of Instant Brands, if any, for any allegedly defective appliance or part shall in no circumstances exceed the purchase price of a comparable replacement appliance.

This Limited Warranty does not cover:

1. Damage resulting from accident, alteration, misuse, abuse, neglect, unreasonable use, use contrary to the operating instructions, normal wear and tear, commercial use, improper assembly, disassembly, failure to provide reasonable and necessary maintenance, fire, flood, acts of God or repair by anyone unless directed by an Instant Brands Representative;
2. Repairs where your appliance is used for other than normal, personal use or when it is used in a manner that is contrary to published user or operator instructions; or
3. Use of unauthorized parts and accessories, or repairs to parts and systems resulting from unauthorized repairs or modifications made to this appliance.

The cost of repair or replacement under these excluded circumstances shall be paid by you.

Warranty

Disclaimer of Implied Warranties

EXCEPT AS EXPRESSLY PROVIDED HEREIN AND TO THE EXTENT PERMITTED BY LAW, INSTANT BRANDS MAKES NO WARRANTIES, CONDITIONS OR REPRESENTATIONS, EXPRESS OR IMPLIED, BY STATUTE, USAGE, CUSTOM OF TRADE OR OTHERWISE WITH RESPECT TO THE APPLIANCES OR PARTS COVERED BY THIS WARRANTY, INCLUDING BUT NOT LIMITED TO, WARRANTIES, CONDITIONS, OR REPRESENTATIONS OF WORKMANSHIP, MERCHANTABILITY, MERCHANTABILITY QUALITY, FITNESS FOR A PARTICULAR PURPOSE OR DURABILITY.

Some states or provinces do not allow for the exclusion of implied warranties of merchantability or fitness, so this limitation may not apply to you. In these states and provinces, you have only the implied warranties that are expressly required to be provided in accordance with applicable law.

Limitation of Remedies; Exclusion of Incidental and Consequential Damage

YOUR SOLE AND EXCLUSIVE REMEDY UNDER THIS LIMITED WARRANTY SHALL BE APPLIANCE REPAIR OR REPLACEMENT AS PROVIDED HEREIN. INSTANT BRANDS SHALL NOT BE LIABLE FOR INDIRECT, INCIDENTAL OR CONSEQUENTIAL DAMAGES ARISING OUT OF OR IN CONNECTION WITH THE USE OR PERFORMANCE OF THE APPLIANCE OR DAMAGES WITH RESPECT TO ANY ECONOMIC LOSS, PERSONAL INJURY, LOSS OF PROPERTY, LOSS OF REVENUES OR PROFITS, LOSS OF ENJOYMENT OR USE, COSTS OF REMOVAL, INSTALLATION OR OTHER INDIRECT, INCIDENTAL OR CONSEQUENTIAL DAMAGES OF ANY NATURE OR KIND.

Warranty Registration

Please visit www.instantpot.com/support/register to register your new Instant Brands™ appliance and validate your warranty within thirty (30) days of purchase. You will be asked to provide the store name, date of purchase, model number (found on the back of your appliance) and serial number (found on the bottom of your appliance) along with your name and email address. The registration will enable us to keep you up to date with product developments, recipes and contact you in the unlikely event of a product safety notification. By registering, you acknowledge that you have read and understand the instructions for use, and warnings set forth in the accompanying instructions.

Warranty Service

To obtain service under this warranty, please contact our Customer Service Department by phone at 1-800-828-7280 or by email to support@instantpot.com. You can also create a support ticket online at www.instantpot.com/support. If we are unable to resolve the problem, you may be asked to send your appliance to the Service Department for quality inspection. Instant Brands is not responsible for shipping costs related to warranty service, save and except for shipping costs associated with the return of your appliance from Canada or within the 48 contiguous states and the District of Columbia of the United States of America, as provided herein. When returning your appliance, please include your name, mailing address, email address, phone number, and proof of the original purchase date as well as a description of the problem you are encountering with the appliance.



Instant Pot®

Instant Brands Inc.
11-300 Earl Grey Dr., Suite 383
Ottawa, Ontario
K2T 1C1
Canada

Register your product today:
instantpot.com/support/register

Contact Information:

[1-800-828-7280](tel:1-800-828-7280)

support@instantpot.com

instantpot.com/#Chat

instantpot.com

store.instantpot.com

Copyright © 2019 Instant Brands™ Inc

602-0101-93

