

COSORI®

User Manual

Original Air Fryer Toaster Oven

Model Line: CO130-AO
Models: CO130-AO, CO130-AO-RXS

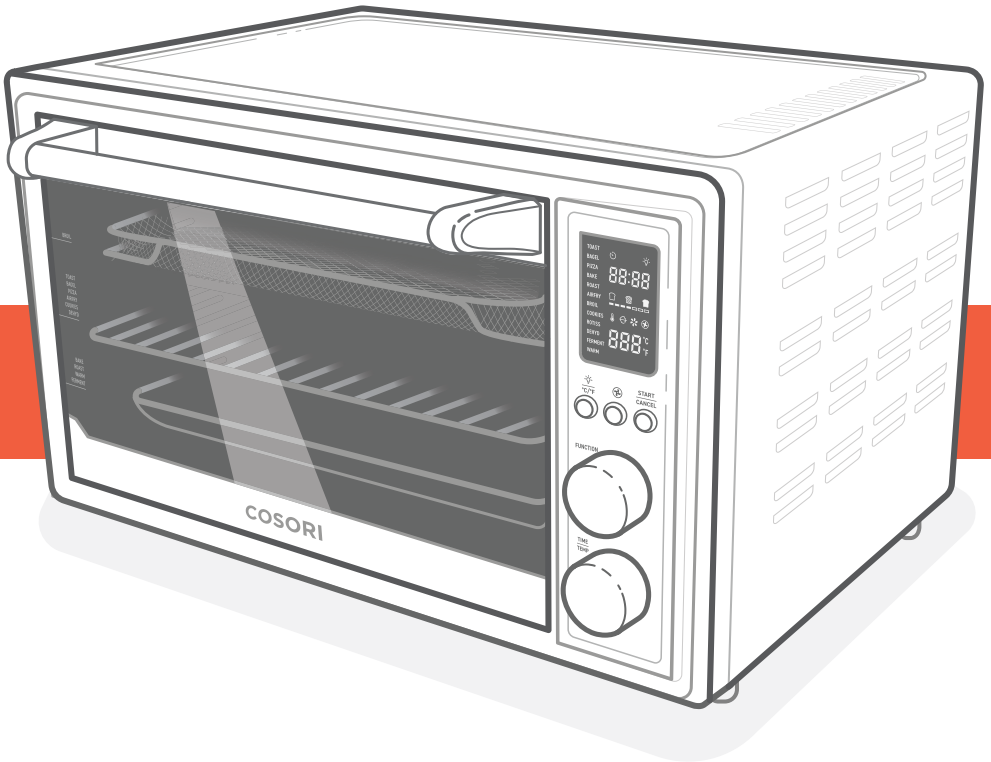

Questions or Concerns?

Mon-Fri, 9:00 am-5:00 pm PST/PDT
support@cosori.com | (888) 402-1684



Thank you for
your purchase!



(We hope you love your new air fryer toaster oven as much as we do.)



join

the Cosori Cooks Community on Facebook
[facebook.com/groups/cosoricooks](https://www.facebook.com/groups/cosoricooks)



explore

our recipe gallery
www.cosori.com/recipes



enjoy

weekly, featured recipes
made exclusively by our in-house chefs



CONTACT OUR CHEFS

Our helpful, in-house chefs are ready to assist you with any questions you might have!

Email: recipes@cosori.com

Toll-Free: (888) 402-1684

M-F, 9:00 am–5:00 pm PST/PDT

On behalf of all of us at Cosori,

Happy cooking!

Table of Contents

Package Contents	3
Specifications	3
Important Safeguards	4
• Key Safety Points	4
• General Safety	4
• While Air Frying	5
• Power & Cord	5
Getting to Know Your Air Fryer Toaster Oven	6
Display	7
Controls	8
• Light/Unit Button	8
• Fan Button	8
• START/CANCEL Button	8
• FUNCTION Knob	8
• TIME/TEMP Knob	8
Before First Use	9
• Setting Up	9
• Test Run	9
Cooking with Your Air Fryer Toaster Oven	10
• Convection Fan	12
• Automatic Preheat	12
• Toast Function (“TOAST”)	13
• Bagel Function (“BAGEL”)	14
• Pizza Function (“PIZZA”)	15
• Bake Function (“BAKE”)	16
• Roast Function (“ROAST”)	17
• Air Fry Function (“AIRFRY”)	18
• Broil Function (“BROIL”)	19
• Cookies Function (“COOKIES”)	20
• Rotisserie Function (“ROTISS”)	21
• Dehydrate Function (“DEHYD”)	22
• Ferment Function (“FERMENT”)	23
• Warm Function (“WARM”)	24
Care & Maintenance	25
Troubleshooting	26
Warranty Information	27
Customer Support	28

Package Contents

1 x Original Air Fryer Toaster Oven
1 x Wire Rack
1 x Food Tray
1 x Crumb Tray
1 x Fry Basket
1 x Rotisserie Fork Set
1 x Rotisserie Handle
1 x Recipe Book
1 x User Manual
1 x Quick Reference Guide

Specifications

Power Supply	AC 120V, 60Hz
Rated Power	1800W
Capacity	Approx. 32 qt / 30 L, 6-Slice Toaster, 13" Pizza
Temperature Range	80°–450°F / 27°–232°C
Time Range	0–24 hr
Weight	19.6 lb / 8.9 kg (including accessories)
Dimensions	20.1 x 16.5 x 12.1 in / 51 x 42 x 30.8 cm

READ AND SAVE THESE INSTRUCTIONS

IMPORTANT SAFEGUARDS

Follow basic safety precautions when using your air fryer toaster oven.
Read all instructions.

Key Safety Points

- **Do not** touch hot surfaces. Use handle.
- The outside of the oven, including the door, is hot during and after use.
- **Always** use heat-resistant gloves, pads, or oven mitts when handling hot materials, and when placing items in or removing items from the oven, including trays, racks, accessories, or containers.

General Safety

- When the oven is not in use, and before cleaning, press **START/CANCEL** to turn it off, then unplug from outlet. Allow to cool completely before putting on or taking off parts.
- **Do not** immerse the housing, cord, or plug in water or liquid.
- Closely supervise children near the oven.
- **Do not** use your oven if it is damaged, not working, or if the cord or plug is damaged. Contact **Customer Support** (see page 28).
- **Do not** use third-party replacement parts or accessories, as this may cause injuries.
- **Do not** use outdoors.
- **Do not** place the oven or any of its parts on a stove, near gas or electric burners, or inside another heated oven.
- Be extremely cautious when removing a tray, basket, or rack if it contains hot oil, grease, or other hot liquids.
- **Do not** clean with metal scouring pads. Metal fragments can break off the pad and touch electrical parts, creating a risk of electric shock.
- Clean the crumb tray after using. Accumulated grease and crumbs can overheat and catch fire.
- **Do not** store anything on top of your oven while it is operating. **Do not** store anything inside your oven other than recommended accessories.
- **Do not** operate with a separate remote-control system.
- **Only** use as directed in this manual.
- This toaster oven is not intended for use by persons (including children) with reduced physical, sensory, or mental capabilities, or lack of experience and knowledge, unless they have been given supervision or instruction concerning use of the toaster oven by a person responsible for their safety.
- Children should not play with the toaster oven.
- Cleaning and user maintenance should not be made by children without supervision.
- Not for commercial use. Household use **only**.

While Cooking

- **Do not** place oversized foods or metal utensils (except for Cosori accessories) into your oven.
- **Do not** place paper, cardboard, or non-heat-resistant plastic into your oven, or any materials which may catch fire or melt.
- To avoid overheating, **do not** use metal foil in the oven unless directed. Use extreme caution when using foil, and **always** fit foil as securely as possible. If the foil contacts the oven's heating elements, this can cause overheating and risk of fire.
- **Never** put baking or parchment paper into the oven without food on top. Air circulation can cause paper to move and touch heating elements.
- **Always** use heat-safe containers. Be extremely cautious if using containers that aren't metal or glass.
- Keep your oven away from flammable materials (curtains, tablecloths, walls, etc.). Use on a flat, stable, heat-resistant surface away from heat sources or liquids.
- Immediately turn off and unplug your oven if you see dark smoke coming out. Food is burning. Wait for smoke to clear before opening the oven door.

Power & Cord

- Your oven has a 3-prong grounding plug, and should **only** be used with 120V, 60Hz electrical systems in North America. **Always** plug in to a grounded electrical outlet. **Do not** modify the plug in any way.
- **Do not** let the power cord (or any extension cord) hang over the edge of a table or counter, or touch hot surfaces.
- If the power supply cord is damaged, it must be replaced by Arovast Corporation or similarly qualified persons in order to avoid an electric or fire hazard. Please contact **Customer Support** (page 28).

Note: *This oven uses a short power-supply cord to reduce the risk of entangling or tripping. Use extension cords with care. The marked electrical rating of the extension cord must be as great as the rating of the oven (see page 3).*

Electromagnetic Fields (EMF)

This oven complies with all standards regarding electromagnetic fields (EMF). If handled properly and according to the instructions in this user manual, the appliance is safe to use based on scientific evidence available today.

GETTING TO KNOW YOUR AIR FRYER TOASTER OVEN

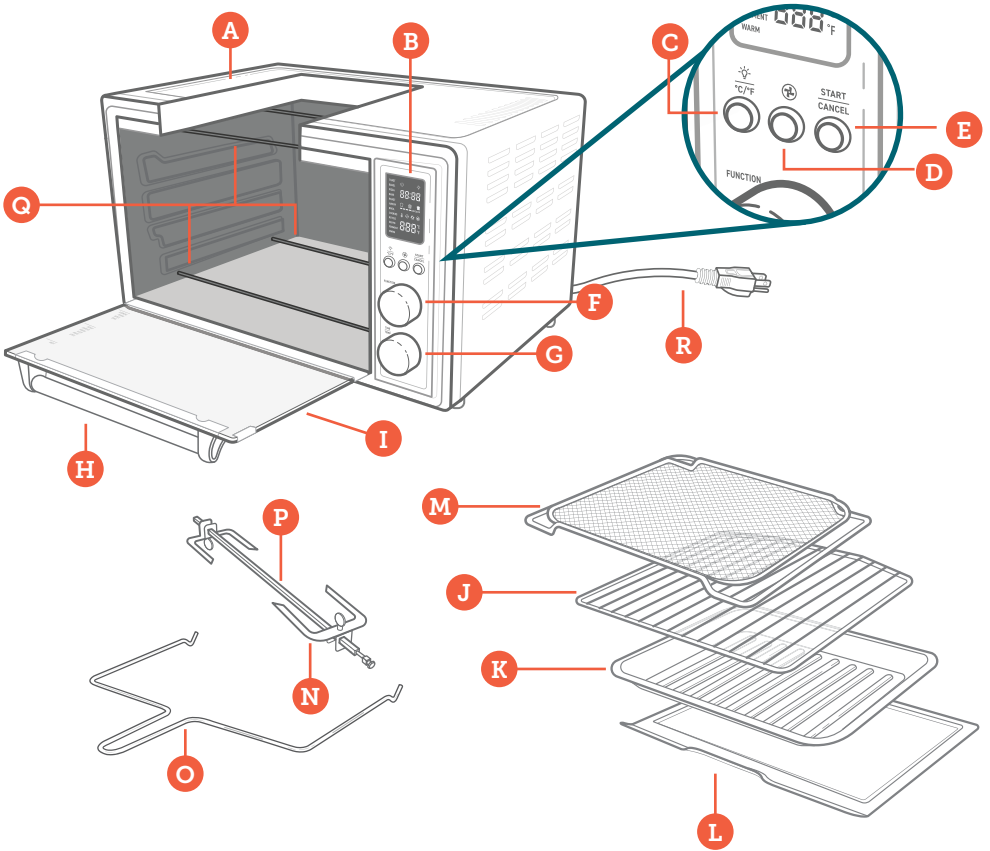

- | | | |
|-------------------------------|--------------------------|-----------------------------|
| A. Housing | G. TIME/TEMP Knob | M. Fry Basket |
| B. LED Display | H. Handle | N. Rotisserie Forks |
| C. Light/Unit Button | I. Door | O. Rotisserie Handle |
| D. Fan Button | J. Wire Rack | P. Rotisserie Shaft |
| E. START/CANCEL Button | K. Food Tray | Q. Heating Elements |
| F. FUNCTION Knob | L. Crumb Tray | R. Power Cord |

DISPLAY

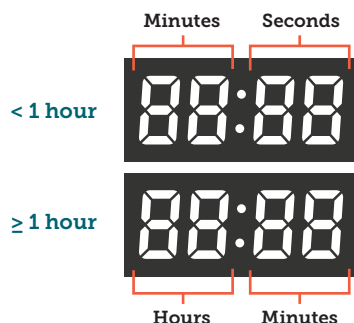
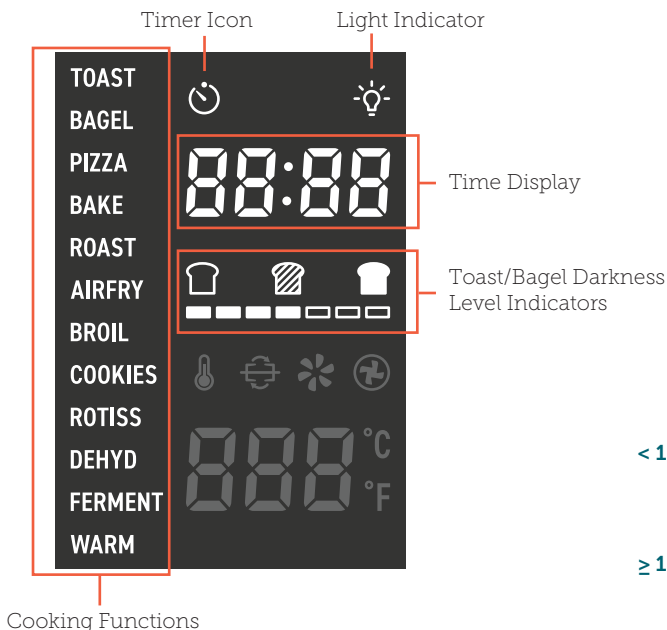

Temperature Icon

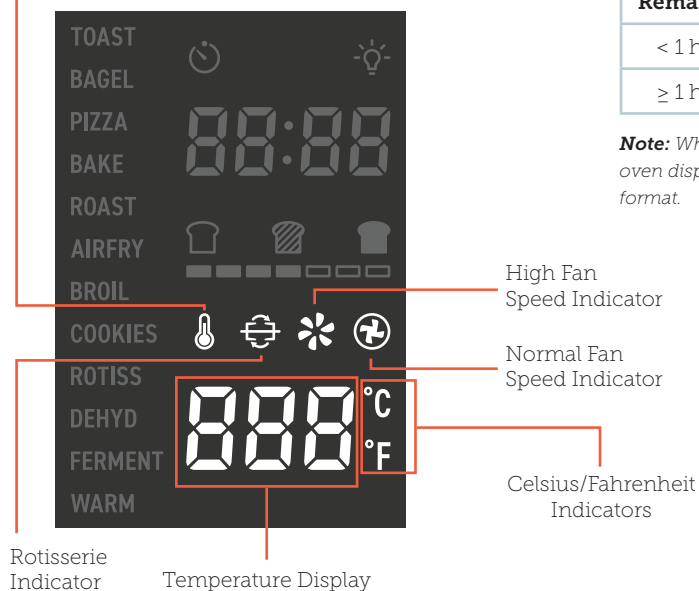

Cook Time Remaining	Display Format
< 1 hour	Minutes : Seconds
≥ 1 hour	Hours : Minutes

Note: When you're setting cook times, the oven display will use the Hours: Minutes format.

CONTROLS

Light/Unit Button

- Turns the interior light on/off.  will show on the display.
- The interior light will turn on automatically when there is 1 minute left of cooking time. Press to turn the light back off.
- Press and hold to switch temperature units between Fahrenheit and Celsius.

Fan Button

- Cycles through fan speeds: normal, high, and off.
- The fan can be used for all cooking functions except Toast and Bagel. The fan is automatically set during Air Fry and Dehydrate.

START/CANCEL Button

- Starts or cancels a cooking function.
- If preheating, cancels preheating and starts the cooking function.
- Blinks when the oven is preheating or has finished preheating. Press the button again to start the cooking function.
- Lights up when the oven is heating.

FUNCTION Knob

- Turn the knob to choose a cooking function. The selected function will blink on the display.

TIME/TEMP Knob

- Turn the knob to change time/temperature. Turn clockwise to increase, and counterclockwise to decrease.
- Press the knob to switch between controlling time and temperature. By default, the knob will control time.
- Time will adjust in increments of +/- 1, 5, 10, or 15 minutes (see chart).
- Temperature will adjust in increments of +/- 5°F.
- After a time or temperature setting is selected, the number will flash 5 times on the display before the setting is confirmed.
- **Display On/Off:** Press and hold the knob until the display turns on/off.

Time Increment Chart

Pizza, Bake, Roast, Air Fry, Broil, Cookies, Rotisserie, Warm	
Below 60 minutes	+/- 1-minute increments
1–2 hours	+/- 5-minute increments
2–3 hours	+/- 10-minute increments
Above 3 hours	+/- 15-minute increments
Dehydrate, Ferment	
All times	+/- 30-minute increments

Note:

- *If the oven is inactive for 30 minutes, it will turn off automatically. Use any control to wake up the oven.*

BEFORE FIRST USE

Setting Up

1. Remove all packaging around and inside the oven.
2. Place on a stable, level, heat-resistant surface, away from anything that can be damaged by heat.
3. Wash all accessories and clean the oven's interior (see page 25). Dry and place accessories back in oven.

Test Run

A test run will help you become familiar with your oven, make sure it's working correctly, and clean it of possible residues in the process.

1. Make sure there is no food or packaging in the oven and plug it in.
2. Turn the **FUNCTION** knob to "**TOAST**" and turn the **TIME/TEMP** knob to Level 7.
3. Press **START/CANCEL** to begin heating. The button will light up, and the display will show the timer counting down.
4. The oven will stop heating and beep several times when finished.

COOKING WITH YOUR AIR FRYER TOASTER OVEN

CAUTION:

- The outer surface of the oven, including the oven door, is hot during and after use. Temperature may be over 212°F / 100°C. **Do not** touch hot surfaces. Use handle.
- **Always** use heat-resistant gloves, pads, or oven mitts when handling hot materials, and when placing items in or removing items from the oven.

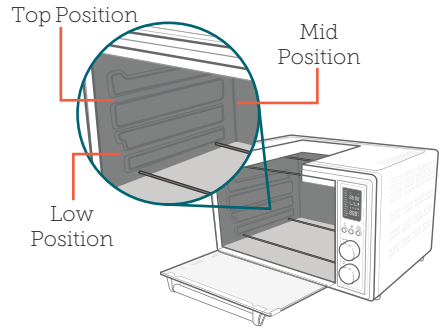

Note: *Always* leave the crumb tray at the bottom of the oven when cooking for easier cleanup.

Cooking Functions Quick Reference Chart

Name	Use	Suggested Accessory & Position	Range
Toast "TOAST"	<ul style="list-style-type: none"> • Toast or brown bread • Manually preheat oven • Defrost food 	Wire rack at mid position	<ul style="list-style-type: none"> • Darkness Level 1–7 • Temperature is automatic
Bagel "BAGEL"	<ul style="list-style-type: none"> • Toast bagels or crumpets • Toast any bread that requires one side to be more toasted than the other • When toasting bagels, place the inside (cut side) facing upwards. The top side will be toasted more than the bottom side 	Wire rack at mid position	<ul style="list-style-type: none"> • Darkness Level 1–7 • Temperature is automatic
Pizza "PIZZA"	<ul style="list-style-type: none"> • Melt and brown cheese and toppings while crisping crust • Includes automatic preheat 	Wire rack at mid position	<ul style="list-style-type: none"> • 150°–450°F / 66°–232°C • 1 min–6 hr
Bake "BAKE"	<ul style="list-style-type: none"> • Cook foods evenly throughout • Bake cakes, muffins, pastries • Includes automatic preheat 	Food tray or wire rack at low position	<ul style="list-style-type: none"> • 150°–450°F / 66°–232°C • 1 min–6 hr

Name	Use	Suggested Accessory & Position	Range
Roast "ROAST"	<ul style="list-style-type: none"> • Cook a variety of meats and poultry • Food will be tender and juicy on the inside and well-roasted on the outside. • Includes automatic preheat 	Food tray at low position	<ul style="list-style-type: none"> • 150°–400°F / 66°–204°C • 1 min–6 hr
Air Fry "AIRFRY"	<ul style="list-style-type: none"> • Cooks using intense heat and maximized airflow • Cook food such as french fries and chicken wings • Includes automatic preheat 	Fry basket at mid position	<ul style="list-style-type: none"> • 150°–400°F / 66°–204°C • 1 min–6 hr
Broil "BROIL"	<ul style="list-style-type: none"> • Cook open-faced sandwiches, thin cuts of meat (such as bacon), poultry, fish, sausages, and vegetables • Brown the tops of casseroles, gratins, and desserts • Includes automatic preheat 	Food tray at top position	<ul style="list-style-type: none"> • 150°–450°F / 66°–232°C • 1 min–6 hr
Cookies "COOKIES"	<ul style="list-style-type: none"> • Bake cookies and other baked treats • Includes automatic preheat 	Food tray or wire rack at mid position	<ul style="list-style-type: none"> • 150°–450°F / 66°–232°C • 1 min–6 hr
Rotisserie "ROTISS"	<ul style="list-style-type: none"> • Cook rotating roasts, such as a whole chicken 	Rotisserie slots Note: Also requires food tray at low position to collect drippings.	<ul style="list-style-type: none"> • 150°–400°F / 66°–204°C • 1 min–6 hr
Dehydrate "DEHYD"	<ul style="list-style-type: none"> • Evenly dry out foods without cooking • Dry fruit or vegetable chips 	Wire rack or fry basket at mid position	<ul style="list-style-type: none"> • 100°–180°F / 38°–82°C • 30 min–24 hr
Ferment "FERMENT"	<ul style="list-style-type: none"> • Precisely hold low temperatures • Proof bread, rolls, pizza, and dough • Make yogurt 	Food tray or wire rack at low position	<ul style="list-style-type: none"> • 80°–110°F / 27°–43°C • 30 min–12 hr
Warm "WARM"	<ul style="list-style-type: none"> • Keep food warm at the recommended temperature to prevent bacterial growth (160°F / 71°C or above) 	Food tray or wire rack at low position	<ul style="list-style-type: none"> • 140°–230°F / 60°–110°C • 1 min–12 hr

Convection Fan

The fan circulates hot air in the oven for faster and more even cooking. Use the high fan speed (super convection) for crispier results, and for air frying. You can turn the fan on and off at any time during cooking.

Note: The fan cannot be used for the Toast or Bagel functions. Fan speed is set automatically for the Air Fry and Dehydrate functions.

Automatic Preheat

Pizza, Bake, Roast, Broil, Cookies, and Air Fry all use automatic preheat.

1. When you start the cooking function by pressing **START/CANCEL**, preheating will start automatically. The START/CANCEL button will light up, and the display will show "PPE". [Figure 1.1]
 - Pressing **START/CANCEL** again during preheating will cancel preheating and immediately start cooking.

2. When preheating is finished, the oven will beep several times and the display will flash. This will repeat once every minute. The START/CANCEL button will blink continuously until pressed again.
 - After 10 minutes of inactivity, the cooking function will cancel, the oven will stop heating, and the display will reset.
3. Press **START/CANCEL** to begin cooking. The button will light up, and the display will show the timer counting down.
 - Preheating times vary based on the temperature setting (see chart).

Setting Temperature	Automatic Preheat Time
300°F / 149°C and below	2–4 min
325°F / 163°C	3–5 min
350°F / 177°C	4–6 min
400°F / 204°C and above	6–8 min

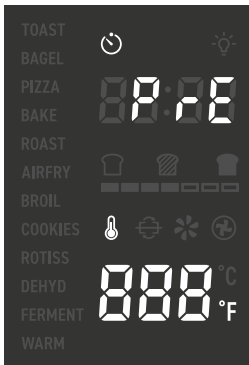

Figure 1.1

Toast Function (“TOAST”)



This function browns the outside of your bread while keeping the inside soft. Also ideal for English muffins and frozen waffles.

Can be used to manually preheat the oven or defrost food. Use Level 4 or higher.

Heating Elements: Top and bottom heating elements cycle on and off.

Rack Position: Mid

1. Place up to 6 slices of bread on the wire rack. Insert the wire rack at mid position and close the oven door.
2. Turn the **FUNCTION** knob to “**TOAST**”, which will blink on the display.
3. Optionally, customize the darkness level. You can only do this before cooking starts.
 - a. Turn the **TIME/TEMP** knob to adjust the darkness level between 1–7. The bars underneath the toast icons indicate the darkness level.
 - b. Use 1–2 for a light toast, 3–5 for a medium toast, and 6–7 for a dark toast.

Note:

- When setting the darkness level, consider the type, thickness, and freshness of the bread.
 - Try lighter settings for raisin toast, white bread, and thinly-sliced bread.
 - Try darker settings for rye, whole wheat, heavier-textured bread, and fresh bread.
- Time and temperature are set automatically. Time increases with darkness level. Temperature is set to the highest level (450°F / 232°C). The display will show “**HI**”.

4. Press **START/CANCEL** to begin. The button will light up, and the display will show the timer counting down.
5. The oven will stop heating and beep several times when finished.

Bagel Function (“BAGEL”)



This function crisps the inside of a cut bagel while lightly toasting the outside.

Also ideal for toasting crumpets or thick-sliced specialty breads which require one side to be more toasted than the other.

Heating Elements: Top heating elements cycle on and off, and bottom heating elements are half on and half off.

Rack Position: Mid

1. Slice the bagel in half. Center the halves on the wire rack. Insert the wire rack at mid position and close the oven door.

Note: This function toasts more on the top than the bottom. The inside (cut side) of the bagel should face upwards for best results.

2. Turn the **FUNCTION** knob to “**BAGEL**”, which will blink on the display.

3. Optionally, customize the darkness level. You can only do this before cooking starts.
 - a. Turn the **TIME/TEMP** knob to adjust the darkness level between 1–7. The bars underneath the toast icons indicate the darkness level.
 - b. Use 1–2 for a light toast, 3–5 for a medium toast, and 6–7 for a dark toast.

Note:

- When setting the darkness level, consider the type, thickness, and freshness of the bagel.
 - Try lighter settings for bagels that are white, light-textured, thinner, or have raisins.
 - Try darker settings for bagels that are fresh or have a heavier texture.
- Time and temperature are set automatically. Time increases with darkness level.

4. Press **START/CANCEL** to begin. The button will light up, and the display will show the timer counting down.
5. The oven will stop heating and beep several times when finished.

Pizza Function (“PIZZA”)

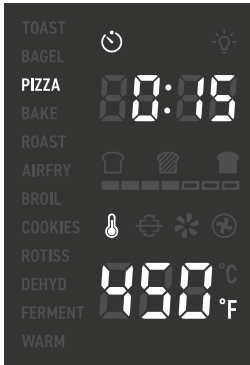

This function melts and browns cheese and toppings, while crisping crust.

Heating Elements: Top and bottom heating elements cycle on and off.

Rack Position: Mid

1. Insert wire rack at mid position and close the oven door.
2. Turn the **FUNCTION** knob to “**PIZZA**”, which will blink on the display.
3. Optionally, customize the temperature and time. You can do this anytime during cooking (except during preheating).
 - a. Turn the **TIME/TEMP** knob to adjust the time between 1 min–6 hr.
 - b. Press the **TIME/TEMP** knob once to control temperature. Turn the knob to adjust the temperature between 150°–450°F / 66°–232°C.

Note: Try a slightly longer cooking time for pizzas with thicker crust, and an even longer cooking time for frozen pizzas.

4. Press **START/CANCEL** to begin. Preheating will start automatically. The START/CANCEL button will light up, and the display will show “**PRE**”.

Note: Pressing **START/CANCEL** again during preheating will cancel preheating and immediately start cooking.

5. When preheating is finished, the oven will beep several times, the display will flash, and the START/CANCEL button will blink continuously.
6. Remove any cardboard, plastic, paper, or other flammable materials. Place pizza on a pan, and place the pan on the wire rack. Close the oven door.
7. Press **START/CANCEL** to begin cooking. The button will light up, and the display will show the timer counting down.

Note: For large pizzas, open the oven door halfway through cooking and carefully turn the pizza 90 degrees for more even browning.

8. The oven will stop heating and beep several times when finished.

Bake Function (“BAKE”)

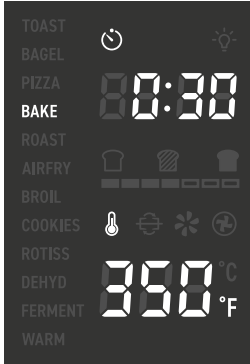

This function cooks food evenly throughout. Ideal for baking cakes, muffins, brownies, and pastries. Also ideal for cooking pre-packaged frozen meals, including lasagna and pot pies.

Heating Elements: Top and bottom heating elements cycle on and off.

Rack Position: Low

1. If using the wire rack, insert at low position and close the oven door.
2. Turn the **FUNCTION** knob to **“BAKE”**, which will blink on the display.
3. Optionally, customize the temperature and time. You can do this anytime during cooking (except during preheating).
 - a. Turn the **TIME/TEMP** knob to adjust the time between 1 min–6 hr.
 - b. Press the **TIME/TEMP** knob once to control temperature. Turn the knob to adjust the temperature between 150°–450°F / 66°–232°C.
4. Press **START/CANCEL** to begin. Preheating will start automatically. The START/CANCEL button will light up, and the display will show **“PRE”**.

Note: Pressing **START/CANCEL** again during preheating will cancel preheating and immediately start cooking.

5. When preheating is finished, the oven will beep several times, the display will flash, and the START/CANCEL button will blink continuously.
6. Place food inside oven. If using the food tray, insert at low position. Close the oven door.

Note:

- Citric acid (from oranges, lemons, and other foods) may damage the porcelain enamel finish of the trays or racks. Line the trays with foil or baking paper.
 - Use extreme caution when using foil, and **always** fit foil as securely as possible. To avoid overheating and risk of fire, make sure foil does not contact the heating elements.
7. Press **START/CANCEL** to begin cooking. The button will light up, and the display will show the timer counting down.
 8. The oven will stop heating and beep several times when finished.

Roast Function (“ROAST”)

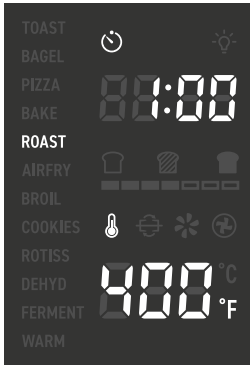

This function is ideal for cooking a variety of meats and poultry. Food will be tender and juicy on the inside and well-roasted on the outside.

Heating Elements: Top and bottom heating elements cycle on and off.

Rack Position: Low

1. If using the wire rack, insert at low position and close the oven door.
2. Turn the **FUNCTION** knob to “**ROAST**”, which will blink on the display.
3. Optionally, customize the temperature and time. You can do this anytime during cooking (except during preheating).
 - a. Turn the **TIME/TEMP** knob to adjust the time between 1 min–6 hr.
 - b. Press the **TIME/TEMP** knob once to control temperature. Turn the knob to adjust the temperature between 150°–400°F / 66°–204°C.
4. Press **START/CANCEL** to begin. Preheating will start automatically. The START/CANCEL button will light up, and the display will show “**PRE**”.

Note: Pressing **START/CANCEL** again during preheating will cancel preheating and immediately start cooking.

5. When preheating completes, the oven will beep several times, the display will flash, and the START/CANCEL button will blink continuously.
6. Place food inside the oven. If using the food tray, insert at low position. Close the oven door.

Note:

- Citric acid (from oranges, lemons, and other foods) may damage the porcelain enamel finish of the trays or racks. Line the trays with foil or baking paper.
 - Use extreme caution when using foil, and **always** fit foil as securely as possible. To avoid overheating and risk of fire, make sure foil does not contact the heating elements.
7. Press **START/CANCEL** to begin cooking. The button will light up, and the display will show the timer counting down.
 8. The oven will stop heating and beep several times when finished.

Air Fry Function (“AIRFRY”)

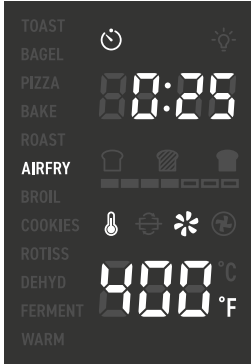

This function is ideal for cooking a variety of food, including french fries and chicken wings. Uses intense heat and maximized airflow.

Heating Elements: Top, bottom, and side heating elements cycle on and off.

Note: Side heating elements are on the right side of the oven, and are not visible.

Rack Position: Mid

1. Turn the **FUNCTION** knob to “**AIRFRY**”, which will blink on the display.
2. Optionally, customize the temperature and time. You can do this anytime during cooking (except during preheating).
 - a. Turn the **TIME/TEMP** knob to adjust the time between 1 min–6 hr.
 - b. Press the **TIME/TEMP** knob once to control temperature. Turn the knob to adjust the temperature between 150°–400°F / 66°–204°C.
3. Press **START/CANCEL** to begin. Preheating will start automatically. The START/CANCEL button will light up, and the display will show “**PRE**”.

Note: Pressing **START/CANCEL** again during preheating will cancel preheating and immediately start cooking.

4. When preheating completes, the oven will beep several times, the display will flash, and the START/CANCEL button will blink continuously.
5. Place food in the fry basket.
 - a. When air frying fatty foods (such as chicken wings), use the food tray instead to prevent oil dripping. Discard excess oil between batches.
6. Insert at mid position and close the oven door.
7. Press **START/CANCEL** to begin cooking. The button will light up, and the display will show the timer counting down.
8. The oven will stop heating and beep several times when finished.

Broil Function (“BROIL”)

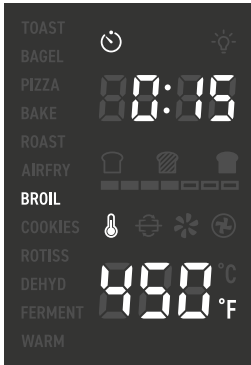

This function is ideal for cooking open-faced sandwiches, thin cuts of meat (such as bacon), poultry, fish, sausages, and vegetables.

Can also be used to brown the tops of casseroles, gratins, and desserts.

Heating Elements: Top heating elements stay on for 5 min, then cycle on and off. Bottom heating elements are half on and half off.

Rack Position: Top

1. Turn the **FUNCTION** knob to “**BROIL**”, which will blink on the display.
2. Optionally, customize the temperature and time. You can do this anytime during cooking (except during preheating).
 - a. Turn the **TIME/TEMP** knob to adjust the time between 1 min–6 hr.
 - b. Press the **TIME/TEMP** knob once to control temperature. Turn the knob to adjust the temperature between 150°–450°F / 66°–232°C.
3. Press **START/CANCEL** to begin. Preheating will start automatically. The START/CANCEL button will light up, and the display will show “**PPE**”.

Note: Pressing **START/CANCEL** again during preheating will cancel preheating and immediately start cooking.

4. When preheating completes, the oven will beep several times, the display will flash, and the START/CANCEL button will blink continuously.
5. Place food on the food tray.
 - a. Optionally, lightly grease the enamel food tray or line with foil to prevent food from sticking.
 - b. Use extreme caution when using foil, and **always** fit foil as securely as possible. To avoid overheating and risk of fire, make sure foil does not contact the heating elements.
6. Insert the food tray at top position and close the oven door.
 - a. Insert at mid position instead for:
 - Bulky foods that may touch the upper heating elements
 - Thicker foods such as burger patties
 - Marinated foods such as chicken wings
 - Foods requiring a gentler broil
7. Press **START/CANCEL** to begin cooking. The button will light up, and the display will show the timer counting down.
8. The oven will stop heating and beep several times when finished.

Cookies Function (“COOKIES”)



This function is ideal for baking homemade or commercially prepared cookies and other baked treats. Also ideal for ready-to-bake crescent rolls, cinnamon rolls, biscuits, and strudels.

Heating Elements: Top and bottom heating elements cycle on and off.

Rack Position: Mid

1. If using the wire rack, insert at mid position and close the oven door.
2. Turn the **FUNCTION** knob to “**COOKIES**”, which will blink on the display.
3. Optionally, customize the temperature and time. You can do this anytime during cooking (except during preheating).
 - a. Turn the **TIME/TEMP** knob to adjust the time between 1 min–6 hr.
 - b. Press the **TIME/TEMP** knob once to control temperature. Turn the knob to adjust the temperature between 150°–450°F / 66°–232°C.

Note: *The amount of dough per cookie may vary the cooking time. Frozen dough will need a longer cooking time.*

4. Press **START/CANCEL** to begin. Preheating will start automatically. The **START/CANCEL** button will light up, and the display will show “**PRE**”.

Note: *Pressing **START/CANCEL** again during preheating will cancel preheating and immediately start cooking.*

5. When preheating is finished, the oven will beep several times, the display will flash, and the **START/CANCEL** button will blink continuously.
6. Place food inside the oven. If using the food tray, insert at mid position. Close the oven door.
 - a. Optionally, lightly grease the enamel food tray or line with baking paper to prevent food from sticking.
 - b. **Never** put baking or parchment paper into the oven without food on top. Air circulation can cause paper to move and touch heating elements.
7. Press **START/CANCEL** to begin cooking. The button will light up, and the display will show the timer counting down.
8. The oven will stop heating and beep several times when finished.

Rotisserie Function (“ROTISS”)

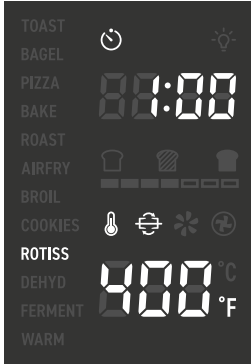

This function is used for rotating roasts. Ideal for roasting a whole chicken.

Heating Elements: Top and bottom heating elements cycle on and off.

Rack Position: Rotisserie slots

1. Turn the **FUNCTION** knob to “**ROTISS**”, which will blink on the display.
2. Optionally, customize the temperature and time. You can do this anytime during cooking.
 - a. Turn the **TIME/TEMP** knob to adjust the time between 1 min–6 hr.
 - b. Press the **TIME/TEMP** knob once to control temperature. Turn the knob to adjust the temperature between 150°–400°F / 66°–204°C.
3. Insert the food tray at low position to collect drippings.
4. Place the whole chicken (or other food item) on the rotisserie shaft. Place the rotisserie forks on either side of the shaft and insert them into the chicken to secure it on the shaft. Tighten the knobs on the forks to secure them.
[Figure 2.1–2.3]
5. Use the rotisserie handle to place the chicken inside the oven, securing both ends of the rotisserie shaft into the rotisserie slots. Close the oven door.

6. Press **START/CANCEL** to begin cooking. The button will light up, and the display will show the timer counting down.
7. The oven will stop heating and beep several times when finished. Use the rotisserie handle to take out the chicken.

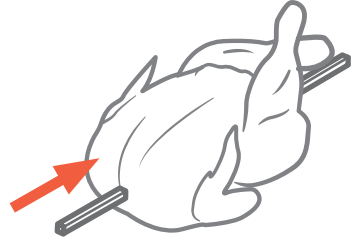

Figure 2.1



Figure 2.2

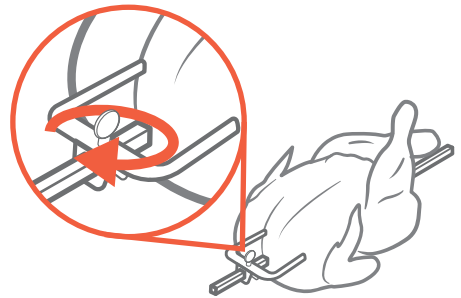

Figure 2.3

Dehydrate Function (“DEHYD”)



This function combines low and stable heat with automatic airflow to evenly dry out foods without cooking. Ideal for drying fruit or vegetable chips.

Heating Elements: Bottom heating elements cycle on and off.

Rack Position: Mid for 1 tray

1. Place food on the wire rack or fry basket.
 - a. When dehydrating foods that may drip, such as marinated jerky, place the food tray in the low rack position to collect drippings.
 - b. Optionally, to prevent staining when dehydrating certain foods (such as beets or marinated meats with dark sauces), line the rack or basket with baking paper.
 - c. **Never** put baking or parchment paper into the oven without food on top. Air circulation can cause paper to move and touch heating elements.
2. Insert wire rack or fry basket at mid position. If using multiple trays, insert at low or high positions. Close the oven door.
3. Turn the **FUNCTION** knob to “**DEHYD**”, which will blink on the display.
4. Optionally, customize the temperature and time. You can do this anytime during cooking.
 - a. Turn the **TIME/TEMP** knob to adjust the time between 30 min–24 hr.
 - b. Press the **TIME/TEMP** knob once to control temperature. Turn the knob to adjust the temperature between 100°–180°F / 38°–82°C.
5. Press **START/CANCEL** to begin dehydrating. The button will light up, and the display will show the timer counting down.
6. The oven will stop heating and beep several times when finished.

Ferment Function (“FERMENT”)



This function is designed to precisely hold low temperatures, providing an ideal environment for proofing bread, rolls, pizza, and dough.

Can also be used for making yogurt with an appropriate recipe (using 110°F / 43°C temperature and 12 hr time).

Heating Elements: Bottom heating elements cycle on and off.

Rack Position: Low

1. Place dough in a heat-safe container. Cover and place on the food tray or wire rack. Insert at low position and close the oven door.
2. Turn the **FUNCTION** knob to **“FERMENT”**, which will blink on the display.
3. Optionally, customize the temperature and time. You can do this anytime during cooking.
 - a. Turn the **TIME/TEMP** knob to adjust the time between 30 min–12 hr.
 - b. Press the **TIME/TEMP** knob once to control temperature. Turn the knob to adjust the temperature between 80°–110°F / 27°–43°C.
4. Press **START/CANCEL** to begin fermentation. The button will light up, and the display will show the timer counting down.
5. The oven will stop heating and beep several times when finished.

Warm Function (“WARM”)



This function is designed to keep food warm at the recommended temperature to prevent bacterial growth (160°F / 71°C or above).

Heating Elements: Bottom heating elements cycle on and off.

Rack Position: Low

1. Place hot food in a heat-safe container. Cover and place on the food tray or wire rack. Insert at low position and close the oven door.
2. Turn the **FUNCTION** knob to “**WARM**”, which will blink on the display.
3. Optionally, customize the temperature and time. You can do this anytime during cooking.
 - a. Turn the **TIME/TEMP** knob to adjust the time between 1 min–12 hr.
 - b. Press the **TIME/TEMP** knob once to control temperature. Turn the knob to adjust the temperature between 140°–230°F / 60°–110°C.
4. Press **START/CANCEL** to begin warming. The button will light up, and the display will show the timer counting down.
5. The oven will stop heating and beep several times when finished.

CARE & MAINTENANCE

Clean oven accessories (including trays, etc.) and oven interior after every use.

Note:

- The walls on the inside of the oven have a nonstick coating for easy cleaning.
 - **Do not** use abrasive cleaners, metal scouring pads, or metal utensils on any part of the oven, including trays and other accessories. These will scratch or damage their surfaces.
 - This oven contains no user-serviceable parts. Any repairs should be performed by an authorized service representative.
1. Before cleaning, turn off and unplug the oven, and allow it to cool completely. Open the door for faster cooling.
 2. Apply non-abrasive liquid cleanser or a mild spray solution to a soft, damp cloth or sponge (not the oven surface) and wipe all parts of the oven. **Do not** use a dry cloth on the display screen, or it may be scratched.
 3. To clean the glass door, use a glass cleaner or mild detergent and a soft, damp sponge or soft, plastic scouring pad.
 4. Let all surfaces dry completely before plugging in or turning on the oven.

Cleaning the Accessories

Note: After each use, slide out the crumb tray and discard crumbs.

1. Apply non-abrasive liquid cleanser or a mild spray solution to a soft, damp sponge or soft, plastic scouring pad (not the accessory surface). Wipe accessories and soak in warm, soapy water if necessary.
2. For stubborn grease:
 - a. In a small bowl, mix 2 US tbsp / 30 mL of baking soda with 1 US tbsp / 15 mL of water to form a spreadable paste.
 - b. Use a sponge to spread the paste on the trays and scrub. Let the trays sit for 15 minutes before rinsing.
 - c. Wash trays with soap and water.
3. Dry thoroughly.
4. Replace the crumb tray into the oven before plugging in or turning on the oven.

Storage

1. Clean and dry the oven and all accessories.
2. Insert the crumb tray into the oven. Insert the rack at mid position. Make sure the oven door is closed.
3. Store the oven in an upright position. **Do not** store anything on top.

TROUBLESHOOTING

Problem	Possible Solution
The oven will not turn on.	Make sure the oven is plugged in.
Foods are not completely cooked.	Increase cooking temperature or time.
Foods are overcooked or burned.	Decrease cooking temperature or time.
	Make sure food items are not too large and are not touching the heating elements.
Foods are cooked unevenly.	Preheat the oven manually by using the Toast function set to Level 4.
	Make sure food items are not too closely packed into a tray, rack, or other container.
White smoke or steam is coming out of the oven.	The oven may produce some white smoke or steam during cooking. This is normal.
	During first use, dust from the packing process may cause white smoke. This is normal for toaster ovens and many other kitchen appliances. To eliminate any dust, see Test Run (page 9).
	Excess oil or fatty foods may produce white smoke. Make sure the inside of the oven is cleaned properly and not greasy.
Dark smoke is coming out of the oven.	Immediately press START/CANCEL and unplug your oven. Food is burning. Wait for smoke to clear before opening the oven door.
Display shows Error Code "E1".	There is an open circuit in the temperature monitor. Contact Customer Support (see page 28).
Display shows Error Code "E2".	There is a short circuit in the temperature monitor. Contact Customer Support (see page 28).

If your problem is not listed, please contact **Customer Support** (see page 28).

WARRANTY INFORMATION

Product	<i>Original Air Fryer Toaster Oven</i>
Models	<i>CO130-AO, CO130-AO-RXS</i>
For your own reference, we strongly recommend that you record your order ID and date of purchase.	
Order ID	
Date of Purchase	

TERMS & POLICY

Arovast Corporation ("Arovast") warrants this product to the original purchaser to be free from defects in material and workmanship, under normal use and conditions, for a period of 2 years from the date of original purchase.

Arovast agrees, at our option during the warranty period, to repair any defect in material or workmanship or furnish an equal product in exchange without charge, subject to verification of the defect or malfunction and proof of the date of purchase.

There is no other express warranty. This warranty does not apply:

- If the product has been modified from its original condition;
- If the product has not been used in accordance with directions and instructions in the user manual;
- To damages or defects caused by accident, abuse, misuse or improper or inadequate maintenance;
- To damages or defects caused by service or repair of the product performed by an unauthorized service provider or by anyone other than Arovast;
- To damages or defects occurring during commercial use, rental use, or any use for which the product is not intended;
- To damages or defects exceeding the cost of the product.

Arovast will not be liable for indirect, incidental, or consequential damages in connection with the use of the product covered by this warranty.

This warranty extends only to the original consumer purchaser of the product and is not transferable to any subsequent owner of the product regardless of whether the product is transferred during the specified term of the warranty.

This warranty does not extend to products purchased from unauthorized sellers. Arovast's warranty extends only to products purchased from authorized sellers that are subject to Arovast's quality controls and have agreed to follow its quality controls.

All implied warranties are limited to the period of this limited warranty.

This warranty gives you specific legal rights and you may also have other rights which vary from state to state. Some states do not allow the exclusion or limitation of incidental or consequential damages, so the above limitation or exclusion may not apply to you.

If you discover that your product is defective within the specified warranty period, please contact Customer Support via support@cosori.com. **DO NOT** dispose of your product before contacting us. Once our Customer Support Team has approved your request, please return the product with a copy of the invoice and order ID.

Every Cosori product automatically includes a 2-year warranty. To make the customer support process quick and easy, register your product online at www.cosori.com/warranty.

This warranty is made by:

Arovast Corporation
1202 N. Miller St., Suite A
Anaheim, CA 92806

CUSTOMER SUPPORT

If you have any questions or concerns about your new product, please contact our helpful Customer Support Team.

Arovast Corporation

1202 N. Miller St., Suite A
Anaheim, CA 92806

Support Hours

Mon–Fri, 9:00 am–5:00 pm PST/PDT

Email: support@cosori.com

Toll-Free: (888) 402-1684

*Please have your order invoice and order ID ready before contacting Customer Support.

SHOW US WHAT YOU'RE MAKING

We hope this has been helpful to you. We can't wait to see your beautiful results, and we think you'll want to share glam shots! Our community awaits your uploads—just pick your platform of choice below.

Snap, tag, and hashtag away, Cosori chef!

#LiveLifeTastefully #iCookCosori

@CosoriCooks



@Cosori



MORE COSORI RECIPES

Considering what to cook? Many recipe ideas are available, both from us, the Cosori community, and through the VeSync app.



Scan the QR code
to get the app.

COSORI®

Questions or Concerns?

support@cosori.com | (888) 402-1684

Mon–Fri, 9:00 am–5:00 pm PST/PDT