

# ASTROLABE

The Missing Manual  
beta version 0.1

Timothy Mitchell

## Acknowledgements

Part I cover and Part II cover: Illustrations adapted from: Johannes Stoeffler, *Elucidatio Fabrique Ususque Astrolabii*. Made available by the Digital Rare Book Collection at the Vienna University Observatory, located at <http://www.univie.ac.at/hwastro>. Used with permission.

Figure 1: A Slide Rule: From Wikimedia Commons, uploaded by user charlie42. This file is licensed under the Creative Commons Attribution-Share Alike 3.0 Unported License. ([http://commons.wikimedia.org/wiki/File:Use\\_slide\\_rule\\_multi.jpg](http://commons.wikimedia.org/wiki/File:Use_slide_rule_multi.jpg))

Figure 2: The Celestial Sphere: Public domain clipart.

Figure 6: Map projection: From Wikimedia Commons. Public domain art. ([http://commons.wikimedia.org/wiki/File:National\\_Atlas\\_Mercator.gif](http://commons.wikimedia.org/wiki/File:National_Atlas_Mercator.gif))

All other content in this manual is copyright © 2011 Timothy J. Mitchell

This work is licensed under the Creative Commons Attribution-NonCommercial-NoDerivs 3.0 Unported License. To view a copy of this license, visit <http://creativecommons.org/licenses/by-nc-nd/3.0/> or send a letter to Creative Commons, 171 Second Street, Suite 300, San Francisco, California, 94105, USA.



*In other words, copy and distribute this all you want; so long as I get credit, you don't modify it and you don't sell it.*

Version 0.1 – October 2011

This manual is a work in progress. The most current version is available for download from the Astrolabe Project website:

<http://astrolabeproject.com>

## Table of Contents

Part 1: An Overview .....	5
About this book.....	7
A note on the examples:.....	7
Introduction: A new manual for a very old computer.....	7
History.....	8
Why an Astrolabe?.....	9
2. Astrolabe Theory .....	10
The Celestial Sphere .....	10
The Local Sky.....	12
The Projections .....	13
3. The Parts of the Astrolabe.....	17
4. The Front Scales .....	20
The Mater Scales.....	20
The Plate Scales .....	21
The Rete Scales.....	29
The Rule.....	31
5. The Rear Scales.....	32
Part 2: Using the Astrolabe .....	35
1. Using the Rear Scales – Basic .....	36
Using the Alidade and the Altitude Scale.....	36
Appendixes .....	40
Bibliography .....	40
Glossary .....	41
Recommended Reading .....	43

## Figures

Figure 1: A slide rule .....	8
Figure 2: The celestial sphere .....	10
Figure 3: Landmarks of the celestial sphere .....	11
Figure 4: Events of the celestial year .....	12
Figure 5: The local sky .....	13
Figure 6: Map projection .....	14
Figure 7: Projecting the celestial sphere .....	14
Figure 8: Projecting the local sky .....	15
Figure 9: The projections - the results .....	15
Figure 10: The projections - overlaid.....	16
Figure 11: Exploded view of a typical astrolabe .....	17
Figure 12: Plates for 20, 45 and 65 degrees.....	18
Figure 13: Orienting the astrolabe .....	20
Figure 14: Some examples of typical limb markings .....	21
Figure 15: The Front of the astrolabe (typical).....	21
Figure 16: Plate detail .....	22
Figure 17: Meridian and Tropics .....	23
Figure 18: Horizon line .....	24
Figure 19: Almucantars.....	25
Figure 20: Azimuth lines .....	26
Figure 21: Unequal hour lines.....	28
Figure 22: Example - reading the plate scales .....	29
Figure 23: Rete (typical) .....	30
Figure 24: Rete close-up .....	31
Figure 25: The rule (typical) .....	31
Figure 26: The Rear of the astrolabe (typical).....	32
Figure 27: The Back Scales - Detail .....	33
Figure 28: Finding the Sun's Position .....	34
Figure 29: The sighting vanes on the alidade .....	37

# Part 1: An Overview

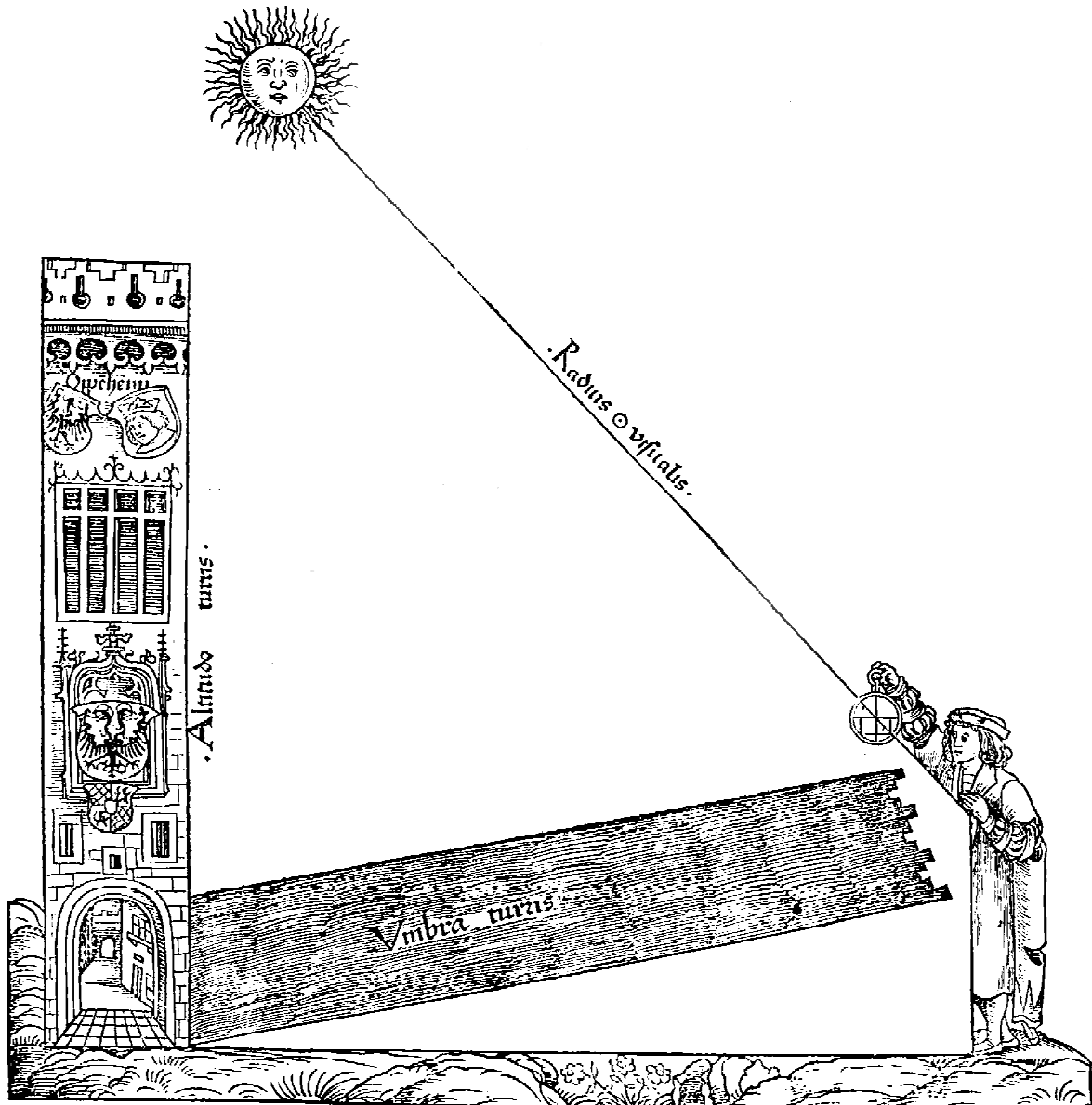



## 1. Background

### **About this book**

A few years ago my interest in mechanical computing devices led me to investigate the astrolabe. As usual, my first reflex was to look for a good book on the subject; but after an exhaustive search I was able to locate only one book on the use and functions of the astrolabe. Written by Geoffrey Chaucer (of Canterbury Tales fame) in the 14th century, it was an interesting book, but did little to answer my questions. What I wanted and needed was a good, simple description of the astrolabe's parts and functions; with examples of how it could be used; in short, a computer manual.

Over a year later James Morrison published his excellent book The Astrolabe (see Recommended Reading). That book answered my questions and then some, but it is not widely available in libraries, and is a bit expensive for someone who is just looking to dabble. So a simple introductory guide is still needed. What follows is based on what I have gleaned from various sources, and my own experience making, using and teaching about the astrolabe. Enjoy.

### **A note on the examples:**

I will try to keep this manual clear enough that the reader will be able to understand the concepts without needing an actual astrolabe to follow along on; however, having one is highly recommended. All the examples in this book are based on an astrolabe designed for latitude 40 degrees 58 minutes north. If you are using an astrolabe designed for some other latitude, you will notice differences in the answers you get. This is to be expected.

If you wish to be able to follow along using the same astrolabe as I did in writing this, the files and instructions to build the example astrolabe can be found on my website:  
<http://astrolabeproject.com>.

### **Introduction: A new manual for a very old computer.**

As we enter the second decade of the 21st century, computers have become ubiquitous. Since we interact with them several times a day, the tendency is to equate the computer with the modern world and to ascribe the term 'high tech' to the modern era.

In fact, computers have been around for much longer than most people imagine. The modern, digital computer, the one we are all familiar with, was born in the first half of the last century; but there is another type of computer, one that has been in use much, much longer.

The digital computer creates a digital, mathematical model of a system and manipulates this model mathematically according to a set of rules, to answer questions about that system. In contrast, the analog computer physically models a system and is physically manipulated by

the user in order to get answers concerning the system. Unlike digital computers, analog computers have been around a long time. One example familiar to older readers is the slide rule, where sliding scales allow complex mathematical computation to be done quickly. An even older example is the abacus, a computer modeling simple arithmetical relationships that is so useful it has been in constant use for millennia.

**Figure 1: A slide rule**

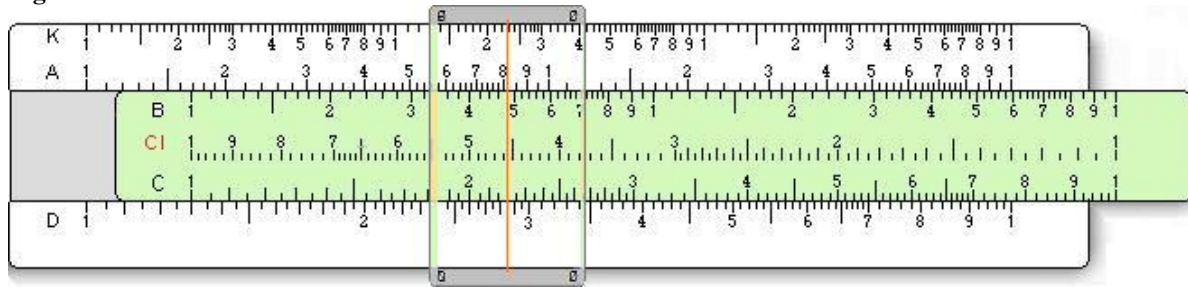

The subject of this manual, the astrolabe, is also an analog computer. As will be explained and demonstrated, the astrolabe physically models the visible universe; and by manipulating this model conditions can be set, and answers and predictions concerning the movements of the sun and stars can be computed, along with a host of other functions.

## History

### Greece

It is generally accepted that the first primitive astrolabes were developed in Greece, around the time of Ptolemy (2nd century A.D.) and it is possible that the instrument dates back as far as 150 B.C. (Neugebauer 240). Their use spread across the Mediterranean basin, eventually arriving in the Arab countries.

### The Arab influence

The astrolabe was introduced to the Arab world at least as early as the mid-8th century (Pingree and Chandler XII). Arab and Persian culture had developed mathematics well in advance of the more northern countries and so were able to greatly improve and expand the capabilities of the device. By the 9th century, knowledge of astrolabes had spread throughout that part of the world, and the device had been transformed from its primitive original form into a powerful tool of accuracy and flexibility.

### Re-introduction into Europe

A combination of trade and the crusades re-introduced the much-improved astrolabe to Europe, along with books concerning its design and construction. By the end of the 13<sup>th</sup> century use and construction of the astrolabe was established over most of Europe (Morrison 38).

### Obsolescence



After about 1600 the advent of specialized devices that replaced the various functions of the astrolabe caused a decline in its popularity as a tool. Specialized versions like the latitude ring continued in use (Morrison 44).

## **Why an Astrolabe?**

### **What could you use an astrolabe for?**

As we discussed above, an astrolabe can be thought of as a form of computer; a multi-function calculator, if you will. Its most common usage was the solving of problems concerning astronomy and time keeping, but the full range of its capabilities is much larger:

- Solving problems of geometry
- Converting between time-keeping systems
- Calculating trigonometric functions
- Basic surveying
- And much more

### **Who would have possessed/used an astrolabe in the middle ages?**

- Alchemists
- Astrologers/astronomers
- Educated individuals

Use of the astrolabe would have been taught in the course of advanced classes in the natural sciences and mathematics, the way slide rules used to be, and high-end calculators are now.

### **What materials would be used to construct astrolabes?**

Most of the surviving astrolabes are constructed of metal, preserved by their higher value and durability. But there are also several surviving examples from the medieval period of astrolabes constructed of both paper and wood (and sometimes paper laminated to wood), so that we can assume that cheap versions were not uncommon.

## 2. Astrolabe Theory

Understanding the various functions of the astrolabe is made easier if you have an understanding of the concepts behind its design, how they are used in the astrolabe and how the various parts work:

### The Celestial Sphere

The sky can be thought of (and for centuries was thought of) as a vast sphere with the fixed stars attached to it, with the Earth, stationary and non-rotating, at the center. The Sun, the Moon, and the planets all had their own concentric spheres between the Earth and the stars. As the various spheres rotate about the earth, different parts of the sky would become visible to a viewer standing in a given spot.

Figure 2: The celestial sphere

*Schema huius præmissæ diuisionis Sphærarum .*



Like the Earth itself, this celestial sphere has many fixed landmarks allowing the observer to find his or her way around:

**Figure 3: Landmarks of the celestial sphere**

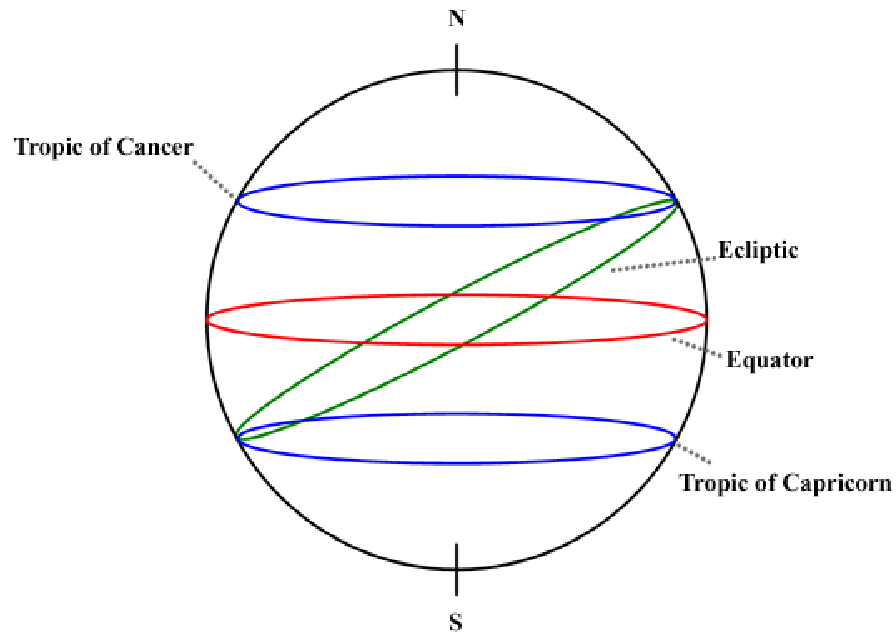

### **The Celestial Poles and Equator**

At due north, at the point about which the sphere appears to rotate, is Polaris, the North Star, or Pole Star. This point marks celestial north. Opposite it, invisible to viewers in the northern hemisphere, is celestial south. Between these two extremes is a circle marking the celestial equator. As these all lay directly above their earth-bound equivalents, you can think of these points the way you think of Earth's north and south poles, and equator; and just as you can define your position on the Earth using your latitude and longitude, positions on the celestial sphere can be similarly defined.

### **The Ecliptic**

The most obvious object in the sky is the Sun. As the Earth rotates (or as it would have been explained in the days when the astrolabe was current technology, as the Sun rotates around the Earth), the sun rises, moves across the sky from East to West and sets. Over the course of the year the Sun seems to move across the fixed stars, oscillating from north to south and back again. This set path in the sky that the sun moves along is known as the ecliptic and is marked by the zodiac constellations.

### **The Tropics**

As the Sun moves along the ecliptic, it moves toward the north as summer approaches, and back south as winter comes. The circle marking the northernmost point of the sun's path is known as the Tropic of Cancer and the southernmost the Tropic of Capricorn.

### **The Celestial Year**

There are 4 fixed events in the year, defined by the sun's motion along the ecliptic.

**Figure 4: Events of the celestial year**

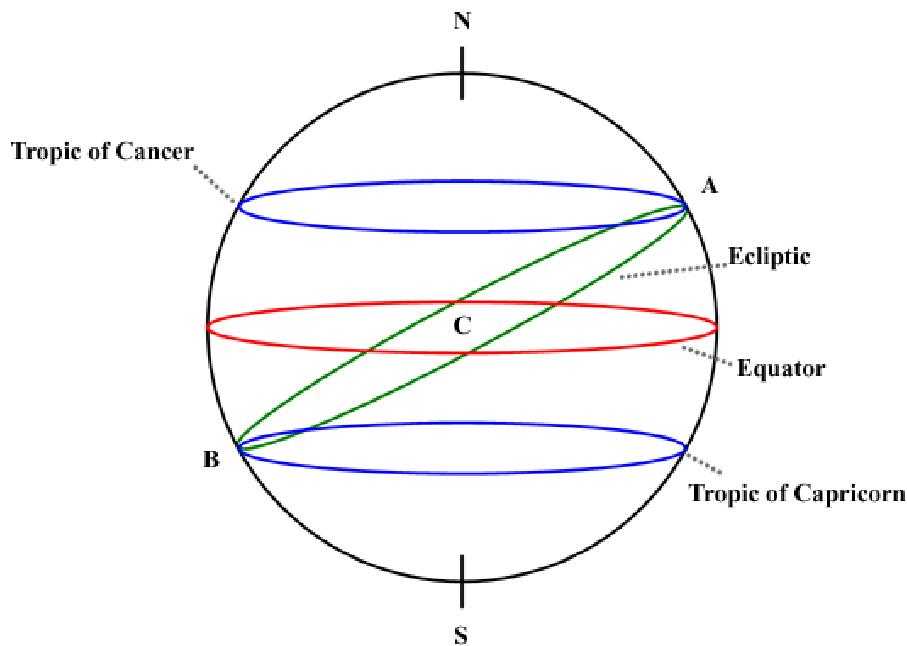

### **The Solstices [A, B]**

The solstices mark the longest and shortest days of the year, these are the dates when the sun is at its most northerly and southerly limits.

### **The Equinoxes [C]**

The ecliptic intersects the equator, and so there are two dates when the sun is on the celestial equator. On these dates the length of the day and length of the night are the same. These dates are the spring and fall equinoxes. The spring equinox occurs when the sun moves from the southern hemisphere to the northern; and the reverse is true for the fall equinox.

### **The Local Sky**

In addition to the celestial sphere, the astrolabes function relies on knowledge of the local sky from the point of view of the user's location. When you look up at the sky you can see half of the celestial sphere; the other half being blocked by the ground you are standing on. What part of the sphere is visible depends on where you are and the time of day and the time of year (see Figure 5).

### **The Horizon**

The horizon is marked, rather obviously, by the line where the sky meets the ground. Of course, your local terrain, mountains and such will alter what can actually be seen, but for the purposes of this manual imagine it as a smooth line all the way round you.

### **The Zenith and Nadir**

The point highest in your local sky (i.e. directly overhead) is the Zenith; its opposite point, directly under your feet, is called the Nadir. The horizon then lies 90 degrees from both.

Figure 5: The local sky

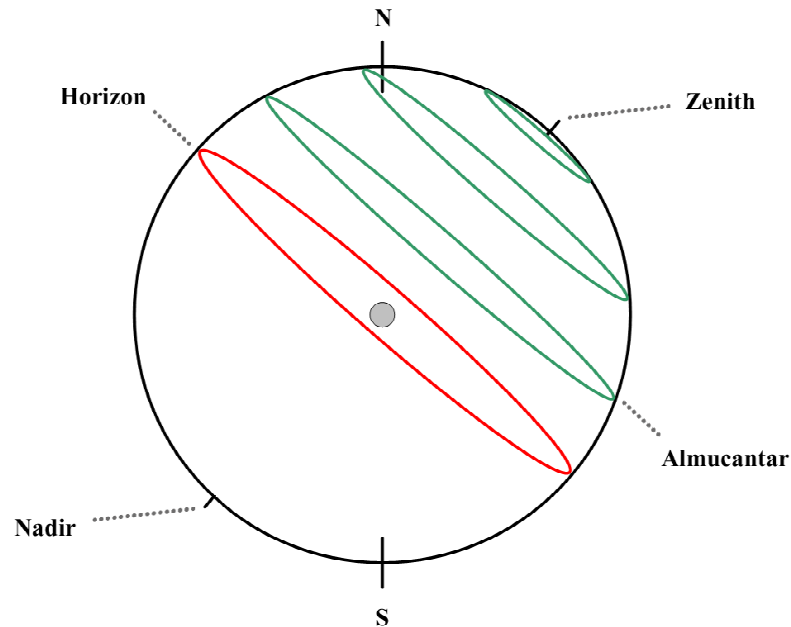

### The Almucantars

An almucantar is defined as a line of equal elevation above the horizon. For example: Imagine a line that lays 15 degrees above your local horizon, all around the sky. That would be the 15-degree almucantar. We will discuss these at length later.

### The Meridian

The last major landmark we will concern ourselves with is the meridian (not shown). This is an imaginary line in the sky, passing from the north celestial pole to the south celestial pole, and passing directly over your head (zenith). This line marks local noon, the sun's highest point above the horizon for any given day. Picture it as a line in the sky running from due north to due south directly overhead.

### The Projections

If you have done any work with maps, you will be familiar with the concept of projections. The Earth is a sphere; so creating a flat map of the curved surface involves projecting that sphere onto a flat surface. This is why, on some maps, the continents appear very distorted near the poles.

**Figure 6: Map projection**

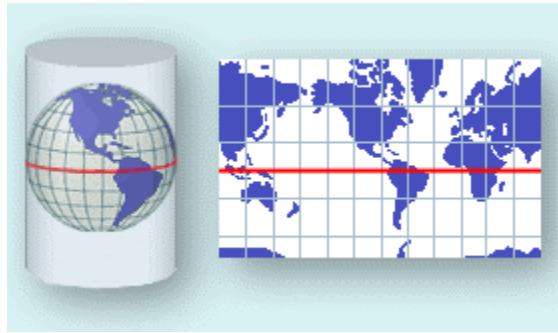

Designing an astrolabe presents a similar problem: Mapping the sky onto a flat surface.

The astrolabe is based on what is known as the planispheric projection. In a planispheric projection, a spherical object is projected onto a plane surface by placing the origin of the projection at one pole of the sphere and projecting the points of the sphere onto a plane surface placed through its equator.

**Figure 7: Projecting the celestial sphere**

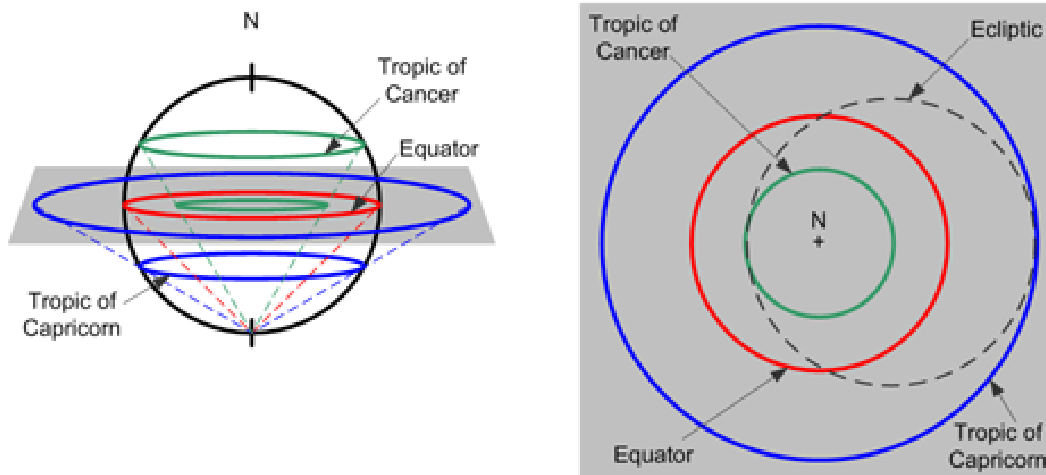

The common form of the astrolabe that we are discussing here uses two projections. The first is a projection of the celestial sphere, with the tropics of Cancer and Capricorn, the Equator and the Ecliptic projected onto the plane, along with the position of the major stars (see Figure 7). This projection makes up the astrolabe rete (see the next section - Parts of the Astrolabe).

The second projection is that of the local sky (see Figure 8). Using the same projection method, the local sky from horizon to zenith is projected onto a plane. Instead of celestial landmarks being projected, this projection uses lines of equal elevation above the horizon (almucantars, see above) from 0 degrees at the horizon to 90 degrees at the zenith. Lines of azimuth are also projected. This projection is used to make the astrolabe plate or climate.

**Figure 8: Projecting the local sky**

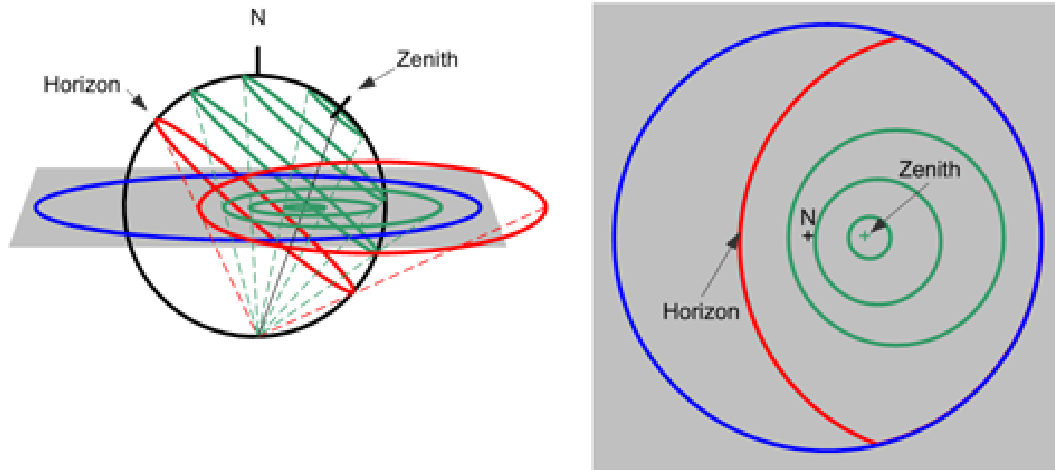

If you look at Figure 9 you will see the result of these two projections. On the right is the astrolabe rete. Its outer circumference is a projection of the Tropic of Capricorn. The outer edge of the wide offset circle is the ecliptic.

**Figure 9: The projections - the results**

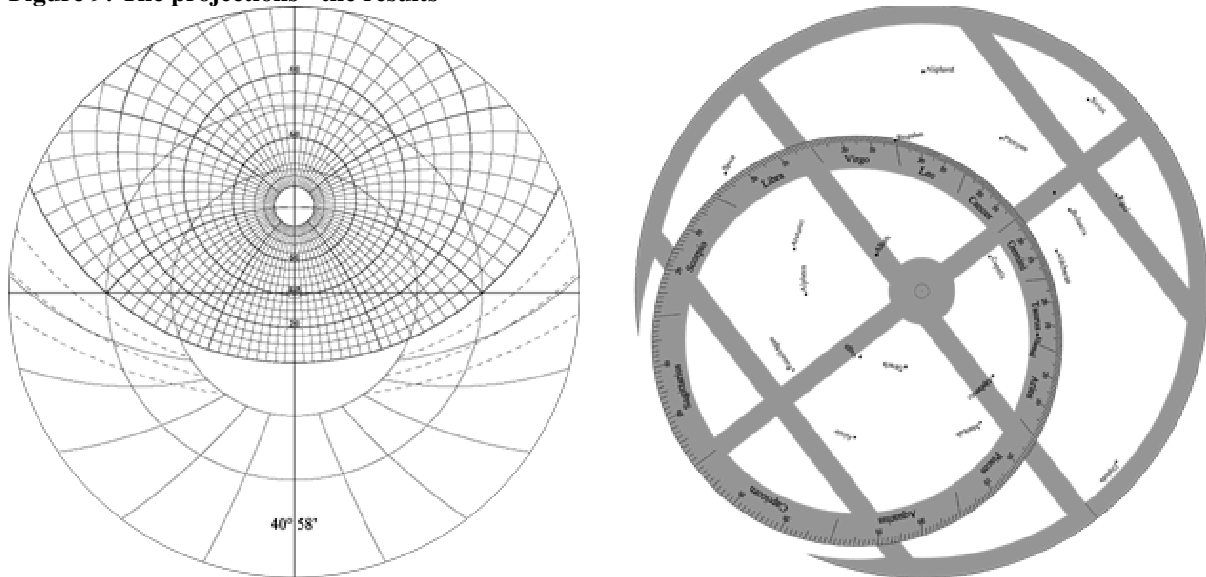

On the left is the astrolabe plate, with its projection of the local sky. The top half of the plate contains the circular grid that is the projection of the local sky from the horizon (the bottom most curve of the grid) to the zenith (the cross at the center of the smallest circle). Again, the outermost circumference of the plate is the projection of the Tropic of Capricorn, and its center marks the projection of the celestial pole.

If you examine these projections, you will notice that in both cases the projection is oriented the same, with the north celestial pole projecting as a point in the exact center of the

projection. This allows us to overlay the projections, the celestial sphere over the local sky, and pivot it on the celestial pole (see Figure 10).

**Figure 10: The projections - overlaid**

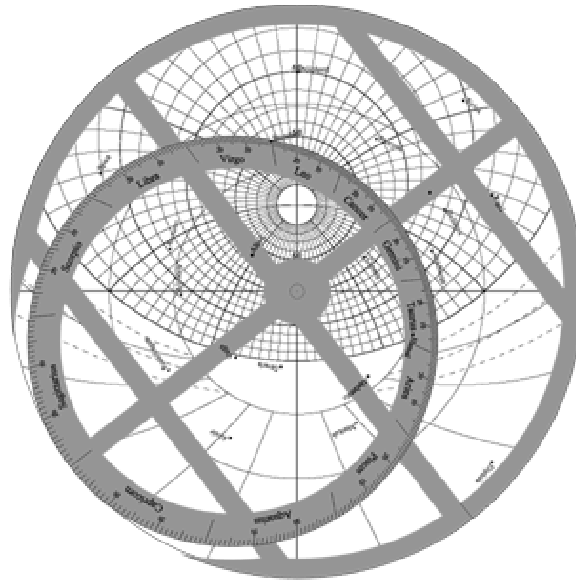

By rotating the rete the user can then display the local view of the sky for any combination of time and day of the year.



### 3. The Parts of the Astrolabe

The illustration shows the major parts of a typical astrolabe, and their relationship.

Figure 11: Exploded view of a typical astrolabe

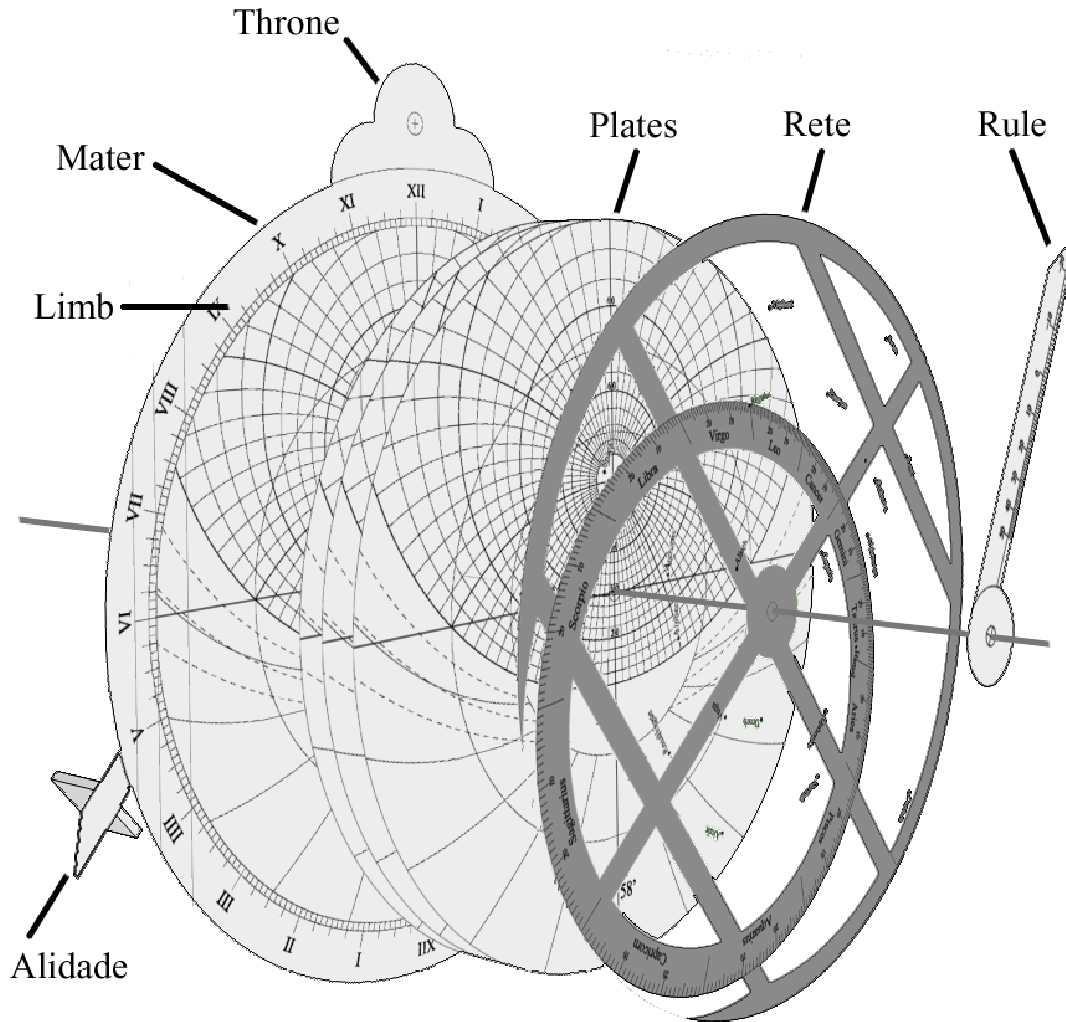

#### The Mater

The Mater is the main part of the astrolabe; all the other parts connect to it. Permanently fixed to it are the Throne and the Limb.

#### The Throne

The Throne is attached to the top of the mater, and provides a means of suspending the astrolabe to take sightings. In use, a ring or cord would be attached to the throne, allowing it to hang freely and so allow measuring angles from the horizon accurately. Depending on the

time, place and whim of the maker, the throne might be anything from a simple bulge, to an impressively ornate decoration almost as large as the rest of the astrolabe.

### **The Limb**

The Limb is the raised ring section on the front of the mater; it encloses a space that contains the plates and the rete. It is commonly marked with the hours of the day and/or a degree scale.

### **The Plates or Climates**

An astrolabe is a very precise instrument, but its accuracy is tied to a specific latitude because the projection of the visible sky changes with the viewer's latitude. In the example below we see plates (also known as climates) for latitude 20 degrees north, 45 degrees north and 65 degrees north; as you can see the projection on the plate changes radically.

**Figure 12: Plates for 20, 45 and 65 degrees**

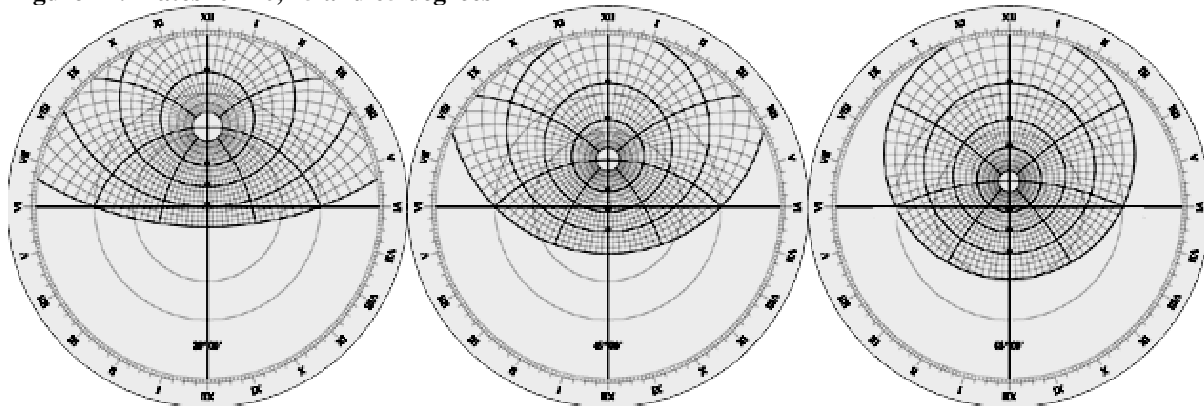

To make the device more flexible, astrolabes were commonly provided with a set of plates, each one for a different specific latitude. That way, if the user traveled to a different location, from Cambridge to London for example, the proper plate could be swapped to the front, allowing accurate calculations to be done at the new location. The set of plates are stored in the circular hollow formed by the limb of the mater.

### **The Rete**

The Rete is a cutout overlay that rests on top of the plates. It shows the projection of the celestial sphere. Unlike the plates, the rete is designed to turn freely.

### **The Rule**

The Rule rests on top of the rete, and is designed to turn freely. It is used as a pointer during calculations and, depending on the origin of the astrolabe and the preference of the maker or owner, might be double or single ended; or not be present at all.

### **The Alidade**

On the opposite side of the astrolabe from the rule is the alidade. This is a double-ended rotating pointer arm with a set of attached sights for taking accurate angle measurements.

**Pin and Horse (not shown)**

Tying together the rest of the parts and providing a pivot point for the rotating parts, the pin is placed through the center of the mater. The Horse is a retaining pin that keeps the pin in place.

## 4. The Front Scales

### A note on orienting the astrolabe

The astrolabe is meant to be used looking down at it. The top of the device (where the throne is situated) is south and should be pointing away from you, the bottom is north, this puts west to the right, and east to the left.

Figure 13: Orienting the astrolabe

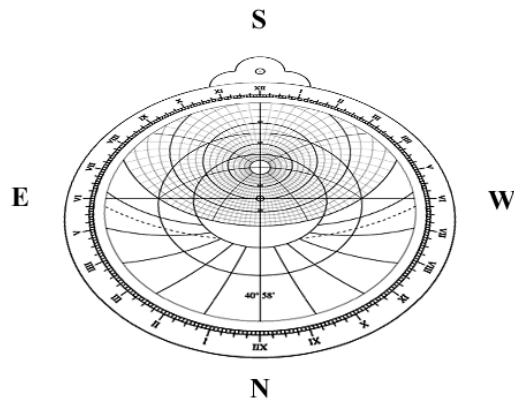

## The Mater Scales

### The Limb

The limb of the astrolabe mater is usually divided into hours, totaling the 24 hours of the day. It is further subdivided into minutes. On larger astrolabes, each individual minute might be marked, while on smaller devices there might be a mark every 3 or 4 minutes. The limb is labeled with the hours, sometimes in Roman numerals, sometimes in Arabic numerals, and sometimes with a series of letters or symbols. In addition, there is sometimes a scale marked in degrees (see Figure 14).

Figure 14: Some examples of typical limb markings

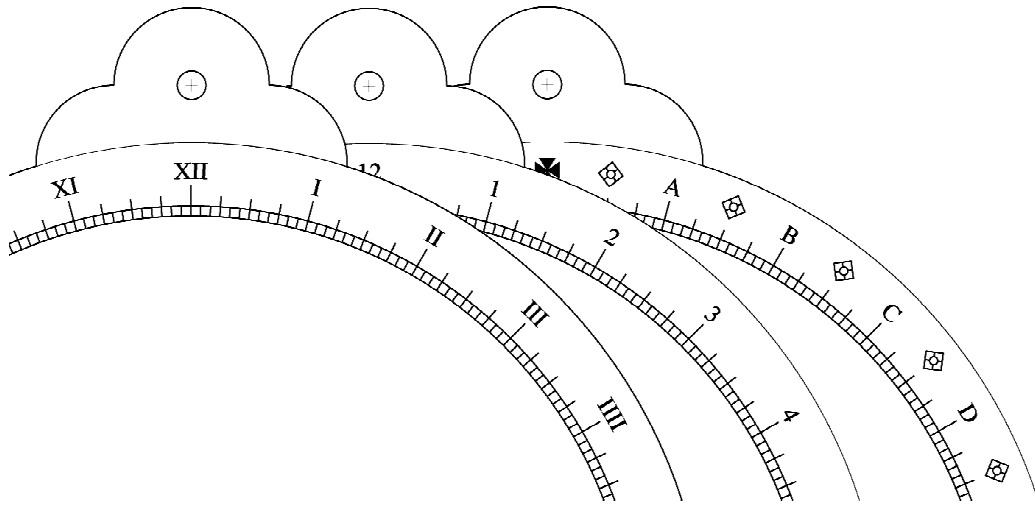

## The Plate Scales

As discussed in a previous section, the plate is a projection of local sky, and as such is tied to a specific latitude. Each plate in a set will be made for a different latitude, but the various markings and lines will serve the same functions on each one.

Figure 15: The Front of the astrolabe (typical)

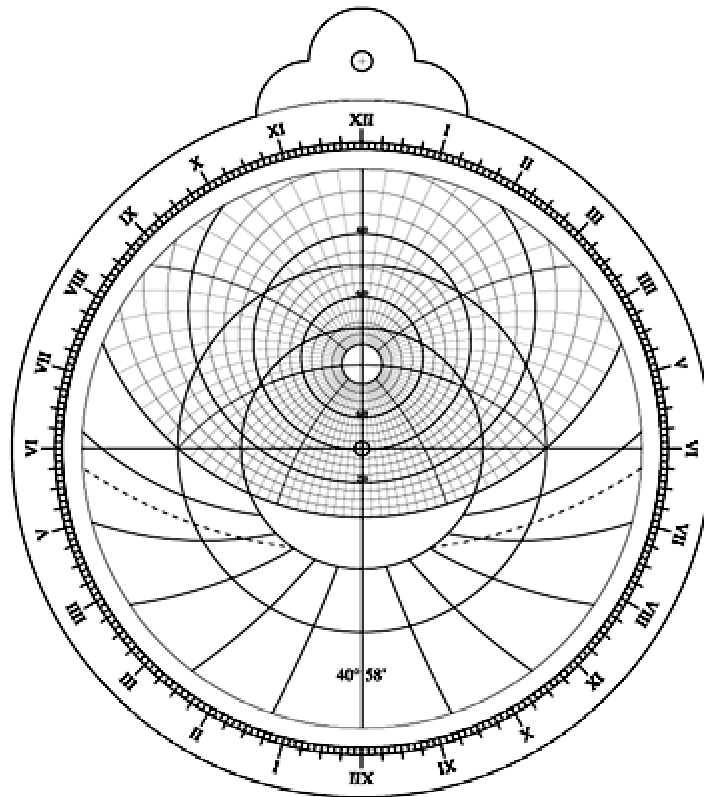

Below is a close-up of part of the plate, with each type of scale marked with its name.

**Figure 16: Plate detail**

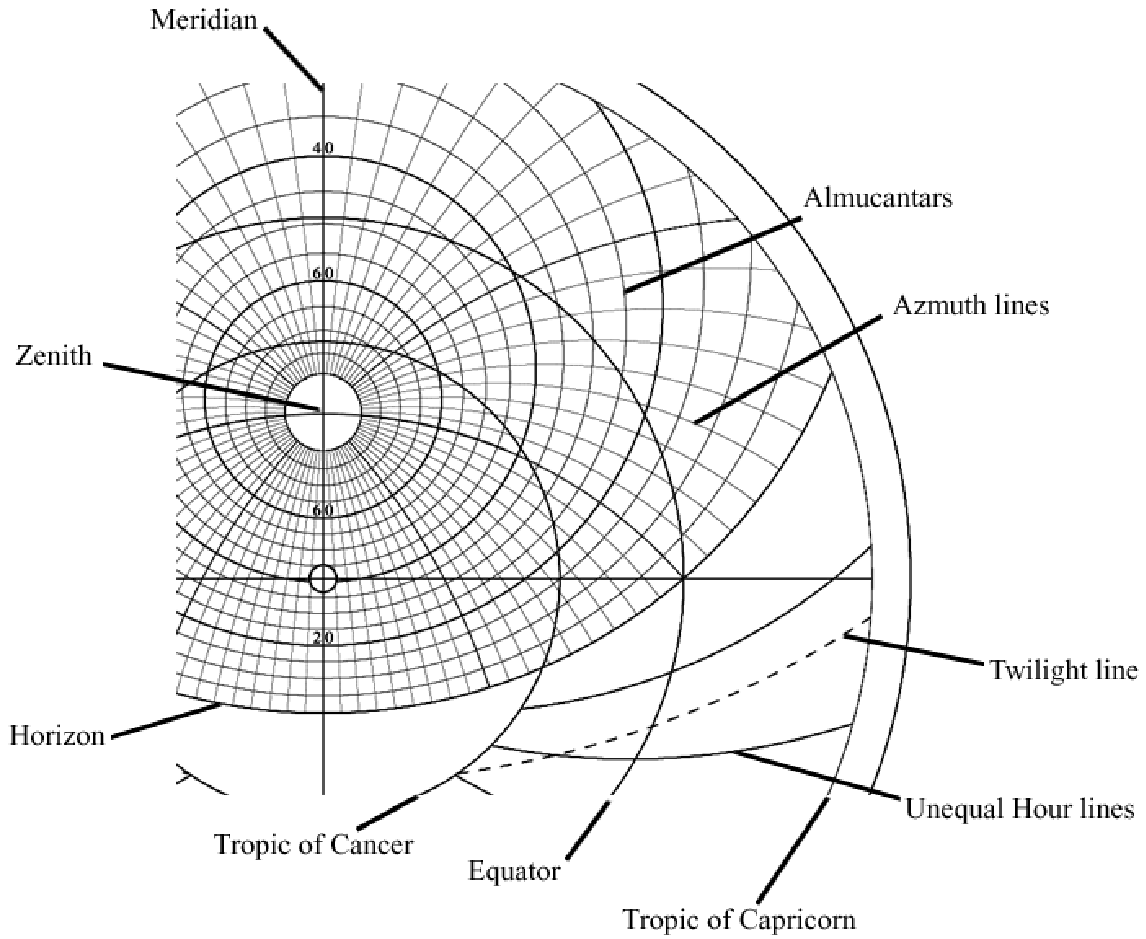

To the untutored eye, this looks horribly complicated, so let's build up the plate one element at a time:

## Meridian

As described in the chapter on astrolabe theory, the meridian is the line in the sky that passes directly over your head (zenith) and through the north and south celestial poles. The meridian is important because it marks the local noon - the highest point in the sun's path through the sky, half way between sunrise and sunset. On the plate the meridian is a vertical line passing through the center of the plate. There is also a line crossing it at 90 degrees, which indicates true east and west (See Figure 17).

Figure 17: Meridian and Tropics

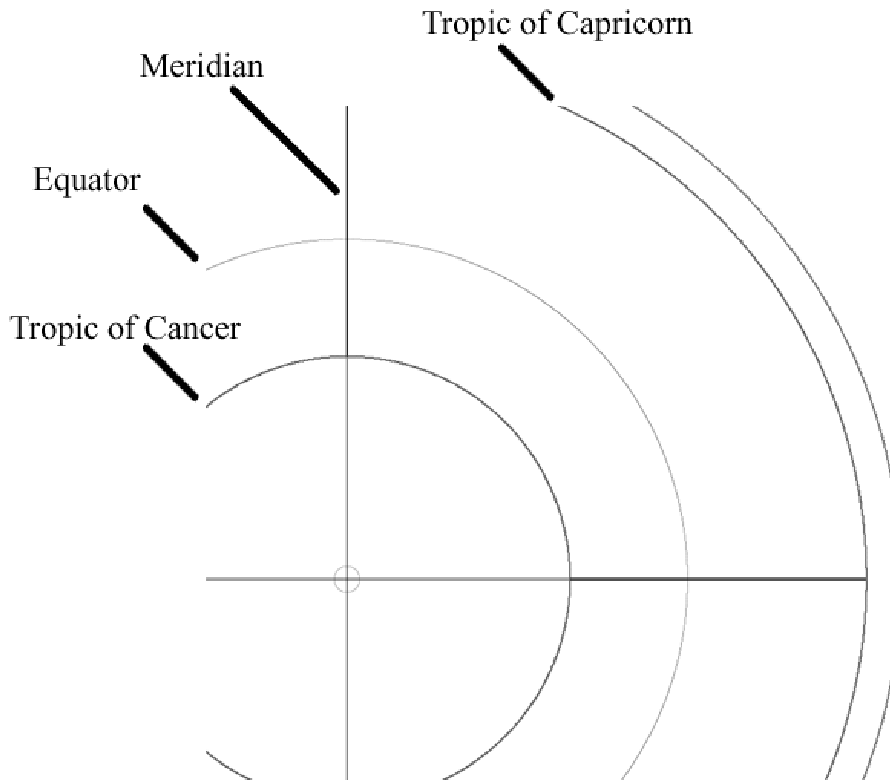

## Tropics and Equator

In the chapter on astrolabe theory it was explained that the rete displays the projection of the celestial sphere. However, as the equator, and the tropics of cancer and capricorn are concentric circles centered on the celestial pole, they do not move as the rete is rotated. Therefore it is common practice, and much easier, to etch them directly on the plate rather than cluttering the rete with them.

## Horizon

The horizon is, of course, the line where the local sky meets the ground. It is depicted on the astrolabe plate as the lowest curve of the sky grid. The horizon line is important to the functioning of the astrolabe, as it is used to compute sunrise and sunset as well as the rising and setting of the stars.

**Figure 18: Horizon line**

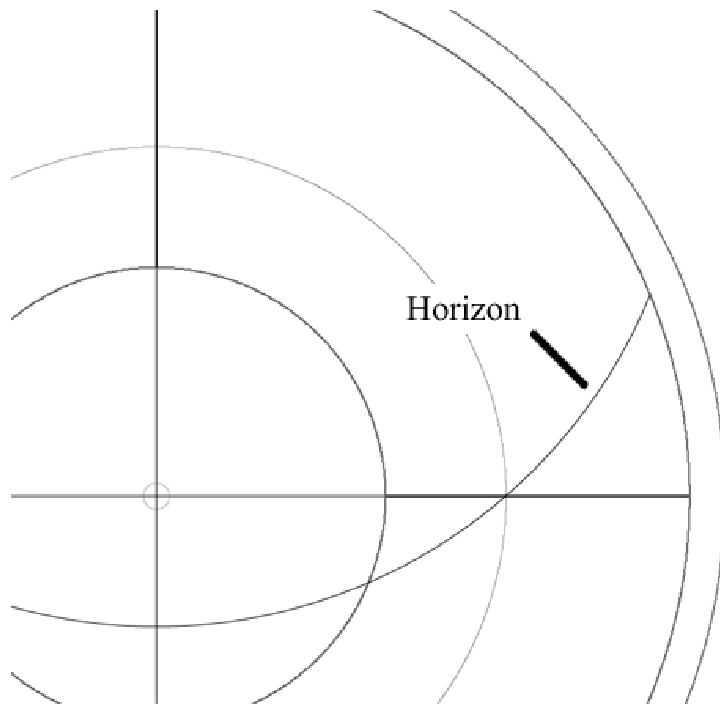



## Almucantars

An almucantar is a line of equal angle above the horizon. The horizon itself is the 0 degree almucantar. The astrolabe plate is typically marked with a series of almucantars from the horizon to the zenith, projected as a set of non-overlapping circles diminishing in size. The example shows the angle above the horizon in 5 degree increments, with every 20th degree marked with a darker line. You will notice that on the example plate there are no markings above the 80 degree line. This prevents the lines from being too close together to be read accurately. The number of almucantars varies with the astrolabe, with some being marked every degree, or every 2 or 3 or 4 degrees. Larger devices would have more room for almucantar circles and smaller ones less.

Figure 19: Almucantars

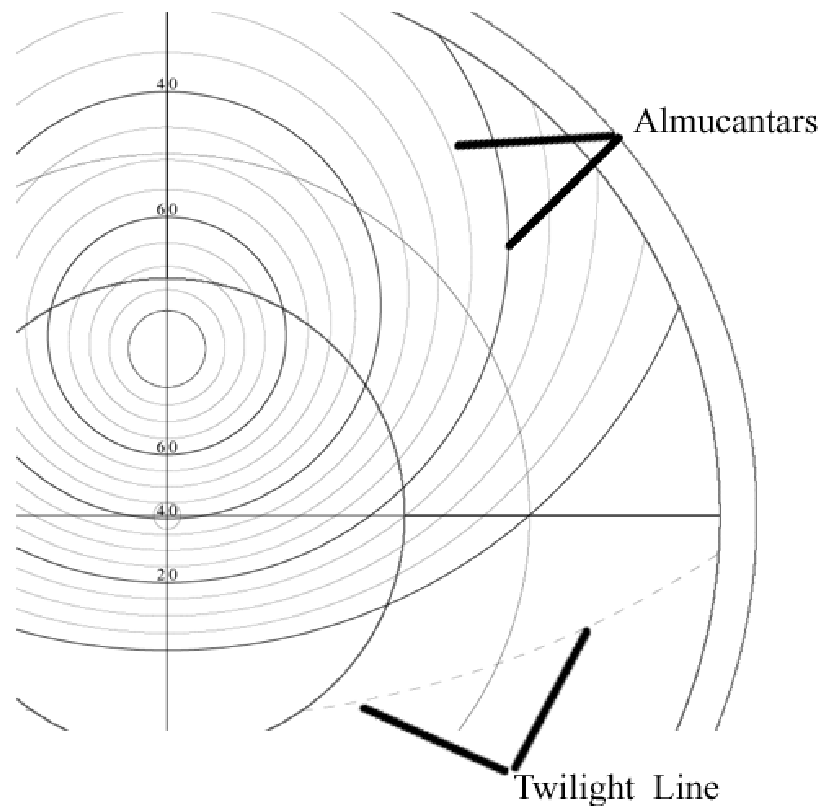

## Twilight line

The twilight line is a special almucantar that is 18 degrees *below* the horizon. The Sun crossing this line marks the transition from twilight to true night so its purpose is to allow the user to compute the times for the start and end of local twilight. It is often depicted as a dashed line below the horizon. In some cases there may be up to three twilight lines shown,

with additional lines for 8 and 12 degrees below the horizon. These indicate the end of civil twilight and nautical twilight respectively.

### Azimuth lines

Crossing the almucantars and running from horizon to horizon, through the zenith, are the azimuth lines. These are projections of the local sky's lines of compass direction. North is at the bottom, as discussed under orientation above, south at the top, west to the right and east to the left. In the example, the azimuth lines are marked every 5 degrees with darker lines every 45 degrees.

Figure 20: Azimuth lines

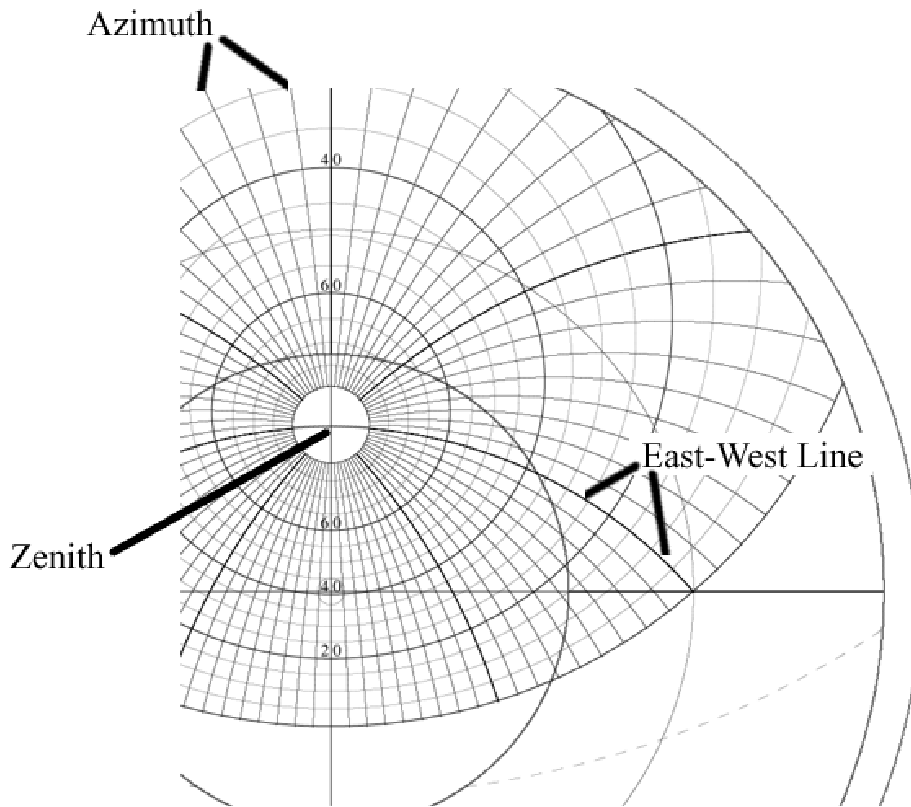

### Note:

You may have noticed that only part of the sky is projected onto the plate - the portion north of the Tropic of Capricorn. This tropic clips off a portion of the southern horizon and sky. It is possible to make an astrolabe that displays the entire sky, but only the area inside the line of the Tropic of Capricorn is really useful. Moreover, the more of the sky that is shown, the

smaller the projection needs to be in order to fit... making the astrolabe less accurate for a given size.

**Zenith**

The zenith is the point directly overhead in the local sky. On the plate it is in the center of the almucantar circles, where the north-south meridian and the east-west azimuth lines cross.

### Unequal hour lines

Finally, in the space under the sky grid there will sometimes be found a series of curved lines called unequal hour lines. The function of these will be described in later chapters; but for now all you need to know is that they allow the user to convert between two different time keeping systems in use in the middle ages.

Figure 21: Unequal hour lines

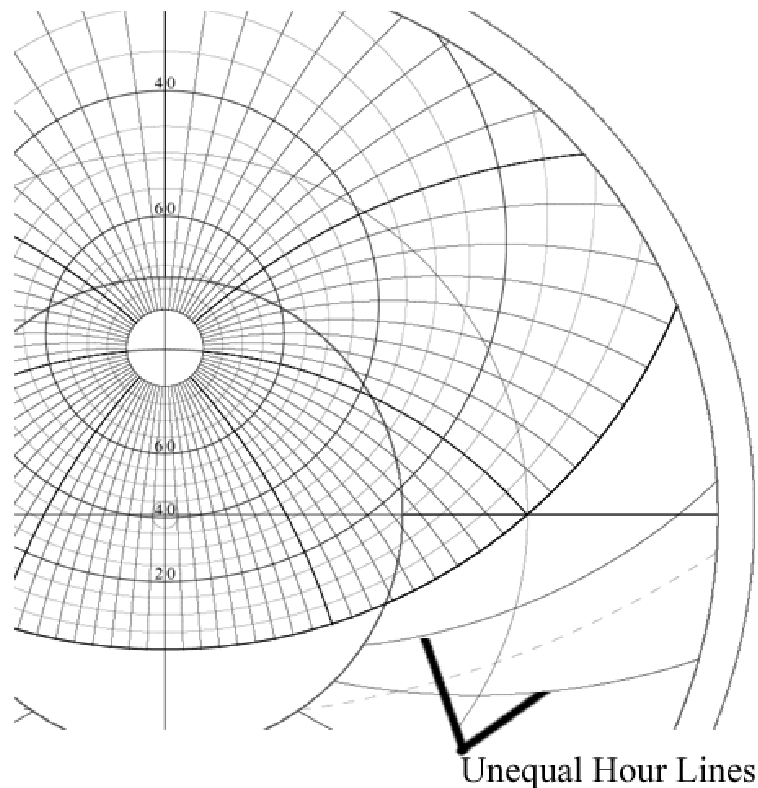

### Reading the plate

All these lines allow the user to locate objects in the sky with accuracy. Think of the almucantar and azimuth lines the way you would east-west and north-south lines on a map. Just like you can define a town's location as so many degrees north and so many east; you can define the position of a star as so many degrees above the horizon and so many degrees from west.

## Example: Reading the plate

Figure 22: Example - reading the plate scales

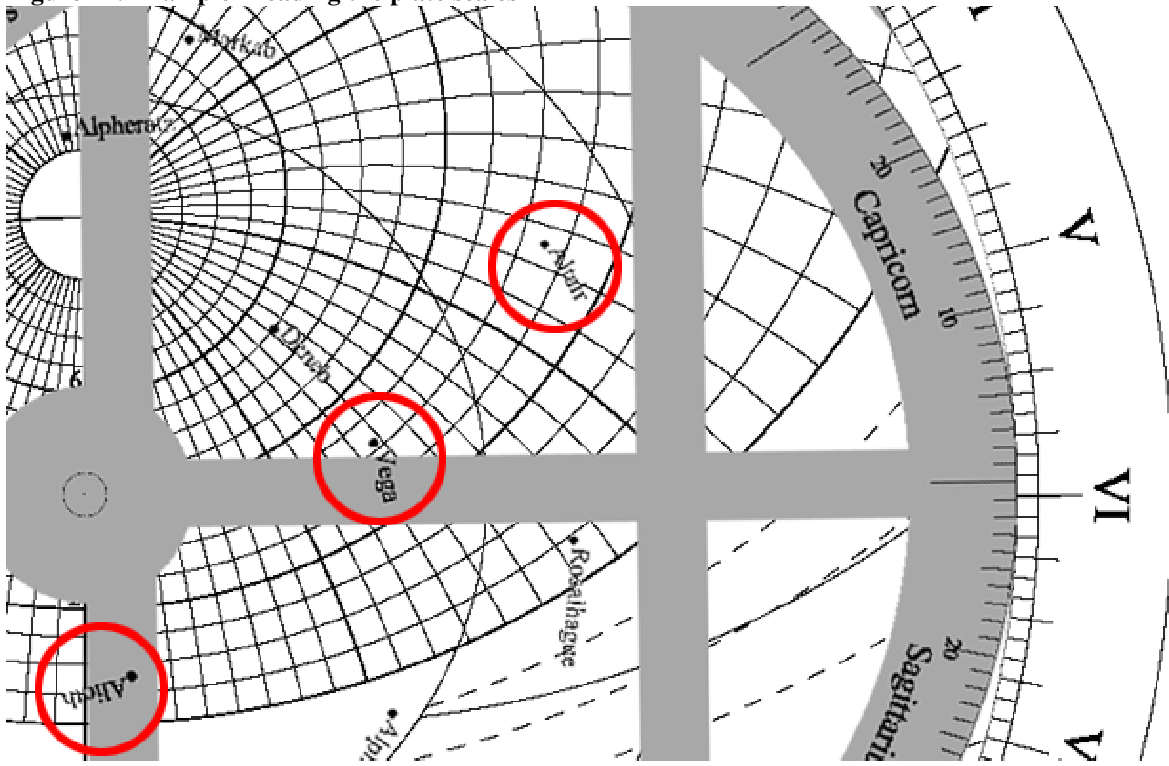

For example, in the illustration above:

- The star Altair (top) is at an altitude of 27.5 degrees above the horizon and is 12.5 degrees south of west (or bearing 257.5 degrees)
- Vega (middle) is 31 degrees above the horizon, 26 degrees north of west
- Alioth (bottom) is about 10 degrees west of north, and about 8 degrees above the horizon.

## The Rete Scales

In the chapter on astrolabe theory, it was stated that the rete is a projection of the major landmarks of the celestial sphere. As described above, the lines for the tropics and the equator are transferred to the plate for simplicity's sake. This leaves the rete with the ecliptic and the positions of the major stars.

### Star positions

Historically astrolabes only display a dozen or so of the most useful stars: Those stars that are bright enough to be recognized easily, and are positioned conveniently in the sky for taking sights on. Polaris, the North Star, is, of course, positioned at the rete's center pivot. The other stars are placed in their projected positions. On a medieval rete the positions of the major

stars will be marked with pointers in various styles. In the example I have just marked the position with a dot.

{examples of pointers}

Figure 23: Rete (typical)

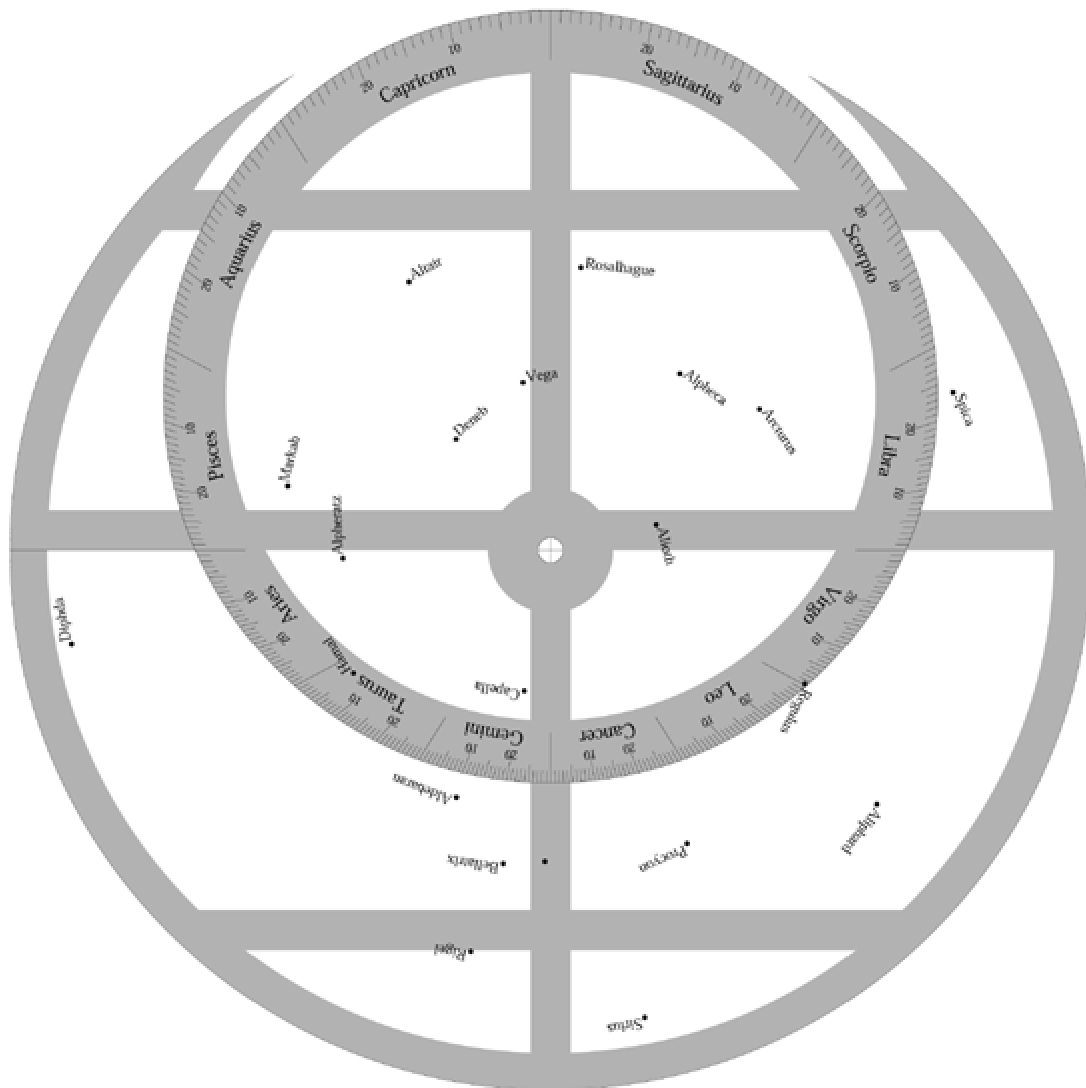

### Ecliptic

On every astrolabe rete you will find an off-center ring representing the ecliptic, the sun's annual path through the sky. This is most often marked out in degrees, and on medieval retes the degrees are most often grouped into the twelve signs of the zodiac, with thirty degrees per sign. Looking at the close-up in Figure 24 you should note that the motion of the sun along

the ecliptic is counter-clockwise; while the daily motion of the sun through the sky from sunrise to sunset is clockwise.

**Figure 24: Rete close-up**

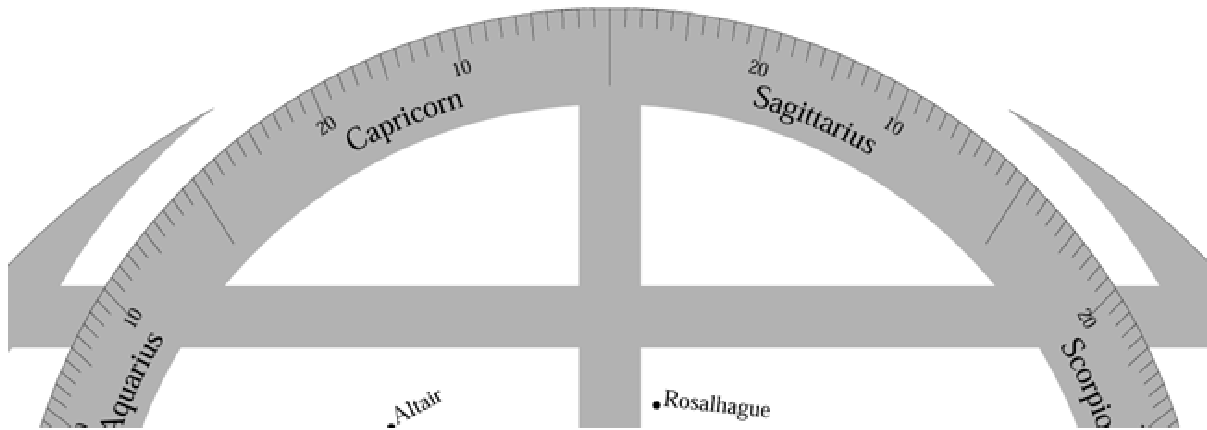

## The Rule

The rule is the rotating pointer that sits on top of the rete. Depending on the maker, the rule might be single or double-ended.

**Figure 25: The rule (typical)**

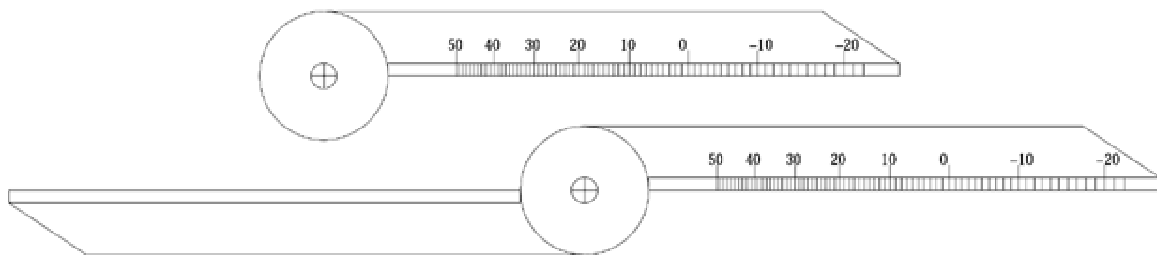

## The Declination Scale

On some astrolabes, the rule is provided with a declination scale, a scale marked in degrees above and below the celestial equator. The declination scale will be discussed in depth later.

## 5. The Rear Scales

The back of the astrolabe is a busy place. The sheer number of scales that can be found on various examples is staggering. A full description of all the possible scales is beyond the scope of this manual. In this section we will discuss the most common and important scales. In later chapters we will introduce and explain in detail some of the other scales you might encounter.

Figure 26: The Rear of the astrolabe (typical)

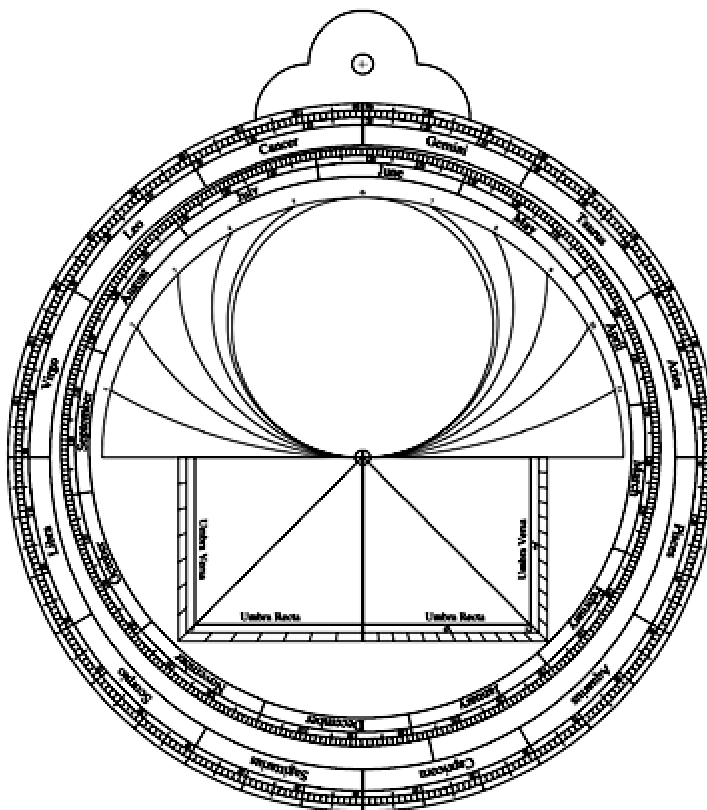

On most astrolabes the outer rim of back of the astrolabe is marked with three more-or-less concentric scales:

### The Altitude Scale

In the example below the outermost scale is the altitude scale. This scale is marked in degrees from 0 to 90 as shown. When used in conjunction with the rotating alidade (sighting arm), it can be used to measure angles. In particular, if the astrolabe is suspended by the throne, the altitude scale will measure angles above the horizon very accurately. This technique is used to measure the altitude above the horizon of the sun, or sighting stars.



Figure 27: The Back Scales - Detail

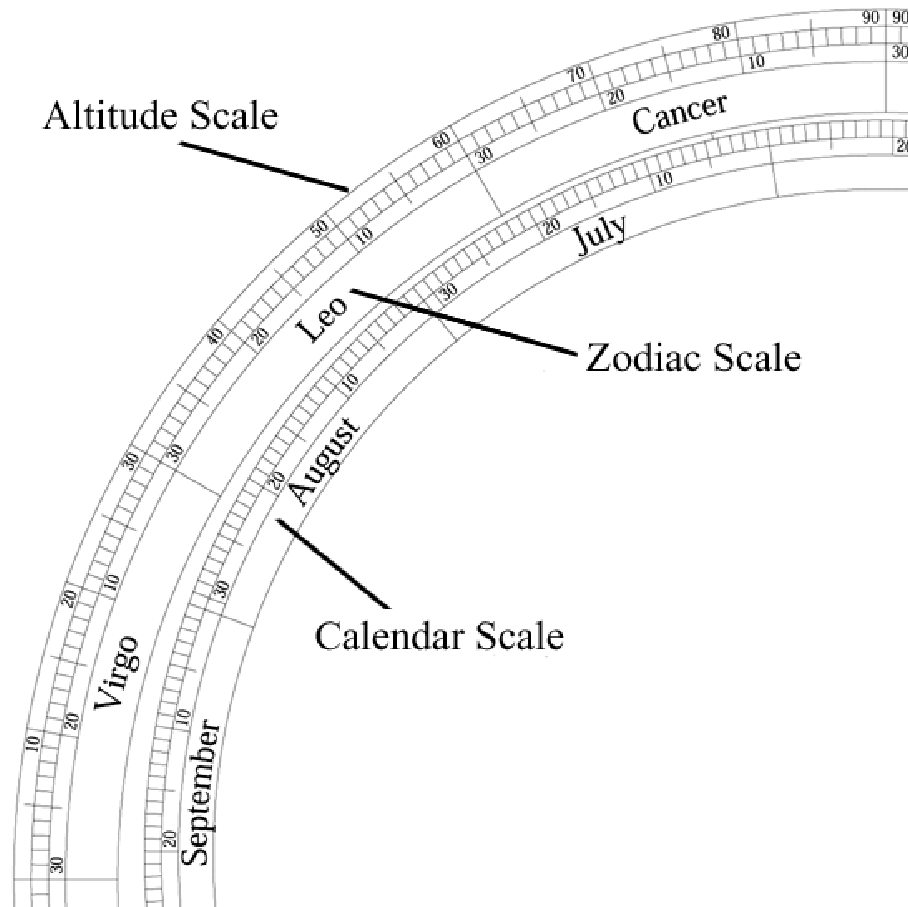

### The Zodiac Scale

The next scale inward is the zodiac scale. This scale is marked off in 360 degrees, and is broken up into twelve 30-degree sections in the same manner as the ecliptic ring on the rete. This zodiac scale represents the path of the sun through the sky over the course of a year, and is used in conjunction with the calendar scale.

### The Calendar Scale

Inward from the zodiac scale on the example is the calendar scale. As you can see it is marked off in the 365 days of the year, broken down into the twelve months. This scale is carefully aligned with the zodiac scale so that when the alidade is used as a pointer, setting the alidade to a given date will show the location of the sun on the zodiac for that date. This works in reverse as well: You can find the date the sun is at any position on the zodiac.

Depending on the design of the astrolabe, the calendar ring might be concentric or offset as it is in the example.

## Example: Finding the Sun's position on the Zodiac

Figure 28: Finding the Sun's Position

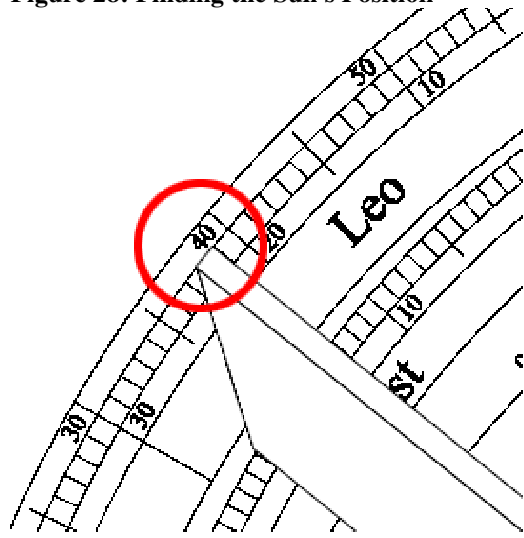

Left: 13 August / Leo 21.

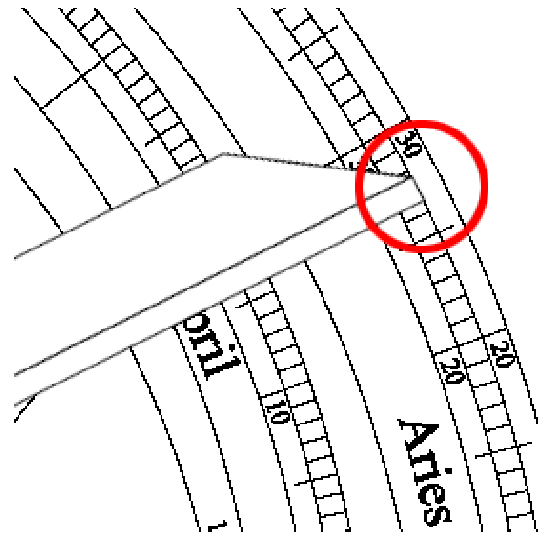

Right: Noon April 16 / Aries 26.5

Note that when reading the scales, the lines mark the end of the day. For example, on the right, the alidade is placed half way between the 15 mark and the 16 mark. (Noon on the 16th is half way between midnight on the 15th and midnight on the 16th)

# Part 2: Using the Astrolabe

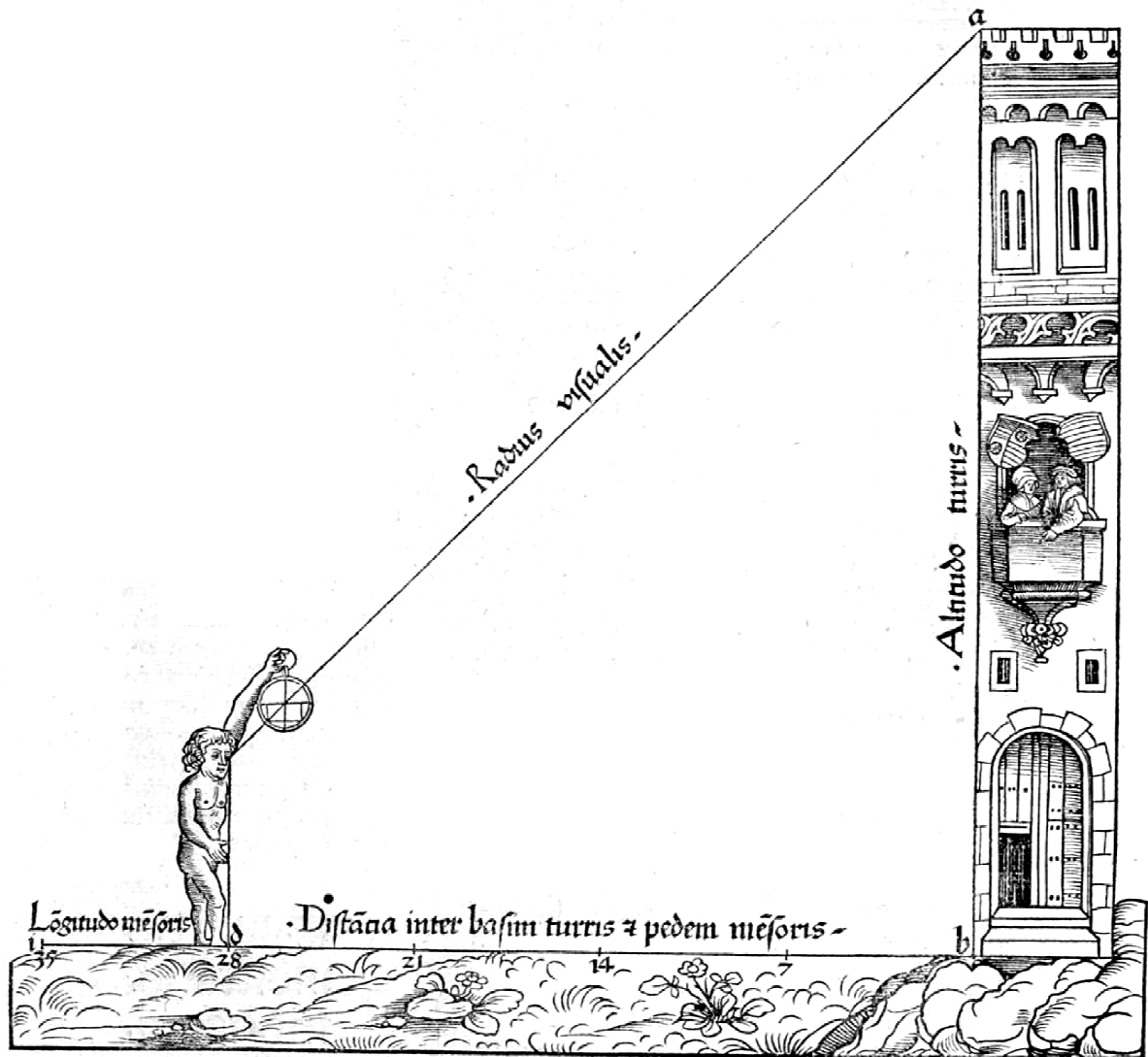

## **Example: Finding the Time**

In just about any introductory computer manual there will be found the “hello world” example. Let’s keep with tradition and run through a simple example problem on the astrolabe.

***Problem: It is the morning of the 13th of March and you want to know what time it is.***

As explained above, the zodiac scale on the rete shows the annual path of the sun through the sky. If it is used in conjunction with the zodiac and calendar scales on the back of the astrolabe, you can locate the sun in the sky for any day and time.

To find the local time, you will first need to take a sighting with the astrolabe to determine the angle of the sun:

{ Insert graphic of sun sighting }

In the example above, the user has taken a sight on the sun using the alidade and the altitude scale on the back of the astrolabe, and has measured its angle above the eastern horizon as 25 degrees.

{ Insert graphic of finding the sun’s location }

Next, using the zodiac and calendar scales the user finds that on the morning of the 13<sup>th</sup> of March the sun is in Pisces 10.

{ Insert graphic of setting the rete }

Next you set the astrolabe to match the local sky by rotating the rete to place Pisces 10 at an altitude of 25 degrees above the horizon line. It is the morning, so you would use the left (morning) side of the astrolabe plate. The astrolabe now matches the configuration of the local sky.

{ Insert graphic of setting rule }

Finally, you will need to rotate the rule around until it is touching Pisces 10; the local time can now be read from the time scale on the limb: 8:54 am.

A note on accuracy: astrolabes differ a bit from one instrument to another. Therefore if you are working along with the example astrolabe, you may get a slightly different answer.

## **1. Using the Rear Scales – Basic**

### **Using the Alidade and the Altitude Scale**

One of the primary functions of the astrolabe is measuring angles, especially angles above the horizon. To allow the user to accomplish this, the back of the astrolabe is marked with an altitude scale; when used with the rotating alidade arm, this allows the user to measure angles with a good deal of accuracy. To increase this accuracy, the astrolabe throne is provided with a free-turning ring; attached so that when the astrolabe is suspended from the ring, the astrolabe hangs exactly vertically.

On most astrolabes, the alidade is provided with two sighting vanes. These vanes have a small hole or notch cut in each so that sighting along the vanes aligns the eye with the alidade.

Holding the astrolabe up by the ring and sighting a target along the alidade using the vanes can measure the angle to the target accurately.

Care should always be taken when making a sighting on the sun. Looking directly into the sun is not a good idea, and can cause permanent damage to the eyes. Instead hold the astrolabe so that you can see the light that shines through the front sight where it lands on the rear vane, and adjust the angle until it lands on the rear sight hole. From an astrolabe manual written in 1362:

“We have to hold the astrolabe firmly by the ring by one of our fingers and turn the edge toward the sun. We raise and lower the rule until the rays of the sun coming through the vane on the end of the rule thus set, pass through the corresponding hole of the vane on the other end of the rule.” (De Prusse: 41).

When sighting on stars at night you may find that there is not enough light to see through the holes; in this case you can sight over the tops of the vanes and align them with the star you are sighting on.

[sighting diagram]

Once you have adjusted the alidade arm to the correct angle, you can then read the angle from the outermost scale.

**Figure 29: The sighting vanes on the alidade**



## Using the Alidade with the Zodiac and Calendar Scales

In addition to its use in measuring angles, the alidade can be used as a pointer with several of the scales on the back of the astrolabe. The most common of these scales are the zodiac and calendar rings. As discussed above in Part 1, these two scales work together to indicate the position of the sun on the ecliptic for any day of the year. The outer, zodiac, ring is divided into 360 degrees, broken down into twelve sections of 30 degrees each. The calendar ring is divided into 365 segments, broken up by the months.

Figure 30: The calendar and zodiac scales

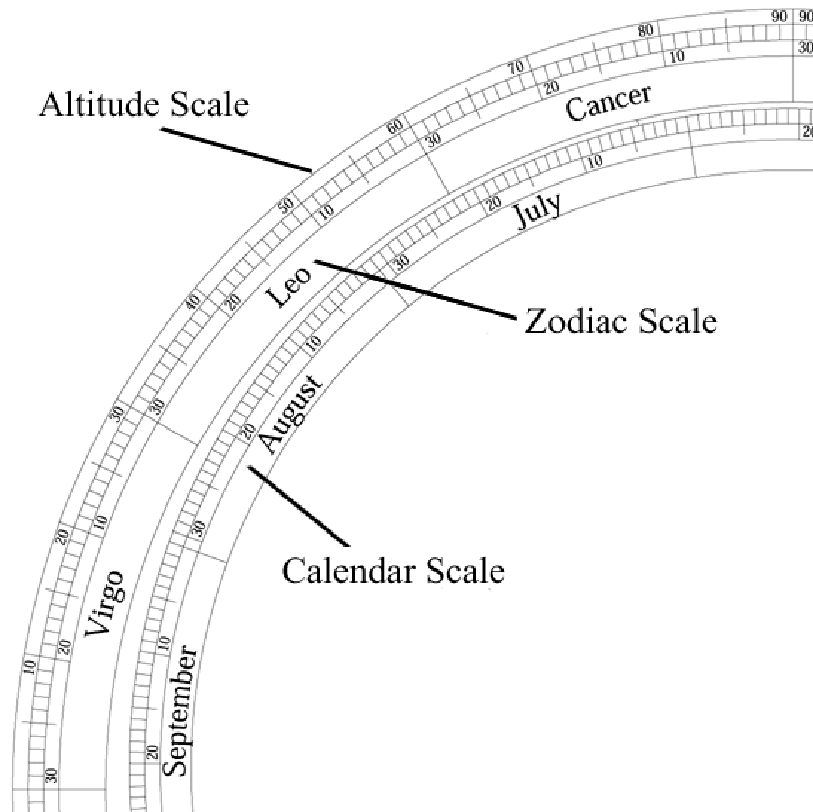

To use these scales the user would rotate one end of the alidade around until its edge was aligned with the date required. Then the zodiac location can be read from the zodiac scale.

On the calendar scale the lines marking the days indicate the end of the day. If you wanted to set the alidade to noon of the fourth of May, you would align it so that the edge was halfway between the mark for the third and the mark for the fourth. If you wanted to set it for the morning of that day, you would align the edge approximately a quarter of the way from the mark for the third to the mark for the fourth. For the evening you would align it three quarters of the way between the marks.

[examples]



# Appendixes

## Bibliography

---

De Prusse, Pèlerin; Laird, Edgar and Fischer, Robert. *Pèlerin De Prusse on the Astrolabe / Text and Translation of His Practique De Astralabe*. Binghamton, NY: Medieval & Renaissance Texts & Studies, 1995.

Morrison, James E. *The Astrolabe*. Janus, 2007.

Neugebauer, O. *The Early History of the Astrolabe*. Studies in Ancient Astronomy IX, Isis, Vol. 40, No. 3 (Aug., 1949), pp. 240-256

Pingree, David, and Bruce Chandler. *Eastern Astrolabes*. Historic Scientific Instruments of the Adler Planetarium Series; Vol II. Adler Planetarium, 2009.



## Glossary

---

- Alidade** The rotating arm on the back of an astrolabe, usually with two raised sighting vanes. The alidade is used for measuring angles. See diopter.
- Almucantar** A circular line on the astrolabe plate that marks a given angle above the horizon.
- Altitude** Vertical angle: When used in this manual, altitude refers to the observed angle above the horizon. (“Altitude above the horizon”)
- Azimuth** Horizontal angle: Either a compass direction, or an angle given from a compass direction (“18 degrees south of west”)
- Celestial Equator** The imaginary line in the sky that marks the division between the northern and southern sky. A projection of the earth’s equator. See also declination.
- Climate** Also referred to as a plate or climate plate. This is the part of the astrolabe that contains the projection of the local sky. Usually removable, and part of a set.
- Declination** An angle measurement of degrees above or below the celestial equator: The sky’s equivalent of the earth’s latitude. A positive declination denotes north, a negative number denotes south. See also right ascension, celestial sphere.
- Diopter** An aperture sight; a sighting device using two small openings to accurately align a device with a target.
- Ecliptic** The apparent path of the sun through the sky as the earth orbits the sun: Associated with the zodiac constellations. The visible planets are also always found within a few degrees of the ecliptic.

Equinox

First Point of Aries

Gnomon

Limb

Mater

Meridian

Nadir

Plate

Rete

Right Ascension

Rule

Solstice

Throne

Tropic of Cancer

Tropic of Capricorn

Zenith

Zodiac

## Recommended Reading

---

**Chaucer, Geoffrey. A Treatise on the Astrolabe, addressed to his son, Lowys, A.D. 1391, edited by Walter Skeat, London (1872).**

The first book on the subject written in English. Not very useful, but a good place to start and widely available. Search Google Books: <http://books.google.com>

**Grant, Edward. A Sourcebook in Medieval Science, Harvard University Press (1974)**

Not much in here about the astrolabe, it is only mentioned a few times in passing. But there is a very nice geometric proof for the function of the shadow squares, and John of Sacrobosco's "On the Sphere" is a wonderful discussion of the Ptolemaic Earth-centered theory that underlies the design of the astrolabe.

<http://amzn.com/0674823605>

**King, David A. A Survey of Medieval Islamic Shadow Schemes for Simple Time-Reckoning. Oriens, Vol. 32 (1990), pp. 191-249**

Gives the background theory for the shadow squares and their relationship to timekeeping. Can be found on JSTOR, if you have access.

**Morrison, James. The Astrolabe, Janus, 2007**

This is the definitive work on the history, design, construction and use of the astrolabe, and a host of related instruments. Required reading for anyone interested in the Astrolabe. If you can buy just one book, it should be this one.

<http://amzn.com/0939320304>

**Neugebauer, O. The Early History of the Astrolabe. Studies in Ancient Astronomy IX, Isis, Vol. 40, No. 3 (Aug., 1949), pp. 240-256.** Historical background on the astrolabe. Can be found on JSTOR, if you have access.

**Pingree, David and Chandler, Bruce. Eastern Astrolabes (Historic Scientific Instruments of the Adler Planetarium Series; Volume II), Adler Planetarium, 2009**

A catalog of astrolabes and related tools in the Adler Planetarium collection. Very good, detailed photos of actual working astrolabes. An excellent reference. Volume 2 focuses on Middle Eastern and Near Eastern devices.

**Stoeffler, Johannes. Elucidatio fabriquae ususque astrolabii, Oppenheim (1523).**

The original of the book translated below. A scanned pdf of the original Latin text is available online at:

[http://www.univie.ac.at/hwastro/books/1513\\_stoe\\_ColMed.pdf](http://www.univie.ac.at/hwastro/books/1513_stoe_ColMed.pdf)

**Stoeffler, Johannes. Stoeffler's Elucidatio - The Construction and Use of the Astrolabe, English translation by Alessandro Gunella and John Lamprey, Classical Science Press, 2007**

This is a translation of a 16<sup>th</sup> century manual on the construction and use of the astrolabe; expensive, but second only to Morrison's book for usefulness.

<http://www.classicalsciencepress.com/books/Stoefflers-Elucidatio-John-Lamprey.html>

**Webster, Roderick. *Western Astrolabes (Historic Scientific Instruments of the Adler Planetarium Series; Volume I)*, Adler Planetarium, 2007**

A catalog of astrolabes and related tools in the Adler Planetarium collection. Very good, detailed photos of actual working astrolabes. An excellent reference. Volume 1 focuses on European devices.