



# **WORKING DOG TRIAL OFFICIAL RULES**

**USCA Trial Rules, Variances, and Guidelines**  
*Revised from the WUSV / FCI Working Commission Rules and*  
*Approved for USCA Working Dog Events*  
*November 2015*  
*Version 1.2*

This document is a partial translation of the rules for the conduct of working dog examinations as used in the WUSV and approved by the FCI in cooperation with the FCI Working Commission and the WUSV / SV. These rules have been adopted for use by the **United Schutzhund Clubs of America (USCA)** with certain amendments and variations. This document and any approved amendments shall be the official rulebook for the conduct of working dog evaluation events sanctioned by the **United Schutzhund Clubs of America**. Unauthorized duplication is strictly forbidden without approval from the **United Schutzhund Clubs of America**, 4407 Meramec Bottom Road, Suite J, St. Louis, MO 63129. (314) 638-9686.

These trial regulations are the USCA approved revisions and edited version including USCA approved variances. This document has been translated from the original FCI and WUSV / SV trial rules, reviewed, rewritten, edited to correctly and effectively address the requirements for USCA Working Dog Trials while still meeting the FCI / WUSV requirements by the USCA Director of Judges, Nathaniel Roque, and Assistant Director of Judges, Ann Marie Chaffin, final review and approval by the USCA Judges Committee: Jim Alloway, Michael Caputo, Debbie Zappia, Mike Gardner and the USCA Executive Board. These trial regulations will replace any prior regulations and will apply to all judges, clubs, members of USCA and any entry into a USCA Authorized Event. In any unclear rule, the WUSV / SV (German wording) rulebook will be reviewed by the Director of Judges and may change the meaning / intent of the USCA rule. Any changes must be done with approval of the USCA Director of Judges and / or the USCA Judges Committee.

The United Schutzhund Clubs of America is a proud member of the IRO and the American Working Dog Federation and also offers the RH 1, RH 2 and the AWD 1-3 Working Titles. Rules for these titles are available in additional rulebooks from the AWDF and the IRO. Members of the AWDF, FCI, and WUSV member clubs participating in USCA events will be held to the following working rules.

## **PREFACE**

The United Schutzhund Clubs of America is a full member Club of the World Union of German Shepherd Dogs (WUSV). Its mission is to "preserve the German Shepherd Dog" in part through the use of approved breed programs, "Breed Surveys", "Working Dog Trials", and education. USCA supports the efforts of the WUSV and its mission for the German Shepherd Dog and recognizes the value of trials for both "breed temperament testing as well as for organized dog sport". The purpose of the following rules and guidelines are for breed suitability for the German Shepherd Dog as well as for organized "dog sport and competition" for all working breeds.

### **PREAMBLE FROM THE WUSV / FCI COMMISSIONS ON WORKING DOGS**

For more than 12,000 years, the dog has been the companion of mankind. Through the domestication of the dog, a close social relationship has been formed with mankind and is in some respects dependent on him. With this comes a certain responsibility on the part of man to ensure the well-being of the dog.

When it comes to training, the physical as well as the psychological health of the dog is top priority. It is imperative then that the dog be handled in a fair, orderly, and humane way. This also should include adequate care of the dog through proper nutrition and water as well as maintaining his health. This should include regular vaccinations and veterinary examinations. In addition to this, there is an additional duty to the dog to properly socialize him and to ensure exercise to meet his needs.

During the course of history, the dog has had various jobs to help man. In the modern day world, many of these duties have been relegated to technology. For this reason, the dog owner has the responsibility to ensure that the dog has other activities due to the loss of past jobs as well as adequate exercise and activities that offer close contact to people. Under this point of view, the Companion Test - BH, the versatility test for the working dog, the tracking test - FH, and the article search test - STP, need to be factored in. The dog should be occupied according to his abilities and capabilities. Besides adequate exercise, he should have intense work with activities that take into consideration his learning ability, his exercise requirements, as well as his

other abilities. The various forms of the dog sport provide these excellent venues. Dogs that do not have enough activities stand out and this can lead to public complaints.

A person, who trains or does sport with his dog, has to undertake a method of careful training with the goal in mind to achieve the best possible harmony between himself and the dog. The goal of all training is to convey to the dog what it is we want him to do in such a way that he can understand. The harmonious agreement between man and his dog, regardless of the dog sport one does, is the basis for all activities. To achieve harmony, it is important to go into the dog's world and understand his abilities.

It remains the ethical responsibility of man to raise and adequately train the dog. The applied methods must meet the standards of behavioral scientists and be effective socially accepted methods of training as related to the working dog especially in regards to the breed. In order to achieve the upbringing, training or training effect, it is important to not utilize excessive/unnecessary compulsion or force and to implement and balance the use of positive methods for the dog. Furthermore, it is imperative to decline the use of techniques that do not utilize the proper training, raising, or training aides or use abusive training aids and equipment. Using a dog for dog sport has to be oriented to his capabilities, his competitive spirit, and his willingness. Influencing the dogs' learning capabilities through the use of medication or animal cruelty is to be declined. One must carefully acknowledge the capabilities of his dog. *To demand work of a dog that does not have the capability to do so, contradicts every ethical level of consciousness.* Only someone who takes the responsibility to be a true friend to his dog will take a healthy and capable dog to trials, competitions, and training.

## TABLE OF CONTENTS

<b>PREFACE.....</b>	<b>3</b>
<b>PREAMBLE FROM THE WUSV / FCI COMMISSIONS ON WORKING DOGS.....</b>	<b>3</b>
<b>USCA APPROVED VARIANCES.....</b>	<b>6</b>
<b>GENERAL RULES AND REGULATIONS .....</b>	<b>11</b>
<b>POINT SCORE AND RATINGS .....</b>	<b>15</b>
<b>TRIAL PARTICIPANTS.....</b>	<b>19</b>
<b>DUTIES OF THE TRIAL SECRETARY.....</b>	<b>23</b>
<b>HELPERS FOR USCA TRIALS.....</b>	<b>26 &amp; 76</b>
<b>THE TEMPERAMENT (IMPARTIALITY) TEST.....</b>	<b>26</b>
<b>ABBREVIATIONS .....</b>	<b>29</b>
<b>PHASE A - TRACKING.....</b>	<b>30</b>
<b>PHASE B - Obedience.....</b>	<b>48</b>
<b>PHASE C - PROTECTION WORK .....</b>	<b>76</b>
<b>COMPANION DOG TEST (BH).....</b>	<b>109</b>
<b>ENDURANCE TEST (Ausdauerprüfung) - AD.....</b>	<b>113</b>
<b>IPO - Preliminary stage (IPO-V).....</b>	<b>116</b>
<b>STP.....</b>	<b>127</b>
<b>AWD &amp; RH Titles.....</b>	<b>132</b>
<b>APPENDIX A - DIAGRAMS.....</b>	<b>133</b>
<b>Tracking Patterns.....</b>	<b>133</b>
<b>ON / OFF LEASH HEELING.....</b>	<b>136</b>
<b>PROTECTION DIAGRAM AND FIELD LAYOUT .....</b>	<b>140</b>
<b>ESCAPE BITE LAYOUT .....</b>	<b>142</b>

## **USCA APPROVED VARIANCES**

*(IPO, FH, APr, StP, AD, AWD)*

The United Schutzhund Clubs of America has adopted and / or requested and received variances from the following international rules. The Board of Directors of USCA has also adopted variances of its own accord. The following variances to the rules are in effect for all USCA trials.

1. Handlers may enter up to three (3) dogs in USCA club level trials except any and all championship trials (e.g., Regional Championship, Working Dog Championship, National Championship) where the specified limit of two (2) dogs shall apply.

2. Clubs may use Friday or Monday under specific circumstances to host events offering all performance titles and degrees awarded by USCA. Performance titles such BH / IPO 1, 2, 3 / FH 1, 2 / APr 1, 2, 3 / DPO (any) must be offered on Saturday and / or Sunday. Friday and Monday may only be used as over flow in the event that there are more than 24 phases scheduled on the adjoining Saturday or Sunday and under specific circumstances due to weather or time constraints. Some BH entries or up to 2 phases of an IPO entry may be completed to meet these weather or time (schedule) needs. Any BH entry that is also entered to earn their APr 1 or IPO 1 on Saturday or Sunday may complete the BH the day prior (e.g., Friday BH and Saturday IPO). At all times if Saturday or Sunday are not exceeding 36 phases all working title entries (IPO) must complete at least 1 of the 3 phases on Saturday or Sunday. At all times efforts should be made to schedule all phases of the trial on Saturday or Sunday to allow public attendance at the event.

If clubs anticipate more trial entries than can be accommodated in two (2) days, a three (3) day event should be authorized with performance titles offered on both days of the weekend and the extra day intended for overflow as described above or to allow BH entries to be earned prior to attempting the APr 1 or IPO 1 on Saturday or Sunday. Clubs are allowed to offer performance titles on Friday or Monday and just one (1) day of a weekend if they are also hosting a Breed Survey or

Conformation Show on the other day of the weekend. Breed Surveys and Conformation Shows must be held on Saturday or Sunday.

A three (3) day event will not be allowed unless the club has three (3) days of activities. It is not intended to allow a club to host an IPO trial on Friday or Monday and a one (1) day event on the weekend. The three (3) day event is intended for larger events with multiple venues. The Regional Director must receive a request from the club for a three (3) day event and will authorize three (3) day events only in the cases listed above. A tentative schedule of the event must be published to the region at least 21 days in advance. All other USCA trial regulations are applicable.

3. The minimum number of dogs for an official working trial is four (4) entries, and one (1) of the entries must be a Working Title (IPO, FH). Four (4) different dogs must be present at the trial.

4. All entries in a USCA Trial must be current USCA members or members of a USCA approved organization. Non-USCA entries into USCA Events will be subject to additional entry fees. All residents of the United States must be a member of a United States USCA recognized Dog Organization; foreign residents may enter at club level competition, provided they have current membership in a foreign dog organization that is USCA recognized: FCI, WUSV Member Club, SV, or DVG.

5. Entry into any USCA Championship Event (regional, national) requires current USCA Membership in good standing.

6. Judges authorized to officiate at USCA Events are:

- USCA Licensed Judges
- SV Licensed Judges
- GSSCC Licensed Judges
- FCI Licensed Judges from WUSV Member Organizations

The United Schutzhund Clubs of America is a full member of the WUSV, a German Shepherd Dog Organization, and as such may only allow judges from German Shepherd Dog Organizations to officiate our events. The

Working Dog Trial is a portion of the breed temperament testing for the German Shepherd Dog as well as an all-breed sport competition. The above licensed judges are licensed through WUSV and therefore trained to observe and evaluate the desired temperament of the German Shepherd Dog in a working dog trial as well as the competitive component of "working dog sport". Approval must be obtained to use a foreign judge at a USCA Trial. Information on obtaining a judge is on the USCA website.

Titles awarded by USCA or SV Judges are suitable for breed requirements for the USCA/SV Breed Survey.

7. All dogs entered in a USCA event must have a USCA issued scorebook or a scorebook issued from a USCA recognized organization. Scorebook bonds in lieu of a score book may be posted by USCA members only to enter a USCA trial.

8. All titles / awards must be earned in a progression. (i.e., IPO 1, 2, 3 / APr 1, 2, 3 / TR (FPr) 1, 2, 3 / OB (UPr) 1, 2, 3, etc.) Since an IPO title requires passing all tracking, obedience and protection, the exception to this is any dog having earned an IPO title may enter a TR, OB, APr at a lower or same level as their current IPO title or may attempt to earn the next higher TR, OB, or APr award instead of repeating all in progression 1-2-3. (i.e., a dog with an IPO 1 may enter for a TR 2, OB 2, or APr 2 or lesser level.)

9. All dogs entered into a trial may not exceed three (3) phases of work in a single trial with the exception of adding an AD with another title or a BH before an IPO 1 title. (i.e., a dog may enter for TR (FPR) 1 and OB (UPr) 1 in the same trial = 2 phases.)

10. All helpers participating at a USCA event must have a current USCA Membership and USCA Helper Book with current "classification" to be allowed to work the level of trial they are participating in. At club level events the helper may be a member of the household of an entry. The same helper is required to work all dogs in a specific level. (i.e., same helper for all IPO 1 entries, same helper for all IPO 3 entries, etc.) This is



to help ensure a fair and equal venue for all dogs. At club level events, only one (1) helper is required. The same helper is to be used for the front-half and back-half of the IPO 1 and IPO 2. At championship level events, two (2) helpers are required for IPO 3 (one (1) front-half and one (1) back-half helper). Additional requirements and information are listed in the USCA Helper Program available on the USCA website. At all times during the trial, the helper is under the direction of the judge.

11. Trial secretaries must be current members of USCA and may not be entered in the trial.

12. Tracklayers do not have to be USCA members for a club level event, but must be USCA members for a championship event (e.g., Regional Championship, Working Dog Championship, National Championship).

13. The start of a trial is determined by one (1) of the following:

- At championship events the start is the draw (a designated time that the entries draw for placement and turn in scorebooks to the trial secretary).
- At club level events the start is determined to be after the scorebooks have been turned in or when the first dog has started a phase of the trial for that calendar day.

14. No practice may be done on the trial venue or fields after the official start of a trial or during the course of the trial. At championship events practice for entries ends at the draw and the turn-in of scorebooks and continues to the end of the event at the awards ceremony. At multi-day club level events (with the permission of the judge), entries may practice on the trial venue after the conclusion of each day's official trial activities (e.g., Saturday trial begins at 7 am and concludes at 4 pm as listed on the trial paperwork. After 4 pm until the official start of the trial on Sunday, entries may practice on the trial venue with the permission of the trial secretary and the presiding Judge).

"Bitches in Season" will be placed at the end of the event for Phases B and C (obedience and protection) and allowed practice time at the end of the trial prior to their competition.

**During practice, commonly used corrective devices (e.g., prong, choke, electric collars, or heeling sticks, etc.) may be used in a commonly accepted humane manner. Motivational training aids may be used as well.**

15. After the official start of the trial and during the trial, corrective devices may not be used on or within sight of the trial venue (the venue is considered to be all trial fields to include tracking fields, competitor parking or any area within the spectator's sight of the event venue). (i.e., corrective devices are choke, pinch, electric collars, heeling sticks, etc.) Abuse of these methods may lead to disqualification and / or BOI Charges.

16. Motivational methods of training (e.g., food, toys, etc.) may be used during the trial until reporting into the Judge or entering the trial or tracking field. During tracking, motivational methods of training can only be used at the official designated parking area for tracking. If a competitor is allowed to drive closer to their track the official parking area is NOT considered where they are parked. No starter tracks on the official tracking field. Starter tracks can be laid right next to the parking area, or they can be done on another field away from the official tracking field with host club's permission. (This is to ensure every competitor has the same advantage.) At the trial field (stadium or club field) during obedience and protection, off of the trial field is considered to be behind the fence or on the change of terrain that is different from the trial field. All use of motivational objects must be stopped, and they must be discarded before entering the trial field. The judge may ask the handler to remove any item that may be a signal or influence the performance of the dog. (i.e., help for the dogs like gloves, hats, vests, etc.)

17. Trial Paperwork must be submitted with fees to the USCA office within five (5) days of the completion of the event. USCA requires an administrative entry fee per entry when submitting trial paperwork. There are two (2) fee structures; one (1) is for USCA Member Entries and then a fee for Non-USCA Member Entries and the amounts of these fees are determined by the Board of Directors. Individual clubs hosting the trial may also charge an additional "Trial Entry Fee" at an amount of their decision.

#### 18. Field and equipment guidelines:

All trial fields must be large enough to properly complete the required exercises for the IPO examinations. The minimum size for a working dog trial field is 100' by 200' and must be approved by the Regional Director when affiliating a club. All championship events must meet the standards set by the National Events Manual. At all trials, regardless of the titles offered (examination levels), the obedience field must be set up with the jump, wall and three (3) dumbbells (the WUSV recommendation for the jump and wall are to be set up side by side) and a single blind for the IPO3 long down exercise. For protection for all IPO levels, the field must be set up with all six (6) blinds in proper staggered position (length to width ratio of 100x80) and no other equipment (e.g., jump, wall, dumbbell stand, etc.) shall be on the field. For Championships the use of fixed blinds or other equipment must be considered in the selection of the field.

The field must also be properly marked. In obedience the long down, start position, start position for the "Retrieve on the Flat", and a five (5) pace minimum starting position from the wall and the jump are to be marked. (The mark for the jump and the wall is minimum distance, and handlers may position further back as they choose). The "Retrieve on the Flat" must be executed in the direction of the "Send Away". If the jump and the wall are side by side, the direction of these exercises is to be in the direction of the "Send Away".

The layout and direction of the work may be determined by the hosting club, but at any time at the judge's discretion based on concerns for safety, sportsmanship, etc., the judge may request the field layout and / or direction of the work be changed.

## GENERAL RULES AND REGULATIONS

### DEGREE (EXAMINATION) LEVELS

Begleithund	Entry Trial Level	BH	(fundamental / entry level)
APr	Trial Level 1-2-3	APr 1-2-3*	(sporting titles)
IPO	Trial Level 1-2-3	IPO 1-2-3 (Breed Suitability / sport titles)	
IPO V	Entry Trial level	IPO VO	(sporting titles)
Endurance test	AD		(fitness title for Breed Suitability)
Tracking	Trial Level 1-2-3	FPr / Tr 1-2-3	(sporting titles)
Obedience	Trial Level 1-2-3	UPr / OB 1-2-3	(sporting titles)
FH	Trial Level 1-2	FH 1-2	(Breed Suitability/sport titles)
IPO-FH	Trial Level	IPO-FH	(Breed Suitability / sport titles)
StP	Trial Level 1-2-3	StP 1-2-3	(sporting titles)
AWD	Trial Level 1-2-3	AWD 1-2-3**	AWD rules available in AWDF
RH	Trial Level 1-2	RH 1-2 ***	(Rules in RH Rulebook, link on USCA website)

For a dog to enter any of the above Trial Levels except for the "AD", they must have obtained a BH

\*APr is obedience & protection together.

\*\* The AWD is the American Working Dog Title established by the rules and guidelines of the American Working Dog Federation (AWDF). USCA is the founding member of this all-breed working dog organization.

\*\*\* The RH is a suitability test to determine ability for Search and Rescue work, USCA is a member of the IRO and promotes the RH as a suitable test. Additional rules and information are available in the official RH rulebook.

### REQUIREMENTS & ELIGIBILITY

Only dogs that appear healthy and can be identified by a tattoo or microchip can be exhibited in a trial. Before being permitted to participate in a trial, each dog must pass a test of impartiality and sureness. The evaluation of self-confidence and impartiality will also take place throughout the entire trial. A dog is to be dismissed from the trial if it demonstrates faulty temperament during the trial, even if the initial test for impartiality was positive.

Minimum age requirement for entry into the various degree levels:

BH / TR (FPr) 1-3 / OB (UPr) 1-3	15 months
AD	16 months
IPO 1 / APr 1-3	18 months
IPO 2	19 months
IPO 3	20 months
FH 1	18 months
FH 2	20 months
IPO-FH	20 months

**PREREQUISITES** - Evidence of achieving the BH title must be presented before entry into any other level, except AD. Dogs that do not possess the IPO 1 title can be permitted to enter the FH provided they have obtained their BH degree. In this case, the awarded title shall have no bearing in regards to Conformation Show or Breed Survey.

**NUMBER OF PARTICIPANTS** - On any given day, when one (1) judge is officiating, a maximum of thirty-six (36) individual phases are allowed. If the entries exceed this figure, the trial must be extended to another day or other judge(s) must be secured to officiate. This maximum number of phases does not apply to championship events.

- The BH, with or without the general knowledge examination, equals two (2) phases.
- The AD event may have up to twenty (20) dogs per one (1) judge. The AD does not count toward the daily maximum phases of a scheduled trial. The AD may be held on the same day as the IPO trial. Dogs may be entered in the IPO trial and the AD.
- A minimum of four (4) dogs must be entered. At least one (1) must be entered for a working title (IPO, FH).
- It is only allowed for any one (1) handler to handle a maximum of three (3) dogs per club trial and two (2) dogs per championship trial.

**WAITING PERIODS** - Dogs are only allowed to be exhibited in one (1) IPO degree (IPO 1, 2, 3 or FH 1 or FH 2) per scheduled trial.

A dog shown in TR (FPr) can be also shown in one (1) OB (UPr) title at the same trial (not to exceed three (3) phases per trial).

***Value for each title or test:***

BH	= 2 phases
FH 1,2	= 3 phases each
TR (FPr) 1,2,3	= 1 phase each
IPO-FH	= 3 phases
OB (UPr) 1,2,3	= 1 phase each
IPO VO	= 3 phases
APr 1,2,3	= 2 phases each
StP 1,2,3	= 1 phase each
AWD 1,2,3	= 3 phases each
RH 1,2	= 3 phases each

No waiting period exists from BH to IPO 1. However, they must be completed on separate days (i.e., BH on Saturday, and IPO 1 on Sunday).

A minimum of 70% is needed to pass any level of a degree in order to advance to the next level. For Breed Survey requirements for the German Shepherd Dog a minimum of 80% in the protection phase must be attained.

**REPEATING DEGREES** - Repeating titles and tests below the IPO 3 level is possible as many times as desired at the title level below what currently is held by the dog. However, the dog going for their initial degree will be ranked ahead of those that have already earned their degree for the same level. This holds true for awards, trophies, placements, sports medals, etc. It is up to the discretion of the handler to repeat an IPO degree without being bound by the waiting period, but not at the same scheduled trial date. It is also not permissible for a handler to participate in two (2) different sanctioned trials on the same day. At the championship level the first-time IPO 3 is considered the same as a dog that has already obtained their IPO 3.

The examination levels are to be completed in sequence (levels 1 - 2 - 3) except for FH. A dog may only be shown at the next higher level upon passing the previous lower level. Please note that a passing score in Phase "C" is a minimum of seventy (70) points. The age requirement is also to be taken into consideration. Dogs that are over six (6) years of age may be put into a senior class. Once a dog is put in the senior class, the dog may only be shown at the trial level IPO 1 and FH 1.

**TRIAL DAYS** - (See Approved USCA Variances #2 at start of rulebook for complete details) Trials are by nature a public event and should be held on Saturdays and Sundays. Fridays and in special circumstances Mondays may be used. Trials that use Friday must start after 12:00 noon. In special situations Mondays and officially declared holidays may be approved. Friday trials can only be sanctioned in combination with a Saturday trial. Monday trials may only be approved in combination with Saturday and Sunday and, only if, more dogs enter Saturday's and Sunday's trial than can be accommodated. If a local club after the flier has been sent wishes to extend their trial to Friday, they must have permission from the Regional Director and notice must be received seven (7) days in advance by the entire region in which the trial is being held, stating the location and time. The only exception to the above rule is if a local trial is to be held on Friday in conjunction with a championship (regional level on up).

**NOTE:** In the event of high temperature and due to the time required to complete the AD, the AD may be started on a Friday morning. The head judge or the Regional Director has to be informed and permission obtained.

A handler may enter a BH and / or an FH / IPO level during a two (2) day trial, although the BH must be on a separate day than the FH / IPO degree. A waiting period is not required.

In case of adverse weather conditions, the judge is justified, even against the wishes of the organizers, to discontinue an event already in progress. This termination, however, can only take place in truly extreme conditions such as an icy field, hard driving snow, heavy rain, heavy fog, and so on. The judges' costs in every case are the responsibility of the organizers.

### **POINT SCORE AND RATINGS**

The highest maximum score in each phase shall be 100 points and therefore the highest point total for all three (3) phases shall be 300 points. A title can only be awarded if a dog achieves at least seventy (70) points in each of the three (3) phases.

***Important: To enter a Breed Survey, only a breed relevant title with a minimum protection score of eighty (80) points will be recognized.***

The following ratings shall be awarded with the corresponding point totals:

Insufficient / M (Mangelhaft)	0 - 209 points
Satisfactory / B (Befriedigend)	210 - 239 points
Good / G (Gut)	240 - 269 points
Very Good / SG (Sehr Gut)	270 - 285 points
Excellent / V (Vorzüglich)	286 - 300 points

In the case of a tie where awards are presented, the dog competing in the highest degree with the highest point score in Phase C (protection) shall receive the award. Should there still be a tie, the points scored in Phase B (obedience) and then Phase A (tracking) shall prevail. If a tie still exists, the youngest dog receives the award.

For an APr title, the highest possible point score is 200 points. The passing score for this title is a minimum of seventy (70) points in both Phase B (obedience) and Phase C (protection). The following ratings shall be awarded

with the corresponding point totals:

Insufficient / M (Mangelhaft)	0 - 139 points
Satisfactory / B (Befriedigend)	140 - 159 points
Good / G (Gut)	160 - 179 points
Very Good / SG (Sehr Gut)	180 - 190 points
Excellent / V (Vorzüglich)	191 - 200 points

**SCORES** - The performance is evaluated in ratings (qualification) and points. The ratings (qualification) and corresponding points must reflect the quality of the performance.



### Evaluation Rating / Point Table

Maximum	Excellent	Very Good	Good	Satisfactory	Insufficient
5	5	4.5	4	3.5	3 - 0
10	10	9.5 - 9	8.5 - 8	7.5 - 7	6.5 - 0
15	15 - 14.5	14 - 13.5	13 - 12	11.5 - 10.5	10 - 0
20	20 - 19.5	19 - 18	17.5 - 16	15.5 - 14	13.5 - 0
30	30 - 29	28.5 - 27	26.5 - 24	23.5 - 21	20.5 - 0
35	35 - 33	32.5 - 31.5	31 - 28	27.5 - 24.5	24 - 0
70	70 - 66.5	66 - 63	62.5 - 56	55.5 - 49	48.5 - 0
80	80 - 76	75.5 - 72	71.5 - 64	63.5 - 56	55.5 - 0
100	100 - 96	95.5 - 90	89.5 - 80	79.5 - 70	69.5 - 0

### Percentages of a 100

Rating	Awarded Percentage	Deduction
<b>Excellent</b>	minimum 96	or up to minus 4%
<b>Very Good</b>	95 to 90	or minus 5 to 10%
<b>Good</b>	89 to 80	or minus 11 to 20%
<b>Satisfactory</b>	79 to 70	or minus 21 to 30%
<b>Insufficient</b>	under 70	or minus 31 to 100%

Only whole points shall be given in the overall rating of each complete phase. Partial points may be given for individual exercises. When adding the points upon completion of each phase, and the result does not consist of a whole number, the points awarded may be rounded up or down, depending on the overall impression.

**DISQUALIFICATION** - Should the judge notice temperament faults in the dog, unsportsmanlike conduct by the handler (e.g., alcohol consumption, carrying of motivational objects , food or training devices), offenses against the trial regulations, local animal protection laws, offenses against the moral code, the team will be disqualified from the remainder of the trial ( handler is unsportsmanlike it may include all entries by the same handler.

Disqualification will occur for any out-of-control situation. (common but not all examples are: the dog leaves the handler and does not return with three (3) commands or less, more than the allowed number of commands used, the use of “down”, no or similar commands to gain control.. The dog leaves the tracking, obedience or protection field as **“determined by the judge”**. The dog does not out in 3 or fewer commands or bites anything other than the helpers’ protection sleeve. If the dogs’ temperament is faulty or dangerous as **“determined by the judge”** the team will be disqualified.

***All points given up to the time of disqualification are lost (this includes points earned in other phases). No ratings or points will be recorded. No critique is given. The judges’ decision is uncontestable.***

***There are MANY additional actions that will result in Disqualification or Termination in a the trial (start to end of the event). They are described in further detail within this rulebook. An additional quick reference sheet is located in the “appendix” .***

TERMINATION - Common causes of termination are the dog and handler cannot complete a phase or the dog will not engage the helper. If a team is terminated all points in that phase will be taken away, but the team has to complete the other two (2) phases, or if already completed can keep the points already earned. (i.e., if a team was terminated in obedience and had tracked already, they would have to go on to protection, and they would also keep the score they received in tracking.)

***All points from other completed phases earned up to the time of termination will be recorded. No points and a "M" rating will be entered for the phase terminated. A critique is given up to termination.***

**TSB RATINGS** - Awards for T (Temperament), S (Self-Assuredness) and B (Ability to work under pressure), also known as courage and hardness are:

Pronounced	= "a" (ausgepraegt) or "P" (pronounced)
Sufficient or present	= "vh" (vorhanden) or "S" (sufficient)
Insufficient	= "ng" (nicht genuegend) or "I" (insufficient)

### **TRIAL PARTICIPANTS**

**CONDUCT** - The handler, before the start of the trial, must present their scorebook and a valid membership card to the trial secretary. The judge may also ask for the dog's pedigree and registration certificate. WUSV / FCI and AWDF affiliated members are welcome to trial under these rules at USCA Club Level Trials. USCA Championships require USCA membership.

At the start of the trial, each participant must, when called, report-in to the officiating trial judge in a sportsmanlike manner with their dog on lead or sitting free at heel according to the rules for their trial level (i.e., leashed in the BH). The participant will announce to the judge his / her name, the name of the dog, the degree, the level and phase he / she is participating in. Each participant must follow the instructions of the judge as well as those of the trial committee without any disagreement.

Dogs must perform the work (exercises) with a focused, attentive, free and willing, purposeful overall manner / temperament. A dog showing inappropriate stress or unwillingness to work is faulty, point deductions and / or termination may occur.

Ill-natured actions or poor sportsmanship may lead to expulsion from the trial. The final decision in all cases rests with the presiding judge, and the decision of the judge may not be challenged. A protest is permitted only in written form to the Director of Judges (DOJ). In the event that someone is expelled from a trial by the judge, the USCA Judges Committee will review the situation for further possible disciplinary action.

At no time during the trial are verbal (e.g., "no" or "phooey") or physical corrections allowed, and will result in deductions and / or disqualification (DQ).

Training vests or similar attire to a training vest are not allowed at any level. The judge may ask the handler to remove any item that may be a signal or influence the performance of the dog. (i.e., help for the dogs like gloves, hats, vests, etc.)

All handlers must stay until the end of the event when all scorebooks and awards have been presented at the close of the trial. Leaving early is considered to be unsportsmanlike conduct and may be noted in the scorebook and trial paperwork if the handler leaves prematurely without presenting a reason to either the Trial Secretary or Judge and receiving approval to leave.

**PULLING A DOG FROM THE TRIAL** - A handler must show his dog in all of the trial phases, regardless of the outcome in any one (1) phase, provided that no grounds are given for the judge to terminate or disqualify the performance. If the dog is injured during the trial, or if its performance capacity is diminished, the trial judge has the right to terminate the dog's trial performance, even against the wishes of the handler.

If a handler pulls a dog from the trial on grounds of illness, the following procedure applies:

After completing one (1) or more phases, the handler must consult with a veterinarian or the presiding trial judge to have the dog's illness verified. The trial paperwork will be marked: "Terminated due to illness."

If a handler is unwilling to present the dog to a vet or to the presiding trial judge, the trial documents will be marked: "DQ - Unsportsmanlike because of quitting."

The veterinarian's certificate can be submitted after the trial. If the handler does not submit a certificate before the end of the trial, the judge may take the handler's scorebook with him. If the handler does not submit a certificate

within a week, the judge will record in the scorebook: "DQ - Unsportsmanlike because of quitting."

If the handler refuses to allow the judge to take the scorebook, the entry is immediately made in the scorebook.

The above procedure in no way changes the judge's ability to terminate a dog's participation if he observes that the dog is sick or injured. Similarly, the judge can terminate dogs, which in his / her opinion, are too old or out of condition to be shown publicly. No bandages or braces are allowed on the dog during trialing in any situation regardless of vet release.

If a handler discontinues the trial without authorization of the judge, notification is to be given to the USCA Regional Director, USCA Director of Judges, or the USCA Judges Committee. Unsportsmanlike charges may be filed against the handler.

**ADMISSION OF VIDEO** - At all sanctioned events, video is not permitted as evidence in any dispute regarding trial performances. Complaints regarding sportsmanship and / or behavior of the participants or judges may be otherwise defined in either the Judges Program or the USCA Rules and Regulations.

**WHO MAY PARTICIPATE** - Events are open to all USCA Members and members of USCA recognized dog sport organizations. All entries must have a USCA or USCA recognized scorebook. All entries must be members in good standing with their organizations.

**BITCHES IN SEASON** - Bitches may participate in all events with the exception of the AD, provided they are kept apart from the rest of the participants. They are shown according to schedule in Phase A (tracking) and in all other phases, they are shown as the last competitors at the end of the trial. If there are several in-season bitches entered, they are to draw for positions starting at the end of the trial. Females that are obviously pregnant or nursing females are excluded from the trial.

Sick and contagious animals are excluded from all events.

**PHYSICAL DISABILITIES** - Handlers that possess physical handicaps that hinder movement of the dog on the left side of the handler can show dogs on the right side. In such cases, the dog and handler will be judged without prejudice as long as the performance is analogous to a left-heeling dog. *At all times the USCA will make every attempt to support and uphold the Americans with Disabilities Act (ADA).*

**MANDATORY COLLAR / CARRYING OF THE LEAD / LEASH** - For liability reasons, the handler must carry a lead throughout the entire course of the trial. The dog must wear a commercially available wide-linked collar ("Fur Saver") throughout the entire trial, which must be in accordance with local animal protection laws. The Judge may inspect and determine if the collar meets trial requirements. During off-lead exercises, the lead must be carried out of sight, or hung around the body in such a way that the catch is on the side of the body opposite the dog. (i.e., the leash may be carried around the waist or over the shoulder in a left to right fashion across the body.)

During the trial, the dog must be exhibited with a chain collar in the neutral position with the lead attached only to the dead ring. Only single-row medium or wide linked chain collars are permitted. The collar may not have spikes, sharp points, prongs, or other hooks. The collar must fit loosely around the dog's neck. Leather, nylon, spike, pinch, or remote training devices are not permitted in a USCA sanctioned event. (This includes any demonstration dogs that may be shown during the trial.) "Flea and tick" collars and tags are to be removed. A chain collar, a leather collar, or a harness is permitted only for the BH examination.

The composition of the metal collar, especially in regard to weight, should not deviate from the customary design. If the judge suspects manipulation by the handler, he / she can demand a change of collars. However, this must take place before the beginning of the trial phase. If the judge detects intent to deceive (concealed prongs for instance), the judge must disqualify the participant from the rest of the trial. In such an incident, an appropriate report is to be furnished and sent to the USCA Regional Director, USCA Director of Judges, and the USCA Judges Committee for determination of formal charges.

**COMMANDS** - Commands permitted are shown in the trial rules. Voice commands in all phases are to be given clearly and audibly. Handlers may use their choice of language, but all commands must be consistent for the same exercise in all phases of the trial. Commands in most cases should be a single word command – an exception to this, for example, is the call out; "heir-fuss" is used together. (i.e., Handlers may use "down" and "fuss" (two languages) as long as it is the same for same action.)

### **DUTIES OF THE TRIAL SECRETARY**

Trial secretaries at all USCA events must be members of the USCA. Before the beginning of the event, the judge must check that all trial documents are available, especially the scorebooks of the participating dogs, helper books, and accepted proof of membership of the entries. Dogs may only have one (1) scorebook except in special circumstances; handlers may only present one (1) scorebook to the judge for entry into a USCA trial.

Prior to the trial, each club must receive approval (authorization) signed by a Regional Director. The secretary will provide the judge with properly filled out judge's sheets.

It is the responsibility of the trial secretary to check that the dogs entered are entered correctly for the title or test that they are being shown in.

The trial secretary may not take on any additional functions during the trial, which includes competing and / or helper work, or track-laying. They must be available to assist the judge throughout the entire trial.

#### **THE TRIAL SECRETARY IS RESPONSIBLE FOR:**

- Providing suitable tracking fields
- Having an adequate number of experienced tracklayers available
- Providing a sport field sufficiently large for both the obedience and protection phases
- Providing the necessary one (1) or two (2) experienced helpers with proper protective equipment (appropriate footwear, protection pants, jacket, sleeve and padded stick)

- Providing equipment in accordance with the trial rules (solid jump, climbing wall, 6-mm pistol, six (6) blinds)
- Providing a group of at least four (4) people available when needed
- Ensuring that the trial is completed in a proper, orderly fashion
- Providing a sufficient number of score sheets and judge's sheets
- Ensuring that score sheets and judge's sheets are all properly prepared and completed

One of the fundamental duties of the trial secretary is the responsibility for assembling and preparing all trial documents. If essential documents are missing and cannot be obtained, the judge may terminate the trial.

The dog's scorebook must be submitted by the handler to the trial secretary at all USCA sanctioned trials. WUSV, AWDF member clubs and DVG scorebooks will be accepted; however, they must be stamped or clearly registered by their organization.

United States residents have to be members of USCA or a USCA recognized dog sport organization. In addition, the following documents may be requested or required by the host club at their discretion, as noted on the trial flyer:

- A copy of the pedigree / registration certificate as judges have the right to ask for registration papers
- Conformation scorecards
- Membership cards
- Valid rabies vaccination certificate

Titles will be recognized only when they have been earned under a working-dog organization belonging to the WUSV / FCI, or under a WUSV / FCI-recognized trial judge. Dogs that are not registered with a WUSV / FCI-recognized breed club are to be listed in the trial paperwork only by their call names. All entries must be identified by either tattoo or microchip.

Trials are, by their nature, public events and it is encouraged to provide open access to the trial for spectators. USCA recognizes that trials are sometimes



held on private property and this may impact the presence of certain people. But at all times in the interest of sportsmanship it is encouraged to promote an open, public event.

Trials may use Friday or Monday to host events offering all performance titles and degrees awarded by USCA. Performance titles such as BH, IPO 1, 2, 3, FH 1, 2, Apr 1, 2, 3 and DPO (any) must be offered on Saturday and Sunday in addition to Friday or Monday. If clubs anticipate more trial entries than can be accommodated in two (2) days, a three (3) day event should be authorized with performance titles offered on both days of the weekend and the extra day intended for overflow (i.e., the BH may be earned on one (1) day and the Apr 1 / IPO 1 on the following day). Clubs are allowed to offer performance titles on Friday or Monday and just one (1) day of a weekend if also hosting a Breed Survey or Conformation Show on the other day of the weekend. Breed Surveys and Conformation Shows must be held on Saturday or Sunday. A three (3) day event will not be allowed unless the club has three (3) days of activities. It is not intended to allow a club to host an IPO trial on Friday or Monday and a one (1) day event on the weekend. The three (3) day event is intended for larger events with multiple venues. The Regional Director must receive a request from the club for a three (3) day event, and will authorize three (3) day events only in the cases listed above. All other USCA trial regulations are applicable. A local club trial may not start before 12:00 noon on the Friday preceding the weekend in question unless it is in conjunction with a championship event from the regional level and up.

The trial secretary must notify the judge and the Regional Director no later than three (3) days before the trial about the location and starting time of the trial.

The judge can resign from his commitment if the trial secretary has not informed them a minimum of three (3) days before the event of the location and the start time. The club is still responsible for any expenses incurred by the judge. If the judge must cancel his / her assignment due to unforeseen special circumstances or emergencies, it is up to the club to have insurance for any reimbursements. Final approval for reimbursement may be determined by the DOJ.

**BH REQUIREMENT** - For entry into all trial levels except for BH, presentation of the scorebook must include proof of having earned a minimum of a BH title under a recognized organization. Public service dogs and dogs that have successfully performed a Herding Dog Trial (HGH) do not have to show proof of having passed a BH test (Public Service Dogs are those that are owned and employed for the purpose of public service, e.g., Police Dogs). Exception is no BH required for entry into AD. First time handlers entering the BH must successfully pass a written exam.

### **HELPERS FOR USCA TRIALS**

All helpers participating at a USCA event must have a current USCA Membership and USCA Helper Book with current "classification" to be allowed to work the level of trial they are participating in. At club level events the helper may be a member of the household of an entry. The same helper is required to work all dogs in a specific level. (i.e., same helper for all IPO 1 entries, same helper for all IPO 3 entries, etc.) This is to help ensure a fair and equal venue for all dogs. At club level events, only one (1) helper is required. The same helper is to be used for the front-half and back-half of the IPO 1 and IPO 2. At championship level events, two (2) helpers are required for IPO 3 (one (1) front-half helper and one (1) back-half helper). Additional requirements and information are listed in the USCA Helper Program available on the USCA website. At all times during the trial, the helper is under the direction of the judge.

### **THE TEMPERAMENT (IMPARTIALITY) TEST**

Before dogs are allowed to begin a BH, TR (FPr), OB (UPr), APr, IPO or FH trial, they must undergo a temperament test that will be conducted on lead.

The temperament of the dog is to be observed during the entire course of the trial. If a dog fails because of unsatisfactory temperament, even though preceding trial phases were passed positively, the dog is to be disqualified and points are not given, even if some were already announced.

## **PRINCIPLES OF THE TEMPERAMENT (IMPARTIALITY) TEST**

The temperament test must take place before the beginning of the trial (except at national events). The location of the test must not be on the performance field. The test can be done at the tracking field or an adjacent field. Dogs are to be brought on a slack heeling lead (not tracking line and harness) attached to a "dead ring" of the collar. No commands are to be given.

***The dog must be able to be touched by the judge, or approved designee of the judge, at the decision of the judge.***

The following standards are to be observed in the test:

- A systematic test of the temperament is to be avoided
- It is the judge's choice how the sequence of events is organized
- The inspection and verification of the tattoo number / microchip number is an essential part of the temperament test.
- Dogs must be able to be touched by the judge

The temperament evaluation occurs not only at the beginning of the trial, but continues throughout the entire trial. A dog that has passed the pre-trial portion of the temperament test may still be eliminated from the trial if that dog shows faulty temperament during the course of the trial. If the judge observes unsatisfactory character, he must test the dog carefully according to the trial rules (e.g., the gunshots). Repetitions to this purpose are permitted.

**CONDUCTING THE TATTOO or MICROCHIP CHECK** - The judge has to verify in the trial documents that the tattoo or microchip check was conducted. If the tattoo mark is not clearly discernible, in all cases the identifiable marks are to be recorded. The tattoo number must agree with the pedigree / scorebook submitted by the handler. In the case of difficulties in the appearance of the tattoo (i.e., illegibility of the numbers), the trial paperwork is to include an appropriate remark. Owners of dogs that are microchipped are responsible for providing the necessary equipment for the identity check.

## **RESULTS OF THE TEMPERAMENT (IMPARTIALITY) TEST**

### **Positive representation = PASSED**

The following are some examples, but not all inclusive:

- Dog is self-confident
- Dog is quiet, secure and attentive
- Dog is animated and attentive
- Dog is impartial and good-natured
- Dog is friendly and outgoing

### **Borderline = TO BE FURTHER OBSERVED**

The following are some examples, but not all inclusive:

- Dog is unsteady, but not aggressive; however, unaffected throughout the course of the trial
- Dog is slightly overexcited; however, became calmer during the course of the trial

### **Failed = CANNOT BE PERMITTED INTO THE TRIAL**

- Dog is insecure and nervous: avoids people
- Dog is nervous and aggressive: warns a person
- Aggressive, biting dogs

Dogs that fail the temperament test are excluded from further participation in the trial.

When a dog is excluded for faulty temperament, the following entry must be made in its scorebook: "FAILED TEMPERAMENT TEST."

**SUSPENSION** - If a dog fails because of unsatisfactory character, he is consequently dismissed from the trial. USCA has the right to adopt rules that may prohibit entry of dogs that have repeatedly failed the temperament test. USCA has a Dog Aggression Policy and this policy will be enforced leading up to suspension or ban for aggressive behavior towards dogs or humans.

## ABBREVIATIONS

**USCA – *United Schutzhund Clubs of America*.** A full member club of the WUSV in the United States. Dedicated to preserving the working heritage of the German Shepherd Dog as well as providing working dog trials and sport for all breeds.

**FCI - *Federation Cynologique Internationale*.** This is the umbrella organization for most of the kennel clubs throughout the world (with the notable exception of the AKC and CKC).

**VDH - *Verband fuer das Deutsche Hundewesen*** - German Kennel Club. This is a governing body made up of other organizations and clubs.

**DVG - *Deutscher Verband der Gebrauchshundsportvereine*.** DVG is the oldest and largest schutzhund organization in the world. Its sole purpose is the training and titling of dogs.

**COAPA** - The organization of all of the South American countries formed into a union for the German Shepherd Dog.

**AWDF - *American Working Dog Federation*.** Formed in 1989, the AWDF was organized to preserve and protect the working heritage of the individual working breeds. It is affiliated with the FCI and has its working titles recorded and recognized around the world.

**WUSV - *World Union for the German Shepherd Dog*.** The worldwide organization for all German Shepherd Dog clubs.

**SV - *Verein fuer Deutsche Schäferhunde*** - German Club for the German Shepherd Dog. The organization in Germany that represents the German Shepherd Dog with over 80,000 members.

**GSSCC - *German Shepherd Schutzhund Club of Canada*.** The Canadian organization for the German Shepherd Dog that is also aligned with the WUSV.

**RD** - Regional Director

**RTD** - Regional Training Director

**RBW** - Regional Breed Warden

**DOJ** - Director of Judges

**ADOJ** - Assistant Director of Judges

**NBW** - National Breed Warden

**Special Regulations** - The FCI / WUSV member clubs are entitled to expand or modify general regulations for their area.

**Liability** - The owner of a dog is liable for any personal injury or material damage caused by his / her dog. Therefore, the owner must have adequate insurance. In case of an accident, the handler is liable for himself / herself and his / her dog throughout the event. The handler follows the instructions given by the judge and the organizer of his / her own free will and executes the instructions at his / her own risk. The host club is liable for any damage or injury caused by the venue. In certain circumstances the host club for a local trial, or the national organization for a national trial, may share liability for injury with the owner / handler caused by competitor / dog in the trial.

## **PHASE A - TRACKING**

*Requirements for IPO 1, 2, 3 / TR (FPr) 1, 2, 3 / FH 1*

### **SELECTION OF THE TRACKING FIELDS**

- The selection of a suitable tracking field is the responsibility of the trial secretary. It is his / her responsibility to make arrangements with the property owner or manager.
- The trial secretary must see to it that the dogs are handled in such a way in the tracking fields that wildlife will not be disturbed.
- Tracking can be held on all natural terrains (e.g., meadow grass, pasture land, ploughed or dirt fields and forest soil).
- The decision regarding the suitability of tracking land is the duty of the judge. Change of cover and terrain in IPO 1 through IPO 3 is possible and in the FH 1, it is absolutely required.
- Optional requirement: FH 1 tracks should cross once over a hard, well-traveled street or gravel road. If a road crossing is used it should be used for all FH tracks in the same trial.

- Holding an FH test on a continuous blanket of snow is not permitted.
- Visible tracks where sight tracking is possible are to be avoided.

## **TRACKING ARTICLES**

Within any one (1) track, articles different from each other must be used. Their color may not stand out considerably from that of the terrain, and their size may not exceed 10 cm long by 4 cm wide by 1 cm thick. Size and material of the articles will be strictly enforced.

Materials: Any reasonable material may be used as articles on the track, such as leather, wood, carpet or other biodegradable substances.

In IPO 2, 3 / TR (FPr) 2, 3 / FH 1, 2, the articles are to be turned over to the tracklayer who must wear them on his / her body for a minimum of thirty (30) minutes before laying the tracks.

In IPO 1 / TR (FPr) 1, the handler uses his / her own articles. Attention should be paid to see that these articles are likewise well scented.

All articles should be marked with numbers. The numbers on the articles must correspond with the numbers on the starting flags (markers). This is mandatory at championships.

Before laying the IPO 1 track, the handler must show the articles to the judge. Only the articles described above or articles of the judge's discretion are to be used.

## **TRACK SHAPE AND LENGTH**

*(See sample tracks in the Appendix)*

<b>Trial Level</b>	<b>IPO 1 TR (FPr) 1</b>	<b>IPO 2 TR (FPr) 2</b>	<b>IPO 3 TR (FPr) 3</b>	<b>FH 1</b>	<b>FH 2</b>
<b>Minimum Length (paces)</b>	300	400	600	1200	1800
<b># of legs</b>	3	3	5	7	8
<b># of corners</b>	2	2	4	6	7

In regional events, qualifying trials and championships, shortened track lengths may be required due to large entries.

### **AGE OF TRACKS**

<b>Trial Level</b>	<b>IPO 1 TR (FPr) 1</b>	<b>IPO 2 TR (FPr) 2</b>	<b>IPO 3 TR (FPr) 3</b>	<b>FH 1</b>	<b>FH 2</b>
<b>Minimum Age (minutes)</b>	20	30	60	180	180

A dog must complete the track in a predetermined amount of time from the start of the track:

IPO 1, 2 / TR (FPr) 1, 2 - 15 minutes; IPO 3 / TR (FPr) 3 - 20 minutes; FH 1 - 30 minutes; FH 2 - 45 minutes.

### **CROSS TRACKS**

**FH 1** - 30 minutes after finishing laying of the track.

**FH 2** - 30 minutes before starting to run the track.

### **LAYING THE TRACK**

- The judge is responsible for determining the layout of the track and for instructing tracklayer(s).
- In laying the track, the tracklayer must ensure that they use a natural stride.
- In the FH tracks, strict attention is to be paid to ensure that the tracks are laid on varying cover. Any standardized FH pattern is to be avoided. Tracklayers for FH tracks must have experience in laying FH tracks.
- At USCA-sanctioned local trials, tracklayers may reside in the same household as the handler.

### **THE START OF TRACKING**



**IPO 1 / TR (FPr) 1** - There will be a draw for tracks BEFORE tracks are laid.

**IPO 2, 3 / TR (FPr) 2, 3 / FH 1, 2** - There will be a draw for tracking order AFTER the tracks are laid.

## **THE SCENT PAD**

**IPO 1, 2, 3 / TR (FPr) 1, 2, 3 / FH 1, 2** - The starting point (scent pad) is marked with a tracking stake or flag, which is placed in the ground directly to the left side of the start. The flag must remain in place throughout the tracking work.

The tracklayer pauses at the start. Light stepping on the starting place is not faulty.

The handlers may not be present during the laying of the tracks for IPO 2, 3 / TR (FPr) 2, 3 / FH 1, 2. During the laying of the IPO 1 / TR (FPr) 1 track, the dog must remain out of sight.

## **THE LEGS OF THE TRACK**

The tracklayer proceeds at a normal pace in the direction prescribed by the judge. Scraping or scuffing of feet or interruption in pace is not permitted.

## **THE CORNERS**

The corners (approximately ninety (90) degrees) are also to be made at a normal pace. Care must be taken that a continuous working of the track to the next leg is possible for the dog. An interruption of the track may not occur. Heavy scuffing on the corners is not allowed.

## **THE PLACEMENT OF ARTICLES**

The articles are to be laid on the track while the tracklayer is in motion. If the tracklayer needs to slow to place the article on the track that is allowed. Laying the articles on the change of cover, corner, or in their immediate vicinity is not allowed. They must be laid on the track, not next to it. No article is to be placed less than twenty (20) paces before or after a corner.

After laying down the last article, the tracklayer continues straight ahead for an additional few paces.

**IPO 1 / TR (FPr) 1** - The first article is placed a minimum of 100 paces, on either the first or second leg. The second article is placed at the end of the track.

**IPO 2 / TR (FPr) 2** - The first article is to be placed a minimum of 100 paces from the start, on either the first or second leg. The second article is placed at the end of the track.

**IPO 3 / TR (FPr) 3** - The first article is placed a minimum of 100 paces from the start, on either the first or second leg. The second article is placed at the judge's discretion. The third article is placed at the end of the track.

**FH 1** - The first article is placed a minimum of 250 paces away from the start. The last article is placed at the end of the track, and the remaining articles placed at irregular intervals on the track. There are a total four (4) articles in this event. It is not required to have a road crossing but if one is used all FH Tracks in the trial should have a road crossing.

**FH 2** - Same as the FH 1 except there are seven (7) articles.

**In all levels, articles may not be placed within twenty (20) paces of a corner or cross track.**

### **VALUE OF THE ARTICLES**

<b>Trial Level</b>	<b>IPO 1 TR (FPr) 1</b>	<b>IPO 2 TR (FPr) 2</b>	<b>IPO 3 TR (FPr) 3</b>	<b>FH 1</b>	<b>FH 2</b>
<b>Article Points</b>	1 x 11 pts 1 x 10 pts	1 x 11 pts 1 x 10 pts	3x7 pts	3 x 5 pts 1 x 6 pts	7 x 3 pts

### **VARIOUS HANDLING OPTIONS IN THE TRACKING WORK**

The following lead / handling options are permitted:

- Collar
- Tracking harness

- Tracking line
- Free tracking

**THE COLLAR** - The collar may not be used on the live ring. In attaching the line, it may be placed over the dog's back, along the side of the dog or between the front and / or the rear legs.

**TRACKING HARNESS-** The following types of tracking harnesses are permitted:

- The chest harness
- The Boettcher tracking harness
- The rope harness or other material

The harness must not be restrictive in any way, and the judge must ensure that the body strap is not fastened in the area of the dog's abdomen. The judge also has the discretion to check any and all harnesses.

**Harnesses MUST be used and attached in the way they are intended. If a Boettcher is used then the line must be attached to the harness at the ring between the legs or fed through that ring and up and attached to fur saver, not attached to a side strap or top of back.**

The use of additional straps is not permitted.

**TRACKING LINE** - The tracking line may be attached directly to the collar, dead ring or to the tracking harness. The tracking line is to be attached to the harness by means of the device (e.g., ring, etc.) on the harness that is provided for that purpose, without attaching the line to the collar (except in the case of a Boettcher tracking harness).

The tracking line must be at least ten (10) meters long. The handler must remain at the end of the tracking line, even in the event that the line is longer than ten (10) meters. Examination of the line length, the collar and the harness by the judge must take place before the beginning of the trial. Retractable lines and flexi-leads are not permitted.

The tracking line may hang loose, as long as the handler does not let it out of his / her hand or the distance between the dog and handler is shortened.

**FREE TRACKING** - The distance of at least ten (10) meters between handler and dog must be maintained throughout the track. A harness may not be used while free tracking.

## **WORKING AND JUDGING OF THE TRACK**

Report-in to the judge occurs in the basic position with the dog prepared to track and the tracking line laid out. At the reporting in, the judge must check the length of the tracking line. A point deduction because of incorrect reporting in may not occur. No deductions are taken if the tracking line is not the required ten (10) meters long. In this case, the tracking line is to be exchanged. If the judge fails to detect a tracking line that is not the correct length before the track commences, there will be no deduction of points. The handler must report-in and declare whether the dog will indicate by "pointing out" or "retrieving" the articles. If the dog indicates by pointing out it may down, sit or stand to point out the article. Changing the way the article is "pointed out" from article to article is faulty, but will still be counted as an indication with a deduction.

While the dog is tracking, the judge and any accompanying persons are not permitted in the immediate area of the track where the dog and handler team are working. The judge may be closer to the dog and handler if the terrain and / or vegetation obstructs the vision of the judge so that it may hinder a correct evaluation of their performance.

### **VALUE OF THE TRACK:**

Working of the track	79%
Articles	21%
Total	100%

The 79% (points) for the track may be distributed to areas of the track based on the difficulty of the legs and corners. All percentages are approximate and

have to be considered based on the difficulty of the legs. Due to the variations and different terrains that may be encountered with FH tracks, these general percentage assessments will be made by the judge at the time of the actual test.

### **POINT ALLOCATION / RATINGS**

<b>RATING</b>	<b>20 Points</b>	<b>15 Points</b>	<b>10 Points</b>	<b>5 Points</b>
<b>EXCELLENT</b>	19.5 – 20	14.5 - 15	10	5
<b>VERY GOOD</b>	18 – 19	13.5 - 14	9 - 9.5	4.5
<b>GOOD</b>	16 - 17.5	12 - 13	8 - 8.5	4
<b>SATISFACTORY</b>	14 - 15.5	10.5 - 11.5	7 - 7.5	3.5
<b>INSUFFICIENT</b>	0 - 13.5	0 - 10	0 - 6.5	0 - 3

### **THE STARTING PLACE / SCENT PAD**

#### ***IPO / TR (FPr) / FH 1, 2***

The dog is led calmly to the start. Any act of compulsion (such as downing the dog at the start flag) is not permitted. Any handling of the dog such as placing the dog in a sit or placing the line under the dog's leg must be done no closer than two (2) meters before the starting flag. No harsh commands are allowed to create pressure on the dog. (i.e., a hard "platz" / "down" that causes the behavior of the dog to show stress.)

It is not faulty at the start of the track for the dog to be slightly ahead of the handler as they approach the track (no more than the body length of the dog) as long as the dog is calm. No holding the collar as team approaches start of track (i.e., holding a leash that is wrapped around the collar or leg when approaching the flag).

The dog must be given a verbal command to track at the start of all tracking (e.g., scent pad, articles).

The start is to be done at the dog's location and not from a distance. The same is true for the restarts after finding the articles.

The start is not dependent on time other than the prescribed maximum for the track itself. The judge must concentrate on the behavior of the dog at the beginning of the first leg, noting the intensity with which the dog absorbs the scent.

The dog should be allowed to take up the scent thoroughly at the starting point. The dog should start calmly and intensely. The taking of the scent must occur without help from the handler, except for the voice command "such" / "search". Releasing the dog with the hand below the handler's knee will be construed as handler help and points will be deducted accordingly. The handler may not excite the dog or urge the dog to charge forward.

Once the dog has taken up the scent and is following it, the handler must remain at the starting point until the dog has reached the end of the tracking line, or until the required distance of ten (10) meters is reached. Following too early is faulty and will be penalized.

**RESTARTS** - After the third unsuccessful start (before the handler has left the scent pad), the tracking work is to be terminated.

**Exception:** The FH 1, FH 2, IPO FH rules state that if the handler is within the first fifteen (15) paces after the start, the dog may be restarted only once, with a deduction of up to four (4) points. (Only a maximum of three (3) restarts are allowed in total.)

A new start further into the course of the track is not allowed. A new start consists of the handler taking the dog at heel, by the collar or on a shortened line, and again setting the dog onto the track.

So long as the handler holds the tracking line in his hands at the end and allows the dog to search freely, a restart does not occur, even if the dog passes the handler. It is also not a restart if the dog returns to the handler while it works out the track and independently resumes the track. A corresponding point deduction is to be made.

**TRACKING PERFORMANCE** - The dog is to follow the course of the track evenly and intensely with a deep nose. Whether the dog tracks fast or slow is not a factor in the scoring, so long as the track is worked out intensely, uniformly, and convincingly.

The tracking line may sag as long as this does not result in a substantial shortening of the distance between handler and dog. The line lightly touching the ground is not faulty.

**CORNERS** - The corners are to be worked out closely and confidently. If the dog checks the corner, to convince it of the lay of the track, it is not faulty so long as the dog does not leave the track. Close circling at the corner is faulty. The handler may not influence the dog at the corner (i.e., using voice commands or lead handling). The corner is defined as one (1) meter before and after the turn. After working out the corner, the dog must continue tracking at his regular pace. If the dog picks up speed after the corner it is considered faulty.

**FH 1, 2 CROSS TRACKS** - The dog may follow the cross track for up to one (1) line length with point deduction. The tracking will be terminated if the dog leaves the track by more than one (1) line length.

**INDICATION AND PICK UP OF ARTICLES** - Indication of the articles must be done convincingly, in the direction of the track, and right before the article (i.e., with the dog lying down with the article between the legs and in front of the chest). Minor crookedness of position is not faulty, but sideways indicating of the article or strong turning around toward the handler is faulty. The dog lying down with the article between the paws and in front of the chest and under the head is not faulty as long as the dog is calm in the position. Any restlessness or moving the article would be considered faulty. Articles that are indicated or picked up with strong handler help are counted as not found.

If the dog indicates or picks up an article differently than announced by the handler (i.e., retrieves when the handler announced the dog would indicate) then all points for that article are deducted. If the dog points out differently

(standing, sitting, down) than it did on the first article a "B" satisfactory rating is the highest it can earn.

If the dog picks up articles, it may then stand still, sit, or come to the handler. Moving forward with the picked-up article or picking it up while lying down is faulty. If the dog brings the article to the handler, the handler may not move toward the dog. The handler must take the article from the dog in the front position. One (1) command for the release is permitted. The handler will give the tracking command after retrieving the article, and the scoring of the track will continue from the point the article was found. The restart will be the same as with all other starts from an article.

As soon as the dog has found an article, it must immediately pick up or indicate it convincingly without influence from the handler. When indicating, the handler must put the line down and immediately go to the dog. Found articles are to be shown to the judge by holding them in the hand and raising the arm up high. In picking up or removing the article, the handler may not stand in front of the dog, but must position himself next to the dog, unless the dog employs the retrieve. The handler may approach the dog from either side to pick up the article, but they must then restart the dog from the same side the handler showed the article. The handler may not be behind the dog to start after the article pick up.

The dog must remain calm in the indicating or picking up position until the handler restarts him / her. Dogs must give articles (indicated or picked up) to the handler during tracking or the team will be disqualified. (i.e., if the dog will not let go of the article and allow the handler to take it then disqualification.)

If the dog retrieves the articles, the dog must come to the front of the handler with the article, the handler will take the article with an "out" command, the dog will go to the basic position and then be directed to track. Another option allowed for retrieving the articles is the dog must come to the front of the handler with the article, the handler will take the article with an "out" command, and then the dog will be directed to track from the front position. During either retrieve of the article, the handler stays at the end of the leash.



**HANDLER HELP** - Articles found with heavy handler help are considered overrun (i.e., the dog does not indicate the article and with the help from the handler with the line or commands, is prevented from tracking further). In this instance, all the points for the article are lost. At all starts during tracking the handler should be standing with their hand and tracking line above the knee, failure to be in this position is faulty and will result in deductions.

**FALSE INDICATIONS** - If the dog indicates a false object or interrupts his tracking work by lying down, sitting or standing still, it is faulty and a point deduction is incurred.

Lying down on the track by the dog does not have to be considered a false indication. If the dog, at the handler's command from a distance of ten (10) meters, continues to work, only two (2) points are deducted. This is not considered a false indication. However, if the handler approaches the dog, this is analogous to a false indication and four (4) points will be deducted from IPO, TR (FPr) titles and three (3) points from FH titles.

#### **SCORING FOR FALSE INDICATION OF ARTICLES**

<b>Trial Level</b>	<b>IPO1 TR (FPr) 1</b>	<b>IPO 2 TR (FPr) 2</b>	<b>IPO 3 TR (FPr) 3</b>	<b>FH 1</b>	<b>FH 2</b>
<b>Point Loss</b>	4	4	4	3	3

**LEAVING THE TRACK** - If the dog goes to leave the track and the handler restrains him from doing so, the judge will instruct the handler to follow the dog. The handler must obey this instruction. The tracking work will be terminated if the dog leaves the track by more than one (1) line length or if free tracking by more than ten (10) meters, or if the handler fails to obey the judge's instruction to follow the dog. The judge is not permitted to advise the handler to drop the tracking line.

**WORKING OF THE TRACK** - If the dog stops working the track, the handler has up to three (3) commands to get the dog started again or the dog is

terminated. (e.g., dog stops movement and raises head, sits, lays down, returns to handler and sits in basic position.)

**PRAISE** - Minimal praise is permissible in the IPO 1 / FPr 1 tracking only, but the handler may not be excessive in the praising of the dog. There is no praising during the actual tracking at all higher levels (IPO 2, 3 / FPr 2, 3 / FH 1 / FH 2 / IPO FH), praise from the handler will result in a point deduction.

Praising at the article in all levels is permissible in the same position in which the dog indicated or picked up the article, before or after showing the found article to the judge. The verbal command "such" or "search" is only permitted at the start and after each article indication.

If the tracking line gets tangled, the handler must ask permission to down his / her dog, before untangling the line. The handler must go back to the end of the line to restart the dog after untangling their dog.

**WILD GAME** - If during the tracking work wild game appears, and the dog follows his hunting instinct, the handler may attempt to prevent the dog from following by giving the dog the command to "platz" / "down". On the judge's signal, the tracking work will then continue with the handler at the end of the tracking line. The scoring in this situation will result in a deduction of up to eight (8) points. If the dog will not start tracking again, the tracking work is to be terminated and the dog will be awarded whatever points it earned up to the point it stopped tracking.

**ENTANGLEMENT / PHYSICAL INTERRUPTION** – In the event the dog becomes tangled in the tracking line or other physical cause that would interrupt the dog's ability to proceed in a normal manner (e.g., thorn, rock in foot) the handler may with the judge's permission "platz" / "down" the dog and drop the tracking line to proceed to the dog to untangle or remove the object causing distraction. The work will then continue with the handler at the end of the tracking line.

**REPORTING OUT** - After completion of the tracking work, the articles found are to be shown to the judge. Playing with or feeding the dog after indication of the last article and before reporting out to the judge is not permitted. If

the handler has food or motivational object in their pockets, they will be disqualified. Reporting out must be done with the dog in the basic position.

### **SCORING OF TRACKING WORK**

- Faulty starting, aimless wandering, frequent circling on the corners, continuous encouragement, incorrect picking up or indicating and dropping of articles will be penalized up to four (4) points.
- Repeated starting, strong wandering, tracking with a predominately high nose, hectic tracking, urinating, defecating, mouse-catching, etc., are penalized up to eight (8) points.
- If the dog indicates or picks up an article differently than announced by the handler (i.e., retrieves when the handler announced the dog would indicate) then all points are deducted.
- If the dog picks up or indicates an article not placed on the track by the tracklayer, and the handler goes to his dog, four (4) points will be deducted on the IPO and TR (FPr) track, and three (3) points on the FH 1, 2 track.
- If the dog indicates an article not placed on the track by the tracklayer or interrupts the track by lying, sitting or standing, this is incorrect. However, on IPO, TR (FPr), FH 1 and FH 2 tracks, if the dog continues working after an additional command, given from a distance of ten (10) meters, two (2) points will be deducted.
- For articles not found, the prescribed article points will not be given.

## **TRACKING DOG - LEVEL 2 (FH 2)**

*Requirements for FH 2*

## **GENERAL DESCRIPTION**

Tracking Dog Level 2 (FH 2) is a test for sporting purposes only. Special claims, which might arise out of the realm of service dog achievements, are not to be made.

**SELECTION OF THE TRACKING FIELDS** - Careful attention is to be given to ensure that the track is laid over changing cover and terrain. It must be laid so as to simulate a real situation; standardized patterns are to be avoided.

Visible tracks are to be avoided. Holding an FH test on a continuous blanket of snow is not permitted.

**TRACKLAYERS** - It is recommended that the tracklayers for this test be experienced and qualified. Tracklayers for the FH 2 tracks should have experience in laying FH tracks. As a rule, the trial judge for this type of test may not accompany the tracklayer while the track is being laid, and the tracking diagrams must be drawn by the tracklayer. The judge must make sure that the cross tracks are laid according to the FH 2 rules, which is thirty (30) minutes before the running of the track.

## **ENTRY REQUIREMENTS**

Before a dog is eligible to take the FH 2 test, he must be at least twenty (20) months old and have attained a BH. If he has not earned the IPO 1 title, the FH 2 title will not constitute a "training title" for the purposes of a Breed Survey.

## **PERFORMANCE IN THE TRACKING WORK**

The dog must demonstrate his track-sureness on a track not laid by the handler that is at least three (3) hours old and at least 1,800 paces long, with seven (7) corners that conform to the terrain. At least two (2) of the corners must be acute and one (1) must be an arc (segment of a circle). The track will be crossed at least twice by a fresher track not laid by the handler or original tracklayer at varying points separate from each other.

Seven (7) articles, which have been well scented by the tracklayer, will be placed along the track at irregular distances. The articles are to be found by the dog and either indicated or picked up.

Before the start of the track, the handler must report to the judge whether the dog indicates by "picks up" or "retrieves" the articles. Doing both together (picking up and indicating), on the same track, is faulty.

Handlers may track the dog free or on a tracking line. The tracking line may hang loose, so long as the handler does not let it out of his / her hand or the distance between the dog and handler is shortened. *FREE TRACKING* - The distance of at least ten (10) meters between handler and dog must be maintained throughout the track. A harness may not be used while free tracking.

## **TRACKING ARTICLES - As previously described.**

### **THE PLACEMENT OF THE ARTICLES**

- The first article must be a minimum of 250 paces from the start
- The second through sixth articles at the judge's command
- The seventh article is placed at the end of the track

### **LAYING OF THE TRACK**

The tracklayer, who is not the handler, must prepare a terrain sketch for the judge. The course of the track is to be planned in advance with the judge or with the appointed tracking chairperson, utilizing natural landmarks such as lone-standing trees, power poles, sheds, cottages, outbuildings, etc.

Before laying the track, the tracklayer will show the required tracking articles to the judge or tracking chairperson. The tracklayer must have carried the articles on their person for at least thirty (30) minutes in order to scent them well. The articles may not exceed the above-stated dimensions, and they must not differ markedly in their color from the surrounding terrain.

### **THE STARTING PLACE / SCENT PAD – As previously described in Tracking above**

**WORKING OF THE TRACK – As previously described in Tracking above (the following exceptions apply)**

The FH 1, FH 2, IPO FH rules state that if the handler is within the first fifteen (15) paces after the start, the dog may be restarted only once, with a deduction of up to four (4) points. (Only a maximum of three (3) restarts are allowed in total.)

Time allowed to complete the track is 45 minutes.

**FH 2 CROSS TRACKS** - If the dog changes over from the primary track onto the cross track and follows it for more than one (1) line length, the tracking work must be terminated. The dog may follow the cross track for up to one (1) line length with point deduction.

**SPECIAL CHARACTERISTICS AND SUPPORT IN THE FH 2** - The judge is permitted to allow the handler assistance if the dog cannot manage terrain-caused obstacles. (e.g., large puddles of water, trenches, etc.) No point deduction is made.

After consulting with the judge, the handler is allowed to interrupt tracking briefly if he believes that he or the dog needs a short break for health reasons and / or weather conditions (e.g., extreme heat). There is no point deduction. The restarting of the dog on the track after the short break will not be scored as a "restart" or considered faulty. The time taken for such breaks, however, is counted in the total time available to the handler and dog to complete the track.

The handler is allowed, during the short break or at an article, to clean up the dog's head, eyes, and nose. For this purpose, the handler may carry a wet cloth or sponge. These items are to be shown to the judge before the start of the tracking work. Further aids are not permitted.

The handler must refrain from giving the dog any type of physical help (i.e., handler jerking on the leash). The dog may be praised at the article indication before or after the handler shows the article to the judge, but not

Page 46 / Ver. 1.3

both. The command "such" may only be given at the start and at any restarts off an article.

## **SCORING**

Maximum score: 100 points. Working of the Track = 79 points. Seven (7) articles (7 x 3) = 21 points.

The maximum 100 points can only be given when a dog works out his track from beginning to end, at a steady pace throughout, and picks up or indicates all seven (7) articles.

All the angles (corners) must be worked out confidently. The dog may not be influenced by the cross-tracks. Each article (7 total) not found will cost three (3) points. Picking up in combination with or alternating with indicating the articles is faulty.

If the dog indicates an article not placed on the track by the tracklayer or interrupts the track by lying, sitting, or standing, this is incorrect. However, if the dog continues working after an additional command is given from a distance of ten (10) meters, two (2) points will be deducted. If the handler goes to his dog, three (3) points will be deducted.

If the handler prevents the dog from leaving the track, the judge will instruct the handler to follow the dog. The tracking work is terminated if the dog leaves the track by more than one (1) line length or if free tracking by more than ten (10) meters or if the handler ignores the judge's instruction to follow the dog.

## **TRACKING DOG - IPO FH**

### *Requirements for IPO FH*

Same as the FH 2 but comprised of two (2) FH 2s on separate days. The scores are averaged from the scores of the two (2) tracks. At a championship the two (2) FH 2s are done under two (2) different judges

## PHASE B – OBEDIENCE

*Requirements for BH / IPO 1, 2, 3 / OB (UPr) 1, 2, 3*

### REQUIREMENTS

EXERCISE	BH Part 1	IPO 1 OB (UPr) 1 APr 1	IPO 2 OB (UPr) 2 APr 2	IPO 3 OB (UPr) 3 APr 3
<b>POINTS</b>				
Heeling On Leash	15	-	-	-
Heeling Off Leash	15	20	10	10
Sit In Motion	10	10	10	10
Down In Motion	10	10	10	-
Walking/Running Down In Motion	-	-		10
Walking Stand	-	-	10	-
Running Stand	-	-	-	10
Retrieve On Flat	-	10	10	10
Retrieve Over Hurdle	-	15	15	15
Retrieve Over Wall	-	15	15	15
Send Away	-	10	10	10
Long Down	10	10	10	10
<b>TOTAL</b>	<b>60</b>	<b>100</b>	<b>100</b>	<b>100</b>



## EQUIPMENT

### **ONE-METER HURDLE CONSTRUCTION:**

Height: 1 meter

Width: 1.5 meters

Nonflexible (rigid) top - no "goal posts".

<p style="text-align: center;">150 cm</p> 	<p>The jump has a height of 100 cm (39.4 inches) and a width of 150 cm (59 inches) (see sketch)</p> <p>The top should be rigid. Practice jumps are not permitted during the trial.</p>
---	--

## 1.8-METER SCALING WALL

### Schrägwand

Vorderansicht  
Höhe 180 cm  
Breite 150 cm

Seitenansicht  
Seitenlänge je 191 cm  
Steigleisten 24 x 48

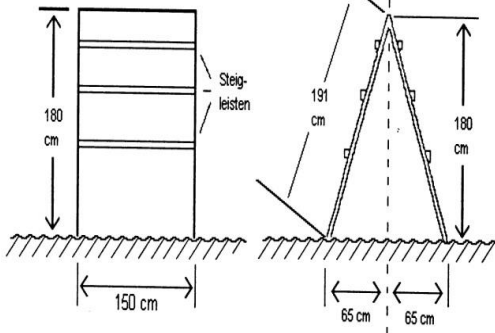

The scaling wall consists of 2 sides joined at the top and must be 150 cm wide (59 inches) and 180 cm (74.8 inches) high. At the bottom, both sides stand apart so that it is a horizontal height of 180 cm (70 inches). The entire area of the scaling wall must be covered with nonslip / skid material. The upper part of each side has 3 cleats. All dogs must jump the same obstacles.

The dimensions of the two (2) sides of the scaling wall are 1.91 meters long by 1.5 meters wide. The wall shall be constructed of sturdy materials and reinforced to make it rigid. Three (3) cleats 24 mm x 48 mm on each side, that extend the width of the wall, shall be located approximately 25, 55, and 85 centimeters from the top edge. The scaling wall is the same for all examination levels (1-3).

Practice jumps are not permitted during the trial.

At the beginning of obedience, the equipment, as specified by the trial rules, is to be checked.

## DUMBBELLS

### DUMBBELL WEIGHTS

	IPO 1 OB (UPr) 1 APr 1	IPO 2 OB (UPr) 2 APr 2	IPO 3 OB (UPr) 3 APr 3
For flat retrieve	650 grams	1,000 grams	2,000 grams
For one-meter jump	650 grams	650 grams	650 grams
For scaling wall	650 grams	650 grams	650 grams

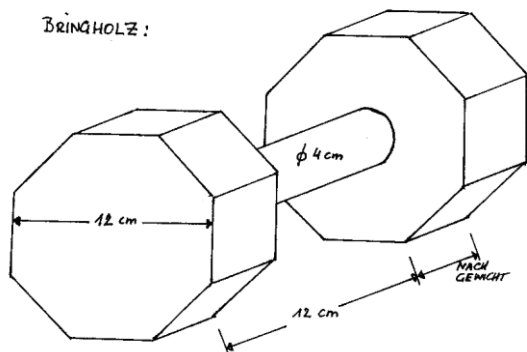

For the retrieve exercises, only one (1) set of dumbbells is permitted. All participants are required to use the same dumbbells that are provided by the hosting club. Handler-owned dumbbells are not permitted.

The sketch of the dumbbell as shown in the rules is only a sample. Important is the fact that the weights are correct and that the braces are made of wood and that the braces are 4 cm from the ground.

- The bar in the middle of the dumbbell, which the dog grips, must not exceed twelve (12) cm in length and four (4) cm in diameter.
- The bar must be at least four (4) cm off of the ground.
- Spitting on the dumbbell by the handler is not allowed.
- Practice jumps are not permitted during the performance.

- The dumbbell in the picture is just a sample; other shapes are permitted. The weight and material are the important features.
- In all the retrieving exercises, the dumbbell may not be placed in the dog's mouth prior to the retrieve.
- The dog is to accompany the handler when the handler goes to pick up the dumbbell. The dog may sit as the handler picks up the dumbbell, but no further than one (1) meter away. The handler may pick up the dumbbell while moving.

### **HANDLER'S BLIND**

One (1) blind must be provided for use by IPO 3, APr 3 and OB (UPr) 3 handlers while their dogs are on the long down. As a courtesy, the host club may provide a chair. The blind for the handler must be placed within the trial field.

### **PISTOL AND AMMUNITION**

Gunfire will be from a six (6) mm (22 caliber) pistol with a closed barrel that does not release a projectile.

## **TRIAL PROCEDURE**

### **BEGINNING OF EXERCISES**

The judge gives the order to begin every exercise. The handler should look to the judge prior to starting each exercise. If a handler mixes up the order of individual obedience exercises (performs one out of order), the judge is obligated to interrupt the "false exercise" with an instruction to the handler to show the correct exercise next. No point deduction will be made for this error.

**REPORTING IN** - At the beginning of each trial section, handlers must report-in to the trial judge in a sportsmanlike manner. The carrying of play articles, toys, or food is not permitted. All use of motivational objects must be stopped, and they must be discarded before entering the trial field. The judge may ask the handler to remove any item that may be a signal or influence the performance of the dog. (i.e., help for the dogs like gloves, hats, vests, etc.)

***The handler that is getting ready to work first in motion (heeling) must be at the start position with the dog in the basic position at the same time as the other handler has their dog in the basic position ready for the long down.***

**BH** - The handlers enter the field with their dogs on lead and report-in in the basic position.

**IPO 1 / APr 1 / OB (UPr) 1** – The handlers enter the field with their dogs, heeling on leash, and report-in in the basic position. After reporting in the leash is removed.

**IPO 2, 3 / APr 2, 3 / OB (UPr) 2, 3** – The handlers enter the field off leash and report-in in the basic position.

Throughout the obedience routine, the dogs must wear a collar, and the handlers must carry the lead with them at all times. The lead may be fastened around the handler's body with the clasp to the opposite side of the dog or may be placed in the handler's pocket.

### **PHYSICALLY HANDICAPPED**

If a handler cannot correctly demonstrate part of an exercise because of a physical handicap, he / she must inform the judge of this prior to the beginning of the trial. If the handler's handicap does not allow the dog to heel on the handler's left side, the dog may heel on the right side. At all times the USCA will make every reasonable attempt to follow and support the Americans with Disabilities Act (ADA). As long as the changes do not affect the fundamentals of the exercise, no point deductions will be made.

### **BASIC POSITION AND START OF EXERCISES**

All exercises begin and end in the "basic position". The "basic position" is the handler standing in an upright / straight, attentive, sporting posture with feet squarely under the hips and both hands in a normal position resting down at the sides of the body, (a splay-legged or legs widely apart stance is not permitted in any exercise). The handlers' hands must be at their side in a  
Page 53 / Ver. 1.3

natural position, either between the handler and dog or over (on the outside) of the dog if it's required due to the size or position of the dog. The handler's hand placement must not influence or affect the dog's behavior (attention / position). The dog's position is sitting on the handler's left side with its right shoulder in line with the handler's knee and its body parallel to the handler (the dog should be as close as possible without leaning on or impeding the handler). The dog should be calm, focused and attentive to the handler in the basic position. The handler may look (make eye contact) at his dog in basic position and during all exercises (excluding the "Long Down under Distraction") with no fault occurring (point deduction) as long as "looking at the dog" does not or is not used to influence or effect behavior (i.e., "help" by turning to look back at the dog or look when giving a command).

Assuming the basic position is allowed only once at the start of each exercise, or the handler can take up basic position once after praising the dog at the end of the last exercise. The basic position at the end of the previous exercise can be used as the starting position for the following exercise. It is also permissible for the handler to assume a new basic position. On small trial fields, the judge may require the handler to start all exercises from the same starting point. The handler should wait for the judge's signal before beginning the new exercise.

When picking up a dog from the stand or down position, the handler must put the dog into basic position with a "sit" command. The command "fuss" / "heel" is faulty. This is also correct in the pick-up of the dog in protection.

A vocal dog (whining or barking) in basic position or during the exercise is faulty and will be evaluated for deduction in each individual exercise not the overall phase.

## **DEVELOPMENT OF THE EXERCISES**

The buildup or development of all obedience exercises occurs forward out of the basic position. On the judge's signal, the handler must show a minimum of ten (10) paces to a maximum fifteen (15) paces as the development for the following exercises before the command may be given:

- Sit out of Motion
- Down out of Motion (in both fast and slow paces in IPO3)
- Walking Stand
- Running Stand
- Send away

Errors in the basic position and development of the exercise must be considered in judging the individual exercises.

### **THREE-SECOND PAUSE**

Before every finish after a front sit (as in a recall or retrieve), as well as after returning to the dog (as in the moving sit or walking stand), a distinct pause of about three (3) seconds is to be observed (or upon the judge's signal). A similar three (3) second pause is to be made during the long down exercise, prior to downing the dog from the basic position and also when returning to the dog and giving the "sit" command on the pick-up.

### **HANDLER'S DISTANCE FROM THE DOG**

Handlers must go a minimum of thirty (30) paces in those exercises where the handler must leave the dog and then recall the dog. Any exercise where the handler returns to the dog such as "sit out of motion" or "walking stand" is a minimum of fifteen (15) paces. The judge may stop a handler from distancing himself / herself too far from the dog.

### **PRAISE**

Praising the dog is allowed after every completed exercise, but only in the basic position (the praise should be calm and only one (1) time). After that, the handler may take a new basic position, or, between praising and starting a new exercise, a distinct pause of three (3) seconds is to be observed (or upon the judge's signal).

Between exercises, value is to be placed on the dog remaining constantly at heel. Releasing the dog and playing is not permitted.

## **BODY HELP / HANDLER HELP**

Help from the handler is not permitted and, if used, will result in a deduction. (e.g., looking back, hand movement, body movement.) Strong handler help to make the dog perform the exercise will be faulty, and a deduction of up to loss of all points may occur if the dog would not have performed the exercise without the help.

## **VOICE COMMANDS**

The prescribed commands are established in the Trial Rules. When recalling the dog, the dog's name may be used *instead* of the command "hier" / "come". However, use of the dog's name *in combination with* the command will be counted as a double command and penalized by a deduction. The one (1) exception is during the blind search in the protection phase. Other than that, all commands should be one (1) word. Once a command is given, that command must remain the same throughout the trial for that exercise or action.

If a dog fails to perform an exercise after three (3) commands are given, the exercise is terminated and no points are given for it. If the dog does not recall after three (3) commands, the handler is instructed to go and pick up his / her dog and assume basic position. The recall exercise is marked as zero (0), but the team is allowed to continue.

In the retrieve exercises, if the dog does not let go of the dumbbell the team is disqualified.

### ***Penalties for additional commands:***

- **1st extra command:** that part of the exercise rated "satisfactory".
- **2nd extra command:** that part of the exercise rated "insufficient".

## **ABOUT TURNS**

About turns are to be performed as left about turns (German turn), however, the dog may either circle around the handler, or back up in place (FCI international / military flip turn). In the flip turn, the dog must stay in heel position as the handler makes the turn. In any instance, the handler and dog must execute the same about turn throughout the obedience phase.



## **FRONTS AND FINISHES**

The dog must sit quickly in front, close, and straight. Upon command, after the required three (3) second pause or on the judge's signal, the dog must take up the ending basic position (go from "front" to "finish") quickly and close. The dog may perform the "finish" by going around (behind) the handler or by executing a military (flip) finish from in front of the handler.

**RETURNING TO THE DOG** - The handler may return from the front or by going around (behind) the dog.

## **DESCRIPTION OF EXERCISES**

### **HEELING ON LEASH**

*Commands: "Fuss" / "Heel"*

*BH / IPO VO* (The BH and the IPO VO are the only trial levels that have the on-lead heeling exercise.)

The Heeling on Leash exercise begins in the "Basic Position".

**Note: There are two (2) right turns, two (2) about turns, and one (1) left turn before entering the group. If the field allows room 15 paces minimum should be shown after each turn.**

The "Heeling on Leash" pattern is the same as the "Heeling off Leash" pattern described below in the "Heeling Off Leash" section. While heeling on leash, the leash is held in the left hand and must be slack during the exercise.

The "Heeling On Leash" Exercise ends after leaving the group and sitting with the dog in "Basic Position" facing the group.

In the BH or IPO VO, the leash is removed outside the group in the basic position after the on-leash portion. The dog may be praised in the basic position before the lead is removed and starting the off-leash heeling. The handler and dog should be facing the group during this procedure. This is the completion of the Heeling on leash exercise.

For the BH and IPO VO, the "Heeling off Leash" Exercise begins at this point by entering the group and completing a right and a left turn (or a left and a right turn), a sit next to a member of the group and then taking up the "Basic Position" to repeat the heeling pattern (described below in "Off Leash Heeling").

## **HEELING OFF LEASH**

*Commands: "Fuss" / "Heel"*

BH / IPO 1, 2, 3 / APr 1, 2, 3 / OB (UPr) 1, 2, 3

**Note: There are two (2) right turns, two (2) about turns, and one (1) left turn before entering the group. If the field allows room 15 paces minimum should be shown after each turn.**

The "Heeling Off Leash" starts from the basic position with the dog "off lead", at the command "fuss" / "heel", the dog must always go with the handler willingly, attentively and close, not impeding the handlers normal stride / gait. The dog must remain straight (parallel) to the handler with his shoulder blade even with the handler's knee through all changes of pace, turns, and in the group. Whenever the handler stops, the dog must automatically sit quickly and straight beside the handler and must remain calm and attentive. The dog must move in a natural, powerful and purposeful gait with a normal topline. Excessive hopping or squatting is faulty.

At the start of the exercise, the handler and his dog move out forty (40) to fifty (50) paces without stopping. After demonstrating the about turn and an additional ten (10) to fifteen (15) paces normal, the handler shows the fast and slow paces (at least ten (10) to fifteen (15) paces each fast and slow pace). Then, at a normal pace, two (2) right turns, one (1) about turn and a stop are to be demonstrated. At all times, the dog must remain on the left side of the handler with the dog's shoulder blade level with the handler's knee. The dog may not forge, lag or heel wide. The handler must demonstrate the about turn as a left about turn.

**BEHAVIOR DURING CHANGE OF PACE** - The change of pace from fast to slow must take place without any "normal" transition steps in between. The handler must show distinct differences in speed.

- Normal walking should be shown at a natural stride
- The fast should be natural, not over-hurried running or sprinting
- The slow should likewise be a natural pace.

The handler is permitted to use the verbal command "fuss" / "heel" only when starting from the basic position or when changing pace. When the handler stands still, the dog must sit immediately and without help from the handler. The handler may not move closer to the dog if the dog is sitting at a distance from the handler. On instruction from the judge, the handler moves forward and shows one (1) left turn on the way to the group for the next exercise.

It is faulty if the dog is lagging, forging or heeling wide. The dog must move in a natural, powerful and purposeful gait with a normal topline. Excessive hopping or squatting is faulty. Hesitant or slow turns on the handler's part are also faulty. The off-lead heeling begins in the BH with the group work. After leaving the group, a new basic position must be established.

***IPO 1, 2, 3 / APr, 1, 2, 3 / OB (UPr) 1, 2, 3*** - Off-lead heeling is the start of obedience. In IPO 1, 2, 3 / APr 1, 2, 3 / OB (UPr) 1, 2, 3, the group heeling concludes the heeling exercise and light praise is permitted, but only after attaining the final basic position.

## **GROUP**

Heeling through the group of moving people is to be shown on lead and off lead in the BH and off lead **only** in the IPO 1, 2, 3 / APr 1, 2, 3 and OB (UPr) 1, 2, 3.

The handler and the dog walk through a moving group, consisting of at least four (4) people. In the group, the handler must heel the dog around two (2) people, once to the left and once to the right. The handler must come to a halt near a person in the group with the dog between the group person and the handler to complete the exercise. The judge may request the handler to repeat the exercise. The handler and the dog leave the group and assume  
Page 59 / Ver. 1.3

the basic position. In the BH, the lead is removed outside the group in the basic position after the on-lead portion. The dog may be praised in the basic position before the lead is removed and starting the off-lead heeling. The handler and dog should be facing the group during this procedure.

## **THE GUNSHOTS**

The firing of the gunshots is done during the free heeling on the first straight leg of the pattern and during the "down under distraction". Two (2) shots will be fired five (5) seconds apart. The first shot is fired after the handler has walked a distance of about fifteen (15) paces. In the IPO 3, APr 3 and OB (UPr) 3, care must be taken to ensure that the handler of the dog on the "down" is out of the dog's sight.

In evaluating the gunshots, the judge must consider if the reaction is a training error. For example, if a dog gets up on the long down, the judge must determine if it was connected with the gunshots or a training problem.

In doubtful cases, the judge is obligated to assess the dog's gunshot indifference by first instructing the handler to put the dog on lead. Shots will then be fired by the judge at a distance of about fifteen (15) paces, during which the dog must remain on a loose lead.

If the dog has a negative reaction to the gun fire, it will immediately be disqualified from the trial. No points will be awarded. Entry into scorebook: "Disqualified due to gun shyness."

## **MOVING EXERCISES (Sit, Down with Recall, Walking Stand, Running Stand)**

The dog is to perform the sit, down, and stand exercises after a single command. The handler may give an additional command immediately after the first command, although this will be penalized and considered faulty.

If, at the command, the dog performs a different exercise (i.e., the dog lies down on the moving sit exercise), a partial score will be given and the exercise will be rated insufficient (see the individual exercises).

If the dog does not respond to the first command, but continues following the handler, two (2) additional commands for a total of three (3) may be given (within a few paces) before the exercise is terminated. Rating: see "Voice Commands".

**DIVISION OF THE EXERCISES** - Two-part exercises such as the "down with recall" and "running stand" should be divided in order to obtain a differential judgment. The division occurs in:

- **Implementation:** Basic Position - Development (Build-Up) - Exercise Execution
- **Recall:** Recall - Sit in Front - Finish - Basic Position

In judging each exercise, the behavior of the dog is to be attentively observed beginning with the basic position up to the end of the exercise. Partial points can only be given if an exercise is shown completely.

#### **SCORING CRITERIA FOR THE IMPLEMENTATION**

- **Behavior in the Basic Position:** Sits straight / crooked at heel - Sits calmly / restlessly - Crowds at sit.
- **Behavior in the Development:** Forges - Lags - Heels attentively - Crowds the handler at heel - Receives handler help - Development is too short.
- **Behavior in the Exercise Execution:** Reacts promptly to command - Executes command quickly - Sits / lies / stands calmly / restlessly - Receives handler help - Performs command incorrectly.
- **Behavior in the Exercise to the Handler:** The dog should remain calm / not restless, and attentive to Handler.
- **Behavior at any time during the exercise by vocalizing:** Barking / whining.

#### **SCORING CRITERIA FOR THE RECALL**

- **Behavior in the Recall** - Reacts quickly / hesitantly to command - Does not remain lying / standing - On command, comes quickly / slowly / hesitantly to the handler - Alters speed of gait in the

recall - Comes directly or in a curve to the handler - Receives handler help or additional commands.

- **Behavior in the Front Sit** - Doesn't sit in front and goes immediately to the heel position or remains standing - Sits hesitantly in front and presses against the handler - Sits in front closely / far away / crooked or to the side - Runs past the handler - Receives handler help to sit in front.
- **Behavior in the Finish Exercise (coming to heel)** - Comes to heel tightly, quickly, in a wide arc or hesitantly - Does not perform the finish - Receives handler help or additional commands.
- **Behavior in the Basic Position** - Sits straight / crooked at heel - Sits calmly / restlessly - Crowds at sit.

### **SIT OUT OF MOTION**

*Commands: "Fuss" / "Heel" - "Sitz" / "Sit"*

<b>Trial Level</b>	<b>BH</b>	<b>IPO 1 OB (UPr) 1 APr 1</b>	<b>IPO 2 OB (UPr) 2 APr 2</b>	<b>IPO 3 OB (UPr) 3 APr 3</b>
<b>Points</b>	10	10	10	10

From the basic position, the handler goes straight ahead at a normal pace with his / her free heeling dog. At a minimum of ten (10) paces and not to exceed fifteen (15) paces, the "sitz" / "sit" command is given and the dog must sit fast and straight without the handler interrupting his pace or looking sideways or backwards at the dog. The dog must sit quietly (not restlessly) and be attentive to the handler. After walking at least fifteen (15) paces further, the handler stops and immediately turns around toward the dog. On the judge's signal, the handler returns to the dog and takes up the basic position on the dog's right side.

**BH** - From the basic position, the handler goes straight ahead at a normal pace with his / her free heeling dog. At a minimum of ten (10) paces and not to exceed fifteen (15) paces, the handler stops and the dog comes to basic position. The handler gives the command "sitz" / "sit", pauses (it may be

shown as described for IPO out of motion without pause) and then walks at least fifteen (15) paces further. The handler stops and immediately turns around toward the dog. The dog must sit quietly (not restlessly) and be attentive to the handler. On the judge's signal, the handler returns to the dog and takes up the basic position on the dog's right side.

### **DOWN OUT OF MOTION WITH RECALL**

*Commands: "Fuss" / "Heel", "Platz" / "Down" and "Hier" / "Come" OR dog's name, "Fuss" / "Heel"*

<b>Trial Level</b>	<b>BH</b>	<b>IPO 1 OB (UPr) 1 APr 1</b>	<b>IPO 2 OB (UPr) 2 APr 2</b>	<b>IPO 3 OB (UPr) 3 APr 3</b>
<b>Points</b>	10	10	10	10

**DIVISION OF THE EXERCISES** - The down with recall is divided into two (2) parts: implementation and recall. Each is worth five (5) points.

***IPO 1, 2 / APr 1, 2 / OB (UPr) 1, 2*** - From the basic position, the handler goes straight ahead at a normal pace with his / her free heeling dog. At a minimum of ten (10) paces and not to exceed fifteen (15) paces, the command "platz" / "down" is given and the dog must lie down fast and straight without the handler interrupting his pace or looking backwards at the dog. The dog must down quietly (not restlessly) and be attentive to the handler. After walking at least thirty (30) further paces, the handler stops and immediately turns around to face the dog. The handler may not step right or left to line up with the dog. On the judge's signal, he / she recalls the dog, either with the command "hier" / "come" or the dog's name.

The dog must come to the handler willingly, quickly, and directly and must sit close and straight in front of the handler. On the command "fuss" / "heel", the dog must rapidly go to the basic position. The handler is not permitted to change his / her position during this exercise.

If the dog remains standing or sits at the "platz" command, five (5) points will be deducted.

*Synopsis: Basic position, 10-15 normal paces, "down" command, minimum of thirty (30) normal paces, "come" command, after three (3) seconds, "heel" command, end at basic position.*

**BH** - The down with recall is divided into two (2) parts: implementation and recall, each worth five (5) points.

From the basic position, the handler goes straight ahead at a normal pace with his / her free heeling dog. At a minimum of ten (10) paces and not to exceed fifteen (15) paces, the handler stops and the dog comes to basic position. The handler shows a pause, then commands the dog "platz" / "down" (it may be shown as described for IPO out of motion without pause). The dog, on the command "platz" / "down", must lie down quickly and straight. The dog must down quietly (not restlessly) and be attentive to the handler. After walking at least thirty (30) paces further, the handler stops and immediately turns around to face the dog. The handler may not step right or left to line up with the dog. On the judge's signal, he / she recalls the dog, either with the command "hier" / "come" or the dog's name.

The dog must come to the handler willingly, quickly, and directly and must sit close and straight in front of the handler. On the command "fuss" / "heel", the dog must rapidly go to the basic position. The handler is not permitted to change his position during this exercise.

If the dog remains standing or sits at the "platz" command, five (5) points will be deducted.

**IPO 3 / APPr 3 / OB (UPr) 3** - From the basic position, the handler goes straight ahead at a normal pace with his / her free heeling dog. At a minimum of ten (10) and not to exceed fifteen (15) paces, the command "fuss" / "heel" is given and the handler and dog go into the running pace. After a further minimum of ten (10) and no more than fifteen (15) running paces, the dog, on the command "platz" / "down", must lie down quickly and straight without the handler interrupting his pace or looking backwards at the dog. The dog must down quietly (not restlessly) and be attentive to the



handler. After at least thirty (30) paces, the handler stops and immediately turns around to face the dog. The handler may not step right or left to line up with the dog. On the judge's signal, he / she recalls the dog, either with the command "hier" / "come" or with the dog's name.

The dog must come to the handler freely, quickly and directly and must sit close and straight in front of the handler. On the command "fuss" / "heel", the dog must quickly go to the basic position. The handler is not permitted to change his / her position during this exercise.

If the dog remains standing or sits at the "platz" / "down" command, five (5) points will be deducted.

*Synopsis: Basic position, 10-15 normal paces, 10-15 fast paces, "down" command, minimum of thirty (30) running paces, "come" command, after three (3) seconds, "heel" command, end at basic position.*

### **STAND WHILE WALKING**

*Commands: "Fuss" / "Heel" - "Steh" / "Stand" - "Sitz" / "Sit"*

<b>Trial Level</b>	<b>BH</b>	<b>IPO 1 OB (UPr) 1 APr 1</b>	<b>IPO 2 OB (UPr) 2 APr 2</b>	<b>IPO 3 OB (UPr) 3 APr 3</b>
<b>Points</b>	-	-	10	-

From the basic position, the handler goes straight ahead at a normal pace with his / her free heeling dog. At a minimum of ten (10) paces and not to exceed fifteen (15) paces, the command "steh" / "stand" is given and the dog must immediately stop and stand still without the handler breaking stride or looking sideways or backwards at the dog. The dog must stand quietly (not restlessly) and be attentive to the handler. After walking at least fifteen (15) paces further, the handler stops and immediately turns around toward the dog. On the judge's signal, the handler returns to the dog and takes up the basic position on the dog's right side. The handler, after a three (3) second pause or at the judge's signal, commands the dog to sit. If the dog sits or lies down on the "steh" / "stand" command, five (5) points will be deducted.

*Synopsis: Basic position, 10-15 normal paces, "stand" command, minimum of 15 normal paces, after three (3) seconds, "heel" command, end at basic position.*

### **STAND WHILE RUNNING WITH RECALL**

*Commands: "Fuss" / "Heel", "Steh" / "Stand", "Hier" / "Come" or dog's name, "Fuss" / "Heel"*

<b>Trial Level</b>	<b>BH</b>	<b>IPO 1 OB (UPr) 1 APr 1</b>	<b>IPO 2 OB (UPr) 2 APr 2</b>	<b>IPO 3 OB (UPr) 3 APr 3</b>
<b>Points</b>	-	-	-	10

**DIVISION OF THE EXERCISES (Running Stand)** - The running stand is divided into two (2) parts: implementation and recall, each worth five (5) points.

**IPO 3 / Apr 3 / OB (UPr) 3:** From the basic position, the handler runs straight ahead with his / her free heeling dog. At a minimum of ten (10) paces and not to exceed fifteen (15) paces, the command "steh" / "stand" is given and the dog must immediately stop and stand still without the handler breaking stride or looking sideways or backwards at the dog. The dog must stand quietly. The dog must stand quietly (not restlessly) and be attentive to the handler. After running at least thirty (30) paces further, the handler stops and immediately turns around toward the dog. The handler may not step right or left to line up with the dog. On the judge's signal, the handler recalls the dog with the command "hier" / "come" or the dog's name. The dog must come in willingly, quickly, and straight, and must sit close in front of the handler. The handler is not permitted to change his / her position during this exercise. On the command "fuss" / "heel", the dog must rapidly take the basic position.

If the dog sits or lies down on the "steh" / "stand" command, five (5) points will be deducted.

*Synopsis: Basic position, 10-15 running paces, "stand" command, minimum of thirty (30) running paces, "come" command, after three (3) seconds, "heel" command, and after three (3) seconds, finish the dog to basic position.*

## **RETRIEVING EXERCISES**

While the handler is picking up the dumbbell from the dumbbell stand, the dog must remain under control. The dog must accompany the handler during the dumbbell pick up to within a minimum of one (1) meter. The dumbbell may be picked up and returned to the stand by sitting in the basic position in front or beside the stand or by free heeling the dog by the stand to pick up the dumbbell.

Practice jumps during the trial are prohibited. The handler may not place the dumbbell in the dog's mouth prior to the retrieving exercises.

The handler must remain in the basic position during the dumbbell throw. If the handler's outside foot moves in order for the handler to throw the dumbbell no point loss (only 1 foot / leg may move as the throw is performed). A deduction may incur if the movement is extreme and / or affects the dog in the basic position. If the dumbbell, as a result of an awkward throw, falls wide to the side, the handler may ask the judge for permission to re-throw. The dog must remain in the basic position while the handler retrieves the poorly thrown dumbbell. The handler must return to the original basic position. There is no pumping of the dumbbell before the throw (i.e., swinging the dumbbell back and forth repeatedly).

Basic position for the handler during the jump and wall retrieve are to be marked by the judge or club at 5 paces from the jump or wall. The mark is a minimum distance to the jump and wall. Handlers may take up basic position further behind the mark. The handler is only allowed a maximum of three (3) attempts to make a correct dumbbell throw that allows the dog to perform the retrieve. If the handler fails to make a good throw in three (3) attempts, all points are lost.

**SCORING** - Dropping the dumbbell, hesitantly picking it up, restless behavior, sluggish retrieving and playing with or mouthing the dumbbell will be penalized by a maximum of four (4) points. In the overall scoring of the

Page 67 / Ver. 1.3

exercise, special value is to be placed upon calm and firm holding of the dumbbell, the speed out and back, the physical abilities of jumping and scaling (climbing) as well as the directness to the dumbbell. If the dog passes over the dumbbell by one (1) step or less on the pickup, it is not faulty.

If the dog does not release the dumbbell after three (3) commands, the team is disqualified. All points awarded up to this point are taken away, and the dog cannot continue to any other phase.

***If the dog does not go at least one (1) way over the wall or jump along with retrieving the dumbbell, no points are awarded.***

### **RETRIEVE ON THE FLAT**

*Commands: "Bring" / "Fetch", "Aus" / "Out", "Fuss" / "Heel"*

<b>Trial Level</b>	<b>BH</b>	<b>IPO 1 OB (UPr) 1 APr 1</b>	<b>IPO 2 OB (UPr) 2 APr 2</b>	<b>IPO 3 OB (UPr) 3 APr 3</b>
<b>Points</b>	-	10	10	10

Until the dog receives the command to "bring" / "fetch", the dog must remain quietly sitting free in the basic position. The dumbbell must be thrown approximately ten (10) meters. The command "bring" / "fetch" will be given when the dumbbell is lying still. The dog must run briskly to the dumbbell, immediately pick it up, and bring it quickly and directly back to the handler. The dog must sit close and straight in front of the handler, holding the dumbbell firmly and calmly in his mouth until the handler takes it from him after a three (3) second pause, or at the judge's signal with the command "aus" / "out".

The handler must hold the dumbbell on the right side of his / her body with an extended arm (i.e., not tucked high under the arm). After a three (3) second pause, or at the judge's signal, the handler commands the dog with the command "fuss" / "heel" into the ending basic position. The handler is not permitted to change his position during the entire exercise. If the

Page 68 / Ver. 1.3

handler leaves his / her position before the exercise is completed, the exercise will be rated "insufficient".

### **RETRIEVE OVER THE ONE-METER JUMP**

*Commands: "Hopp" / "Jump", "Bring" / "Fetch", "Aus" / "Out", "Fuss" / "Heel"*

<b>Trial Level</b>	<b>BH</b>	<b>IPO 1 OB (UPr) 1 APr 1</b>	<b>IPO 2 OB (UPr) 2 APr 2</b>	<b>IPO 3 OB (UPr) 3 APr 3</b>
<b>Points</b>	-	15	15	15

The handler must take the basic position in front of the hurdle in such a way that it is possible for the dog to make a clean jump, but no closer than 5 paces. The dog must remain sitting quietly in the basic position until he is given the command "hopp" / "jump". The dumbbell is to be thrown far enough so that the dog is able to show a clean return jump.

The command "hopp" / "jump" must be given when the dumbbell is lying still. The command "bring" / "fetch" is given during the outward jump while the dog is in the air and before the dog touches the ground on the opposite side of the hurdle.

The dog must jump cleanly and run briskly to the dumbbell, immediately pick it up, and return quickly and directly back to the handler. The dog must sit close and straight in front of the handler, holding the dumbbell firmly and calmly in his mouth until the handler takes it from him after a three (3) second pause, or at the judge's signal with the command "aus" / "out".

The handler must hold the dumbbell on the right side of his / her body with an extended arm (i.e., not tucked high under the arm). After a three (3) second pause, or at the judge's signal, the handler commands the dog with the command "fuss" / "heel" into the ending basic position. The handler is not permitted to change his position during the entire exercise. If the handler leaves his position before the exercise is completed, the exercise will be rated "insufficient".

In the event that the dog knocks the hurdle over on the jump out to the dumbbell, the judge evaluates the performance to the dumbbell and pick up, mandatory four (4) points are deducted for knocking over the jump along with any other faults to that point. Then the hurdle is reset and the exercise is repeated, this time with only the return portion of the exercise from the dumbbell pick up is evaluated on the second attempt. The combination of the two (2) attempts makes the final rating of the performance. If the hurdle is knocked over on the second attempt the exercise is faulty and zero (0) points are awarded.

If the thrown dumbbell lands too far to one side of the jump or is poorly visible for the dog, the handler may ask the judge for a re-throw, or the judge may ask that it be re-thrown, and no points are deducted. The dog must remain sitting during this time. If the dog follows the handler in retrieving the dumbbell, but remains in front of the jump, then the exercise is evaluated accordingly. If the dog follows the handler past the jump, all points are lost.

**SCORING** - The dog is scored on the following points:

- Basic position
- Behavior at any time during the exercise by vocalizing = barking / whining
- Dog's attitude before the command: restless behavior = up to four (4) points deducted
- Reaction to the command and outward jump: touching jump is rated "good" / pushing off jump is rated "satisfactory" / pushing very hard off jump is rated "insufficient"
- Pick up: slow pick up, dropping or playing with the dumbbell = up to four (4) points deducted
- Return jump: touching jump is rated "good" / pushing off jump is rated "satisfactory" / pushing very hard off jump is rated "insufficient"
- Sit in front: mouthing, chewing = up to four (4) points deducted
- Three (3) second pause
- Release of dumbbell
- Failure to release after three (3) commands = disqualification

- If the dog drops the dumbbell at any time and does not pick it up  
= all points are lost
- Three (3) second pause
- Finish

A partial score is only possible when a retrieve is shown. If the dog does not retrieve the dumbbell or go over the jump at least one (1) way there are no points awarded.

**Example:**

Clean jumps (both) and faultless retrieve = 0 points deducted.

Outward and return jump performed without retrieve = all points deducted.

Outward or return jump done with retrieve = five (5) points deducted.

**RETRIEVE OVER THE SCALING WALL**

*Commands: "Hopp" / "Jump", "Bring" / "Fetch", "Aus" / "Out", "Fuss" / "Heel"*

Trial Level	BH	IPO 1 OB (UPr) 1 APr 1	IPO 2 OB (UPr) 2 APr 2	IPO 3 OB (UPr) 3 APr 3
Points	-	15	15	15

The handler must take the basic position in front of the scaling wall in such a way that it is possible for the dog to make a clean jump, but no closer than 5 paces. The dog must sit quietly in the basic position until he is given the command "hopp" / "jump". The dumbbell must be thrown far enough that the return jump can also be shown in correct scaling form. The command "bring" / "fetch" is given as the dog goes over the scaling wall and before the dog touches the ground on the other side.

The dog must scale the wall quickly and run briskly to the dumbbell, immediately pick it up, and return quickly and directly over the wall back to the handler. The dog must sit close and straight in front of the handler, holding the dumbbell firmly and calmly in its mouth until the handler takes it

after a three (3) second pause, or at the judge's signal with the "aus" / "out" command.

The handler must hold the dumbbell on the right side of his / her body with an extended arm (i.e., not tucked high under the arm). After a three (3) second pause, or at the judge's signal, the handler commands the dog with the command "fuss" / "heel" into the ending basic position. The handler is not permitted to change his position during the entire exercise. If the handler leaves his position before the exercise is completed, the exercise will be rated "insufficient".

If the thrown dumbbell lands too far to one side of the wall or is poorly visible for the dog, the handler may ask the judge for a re-throw, or the judge may ask that it be re-thrown, and no points are deducted. The dog must remain sitting during this time. If the dog follows the handler in retrieving the dumbbell, but remains in front of the wall, then the exercise is evaluated accordingly. If the dog follows the handler past the wall, all points are lost.

**SCORING** - The dog is scored on the following points:

- Basic position
- Behavior at any time during the exercise by vocalizing = barking / whining
- Dog's attitude before the command: restless behavior = up to four (4) points deducted
- Reaction to the command and outward jump over the wall.
- Pick up: slow pick up, dropping or playing with the dumbbell = up to four (4) points deducted
- Reaction to the return jump over the wall.
- Sit in front: mouthing, chewing = up to four (4) points deducted
- Three (3) second pause
- Release of dumbbell
- Failure to release after three (3) commands = disqualification
- If the dog drops the dumbbell at any time and does not pick it up = all points are lost
- Three (3) second pause
- Finish



A partial score is only possible when a retrieve is shown. If the dog does not retrieve the dumbbell or go over the wall at least one (1) way there are no points awarded.

### **SEND AWAY**

*Commands: "Fuss" / "Heel", "Voraus" / "Go Out", "Platz" / "Down", "Sitz"/ "Sit"*

<b>Trial Level</b>	<b>BH</b>	<b>IPO 1 OB (UPr) 1 APr 1</b>	<b>IPO 2 OB (UPr) 2 APr 2</b>	<b>IPO 3 OB (UPr) 3 APr 3</b>
<b>Points</b>	-	10	10	10

The judge will designate the start position. The handler is not allowed in any way to excite, build up, or stage the dog prior to the start of the exercise. From the basic position, the handler goes straight ahead at a normal pace with his / her free heeling dog. At a minimum of ten (10) paces and not to exceed fifteen (15) paces, the handler gives the command "voraus" / "go out". The dog must run quickly in a straight line away from the handler for a distance of at least thirty (30) paces while the handler stands still. While giving the command "voraus" / "go out", the handler may raise the arm smoothly and without undue influence upon the dog. The handler may not bend over while sending dog, and handler's hand must be above the dog's withers. On the judge's signal, the handler gives the verbal command "platz" / "down". The dog must lie down immediately. The handler may keep his arm raised until the dog assumes the down position.

At the judge's signal, the handler goes to the dog's right side and, after a three (3) second pause, or at the judge's signal, commands the dog "sitz" / "sit" into the basic position.

After the dog is picked up from the long down and goes to the end of the field while the other team is doing the "Send Away", the dog can only lay down or sit beside the handler. The handler must remain with the dog.

*Synopsis: Basic position, 10-15 normal paces, "go out" command, minimum of thirty (30) normal paces, "down" command, basic position*

**Scoring** - Repeated raising of the arm is not permitted. Sideways deviation, hesitant or premature lying down and premature standing up of the dog while being picked up will result in a partial score. After reaching the required distance, the judge will give the direction to down the dog. If the dog does not allow himself to be stopped, the exercise is rated with 0 points.

**SCORING** - The dog is scored on the following points:

- Basic position
- Behavior at any time during the exercise by vocalizing = barking / whining
- Dog's attitude before the command: restless behavior = up to four (4) points deducted
- Reaction to the command
- Speed and straightness on "Send Away"
- Slow response to first down command = -1.5
- One (1) additional command to "down" the dog = -2.5 (for total of -4)
- Two (2) additional commands to "down" the dog = -3.5 (for total of -7.5)
- Dog goes to the end of the field, or returns to the handler by more than 3 meters, or does not down = all points lost.

**LONG DOWN UNDER DISTRACTION**

*Commands: "Platz" / "Down", "Sitz" / "Sit"*

Trial Level	BH	IPO 1 OB (UPr) 1 APr 1	IPO 2 OB (UPr) 2 APr 2	IPO 3 OB (UPr) 3 APr 3
Points	10	10	10	10

**BH** - The handler will heel with the dog on lead to the location designated by the judge. On the judge's signal, the handler gives the "platz" / "down" command from the basic position. The handler should unleash the dog and put the leash away before giving the "platz" / "down" command. No leash or other article is to be left with the dog. The handler moves away to a distance of thirty (30) paces and stands on the field with his / her back to the dog.

During the down, the dog must remain lying quietly. On the judge's signal, the handler returns to the dog's right side and after a three (3) second pause, or at the judge's signal, commands the dog "sitz" / "sit" into the basic position. The handler should put the leash back on the dog while in the basic position and before heeling to the location designated by the judge.

**IPO 1, 2, 3 / APr 1, 2, 3 / OB (UPr) 1, 2, 3** - The handler will heel with the dog to the location designated by the judge (the BH will heel to the long down position on lead and remove the lead at the judge's signal before downing the dog). On the judge's signal, the handler gives the "platz" / "down" command from the basic position. No leash or other article is to be left with the dog. The handler moves away to a distance of thirty (30) paces. In the IPO 3, the handler is out of sight of the dog (usually in a blind provided for that purpose). For all other levels, the handler shall stand with his / her back to the dog. Handlers may not leave the field.

During the down, the dog must lie quietly. At the judge's signal, the handler goes to the dog's right side and, after a three (3) second pause, or at the judge's signal, commands the dog "sitz" / "sit" into the basic position.

## **SCORING**

- If the dog sits or stands, lies restlessly or moves within three (3) meters from the "down" spot, a partial score will result.
- If the dog leaves the "down" spot by more than three (3) meters before the performing dog completes the retrieve on flat exercise, no points will be given.
- If the dog approaches the handler as he / she comes to pick the dog up, the exercise will be rated "satisfactory".

Whenever possible, bitches are to be placed on the "down" at a spot separate from where the males are placed.

**SPECIAL NOTES FOR THE BH DEGREE** - In the BH test, if the dog leaves the down position by more than three (3) meters before the end of the 2<sup>nd</sup> exercise (Free Heeling) no partial score is possible. If the dog stays in the position to the start of Exercise 3 (Sit Out of Motion) and then breaks it will be scored at best with a rating of insufficient or at least a 3.5 point deduction. If the dog comes toward the handler on the pickup, the exercise will be scored at best with a rating of "satisfactory" or at least a 3 point deduction and be subject to further deductions for other faults.

## **PHASE C - PROTECTION WORK**

### **JUDGING CRITERIA FOR THE PROTECTION WORK**

**GENERAL** - Rating protection work is of great significance for the breeding selection of working dogs. For this reason, the assessment of the protection work has the highest priority. It is essential to differentiate natural and useful performance aptitudes from learned behaviors.

In a suitable location, six (6) blinds are to be set up in a staggered fashion, three (3) on each side of the field. Six (6) blinds must be set up on the trial field regardless of the level of entries in the trial. The necessary markings must be clearly visible for the handler, the judge, and the helper. The location for each exercise in protection must be marked out on the trial field, showing the beginning spot and the direction of each exercise. This is required in all levels of trials.

#### **HELPER GUIDELINES (refer to the USCA Helper Program for complete information)**

- The helper in Phase "C" is the judge's assistant on the day of the trial. Before the beginning of protection work, the helper will be instructed by the judge. The helper must perform according to those instructions.

- Only USCA-classified helpers with a current membership are allowed to work in sanctioned trials.
- The helper must wear protective clothing, including appropriate footwear, pants, jacket, and protection sleeve.
- At all USCA-sanctioned events, the leather-covered "soft" stick is the only type of stick allowed by the FCI / WUSV for protection work. The "stick contact" required by the trial rules are to be carried out in a manner that complies with local animal protection regulations.
- The sleeve must be equipped with a bite bar, and the sleeve cover must be made from burlap (jute) in a natural color. If it is necessary for the helper to keep an eye on the dog in the guarding phase (i.e., the dog is circling the helper), the helper is not required to stand still, although he is not permitted to make any threatening or defensive movements. The helper must protect his body with the sleeve and not the soft stick.
- The helper must follow the handler's instructions during the disarming in accordance with the trial rules. It is up to the handler in which way he / she chooses to take the soft stick from the helper. The handler may not instruct the helper to turn away from facing the dog. The handler may not leave the dog in a guarding position and move next to the helper to call the dog to basic position (between the helper and handler); the dog and handler must free heel to the transport position as a team.
- In club level trials one (1) helper may be used to work all dogs entered into the trial. If more than one (1) helper is used in a club trial, all dogs in each level (IPO 1, 2, 3 / Apr 1, 2, 3 ) should be worked by the same helper to maintain an equal and fair examination / test for all of the dogs. (i.e., all dogs competing for the IPO 1 should be worked by the same helper, all dogs competing for the IPO 2 should be worked by the same helper, etc. The helper doing the work for the IPO 1 can be a different helper than the helper that is working the IPO 2, etc.) *The exception to this is if a helper for the trial is also entered into the trial a different helper must be used to test his dog.* Only in an IPO 3 can there be two (2) helpers. (i.e., one (1) helper for the front half and one (1) helper for the back half.) Sportsmanship

must be maintained and the helper work should be fair and equal to all entries. In club level trials one (1) helper may be used for the IPO 3. In regional or national level trials, such as championships or qualification trials, a minimum of two (2) helpers must be used for the IPO 3 level. ***In all levels of events, it is permitted to use a helper who lives in the same household as one of the handlers.***

Common events that lead to disqualification are, but not limited to:

- If the dog is determined to be out of control.
- If the dog leaves the protection field at any time. The protection is then stopped, and the team is disqualified. (Three (3) extra commands are not allowed at this point to get the dog back on the field.) This includes leaving the field during the "Search for the Helper", if the dog goes beyond the designated boundaries of the trial field (i.e., a very wide or deep search that takes the dog off the field, going beyond, past or under fences or into the spectator area).
- If dog does not release with a maximum of three (3) out commands or release only after the handler takes physical measures.
- If the dog grips any other part of the helper's body other than the protective sleeve.
- If the dog is determined by the judge to be unsafe, overly aggressive or dangerous to the helper, judge, handler or any person on the protection field or attending the event.
- If the handler presents themselves in an unsportsmanlike manner.

Disqualification will result in no points recorded for any phase of the trial, and the dog will not go on to complete any additional uncompleted phases. No TSB rating will be given to a dog that is disqualified (DQ).

Common events that lead to termination are, but not limited to:

- If the dog fails to catch and engage the helper before the helper has reached the twenty (20) pace distance, or fail to remain on the sleeve in the "Attempted Escape of the Helper".

- If in any defense exercise the dog fails to engage the helper.
- If the dog requires more than the allowed number of commands to complete the exercise it will result in termination or disqualification (i.e., no out after three (3) commands is disqualification (DQ), more than two (2) additional commands to complete the transport, call out, etc., are reasons for disqualification (DQ)).

If the dog has had the protection work terminated, but has completed a "fighting / grip exercise", no score for protection will be recorded. A TSB Rating will be given to any dog that makes it to a "fighting / grip exercise". If terminated the dog will still retain any points already earned in Phases "A" and "B" or will be required to finish any uncompleted phases.

**The most important criteria for the assessment of protection work are:**

- ***Ausgeglichene Triebveranlagung*** - Well-balanced drives.
- ***Selbstsicherheit*** - Self-confidence.
- ***Belastbarkeit*** - Ability to work under pressure; toughness; resilience.
- ***Nervenfestigkeit*** - Steadfast, sound nerves.
- ***Führigkeit*** - Willingness to take direction (commands), responsiveness to the handler.

## **THE PHASES OF PROTECTION WORK**

The protection work is divided into three (3) phases, under which the most variable temperament and drive attributes will be discussed.

The phases are divided as follows:

- Search and hold exercises (including guarding phases).
- Engagement with the helper. (fighting, pressure, grip, transition)
- Controllability of the dog (obedience, optimal handler-dog relationship).

## SEARCH EXERCISES

In the searching exercises, self-confidence, nerve steadiness, directability and controllability are of great significance. In IPO 1, 2, 3 / APr 1, 2, 3 the dog has to show some control and make an attempt to be directed to the first blind for a search. If the dog makes no attempt / effort to be directed to the first blind but runs directly from handler to the blind where the helper is hiding the team will be disqualified (DQ). Entry into the scorebook: "Disqualified out of control."

The handler should walk down field during the blind search at a steady, consistent pace (running or excessive changes of pace are faulty). The handler must stand still at the position they are on the centerline (stop moving forward down field) when the dog enters (runs into) the live blind regardless of missed blinds or where the handler is on the field until the judge signals the handler to approach.

The commands allowed per each blind are "search command - dog's name - hier command" or "search command - hier command", and count as one (1) set of commands per blind.

If the dog does not find the helper in the blind, the handler may resend him up to two (2) additional times. The handler must stay at center field position. If the dog stays with the helper protection will continue, but the search is rated "insufficient". After being sent unsuccessfully a total of three (3) times to the helper (original plus two (2) additional commands), protection is terminated. TSB rating will be marked as a dash (-) because the dog did not make it to a fighting exercise. If the handler calls the dog to him and this stops his forward progress (i.e., the dog comes to basic position) at any time during the blind search, it is terminated. The handler may not use excessive body movement (help) to send the dog (i.e., the handler cannot bend over while sending dog, and handler's hand must be above the dog's withers, the handler must not use excessive arm movements). Any excessive "help" is faulty.



If the dog requires more than two (2) additional commands in total to complete the search, the search is terminated. If a dog is terminated there is no point entry for that phase (no points earned in the phase are recorded); all other remaining points earned in the phases in the trial are retained and entered; if the dog has not completed any phases it will be required to complete them (e.g., tracking and obedience).

***Assessment criteria for the search:***

- Intense.
- Goal oriented, purposeful.
- Goes directly to the blind indicated.
- Dog is readily guided and directed.
- Close, tight, and attentive running around the blind.
- Dog should pass in front of handler.

**HOLD AND BARK**

In the Hold and Bark Exercise the dog should as it enters the blind, immediately show a strong "holding" behavior and immediately start "barking". The tone and intensity of the barking should be powerful, focused and continuous. The dogs position should be close and remain consistent without making contact with the helper (bothering). The dog should remain focused on the helper throughout the exercise displaying these behaviors, undistracted by the approach of the handler. When called out or picked up (IPO1) the dog must show control and immediate response to the handler's command. If the dog does not come to basic position after three (3) commands for the call out, the team is disqualified (DQ).

If the dog enters the blind and grips the helper's sleeve and does not release during the "Hold and Bark" Exercise (i.e., the dog is gripping or gripping and releasing), after the twenty (20) seconds the judge will signal the handler to come to the "call out" line. If the dog is still gripping the sleeve when the handler is at the call out spot, they may only use the "hier-fuss" or "come-heel" command one (1) time to make the dog release and come to heel. If the dog does not release and call out to the handler with the one (1) command the dog will be disqualified (DQ). Entry into the scorebook: "Disqualified out of control." If the dog releases and calls out to the

Page 81 / Ver. 1.3

handler, there is a nine (9) point deduction, and the protection work continues. If the handler uses the "out" command the team is disqualified (DQ).

If the dog finds the helper, but leaves the helper, the handler is allowed only one (1) additional command to resend the dog into the blind. This applies whether the dog leaves the helper when the handler is standing at the center field line or whether the dog leaves as the handler is called in and is approaching the blind but has not yet reached the blind. If the handler is approaching the blind when the dog leaves the helper for the first time, the handler will be instructed to stop and then resend the dog to the blind. If the dog stays with the helper until the handler reaches the call out line and the judge signals the handler to call out or pickup the dog then there will be a nine (9) points deduction, and the protection can continue. If the dog leaves on his own again (second time) then the team is terminated. No TSB Rating will be given.

If the dog leaves the helper in the "Hold and Bark" while the handler has passed the blind, but before signaled by the judge to call out the dog, the judge has the discretion to let protection continue if he / she feels the dog left the helper because it anticipated the call out. A deduction of up to 6.5 points (insufficient) for early call out may occur.

**Assessment criteria for the holding phases (Holding):**

- Focused, attentive to the helper.
- Close.
- Intense.
- Persistent right up to the call out.
- Self-sure and confident.

**Assessment criteria for the Barking phases (Barking):**

- Continuous, sustained.
- Energetic / enthusiastic.
- Convincing.

*Special merit is placed upon the amount of self-confidence and intense behavior shown by the dog in the guarding phases. (e.g., dominance, confidence, strength and intensity in the guarding.)*

## **THE ESCAPE**

The exercise begins at the basic position after the call out from the "Hold and Bark". The dog should show obedience to the handler in its free heeling from the basic position to the designated position for the escape (curved line, approximately 5 paces from the call out position and 5 paces from the helper), present a basic position at the designated position (line) and then receive the command "down / platz" that positions the dog behind the designated line. The handler will then leave the dog in the "down / platz" position with the dog watching the helper and the handler will return to the blind. The handler may watch the dog and helper from the blind. (i.e., stand partway in to the blind to be able to see the dog and helper.) The dog should remain calm and watchful / attentive to the helper. On the judge's signal the helper will make an attempted escape, immediately as the helper moves the handler must give a "go" command to the dog to "release" it from the down position. The dog should with power and confidence grip and attempt to control / stop the helper from escaping.

In the escape if the dog is completely over the line when downed, the handler will be asked to call the dog back to basic position behind the line and downed correctly. If the dog in the down (platz) is not behind the escape line, but has contact with line the dog is allowed to continue, but the rating will be lowered one (1) category even if the remaining part of the escape is performed correctly. If the dog leaves (breaks) the escape position on its own and only guards the helper (no grip), the handler may on instruction from the judge go to the down position and call the dog back to reposition it behind the designated line and into the down (platz) position, but will receive a point deduction of insufficient. If the dogs leaves (breaks) the position on its own and grips anything (e.g., sleeve, helper, etc.) the dog will be disqualified.

## **THE ENGAGEMENT SEQUENCES**

The engagement sequences consist of three (3) phases. In these phases, the dog shows its determination, self-confidence and ability to withstand pressure (TSB).

The phases of the fighting sequences are:

- Readiness to engage and take defensive action (defense drive).
- Periods of pressure /stress (ability to take pressure, including the stationary phase before the "out").
- Guarding.

**FIGHT AND DEFENSE READINESS (Defense Drive)** - Escape, defense, re-attack (by the helper), counter-attack (by the dog).

**Assessment criteria for defense drive:**

- Determination.
- Self-confidence.
- Full, forceful, hard and steady grip.

**PRESSURE PHASE** - The dog must work energetically and self-confidently in all periods of stress. The dog must show no negative reaction, it should show steady and confident behavior in its reaction to withstand the helper's attempt to test the dogs "TSB" (courage and hardness) during the pressure phase and stick contact ("drive").

**Assessment criteria for the pressure phases:**

- Energetic.
- Self-confident.
- Unfazed (includes maintaining the grip).

**GUARDING PHASES** - The dog must guard (hold) the helper with intensity, self-confidence, and attentiveness. Special merit is placed upon the amount of self-confidence and intense behavior shown by the dog in the guarding phases. (e.g., dominance, confidence, strength and intensity in the guarding.)

**Assessment criteria for the guarding phase:**

- Close
- Attentive

**Point Assessments:**

- If the dog is slightly inattentive and / or slightly bothersome, a one (1) point deduction will result.
- If the dog guards the helper very inattentively and / or is very bothersome, a two (2) point deduction will result.
- If the dog does not guard the helper, but remains with the helper, a five (5) point deduction will result.
- If the dog stops guarding and comes toward the handler as the handler approaches, if the handler is within three (3) meters of the helper, the exercise is rated as insufficient. If the dog leaves the helper by more than three (3) meters or the handler gives a command so that the dog stays with the helper, Phase "C" is terminated.

**ATTACK ON THE DOG OUT OF MOTION** - All handlers and dogs (IPO 1, 2, 3 / APr 1, 2, 3) are required to take the same position on the field in line with blind number one (1). In the "Attack on the Dog Out of Motion" the dog must remain calm in the "watch position" until released. The handler may choose to hold the dog by the collar or not with no deduction. The helper will run from the blind for all levels and turn at midline to attack the dog. For IPO 1 / APr 1 the judge will signal for the dog to be released when the helper is thirty (30) to forty (40) paces away from the handler / dog. For IPO 2 / APr 2 the judge will signal for the dog to be released when the helper is forty (40) to fifty (50) paces away from the handler / dog. In IPO 3 / APr 3 the judge will signal for the dog to be released when the helper is fifty (50) or more paces away (full field) from the dog. If the dog is not direct in its attack to the helper it is faulty. If the dog makes contact with the judge on the "Attack on the Dog Out of Motion", the team is disqualified (DQ).

**CONTROLLABILITY**

Controllability is the readiness of the dog to show obedience during the protection work. It is particularly evident in the exercise portions dealing with the blind search, the transports, heeling, the downs, the "outs", and the guarding phases.

**Note:** The handler may give one (1) "sit" command when approaching the dog to "pick up" for disarms or transports with no point deduction. The command must be given when the handler is within one (1) pace (approximately one (1) meter) of the dog. Additional commands will be faulty. If the handler, at any time during the protection phase, gives a "down" / "platz" or "no" / "phooey" (or similar) command to the dog to regain control, they will be disqualified (DQ). In the "Attack on the Dog Out of Motion" the dog must remain calm until released. If the dog is not calm in basic position (e.g., jumping, barking, etc.), the dog will receive up to a three (3) point deduction. If the dog breaks free before the judge signals the handler to release, the exercise is at best rated high insufficient. If the dog breaks free before the helper has made the turn towards the handler / dog up field, the dog is disqualified (DQ).

**Assessment criteria for controllability:**

- Controllability during the reporting in and during the blind search.
- Outs correctly.
- Heeling close while being attentive to the helper.
- Fast response (coming to the handler) on the call-out.

**THE GRIP**

The grip has fundamental meaning in the assessment of the protection work. Through evaluation of the grip, the trial judge has the opportunity to discern and emphasize the quality of the dog being judged.

In all phases, the grip must be fundamentally full, forceful, hard and steady.

The evaluation of the quality of the dog on the basis of his grip behavior must take place throughout the entire protection routine. At the same time, the helper's behavior, among other things, is also to be taken into consideration.

In judging the escape, attention is to be given to the fullness of the grip, but priority consideration must be given to the effective hindering of the escape.

## **THE OUTS**

After a fighting sequence stops, the dog must let go without assistance from the helper. Handlers may give the first "out" command on their own without direction from the judge within a reasonable amount of time (approximately less than four (4) or five (5) seconds). If the dog does not let go after the first command, the judge will signal the handler to give as many as two (2) additional "out" commands. The first "out" command can be used by the handler with no deduction even if the dog has already released as long as it is used by the handler immediately after or as the dog outs. The "out" command is not mandatory if the dog has released, but the evaluation of the transition from fighting phase, to out and guarding is important in the evaluation.

If the dog regrips the helper as the handler approaches, and the handler is within three (3) meters he / she must continue walking to basic position and tell the dog to "sit". If the dog releases the sleeve the protection work may continue. If the dog does not release after the one (1) "sit" command the team will be disqualified. If the handler uses "out" at the basic position the protection work will be terminated.

When giving the command "aus" / "out", the handler must stand quietly, without exerting other influence on the dog.

In the evaluation of the "out", the following factors are to be considered:

- The helper must stand still on the judge's signal.
- The dog must immediately release when commanded.
- One (1) "out" command is allowed without point loss.
- The dog must guard the helper.

## CRITERIA FOR SCORING THE "OUT" IN THE PROTECTION WORK

Action	Point Deduction
The dog outs immediately with or without a command.	No deduction
The dog outs slowly to very slowly, re-grips, or bumps several times (without <i>additional</i> command).	Up to 3 points
The dog outs immediately on the second "out" command.	3 points total
The dog outs slowly to very slowly after the second command, re-grips, or bumps several times.	3.5 to 6 points
The dog outs immediately on the third "out" command.	6 points total
The dog outs slowly to very slowly on the third "out" command.	6.5 to 9 points total

The preceding scores apply only to the "out". Other incorrect behavior by the dog will be judged according to the customary scoring system.

**ADDITIONAL COMMENTS** - The handler must give the first "out" command in a self-determined suitable period of time (approximately less than four (4) or five (5) seconds). The two (2) additional commands, if needed, are given on the judge's signal. If a dog fails to "out" after the third command, the protection work will be stopped, and the dog is disqualified (DQ). Entry into the scorebook will be "Disqualified out of control, no out".

When giving the "out" command, the handler is to stand quietly; he may not go toward the dog. Additional verbal / visible commands or other influences will lead to termination of the work. If the dog's name is used, this is scored as an additional command. An exercise will be stopped and the team will be disqualified if the dog receives the helping command "platz" / "down" in order to make the dog release the grip. The handler is, at no time, allowed to reinforce the dog with a "platz" / "down" command if the dog outs and downs after the out.

***Protection work will be stopped and the team disqualified if the dog will not release except through physical influence by the handler.***



***Protection work will be stopped and the team disqualified if the dog is given a command in order to make the dog stay by the helper.***

## **ASSESSMENT OF THE NATURAL TENDENCIES SHOWN BY THE DOG (TSB Assessment)**

### **Assessment criteria:**

**The most important criteria for the assessment of protection work are:**

- ***Ausgeglichene Triebveranlagung*** - Well-balanced drives.
- ***Selbstsicherheit*** - Self-confidence.
- ***Belastbarkeit*** - Ability to work under pressure; toughness; resilience.
- ***Nervenfestigkeit*** - Steadfast, sound nerves.
- ***Führigkeit*** - Willingness to take direction (commands), responsiveness to the handler.

**"Controllability"** is specially evaluated with an influence on the total rating. No written entry about that is made in the performance book.

### **Assessments for TSB:**

Pronounced	<i>"a" (ausgeprägt)</i>
Present	<i>"vh" (vorhanden)</i>
Insufficient	<i>"ng" (nicht genügend)</i>

### **PRONOUNCED** - Requirements of pronounced TSB:

- Sense of physical strength.
- Sense of psychological strength.
- Inner confidence and fearlessness.
- Urge to dominate.
- Hardness.

The overall picture should show these attributes: self-confident, intense, goal-oriented, and secure gripping and holding, with no negative reaction to the pressure and stick threat, with close and attentive watching in the holding and guarding phases.

Small deviations from the above statements / opinions will still allow an "a" (pronounced) rating under certain circumstances.

**PRESENT** - Deficiencies in, for example, the self-confidence, in goal-oriented behavior, in grip and stick behavior, as well as in the guarding phases would earn this rating.

**INSUFFICIENT:** Lacking self-sureness, strong deficiencies with respect to hardness, or disinterest in the helper would earn this rating.

If the dog leaves the helper by a distance of more than three (3) meters or the dog has disengaged or stopped its guarding behavior (e.g., inattentive, not engaged, looking around or looking at the handler, without focus to holding or guarding the helper, etc.) before the judge signals the handler to approach, protection work will be terminated.

### **REPORTING IN**

In every case, at the beginning of protection, the handler must report to the judge unless the judge has instructed otherwise.

During the entire protection phase, special value is placed on the dog's willingness to obey. If the handler cannot report with his / her dog properly (i.e., the dog breaks away and runs to the blind), the handler is allowed a maximum three (3) commands to call the dog back. If the dog does not return after three (3) commands, protection will be stopped because of disobedience and the dog will be disqualified (DQ). Entry into the scorebook: "Disqualified out of control."

### **COLLAR AND LEAD / LEASH**

The handler must carry the lead in all trial levels and in all phases including IPO 3. This includes a requirement that the dog must wear a collar at all times. During off-lead exercises, the lead must be carried out of sight, or hung around the body in such a way that the catch is on the side of the body opposite the dog. (i.e., the leash may be carried around the waist or over the shoulder in a left to right fashion across the body.)

## IPO / APR PROTECTION EXCERSISES

Level	IPO 1 / APr 1	IPO 2 / APr 2	IPO 3 / APr 3
<b>Search for the Helper</b>	5 pt (see below)	5 pt (see below )	10 pt (see below)
<b>Hold and Bark</b>	5pt Hold / 5pt bark (10)	5pt Hold / 5pt bark (10)	5pt Hold / 5pt bark (10)
<b>Prevention of Attempted Escape</b>	20 pt	10 pt	10pt
<b>Defense Against Attack while guarding</b>	35 pt	20 pt	20 pt
<b>Back transport</b>	-	5 pt	5 pt
<b>Attack on Dog Out of back transport</b>	-	30 pt	15 pt
<b>Attack on Dog Out of Motion</b>	30 pt	20 pt	10 pt
<b>Defense Against Dog After the Guarding Phase</b>	-	-	20 pt
<b>Total</b>	100 pt	100 pt	100 pt

### IPO 1 / APR 1 PROTECTION REPORT-IN AND SEARCH

**REPORTING IN** - With the dog on lead, the handler reports to the judge in the basic position, unless the judge instructs otherwise. The handler then goes to the center of the field between the two (2) blinds. The basic position is taken and the leash is removed. On the judge's signal, from between blinds four (4) and five (5), the handler turns and sends his dog to search while remaining in the center of the field. The handler must be facing down field in basic position before taking off leash. Only after the signal from the judge to begin, may the team then turn to face the first blind.

### **SEARCH FOR THE HELPER (5 points)**

*Commands: "Voran" / "Go On" or "Revier" / "Search", "Hier" / "Come"*

On judge's signal, the handler turns and sends his dog to search. The dog will be sent by means of verbal commands and / or visible signals. Only one (1) command may be used in sending the dog (e.g., "revier", "voran" or "search"). The command "hier" / "come" may be given in combination with the dog's name. The handler must show the search of two (2) blinds. (blinds five (5) and six (6) with the helper hidden in blind six (6)). The handler must remain on the centerline and may move down the field until the dog enters blind six (6). The handler must stop when the dog reaches the live blind until the judge signals the handler to come to the call out position.

The dog must run the search in front of the handler at all times. When the search command is given, the dog must go directly and purposefully to each blind with intensity and single mindedness and must be attentive to the blind and run around it closely, tightly and attentively. The dog must circle the blind within three (3) meters.

It is faulty for the dog to go back and search a blind that was missed or already searched. The blind is considered missed when the dog refuses to go to the blind after two (2) extra commands, or when the dog starts toward the next blind in the progression without searching the one (1) to which he was directed.

## **IPO 2 / APR 2 PROTECTION REPORT-IN AND SEARCH**

**REPORTING IN** - With the dog on lead, the handler reports to the judge in the basic position, unless the judge instructs otherwise. After reporting in, the lead is removed and the dog must free heel to the starting position. The handler must be facing down field in basic position. Only after the signal from the judge to begin, may the team then turn to face the first blind.

The dog will begin the search from the basic position between blinds two (2) and three (3).

### **SEARCH FOR THE HELPER (5 points)**

*Commands: "Vorán" / "Go On" or "Revier" / "Search", "Hier" / "Come"*

On judge's signal, the handler turns and sends his dog to search. The dog will be sent by means of verbal commands and / or visible signals. Only one (1) command may be used in sending the dog (e.g., "revier", "vorán" or "search"). The command "hier" / "come" may be given in combination with the dog's name. The handler must show four (4) blinds searched, alternating two (2) to the left and two (2) to the right (or vice-versa). The handler must proceed at a normal pace down the imaginary centerline and continue moving forward on the centerline until the dog enters blind six (6). The handler must stop when the dog reaches the live blind until the judge signals the handler to come to the call out position.

The dog must run the search in front of the handler at all times. When the search command is given, the dog must go directly and purposefully to each blind with intensity and single mindedness and must be attentive to the blind and run around it closely, tightly and attentively. The dog must circle the blind within three (3) meters.

It is faulty for the dog to go back and search a blind that was missed or already searched. The blind is considered missed when the dog refuses to go to the blind after two (2) extra commands, or when the dog starts toward the next blind in the progression without searching the one (1) to which he was directed.

## **IPO 3 / APR 3 PROTECTION REPORT-IN AND SEARCH**

**REPORTING IN** - With the dog off lead, the handler reports to the judge in the basic position, unless the judge instructs otherwise. After reporting in, the dog must free heel to the starting position. The handler must be facing down field with the dog in basic position. Only after the signal from the judge to begin, may the team then turn to face the first blind.

The dog will begin the search from the basic position in line with the first (1) blind.

### **SEARCH FOR THE HELPER (10 points)**

*Commands: "Voran" / "Go-On" or "Revier" / "Search", "Hier" / "Come"*

On judge's signal, the handler turns and sends his dog to search. The dog will be sent by means of verbal commands and / or visible signals. Only one (1) command may be used in sending the dog (e.g., "revier", "voran" or "search"). The command "hier" / "come" may be given in combination with the dog's name. The handler must show six (6) blinds searched, alternating three (3) to the left and three (3) to the right (or vice-versa). The handler must proceed at a normal pace down the imaginary centerline and continue moving forward on the centerline until the dog enters blind six (6). The handler must stop when the dog reaches the live blind until the judge signals the handler to come to the call out position.

The dog must run the search in front of the handler at all times. When the search command is given, the dog must go directly and purposefully to each blind with intensity and single mindedness and must be attentive to the blind and run around it closely, tightly and attentively. The dog must circle the blind within three (3) meters.

It is faulty for the dog to go back and search a blind that was missed or already searched. The blind is considered missed when the dog refuses to go to the blind after two (2) extra commands, or when the dog starts toward the next blind in the progression without searching the one (1) to which he was directed.

**SCORING** – it is faulty (among other things):

- Not to assume the basic position before beginning the search.
- To use additional verbal or visual signals other than those allowed.
- To not adhere to the imaginary center line or to not walk at a normal pace.
- For the dog to perform wide sweeping (not purposeful) searches.
- For the dog not to search the blinds closely / deeply enough.

## IPO 1, 2, 3 / APR 1, 2, 3 HOLD AND BARK

### HOLD (5 points) AND BARK (5 points) 10 points total

Trial Level	IPO 1 / AP r 1	IPO 2 / AP r 2	IPO 3 / AP r 3
Points	10	10	10

### **HOLD AND BARK**

*Commands: (completion) "Hier Fuss" / "Come Heel", "Platz" / "Down"*

The dog must confront the helper actively and attentively and bark continuously. The dog is not permitted to jump on or grip the helper. After the dog has barked for approximately twenty (20) seconds, the handler approaches the blind (upon receiving a signal from the judge) and stops at the indicated spot, facing the helper.

Intense, close circling of the blind is permitted on a limited basis but is faulty.

**CALL OUT OF THE BLIND** - On another signal from the judge, the handler calls the dog out with the commands "hier-fuss" / "come-heel". The dog must come immediately to the handler and sit quickly next to the handler in the basic position at the call out position (five (5) paces from the blind). The dog is to sit quietly (without barking), straight, and attentive in the basic position.

**For IPO 1** the handler may also chose to pick up the dog from the guarding by approaching the dog and assuming the basic position and with the command "heel" / "fuss" free heel the dog back to the call out position (five (5) paces from blind). (On the pick up the handler may use the "sit" command at basic position before heeling from the blind.)

**SCORING** - The hold and bark exercise is to be scored in all trial levels as a whole. In order to be able to make a uniform score, five (5) points for the "hold" and five (5) points for the "bark" are provided.

Incorrect conduct for the "hold" includes, among other things:

- Inattentiveness.

- Temporarily leaving the helper.
- Disassociation and / or uncertainty at the helper.
- Dog allows himself to be distracted from the helper.
- The dog looks to, or moves toward, the handler.
- Little or no intensity in the holding.
- Lack of focus in the holding.
- Bothering the helper by jumping on him / her, bumping, light touching.
- Lightly or strongly gripping, or gripping and holding tightly.
- Leaving the helper and going toward the handler as they approach the blind (partial score).
- If the dog grips immediately and holds on, the whole exercise is rated "insufficient".

Incorrect conduct for the call out of the blind includes among other things if the dog:

- Comes hesitantly to the handler on the command.
- Does not come on a single command.
- Does not come to the handler after the third command.
- Does not come to the basic position on the call out.
- Shows himself to be, on the whole, disobedient.
- Will not stay in the basic position when the helper steps out of the blind.

**LEAVING THE HELPER / GRIPPING DURING THE HOLD** - If the dog grips the helper in the blind, but doesn't let go, after the twenty (20) second holding time the judge will signal the handler to come to the "call out" line. The handler may only use the "hier / fuss" or "come / heel" command one (1) time to make the dog release and come to heel or the team will be disqualified (no out, out of control). If the dog releases and comes to heel there is a nine (9) point deduction and the protection work continues. If the dog leaves the helper as the handler is approaching the blind, and the handler is between the blind and the call out line a deduction of up to 6.5 points (insufficient) for early call out may occur. If the dog leaves the helper as the handler approaches, but hasn't reached the blind, the handler is allowed one (1) additional command to send the dog back into the blind, if the handler hasn't already exhausted his one (1) extra command. If the dog



stays with the helper until the judge signals the call out or pickup, then a 9 point deduction, but the team can continue. If the dog leaves on his own again then the team is terminated. No TSB rating is given.

Incorrect conduct for the "bark" and "hold" (among other things) are:

- No bark.
- Beginning the barking late.
- Barking only briefly.
- Does not bark continuously.
- Stops barking when the handler approaches.
- Grips, bumps, or bothers
- Does not display power, focus or intensity in the barking

Deductions for barking:

- Weak barking (not energetic), not continuous barking  
Deduction: up to 2 points
- No barking, yet shows attentive holding  
Deduction: 5 points (mandatory)

## **IPO 1, 2, 3 / APR 1, 2, 3 PREVENTION OF AN ATTEMPTED ESCAPE**

### **PREVENTION OF AN ATTEMPTED ESCAPE OF THE HELPER**

Trial Level	IPO 1 / APr 1	IPO 2 / APr 2	IPO 3 / APr 3
<b>Points</b>	20	20	10

### **PREVENTION OF AN ATTEMPTED ESCAPE**

*Commands: "Fuss" / "Heel", "Platz" / "Down", "Aus" / "Out"*

Upon a signal from the judge, the handler orders the helper to step out of the blind. The helper is not permitted to raise his / her arms, nor will the handler instruct him / her to do so. The helper moves at a normal pace to the designated location for the escape. On a signal from the judge, the handler moves with their free heeling dog to the designated spot for the down prior to the escape. The distance between the dog and the helper is five (5) paces.

The handler leaves his guarding dog in the down position and moves directly into the blind, maintaining visual contact with the dog, the judge, and the helper. On the judge's signal, the helper tries to escape. The handler must give the dog a command to follow (i.e., the handler may use "go" or some form of release command. An "attack" or "bite" command is means for disqualification). The dog must immediately prevent the escape without hesitation by means of an energetic and strong grip. The dog may only grip the protective sleeve of the helper. On a signal from the judge, the helper stops running and stands still. When the helper comes to a standstill, the dog must release immediately in a natural manner (transition). Handlers may give the verbal command "aus" / "out" on their own at the appropriate time.

If the dog does not release after the first command, the handler may give up to two (2) additional "aus" / "out" commands, with point deduction, upon receiving a signal from the judge. If the dog does not release after having received three (3) commands, one (1) permissible and two (2) additional commands, the team is to be disqualified. The handler must stand calmly without influencing the dog in any way while giving the command. After the release, the dog must stay close to the helper and guard him attentively.

Incorrect conduct includes, among other things:

- Giving commands to assist the dog.
- The dog is inattentive.
- The grip is uncertain.
- The dog does not have a full, forceful, hard and steady grip.
- The dog slips off the sleeve and re-grips.
- The dog does not make the grip after the helper has taken about twenty (20) steps (protection terminated).
- Does not show the basic position before the down.
- Anticipates the down on his own before the escape.
- Receives physical help to down or additional commands.
- Behaves restlessly in the down position (including barking continuously) and / or will not stay down.
- Breaks from the escape position before the command or before the helper moves and grips the sleeve the team is disqualified (DQ).

- Breaks from the escape position before the command or before the helper moves, but only guards the helper, the handler may go to the down position and call the dog back one (1) time. If successful, the escape is rated "insufficient". If the dog does not come back the team is disqualified (DQ).

## **IPO 1, 2, 3 / APr 1, 2, 3 DEFENSE AGAINST AN ATTACK DURING THE GUARDING PHASE**

### **DEFENSE AGAINST AN ATTACK DURING THE GUARDING PHASE**

Trial Level	IPO 1 / Apr 1	IPO 1 / Apr 2	IPO 3 / Apr 3
<b>Points</b>	35	20	20

### **DEFENSE AGAINST AN ATTACK DURING THE GUARDING PHASE**

***Command:*** "Aus" / "Out"

After a guarding phase of about five (5) seconds, and upon a signal from the judge, the helper makes an attack on the dog. The dog must defend himself through energetic and powerful gripping without any influence from the handler. The dog may only grip the protective sleeve of the helper. As soon as the dog has a grip on the sleeve, the helper applies stick pressure tests, two (2) times. Pressure may only be applied to the shoulders and the area of the withers. The attack on the dog must be in a direction away from the handler. Upon a signal from the judge, the helper stops resisting (drive) and stands still. After the helper has stopped the attack and is standing still, the dog must release (out) immediately in a natural manner (transition). The handler may give a verbal command "aus" / "out" at the appropriate time or additional commands when signaled by the judge, and the dog must guard the helper intensely.

If the dog does not release after the first command, the handler may give up to two (2) additional "aus" / "out" commands, with point deduction, upon receiving a signal from the judge. If the dog does not release after having received three (3) commands, one (1) permissible and two (2) additional

Page 99 / Ver. 1.3

commands, the team is to be disqualified. The handler must stand calmly without influencing the dog in any way while giving the command. After the release, the dog must stay close to the helper and guard him attentively.

It is incorrect, among other things:

- To give commands to assist the dog.
- If the dog shows a lack of confidence.
- If the dog does not grip the sleeve with a full, forceful, hard and steady grip.
- If the dog has an agitated, nervous, or hectic grip.
- For the dog to exhibit a negative reaction to the stick pressure.
- If the dog comes off the sleeve on the stick pressure (protection will be terminated).
- If the dog can be driven away (protection will be terminated).

**COMPLETION / DISARM** - On the judge's signal for IPO 1 / APr 1, the handler walks directly to his dog at a normal pace and with the verbal command "sitz" / "sit", puts the dog in the basic position. If the dog is already sitting, the position of the dog may be reconfirmed with the "sit" command. The handler then heels the dog down to the position for the "Attack Out of Motion" (in line with the number one (1) blind). For IPO 2, 3 / APr 2, 3 the handler walks directly to his dog at a normal pace and with the verbal command "sitz" / "sit" puts the dog in the basic position. The soft stick is not taken from the helper. For the IPO 2, 3 / APr 2, 3 the handler continues on to the back transport.

## IPO 2, 3 / APr 2, 3 BACK TRANSPORT

### BACK TRANSPORT (IPO 2, 3 / APr 2, 3)

Trial Level	IPO 1 / APr 1	IPO 2 / APr 2	IPO 3 / APr 3
Points	-	5	5

### **BACK TRANSPORT**

*Command: "Fuss" / "Heel"*

The handler commands the helper to step back away from the dog, turn around, and to walk ahead (move out). The handler and his / her free heeling dog follows the helper at a distance of five (5) paces. The dog is to watch the helper attentively. The judge will determine the course of the back transport, which will be a distance of approximately thirty (30) paces.

If the free heeling cannot be demonstrated, the protection work will be terminated.

Examples:

During the back transport, if the dog leaves the handler and goes to the helper:

- But does NOT grip the sleeve, the handler has one (1) chance to call the dog back and may continue with a deduction of 4 pts.
- If the dog grips the sleeve, the dog is disqualified for out of control.

Incorrect conduct includes, among other things:

- Forging.
- Dog is inattentive to the helper.
- Dog strays sideways.
- Handler help. (e.g., additional commands or visual aid, handler alters the pace to keep up with the dog, handler grabs the dog, etc.)

## IPO 2, 3 / APr 2, 3 ATTACK ON THE DOG OUT OF THE BACK TRANSPORT

### ATTACK ON THE DOG OUT OF THE BACK TRANSPORT (IPO 2, 3 / APr 2, 3)

Trial Level	IPO 1 / APr 1	IPO 2 / APr 2	IPO 3 / APr 3
Points	-	30	15

### ATTACK ON THE DOG OUT OF THE BACK TRANSPORT

*Command: "Aus" / "Out"*

On a signal from the judge, an attack is performed on the dog out of the back transport. The dog must counter the attack by means of an energetic and powerful grip. The dog may only grip the protective sleeve of the helper. As soon as the dog has a grip on the sleeve, the handler is to stand still. On the judge's command, the helper stops and stands still. After the helper has stopped the attack and is standing still, the dog must release (out) immediately in a natural manner (transition). The handler may give a verbal command "aus" / "out" at the appropriate time or additional commands when signaled by the judge, and the dog must guard the helper intensely and attentively.

It is incorrect, among other things, if the dog:

- Needs commands to initiate the counter attack.
- Is not self-confident.
- Does not grip with a full, forceful, hard and steady grip.
- Has a chewy, nervous or hectic grip.
- Can be driven away (protection will be terminated).

**COMPLETION / DISARM** - On the judge's signal for the IPO 2, 3 / APr 2, 3, the handler walks directly to his / her dog at a normal pace and with the verbal command "sitz" / "sit", puts the dog in the basic position. If the dog is already sitting, the position of the dog may be reconfirmed with the "sit" command. The helper is not permitted to raise his / her arms, nor will the handler instruct him / her to do so. The soft stick is taken from the helper.

The method of disarming the helper is left to the discretion of the handler. For example, the handler can tell the helper to step back slowly two (2) to three (3) paces or may move away from the helper without asking him / her to step back. The handler is not allowed to instruct the helper to turn towards judge.

**SIDE TRANSPORT** - A side transport of the helper to the judge, over a distance of approximately twenty (20) paces, follows. A verbal command of "fuss" / "heel", "forward" or "transport" is permitted. The dog must walk on the helper's right side so that the dog is positioned between the handler and the helper. The dog must watch the helper attentively during the side transport. However, the dog may not bother, jump on, or grip the helper. If at any point during the side transport the dog moves out of position from between the handler and helper, the transport should be stopped and the handler is allowed three (3) attempts to reposition the dog between the handler and helper. If the dog returns to the correct position with a minimum of three (3) commands the team is allowed to continue. At no time is the handler allowed to go to the dog and heel the dog back to the side transport. The group stops in front of the judge. The handler presents the soft stick to the judge and declares, "first part of Phase 'C' completed."

Incorrect conduct includes, among other things:

- The handler does not walk directly to his dog.
- The dog appears oriented to the handler and / or is inattentive.
- The dog is not obedient at the handler's approach.
- The dog is not obedient on the pickup.
- The dog receives several "sit" commands.
- The dog does not sit.
- The handler leaves the dog guarding and proceeds to the side of the helper then recalls the dog to the transport position.

## **IPO 1, 2, 3 / APr 1, 2, 3 ATTACK ON THE DOG OUT OF MOTION**

### **ATTACK ON THE DOG OUT OF MOTION (IPO 1, 2, 3 / APr 1, 2, 3)**

<b>Trial Level</b>	<b>IPO 1 /APr 1</b>	<b>IPO 2 / APr 2</b>	<b>IPO 3 / APr 3</b>
<b>Points</b>	30	20	10

### **ATTACK ON THE DOG OUT OF MOTION**

*Commands: "Vorán" / "Go on", "Aus" / "Out", "Sitz" / "Sit", "Fuss" / "Heel"*

The handler and the free heeling dog are sent to a marked position on the centerline of the field even with the first blind. With the command to "sit", the dog is placed in basic position. The dog must sit calmly in the basic position before the exercise starts. The handler may take the dog by the collar. The dog may not be stimulated or worked up by the handler and must sit calmly next to the handler until he is released at the judge's signal with the command "vorán" / "go on" to defend against the attack.

At the judge's command, the helper comes out of the blind and runs across the field to the imaginary centerline. The handler can be silent or order the helper to stop by calling out "Bleiben Sie stehen" / "Stop, stand still". The helper ignores the instruction and starts a frontal attack upon the handler and dog. The helper yells and makes strong threatening motions. At the judge's signal, when the helper is approximately thirty (30) to forty (40) paces away for the IPO 1 / APr 1, forty (40) to fifty (50) paces away for the IPO 2 / APr 2 or full field distance for the IPO 3 / APr 3, the handler sends his dog with the command "vorán" / "go on". No attack commands may be given. As the dog prepares to engage, the helper should continue to make strong threatening motions.

The handler is not permitted to leave his position.

The dog must counter the attack with intensity and must grip energetically with a full, forceful, hard and steady grip. Once the dog grips, the helper



pressures the dog. On the judge's signal, the helper stops the pressure phase and resisting (drive), and stands still. After the helper has stopped the attack and is standing still, the dog must release (out) immediately in a natural manner (transition). The handler may give a verbal command "aus" / "out" at the appropriate time or additional commands when signaled by the judge, and the dog must guard the helper intensely.

It is incorrect, among other things, if the dog:

- Appears intimidated.
- Is hesitant through the attack.
- Does not go directly for the attack, misses or does not directly engage the sleeve, engages the sleeve but comes off (slips, does not grip hard enough, etc.) but immediately reengages the sleeve; a rating deduction of "M" insufficient will be given.
- Grips timidly.
- Does not have a full, forceful, hard and steady grip.
- Comes off after gripping, though grips again (In this case, it is to be determined if the reason is a helper mistake or a weakness of the dog).
- Can be driven off (protection will be terminated).
- Breaks and goes to the helper before the judge signals.

It is incorrect, among other things, if the handler:

- Uses an attack / bite command disqualification (DQ).
- Moves after sending the dog before judge's instruction.

***For IPO 1, 2 / APr 1, 2 - this completes the fighting exercises, proceed to Completion / Disarm and Side Transport.***

***For IPO 3 / APr 3 - protection continues to "Defense Against an Attack after the Guarding Phase" disregard Completion / Disarm below and proceed to "Defense Against an Attack after Guarding" on next page.***

**COMPLETION / DISARM** - On the judge's signal for the IPO 1, 2 / APr 1, 2, the handler walks directly to his dog at a normal pace and with the verbal command "sitz" / "sit", puts the dog in the basic position. If the dog is already sitting, the position of the dog may be reconfirmed with the "sit"

command. The helper is not permitted to raise his / her arms, nor will the handler instruct him / her to do so. The soft stick is taken from the helper.

The method of disarming the helper is left to the discretion of the handler. For example, the handler can tell the helper to step back slowly two (2) to three (3) paces or may move away from the helper without asking him / her to step back. The handler is not allowed to instruct the helper to turn towards judge.

Incorrect conduct includes, among other things:

- The handler does not walk directly to his dog.
- The dog appears oriented to the handler and / or is inattentive.
- The dog is not obedient at the handler's approach.
- The dog is not obedient on the pickup.
- The dog receives several "sit" commands.
- The dog does not sit.
- The handler leaves the dog guarding and proceeds to the side of the helper then recalls the dog to the transport position.

**SIDE TRANSPORT** - A side transport of the helper to the judge, over a distance of approximately twenty (20) paces, follows. A verbal command of "fuss" / "heel", "forward" or "transport" is permitted. The dog must walk on the helper's right side so that the dog is positioned between the handler and the helper. The dog must watch the helper attentively during the side transport. However, the dog may not bother, jump on, or grip the helper. If at any point during the side transport the dog moves out of position from between the handler and helper, the transport should be stopped and the handler is allowed three (3) attempts to reposition the dog between the handler and helper. If the dog returns to the correct position with a minimum of three (3) commands the team is allowed to continue. At no time is the handler allowed to go to the dog and heel the dog back to the side transport. The group stops in front of the judge. The handler presents the soft stick to the judge and declares, "second part of Phase 'C' completed." After reporting out the handler free heels his / her dog five (5) paces away and leashes his / her dog. The dog is allowed to lie down or sit in basic position beside the handler during the critique. Dogs must be calm.

## IPO 3 / APr 3 DEFENSE AGAINST AN ATTACK AFTER THE GUARDING PHASE

### DEFENSE AGAINST AN ATTACK AFTER THE GUARDING PHASE (IPO 3 / APr 3 only)

Trial Level	IPO 1 /APr 1	IPO 2 / APr 2	IPO 3 / APr 3
Points	-	-	20

#### **DEFENSE AGAINST AN ATTACK AFTER THE GUARDING PHASE**

*Commands: "Aus" / "Out", "Sitz" / "Sit", "Fuss" / "Heel"*

After a guarding phase of about five (5) seconds, and upon a signal from the judge, the helper makes an attack on the dog. The dog must defend himself through energetic and powerful gripping without any influence from the handler. The dog may only grip the protective sleeve of the helper. As soon as the dog has a grip on the sleeve, the helper applies stick pressure tests, two (2) times. Pressure may only be applied to the shoulders and the area of the withers. The attack on the dog must be in a direction away from the handler. Upon a signal from the judge, the helper stops resisting (drive) and stands still. After the helper has stopped the attack and is standing still, the dog must release (out) immediately in a natural manner (transition). The handler may give a verbal command "aus" / "out" at the appropriate time or additional commands when signaled by the judge, and the dog must guard the helper intensely.

If the dog does not release after the first command, the handler may give up to two (2) additional "aus" / "out" commands, with point deduction, upon receiving a signal from the judge. If the dog does not release after having received three (3) commands, one (1) permissible and two (2) additional commands, the team is to be disqualified. The handler must stand calmly without influencing the dog in any way while giving the command. After the release, the dog must stay close to the helper and guard him attentively.

It is incorrect, among other things:

- To give commands to assist the dog.
- If the dog shows a lack of confidence.
- If the dog does not grip with a full, forceful, hard and steady grip.
- If the dog has an agitated, nervous, or hectic grip.
- For the dog to exhibit a negative reaction to the stick pressure.
- If the dog comes off the sleeve on the stick pressure (protection will be terminated).
- If the dog can be driven away (protection will be terminated).

**COMPLETION / DISARM** - On the judge's signal for the IPO 3 / APr 3, the handler walks directly to his dog at a normal pace and with the verbal command "sitz" / "sit", puts the dog in the basic position. If the dog is already sitting, the position of the dog may be reconfirmed with the "sit" command. The helper is not permitted to raise his / her arms, nor will the handler instruct him / her to do so. The soft stick is taken from the helper.

The method of disarming the helper is left to the discretion of the handler. For example, the handler can tell the helper to step back slowly two (2) to three (3) paces or may move away from the helper without asking him / her to step back. The handler is not allowed to instruct the helper to turn towards judge.

Incorrect conduct includes, among other things:

- The handler does not walk directly to his dog.
- The dog appears oriented to the handler and / or is inattentive.
- The dog is not obedient at the handler's approach.
- The dog is not obedient on the pickup.
- The dog receives several "sit" commands.
- The dog does not sit.
- The handler leaves the dog guarding and proceeds to the side of the helper then recalls the dog to the transport position.

**SIDE TRANSPORT** - A side transport of the helper to the judge, over a distance of approximately twenty (20) paces, follows. A verbal command of "fuss" / "heel", "forward" or "transport" is permitted. The dog must walk on the helper's right side so that the dog is positioned between the handler and

the helper. The dog must watch the helper attentively during the side transport. However, the dog may not bother, jump on, or grip the helper. If at any point during the side transport the dog moves out of position from between the handler and helper, the transport should be stopped and the handler is allowed three (3) attempts to reposition the dog between the handler and helper. If the dog returns to the correct position with a minimum of three (3) commands the team is allowed to continue. At no time is the handler allowed to go to the dog and heel the dog back to the side transport. The group stops in front of the judge. The handler presents the soft stick to the judge and declares, "second part of Phase 'C' completed." After reporting out the handler free heels his / her dog five (5) paces away and leashes his / her dog. The dog is allowed to lie down or sit in basic position beside handler during the critique. Dogs must be calm.

## **COMPANION DOG TEST (BH)** **(60 points)**

### **PART A - TRAFFIC / SAFETY TEST** (off the obedience field)

#### **GENERAL PROVISIONS**

The exercises listed below are not conducted on the training field but in a suitable public place. Due to time and distances in some trials, this portion may be conducted away from the training field in the parking area of the property. The judge and the trial chairperson decide where and how the traffic exercises (public streets, walkways, or squares) are conducted. Public traffic must not be disturbed.

Due to the uniqueness of the traffic test, it takes a significant amount of time to conduct this part of the examination. The performance requirements may not be lowered by superficially examining a large number of dogs.

No points are given for the individual exercises in Part B. In order to pass this part of the examination, the overall impression concerning the dog's behavior in traffic and public places is important.

The exercises described below are examples and may be modified by the judge depending on the location in which the test is conducted. The judge is entitled to make dogs repeat exercises or to modify exercises if he / she has any doubts regarding the evaluation of a dog.

### **ENCOUNTER WITH A GROUP OF PEOPLE**

On the judge's request, the handler and the dog walk along a designated stretch of the sidewalk. The dog is on a leash. The judge follows the team at an appropriate distance.

- The dog must follow the handler willingly on a loose leash
- The dog must be indifferent toward pedestrians and bicyclists
- A passing pedestrian (a person that was assigned this task) cuts off the handler. The dog must display neutral and unimpressed behavior
- Handler and dog continue to walk and approach a group of people. The persons in the group are not standing too closely together. The group must consist of at least six (6) people. One (1) of the people in the group starts talking to the handler and greets him with a handshake. The handler gives the dog a command to either lie down or sit next to him / her. The dog must remain calm during the short conversation.

### **ENCOUNTER WITH BICYCLISTS**

The handler walks along a road / path with the dog on leash and a bicyclist passes him / her from behind. The bicyclist rings his bell while passing. In quite a distance, the bicyclist turns around and comes toward the handler and the dog. The bicyclist rings the bell again. The bicyclist has to pass the handler and the dog in such a manner that the dog is located between the passing bicyclist and the handler. The leashed dog must display a steady / indifferent behavior toward the cyclist.

### **ENCOUNTER WITH CARS**

The handler and the dog walk past several cars, with the dog on leash. The engine of one (1) of the cars is started while the handler is walking by. The

door of another car is slammed shut. As handler and dog walk on, a car stops next to them. The window is opened and the handler is asked for directions. The handler instructs the dog to either lie down or sit while this is going on.

The dog must remain calm and display indifferent behavior toward the cars and any traffic noises.

### **ENCOUNTER WITH JOGGERS OR INLINE SKATERS**

The handler and the dog walk along a quiet road. The dog is on leash. At least two (2) joggers (or skaters) pass from behind without reducing their speed. Once the joggers are gone, another jogger runs toward the handler and passes without slowing. It is not mandatory that the dog performs correct on-leash heeling. However, the dog may not bother the people that are passing or coming toward him. It is permitted for the handler to put the dog in a down or a sit during the encounter.

### **ENCOUNTER WITH OTHER DOGS**

Another handler with a dog passes the dog and handler team, turns around and comes back. The dog must show a neutral behavior toward the other dog. The handler may repeat the verbal command "fuss" / "heel" or may put the dog in a down or sit during the encounter.

### **BEHAVIOR OF THE LEASHED DOG TOWARD OTHER ANIMALS WHEN LEFT ALONE IN TRAFFIC FOR A SHORT PERIOD OF TIME**

On the judge's request, the handler walks with the dog along the sidewalk of a road without too much traffic. The dog is on leash. After walking a short distance, and upon a signal from the judge, the handler ties the leash to a fence post or something similar. The handler moves out of the dog's sight (e.g., inside a store or a house entrance).

- The dog is permitted to stand, sit, or lie down
- With the handler out of sight, a pedestrian (designated person) who is walking a dog on leash, walks by at a distance of five (5) paces to the dog that is to be examined
- The dog has to stay calm while the handler is gone. He must let the other dog pass by without showing aggressive behavior (e.g.,

heavy pulling on the leash, continuous barking). At a signal from the judge, the handler picks up the dog.

**Note:** It is up to the judge's discretion whether he lets each individual dog perform each exercise in each location or if he lets all dogs that are to be evaluated perform a selection of the exercises and then moves on to the next location and continues there with the examination in the same manner.

**"Dogs must be able to be touched. At any time at the discretion of the judge the dog may be approached and / or touched."**

## **BH Part – B**

### **BH OBEDIENCE EXERCISES**

(Exercises are listed below in order of execution and are described in detail in previous "Obedience Section" above (pages 35-47))

#### **HEELING ON LEASH (15 points)**

*Command: "Fuss" / "Heel"*

#### **FREE HEELING (15 points)**

*Command "Fuss" / "Heel"*

#### **SIT OUT OF MOTION (10 points)**

*Command: "Sitz" / "Sit"*

**"Note:** In USCA Trials, if the handler chooses to perform this "Sit Out of Motion" exercise as the IPO 1-3 exercises are described in this rulebook (from continuous motion without a stop / pause) no point deduction will occur for not stopping / pausing."

#### **DOWN WITH RECALL (10 points)**

*Commands: "Platz" / "Down", "Hier" / "Come", "Fuss" / "Heel"*



**"Note: In USCA Trials, if the handler chooses to perform this "Down Out of Motion" exercise as the IPO 1-3 exercises are described in this rulebook (from continuous motion without a stop / pause) no point deduction will occur for not stopping / pausing."**

### **LONG DOWN UNDER DISTRACTION (10 points)**

*Commands: "Platz" / "Down", "Sitz" / "Sit"*

***A dog that does not receive at least seventy (70) percent (42 out of 60 points) of the total points is excluded from the rest of the examination.***

**"Dogs must be able to be touched. At any time at the discretion of the judge the dog may be approached and / or touched."**

## **ENDURANCE TEST (Ausdauerprüfung) - AD**

### **GENERAL INFORMATION**

The endurance test (AD) award is not a training degree but exists for show and breed requirements. The AD provides documentation that the dog is physically able to endure a certain amount of physical stress without showing significant fatigue. Given the physical structure of the dog, this condition can best be shown through running. Running challenges the heart and lungs as well as the rest of the body. Other characteristics such as spirit and hardness must be present. Successful demonstration of the test will provide proof that the desired characteristics are present in a healthy body. Both sets of characteristics are prerequisites for a useful breeding program.

The AD test is to be hosted by a local club. The approval to host the event must be obtained by the local club at least four (4) weeks prior to the test. The secretary of the event must be identified at that time and a judge must have been commissioned. Scoresheets must be on hand. By accepting responsibility to host an AD, the local club agrees that during the warm summer months, the event will only be held during the early morning or evening hours. The outside temperature must not exceed 72 degrees Fahrenheit.

The entry form must contain:

- The exact name of the dog, sex, date of birth
- Registration numbers
- Scorebook numbers
- Any earned training degrees
- Name and address of both owner and breeder

Participation in the AD test is voluntary and all risks are assumed by the handler of the dog.

### **REQUIREMENTS FOR ENTRY**

The dog must be at least sixteen (16) months old before it is tested and the maximum permissible age is six (6) years. A maximum of twenty (20) dogs may be permitted to enter with one (1) judge. Should the entry exceed twenty (20) dogs, a second judge must be commissioned. All dogs must be registered.

The dog must be healthy and in good condition; sick dogs, weak dogs, bitches in heat, bitches in whelp and nursing bitches are not allowed to participate.

At the start of the test, the handler will report to the judge in a sporting manner with the dog at the heel position. The scorebook, pedigree and registration papers should be presented at that time. The judge and trial secretary will verify that each dog is in good condition. Dogs that present a tired or listless expression are to be disqualified. The handler will conduct him / herself in a sporting manner. Unsportsmanlike behavior can result in disqualification from the examination. All decisions made by the judge are final.

### **SCORING**

No points or awards will be given for the examination, only the rating of "Passed" or "Not Passed". Only dogs that pass will receive the AD certification.

## **TERRAIN**

The test should preferably be run on streets or roads of varied terrain such as asphalt or dirt. The handler will accompany the dog only on a bicycle.

## **THE TEST**

Handlers must arrive in time to allow the dogs an opportunity to relieve themselves prior to the start of the test.

It is strictly forbidden to consume alcohol during the test.

## **THE RUNNING EXERCISE**

The dogs will be run a total of twenty (20) kilometers (approximately 12.4 miles) at an average speed of twelve (12) to fifteen (15) kilometers per hour (seven (7) to nine (9) miles per hour).

The dog must be kept on leash on the right-hand side of the handler and move in a normal trot next to the bicycle. Depending on safety and at the judge's discretion, the dog may be allowed to trot on the left-hand side. A "springer" may also be used. The leash must be sufficiently long to give the dog the ability to adjust to any changes in speed. Overly fast running is to be avoided. Slight pulling or forging is not faulty, but continually falling behind is faulty.

There will be a fifteen (15) minute rest period after the dogs have completed eight (8) km (4.9 miles). During the rest period, the judge will examine the dogs for fatigue. Tired dogs will be removed from the test. There will be a twenty (20) minute rest period at the end of fifteen (15) km (9.3 miles). The judge will again check the dogs. Dogs that are tired or dogs with sore feet will be removed from the test. Dogs will be allowed to move about freely during the rest periods, but should be on leash. The last five (5) km (3.1 miles) will be run and then there will be a fifteen (15) minute rest period. The judge will again determine if the dog demonstrates tiredness or sore feet due to the running.

The judge and the trial secretary should accompany the dogs on a bicycle or in a car. The judge will make notes about the condition of the dogs and all

deficiencies will be noted. It is necessary that a car follow the handlers and dogs so that tired or sore dogs can be transported. Dogs that lack the proper spirit and hardness, those that show fatigue and dogs that cannot keep up the required speed or need extra time cannot pass the examination.

## **IPO - Preliminary stage (IPO-V)**

Phase A	100 points
Phase B	100 points
Phase C	100 points
<b>Total:</b>	<b>300 points</b>

### **Entry / General requirements**

On the day of the trial event, the dog must have reached the age of fifteen (15) months. No exceptions will be made. A IPO-V is broken down into three (3) phases. Each phase is counted as one (1); the same requirement as IPO 1, 2, and 3.

### **Temperament test**

At the beginning of each test, with the first performance phase, the judge must undertake an impartiality or temperament test of the dog. At any time the judge may determine the need to approach (touch) the dog.

### **IPO-V Phase A - Tracking**

Self-laid track approximately 200 paces, 2 legs, 1 turn (approximately ninety (90) degrees), one (1) handler owned article, no waiting time to run, execution time 10 minutes (the time the dog must complete the track).

Scent pad	10 points
Maintaining the track	59 points
Turn	10 points
Article	21 points
<b>Total</b>	<b>100 points</b>

If the dog does not find any articles, the final evaluation can only be rated as satisfactory (no points greater than 79).

## WORKING AND JUDGING OF THE TRACK

Reporting to the judge occurs in the basic position with the dog prepared to track and the tracking line laid out. At the reporting in, the judge must check the length of the tracking line. A point deduction because of incorrect reporting in may not occur. No deductions are taken if the tracking line is not the required ten (10) meters long. In this case, the tracking line is to be exchanged. If the judge fails to detect a tracking line that is not the correct length before the track commences, there will be no deduction of points.

While the dog is tracking, the judge and any accompanying persons are not permitted in the area of the track where the dog and handler team are working.

### VALUE OF THE TRACK:

Maintaining the track	79%
Article	21%
Total	100%

All percentages are approximate and have to be considered based on the difficulty of the legs.

### POINT ALLOCATION / RATINGS

RATING	20 Points	15 Points	10 Points	5 Points
EXCELLENT	19.5 – 20	14.5 - 15	10	5
VERY GOOD	18 – 19	13.5 - 14	9 - 9.5	4.5
GOOD	16 - 17.5	12 - 13	8 - 8.5	4
SATISFACTORY	14 - 15.5	10.5 - 11.5	7 - 7.5	3.5
INSUFFICIENT	0 - 13.5	0 - 10	0 - 6.5	0 - 3

## **THE START / SCENT PAD**

### ***IPO-VO***

***See Tracking in the IPO section above (pages 19-30) for general information that applies to all tracking.***

***The following exceptions and changes apply to IPO-VO Tracking.***

**PRAISE** - Minimal praise is permissible in IPO-VO as the dog is working out the track, but the handler may not be excessive in the praising of the dog.

Praising at the article is permissible in the same position in which the dog indicated or picked up the article, before or after showing the found article to the judge. The verbal command "such" or "search" is only permitted at the start and after an article.

### **IPO-VO Phase B OBEDIENCE**

Exercise 1:	On-Leash heeling	30 points
Exercise 2:	Off-Leash heeling	20 points
Exercise 3:	Down with recall	15 points
Exercise 4:	Retrieve	10 points
Exercise 5:	Jump over a hurdle	10 points
Exercise 6:	Down under distraction	15 points
<b>Total:</b>		<b>100 points</b>

### **GENERAL REQUIREMENTS:**

*A command to "sit" is permitted for the basic position.*

*In USCA Trials the heeling pattern has been approved to be the same configuration as BH or IPO heeling pattern.*

#### **1. HEELING ON LEASH (30 points)**

*Command: "Fuss" / "Heel"*

From the basic position, the dog is to follow the handler happily on lead upon receiving the verbal command "fuss" / "heel". The leash must be attached to the dead ring.

At the start of the exercise, the handler and his dog move out forty (40) to fifty (50) paces without stopping. After at least fifteen (15) paces there are two (2) gunshots fired at least two (2) seconds apart to test the dog. Additional gunshots may be requested by the judge. After demonstrating the about turn and an additional ten (10) to fifteen (15) paces, the handler shows the fast and slow paces (at least ten (10) to fifteen (15) paces each). Then, at a normal pace, 2 right turns, one (1) about turn and a stop are to be demonstrated. At all times, the dog must remain on the left side of the handler with the dog's shoulder blade level with the handler's knee. The dog may not forge, lag or heel wide. The handler must demonstrate the about turn as a left about turn.

The handler is permitted to use the verbal command "fuss" / "heel" only when starting from the basic position or when changing pace. When the handler stands still, the dog must sit immediately and without help from the handler. The handler may not move closer to the dog if the dog is sitting at a distance from the handler. The leash is to be held in the left hand and must have slack in it. On instruction from the judge, the handler moves forward and shows one (1) left turn on the way to the group for the next exercise.

It is faulty if the dog is lagging, forging, or heeling wide. Hesitant or slow turns on the handler's part are also faulty.

**GROUP** - The handler and the dog walk through a moving group, consisting of at least four (4) people. In the group, the handler must heel the dog around two (2) people, once to the left and once to the right (i.e., a figure eight). The handler must come to a halt at least once near a person in the group to complete the exercise. The judge is entitled to ask the handler to repeat the exercise. The handler and the dog leave the group and assume the basic position. The lead is removed outside the group in the basic position after the on-lead portion. The dog may be praised in the basic position before the lead is removed and starting the off-lead heeling. The handler and dog should be facing the group during this procedure.

**ABOUT TURN (180 degrees)** - About turns are to be performed as left about turns (German turn), however, the dog may either circle around the handler, or back up in place (FCI international / military flip turn). In the flip turn, the dog must stay in heel position as the handler makes the turn. In any instance, the handler and dog must execute the same about turn throughout the obedience phase.

## **2. HEELING OFF LEASH (20 points)**

*Commands: "Fuss" / "Heel"*

On a signal from the judge, the leash is taken off while the dog is in the basic position. The handler either puts the leash over his / her shoulder or puts it in his / her pocket (snap always on the opposite side of the dog) and immediately enters the group again with the free heeling dog. The handler must heel the dog around at least two (2) people, once to the left and once to the right (i.e., a figure eight). Each time the handler walks through the group he / she has to halt at least once near a person. After handler and dog leave the group, the handler assumes the basic position and begins the free heeling exercise. The pattern is the same as described in "Heeling On Leash".

## **3. DOWN OUT OF MOTION WITH RECALL (15 points)**

*Commands: "Fuss" / "Heel", "Platz" / "Down" and "Hier" / "Come" OR dog's name, "Fuss" / "Heel"*

**DIVISION OF THE EXERCISES** - The down with recall is divided into two (2) parts: implementation and recall. Each is worth five (5) points.

From the basic position, the handler goes straight ahead at a normal pace and with his / her free heeling dog. At a minimum of ten (10) paces and not to exceed fifteen (15) paces, the command "platz" / "down" is given and the dog must lie down fast and straight without the handler interrupting his pace or looking backwards at the dog. After walking at least fifteen (15) further paces, the handler stops and immediately turns around to face the dog. On the judge's signal, he / she recalls the dog, either with the command "hier" / "come" or the dog's name.



The dog must come to the handler willingly, quickly, and directly and must sit close and straight in front of the handler. On the command "fuss" / "heel", the dog must rapidly go to the basic position. The handler is not permitted to change his / her position during this exercise.

If the dog remains standing or sits at the "platz" command, five (5) points will be deducted.

*Synopsis: Basic position, 10-15 normal paces, "down" command, minimum of thirty (30) normal paces, "come" command, after three (3) seconds, "heel" command, end at basic position.*

#### **4. RETRIEVE (10 points)**

a) One (1) verbal command to: "bring", "out" / "aus", "heel / fuss"

b) Execution: The dog is off leash in the basic position. The handler throws his own article approximately five (5) paces away. The command to "retrieve" / "bring" is first given after the article comes to rest. The calm and off-leash dog sitting next to his handler must go out quickly and directly to the article at the command "retrieve" / "bring", pick it up immediately and bring it back quickly and directly to the handler. The dog has to sit close and straight in front of the handler and hold the article calmly until after approximately three (3) seconds he is commanded to "aus" / "out". At the command "heel" / "fuss" the dog has to assume the basic position quickly and straight at the left of the handler with his shoulder at knee height. At the end of the exercise the dog is put on leash.

c) Evaluation: Faulty basic position, slow go-out, faulty pick up, slow return, dropping it playing or mouthing the article, splayed stance of the handler, not sitting correctly in front or at the end are evaluated accordingly.

d) Handler help while not moving out of position are also evaluated accordingly. If the handler moves out of place before the end of the

exercise, the exercise is rated as insufficient. If the dog does not bring the article, the exercise receives zero (0) points.

#### **5. JUMP OVER A HURDLE (80 cm, 31.5") (10 points)**

a) One (1) verbal command to: "jump", "here" / "jump back", "heel / fuss"

b) Execution: The handler with his dog stands a minimum of five (5) paces in front of the jump and takes his dog off leash. The calm and off-leash dog sits next to his handler and must jump over the hurdle at the "jump" command and at the "here" / "jump back" commands, he has to jump immediately over the hurdle and sit close and straight in front of his handler. At the command "heel" / "fuss" the dog must quickly return to his handler sitting straight to his left with the shoulder at knee height. ***The handler may move two (2) paces when giving the dog the command to "jump"***. At the end of the exercise the dog is put on leash.

c) Evaluation: Faulty basic position, hesitant jump, faulty sit in front and at the end, handler help is evaluated accordingly. If the dog tips the jump than up to one (1) point is deducted per jump. If he steps on the jump, then up to two (2) points can be deducted.

#### **6. DOWN UNDER DISTRACTION (15 points)**

a) One (1) verbal command to: "down" / "platz", "sit"

b) Evaluation: At the beginning of another dog's obedience for Phase B, the handler goes with his dog to a place as assigned by the judge and unleashes his dog while in the basic position. Then the handler downs his dog with the command "down" / "platz" and without leaving a leash or other article with the dog. The handler then leaves his dog without looking back approximately twenty (20) paces within the trial area and remains calmly standing with his back to the dog. The dog has to remain calmly lying down with any influence of the handler while the other dog performs exercise one (1) through three (3). At the instruction of the judge, the handler returns to his dog and stands to the right of his dog. At the instruction of the judge, the dog is to execute the "sit" command quickly and straight in the basic position. The dog is put on leash.

c) Evaluation: Restless behavior of the handler as well as other hidden handler help, restless lying down, or standing / sitting up prematurely are evaluated accordingly. If the dog stands or sits, but remains in place, partial points are awarded. If the dog leaves the area before the other dog has completed Exercise 3 and the dog goes more than three (3) meters from the designated spot, the exercise is evaluated with zero (0) points.

## **IPO-V Protection Phase "C"**

Exercise 1: Bark and Hold	15 points
Exercise 2: Prevention of helper escape	30 points
Exercise 3: Attack on the handler and his dog	50 points
Exercise 4: Transport to the judge	5 points
<b>Total:</b>	<b>100 points</b>

### **General requirements:**

There is no TSB Evaluation. The helper uses a soft stick as a threat to the dog without striking him. The command to "aus" / "out" is allowed only once for all defensive exercises. See the table below for the evaluation for the "aus" / "out".

<b>Slow "out"</b>	<b>First additional command with immediate "out"</b>	<b>First additional command with slow "out"</b>	<b>Second additional command with immediate "out"</b>	<b>Second additional command with slow "out"</b>	<b>No "out" after second command or other attempts</b>
0.5-3.0	3.0	3.5-6.0	6.0	6.5-9.0	Disqualification

### **1. Hold and Bark (15 points)**

a) One (1) verbal command to: "voran" / "search" / "revier"

b) Execution: The helper is located at an approximate distance of twenty (20) paces from the handler and his dog, whereby the dog cannot see him. At the instruction of the judge, the handler unleashes his dog and sends him with the command "voran" / "search" / "revier" and / or by raising his arm to the blind. The dog has to actively and attentively hold and continuously bark. The dog may neither jump on the helper nor grip him. At the instruction of the judge, the handler goes immediately to his dog and holds him by the collar.

c) Judgment: Limitations regarding the continuous and demanding bark and forceful hold are to be deducted accordingly. Bothering of the helper, for example bumping, jumping up on the helper, etc., leads to a deduction of up to three (3) points. Up to twelve (12) points may be deducted for heavy gripping. If the dog leaves the helper a partial score is given reflecting an "insufficient" rating. If the dog does not want to cooperate, Phase "C" is to be terminated.

## **2. Prevention of an attempted helper's escape (30 points)**

a) One (1) verbal command to: "out" / "aus "

b) Execution: While the handler holds his dog by the collar, the helper steps out of the blind and attempts to escape. At the instruction of the judge, the handler releases his dog. The dog has to independently prevent the escape by means of an energetic and strong grip. He may only grip the protection sleeve of the helper. At the instruction of the judge, the helper stands still. After the helper stops, the dog must release immediately. The handler may give a command "aus" / "out" within a reasonable amount of time.

If the dog does not out on the first permitted command, the handler then will receive instructions from the judge for two (2) additional commands to "aus" / "out". If the dog does not out after the third command (one (1) permitted and two (2) additional), the result is disqualification. During the "aus" / "out" command the handler has to remain standing still without influencing the dog. After the "out" the dog must remain close to the helper

and watch him attentively. The handler goes immediately to the dog at the instruction of the judge and holds him on his collar.

c) Evaluation: Restrictions in the important evaluation criteria are rated accordingly: Quick, energetic reaction and pursuit with a strong grip and effective prevention of the escape and forceful, full, hard and steady grip until the release attentively and closely guarding the helper. If the dog does not prevent the escape within twenty (20) paces by gripping and holding, then Phase "C" is terminated.

### **3. Attack on the handler and his dog (50 points)**

a) One (1) verbal command to: "*Defend*", "*Out*" / "*Aus*", "*Heel*" / "*Fuss* "

b) Execution: The dog is held by the collar may however not be stimulated by the handler. At the instruction of the judge, the helper goes in a normal pace away from the handler. After approximately twenty (20) paces, the helper turns and attacks the handler and his dog from the front all the while yelling loudly and making definitive strong threats. The handler releases his dog with the command "defend". The dog has to defend the attack without hesitation and with a strong grip. He may only grip the protection sleeve of the helper. The handler must remain in place. At the instruction of the judge, the helper stands still. After the helper stops, the dog is to release immediately. The handler may give a command to "aus" / "out" within a reasonable amount of time.

If the dog does not out on the first permitted command, the handler then will receive instructions from the judge for two (2) additional commands to "aus" / "out". If the dog does not out after the third command (one (1) permitted and two (2) additional), the result is disqualification. During the "aus" / "out" command the handler has to remain standing still without influencing the dog. After the "out" the dog must remain close to the helper and watch him attentively. The handler goes immediately to the dog at the instruction of the judge at a normal pace and in the most direct manner and places the dog in the basic position by commanding "heel" / "fuss". The handler puts his dog on leash.

c) Evaluation: Restrictions in the most important evaluation criteria are rated: Energetic defense with a full, forceful, hard and steady grip until the release, after the release attentively and closely guarding the helper.

If the dog leaves the helper during the guarding phase or the handler gives him a command so that the dog stays with the helper, the exercise is rated as insufficient.

#### **4. Transport to the judge (5 points)**

a) One (1) verbal command to: "*heel*" / "*fuss*"

b) Execution: A side transport of the helper is conducted to the judge over an approximate distance of ten (10) paces. The command "*fuss*" / "*heel*" is permitted. The dog is to be at the right side of the helper, so that the dog is between the helper and the handler. For the duration of the transport, the dog has to attentively watch the helper. He may not crowd the helper, jump up, or grip. The group halts in front of the judge and reports out with Phase "C" ended.

c) Evaluation: Restrictions in the most important evaluation criteria leads to deduction.

## Article Indication Trial 1 – 3 (StP 1, 2, 3)

### Test levels for the Article Indication Test

The requirements are set at different levels and reflect the individual testing levels.

Level	Indication Area	Articles	Points	Execution Time
1	20 x 30 m	2 Handler Articles Size: 10 x 3 x 1 cm Material = same type permitted 1 article left, 1 article right	10 / 10	10 minutes
2	20 x 40 m	4 Stranger Articles Size: 10 x 3 x 1 cm Material = different 2 articles left, 2 articles right	5 / 5 / 5 / 5	12 minutes
3	30 x 50 m	5 Stranger Articles Size: 5 x 3 x 1 cm Material = different Placed at discretion	4 / 4 / 4 / 4 / 4	15 minutes

### General requirements

In order to take this test, the dog has to be a minimum of fifteen (15) months old and have earned their BH.

The handler reports in with his name and his dog's name in a sportsmanlike manner and advises the judge which level of the test he / she is undertaking. Thereafter, he / she goes with his / her dog on leash to the designated start position and assumes the basic position.

The dog is taken off leash for the indication work. The handler is to keep the leash with him / her.

Any force or punishment is to be avoided.  
Slightly going out of the boundaries is not faulty.

Spectators are to be a reasonable distance away from the indication field.

### **Type of area for the Indication Work**

Terrain: all natural ground (grass, plowed field, wooded area). Tree stock is also permitted. (Avoid any opportunity for visual indication, so avoid short grass or other similar areas.) This should not be done on a trial obedience field.

Prior to laying out the articles, the indication area should be crossed by people several times, so that no one track is indicated.

Markings may be placed around the indication area.

### **Articles**

Material: Wood, leather, artificial leather, textile

Placed articles may not differentiate themselves in color to the terrain and should not be visible.

Handler and dog must remain out of sight while the articles are placed.

There is no waiting time to begin. The dog may begin to search immediately after the articles are placed.

### **Deploying the dog to locate**

The imaginary centerline and the bordering sides of the indication area will be made known to the handler by the judge.

At the beginning a short conditioning of the dog to start working at the imaginary centerline of the indication area is permitted.

The handler moves within the imaginary centerline. He may only leave this to retrieve the article. Thereafter the dog is restarted from the middle line to locate the remaining article(s). Both verbal and visual commands are



permitted. The command "lost" may be supported with the "search" command.

Locating the article(s) with a "high nose" is not faulty.

The indication area may be repeatedly searched.

### **Behavior at the articles**

Articles must be convincingly indicated and may not be touched by the dog. The articles may be indicated by sitting, standing, lying down, or in varying styles. A command to indicate is not permitted and leads to the article not being evaluated.

No commands are permitted to assist the dog in indicating the articles. If the dog has indicated an article, the handler goes to his dog and shows the judge the article by raising it up, then he returns to the middle line and restarts his dog to continue the article indication work.

The lying down position for the articles is not stipulated. The located article must however be in the immediate area of the dog's front paws.

The handler always approaches his dog from the side and may not stand in front of the dog. Praising the dog after the article is shown is permitted.

After the dog has located the last article, he is placed on leash. Thereafter, the handler shows the article and reports out to the judge.

### **Evaluation**

The highest points for each of the article indication tests (StP 1, 2, 3) is 100 points for each.

At least seventy (70) points must be achieved.

The evaluation criteria for all three (3) levels:

- a) Obedience 20 points (following the verbal / visual commands of the handler)

- b) Intensity of searching (willing to intensively pick up the scent) 20 points
- c) Endurance (maintaining the search drive to locate the articles) 20 points
- d) Behavior of the handler (influence on the dog) 20 points
- e) Article indication (convincing indication) 20 points

Highest points	Excellent	Very Good	Good	Satisfactory	Insufficient
100 points	96 – 100	90 – 95	80 – 89	70 – 79	0 - 69

**Execution requirements**

The exercise begins with the basic position at the border of the indication area and ends with the reporting out to the judge. Articles located by the dog must be presented.

Positive Criteria:

Even, calm, and smooth work. Quickly dispatching from the handler. Immediate reaction to the commands. Enduring and goal-oriented work on the part of the dog. Broad side sweeps by the dog.

Faulty:

Picking up the articles by the dog, those that require strong intervention by the handler to indicate are not evaluated.

Touching the articles 1 – 3 point deduction

Premature getting up, additional command 1 – 3 point deduction

Leaving the center line on the part of the handler 2 – 5 point deduction

Catching mice, emptying, etc. 4 – 8 point deduction



Lackluster work on the part of the dog 4 – 8 point deduction

***Going over the allowed time allotment results in termination of the work.***

***Points awarded up to that time are granted.***

**Further additional negative evaluation criteria: restless behavior when indicating, barking, non-permitted handler help, going away over the boundaries of the indication area.**

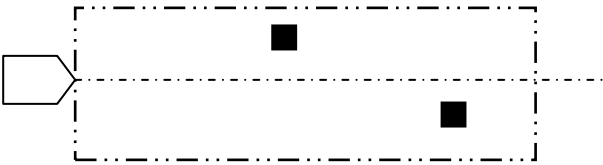
**Layout of the indication fields Level 1 - 3**

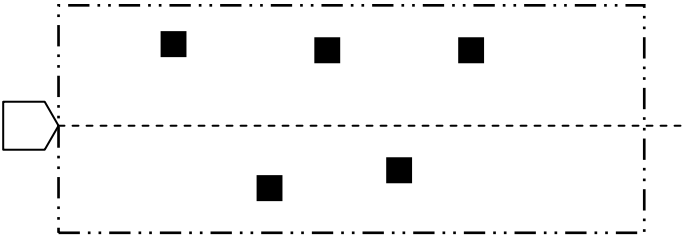
	<p><b>Level 1</b> Indication area 20 x 30 m</p>
	<p><b>Level 2</b> Indication area 20 x 40 m</p>
	<p><b>Level 3</b> Indication area 30 x 50 m</p>

## **American Working Dog Titles**

### **AWD 1, 2, 3**

The United Schutzhund Clubs of America also offers the AWD 1, 2, 3 working dog titles. These titles were written and developed in cooperation with the AWDF, to ensure that there would be an accepted level of working dog title available in the United States of America regardless of what changes were made to the working dog titles throughout the rest of the world.

At this time these titles are only available and recognized by AWDF Member Clubs.

Copies of the 120 page AWD Rulebook are available through down load directly from the USCA Web Site at [www.germanshepherddog.com](http://www.germanshepherddog.com) or from the AWDF website at [www.awdf.org](http://www.awdf.org)

All USCA Licensed Judges are authorized to award these titles.

Authorization to include these titles must be received through the host club's Regional Director.

## **RH Titles (Suitability for search dog)**

**The United Schutzhund Clubs of America are full members of the IRO and the WUSV and offer RH titles based on these organizations standards.**

All USCA Licensed Judges are authorized to the Entry Level RH Title. Advanced RH titles must be awarded by Judges that have been approved for specific levels.

For information on the IRO or SV RH titles and programs got to the IRO website at [www.iro-dogs.org](http://www.iro-dogs.org) award these titles.

## APPENDIX A - DIAGRAMS

### IPO 1, 2 / FPr 1, 2 TRACKING

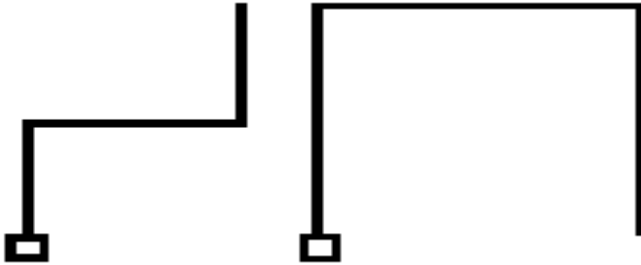

### IPO 3 / FPr 3 TRACKING

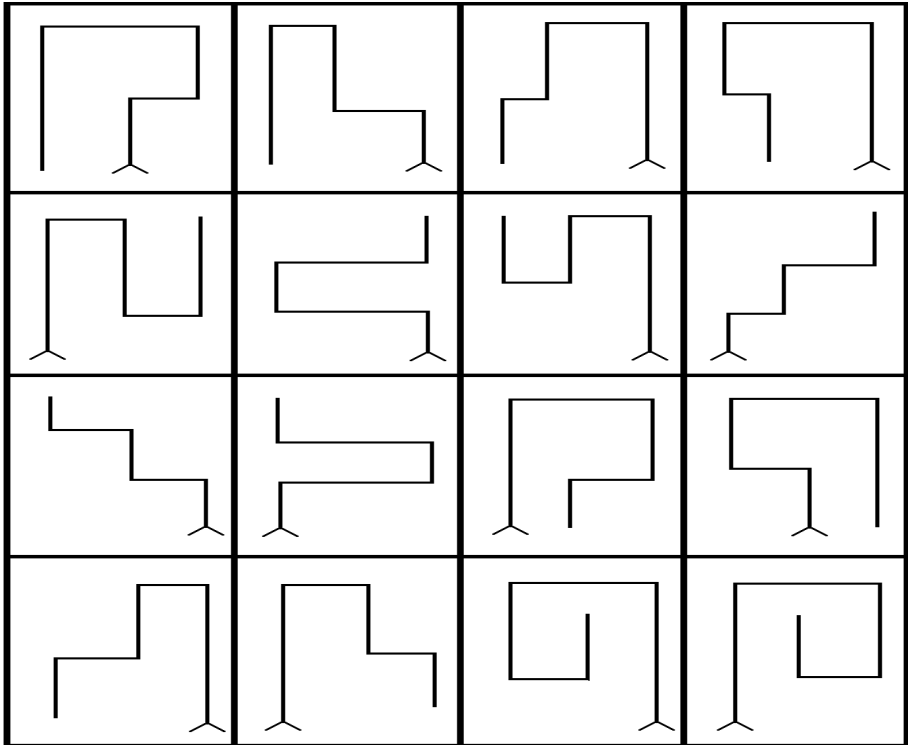

FH1 Tracking Patterns

# FH 1 Patterns

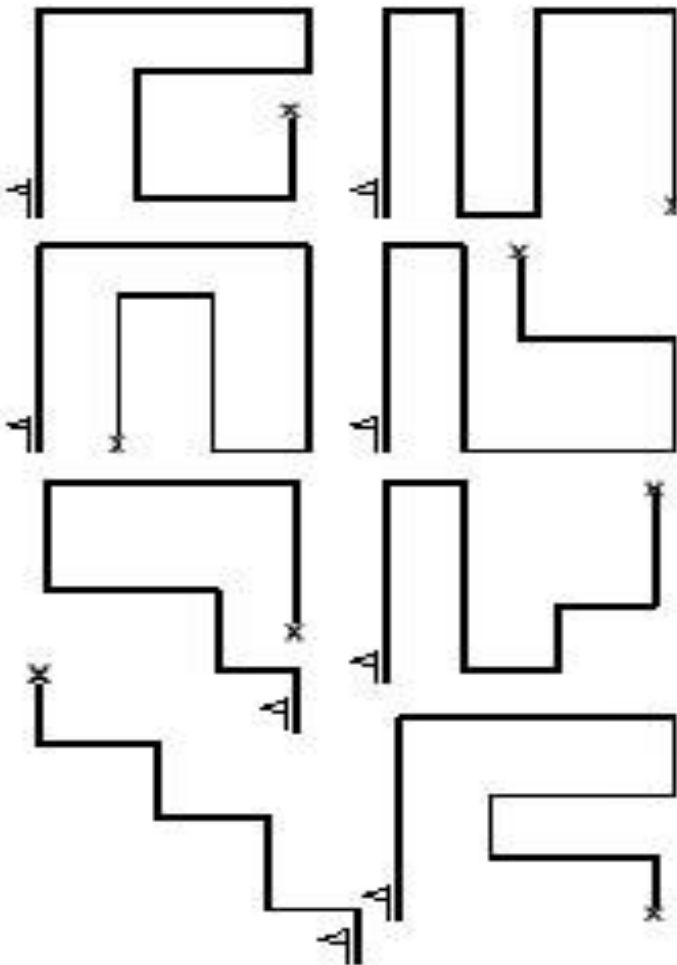

## FH 2 Tracking patterns

# FH 2 Patterns

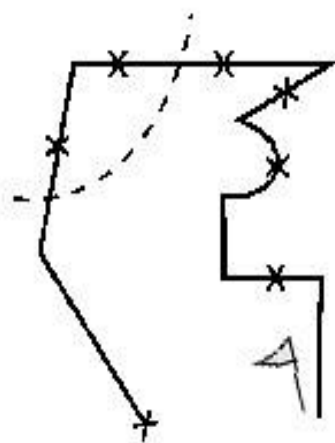
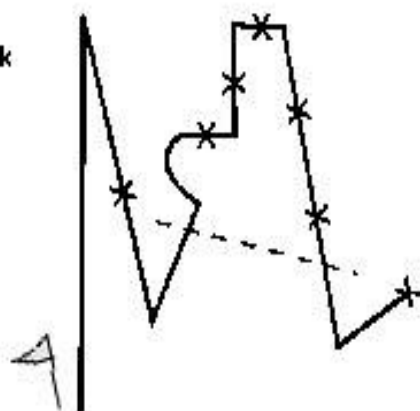
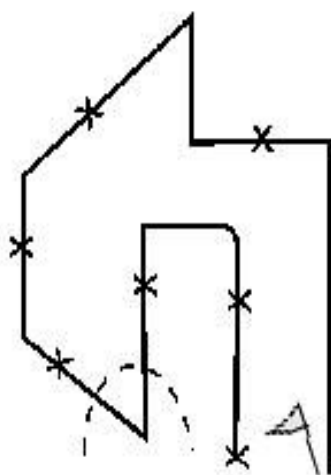

# ON / OFF LEASH HEELING

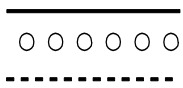

**B** Basic Position  
**L** Left Turn  
**R** Right Turn  
**T** About Turn  
**H** Halt

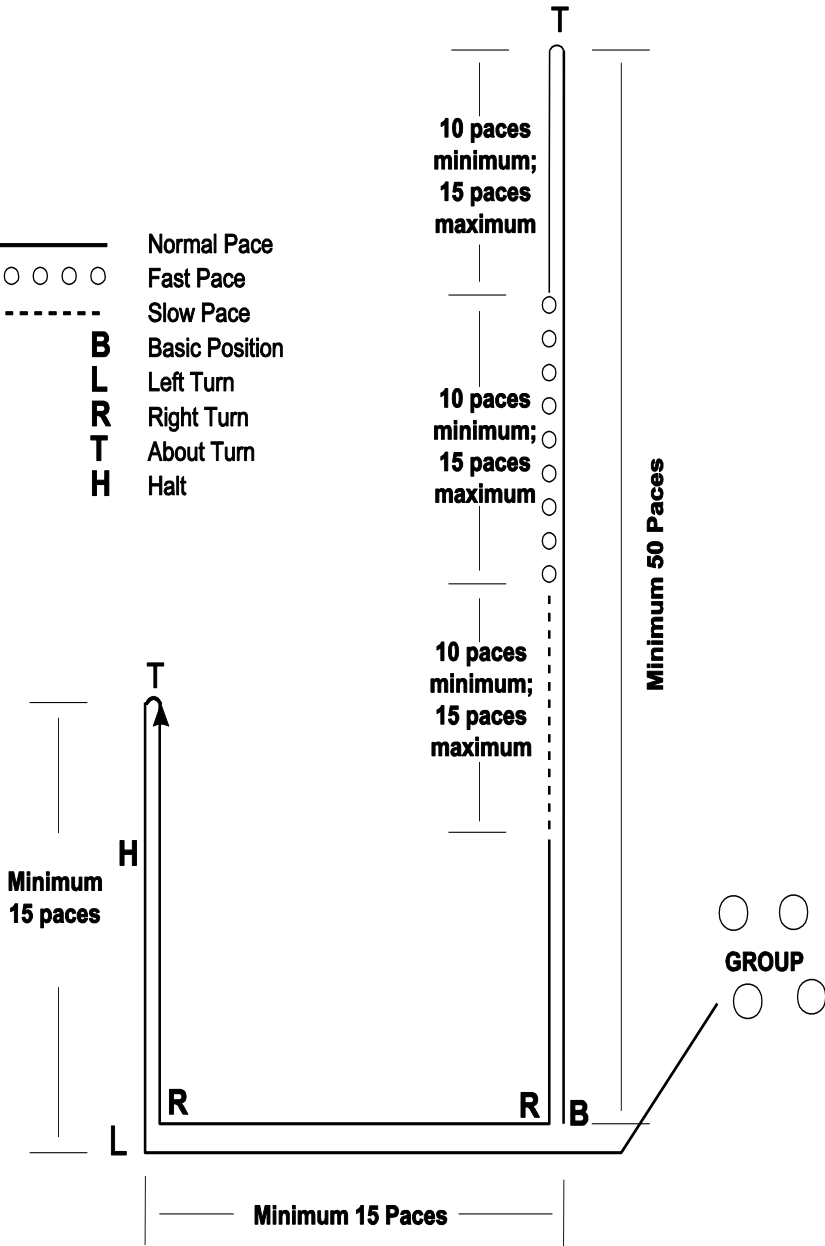



**Additional Obedience Notes:**

The direction for the toss in the "Retrieve on the Flat" must be in the same direction as the "Send Away". The "Retrieve Over the One-meter Jump" and the "Retrieve over the Wall" toss should be done in the same direction, if the jump and the wall are set up side by side.

The "Send Away" is also performed in the same direction as the first leg of the heeling pattern.

IPO 3 must have a blind set up for the "Long Down" exercise.

## Out of Motion Exercises

BH / IPO 1 / APr 1 / UPr 1 Sit, Down with Recall  
IPO 2 / APr 2 / UPr 2 Sit, Down with Recall, Walking Stand  
IPO 3 / APr 3 / UPr 3 Sit, Walking / Running Down with Recall, Running Stand  
with Recall

Sit out of Motion BH / IPO 1-2-3 / APr 1-2-3 / UPr 1-2-3

Walking Stand out of Motion IPO 2 / APr 2 / UPr 2

(IPO / APr / UPr the exercise is executed without a change of pace (stride) by the handler. For BH the Sit may be executed with the handler stopping for 3 seconds and command sit or may be executed without breaking stride as described above for IPO)

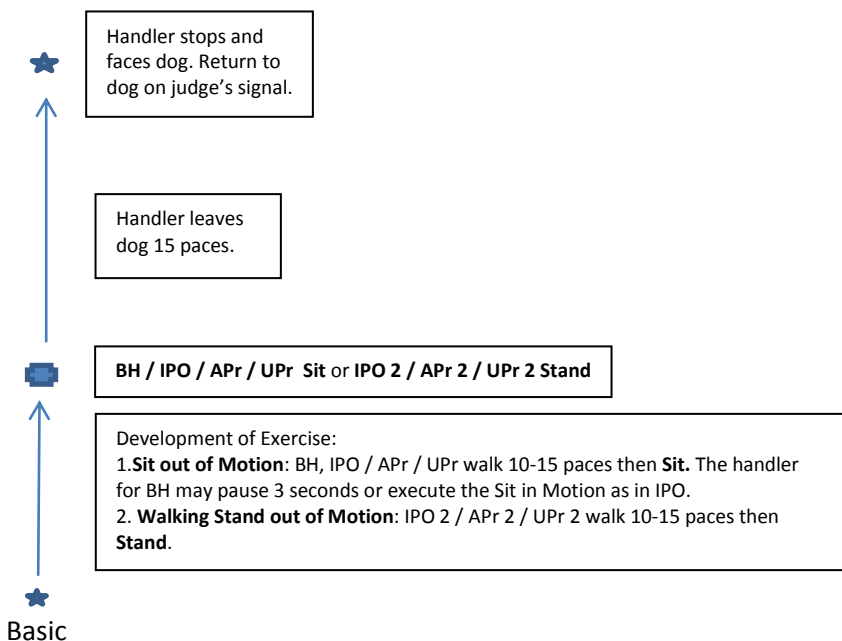

Down out of Motion with Recall BH / IPO 1-2 / APr 1-2 / UPr 1-2

Walking / Running Down out of Motion IPO 3 / APr 3 / UPr 3



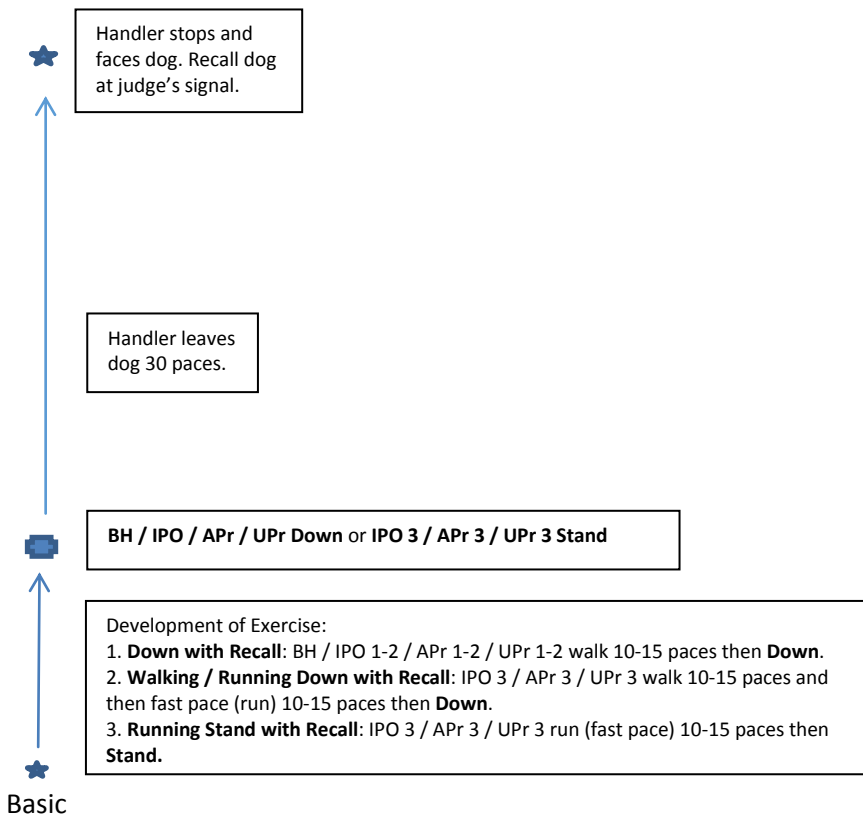

## Running Stand with Recall IPO 3 / APr 3 / UPr 3

(IPO / APr / UPr the exercise is executed without a change of pace (stride) by the handler. For the BH the Down may be executed with the handler stopping for 3 seconds and then command down or may be executed without breaking stride as described above for IPO)

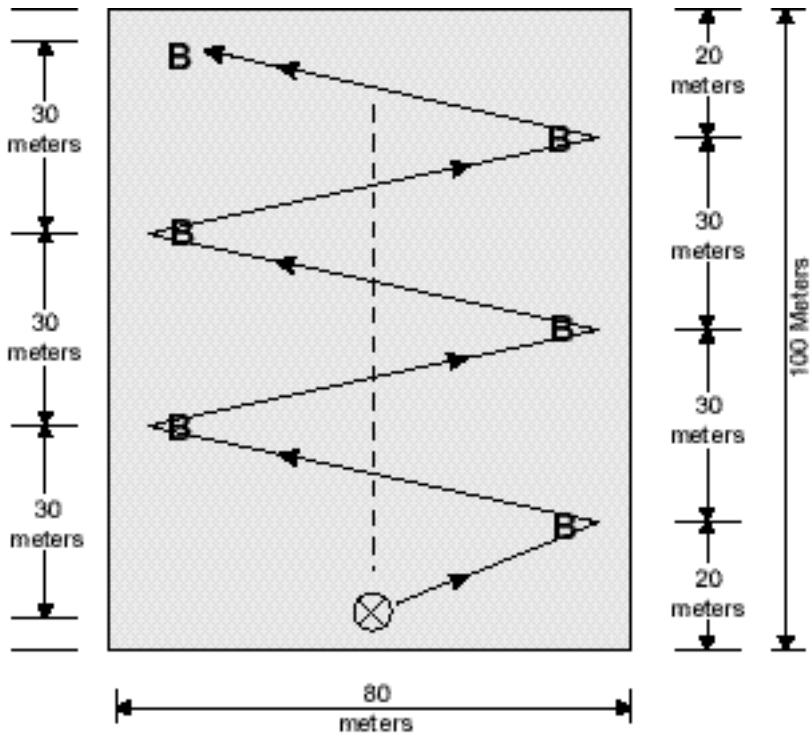

## PROTECTION DIAGRAM AND FIELD LAYOUT



-  Start
-  Blind
-  Path of Dog
-  Center Line

IPO 3 Protection Search – handler starts at point marked X, with the dog in basic position facing down field (centerline) and signals the judge. At the recognition of the judge to start the search, the handler / dog team turn toward the number one (1) blind remaining on the centerline and again assume the basic position (dog sitting calmly). The handler may then at their decision start the search by sending the dog with the search command. (e.g., revier, search, voran, etc.) When the dog has searched the blind, the handler may use the dog's name and "hier" (come, etc.) to call the dog back towards the handler and then repeat the search command for the next blind. The handler must remain moving down the centerline of the field as the dog searches the blinds. The dog must cross in front of the handler at all times, and the handler must walk at a steady consistent pace to properly complete the search. At no time may the dog return to the handler and stop the search by coming to basic or front position. Once the dog has entered the find / live blind (#6 with the helper) regardless of the handlers' location on the field he / she must stop moving on the centerline of the field until called in by the judge to pick up the dog.

**Additional Protection Field Notes:**

During the protection routine the field should be clear of all equipment except blinds. All six (6) blinds must be set up regardless of the level of IPO being evaluated. Correct blind set up requires the blinds be staggered in an approximate field length to width ratio of 100% long to 80% wide. (i.e., a field that is 300' long from blind 1 to blind 6 should be 240' wide between blind 1 and blind 2; making a 100 x 80 ratio.) This allows the proper stagger and width to length ratio for a correct search, and the handlers can maintain a normal walking pace in relation to the dog's speed during the search.

### IPO 1 Protection layout

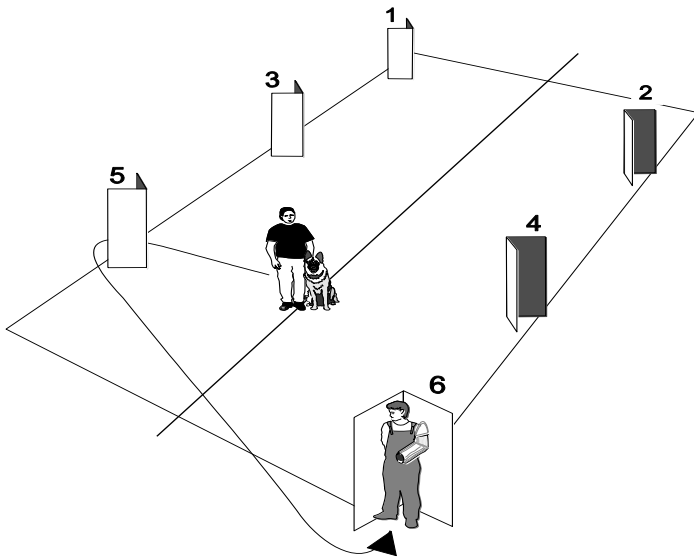

### IPO 2 Protection Layout

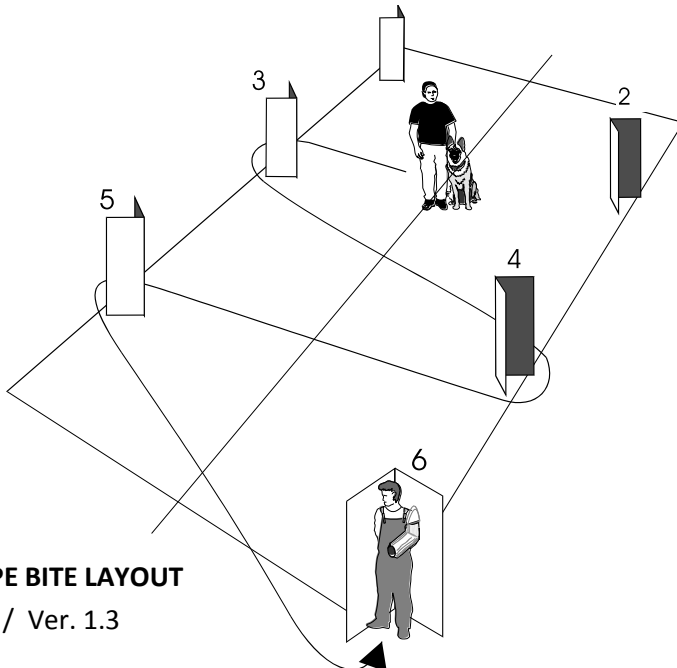

### ESCAPE BITE LAYOUT

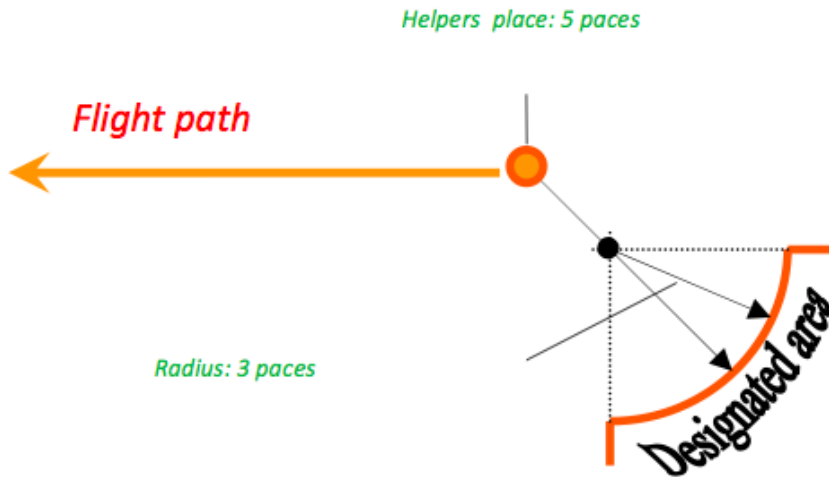

Additional Notes: The exercise begins at the basic position after the call out from the "Hold and Bark". The dog should show obedience to the handler in its free heeling from the basic position to the designated position for the escape (curved line, approximately 5 paces from the call out position and 5 paces from the helper), present a basic position at the designated position (line) and then receive the command "down / platz" that positions the dog behind the designated line. The dog may be placed anywhere behind the designated area for the down. The handler will then leave the dog in the "down / platz" position with the dog watching the helper, and the handler will return to the blind. The handler may watch the dog and helper from the blind. (i.e., stand partway in to the blind to be able to see the dog and helper.) The dog should remain calm and watchful / attentive to the helper. On the judge's signal the helper will make an attempted escape, immediately as the helper moves the handler must give a "go" command to the dog to "release" it from the down position. The dog should with power and confidence grip and attempt to control / stop the helper from escaping. In the escape if the dog is completely over the line when downed, the handler will be asked to call the dog back to basic position behind the line

and downed correctly. If the dog in the down (platz) is not behind the escape line, but has contact with line the dog is allowed to continue, but the rating will be lowered one (1) category even if the remaining part of the escape is performed correctly. If the dog leaves (breaks) the escape position on its own and only guards the helper (no grip), the handler may on instruction from the judge go to the down position and call the dog back to reposition it behind the designated line and into the down (platz) position, but will receive a point deduction of insufficient. Only one attempt is allowed to call the dog back to the down position. If it does not respond the protection is "DQ - out of control". If the dogs leaves (breaks) the position on its own and grips anything (e.g., sleeve, helper, etc.) the dog will be disqualified.

## **Quick Reference Sheet for the most common but not all actions resulting in a Disqualification (DQ) or Termination ( Term)**

### **Tracking:**

If the dog stops working the track, the handler has up to three (3) commands to get the dog to continue to work - Term

Restarts the dog during the track (except 1 time allowed in FH) - **TERM**

If the handler holds / grabs the dog by the collar or body - **DQ**

Training Devices at the tracking field - **DQ**

Motivational objects or food on the tracking field (except in the designated parking area) – **DQ**

Stops working the track or does not complete the track in the allowed time - **Term**



## **Obedience:**

If the dog leaves the handler and will not return with 3 commands or less - **DQ**

If the dog leaves the trial field “as determined by the judge” - **DQ**

If the dog does not release the dumbbell after three (3) commands. - **DQ**

If the dog is given a “platz / down” command or incorrect command to regain control of the dog. - **DQ**

If the handler holds / grabs the dog by the collar or body - **DQ**

If the dog cannot physically complete an exercise or is unfit/unhealthy - **Term**

## **Protection:**

If the dog leaves the protection field at any time – **DQ**

If the handler calls the dog to him and this stops his forward movement or dog goes to basic position during the blind search - **Term**

If the dog is given a command in order to make the dog stay by the helper - **DQ**

If dog does not release with a maximum of three (3) out commands - **DQ**

If the dog grips any other part of the helper's body other than the protective sleeve – **DQ**

If the handler holds / grabs the dog by the collar or body (except in the Attack on Dog out of Motion” in the watch position (may hold the collar) - **DQ**

If the dog requires more than the allowed number of commands to complete the exercise (i.e., more than two (2) additional commands in total to complete the blind search, the transports, call out, Outs etc - **Term**

If handler uses the "platz / down" command at any time (other than Escape setup) - **DQ**

If the handler cannot report in or out (transport) to the judge with his / her dog properly in position with 3 or less commands - **DQ**

If the dog makes no attempt / effort to be directed to the first blind - **DQ**

After being sent unsuccessfully a total of three (3) times to the helper, in the live blind - **Terminated**

If the dog leaves the helper, the handler is allowed only one (1) additional command to resend the dog into the blind. If the dog leaves on his own a second time - **Terminated**

If the dog is gripping the sleeve when the handler is at the call out spot, they may only use the "hier-fuss" command one (1) time to make the dog release and come to heel - **DQ**

If the dog does not come to basic position after three (3) commands for the call out or in IPO1 if the dog cannot be heeled out of the blind with 3 or less commands - **DQ**

If the dog leaves (breaks) the escape position on its own and only guards the helper (no grip), the handler may call the dog back to reposition it, one time (1) - **DQ**

If the dog leaves (breaks) the escape position on its own and grips anything (e.g., sleeve, helper, etc.) - **DQ**

If the dog fails to catch and engage the helper before the helper has reached the twenty (20) pace distance, or fail to remain on the sleeve in the "Attempted Escape of the Helper" or if the dog fails to engage the Helper in any Defense exercise - **Terminated**

During guarding If the dog leaves the helper by more than 3 meters and/or is not actively guarding the helper – **Term**

If the handler gives a command so that the dog stays with the helper - **DQ**

If the dog regrips the sleeve as the handler approaches, and the handler is within three (3) meters he / she must continue walking to basic position and tell the dog to "sit". If the dog does not release after the one (1) "sit" command the team will be disqualified. If the handler uses "out" at the basic position the protection work will be **terminated**.

An exercise will be stopped and the team will be disqualified if the dog receives the helping command "platz" / "down" in order to make the dog release the grip. The handler is, at no time, allowed to reinforce the dog with a "platz" / "down" command if the dog outs and downs after the out. **DQ**

If dogs breaks free (or sent) on "Attack on Dog Out of Motion" before the helper has made the turn up field - **DQ**

If the dog makes **ANY** contact with the judge during the protection Work - **DQ**