

# U.S. Chart No. 1

## Symbols, Abbreviations and Terms used on Paper and Electronic Navigational Charts



13<sup>th</sup> Edition

April 15, 2019

Prepared Jointly by

Department of Commerce  
National Oceanic and Atmospheric Administration

Department of Defense  
National Geospatial-Intelligence Agency



## ECDIS Symbols and Other ECDIS Information

Symbology for displaying Electronic Navigational Charts (ENCs) on Electronic Chart Display and Information Systems (ECDIS) has been added to U.S. Chart No. 1. In addition to the ECDIS symbols shown in the traditional lettered sections of U.S. Chart No. 1, there are now several special pages devoted exclusively to providing important details about ECDIS. These pages are distinguished by the ECDIS icon, as shown in the top left corner of this page. The ECDIS pages are also listed in the table of contents in italic type.



One major difference in the use of paper charts and ENCs is the ability of ECDIS to display the same feature differently depending on user settings and other conditions, such as a ship's draft. An important example is that ECDIS displays wrecks, rocks and other obstructions with their traditional "paper chart" symbols if they are at or deeper than the depth of the safety contour set for the ship. Dangers that are shoaler are portrayed with the unique ECDIS "isolated danger" symbol shown at left. (See the ECDIS Portrayal of Depths page for more information about the ECDIS safety contour.)



Another advantage that ECDIS provides over paper charts is enabling users to obtain more information about a feature through a "cursor pick." Some feature attribute values that can be obtained by cursor pick are noted throughout U.S. Chart No. 1. This is especially true if a particular value, such as height, vertical clearance or the like is included in the INT symbol description. The cursor pick icon, shown at left, is used to indicate when a reference to a cursor pick is made.

There are many other attribute values that users may obtain through a cursor pick that are not specifically noted. These include, but are not limited to, the purpose, seasonality, periodicity, status, color, height, type of structure and the visual or radar conspicuousness of features; shape, color or color pattern of buoys; characteristics of lights; category of obstructions and wrecks; radar wave length, radio frequency, communication channel and call signs; the presence of AIS transmitted signals; information regarding pilotage services and many more.

U.S. Chart No. 1 is a handy guide for ECDIS users, but it is no substitute for mandated ECDIS training.

The ECDIS user and developer communities are invited to help improve the presentation of ECDIS symbology and information in U.S. Chart No. 1. Please let us know what additional information you would like to see in the next edition.

Corrections, comments, or questions regarding U.S. Chart No. 1 may be submitted through ASSIST, the NOAA Coast Survey stakeholder engagement and feedback website at [www.nauticalcharts.noaa.gov/customerservice/assist](http://www.nauticalcharts.noaa.gov/customerservice/assist),

or mailed to:

National Ocean Service, NOAA (N/CS2)  
Attention: U.S. Chart No. 1  
1315 East West Highway  
Silver Spring, MD 20912-3282



# SYMBOLS, ABBREVIATIONS AND TERMS

## Contents

### Document Sections and ECDIS Pages

Preface	4
Introduction	4
Schematic Layout	7
<i>Day, Dusk and Night Color Palettes</i>	8
<i>Conspicuous and Non-Conspicuous Features</i>	27
<i>ECDIS Portrayal of Depths</i>	46
<i>Examples of Routing Measures in ECDIS</i>	68
<i>Simplified and Traditional "Paper Chart" Symbols</i>	89
Index of Abbreviations	110
Index	116
Appendix 1, IALA Maritime Buoyage System	127

### Symbol Sections

#### GENERAL

- A Chart Number, Title, Marginal Notes
- B Positions, Distances, Directions, Compass

#### TOPOGRAPHY

- C Natural Features
- D Cultural Features
- E Landmarks
- F Ports
- G (Not currently used)

#### HYDROGRAPHY

- H Tides, Currents
- I Depths
- J Nature of the Seabed
- K Rocks, Wrecks, Obstructions, Aquaculture
- L Offshore Installations
- M Tracks, Routes
- N Areas, Limits
- O (Not currently used)

#### NAVIGATION AIDS AND SERVICES

- P Lights
- Q Buoys, Beacons
- R Fog Signals
- S Radar, Radio, Satellite Navigation Systems
- T Services
- U Small Craft (Leisure) Facilities

## INTRODUCTION

### Two Symbology Types Comprising Four Symbology Sets

U.S. Chart No. 1 presents two types of symbology used for marine navigation – the symbols used on paper nautical charts (and their digital raster image equivalents) and the corresponding symbols used to portray Electronic Navigational Chart (ENC) data on Electronic Chart Display and Information Systems (ECDIS).

Within these two types, four separate symbology sets are shown. These are described below:

#### *Paper Chart Symbols*

INT — The international or “INT” symbols specified in the *Regulations for International (INT) Charts and Chart Specifications of the IHO* (International Hydrographic Organization). These symbols are used by many countries around the world, including the United States.

NOAA — Symbols used on charts produced by the National Oceanic and Atmospheric Administration (NOAA) when an INT symbol is not used. NOAA produces nautical charts for all U.S. waters, including the Great Lakes and U.S. Territories.

NGA — Symbols used on charts produced by the National Geospatial-Intelligence Agency (NGA) when an INT symbol is not used. NGA produces nautical charts for the U.S. military and for areas outside of U.S. waters.

#### *ECDIS Symbols*

ECDIS — Symbols used to portray ENCs on ECDIS navigation systems. Use of ECDIS is required for large commercial ships on international voyages. These symbols are specified in *IHO Specifications for Chart Content and Display Aspects of ECDIS*.

### Other Non-ECDIS Digital Displays May Portray Data Differently

Navigation systems certified to meet the exacting performance standards established by the International Maritime Organization (IMO) are said to be ECDIS “type approved.” The symbology used to display ENCs or other non-ENC navigational data on non-ECDIS systems, such as geographic information systems, recreational GPS and other chart display systems can differ significantly from the symbology specified for ECDIS type approved systems. U.S. Chart No. 1 only shows the symbology used on ECDIS.

### U.S. Chart No. 1 and Typical Chart Layouts

A brief description of the columns on each symbol description page is provided here. A detailed schematic layout of U.S. Chart No. 1 is on page 8. Section A, on pages 10 and 11 presents schematics showing typical layouts of the major elements of NOAA and NGA charts.

Col 1 — Symbol number. The number together with the section letter which appears at the top of each page constitutes a unique identifier for each symbol, such as C1 for the “Coastline, surveyed” symbol.

Col 2 — INT symbol example.

Col 3 — Description of the feature or real world phenomenon being portrayed.

Col 4 — NOAA symbol example. This column will be blank if NOAA uses the INT symbol shown in column 2.

Col 5 — NGA symbol example. This column will be blank if NGA uses the INT symbol shown in column 2.

If columns 4 and 5 are combined, then NOAA and NGA both use the same symbol, which is different from the INT symbol.

Col 6 — Other NGA symbol examples. NGA produces facsimiles of some foreign charts. If the depiction on the chart is different than the INT or NGA symbols (shown in Cols 2 and 5, respectively) then the additional foreign symbols are shown here.

Col 7 — ECDIS symbol example in the day color palettes. (See page 9 for a description of ECDIS color palettes.)

Col 8 — The ECDIS description usually provides the generic symbol name given in the *IHO Specifications for Chart Content and Display Aspects of ECDIS*, although sometimes other clarifying terms are also provided.

The schematic layout on page 7 shows a typical symbol table page and provides more details about the table headers and the types of information presented in each of the columns.

## INFORMATION ON SELECTED CHART FEATURES

### Soundings

The sounding datum reference is stated in the chart title. Soundings on NOAA and NGA charts may be shown in fathoms, feet, fathoms and feet, fathoms and fractions, or meters and decimeters. In all cases the unit of depth used is shown in the chart title and outside the border of the chart in bold type (see item b in Section A). For ECDIS, the sounding datum is part of the ENC metadata, which can be retrieved through a cursor inquiry.

### Heights

Heights of lights, landmarks, structures, etc. refer to the shoreline plane of reference. The unit of height is shown in the chart title. When the elevations of islets or bare rocks are offset into the adjacent water, they are shown in parentheses. For ECDIS, the unit of height is meters.

### Drying Heights

For rocks and banks that cover and uncover, elevations are underlined and are referenced to the sounding datum as stated in the chart title (or in the ENC metadata). When the heights of rocks that cover and uncover are offset into the adjacent water, they are shown in parentheses.

### Shoreline

Shoreline shown on charts represents the line of contact between the land and a selected water elevation. In areas affected by tidal fluctuation, this line of contact is usually the mean high water line. In confined coastal waters of diminished tidal influence, a mean water level may be used. The shoreline of interior waters (rivers, lakes) is usually a line representing a specified elevation above a selected datum. Shoreline is symbolized by a heavy line (symbol C 1). Apparent shoreline is used on charts to show the outer edge of marine vegetation where the limit would be expected to appear as the shoreline to the mariner or where it prevents the shoreline from being clearly defined. Apparent shoreline is symbolized by a light line (symbols C 32, C 33, C p, C q and C r).

### Landmarks

A structure or a conspicuous feature on a structure may be shown by a landmark symbol with a descriptive label (see Section E). Prominent buildings that could assist the mariner may be shown by actual shape as viewed from above (see Sections D and E).

On NGA charts, landmark legends shown in capital letters indicate that a landmark is conspicuous; the landmark may also be labeled "CONSPICUOUS" or "CONSPIC." On NOAA charts, all landmarks are considered to be conspicuous, and landmark legends shown in all capital letters indicate a landmark has been positioned accurately; legends using both upper and lower case letters indicate an approximate position.

ECDIS portrays conspicuous features with black symbols and non-conspicuous features with brown symbols. Only the conspicuous version is shown in the lettered sections of U.S. Chart No. 1. See the ECDIS "Conspicuous and Non-Conspicuous Features" page in front of Section E for more information.

## IALA Buoyage System

The International Association of Marine Aids to Navigation and Lighthouse Authorities (IALA) Maritime Buoyage System is followed by most of the world's maritime nations; however, systems used in some foreign waters may be different. IALA buoyage is divided into two regions: Region A and Region B. All navigable waters of the United States follow IALA Region B rules, except U.S. possessions west of the International Date Line and south of 10° north latitude, which follow IALA Region A rules.

The major difference between the two buoyage regions is the color of the lateral marks. Region A uses red to port and Region B uses red to starboard (red-right-returning). The shapes of the lateral marks are the same in both regions, can to port and cone (nun) to starboard, when entering from seaward. Cardinal and other marks, such as those for isolated dangers, safe water and special marks are also the same in both regions. Section Q and Appendix 1 illustrate the IALA buoyage system for both Regions A and B.

### U.S. Lateral Marks

Most of U.S. waters are in IALA Region B. In the U.S. system, on entering a channel from seaward, buoys and beacon dayboards on the starboard side are red with even numbers and have red lights, if lit. Buoys and beacon dayboards on the port side are green with odd numbers and have green lights, if lit. Preferred channel buoys have red and green horizontal bands with the top band color indicating the preferred side of passage.

### Light Range (Visibility)

A light's range or visibility is given in nautical miles, except on the Great Lakes and adjacent waterways, where light ranges are given in statute miles. For lights having more than one color, NOAA charts give only the shortest range of all the colors. On NGA charts, multiple ranges may be shown using the following convention. For lights with two colors, the first number indicates the range of the first color and the second number indicates the range of the second color. For example, FI WG 12/8M means the range of the white light is 12 nautical miles and the range of green light is 8 nautical miles. For lights with three colors, only the longest and shortest ranges are given and the middle range is indicated by a dash. For example, FI WRG 12-8M means that the range of the white light is 12 nautical miles, the range of green light is 8 nautical miles and the range of the red light is between 8 to 12 nautical miles. The dash can appear in any of the three positions.

### Aids to Navigation Positioning

The fixed and floating aids to navigation depicted on charts have varying degrees of reliability. Floating aids are moored to sinkers by varying lengths of chain and may shift due to sea conditions and other causes. Buoys may also be carried away, capsized or sunk. Lighted buoys may be extinguished and sound signals may not function, because of ice or other causes. Therefore, prudent mariners will not rely solely on any single aid to navigation, particularly on floating aids, but will also use bearings from fixed objects and aids to navigation on shore.

## Colors

Color conveys the nature and importance of features found on nautical charts. Chart elements significant to marine navigation, such as lights, compass roses and regulated areas, are emphasized with magenta. Lateral marks on NOAA charts are shown with a red or green fill. Shades of blue depict potential hazards to navigation, typically shallow water and submerged obstructions. Areas of deeper water believed to be clear of obstructions are shown as white. Land, and other features that are always dry, are depicted with buff on NOAA charts and gray on NGA charts. Foreshore and other intertidal features are portrayed with a green tint. Other colors may be used to provide additional information, such as protected areas, which are outlined in blue or green.

## Traffic Separation Schemes

Traffic separation schemes show recommended lanes to increase safety of navigation, particularly in areas of high density shipping. These schemes are described in the International Maritime Organization (IMO) publication, *Ships Routeing*. Traffic separation schemes are generally shown on nautical charts at scales of 1:600,000 and larger. When possible, traffic separation schemes are plotted to scale and shown as depicted in Section M.

## Conversion Scales

Depth conversion scales are provided on all charts to enable the user to work in meters, fathoms or feet.

## Correction Date

The date of each new chart edition is shown below the lower left border of the chart. The date of the latest NGA issued U.S. Notice to Mariners applied to the chart is shown after the edition date. NOAA charts also show the date of the latest U.S. Coast Guard Local Notice to Mariners applied to the chart.

## ADDITIONAL RESOURCES

Information on the use of nautical charts, aids to navigation, sounding datums and the practice of navigation in general is in *The American Practical Navigator* (Bowditch), available through the “Publications” link on the NGA Maritime Safety Information portal at <https://msi.nga.mil/NGAPortal/MSI.portal>.

Tide and current data over U.S. waters is available from the NOAA Center for Operational Oceanographic Products and Services at <https://tidesandcurrents.noaa.gov>.

Detailed information about specific lights, buoys, and beacons and general information about the U.S. Aids to Navigation System and the Uniform State Waterway Marking Systems is in the U.S. Coast Guard *Light List*, at <https://www.navcen.uscg.gov/?pageName=lightLists>.

Information about aids to navigation in foreign waters is in the NGA *List of Lights*, available through the “Publications” link on the NGA Maritime Safety Information portal at <https://msi.nga.mil/NGAPortal/MSI.portal>.

Other important information that cannot be shown conveniently on nautical charts can be found in the NOAA *U.S. Coast Pilot*<sup>®</sup>, at <https://nauticalcharts.noaa.gov/publications/coast-pilot/index.html> and NGA *Sailing Directions*, available through the “Publications” link on the NGA Maritime Safety Information portal at <https://msi.nga.mil/NGAPortal/MSI.portal>.

U.S. Nautical Chart Catalogs and Indexes

NGA catalogs are available through the “Product Catalog” link on the NGA Maritime Safety Information portal at <https://msi.nga.mil/NGAPortal/MSI.portal>.

NOAA catalogs are available at the NOAA Chart Locator at [www.charts.noaa.gov/InteractiveCatalog/nrnc.shtml](http://www.charts.noaa.gov/InteractiveCatalog/nrnc.shtml) and the NOAA Nautical Chart Catalog and Chart Viewer at [www.charts.noaa.gov/ChartCatalog/MapSelect.html](http://www.charts.noaa.gov/ChartCatalog/MapSelect.html).

A list of the dates of the latest editions of NOAA charts is at <https://nauticalcharts.noaa.gov/charts/list-of-latest-editions.html>.

## CORRECTIONS AND COMMENTS

Corrections to U.S. Chart No. 1 will appear in the weekly U.S. Notice to Mariners, available through the “Notice to Mariners” link on the NGA Maritime Safety Information portal at <https://msi.nga.mil/NGAPortal/MSI.portal>.

Corrections, comments, or questions regarding U.S. Chart No. 1 may be submitted through ASSIST, the NOAA Coast Survey stakeholder engagement and feedback website at [www.nauticalcharts.noaa.gov/customer-service/assist](http://www.nauticalcharts.noaa.gov/customer-service/assist).

or to:

National Ocean Service, NOAA (N/CS2)  
Attention: U.S. Chart No. 1  
1315 East West Highway  
Silver Spring, MD 20910-3282

# Schematic Layout of U.S. Chart No. 1:

**(A) K Rocks, Wrecks, Obstructions (B)**

(D) Supplementary national symbol: a

(C) Rocks	Plane of Reference for Heights → H		Plane of Reference for Depths → H				(D) Supplementary national symbol: a	
(E)	No.	INT	Description	NOAA	NGA	Other NGA	ECDIS	
	11		Rock which covers and uncovers, height above chart datum				 	rock which covers and uncovers or is awash at low water underwater hazard which covers and uncovers with drying height isolated danger of depth less than the safety contour
	(1)	(2)	(3)	(4a)	(4b)	(5)	(6)	(7)

(A)	Section designation
(B)	Section
(C)	Sub-section
(D)	Reference to "Supplementary national symbols" at the end of each section
(E)	Cross-reference to terms in other sections
(1)	Column 1: Numbering system following the "Chart Specification of the IHO". A letter in this column indicates a supplementary national symbol or abbreviation for which there is no international equivalent.
(2)	Column 2: Representation that follows the "Chart Specifications of the IHO" (INT 1 symbol)
(3)	Column 3: Description of symbol, term, or abbreviation
(4a)*	Column 4a: Representation used on charts produced by the National Oceanic and Atmospheric Administration (NOAA)
(4b)*	Column 4b: Representation used on charts produced by the National Geospatial-Intelligence Agency (NGA)
(5)	Column 5: Representation of symbols that may appear on NGA reproductions of foreign charts
(6)**	Column 6: Representation used to portray ENC data on ECDIS
(7)**	Column 7: Description of ECDIS symbols
*	When columns 4a and 4b are combined then NOAA and NGA both use the same symbol. When either column 4a or 4b is blank then the respective agency uses the INT 1 symbol shown in column 2.
**	When columns 6 and 7 have several rows for the same symbol number, then ECDIS portrays this feature differently depending on the ship's draft and other conditions as defined in ECDIS by the mariner (as is the case for K 11). When columns 6 and 7 combine rows to span across several symbol numbers then ECDIS portrays all of the grouped symbol numbers the same way (see C 5–C 7).
†	Signifies that this representation is obsolete, but it may appear on older charts.
	Signifies that a feature attribute value, such as a height, distance or name, may be obtained through an ECDIS cursor pick report. There are many attribute values that may be obtained in this manner, but the cursor pick icon is only used to note values that are specifically referred to in the description of symbols column and that ECDIS does not display next to the symbol. Height of trees in C 14 is an example.



## Day, Dusk and Night Color Palettes



ECDIS allows the mariner to change the color palette that is used to display an ENC. Three different color tables have been designed to provide the maximum clarity and contrast between features on the display under three different lighting conditions on the bridge, namely Day, Dusk and Night.

Each symbol is rendered in a different color appropriate for the lighting condition that the color table is meant for. This design provides maximum contrast for the display on a sunny day, as well as preserving night vision on a dimly lit bridge in the evening. This allows the mariner to look back and forth between the chart on the ECDIS display and out to sea through the bridge window without the mariner's eyes needing to readjust to a difference in light intensity.

- The Day Color Table, meant to be used in bright sunlight, uses a white background for deep water and looks the most like a traditional paper chart.
- The Dusk Color Table uses a black background for deep water and colors are subdued, but slightly brighter than those used in the Night Color Table.
- The Night Color Table, meant to be used in the darkest conditions, uses a black background for deep water and muted color shades for other features.

The images on the right show each of the three color palettes.

The symbols shown in the remainder of this document use the day color palette.

DAY



DUSK

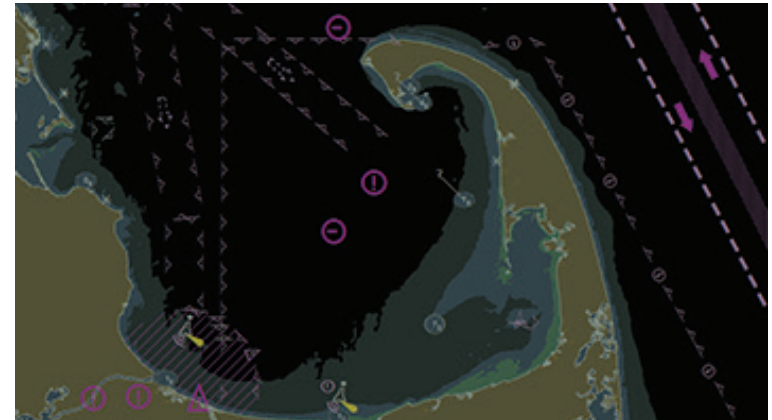

NIGHT



## Schematic Layout of a NOAA Chart (reduced in size)

Note: this is an example only and not to be used for navigation

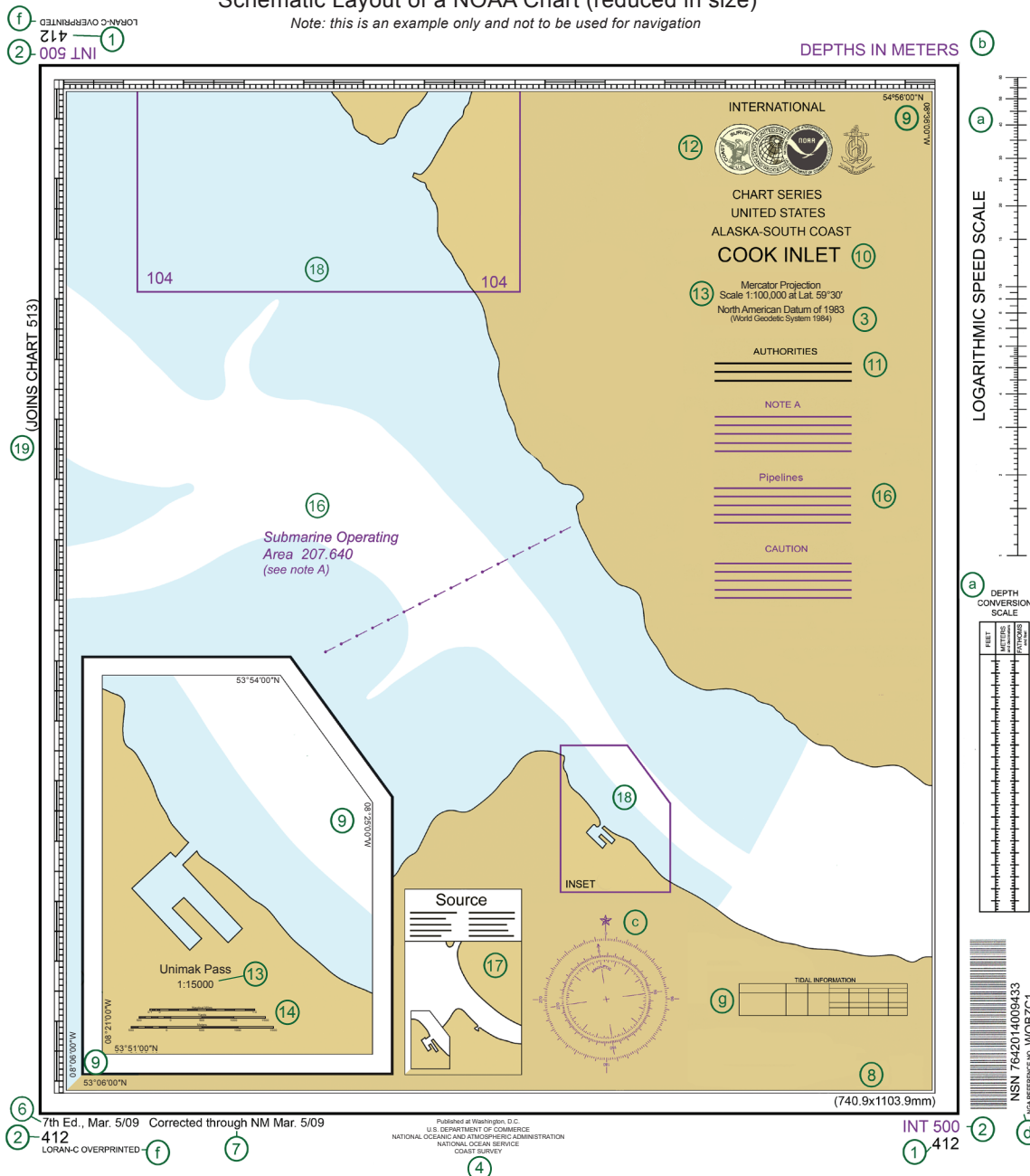

Magnetic Features → B	
Tidal Data → H	
①	Chart number in national chart series
②	Chart number in international (INT) series (if any)
③	Reference ellipsoid of the chart
④	Publication note (imprint)
⑤	Copyright note
⑥	Date of current edition
⑦	Notice to Mariners corrections
⑧	Dimensions of inner borders
⑨	Corner coordinates
⑩	Chart title
⑪	Explanatory notes on chart construction, etc. To be read before using chart.
⑫	Seal(s)
⑬	Scale of chart. Some charts have scale at a stated latitude.
⑭	Linear scale on large scale charts

# A Chart Number, Title, Marginal Notes

15	Linear border scale on large scale charts. On smaller scales use latitude borders for sea miles.
16	Cautionary notes (if any). Information on particular features, to be read before using chart.
17	Source Diagram (if any). Navigators should be cautious where surveys are inadequate.
18	Reference to a larger scale chart
19	Reference to an adjoining chart of similar scale
a	Conversion scales
b	Reference to the units used for depth measurement
c	Compass rose
d	Bar code and stock number
e	Glossary: Translation of words on chart that are not in English
g	Tidal and Tidal Stream information within the chart coverage



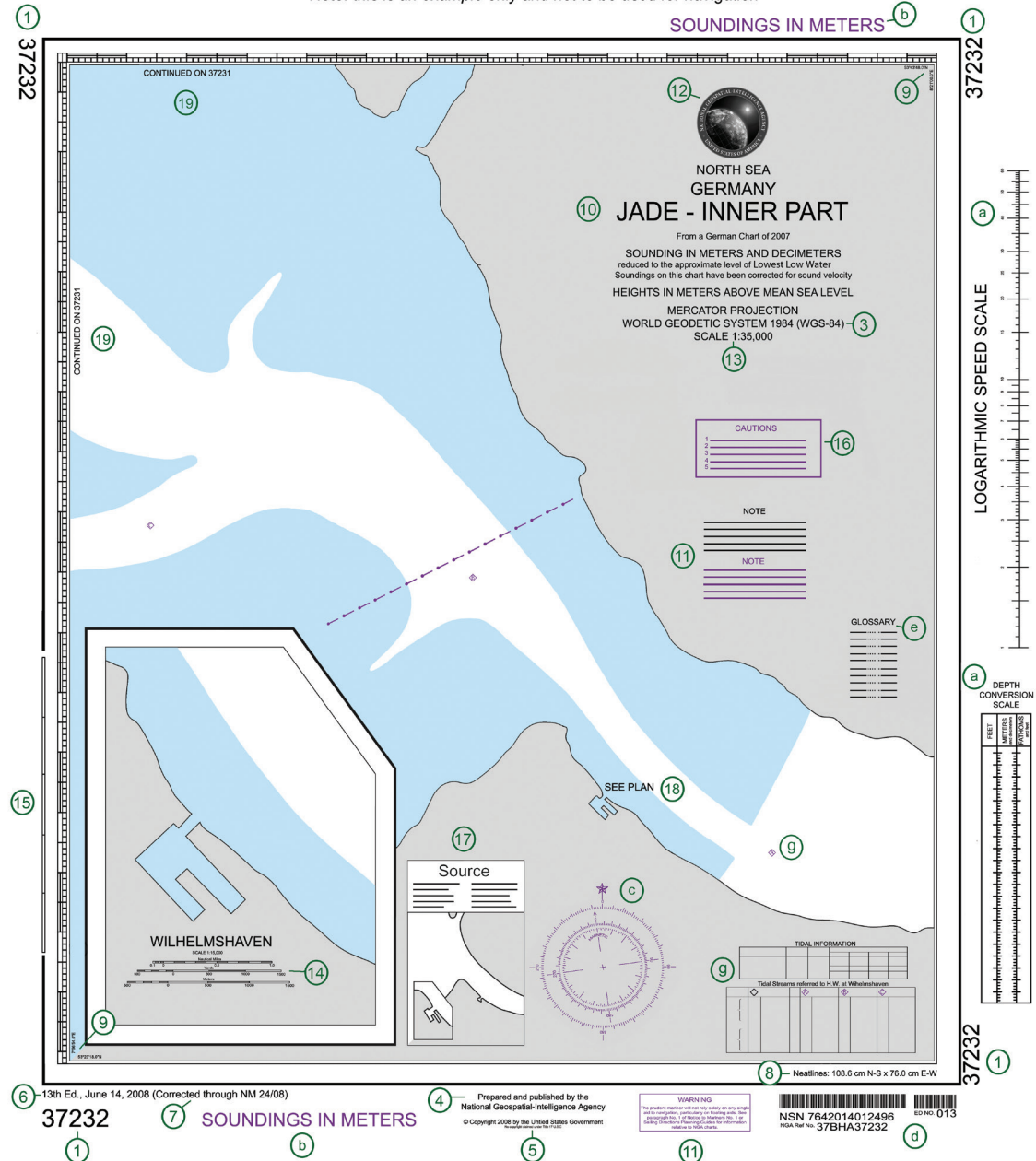

## Schematic Layout of an NGA Chart (reduced in size)

Note: this is an example only and not to be used for navigation







# Positions, Distances, Directions, Compass B

No.	INT	Description	NOAA	NGA	Other NGA	ECDIS
Geographical Positions						
1	Lat	Latitude				
2	Long	Longitude				
4		Degree(s)		deg		
5		Minute(s) of arc				
6		Second(s) of arc				
7	PA	Position approximate (not accurately determined or does not remain fixed)	PA	(PA)		PA      Position approximate
						 Point feature or area of low accuracy
						 Sounding of low accuracy
8	PD	Position doubtful (reported in various positions)	PD	(PD)		PA      Position approximate
						 Point feature or area of low accuracy
						 Sounding of low accuracy
9	N	North				
10	E	East				
11	S	South				
12	W	West				
13	NE	Northeast				
14	SE	Southeast				
15	NW	Northwest				
16	SW	Southwest				



# B Positions, Distances, Directions, Compass

No.	INT	Description	NOAA	NGA	Other NGA	ECDIS	
Control Points							
20		Triangulation Point					
21		Observation spot		⊕ Obs Spot			
22		Fixed point		⊙			
25.1		Distance along waterway, no visible marker					Canal and distance point with no mark
25.2		Distance along waterway with visible marker					Canal and distance point
Note: ECDIS uses a magenta "km" symbol to represent distance marks. However, the distances shown along waterways on NOAA-produced ENC's are displayed in statute miles.							
Symbolized Positions (Examples)							
30		Symbols in plan—position is center of primary symbol					ECDIS follows the paper chart convention for the position of symbols, except for simplified symbols for buoys and beacons (see Q 1).
31		Symbols in plan—position is at bottom of symbol					
32		Point symbols		⊙ MAST			Position of a point feature
33		Point symbols—approximate positions		⊙ Mast			ECDIS indicates approximate position only for wrecks, obstructions, islets and shoreline features.
Units						Supplementary national symbols <i>a–m</i>	
40	km	Kilometer(s)					
41	m	Meter(s)					
42	dm	Decimeter(s)					
43	cm	Centimeter(s)					
44	mm	Millimeter(s)					
45	M	International nautical mile(s) (1852m), sea mile(s)	Mi NMi NM				
47	ft	Foot / Feet					
48	fm, fms	Fathom(s)					

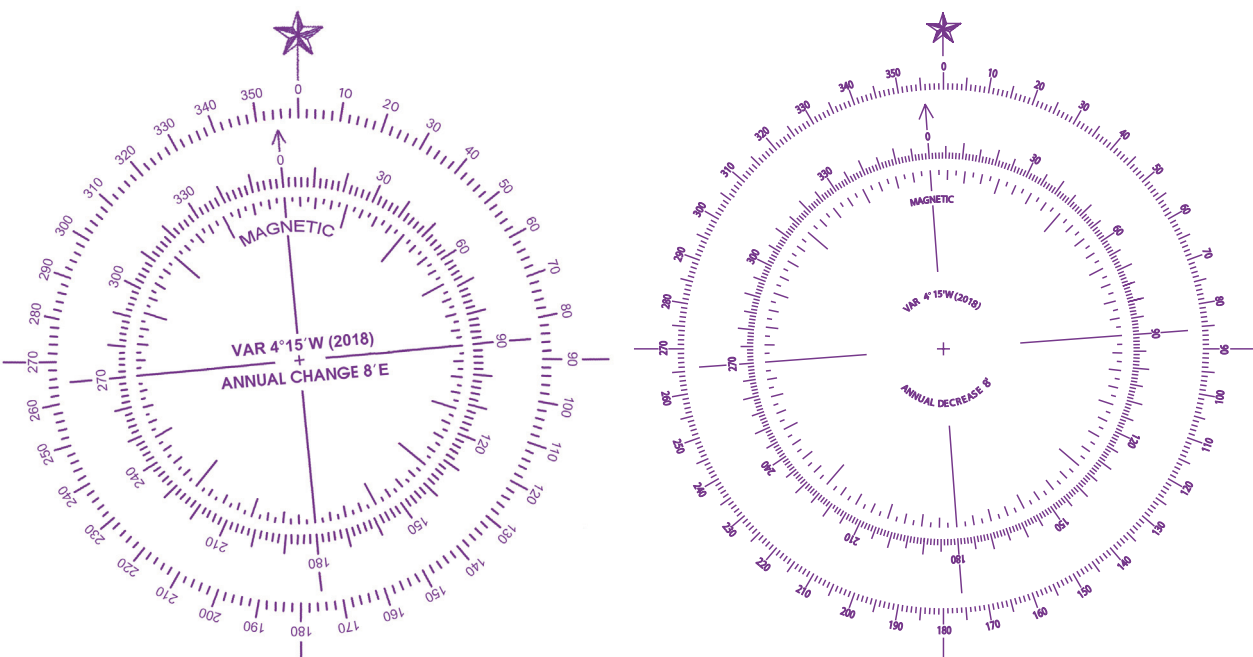

# Positions, Distances, Directions, Compass **B**

No.	INT	Description	NOAA	NGA	Other NGA	ECDIS
49	h	Hour(s)	hr			
50	m	min	Minute(s) of time			
51	s	sec	Second(s) of time			
52	kn	Knot(s)				
53	t	Ton(s), Tonnage (weight)				
54	cd	Candela(s)				
Magnetic Compass						Supplementary national symbols <i>n</i>
68.1	<div style="border: 1px solid purple; padding: 2px; display: inline-block;">                     Magnetic Variation                      4°30' W 2011 (8'E)                 </div>	Note of magnetic variation, in position				 Cursor pick site for magnetic variation at a point
						 Cursor pick site for magnetic variation over an area
68.2	Magnetic Variation at 55°N 8°W 4°30' W 2011 (8'E)	Note of magnetic variation, out of position				

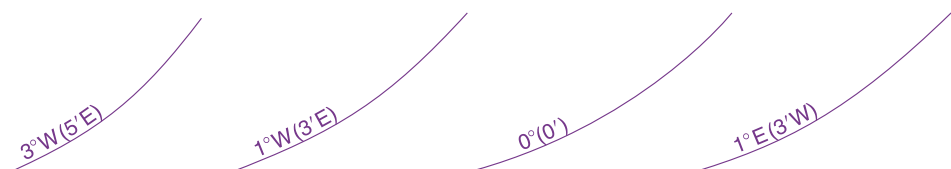
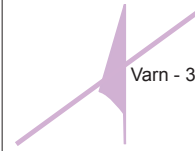
# B Positions, Distances, Directions, Compass

No.	NOAA / NGA	ECDIS
70	<p>Compass rose, normal pattern (smaller patterns of compass rose may be used)</p> <p>Magnetic variation (example):            VAR 4°15'W (2018) means magnetic variation was 4°15'W in 2018            ANNUAL DECREASE 8' means annual change is 8'E or decreasing 8' annually            For 2019 the magnetic variation is 4°7'W</p> 	 <p>Cursor pick site for magnetic variation at a point</p>
71	<p>Isogonic lines, Isogonals</p> <p>MAGNETIC VARIATION LINES ARE FOR 2018            The magnetic variation is shown in degrees, followed by the letter W or E, as appropriate, at certain positions on the lines. The annual change is expressed in minutes with the letter W or E and is given in brackets, immediately following the variation.</p> 	 <p>Var - 3</p> <p>Cursor pick site for magnetic variation along a line</p>

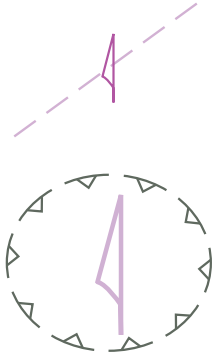











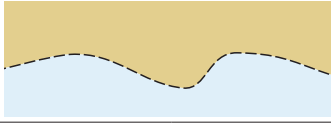
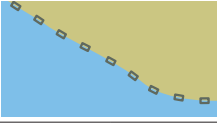

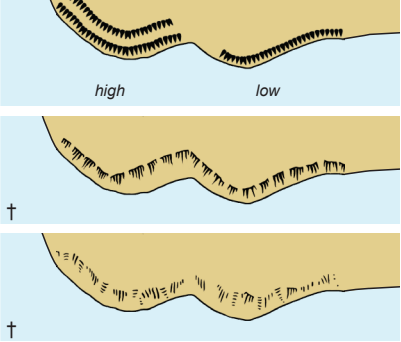
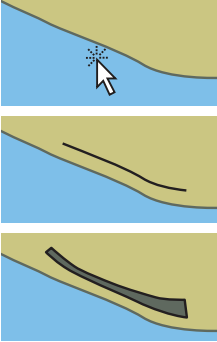

# Positions, Distances, Directions, Compass B

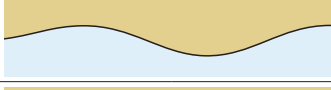
No.	INT	Description	NOAA	NGA	Other NGA	ECDIS
82.1		<p>Local magnetic anomaly Within the enclosed area the magnetic variation may deviate from the normal by the value shown</p>				 <p style="text-align: right; font-size: small;">Cursor pick site for magnetic anomaly along a line or over an area</p>
82.2	<p style="font-size: small; color: purple;">Local Magnetic Anomaly (see Note)</p>	<p>Local magnetic anomaly Where the area affected cannot be easily defined, a legend only is shown at the position</p>	<p style="font-size: small; color: purple;">LOCAL MAGNETIC DISTURBANCE (see note)</p>	<p style="font-size: small; color: purple;">LOCAL MAGNETIC ANOMALY (see note)</p>	<p style="font-size: small; color: purple;">LOCAL MAGNETIC DISTURBANCE (see note)</p>	 <p style="text-align: right; font-size: small;">Cursor pick site for magnetic anomaly at a point</p>
<b>Supplementary National Symbols</b>						
a		Square meter(s)		m <sup>2</sup>		
b		Cubic meter(s)		m <sup>3</sup>		
c		Inch(es)		in		
d		Yard(s)		yd		
e		Statute mile(s)	St M	St Mi		
f		Microsecond(s)	<i>μsec</i>	<i>μs</i>		
g		Hertz		Hz		
h		Kilohertz		kHz		
i		Megahertz		MHz		
j		Cycles/second	cps	c/s		
k		Kilocycle(s)		kc		
l		Megacycle(s)		Mc		
m		Ton(s) (U.S. short ton) (2,000lbs)		T		
o		Benchmark		BM		
p		Variation	var	VAR		Varn    Magnetic variation

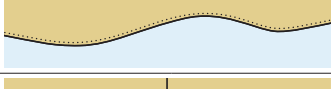
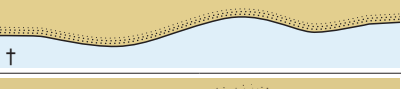
## B Positions, Distances, Directions, Compass

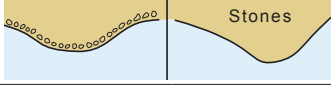
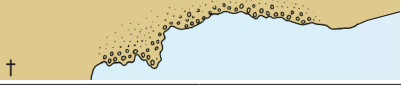
No.	INT	Description	NOAA	NGA	Other NGA	ECDIS
q		Magnetic		mag		
r		Bearing		brg		
s		True		T		

# Natural Features C







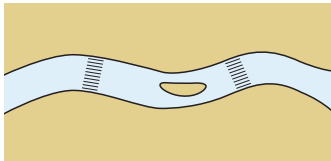
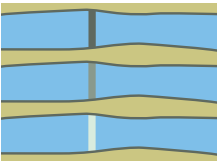
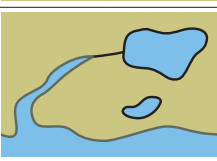

No.	INT	Description	NOAA	NGA	Other NGA	ECDIS
Coastline						Supplementary national symbols: a-e
Foreshore → I, J						
1		Coastline, surveyed				 Coastline
2		Coastline, unsurveyed				 Coastline or shoreline construction of low accuracy in position
3		Cliffs, Steep coast				 Presence of cliffs coincident with coastline is obtained by cursor pick Sloping ground crest line distant from coastline, radar or visually conspicuous Cliff as an area
4		Hillocks				 Conspicuous hill or mountain top
5		Flat coast				
6		Sandy shore				
7		Stony shore, Shingly shore				
8		Sandhills, Dunes				 Conspicuous hill or mountain top

# C Natural Features

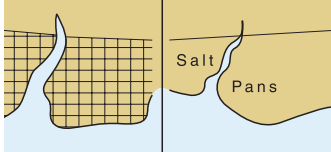
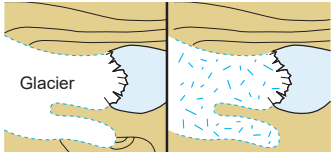
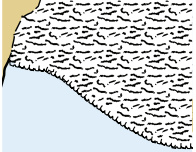
No.	INT	Description	NOAA	NGA	Other NGA	ECDIS
Relief						
Plane of reference for heights → H						
10		Contour lines with values and spot height				Elevation contour with spot height, contour value is obtained by cursor pick
11		Spot heights				Position of an elevation or control point
12		Approximate contour lines with values and approximate height				Elevation contour with spot height, contour value is obtained by cursor pick
13		Form lines with spot height				Elevation contour with spot height, contour value is obtained by cursor pick
14		Approximate height of top of trees (above height datum)				Approximate height of trees is obtained by cursor pick
Water Features, Lava						
20		River, Stream				River
21		Intermittent river, intermittent lake				River

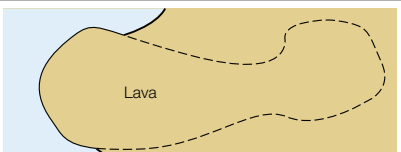
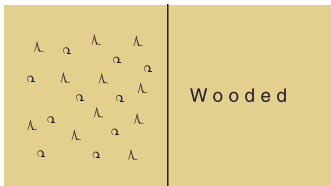









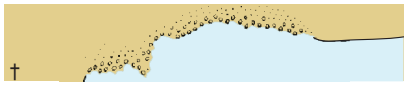

# Natural Features C

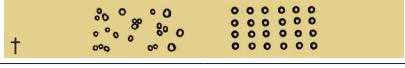
No.	INT	Description	NOAA	NGA	Other NGA	ECDIS	
22		Rapids, Waterfalls					Rapids
							Waterfall Waterfall, visually conspicuous
23		Lakes					Lake
24		Salt pans					
25		Glacier					Continuous pattern for an ice area (glacier, etc.)
26		Lava flow					
Vegetation						Supplementary national symbols: i-t	
30		Woods in general					Line of trees
							Wooded area

# C Natural Features

No.	INT	Description	NOAA	NGA	Other NGA	ECDIS
31	Prominent trees (isolated or in groups)					
31.1		Unspecified tree				
31.2		Evergreen (except conifer)				
31.3		Conifer, Casuarina				
31.4		Palm				
31.5		Nipa Palm				
31.6		Casuarina				
31.7		Filao				
31.8		Eucalypt				
32		Mangrove, Nipa palm				
33		Marsh, Swamp, Reed beds				
Supplementary National Symbols						
a		Chart sounding datum line (surveyed)				
b		Approximate sounding datum line (inadequately surveyed)				
c		Foreshore; Strand (in general); Stones; Shingle; Gravel; Mud; Sand				
d		Breakers along a shore				

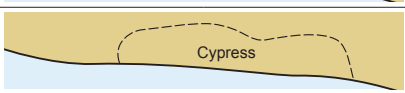
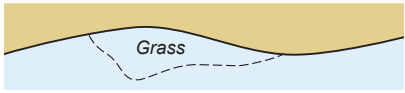
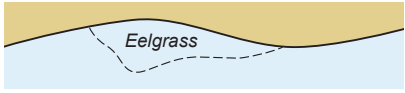
No.	INT	Description	NOAA	NGA	Other NGA	ECDIS
e		Rubble				
f		Hachures				
g		Shading				
i		Deciduous woodland				
j		Coniferous woodland				
k		Tree plantation				
l		Cultivated fields				
m		Grassfields				
n		Paddy (rice) fields				
o		Bushes				
p		Apparent shoreline				
q		Vegetation or topographic (Feature Area Limit-in general)				
r		Cypress				
s		Grass				
t		Eelgrass				

# D Cultural Features

No.	INT	Description	NOAA	NGA	Other NGA	ECDIS	
<b>Settlements, Buildings</b>							
Height of objects → E		Landmarks → E					
1		Urban area					Built-up area
2		Settlement with scattered buildings					
3	○ Name      □ Name	Settlement (on medium and small scale charts)				● Name	Built-up area as a point
4	⊕ Name      ■ Name HOTEL	Village	Vil				
5		Buildings					Conspicuous single building
6		Important building in built-up area					Conspicuous single building in built-up area
7		Street name, Road name					Street name is obtained by cursor pick
8		Ruin, Ruined landmark					Status of ruins is obtained by cursor pick
<b>Roads, Railways, Airfields</b>						<b>Supplementary National Symbols: a-c</b>	
10		Motorway, highway					Road, track or path as a line
11		Road (hard surfaced)					
12		Track, Path (loose or unsurfaced)					Road as an area

# Cultural Features **D**



No.	INT	Description	NOAA	NGA	Other NGA	ECDIS	
13		Railway, with station					Railway, with station
14		Cutting					Cutting
15		Embankment					Embankment
							Embankment, visually or radar conspicuous
16		Tunnel					Tunnel
							Tunnel with depth below the seabed encoded
17		Airport, Airfield					Airport as a point
							Runway as a line
							Airport area, with runway area and visually conspicuous runway area
18		Heliport, Helipad					
Other Cultural Features						Supplementary National Symbols: d-i	
20.1		Fixed bridge					
20.2		Footbridge, fixed bridge on smaller scale charts					

# D Cultural Features

No.	INT	Description	NOAA	NGA	Other NGA	ECDIS
21		Horizontal clearance	FIXED BRIDGE HOR CL 25 FT VERT CL 20 FT	HOR CL 8 M ← 8 →		Horizontal clearance is obtained by cursor pick
22		Vertical clearance (see introduction)		VERT CL 6 M T I		Bridge
23.1		Opening bridge (in general) with vertical clearance				Opening bridge
23.2		Swing bridge with vertical clearance				
23.3		Lifting Bridge with vertical clearance (closed and open)				
23.4		Bascule Bridge with vertical clearance				
23.5		Pontoon bridge				Bridge
23.6		Draw bridge with vertical clearance				Opening bridge
24		Transporter bridge with vertical clearance below fixed structure				Bridge

No.	INT	Description	NOAA	NGA	Other NGA	ECDIS	
25		Overhead transporter, Aerial cableway with vertical clearance					Aerial cableway
							Aerial cableway, radar conspicuous
26.1		Overhead power cable with pylons and physical vertical clearance					Transmission line
26.2		Overhead power cable with pylons and safe vertical clearance					Transmission line, radar conspicuous
<p>Note D26.2: The safe vertical clearance defined by the responsible authority, to avoid risk of electrical discharge, has been obtained by applying a reduction to the physical vertical clearance of the cable. The reduction is variable and depends upon the transmission voltage. See H20.</p>							
27		Overhead cable, Telephone line, with vertical clearance					Overhead cable
					Overhead cable, radar conspicuous		
28		Overhead pipe with vertical clearance					Overhead pipeline
					Overhead pipeline, radar conspicuous		
29		Pipeline on land					Oil, gas pipeline, submerged or on land
<b>Supplementary National Symbols</b>							
a		Highway markers					
c		Abandoned railroad					

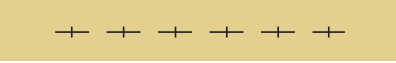
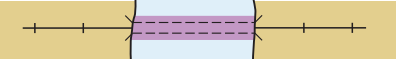
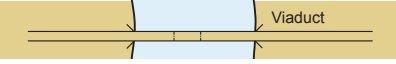
# D Cultural Features

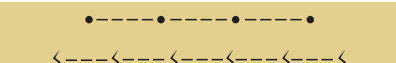
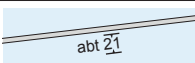
No.	INT	Description	NOAA	NGA	Other NGA	ECDIS	
c		Abandoned railroad					
d		Bridge under construction					
f		Viaduct					
g		Fence					
h		Power transmission line					
i		Approximate vertical clearance					





# Conspicuous and Non-conspicuous Features

There are 25 features for which ECDIS displays either a black symbol, if the feature is visually conspicuous, or a brown symbol if is not. Only conspicuous landmarks are depicted on NOAA paper charts and ENCs. Therefore, only the conspicuous symbol versions are shown in the symbol tables of U.S. Chart No. 1. Both versions of the symbols for these features are shown on this page.















































Cairn		
Chimney		
Dish aerial		
Dome		
Flare stack		
Fortified structure		
Hill or mountain top		
Mast		
Monument		
Mosque or minaret		
Position of a point feature		
Radar scanner		
Radio, television tower		
Refinery		
Religious building, Christian		
Religious building, non-Christian		

Silo		
Single building		
Tank		
Tank farm		
Tower		
Water tower		
Windmill		
Windmotor		
Wind generator farm		

The seven symbols shown below represent features that only have a brown symbol. There is no corresponding black, conspicuous symbol. The brown symbol is displayed regardless of the conspicuousness of the feature.



















































Cranes	
Flagstaff, flagpole	
Mangrove	
Mine, quarry	
Quarry	
Timber yard	
Tree	







# E Landmarks

No.	INT	Description	NOAA	NGA	Other NGA	ECDIS	
Plane of Reference for Height → H		Lighthouses → P	Beacons → Q				
General							
1	 Factory  Hotel	Examples of landmarks	 TANK  Tr  MONUMENT			  	
2	 FACTORY  HOTEL  WATER TR	Examples of conspicuous landmarks (On NOAA charts, a large circle with dot and capitals indicates that position is accurate; a small circle with lowercase indicates that position is approximate.)	 EMPIRE STATE BUILDING  SPIRE  RADAR MAST  CHIMNEY			  	
3.1		Pictorial sketches (in true position)	‡				
3.2		Pictorial sketches (out of position)	‡				
4	 (30)	Height of top of a structure above height datum				 Height is obtained by cursor pick	
5	 (30)	Height of structure above ground level					
Landmarks							
10.1	  Ch	Church			 		Church as a point
							Church as an area
10.2	 Tr  Tr	Church tower					
10.3	 Sp  Sp	Church spire	 SPIRE  Spire				
10.4	 Cup  Cup	Church cupola (dome)	 CUPOLA  Cup				
13		Temple, Pagoda, Shrine, Marabout, Joss house					

No.	INT	Description	NOAA	NGA	Other NGA	ECDIS
17		Mosque, Minaret				Mosque or minaret
19		Cemetery				Landmark area, type is obtained by cursor pick
20	Tr	Tower	TOWER Tr			Tower
21		Water tower, Water tank on a tower	STANDPIPE S'pipe	WTR TR Wtr Tr		Water tower
22	Chy	Chimney	CHIMNEY Chy	CHY 		Chimney
23		Flare stack (on land)	FLARE Flare			Flare stack
24	Mon	Monument (including column, pillar, obelisk, statue, calvary cross)	MONUMENT Mon			Monument
25.1		Windmill	WINDMILL Windmill			Windmill, status of ruins is obtained by cursor pick
25.2	Ru	Windmill (without sails)				
26.1		Wind turbine, Windmotor	WINDMOTOR Windmotor			Wind motor
26.2		Onshore wind farm	WIND FARM Wind Farm			Wind generator farm
27	FS	Flagstaff, Flagpole	FS FP	FS FP		Flagstaff, flagpole
28		Radio mast, Television mast	R MAST TV MAST	R Mast TV Mast		Mast
29		Radio tower, Television tower	R TR TV TR	R Tr TV Tr		Radio, television tower
30.1	Radar	Radar mast	RADAR MAST Radar Mast			Mast
30.2	Radar	Radar tower	RADAR TR Radar Tr			Radar tower

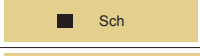
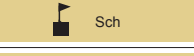

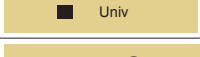







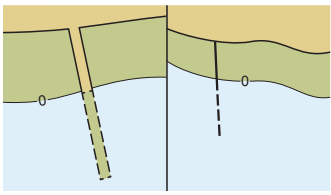







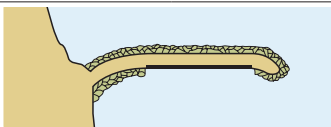
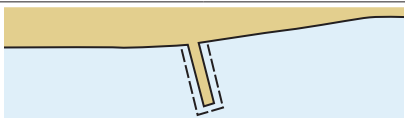

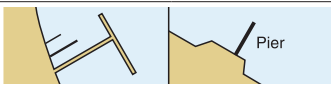
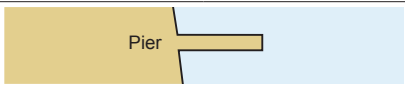

# E Landmarks

No.	INT	Description	NOAA	NGA	Other NGA	ECDIS	
30.3		Radar scanner					Radar scanner
30.4		Radome	 	 			Dome
31		Dish aerial	 				Dish aerial
32	 Tanks	Tanks	 TANK   Tk				Tank
							Tank farm
33	 Silo 	Silo	 SILO   ELEVATOR 		 		Silo
34.1		Fortified structure (on large scale charts)	 				Fortified structure
34.2		Castle, Fort, Blockhouse (on small scale charts)					Fortified structure
34.3		Battery, Small fort (on small scale charts)					
35.1		Quarry (on large scale charts)					Quarry area
35.2		Quarry (on small scale charts)					Quarry
36		Mine					
37.1		Recreational vehicle site					
37.2		Camping site (including recreational vehicles)					
Supplementary National Symbols							
a		Muslim shrine	 				
b		Tomb	 				
c		Watermill	 				

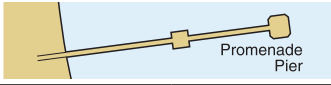
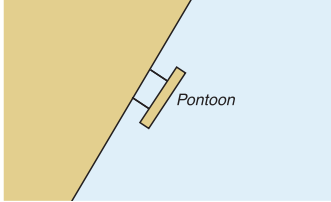
No.	INT	Description	NOAA	NGA	Other NGA	ECDIS
d		Factory				
e		Well				
f		School				
g		Hospital				
h		University				
i		Gable				
k		Telegraph Telegraph office		Tel Tel Off		
l		Magazine		Magz		
m		Government house		Govt Ho		
n		Institute		Inst		
o		Courthouse		Ct Ho		
p		Pavilion		Pav		
q		Telephone		T		
r		Limited		Ltd		
s		Apartment		Apt		
t		Capitol		Cap		
u		Company		Co		
v		Corporation		Corp		

# F Ports

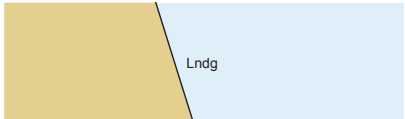









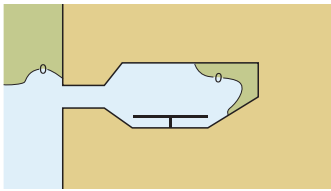
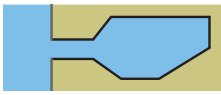

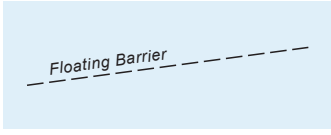

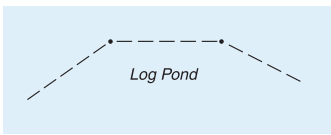

No.	INT	Description	NOAA	NGA	Other NGA	ECDIS
Protective Structures						Supplementary national symbols: a-c
1		Dike, Levee, Berm				Dike as a line Dike as a line, conspicuous Dike as an area
2.1		Seawall (on large scale charts)				Seawall
2.2		Seawall (on small scale charts)				
3		Causeway				Causeway as a line Causeway, covers and uncovers as a line Causeway as an area Causeway, covers and uncovers as an area
4.1		Breakwater (in general)				Breakwater as a line
4.2		Breakwater (loose boulders, tetrapods, etc.)			Breakwater as an area	
4.3		Breakwater (slope of concrete or masonry)				
5		Training wall (partly submerged at high water)				Training wall

No.	INT	Description	NOAA	NGA	Other NGA	ECDIS	
6		Groin (partly submerged at high water)					Groin (intertidal)
<b>Harbor Installations</b>							
Depths → I		Anchorages, Limits → N		Beacons and other fixed marks → Q		Marina → U	
10		Fishing harbor					Fishing harbor
11.1		Boat harbor, Marina					Yacht harbor, marina
11.2		Yacht berths without facilities					
11.3		Yacht club, Sailing club					
12		Mole (with berthing facility)					Mole as a line
							Mole as an area
13		Quay, Wharf					Wharf (quay)
14		Pier, Jetty					Pier (jetty), promenade pier
15		Promenade pier					
16		Pontoon					Pontoon as a line
							Pontoon as an area
17		Landing for boats					Landing

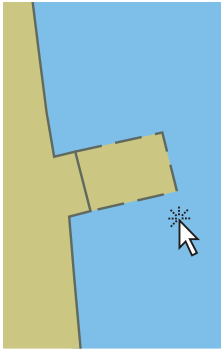
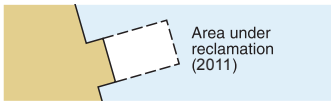
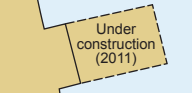
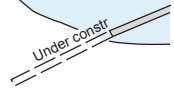
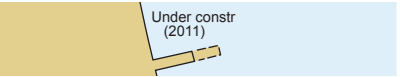
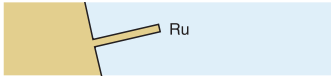
# F Ports

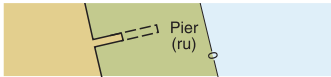
No.	INT	Description	NOAA	NGA	Other NGA	ECDIS
18		Steps, Landing stairs				
19.1		Designation of berth	3    A    3			
19.2		Visitors' berth				
19.3		Dangerous cargo berth				
20		Dolphin				
21		Deviation dolphin				
22		Minor post or pile				
23		Slipway, Patent slip, Ramp				
24		Gridiron, Scrubbing grid, Careening grid				
25		Dry dock, Graving dock				
26		Floating dock				
27		Non-tidal basin, Wet dock				



No.	INT	Description	NOAA	NGA	Other NGA	ECDIS	
28		Tidal basin, Tidal harbor				 Dock	
	 Dock, under construction or ruined						
29.1	 Floating Barrier	Floating barrier, e.g. security, containment booms (ice, logs, oil), shark nets: - with supports - without supports				 Floating hazard	
	 Log Pond					 Boom	
29.2	 Bubble Curtain	Bubble curtain (bubbler, pneumatic pipe)				 Boom, floating obstruction	
						 Floating oil barrier, oil retention (high pressure pipe)	
30		Works on land, with year date					
31		Works at sea, Area under reclamation, with year date					Ruin or works under construction  Year and condition of under construction or ruin is obtained by cursor pick
32	Under construction (2011) Works in progress (2011)	Works under construction, with year date					
33.1		Ruin					 Pier, ruined and partly submerged
33.2		Ruined pier, partly submerged at high water					
34		Hulk				 Hulk	

# F Ports

No.	INT	Description	NOAA	NGA	Other NGA	ECDIS
Canals, Barrages						Supplementary national symbol: d
Cultural Features → B		Clearances → D	Signal Stations → T			
40		Canal				
41.1		Lock (on large scale charts)				
41.2		Lock (on small scale charts)				
42		Gate, Caisson				
43		Flood barrage				
44		Dam, Weir (direction of flow shown is left to right)				

No.	INT	Description	NOAA	NGA	Other NGA	ECDIS	
Transshipment Facilities						Supplementary national symbols: e-f	
Roads → D		Railways → D		Tanks → E			
50		Roll-on, Roll-off Ferry Terminal (RoRo Terminal)					RoRo terminal
51		Transit shed, Warehouse (with designation)					Conspicuous single building, designation is obtained by cursor pick
52		Timber yard					Timber yard as a point
							Timber yard as an area
53.1		Crane with lifting capacity, Traveling crane (on railway)					Lifting capacity is obtained by cursor pick
							Crane as a point
53.2		Container crane (with lifting capacity)					Crane as an area
							Crane, visually conspicuous as an area
Public Buildings						Supplementary national symbol: g	
60		Harbormaster's office					Conspicuous single building
61		Custom office					Conspicuous single building
							Customs
62.1		Health office, Quarantine building					Conspicuous single building
62.2		Hospital					
63		Post office					

# F Ports

No.	INT	Description	NOAA	NGA	Other NGA	ECDIS
Supplementary National Symbols						
a		Jetty (partly below MHW)				
b		Submerged jetty				
c		Jetty (on small scale charts)				
d		Pump-out facilities				
e		Quarantine office				
g		Conveyor				

**Terms Relating to Tide Levels**

<b>INT Terms</b>		
<b>No.</b>	<b>Term</b>	<b>Description</b>
1	CD	Chart Datum, Datum for sounding reduction
2	LAT	Lowest Astronomical Tide
3	HAT	Highest Astronomical Tide
4	MLW	Mean Low Water
5	MHW	Mean High Water
6	MSL	Mean Sea Level
8	MLWS	Mean Low Water Springs
9	MHWS	Mean High Water Springs
10	MLWN	Mean Low Water Neaps
11	MHWN	Mean High Water Neaps
12	MLLW	Mean Lower Low Water
13	MHHW	Mean Higher High Water
14	MHLW	Mean Higher Low Water
15	MLHW	Mean Lower High Water
16	Sp	Spring tide
17	Np	Neap tide

<b>Supplementary National Terms (see I-t for other terms and symbols)</b>		
<b>No.</b>	<b>Term</b>	<b>Description</b>
a	HW	High Water
b	HHW	Higher High Water
c	LW	Low Water
d	LWD	Low Water Datum
e	LLW	Lower Low Water
f	MTL	Mean Tide Level
g	ISLW	Indian Spring Low Water
h	HWF&C	High Water Full and Change (Vulgar establishment of the port)
i	LWF&C	Low Water Full and Change
j	CRD	Columbia River Datum
k	GCLWD	Gulf Coast Low Water Datum

# H Tides, Currents

No.	
Tidal Levels and Charted Data	
Tide Gauge → T	

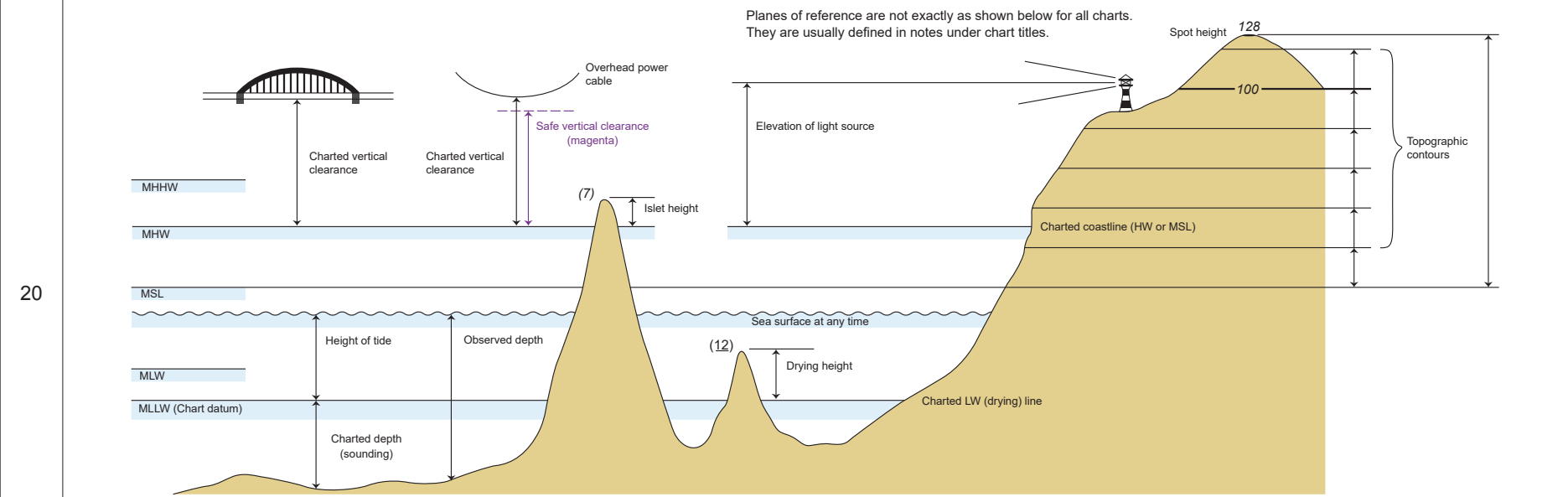

**Notes:**

- 1) The numbers 128, 100, (7) and (12), shown above, are examples of how spot heights, topographic contour labels, islet heights and drying heights appear on NOAA paper charts. The numbers are enclosed in parentheses if the value is offset into the water to more clearly show the islet or rock.
- 2) On NOAA charts, except for lake charts, the HW (coast) line is equal to the MHW line.

## Tide Tables

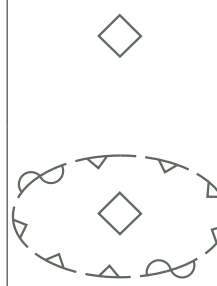

No.	INT	Description	NOAA																																																																						
30	Tidal Levels referred to datum of soundings	Tabular statement of semi-diurnal or diurnal tides  Note: The order of the columns of levels will be the same as that used in national tables of tidal predictions.	TIDAL INFORMATION																																																																						
	<table border="1" style="width: 100%; border-collapse: collapse;"> <thead> <tr> <th rowspan="2">Place</th> <th rowspan="2">Lat N</th> <th rowspan="2">Long E</th> <th colspan="4">Heights in metres above datum</th> </tr> <tr> <th>MHWS</th> <th>MHWN</th> <th>MLWN</th> <th>MLWS</th> </tr> </thead> <tbody> <tr> <td rowspan="2">Norderney, Riffgat Langeoog</td> <td>53°42'</td> <td>7°09'</td> <td>3.2</td> <td>2.8</td> <td>0.9</td> <td>0.4</td> </tr> <tr> <td>53°43'</td> <td>7°30'</td> <td>3.4</td> <td>3.0</td> <td>0.9</td> <td>0.4</td> </tr> <tr> <td></td> <td></td> <td></td> <th>MHHW</th> <th>MLHW</th> <th>MHLW</th> <th>MLLW</th> </tr> <tr> <td></td> <td></td> <td></td> <td></td> <td></td> <td></td> <td></td> </tr> </tbody> </table>		Place	Lat N	Long E	Heights in metres above datum				MHWS	MHWN	MLWN	MLWS	Norderney, Riffgat Langeoog	53°42'	7°09'	3.2	2.8	0.9	0.4	53°43'	7°30'	3.4	3.0	0.9	0.4				MHHW	MLHW	MHLW	MLLW								<table border="1" style="width: 100%; border-collapse: collapse;"> <thead> <tr> <th rowspan="2">PLACE</th> <th rowspan="2">Height referred to datum of soundings (MLLW)</th> <th colspan="3"></th> </tr> <tr> <th>NAME</th> <th>(LAT/LONG)</th> <th>Mean Higher High Water</th> <th>Mean High Water</th> <th>Mean Low Water</th> </tr> </thead> <tbody> <tr> <td></td> <td></td> <td></td> <td></td> <td>feet</td> <td>feet</td> <td>feet</td> </tr> <tr> <td>Baltimore, Ft. McHenry</td> <td>(39°16'N/76°35'W)</td> <td>1.7</td> <td>1.4</td> <td>0.2</td> </tr> <tr> <td>Annapolis, U.S. Naval Academy</td> <td>(38°59'N/76°29'W)</td> <td>1.4</td> <td>1.2</td> <td>0.2</td> </tr> <tr> <td>Washington D.C., Washington Channel</td> <td>(38°52'N/77°01'W)</td> <td>3.2</td> <td>2.9</td> <td>0.1</td> </tr> </tbody> </table>	PLACE	Height referred to datum of soundings (MLLW)				NAME	(LAT/LONG)	Mean Higher High Water	Mean High Water	Mean Low Water					feet	feet	feet	Baltimore, Ft. McHenry	(39°16'N/76°35'W)	1.7	1.4	0.2	Annapolis, U.S. Naval Academy	(38°59'N/76°29'W)	1.4	1.2	0.2	Washington D.C., Washington Channel	(38°52'N/77°01'W)	3.2	2.9	0.1
	Place					Lat N	Long E	Heights in metres above datum																																																																	
MHWS		MHWN	MLWN	MLWS																																																																					
Norderney, Riffgat Langeoog	53°42'	7°09'	3.2	2.8	0.9	0.4																																																																			
	53°43'	7°30'	3.4	3.0	0.9	0.4																																																																			
			MHHW	MLHW	MHLW	MLLW																																																																			
PLACE	Height referred to datum of soundings (MLLW)																																																																								
		NAME	(LAT/LONG)	Mean Higher High Water	Mean High Water	Mean Low Water																																																																			
				feet	feet	feet																																																																			
Baltimore, Ft. McHenry	(39°16'N/76°35'W)	1.7	1.4	0.2																																																																					
Annapolis, U.S. Naval Academy	(38°59'N/76°29'W)	1.4	1.2	0.2																																																																					
Washington D.C., Washington Channel	(38°52'N/77°01'W)	3.2	2.9	0.1																																																																					
			Dashes (---) located in datum columns indicate unavailable datum values for a tide station. Real-time water levels, tide predictions, and tidal current predictions are available on the Internet from <a href="http://tidesandcurrents.noaa.gov">http://tidesandcurrents.noaa.gov</a> .  (Nov 2011)																																																																						

No.	INT	ECDIS																																																															
31	<p>Tidal streams referred to ...</p> <table border="1"> <thead> <tr> <th>Hours</th> <th>Geographical Position</th> <th colspan="4"></th> </tr> </thead> <tbody> <tr> <td>6</td> <td rowspan="12"> <div style="display: flex; align-items: center;"> <div style="writing-mode: vertical-rl; transform: rotate(180deg); font-size: 0.8em; margin-right: 5px;">Before High Water</div> <div style="font-size: 0.8em; margin-right: 5px;">{</div> <div style="font-size: 0.8em; margin-right: 5px;">6</div> </div> </td> <td rowspan="6">Directions of streams (degrees)</td> <td rowspan="6">Rates at spring tides (knots)</td> <td rowspan="6">Rates at neap tides (knots)</td> <td>-6</td> <td>261</td> <td>0.8</td> <td>0.7</td> </tr> <tr> <td>-5</td> <td>170</td> <td>0.2</td> <td>0.1</td> </tr> <tr> <td>-4</td> <td>097</td> <td>1.1</td> <td>0.8</td> </tr> <tr> <td>-3</td> <td>095</td> <td>1.5</td> <td>1.2</td> </tr> <tr> <td>-2</td> <td>094</td> <td>1.3</td> <td>1.1</td> </tr> <tr> <td>-1</td> <td>092</td> <td>1.0</td> <td>0.9</td> </tr> <tr> <td>0</td> <td>081</td> <td>0.7</td> <td>0.6</td> </tr> <tr> <td>+1</td> <td>038</td> <td>0.3</td> <td>0.2</td> </tr> <tr> <td>+2</td> <td>291</td> <td>0.6</td> <td>0.4</td> </tr> <tr> <td>+3</td> <td>277</td> <td>1.0</td> <td>0.8</td> </tr> <tr> <td>+4</td> <td>270</td> <td>1.2</td> <td>1.0</td> </tr> <tr> <td>+5</td> <td>267</td> <td>1.1</td> <td>1.0</td> </tr> <tr> <td>+6</td> <td>264</td> <td>1.0</td> <td>0.9</td> </tr> </tbody> </table>	Hours	Geographical Position					6	<div style="display: flex; align-items: center;"> <div style="writing-mode: vertical-rl; transform: rotate(180deg); font-size: 0.8em; margin-right: 5px;">Before High Water</div> <div style="font-size: 0.8em; margin-right: 5px;">{</div> <div style="font-size: 0.8em; margin-right: 5px;">6</div> </div>	Directions of streams (degrees)	Rates at spring tides (knots)	Rates at neap tides (knots)	-6	261	0.8	0.7	-5	170	0.2	0.1	-4	097	1.1	0.8	-3	095	1.5	1.2	-2	094	1.3	1.1	-1	092	1.0	0.9	0	081	0.7	0.6	+1	038	0.3	0.2	+2	291	0.6	0.4	+3	277	1.0	0.8	+4	270	1.2	1.0	+5	267	1.1	1.0	+6	264	1.0	0.9	 <p>Point or area for which a tidal stream table is available</p> <p>Boundary of an area for which there is tidal information</p>
Hours	Geographical Position																																																																
6	<div style="display: flex; align-items: center;"> <div style="writing-mode: vertical-rl; transform: rotate(180deg); font-size: 0.8em; margin-right: 5px;">Before High Water</div> <div style="font-size: 0.8em; margin-right: 5px;">{</div> <div style="font-size: 0.8em; margin-right: 5px;">6</div> </div>	Directions of streams (degrees)	Rates at spring tides (knots)	Rates at neap tides (knots)	-6	261	0.8	0.7																																																									
-5					170	0.2	0.1																																																										
-4					097	1.1	0.8																																																										
-3					095	1.5	1.2																																																										
-2					094	1.3	1.1																																																										
-1					092	1.0	0.9																																																										
0		081	0.7	0.6																																																													
+1		038	0.3	0.2																																																													
+2		291	0.6	0.4																																																													
+3		277	1.0	0.8																																																													
+4		270	1.2	1.0																																																													
+5		267	1.1	1.0																																																													
+6	264	1.0	0.9																																																														

### Tidal Streams and Currents

Supplementary national symbols: m-t

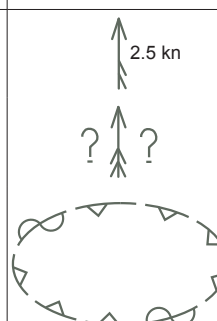

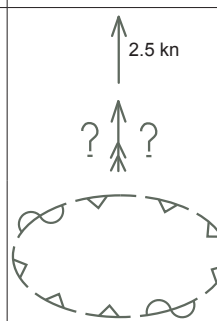













Breakers → K      Tide Gauge → T

No.	INT	Description	NOAA	NGA	Other NGA	ECDIS
40		Flood tide stream with mean spring rate				 <p>Flood stream, rate at spring tides</p> <p>Current or tidal stream whose direction is not known</p> <p>Boundary of an area for which there is tidal information</p>
41		Ebb tide stream with mean spring rate				 <p>Ebb stream, rate at spring tides</p> <p>Current or tidal stream whose direction is not known</p> <p>Boundary of an area for which there is tidal information</p>













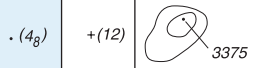

# H Tides, Currents

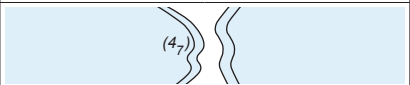
No.	INT	Description	NOAA	NGA	Other NGA	ECDIS	
42		Current in restricted waters					Non-tidal current
43		Ocean current with rates and seasons					
44		Overfalls, tide rips, races					Overfalls, tide rips; eddies; breakers as point, line, and area
45		Eddies					
46		Position of tabulated tidal stream data with designation					Point for which a tidal stream table is available
47		Offshore position for which tidal levels are tabulated					
Supplementary National Symbols (Supplementary national terms relating to tidal levels are listed after H 17)							
l		Stream		Str			
m		Current, general, with rate					
n		Velocity, Rate		vel			
o		Knots		kn			
p		Height		ht			
q		Flood		fl			
u		Gulf Stream Limits					

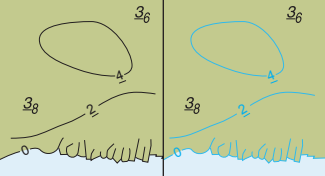
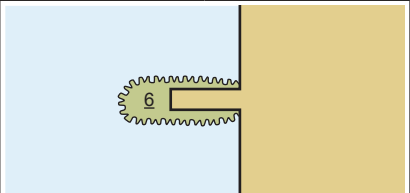

No.	INT	Description	NOAA	NGA	Other NGA	ECDIS
General						
1	ED	Existence doubtful				 Sounding of low accuracy
2	SD	Sounding of doubtful depth				   Sounding of low accuracy Underwater hazard with depth greater than 20 meters Isolated danger of depth less than the safety contour
3.1	Rep	Reported, but not confirmed				  Sounding of low accuracy Point feature or area of low accuracy
3.2	Rep (2011)	Reported (with year of report), but not confirmed				  Low accuracy line demarking area wreck or obstruction Low accuracy line demarking foul area
4	 	Reported, but not confirmed sounding or danger (on small scale charts only)				      Obstruction, depth not stated Sounding of low accuracy Underwater hazard with depth of 20 meters or less Underwater hazard with depth greater than 20 meters Isolated danger of depth less than the safety contour Point feature or area of low accuracy

# I Depths

No.	INT	Description	NOAA	NGA	Other NGA	ECDIS	
Soundings						Supplementary national symbols: a-c	
Plane of Reference for Depths → H			Plane of Reference for Heights → H				
10		Sounding in true position (NOAA shows fathoms and feet with vertical numbers and meters with sloping numbers)					Sounding shallower than or equal to safety depth Sounding deeper than safety depth
11		Sounding out of position					Depths are always shown in their true position in ECDIS
12		Least depth in narrow channel					
13		No bottom found at depth shown					Status of no bottom found is obtained by cursor pick
14		Soundings which are unreliable or taken from a smaller scale source (NOAA shows unreliable soundings in fathoms and feet with sloping numbers and in meters with vertical numbers)					Sounding of low accuracy
15		Drying heights and contours above chart datum					Drying height, less than or equal to safety depth
16		Natural watercourse (in intertidal area)					Tideway

No.	INT	Description	NOAA	NGA	Other NGA	ECDIS
Depths in Fairways and Areas						Supplementary national symbols: a, b
Plane of Reference for Depths → H						
20		Limit of dredged area				
21		Dredged channel or area with depth of dredging in meters and decimeters				
22		Dredged channel or area with depth and year of the latest control survey				
24		Area swept by wire drag. The depth is shown at chart datum. (The latest date of sweeping is shown in parentheses.)				
25		Unsurveyed or inadequately surveyed area; area with inadequate depth information				

# ECDIS Portrayal of Depths



ECDIS depth related symbols closely resemble their paper chart counterparts; however, ECDIS provides valuable additional information to mariners that paper charts cannot.

## Soundings

ECDIS enables mariners to set their own-ship “safety depth.” If no depth is set, ECDIS sets the value to 30m. Soundings equal to or shoaler than the safety depth are shown in black; deeper soundings are displayed in a less conspicuous gray. Fractional values are shown with subscript numbers of the same size.

## Depth Contours & Depth Areas

Depth contours in ECDIS are portrayed with a thin gray line. Each pair of adjacent depth contours is used to create depth area features. These are used by ECDIS to tint different depth levels and to initiate alarms when a ship is headed into unsafe water.

## Depth Contour Labels

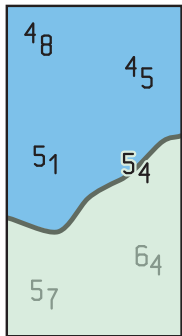

ECDIS depth contour labels are not centered and oriented along isolines as they appear on paper charts. They are displayed upright and may appear either on or next to the contour lines that they describe. The labels are black and the same size as soundings, but the labels have a light “halo” to set them apart. The graphic to the left shows depth labels and soundings both deeper and shoaler than the safety depth. Note that depths on NOAA paper charts and ENCs are usually compiled in fathoms and feet. Because ECDIS displays depths in meters, soundings and contour lines often show fractional meter values. The “own-ship safety contour” (described below) is always displayed, but mariners may choose to have all other depth contours turned off.

## Safety Contour

ECDIS uses a “safety contour” value to show an extra thick line for the depth contour that separates “safe water” from shoaler areas. If the mariner does not set an own-ship safety contour value, ECDIS sets the value to 30m. If the ENC being displayed does not have a contour line equal to the safety contour depth value set by the mariner, then ECDIS sets the next deeper contour as the safety contour. Depending on the contour intervals used on individual ENCs, ECDIS may set different safety contours as a ship transits from one ENC to another. ECDIS will initiate an alarm if the ship’s future track will cross the safety contour within a specified time set by the mariner.

## Two or Four Tints for Shading Depth Areas

ECDIS tints all depth areas beyond the (green tinted) foreshore in either one of two or one of four shades of blue. This is similar to the convention used for paper charts, but the depths used to change from one tint to another are based on the safety contour and thus “customized” for each ship. If the mariner chooses two shades to be displayed, water deeper than the safety contour is shown in an off-white color, water shoaler than the safety contour is tinted blue.

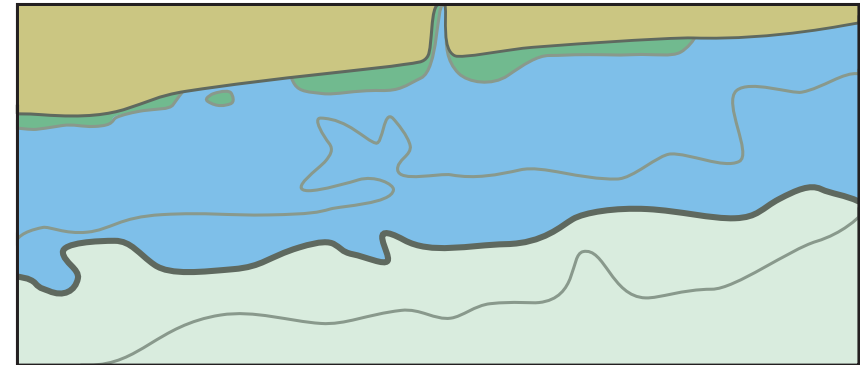

Portrayal of Depth Areas with 2 Color Settings

Some ECDIS enable mariners to define two additional depth areas for medium-deep water and medium-shallow water by setting a “deep contour” value and a “shallow contour” value. If this option is used, the safety contour is displayed between the medium deep and medium shallow contours.

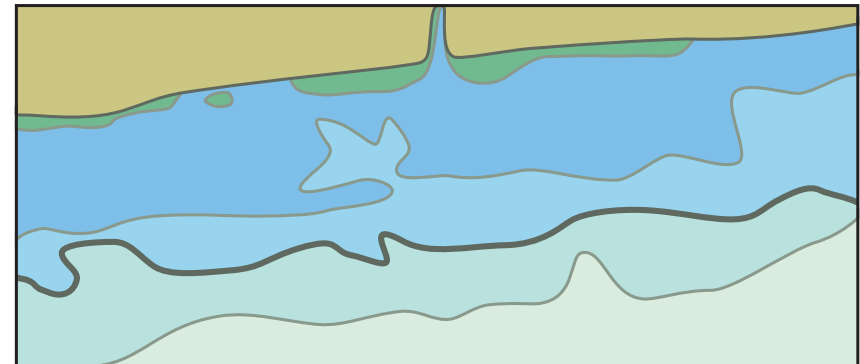

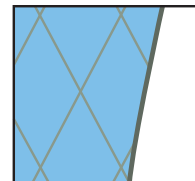

Portrayal of Depth Areas with 4 Color Setting



Some ECDIS also provide the mariner with the option of displaying a cross-hatch “shallow water” pattern over all depth areas shoaler than the safety contour.

No.	INT	Description	NOAA	NGA	Other NGA	ECDIS
<b>Depth Contours</b>						
30		<p>Drying contour Low water line</p> <p>Blue tint, in one or more shades, or tint ribbons are shown to different limits according to the scale and purpose of the chart and the nature of the bathymetry.</p> <p>On some charts, contours and values are printed in blue.</p>				
31		Approximate depth contours				<p>Approximate depth contour Approximate safety depth contour</p>
<b>Supplementary National Symbols</b>						
a		Swept channel				
b		Swept area, not adequately sounded (shown by purple or green tint)				
c		Stream				

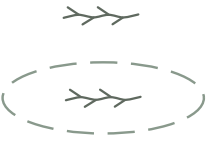
# J Nature of the Seabed

No.	INT	Description	NOAA	NGA	Other NGA	ECDIS	
Types of Seabed						Supplementary national abbreviations: a-ag	
Rocks → K							
1	S	Sand				S	Sand
2	M	Mud				M	Mud
3	Cy	Clay				Cy	Clay
4	Si	Silt				Si	Silt
5	St	Stones				St	Stones
6	G	Gravel				G	Gravel
7	P	Pebbles				P	Pebbles
8	Cb	Cobbles				Cb	Cobbles
9.1	R	Rock; Rocky		<i>Rk; rky</i>		R	Rock
9.2	Bo	Boulder(s)		<i>BlDs</i>		R	Boulder
						R	Lava
10	Co	Coral, Coralline algae				Co	Coral
11	Sh	Shells (skeletal remains)				Sh	Shells
12.1	<i>S/M</i>	Two layers, e.g. sand over mud					
12.2	<i>fS M Sh</i> <i>fS.M.Sh</i>	The main constituent is given first for mixtures, e.g. fine sand with mud and shells	<i>f S M Sh</i>				
13.1	<i>Wd</i>	Weed (including kelp)					Weed, kelp
13.2		Kelp, Weed		 <i>Kelp</i>			Weed, kelp as an area
13.3	Sg	Seagrass					

No.	INT	Description	NOAA	NGA	Other NGA	ECDIS	
14		Sandwaves		Sandwaves			Sand waves as a point
							Sand waves as a line
							Sand waves as an area
15		Spring in seabed		Spring			Spring
<b>Types of Seabed, Intertidal Areas</b>							
20		Area with stones and gravel					Areas of gravel and stone
21		Rocky area, which covers and uncovers		Rock			Rocky ledges or coral reef
22		Coral reef, which covers and uncovers		Coral			Rocky ledges or coral reef
<b>Qualifying Terms</b>							
30	<i>f</i>	Fine	} only used in relation to sand				
31	<i>m</i>	Medium					
32	<i>c</i>	Coarse					
33	<i>bk</i>	Broken					
34	<i>sy</i>	Sticky					
35	<i>so</i>	Soft					
36	<i>sf</i>	Stiff					
37	<i>v</i>	Volcanic		<i>vol</i>			
38	<i>ca</i>	Calcareous		<i>Ca</i>			Rocky ledges or coral reef
39	<i>h</i>	Hard					











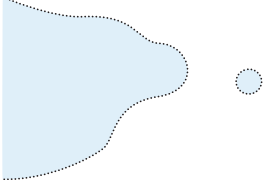
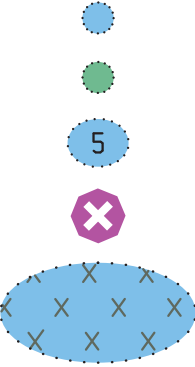

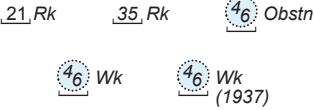
# J Nature of the Seabed

No.	INT	Description	NOAA	NGA	Other NGA	ECDIS
Supplementary National Abbreviations						
a		Ground		<i>Grd</i>		
b		Ooze		<i>Oz</i>		
c		Marl		<i>Ml</i>		
d		Shingle		<i>Sn</i>		
f		Chalk		<i>Ck</i>		
g		Quartz		<i>Qz</i>		
h		Schist		<i>Sch</i>		
i		Coral head		<i>Co Hd</i>		
j		Madrepores		<i>Mds</i>		
k		Volcanic ash		<i>Vol Ash</i>		
l		Lava		<i>La</i>		
m		Pumice		<i>Pm</i>		
n		Tufa		<i>T</i>		
o		Scoriae		<i>Sc</i>		
p		Cinders		<i>Cn</i>		
q		Manganese		<i>Mn</i>		
r		Oysters		<i>Oys</i>		
s		Mussels		<i>Ms</i>		
t		Sponge		<i>Spg</i>		
u		Kelp		<i>K</i>		
v		Grass		<i>Grs</i>		
w		Sea-tangle		<i>Stg</i>		
x		Spicules		<i>Spi</i>		
y		Foraminifera		<i>Fr</i>		
z		Globigerina		<i>Gl</i>		
aa		Diatoms		<i>Di</i>		
ab		Radiolaria		<i>Rd</i>		
ac		Pteropods		<i>Pt</i>		
ad		Polyzoa		<i>Po</i>		
ae		Cirripedia		<i>Cir</i>		
af		Fucus		<i>Fu</i>		

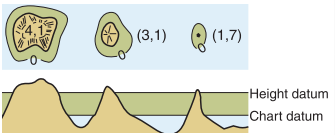
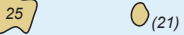

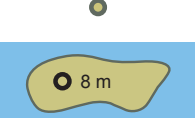
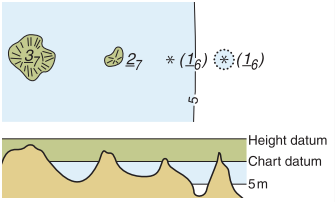
No.	INT	Description	NOAA	NGA	Other NGA	ECDIS
ag		Mattes		<i>Ma</i>		
ah		Small		<i>sml</i>		
ai		Large		<i>lrg</i>		
aj		Rotten		<i>rt</i>		
ak		Streaky		<i>str</i>		
al		Speckled		<i>spk</i>		
am		Gritty		<i>gty</i>		
an		Decayed		<i>dec</i>		
ao		Flinty		<i>fly</i>		
ap		Glacial		<i>glac</i>		
aq		Tenacious		<i>ten</i>		
ar		White		<i>wh</i>		
as		Black		<i>bl; bk</i>		
at		Violet		<i>vi</i>		
au		Blue		<i>bu</i>		
av		Green		<i>gn</i>		
aw		Yellow		<i>yl</i>		
ax		Orange		<i>or</i>		
ay		Red		<i>rd</i>		
az		Brown		<i>br</i>		
ba		Chocolate		<i>ch</i>		
bb		Gray		<i>gy</i>		
bc		Light		<i>lt</i>		
bd		Dark		<i>dk</i>		
be		Varied		<i>vard</i>		
bf		Uneven		<i>unev</i>		

# K Rocks, Wrecks Obstructions and Aquaculture

No.	INT	Description	NOAA	NGA	Other NGA	ECDIS	
General							
1		Danger line: A danger line draws attention to a danger which would not stand out clearly enough if represented solely by its symbol (e.g. isolated rock) or delimits an area containing numerous dangers, through which it is unsafe to navigate					<p>Obstruction, depth not stated</p> <p>Obstruction which covers and uncovers</p> <p>Underwater hazard with depth of 20 meters or less</p> <p>Isolated danger of depth less than the safety contour</p> <p>Foul area, not safe for navigation</p>
2		Depth swept by wire drag or confirmed by diver (This symbol may be combined with other symbols, e.g. wrecks, obstructions, wells.)					<p>Swept sounding, less than or equal to safety depth</p> <p>Swept sounding, greater than safety depth</p>
3		Safe clearance depth. The exact depth is unknown, but is estimated to have a safe clearance at the depth shown				ECDIS displays safe clearance depths in the same manner as known depths.	
Rocks							
Plane of Reference for Heights → H		Plane of Reference for Depths → H					
10		Rock (islet) which does not cover, height above height datum					<p>Land as a point at small scale</p> <p>Land as an area, with an elevation or control point</p>
11		Rock which covers and uncovers, height above chart datum					<p>Rock which covers and uncovers or is awash at low water</p> <p>Underwater hazard which covers and uncovers with drying height</p> <p>Isolated danger of depth less than the safety contour</p>

# Rocks, Wrecks, Obstructions and Aquaculture K

No.	INT	Description	NOAA	NGA	Other NGA	ECDIS	
12		Rock awash at the level of chart datum					Rock which covers and uncovers or is awash at low water
13		Underwater rock of unknown depth, dangerous to surface navigation					Dangerous underwater rock of uncertain depth
							Isolated danger of depth less than the safety contour
14		Underwater rock of known depth					
14.1		inside the corresponding depth area	12 Rk	27 Rk 21 R			Underwater hazard with a depth of 20 meters or less
							Underwater hazard with depth greater than 20 meters
14.2		outside the corresponding depth area, dangerous to surface navigation		 			Isolated danger of depth less than the safety contour
15	35 R	Underwater rock of known depth, not dangerous to surface navigation	35Rk		35 R.    +(35)		Underwater hazard with a depth of 20 meters or less
							Underwater hazard with depth greater than 20 meters

# K Rocks, Wrecks Obstructions and Aquaculture

No.	INT	Description	NOAA	NGA	Other NGA	ECDIS
16		Coral Reef which is always covered				<p>Dangerous underwater rock of uncertain depth</p> <p>Obstruction, depth not stated</p> <p>Isolated danger of depth less than the safety contour</p> <p>Safe clearance shoaler than safety contour</p> <p>Safe clearance deeper than safety contour</p> <p>Safe clearance deeper than 20 meters</p>
17		Breakers				<p>Overfalls, tide rips; eddies; breakwaters as point, line, and area</p>
<b>Wrecks and Fouls</b>						
Plane of Reference for Depths → H						
20		Wreck, hull never covers, on large scale charts, height above height datum				<p>Wreck, always dry, with height shown</p>
21		Wreck, covers and uncovers, on large scale charts, height above chart datum				<p>Wreck, covers and uncovers</p> <p>Distributed remains of wreck</p>































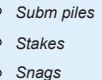

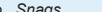

# Rocks, Wrecks, Obstructions and Aquaculture K

No.	INT	Description	NOAA	NGA	Other NGA	ECDIS
22		Submerged wreck, depth known, on large scale charts				  
23		Submerged wreck, depth unknown, on large scale charts			  	
24		Wreck showing any portion of hull or superstructure at level of chart datum			   	
25		Wreck of which the mast(s) only are visible at chart datum				
26	 	Wreck, least depth known by sounding only				  
27	 	Wreck, depth swept by wire drag or confirmed by diver				  



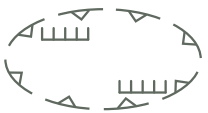







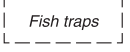
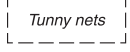

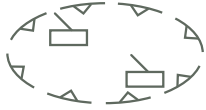
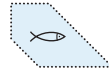





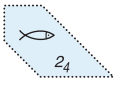





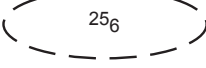

# K Rocks, Wrecks Obstructions and Aquaculture

No.	INT	Description	NOAA	NGA	Other NGA	ECDIS	
28		Dangerous wreck, depth unknown					Dangerous wreck, depth unknown
29		Sunken wreck, not dangerous to surface navigation					Non-dangerous wreck, depth unknown
30		Wreck over which the exact depth is unknown, but which is estimated to have a safe clearance at the depth shown.					Underwater hazard with safe clearance of 20 meters or less
							Underwater hazard with safe clearance greater than 20 meters
							Isolated danger of depth less than the safety contour
31.1		Foul ground, not dangerous to surface navigation, but to be avoided by vessels anchoring, trawling, etc. (e.g. remains of wreck, cleared platform)					Foul area of seabed safe for navigation but not for anchoring
31.2							Foul ground
							Distributed remains of wreck
<b>Obstructions and Aquaculture</b>							
Plane of Reference for Depths → H		Kelp, Seaweed → J	Underwater Installations → L				
40		Obstruction, depth unknown					Obstruction, depth not stated
							Isolated danger of depth less than the safety contour
							Safe clearance shoaler than safety contour

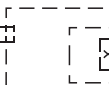
# Rocks, Wrecks, Obstructions and Aquaculture K

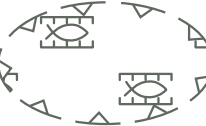
No.	INT	Description	NOAA	NGA	Other NGA	ECDIS	
41	 	Obstruction, least depth known by sounding only				  	Underwater hazard with depth of 20 meters or less Underwater hazard with depth greater than 20 meters Isolated danger of depth less than the safety contour
42	 	Obstruction, depth swept by wire drag or confirmed by diver				  } swept depth  Method of depth measurement is obtained by cursor pick  } known by diver or other means  } 	Less than or equal to safety depth Greater than safety depth Underwater hazard with depth of 20 meters or less Underwater hazard with depth greater than 20 meters Isolated danger of depth less than the safety contour
43.1	 	Stumps of posts or piles, wholly submerged				  	Obstruction, depth not stated Underwater hazard with depth of 20 meters or less Isolated danger of depth less than the safety contour
43.2		Submerged pile, stake, snag, or stump (with exact position)	     				Isolated danger of depth less than the safety contour
44.1		Fishing stakes				 	Fish stakes as a point Fish stakes as an area
44.2		Fish trap, Fish weir, Tunny nets					Fish trap, fish weir, tunny net as a point

# K Rocks, Wrecks Obstructions and Aquaculture











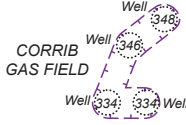









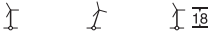

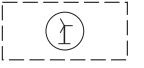

No.	INT	Description	NOAA	NGA	Other NGA	ECDIS	
45	 	Fish trap area, Tunny nets area					Fish trap, fish weir, tunny net as an area
46.1	 	Fish haven	 Obstn Fish Haven	 (actual shape)		 	Isolated danger of depth less than the safety contour  Safe clearance shoaler than safety contour
46.2	 	Fish haven with minimum depth	 Obstn Fish Haven (auth min 42ft)			     	Underwater hazard with depth of 20 meters or less  Underwater hazard with depth greater than 20 meters  Isolated danger of depth less than the safety contour  Safe clearance shoaler than safety contour  Safe clearance deeper than safety contour  Safe clearance deeper than 20 meters
47	 	Shellfish beds					Marine farm as a point
48.1	 	Marine farm (on large scale charts), area of marine farms		 Marine Farm			Marine farm as an area
48.2	 	Marine farm (on small scale charts)		 Obstn (Marine Farm)			
Supplementary National Symbols							
a		Rock which covers and uncovers, (height unknown)	* 				





































# Rocks, Wrecks, Obstructions and Aquaculture K

















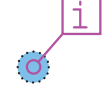



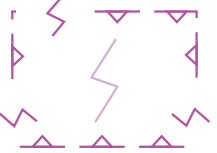

No.	INT	Description	NOAA	NGA	Other NGA	ECDIS
b		Shoal sounding on isolated rock or rocks			 	
c		Sunken wreck covered 20 to 30 meters	++			
d		Submarine volcano		Sub vol		
e		Discolored water		Discol water		
f		Sunken danger, least depth cleared by wire drag		Obstrn		
g		Reef of unknown extent		Reef		
h		Coral reef, detached (uncovers at sounding datum)		 		
i		Submerged crib				
j		Crib, duck blind (above water)		Duck Blind  Crib		
k		Submerged duck blind		Duck Blind		
l		Submerged platform				
m		Coral reef which covers and uncovers				
n		Sinkers				
o		Foul area, foul with rocks or wreckage, dangerous to navigation	  			
p		Unexploded ordnance				
q		Float				
r		Stumps of posts or piles, which cover and uncover				

# L Offshore Installations

No.	INT	Description	NOAA	NGA	Other NGA	ECDIS	
General							
Areas, Limits → N							
1	<i>Ekofisk Oilfield</i>	Name of oilfield or gasfield					Area to be navigated with caution, name is obtained by cursor pick
2		Platform with designation/name					Offshore platform, name is obtained by cursor pick
3		Limit of safety zone around offshore installation					Area where entry is prohibited or restricted or to be avoided, with other cautions
4		Limit of development area					Cautionary area, navigate with caution
5.1		Wind turbine, floating wind turbine, vertical clearance under blade					Wind motor visually conspicuous
5.2		Offshore wind farm					Wind farm (offshore)
		Offshore wind farm (floating)					
6		Wave farm, Renewable energy device					Wave farm
Platforms and Moorings							
Mooring Buoys → Q							
10		Production platform, Platform, Oil derrick					Offshore platform
11		Flare stack (at sea)					Conspicuous flare stack on offshore platform

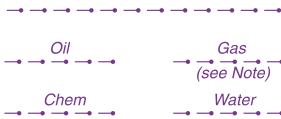
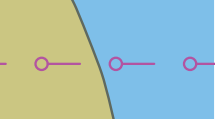
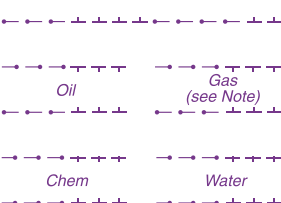
No.	INT	Description	NOAA	NGA	Other NGA	ECDIS	
12		Single Point Mooring (SPM), including Single Anchor Leg Mooring (SALM), Articulated Loading Column (ALC)					Offshore platform, name and status of disused is obtained by cursor pick
14	 	Disused platform with superstructure removed					
16		Single Buoy Mooring (SBM), Oil or gas installation buoy including Catenary Anchor Leg Mooring (CALM)					Installation buoy and mooring buoy, simplified Installation buoy, paper chart
17		Moored storage tanker, Accommodation vessel		 <i>Tanker</i>			Offshore platform
18		Mooring ground tackle					Ground tackle
<b>Underwater Installations</b>						Supplementary national symbol: a	
Plane of Reference for Depths → H		Obstructions → K					
20		Submerged production well	 <i>Well (cov 21ft)</i>  <i>Well (cov 83ft)</i> 		 <i>15: Prod Well</i>  <i>Prod Well</i>	  	Underwater hazard with depth of 20 meters or less Underwater hazard with depth greater than 20 meters Isolated danger of depth less than the safety contour
21.1		Suspended well, depth over wellhead unknown					Isolated danger of depth less than the safety contour
21.2	 	Suspended well, with depth over wellhead	 <i>Pipe (cov 24ft)</i>  <i>Pipe (cov 92ft)</i>			  	Underwater hazard with depth of 20 meters or less Underwater hazard with depth greater than 20 meters Isolated danger of depth less than the safety contour

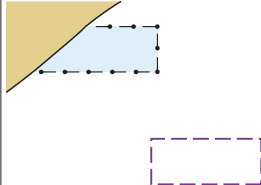



















# L Offshore Installations

No.	INT	Description	NOAA	NGA	Other NGA	ECDIS
22	#	Site of cleared platform				# Foul area of seabed safe for navigation but not for anchoring
23	 Pipe  Pipe (1 <sub>g</sub> )	Above-water wellhead (lit or unlit)	 Pipe		 Pipe (2 <sub>g</sub> )	 Obstruction in the water which is always above water level
24	 Turbine  F1(2) Underwater Turbine	Underwater turbine				  Underwater turbine or subsurface ODAS
25	 ODAS	Subsurface Ocean(ographic) Data Acquisition System (ODAS)				
<b>Submarine Cables</b>						
30.1		Submarine cable				 Submarine cable area
30.2		Submarine cable area	 Cable Area			
31.1		Submarine power cable				 Submarine cable area
31.2		Submarine power cable area				
32		Disused submarine cable				 Status of disused is obtained by cursor pick
<b>Submarine Pipelines</b>						
40.1		Supply pipeline: unspecified, oil, gas, chemicals, water				 Oil, gas pipeline, submerged or on land
40.2		Supply pipeline area: unspecified, oil, gas, chemicals, water	 Pipeline Area			 Submarine pipeline area with potentially dangerous contents

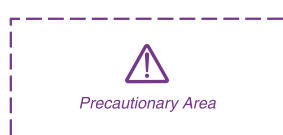
No.	INT	Description	NOAA	NGA	Other NGA	ECDIS	
41.1		Outfall and intake: unspecified, water, sewer, outfall, intake					Water pipeline, sewer, etc.
		Outfall and intake area: unspecified, water, sewer, outfall, intake					Submarine pipeline area with generally non-dangerous contents
42.1		Buried pipeline/pipe (with nominal depth to which buried)					Nominal depth of buried pipeline is obtained by cursor pick
42.2		Pipeline tunnel					Pipeline tunnel
43		Diffuser, Crib					Underwater hazard with depth of 20 meters or less
							Isolated danger of depth less than the safety contour
44		Disused pipeline/pipe					Status of disused is obtained by cursor pick
Supplementary National Symbols							
a		Submerged well (buoyed)					
b		Potable water intake					

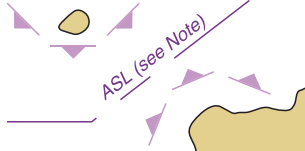
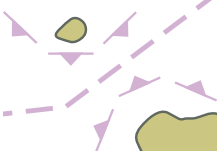
# M Tracks, Routes

No.	INT	Description	NOAA	NGA	Other NGA	ECDIS
Tracks						Supplementary national symbols: a-c
Tracks Marked by Lights → P		Leading Beacons → Q				
1		Leading line (solid line is the track to be followed, ≠ means "in line")	-----	Lights in line 090°		Leading line bearing a non-regulated, recommended track - <?> - - - - < Direction not encoded - - - - < 270 deg < One-way - - - - < 270 deg < > Two-way
2		Transit (other than leading line), clearing line		Beacons in line 090°	Bns in line 270.5°	- - - - 270 deg - - - - Clearing line; transit line
3		Recommended track based on a system of fixed marks	-----	Lights in line 090°		Non-regulated, recommended track based on fixed marks - <?> - - - - < Direction not encoded > - - - - 90 deg > One-way < > - - - - 270 deg < > Two-way
4		Recommended track not based on a system of fixed marks				Non-regulated, recommended track not based on fixed marks - <?> - - - - < Direction not encoded - > - - - - 90 deg > One-way - < > - - - - 270 deg < > Two-way
5.1		One-way track and DW track based on a system of fixed marks				Based on fixed marks, one-way > - - - - 90 deg > Non-regulated recommended track > - - - - DW > Deep water route
5.2		One-way track and DW track not based on a system of fixed marks				Not based on fixed marks, one-way - > - - - - 90 deg > Non-regulated recommended track - > - - - - DW > Deep water route centerline
6		Recommended track with maximum authorized (or recommended) draft stated		 		If encoded, the shallowest depth range value along the track is obtained by cursor pick

No.	INT	Description	NOAA	NGA	Other NGA	ECDIS
Routing Measures						Supplementary national symbols: d-e
Basic Symbols						
10		Established (mandatory) direction of traffic flow				 Traffic direction in a one-way lane of a traffic separation scheme
11		Recommended direction of traffic flow				 Single traffic direction in a two-way route part of a traffic-separation scheme
12		Separation line (large scale, small scale)				 Traffic separation line
13		Separation zone				 Traffic separation zone
14		Limit of restricted routing measure (e.g. Inshore Traffic Zone (ITZ), Area to be Avoided (ATBA))				
15		Limit of routing measure				 Traffic separation scheme boundary
16		Precautionary area				 Traffic precautionary area as a point
						 Traffic precautionary area as an area
17		Archipelagic Sea Lane (ASL); axis line and limit beyond which vessels shall not navigate				 Axis and boundary of archipelagic sea lane
18		Fairway designated by regulatory authority:				 Fairway, depth is obtained by cursor pick
		with minimum depth				

# M Tracks, Routes

Examples of Routing Measures on Paper/Raster Charts

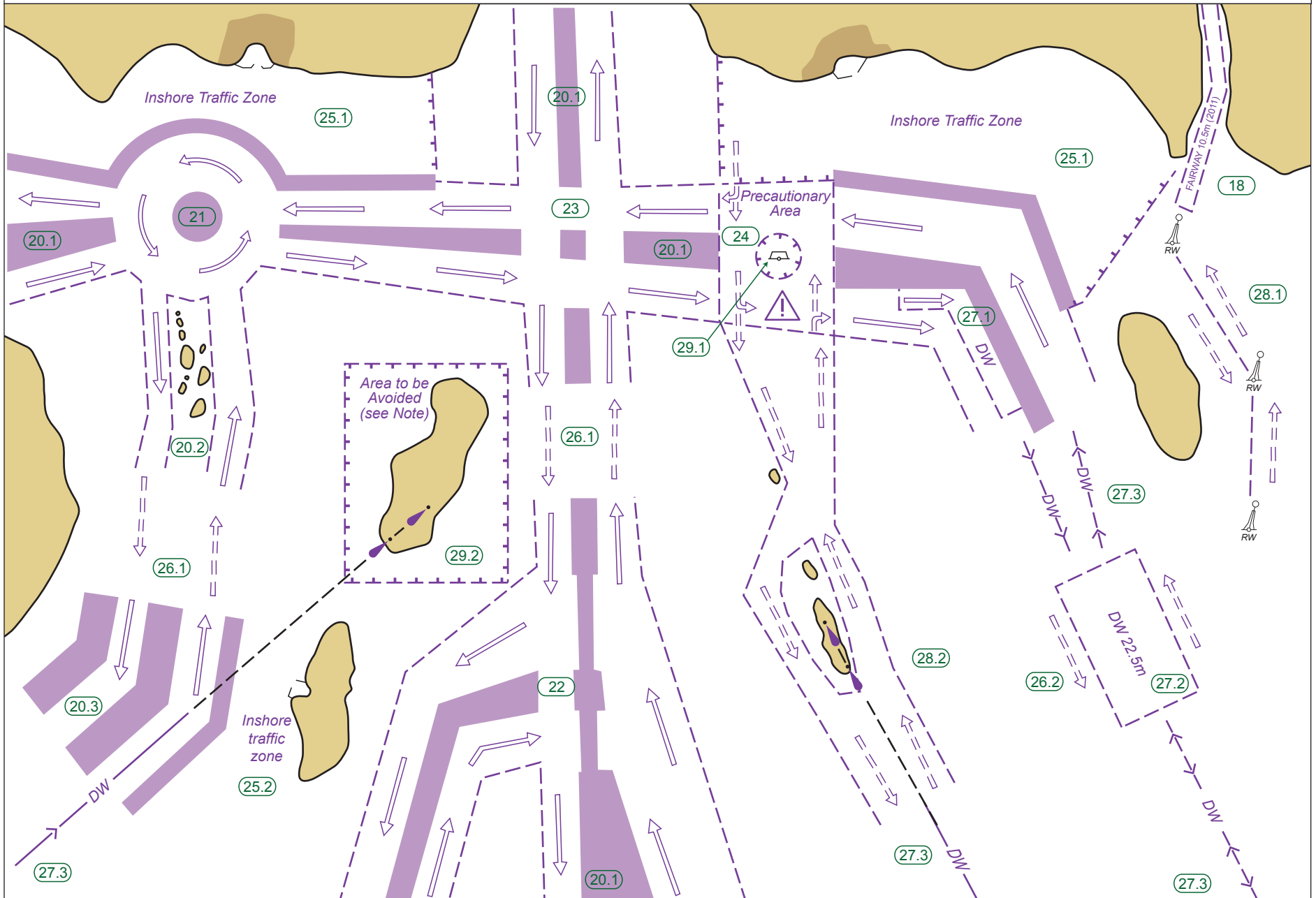







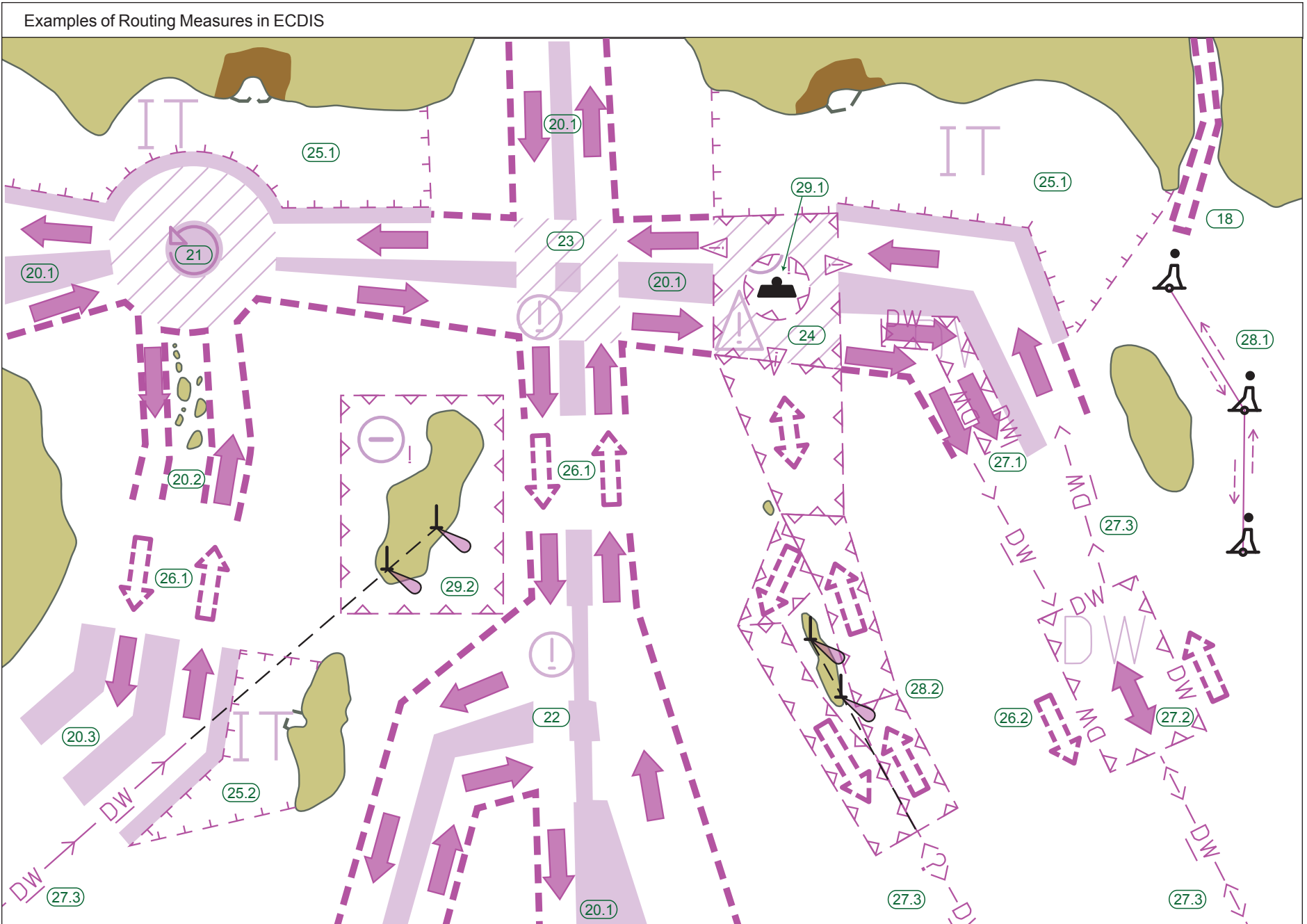











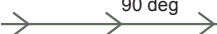
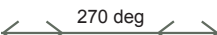









No.	
<b>Examples of Routing Measures</b>	
18	Safety fairway
20.1	Traffic Separation Scheme (TSS), traffic separated by separation zone
20.2	Traffic Separation Scheme, traffic separated by natural obstructions
20.3	Traffic Separation Scheme, with outer separation zone separating traffic using scheme from traffic not using it
21	Traffic Separation Scheme, roundabout with separation zone
22	Traffic Separation Scheme, with "crossing gates"
23	Traffic Separation Scheme crossing, without designated precautionary area
24	Precautionary area
25.1	Inshore Traffic Zone (ITZ), with defined end limits
25.2	Inshore Traffic Zone, without defined end limits
26.1	Recommended direction of traffic flow, between traffic separation schemes
26.2	Recommended direction of traffic flow, for ships not needing a deep water route
27.1	Deep water route (DW), as part of one-way traffic lane
27.2	Two-way deep water route, with minimum depth stated
27.3	Deep water route, centerline as recommended one-way or two-way track
28.1	Recommended route, one-way and two-way (often marked by centerline buoys)
28.2	Two-way route, with one-way sections
29.1	Area to be Avoided (ATBA), around navigational aid
29.2	Area to be Avoided, e.g. because of danger of stranding



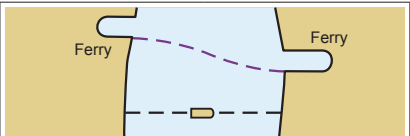

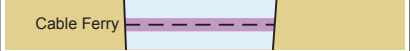





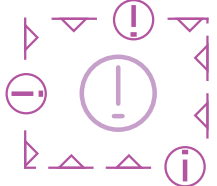



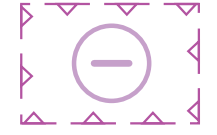
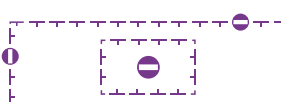

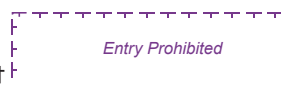









# M Tracks, Routes



No.	INT	Description	NOAA	NGA	Other NGA	ECDIS
<b>Radar Surveillance Systems</b>						
30	 Radar Surveillance Station	Radar surveillance station				 Radar station
31		Radar range				 Radar range
32.1		Radar reference line				 Radar line
32.2		Radar reference line coinciding with a leading line				Non-regulated recommended track based on fixed marks  Direction not encoded  One-way  Two-way
<b>Radio Reporting Points</b>						
40.1		Radio reporting (calling-in or way) points showing direction(s) of vessel movement with designation (if any) and VHF-channel				 Radio calling-in point for traffic in one direction only  Radio calling-in point for traffic in both directions  Radio calling-in point, direction not encoded
		Radio reporting line				 Radio calling-in point for traffic in one direction only  Radio calling-in point for traffic in both directions  Radio calling-in point, direction not encoded

# M Tracks, Routes



No.	INT	Description	NOAA	NGA	Other NGA	ECDIS
Ferries						
50		Ferry				 Ferry route
51	 Cable Ferry	Cable Ferry				 Cable ferry route
Supplementary National Symbols						
a		Recommended track for deep draft vessels (track not defined by fixed marks)				
b		Depth is shown where it has been obtained by the cognizant authority				
c		Alternate course				

No.	INT	Description	NOAA	NGA	Other NGA	ECDIS	
<b>General *</b>							
Dredged and Swept Areas → I		Submarine Cables, Submarine Pipelines → L	Tracks, Routes → M				
On multi-colored charts, symbols in Section N may be in green when associated with environmental areas.							
1.1	Tint band may vary in width between 1–5 mm 	Maritime limit in general  usually implying permanent physical obstructions (tint band for emphasis)					Caution area, a specific caution note applies
1.2		usually implying no permanent physical obstructions (tint band for emphasis)					
2.1		Limit of restricted area (tint band for emphasis)					Area where entry is prohibited or restricted or to be avoided
2.2		Limit of area into which entry is prohibited					Area where entry is prohibited or restricted or to be avoided, with other cautions
							Area where entry is prohibited or restricted or to be avoided, with other information
<b>Anchorage, Anchorage Areas</b>							
10		Reported anchorage (no defined limits)			 		Anchorage area as a point at small scale, or anchor points of mooring trot at large scale
11.1	  	Anchor berths			  No 1	 Nr 6	Anchor berth
11.2	  	Anchor berths with swinging circle					Radius of swing circle is obtained by cursor pick

\* ECDIS represents many types of area limits with just a few different symbols. Information about the type of area and its associated restrictions or prohibitions may be obtained by cursor pick.

# N Areas, Limits

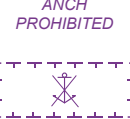
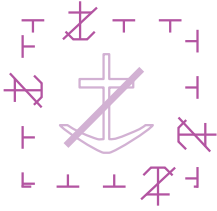
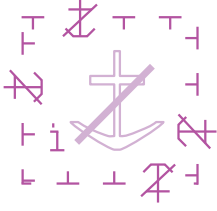

























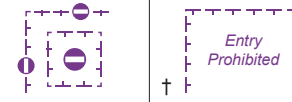

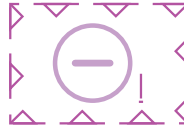
No.	INT	Description	NOAA	NGA	Other NGA	ECDIS
12.1		Anchorage area in general				<p>Type of anchorage area is obtained by cursor pick</p>
12.2		Numbered anchorage area				
12.3		Named anchorage area				
12.4		Deep water anchorage area, Anchorage area for deep draft vessels				
12.5		Tanker anchorage area				
12.6		Anchorage area for periods up to 24 hours				
12.7		Dangerous cargo anchorage area				
12.8		Quarantine anchorage area				
12.9		Reserved anchorage area				
<p>Note: Anchors as part of the limit symbol are not shown for small areas. Other types of anchorage areas may be shown.</p>						
13		Seaplane operating area				<p>Seaplane landing area</p>
14		Anchorage for seaplanes				<p>Type of anchorage area is obtained by cursor pick</p>

No.	INT	Description	NOAA	NGA	Other NGA	ECDIS	Supplementary national symbols: d, e, g
<b>Restricted Areas</b>							
On multi-colored charts, the magenta symbols may be in green when associated with environmental areas.							
20		Anchoring prohibited					Area where anchoring is prohibited or restricted
							Area where anchoring is prohibited or restricted, with other cautions
							Area where anchoring is prohibited or restricted, with other information
21.1		Fishing prohibited					Area where fishing or trawling is prohibited or restricted
							Area where fishing or trawling is prohibited or restricted, with other cautions
							Area where fishing or trawling is prohibited or restricted, with other information

# N Areas, Limits



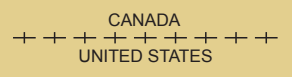



No.	INT	Description	NOAA	NGA	Other NGA	ECDIS	
21.2		Diving prohibited					Area where diving is prohibited
22		Environmentally Sensitive Sea Areas					Environmentally Sensitive Sea Area (ESSA)
		Bird sanctuary					
		Seal sanctuary					Area with minor restrictions or information notices
		Seal sanctuary					
	Note: Other animal silhouettes (e.g. seahorses, penguin, petrel) may be used, as appropriate.						
	Non-specific nature reserve, National parks, Marine Reserves (MR)					PSSA	
	Particularly Sensitive Sea Area (PSSA)						
Tint band may vary in width between 1–5 mm							





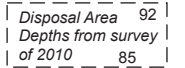

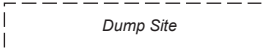

















No.	INT	Description	NOAA	NGA	Other NGA	ECDIS	
23.1		Explosives dumping ground, individual mine or explosive					Explosives or chemical dumping ground as a point
23.2		Explosives dumping ground (disused), Foul (explosives)					Explosives or chemical dumping ground as an area
24		Dumping ground for chemical waste					
25		Degaussing range (DG range)					Degaussing area
27	5kn	Maximum speed					If a speed restriction exists, the speed limit is obtained by cursor pick
<b>Military Practice Areas</b>							
30		Firing practice area					Restricted area
31		Military restricted area, entry prohibited					Area where entry is prohibited or restricted or to be avoided, with other cautions
32		Mine-laying (and counter-measures) practice area					Restricted area
33		Submarine transit lane and exercise area					
34		Minefield					Minefield
<b>International Boundaries and National Limits</b>						Supplementary national symbols: a, f, h	
40		International boundary on land					Jurisdiction boundary

# N Areas, Limits

No.	INT	Description	NOAA	NGA	Other NGA	ECDIS
41		International maritime boundary				
42		Straight territorial sea baseline with base point				
43		Seaward limit of territorial sea				
44		Seaward limit of contiguous zone				
45		Limits of fishery zones				
46		Limit of continental shelf				
47		Limit of Exclusive Economic Zone (EEZ)				
48		Customs limit				
49		Harbor limit				
Various Limits						Supplementary national symbols: a, b
60.1		Limit of fast ice, Ice front (with date)				
60.2		Limit of sea ice (pack ice) seasonal (with date)				
62.1		Spoil ground				
62.2		Spoil ground (disused)				
63		Extraction (dredging) area				
64		Cargo transhipment area				
65		Incineration area				

No.	INT	Description	NOAA	NGA	Other NGA	ECDIS
Supplementary National Symbols						
a		COLREGS demarcation line				
b		Limit of fishing area (fish trap areas)				
c		Dumping ground				
d		Dumping area (Dump site)				
f		Reservation line (Options)				
g		Dump site				
h		Three Nautical Mile Line				
i		No Discharge Zone				

# P Lights

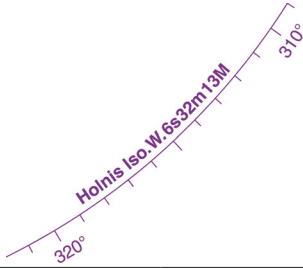
No.	INT	Description	NOAA	NGA	Other NGA	ECDIS
Light Structures and Major Floating Lights						
Minor Light Floats → Q30, 31						
1.1	☆ ★ Lt LtHo	Position of navigation light (size and style of "star" may vary) light, lighthouse		●	☆ ✧ ● ·	 Light, lighthouse, paper chart
1.2		Light on standard charts				
1.3		Significant all-round light, generally for offshore navigation on multicolored charts				
2.1		Lighted offshore platform on standard charts	■ PLATFORM (lighted)			 Lighted offshore platform, paper chart
2.2	 	Lighted offshore platform on multicolored charts				
3	 	Lighted beacon tower	○ Marker (lighted)			 Lighted beacon tower, paper chart
4	  	Lighted beacon				 Lighted beacon, paper chart
5	 	Articulated light, buoyant beacon, resilient beacon	○ Art			
Note: Minor lights, fixed and floating, usually conform to IALA Maritime Buoyage System characteristics.						
7	  	Navigational lights on landmarks or other structures				
8		Important light off chart limits				







No.	Abbreviaton		Class of Light	Illustration	Period Shown	ECDIS
	INT	NOAA				
<b>Light Characters</b>						
Light Characters on Light Buoys → Q						
10.1	F	F	Fixed			F
Occulting (total duration of light longer than total duration of darkness)						
10.2	Oc	Oc	Single-occulting			Oc
	Oc(2) Example	Oc (2)	Group-occulting			Oc (2)
	Oc(2+3) Example	Oc (2+3)	Composite group-occulting			Oc (2+3)
Isophase (duration of light and darkness equal)						
10.3	Iso	Iso	Isophase			Iso
Flashing (total duration of light shorter than total duration of darkness)						
10.4	Fl	Fl	Single-flashing			Fl
	Fl(3) Example	Fl (3)	Group-flashing			Fl (3)
	Fl(2+1) Example	Fl (2+1)	Composite group-flashing			Fl (2+1)
10.5	LFl	L Fl	Long-flashing (flash 2s or longer)			L Fl
Quick (repetition rate of 50 to 79 - usually either 50 or 60 - flashes per minute)						
10.6	Q	Q	Continuous quick			Q
	Q(3) Example	Q (3)	Group quick			Q(3)
	IQ	IQ	Interrupted quick			IQ

When text for lights is displayed, ECDIS uses INT abbreviations.





# P Lights

No.	Abbreviaton		Class of Light	Illustration	Period Shown	ECDIS
	INT	NOAA				
Very quick (repetition rate of 80 to 159 - usually either 100 or 120 - flashes per minute)						
10.7	VQ	VQ	Continuous very quick			
	VQ(3) Example	VQ (3)	Group very quick			
	IVQ	IVQ	Interrupted very quick			
Ultra quick (repetition rate of 160 or more - usually 240 to 300 - flashes per minute)						
10.8	UQ	UQ	Continuous ultra quick			
	IUQ	IUQ	Interrupted ultra quick			
10.9	Mo(K) Example	Mo (K)	Morse code			
10.10	FFI	F FI	Fixed and flashing			
10.11	Al.WR	AlWR	Alternating			

When text for lights is displayed, ECDIS uses INT abbreviations.

No.	INT	Description	NOAA	NGA	Other NGA	ECDIS	
<b>Colors of Lights</b>							
11.1	W	White (for lights, only on sector and alternating lights)		Colors of lights shown on standard charts		 <p>Default light symbol if no color is encoded or color is other than red, green, white, yellow, amber, or orange</p>  <p>Red</p>  <p>Green</p>  <p>White, yellow, amber or orange</p>  <p>Sector lights</p>	
11.2	R	Red					
11.3	G	Green					
11.4	Bu	Blue		on multicolored charts			
11.5	Vi	Violet					
11.6	Y	Yellow		on multicolored charts at sector lights			
11.7	Y	Or	Orange				
11.8	Y	Am	Amber				
<b>Period</b>							
12	2.5s      90s	Period in seconds and tenths of a second				<p>When text for lights is displayed, ECDIS uses INT abbreviations.</p>	
<b>Elevation</b>							
Plane of reference for Heights → H			Tidal Levels → H				
13	12m	Elevation of light given in meters or feet	36ft				
<b>Range</b>							
14	15M	Light with single range					
	15/10M	Light with two different ranges	10M <i>only lesser of two ranges is charted</i>		15/10M		
	15-7M	Light with three or more ranges	7M <i>only least of three ranges is charted</i>				
Note: Charted ranges are nominal ranges given in Nautical Miles.							
<b>Disposition</b>							
15	(hor)	Horizontally disposed				 <p>Disposition of light is obtained by cursor pick</p>	
	(vert)	Vertically disposed					
	(Δ)      (▽)	3 lights disposed in the shape of a triangle					

# P Lights

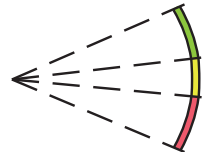
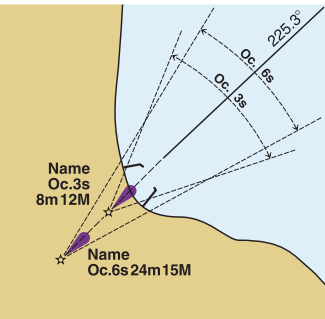
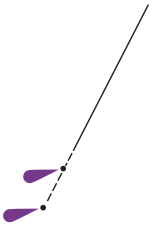
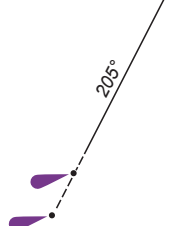
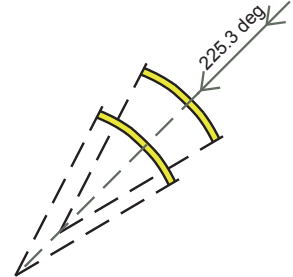



No.	INT	Description	NOAA	NGA	Other NGA	ECDIS	
Example of a Full Light Description							
16	INT Example  Name ☆ FI(3)WRG.15s 21m 15-11M		NOAA Example  Name ☆ FI (3) WRG 15s 21ft 11M		NGA Example  Name ☆ FI (3) WRG 15s 21m 15-11M		 FIR15s21m11M
	FI(3)	Class of light: group flashing repeating a group of three flashes	FI(3)	Class of light: group flashing repeating a group of three flashes	The descriptions of non-sector lights are shown in ECDIS when the display of text is turned on, as shown above. (The aid to navigation or other structure that is always shown attached to a light flare in ECDIS is not depicted here.)		
	WRG	Colors: white, red, green, exhibiting the different colors in defined sections	WRG	Colors: white, red, green, exhibiting the different colors in defined sections	Sector lights (as described in the INT, NOAA and NGA examples at left) are depicted graphically in ECDIS, as shown below and in P40.		
	15s	Period: the time taken to exhibit one full sequence of three flashes and eclipses: 15 seconds	15s	Period: the time taken to exhibit one full sequence of three flashes and eclipses: 15 seconds	 The description of a sector light or any other type of light may always be obtained by cursor pick.		
	21m	Elevation of focal plane above datum: 21 meters	21ft 21m	Elevation of light: 21 feet 21 meters			
	15-11M	Nominal range: white 15M, green 11M, red between 15 and 11M	11M 15-11M	Nominal range: shortest range of all the lights is 11M white 15M, green 11M, red between 15 and 11M			
Lights Marking Fairways							
Leading Lights and Lights in Line							
20.1		<p>Leading lights with leading line (solid line is the track to be followed) and arcs of visibility on standard charts</p> <p>Bearing given in degrees and tenths of a degree</p>				<p>Leading lights with sectors</p> 	

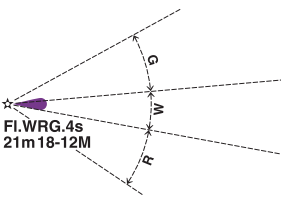

No.	INT	Description	NOAA	NGA	Other NGA	ECDIS
20.2		<p>Leading lights with leading line (solid line is the track to be followed) and arcs of visibility on multi-colored charts</p> <p>Bearing given in degrees and tenths of a degree</p>				
20.3		<p>Leading lights (≠ means lights in line) on standard charts</p> <p>Bearing given in degrees and tenths of a degree</p>				<p>Leading lights</p>
20.4		<p>Leading lights (≠ means lights in line) on multi-colored charts</p> <p>Bearing given in degrees and tenths of a degree</p>				
20.5		<p>Leading lights on small scale standard charts</p>				
20.6		<p>Leading lights on small scale multi-colored charts</p>				
21.1		<p>Lights in line, marking the sides of a channel on standard charts</p>				<p>Lights in line, marking the sides of a channel</p>
21.2		<p>Lights in line, marking the sides of a channel on multi-colored charts</p>				
22	Rear Lt or Upper Lt	Rear or upper light				
23	Front Lt or Lower Lt	Front or lower light				

# P Lights

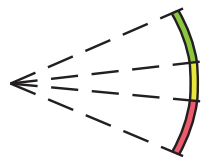
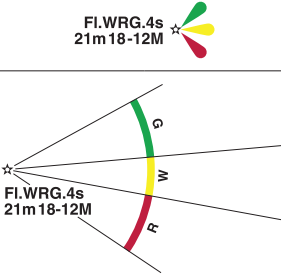
No.	INT	Description	NOAA	NGA	Other NGA	ECDIS
Direction Lights						
30.1		Direction light with narrow sector and course to be followed, flanked by darkness or unintensified light				<p>Directional light with sector</p>
30.2		Direction light on standard charts with course to be followed, sector(s) uncharted				<p>Directional light without sector</p>
30.3		Direction light with narrow fairway sector flanked by light sectors of different character on standard charts				<p>Light, directional</p>
30.4		Direction light with narrow fairway sector flanked by light sectors of different character on multicolored charts				
31		Moiré effect light (day and night), arrows show when course alteration needed				<p>Category of light as moiré effect is obtained by cursor pick</p>
Quoted bearings are always from seaward.						

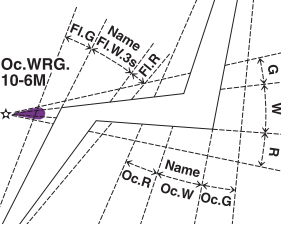
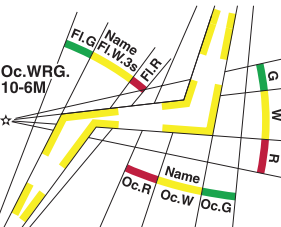











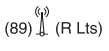



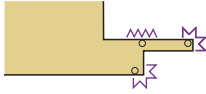

No.	INT	Description	NOAA	NGA	Other NGA	ECDIS
Sector Lights						
40.1		Sector light on standard charts				 Light, sector
40.2		Sector light on multicolored charts				
40.3		Sector light on standard charts. Sectors not charted				
40.4		Sector lights on multicolored charts. Sectors not charted				
41.1		Sector lights on standard charts, the white sector limits marking the sides of the fairway				
41.2		Sector lights on multicolored charts, the white sector limits marking the sides of the fairway				

# P Lights

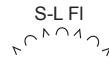
No.	INT	Description	NOAA	NGA	Other NGA	ECDIS
42.1	<p>FI(3)10s62m25M F.R.55m12M</p>	Main light visible all-round with red subsidiary light seen over danger				<p>Light, danger</p>
43.1	<p>Fl.5s41m30M</p>	All-round light with obscured sector				<p>Light, obscured</p>
44.1	<p>Iso.WRG</p>	Light with arc of visibility deliberately restricted				<p>Light, restricted</p>

No.	INT	Description	NOAA	NGA	Other NGA	ECDIS	
45.1		Light with faint sector					Light, faint
46.1		Light with intensified sector					Intensified light visibility is obtained by cursor pick
							Light, intensified
Lights with Limited Times of Exhibition							
50		Lights exhibited only when specially needed (for fishing vessels, ferries) and some private lights	Occas				Status and condition of light is obtained by cursor pick
51		Daytime light (charted only where the character shown by day differs from that shown at night)					
52		Fog light (exhibited only in fog, or character changes in fog)					
53		Unwatched (unmanned) light with no standby or emergency arrangements					
54	(temp)	Temporary					
55	(exting)	Extinguished					
56	(man)	Manually activated					
Special Lights							
Flare Stack (as sea) → L		Flare Stack (on land) → E		Signal Stations → T			
60		Aero light (may be unreliable)					AeroAIFIWG7.5s11M Light

# P Lights

No.	INT	Description	NOAA	NGA	Other NGA	ECDIS	
61.1		Air obstruction light of high intensity (e.g. on radio mast)					Conspicuous mast with light
61.2		Air obstruction light of low intensity (e.g. on radio mast)					
62	Fog Det Lt	Fog detector light					Category of light is obtained by cursor pick
63	 (Illuminated)	Floodlit, floodlighting of a structure					Floodlight
64		Strip light					Strip light
On multicolored charts, P63 and P64 may be any appropriate color.							
65	(priv)	Private light other than one exhibited occasionally					Status of private is obtained by cursor pick
66	(sync)	Synchronized light					
Supplementary National Symbols							
a		Riprap surrounding light					
b		Short-Long Flashing					
c		Group-Short Flashing					
d		Fixed and Group Flashing					
e		Unmanned light-vessel; light float					
f		LANBY, superbuoy as navigational aid					



# Simplified and Traditional Paper Chart Symbols

ECDIS can be set to display aids to navigation with either traditional paper chart or simplified symbols. The two symbol sets are shown below. Some ECDIS color fill the paper chart buoy shapes, but this is not required by IHO ECDIS portrayal specifications.

## Floating Marks

Paper Chart	Simplified	Simplified Symbol Name
* ▲		Cardinal buoy, north
* ◆		Cardinal buoy, east
* ▼		Cardinal buoy, south
* ▾		Cardinal buoy, west
○?		Default symbol for buoy (used when no defining attributes have been encoded in the ENC)
* ●		Isolated danger buoy
		Conical lateral buoy, green
		Conical lateral buoy, red
		Can shape lateral buoy, green
		Can shape lateral buoy, red
		Installation buoy and mooring buoy
**		Safe water buoy
		Special purpose buoy, spherical or barrel shaped, or default symbol for special purpose buoy
		Special purpose TSS buoy marking the starboard side of the traffic lane
		Special purpose TSS buoy marking the port side of the traffic lane
		Special purpose ice buoy or spar or pillar shaped buoy
		Super-buoy ODAS & LANBY
		Light float
		Light vessel

## Fixed Marks

Paper Chart	Simplified	Simplified Symbol Name
* ▲		Cardinal beacon, north
* ◆		Cardinal beacon, east
* ▼		Cardinal beacon, south
* ▾		Cardinal beacon, west
↓?		Default symbol for a beacon (used when no defining attributes have been encoded in the ENC)
⊥		Isolated danger beacon
		Major lateral beacon, red
⊥		Major lateral beacon, green
		Minor lateral beacon, green
⊖		Major safe water beacon
		Minor safe water beacon
⊖		Major special purpose beacon
		Minor special purpose beacon







\* Paper chart symbols display various buoy or beacon shape symbols in conjunction with the topmark. Simplified portrayal only displays the topmark.

\*\* Several different paper chart symbols correspond to this simplified symbol.





## Day Marks

Paper Chart	Simplified	Simplified Symbol Name
		Square or rectangular daymark
		Triangular daymark, point up
		Triangular daymark, point down
≡		Retro reflector





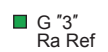













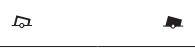















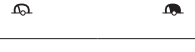











# Q Buoy, Beacons

No.	INT	Description	NOAA	NGA	Other NGA	ECDIS
Buoy and Beacons						
IALA Maritime Buoyage System, which includes Beacons → Q 130						
		Default buoy symbol if no other defining attribution is provided				 ? Default symbol for buoy, paper chart
		Default buoy symbol if no other defining attribution is provided				 ? Default symbol for buoy, simplified
		Default beacon symbol if no other defining attribution is provided				 ? Default symbol for a beacon, paper chart
		Default beacon symbol if no other defining attribution is provided				 ? Default symbol for a beacon, simplified
1		Position of buoy or beacon				ECDIS shows the position of buoys and beacons with a circle at the bottom of paper chart symbols. For simplified symbols, the position of the aid corresponds with the center of the symbol.
Colors of Buoys and Beacon Topmarks						Supplementary national symbols: p
Abbreviations for Colors → P						
2		Green and black (symbols filled black)				
3		Single color other than green and black				
4		Multiple colors in horizontal bands, the color sequence is from top to bottom				
5		Multiple colors in vertical or diagonal stripes, the darker color is given first				
6		Retroreflecting material				
Lighted Marks						Supplementary national symbols: p
Marks with Fog Signals → R						
7		Lighted marks on standard charts				
8		Lighted marks on multicolored charts				
Note: On standard charts, the light flares of buoys and beacons are shown in magenta. On multicolored charts, the light flares are shown in the colors of the appropriate light						



















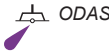

No.	INT	Description	NOAA	NGA	Other NGA	ECDIS																																													
<b>Topmarks and Radar Reflectors</b>																																																			
For Application of Topmarks within the IALA System → Q 130			For other topmarks (special purpose buoys and beacons) → Q																																																
9		IALA System buoy topmarks (beacon topmarks shown upright)				<p>Paper chart symbols for topmarks (on the left, below) are always displayed above a buoy or beacon shape symbol, as in Q 10 and Q 11.</p> <p>Simplified symbols (on the right, below) for cardinal marks, isolated dangers and safe water consist of only the topmark without the buoy shape symbol.</p> <p>Simplified symbology for marks with any other type of topmark will display only the simplified buoy or beacon shape symbol without a topmark.</p> <table border="1" style="width: 100%; border-collapse: collapse;"> <tr> <td style="text-align: center;"></td> <td style="text-align: center;"></td> <td>2 cones point upward</td> </tr> <tr> <td style="text-align: center;"></td> <td style="text-align: center;"></td> <td>2 cones point downward</td> </tr> <tr> <td style="text-align: center;"></td> <td style="text-align: center;"></td> <td>2 cones base to base</td> </tr> <tr> <td style="text-align: center;"></td> <td style="text-align: center;"></td> <td>2 cones point to point</td> </tr> <tr> <td style="text-align: center;"></td> <td style="text-align: center;"></td> <td>2 spheres</td> </tr> <tr> <td style="text-align: center;"></td> <td style="text-align: center;"></td> <td>Sphere</td> </tr> <tr> <td style="text-align: center;"></td> <td></td> <td>Cone point up</td> </tr> <tr> <td style="text-align: center;"></td> <td></td> <td>Cone point down</td> </tr> <tr> <td style="text-align: center;"></td> <td></td> <td>Cylinder, square, vertical rectangle</td> </tr> <tr> <td style="text-align: center;"></td> <td></td> <td>X-shape</td> </tr> <tr> <td style="text-align: center;"></td> <td></td> <td>Flag or other shape</td> </tr> <tr> <td style="text-align: center;"></td> <td></td> <td>Board, horizontal rectangle</td> </tr> <tr> <td style="text-align: center;"></td> <td></td> <td>Cube point up</td> </tr> <tr> <td style="text-align: center;"></td> <td></td> <td>Upright cross over a circle</td> </tr> <tr> <td style="text-align: center;"></td> <td></td> <td>T-shape</td> </tr> </table>			2 cones point upward			2 cones point downward			2 cones base to base			2 cones point to point			2 spheres			Sphere			Cone point up			Cone point down			Cylinder, square, vertical rectangle			X-shape			Flag or other shape			Board, horizontal rectangle			Cube point up			Upright cross over a circle			T-shape
		2 cones point upward																																																	
		2 cones point downward																																																	
		2 cones base to base																																																	
		2 cones point to point																																																	
		2 spheres																																																	
		Sphere																																																	
		Cone point up																																																	
		Cone point down																																																	
		Cylinder, square, vertical rectangle																																																	
		X-shape																																																	
		Flag or other shape																																																	
		Board, horizontal rectangle																																																	
		Cube point up																																																	
		Upright cross over a circle																																																	
		T-shape																																																	
10		Beacon with topmark, color, radar reflector and designation				bn No 2  Beacon in general with topmark, paper chart																																													













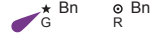







# Q Buoys, Beacons

No.	INT	Description	NOAA	NGA	Other NGA	ECDIS		
11		Buoy with topmark, color, radar reflector and designation				by No 3 	Conical buoy with topmark, paper chart	
Note: Radar reflectors on floating marks usually are not charted. ECDIS does not display radar reflectors on fixed or floating aids; this information is obtained by cursor pick.								
Buoys								
Shapes of Buoys								
Features Common to Buoys and Beacons → Q 1–11								
						Paper Chart	Simplified	
20		Conical buoy, nun buoy, ogival buoy						Conical buoy
21		Can buoy or cylindrical buoy						Can buoy
22		Spherical buoy						Spherical buoy
23		Pillar buoy; Buoy with no distinctive shape						Pillar buoy
24		Spar buoy, spindle buoy						Spar buoy
25		Barrel buoy, tun buoy						Barrel buoy
26		Superbuoy						Super-buoy Lanby, super-buoy Super-buoy odas & lanby
†								
Light Vessels and Minor Light Floats								
30.1		Light float on standard charts						Light float
30.2								
31		Light float not part of IALA System						Light float
†								
32		Light vessel						Light vessel, paper chart
Mooring Buoys								

No.	INT	Description	NOAA	NGA	Other NGA	ECDIS
Oil or Gas Installation Buoy → L						
40		Mooring buoys				 Mooring buoy, can shape, paper chart Mooring buoy, barrel shape, paper chart Installation buoy and mooring buoy, simplified
41.1		Lighted mooring buoy (example) on standard charts				 Mooring buoy with light flare, barrel shape, paper chart
41.2		Lighted mooring buoy (example) on multi-colored charts				
42		Trot, mooring buoys with ground tackle and berth numbers				 Trot, mooring buoys with ground tackle and berth numbers
43		Mooring buoy with telephonic communication		 Tel = telegraphic  T = telephonic		 Mooring buoy, can shape, paper chart Mooring buoy, barrel shape, paper chart Installation buoy and mooring buoy, simplified
44		Numerous moorings (example)				 Small-craft mooring area
45		Visitors' mooring				 Availability of visitor mooring at marina is obtained by cursor pick
<b>Special Purpose Buoys</b>						
Note: Shapes of buoys are variable. Lateral or Cardinal buoys may be used in some situations.						
						 Purpose of buoy and other information is obtained by cursor pick













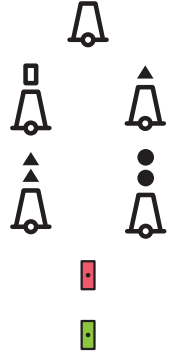

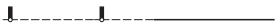

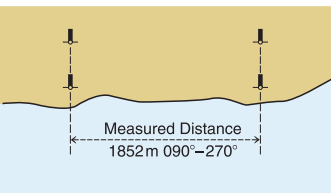
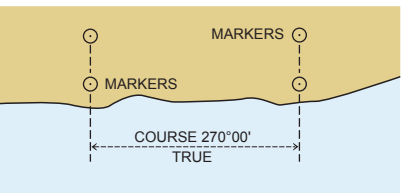
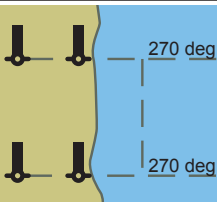

# Q Buoy, Beacons

No.	INT	Description	NOAA	NGA	Other NGA	ECDIS
Purpose of buoy may be shown by label.						
50		Firing danger area (Danger Zone) buoy				 Conical buoy with topmark, paper chart
54		Degaussing Range buoy				 Special purpose buoy, spherical or barrel shaped, or default symbol for special purpose buoy, simplified
58	 	ODAS buoy (Ocean Data Acquisition System), data collecting buoy	 			 Super-buoy, paper chart  Super-buoy odas & lanby, simplified  Spherical buoy, paper chart  Spherical buoy, simplified
70		Buoy privately maintained (example)			 	 Status as private is obtained by cursor pick
71		Seasonal buoy (example)				 Status as periodic and period start and stop dates are obtained by cursor pick

No.	INT	Description	NOAA	NGA	Other NGA	ECDIS	
Beacons							
Lighted Beacons → P      Features Common to Beacons and Buoys → Q1–11							
80		Beacon in general, characteristics unknown or chart scale too small to show				  	<p>Default symbol for a beacon, paper chart</p> <p>Default symbol for a beacon, simplified</p> <p>Beacon in general, paper chart</p>
81		Beacon with color, no distinctive topmark				 Beacon color is obtained by cursor pick	
82		Beacons with colors and topmarks (examples)				 Beacon color is obtained by cursor pick See note at Q 9 for information about topmarks and ECDIS simplified symbology      	<p>Beacon in general with topmark, paper chart</p> <p>Major red lateral beacon, simplified</p> <p>Beacon in general with topmark, paper chart</p> <p>Cardinal beacon, north, simplified</p> <p>Beacon in general with topmark, paper chart</p> <p>Isolated danger beacon, simplified</p>
83		Beacon on submerged rock with colors (topmark as appropriate)				 	<p>Beacon in general with topmark, paper chart</p> <p>Isolated danger beacon, simplified</p>

# Q Buoys, Beacons







No.	INT	Description	NOAA	NGA	Other NGA	ECDIS
Minor Impermanent Marks Usually in Drying Areas (Lateral Marks of Minor Channels)						
Minor Pile → F						
90		Stake, pole	† ○ Stake ● Stake † ○ Pole ● Pole			Minor, stake or pole beacon, paper chart
91	Port Hand 	Perch, withy				Minor, stake or pole beacon, paper chart
	Starboard Hand 					Minor red lateral beacon, simplified
92		Withy				Minor green lateral beacon, simplified
Minor Marks, Usually on Land						
Landmarks → E						
100		Cairn	○ Cairn ○ CAIRN			Conspicuous cairn
101		Colored or white mark				Square or rectangular day mark, paper chart
						Square or rectangular day mark, simplified
						Triangular day mark, point up, paper chart
						Triangular day mark, point up, simplified
						Triangular day mark, point down, paper chart
Triangular day mark, point down, simplified						
102.1		Colored topmark (color known or unknown) with function of a beacon				
102.2		Painted boards with function of leading beacons				

No.	INT	Description	NOAA	NGA	Other NGA	ECDIS	
<b>Beacon Towers</b>							
110		Beacon towers without and with topmarks and colors (examples)					<p>Beacon tower, paper chart</p> <p>Beacon tower with topmarks, paper chart</p> <p>Major red lateral beacon, simplified</p> <p>Major green lateral beacon, simplified</p>
111		Lattice beacon					Lattice beacon, paper chart
<b>Special Purpose Beacons</b>							
Leading Lines, Clearing Lines → M							
Note: Topmarks and colors shown where scale permits.							
120		Leading beacons					Leading beacons
121		Beacons marking a clearing line					Beacons marking a clearing line or transit
122		Beacons marking measured distance with quoted bearings					Beacons marking measured distance
123		Cable landing beacon (example)					Cable landing beacon (example)
124		Refuge beacon					Purpose as refuge or firing danger area beacon is obtained by cursor pick
126		Notice board					Notice board

# Q Buoy, Beacons



## IALA Maritime Buoyage System

IALA International Association of Marine Aids to Navigation and Lighthouse Authorities

Where in force, the IALA System applies to all fixed and floating marks except landfall lights, leading lights and marks, sectored lights and major floating lights. The standard buoy shapes are: cylindrical (can) , conical , spherical , pillar , and spar , but variations may occur, for example: minor light floats .

130

There are two international buoyage regions where lateral marks differ. Each region is primarily comprised of the waters surrounding the areas shown below.

-  **Region A:** Greenland, Africa, Europe, Australia and Asia (except for Japan, the Republic of Korea, Taiwan and the Philippines).
-  **Region B:** North and South America, Japan, the Republic of Korea, Taiwan and the Philippines.

ECDIS marks the boundary between IALA regions A and B with this symbol: 

130.1

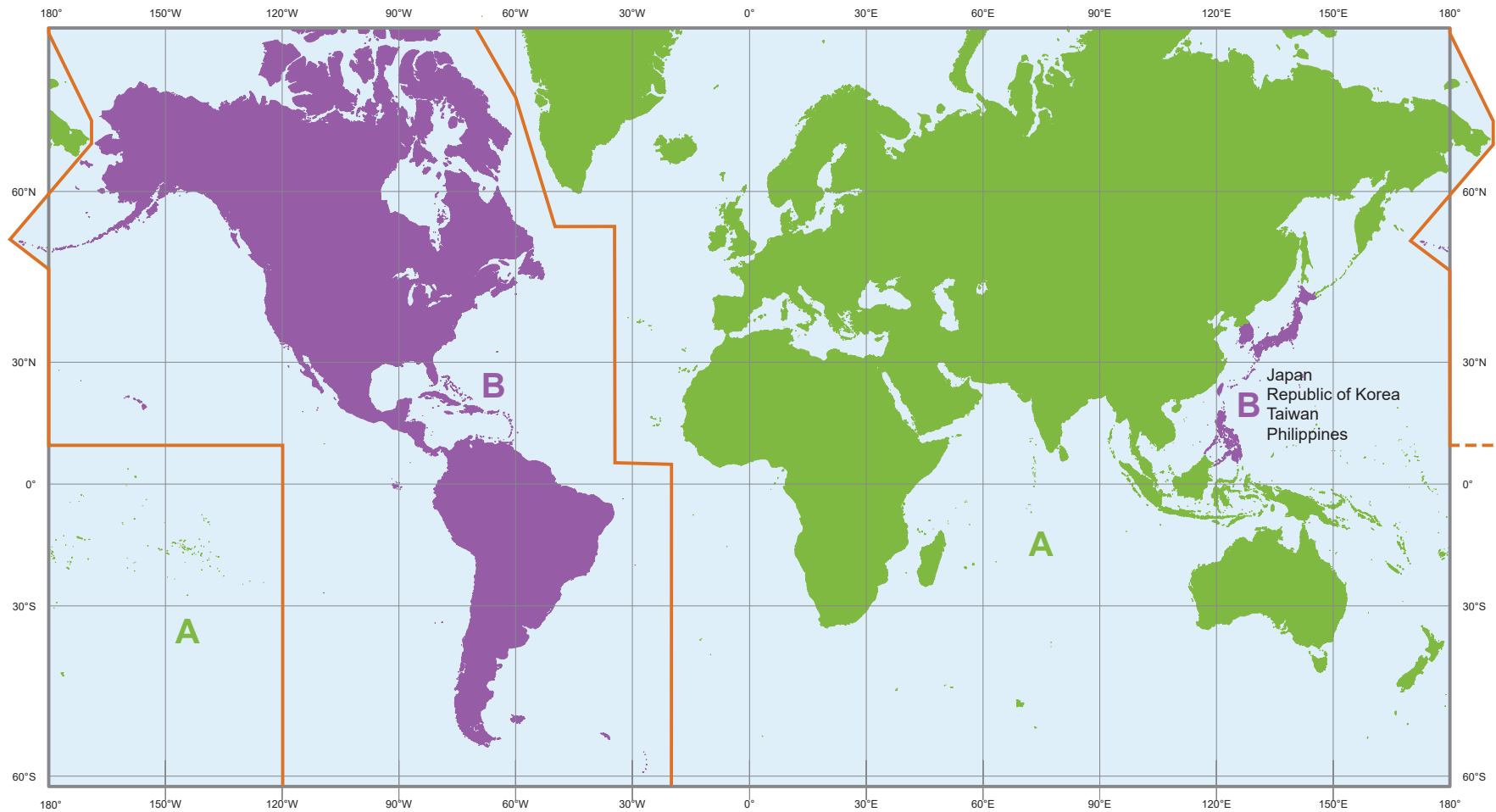





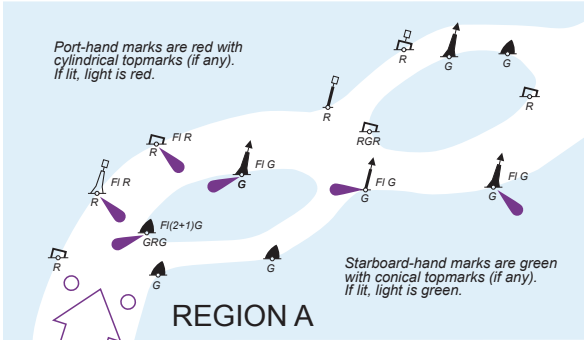
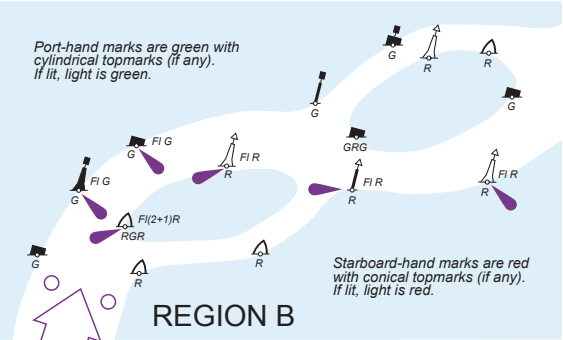
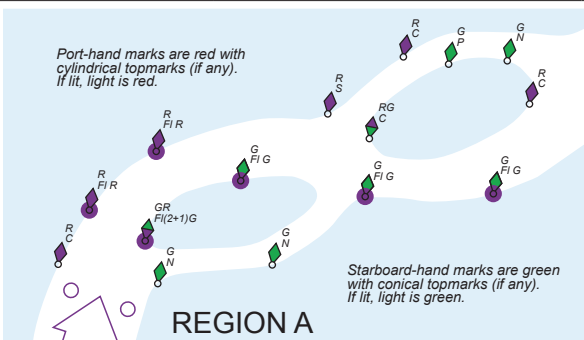
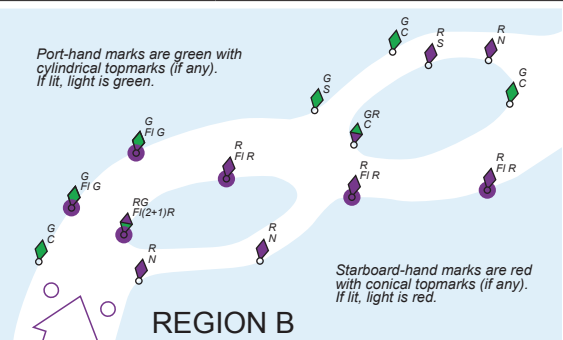





**Lateral Marks** are generally for well-defined channels. There are two international buoyage regions—A and B—where lateral marks differ by color, but not by shape or topmark.







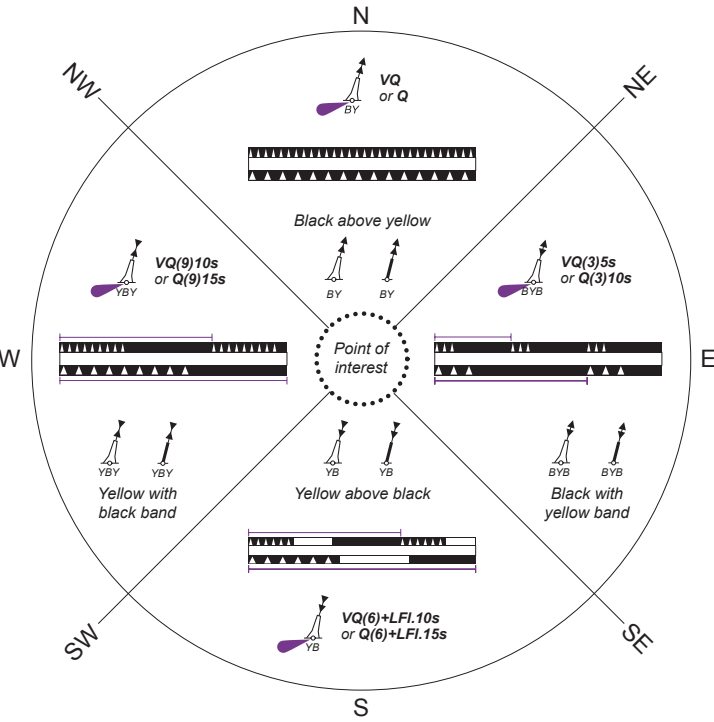

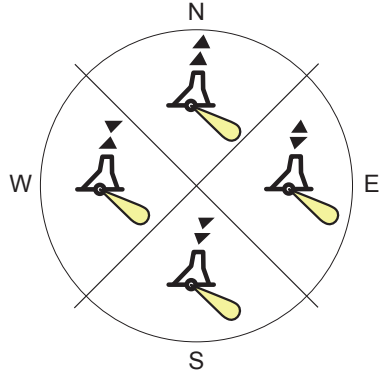
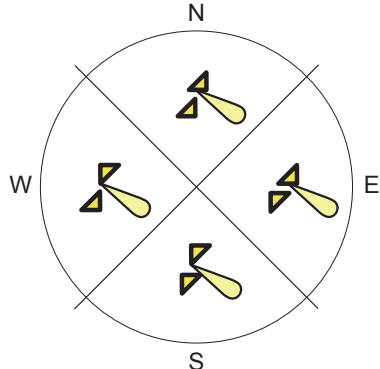















130.1	INT	 <p>Port-hand marks are red with cylindrical topmarks (if any). If lit, light is red.</p> <p>Starboard-hand marks are green with conical topmarks (if any). If lit, light is green.</p> <p>REGION A</p>	 <p>Port-hand marks are green with cylindrical topmarks (if any). If lit, light is green.</p> <p>Starboard-hand marks are red with conical topmarks (if any). If lit, light is red.</p> <p>REGION B</p>	<p>Buoy shape may be cylindrical or conical (to indicate port or starboard) but may be another shape with appropriate topmark. Marks which indicate a junction with a side channel have three horizontal color bands and, if lit, the rhythm will be FI(2+1).</p> <p>Buoys in U.S. waters generally do not have topmarks.</p>
	NOAA	 <p>Port-hand marks are red with cylindrical topmarks (if any). If lit, light is red.</p> <p>Starboard-hand marks are green with conical topmarks (if any). If lit, light is green.</p> <p>REGION A</p>	 <p>Port-hand marks are green with cylindrical topmarks (if any). If lit, light is green.</p> <p>Starboard-hand marks are red with conical topmarks (if any). If lit, light is red.</p> <p>REGION B</p>	

Direction of Buoyage: The direction of buoyage is that taken when approaching a harbor from seaward. Along coasts, the direction is determined by buoyage authorities, normally clockwise around land masses.































130.2	INT	Symbols showing direction of buoyage where it is not obvious		
		 <p>General symbol for direction of buoyage</p>	 <p>IALA Region A on multicolored charts</p>	 <p>IALA Region B on multicolored charts</p>
ECDIS	 <p>General symbol for direction of buoyage</p>	 <p>IALA Region A</p>	 <p>IALA Region B</p>	

# Q Buoy, Beacons

No.	INT	ECDIS
130.3	<p data-bbox="206 278 1381 304">Cardinal Marks: indicating navigable water to the named side of the marks. In the illustration below all marks are the same in Regions A and B.</p>  <p data-bbox="1062 579 1263 601">Topmark: 2 black cones</p> <p data-bbox="1062 611 1166 633">Light: White</p> <p data-bbox="1062 656 1444 702">The same abbreviations are used for lights on spar buoys and beacons.</p> <p data-bbox="1062 712 1440 757">The periods 5s, 10s, and 15s may not always be charted.</p> <p data-bbox="1062 808 1446 856">Time (seconds) 0 5 10 15 Period shown </p> <p data-bbox="1062 883 1455 950">Cardinal marks are seldom used in U.S. waters and do not appear on NOAA charts, except for charts that also depict Canadian waters.</p>	 <p data-bbox="1634 712 1828 734">Paper chart symbology</p>  <p data-bbox="1640 1182 1819 1204">Simplified symbology</p>

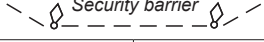



















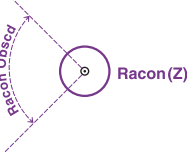

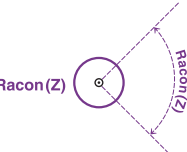
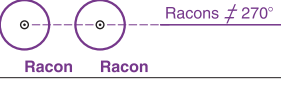

No.	INT	Description	NOAA	NGA	Other NGA	ECDIS	
130.4	<b>Isolated Danger Marks</b> stationed over dangers with navigable water around them. Body: black with red horizontal band(s) Topmark: two black spheres Light: white						
	  FI (2)  FI (2)	Unlit Marks				  	Pillar buoy with 2 spheres topmark  Spar buoy with 2 spheres topmark  Isolated danger buoy, simplified
130.5	<b>Safe Water Marks</b> , including mid-channel and landfall marks. Body: red and white vertical stripes Topmark (if any): red sphere Light: white						
	   <i>ISO or Oc or LFl.10s or Mo (A)</i>	Unlit marks				   	Spherical buoy, paper chart  Pillar buoy with sphere topmark  Spar buoy with sphere topmark  Safe water buoy, simplified
130.6	<b>Special Marks</b> not primarily to assist navigation but to indicate special features. Body (shape optional): yellow* Topmark (if any): yellow X or upright cross Light: yellow, rhythm optional*						
	   <i>FI Y</i>	Unlit Marks				    	Spherical buoy, paper chart  Can buoy  Conical buoy  Spar buoy with x-shape topmark  Special purpose buoy, simplified
130.7	<b>New Danger Marks.</b> Body (shape optional): yellow and blue Topmark: yellow cross						
	  	Unlit marks					
* In special cases, yellow may be used in conjunction with another color							

























# Q Buoys, Beacons

No.	INT	Description	NOAA	NGA	Other NGA	ECDIS
Supplementary National Symbols						
a		Bell buoy	 BELL	 BELL		
b		Gong buoy	 GONG	 GONG		
c		Whistle buoy	 WHIS	 WHIS		
d		Fairway buoy (red and white vertical stripe)	 RW			
e		Mid-channel buoy (red and white vertical stripe)	 RW			
f		Starboard-hand buoy (entering from seaward - US waters)	 R "2"			
g		Port-hand buoy (entering from seaward - US waters)	 G "1"  "1"			
h		Bifurcation/Junction buoys	 RG  GR			
		Isolated danger, Wreck or Obstruction buoy	 BR			
i		Fish trap (area) buoy	 Y			
j		Anchorage buoy (marks limits)	 Y			
l		Triangular shaped beacons	 R  RG Bn			
		Square shaped beacons	 G  GR Bn  W Bn  B Bn			
		Beacon, color unknown	 Bn			
o		Lighted beacon	 !	 !	 ! Bn  !	
q		Security barrier	 Security barrier			
r		Scientific mooring buoy	 !			
s		Float (unlighted)	 !			
t		White and blue buoy		 WBUW		





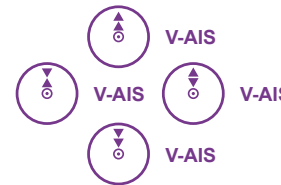



No.	INT	Description	NOAA	NGA	Other NGA	ECDIS				
<b>General</b>										
Fog Detector Light → P		Fog Light → P								
1		Position of fog signal, type of fog signal not stated	Fog Sig			<p>Position of a conspicuous point feature with fog signal</p> <p>Lighted pillar buoy, paper chart with fog signal</p> <p>Lighted super-buoy, paper chart with fog signal</p>				
2	(man)	Manually activated								
<b>Types of Fog Signals, with Abbreviations</b>						Supplementary national symbol: a				
10	Explos	Explosive	<i>GUN</i>			<p>Type of fog signal and its characteristics are obtained by cursor pick</p>				
11	Dia	Diaphone	<i>DIA</i>							
12	Siren	Siren	<i>SIREN</i>							
13	Horn	Horn (nautophone, reed, tyfon)	<i>HORN</i>							
14	Bell	Bell	<i>BELL</i>							
15	Whis	Whistle	<i>WHISTLE</i>							
16	Gong	Gong	<i>GONG</i>							
<b>Examples of Fog Signal Descriptions</b>										
Note: The fog signal symbol will usually be omitted when a description of the signal is given.										
20	<p>Fl.3s 70m 29M Siren Mo(N)60s</p>	Siren at a lighthouse, giving a long blast followed by a short one (N), repeated every 60 seconds	<p>Fl 3s 70m 29M SIREN Mo(N) 60s</p>	<p>Fl 3s 70m 29M SIREN</p>		<p>Light with fog signal</p>				
21	<p>Bell</p>	Wave-actuated bell buoy	<p>BELL</p>	<p>BELL</p>		<p>Pillar buoy, paper chart with fog signal</p>				
22	<p>Q(6)+LFl.15s Yb Horn(1)15sWhis</p>	Light buoy, with horn giving a single blast every 15 seconds, in conjunction with a wave-actuated whistle	<p>Q(6)+LFl 15s HORN(1) 15s WHIS</p>	<p>Q(6)+LFl 15s HORN WHIS</p>	<table border="1" style="width: 100%; border-collapse: collapse;"> <tr> <td style="text-align: center;">Paper Chart</td> <td style="text-align: center;">Simplified</td> </tr> <tr> <td style="text-align: center;"> </td> <td style="text-align: center;"> </td> </tr> </table>	Paper Chart	Simplified			<p>Lighted pillar buoy, paper chart with fog signal</p>
Paper Chart	Simplified									
<b>Supplementary National Symbol</b>										
a		Morse Code fog signal	<i>Mo</i>							

# S Radar, Radio, Satellite Navigation Systems

No.	INT	Description	NOAA	NGA	Other NGA	ECDIS		
Radar								
Radar Structures Forming Landmarks → E				Radar Surveillance Systems → M				
1	 Ra	Coast radar station, providing range and bearing service on request		 Ra			Radio station	
2	 Ramark	Ramark, radar beacon transmitting continuously		 Ramark				
3.1	 Racon(Z)(3cm)	Radar transponder beacon, with morse identification, responding within the 3 cm (X) band	†	 RACON				
3.2	 Racon(Z)(10cm)	Radar transponder beacon, with morse identification, responding within the 10 cm (S) band						
3.3	 Racon(Z)	Radar transponder beacon, with morse identification			 Racon(Z) (3 & 10 cm)			
3.4	 Racon(Z)	Radar transponder beacon with sector of obscured reception					Radar transponder beacon	
	 Racon(Z)	Radar transponder beacon with sector of reception						
3.5	 Racons ≠ 270°	Leading radar transponder beacons (‡: objects in line)						
	 Racons ≠ 270° Lts ≠ 270°	Leading radar transponder beacons coincident with leading lights						
3.6	 Racon	Radar transponder beacons on floating marks	 RACON (-) R "2" FIR 4s	 Racon		Paper Chart 	Simplified 	Radar transponder on floating mark
4		Radar reflector						
Radar reflectors are not charted on buoys in regions where they are fitted to nearly all buoys							Symbol indicating this object is radar conspicuous	
5		Radar conspicuous feature						

No.	INT	Description	NOAA	NGA	Other NGA	ECDIS
Radio						
Radio Structures Forming Landmarks → E			Radio Reporting (Calling-in or Way) points → M			
10	†	 <b>Name RC</b>	Circular (non-directional) marine or aeromarine radiobeacon	†  RC	†  R Bn	
11	†	 RD	Directional radiobeacon with bearing line	†  RD		
	†	 RD	Directional radiobeacon coincident with leading lights			
12	†	 <b>RW</b>	Rotating pattern radiobeacon	†  RW		 Radio station  Additional information regarding radio, such as category of radio station, signal frequency, communication channel, call sign, estimated signal range, periodicity and status may be included in the cursor pick.  The presence of an AIS transmitted signal intended for use as an aid to navigation associated with a physical aid, including the AIS MMSI Number, can be obtained by cursor pick on the physical aid.
13	†	 <b>Consol</b>	Consol beacon	†  CONSOL Bn 190 kHz MMF	†  CONSOL	
14		 <b>RG</b>	Radio direction-finding station		 RDF	
15	†	 <b>R</b>	Coast radio station providing QTG service	†  R Sta	†  R	
16	†	 <b>Aero RC</b>	Aeronautical radiobeacon	†  AERO R Bn		
17.1		 <b>AIS</b>	Automatic Identification System transmitter			
17.2		 AIS	Automatic Identification System transmitter on floating marks (examples)			
18.1		 <b>V-AIS</b>	Virtual AIS (with unknown IALA-defined function)			
18.2		 V-AIS	Virtual AIS (with known IALA-defined function)			 V-AIS North cardinal virtual aid























# S Radar, Radio, Satellite Navigation Systems

No.	INT	Description	NOAA	NGA	Other NGA	ECDIS	
18.3	 V-AIS  V-AIS	Virtual AIS with lateral mark function					
18.4	 V-AIS	Virtual AIS with isolated danger mark function					
18.5	 V-AIS	Virtual AIS with safe water mark function					
18.6	 V-AIS	Virtual AIS with special purpose mark function					
18.7	 V-AIS	Virtual AIS with new danger mark function					
<b>Satellite Navigation Systems</b>							
50	WGS WGS72 WGS84	World Geodetic System, 1972 or 1984					
Note: A note may be shown to indicate the shifts of latitude and longitude, to one, two or three decimal places of a minute, depending on the chart scale, which should be made to satellite-derived positions (which are referred to WGS 84) to relate them to the chart.							
51	 DGPS	Station providing DGPS corrections				 DGPS	DGPS reference station



No.	INT	Description	NOAA	NGA	Other NGA	ECDIS
<b>Pilotage</b>						
1.1		Boarding place, position of a pilot cruising vessel	<i>Pilots</i>			
1.2	<i>Name</i>	Boarding place, position of a pilot cruising vessel, with name (e.g. District, Port)		<i>Name</i>		
1.3	<i>Note</i>	Boarding place, position of a pilot cruising vessel, with note (e.g. Tanker, Disembarkation)		(see note)		
1.4	<i>H</i>	Pilots transferred by helicopter				
2		Pilot office with pilot lookout, Pilot lookout station				
3		Pilot office	PIL STA			
4	<i>Port name (Pilots)</i>	Port with pilotage service (boarding place not shown)				
<b>Coast Guard, Rescue</b>						
10		Coast Guard station				
11		Coast Guard station with Rescue station				
12		Rescue station, Lifeboat station, Rocket station				
13		Lifeboat lying at a mooring				
14		Refuge for shipwrecked mariners				
<b>Signal Stations</b>						
20		Signal station in general	SS	Sig Sta		
21		Signal station, showing international port traffic signals				
22		Traffic signal station, Port entry and departure signals				
23		Port control signal station	HECP			

# T Services

No.	INT	Description	NOAA	NGA	Other NGA	ECDIS	
24	 SS (Lock)	Lock signal station					Signal station
25.1	 SS (Bridge)	Bridge passage signal station					
25.2	†  F Traffic-Sig	Bridge lights including traffic signals					
28	 SS (Storm)	Storm signal station		S Sig Sta			
29	 SS (Weather)	Weather signal station, Wind signal station, National Weather Service (NWS) signal station					
30	 SS (Ice)	Ice signal station					
31	 SS (Time)	Time signal station					
32.1		Tide scale or gauge					
32.2	 Tide Gauge	Automatically recording tide gauge					
33	 SS (Tide)	Tide signal station					
34	 SS (Stream)	Tidal stream signal station					
35	 SS (Danger)	Danger signal station					
36	 SS (Firing)	Firing practice signal station					
<b>Supplementary National Symbols</b>							
a		Bell (on land)					
b		Marine police station					
c		Fireboat station					
d		Notice board					
e		Lookout station; Watch tower					
f		Semaphore		Sem			
g		Park Ranger station					

# Small Craft (Leisure) Facilities U

No.	INT	Description	NOAA	NGA	Other NGA	ECDIS																																																																																																																																																																																																																																
Small Craft (Leisure) Facilities																																																																																																																																																																																																																																						
Traffic Features, Bridges → D			Public Buildings, Cranes → F			Pilots, Coast Guard, Rescue, Signal Stations → T																																																																																																																																																																																																																																
a	Marina facilities																																																																																																																																																																																																																																					
	<table border="1"> <thead> <tr> <th rowspan="2">NO</th> <th rowspan="2">LOCATION</th> <th>TIDES</th> <th>DEPTH</th> <th colspan="6">SERVICES</th> <th colspan="6">SUPPLIES</th> </tr> <tr> <th>APPROACH-FEET (REPORTED)</th> <th>ALONGSIDE-FEET (REPORTED)</th> <th>RAMP SURFACED (TRANSIENTS)</th> <th>ELECTRICITY (REPORTED)</th> <th>REPAIRS HULL-MOTOR-BERTHS</th> <th>MARINE RAILWAY-RADIO</th> <th>LIFT CAPACITY-FEET</th> <th>BOAT RENTAL</th> <th>CANOE-ROW-MOTOR</th> <th>CHARTER-HOUSE-SAIL</th> <th>FOOD-LODGING-CAMPING</th> <th>PUMP-OUT STATION</th> <th>TOILETS-SHOWERS-LAUNDRY</th> <th>WINTER STORAGE</th> <th>NAUTICAL CHART SALES</th> <th>WATER-ICE</th> <th>GROCERIES-HARDWARE</th> <th>BAIT-TACKLE</th> <th>DIESEL OIL-GASOLINE</th> </tr> </thead> <tbody> <tr> <td>1</td> <td>LAS VEGAS BOAT</td> <td></td> <td></td> <td></td> <td>80</td> <td>20</td> <td></td> <td>S</td> <td>HM</td> <td></td> <td></td> <td></td> <td>M</td> <td></td> <td></td> <td></td> <td>FC</td> <td>T</td> <td>P</td> <td>WD</td> <td>C</td> <td>WI</td> <td>GH</td> <td>BT</td> <td>G</td> </tr> <tr> <td>2</td> <td>LAKE MEAD MAR</td> <td></td> <td></td> <td></td> <td>80</td> <td>15</td> <td>B E</td> <td>S</td> <td>HM</td> <td></td> <td></td> <td></td> <td>M</td> <td></td> <td></td> <td></td> <td>FL</td> <td>T</td> <td>P</td> <td>WD</td> <td>C</td> <td>WI</td> <td></td> <td></td> <td>DG</td> </tr> <tr> <td>3</td> <td>HEMENWAY HARBOR</td> <td></td> <td></td> <td></td> <td>80</td> <td></td> <td></td> <td>S</td> <td></td> <td></td> <td></td> <td></td> <td></td> <td></td> <td></td> <td></td> <td></td> <td></td> <td></td> <td></td> <td></td> <td></td> <td></td> <td></td> <td></td> <td></td> </tr> <tr> <td>4</td> <td>TEMPLE BAR HAR</td> <td></td> <td></td> <td></td> <td>80</td> <td>15</td> <td></td> <td></td> <td>SN</td> <td></td> <td></td> <td></td> <td>M</td> <td>H</td> <td></td> <td></td> <td>FLC</td> <td>TSL</td> <td>P</td> <td>WD</td> <td>C</td> <td>WI</td> <td>GH</td> <td>BT</td> <td>G</td> </tr> <tr> <td>5</td> <td>ECHO BAY RESORT</td> <td></td> <td></td> <td></td> <td>35</td> <td>35</td> <td>BM</td> <td>S</td> <td>M</td> <td></td> <td></td> <td></td> <td>M</td> <td>H</td> <td></td> <td></td> <td>FLC</td> <td>TSL</td> <td>P</td> <td>WD</td> <td>C</td> <td>WI</td> <td>GH</td> <td>BT</td> <td>G</td> </tr> <tr> <td>6</td> <td>OVERTON BEACH</td> <td></td> <td></td> <td></td> <td>100</td> <td></td> <td></td> <td>S</td> <td></td> <td></td> <td></td> <td></td> <td>M</td> <td></td> <td></td> <td></td> <td>F C</td> <td>TSL</td> <td></td> <td>WD</td> <td></td> <td>WI</td> <td>G</td> <td>BT</td> <td>G</td> </tr> <tr> <td>7</td> <td>CALLVILLE BAY M</td> <td></td> <td></td> <td></td> <td>100</td> <td>40</td> <td></td> <td>S</td> <td></td> <td></td> <td></td> <td></td> <td>M</td> <td>H</td> <td></td> <td></td> <td>F C</td> <td>TS</td> <td>P</td> <td>WD</td> <td></td> <td>WI</td> <td>G</td> <td>B</td> <td>G</td> </tr> </tbody> </table>												NO	LOCATION	TIDES	DEPTH	SERVICES						SUPPLIES						APPROACH-FEET (REPORTED)	ALONGSIDE-FEET (REPORTED)	RAMP SURFACED (TRANSIENTS)	ELECTRICITY (REPORTED)	REPAIRS HULL-MOTOR-BERTHS	MARINE RAILWAY-RADIO	LIFT CAPACITY-FEET	BOAT RENTAL	CANOE-ROW-MOTOR	CHARTER-HOUSE-SAIL	FOOD-LODGING-CAMPING	PUMP-OUT STATION	TOILETS-SHOWERS-LAUNDRY	WINTER STORAGE	NAUTICAL CHART SALES	WATER-ICE	GROCERIES-HARDWARE	BAIT-TACKLE	DIESEL OIL-GASOLINE	1	LAS VEGAS BOAT				80	20		S	HM				M				FC	T	P	WD	C	WI	GH	BT	G	2	LAKE MEAD MAR				80	15	B E	S	HM				M				FL	T	P	WD	C	WI			DG	3	HEMENWAY HARBOR				80			S																			4	TEMPLE BAR HAR				80	15			SN				M	H			FLC	TSL	P	WD	C	WI	GH	BT	G	5	ECHO BAY RESORT				35	35	BM	S	M				M	H			FLC	TSL	P	WD	C	WI	GH	BT	G	6	OVERTON BEACH				100			S					M				F C	TSL		WD		WI	G	BT	G	7	CALLVILLE BAY M				100	40		S					M	H			F C	TS	P	WD		WI	G	B	G
	NO	LOCATION	TIDES	DEPTH	SERVICES						SUPPLIES																																																																																																																																																																																																																											
			APPROACH-FEET (REPORTED)	ALONGSIDE-FEET (REPORTED)	RAMP SURFACED (TRANSIENTS)	ELECTRICITY (REPORTED)	REPAIRS HULL-MOTOR-BERTHS	MARINE RAILWAY-RADIO	LIFT CAPACITY-FEET	BOAT RENTAL	CANOE-ROW-MOTOR	CHARTER-HOUSE-SAIL	FOOD-LODGING-CAMPING	PUMP-OUT STATION	TOILETS-SHOWERS-LAUNDRY	WINTER STORAGE	NAUTICAL CHART SALES	WATER-ICE	GROCERIES-HARDWARE	BAIT-TACKLE	DIESEL OIL-GASOLINE																																																																																																																																																																																																																	
	1	LAS VEGAS BOAT				80	20		S	HM				M				FC	T	P	WD	C	WI	GH	BT	G																																																																																																																																																																																																												
	2	LAKE MEAD MAR				80	15	B E	S	HM				M				FL	T	P	WD	C	WI			DG																																																																																																																																																																																																												
	3	HEMENWAY HARBOR				80			S																																																																																																																																																																																																																													
	4	TEMPLE BAR HAR				80	15			SN				M	H			FLC	TSL	P	WD	C	WI	GH	BT	G																																																																																																																																																																																																												
	5	ECHO BAY RESORT				35	35	BM	S	M				M	H			FLC	TSL	P	WD	C	WI	GH	BT	G																																																																																																																																																																																																												
	6	OVERTON BEACH				100			S					M				F C	TSL		WD		WI	G	BT	G																																																																																																																																																																																																												
7	CALLVILLE BAY M				100	40		S					M	H			F C	TS	P	WD		WI	G	B	G																																																																																																																																																																																																													
<p>(+) DENOTES HOURS LATER (-) DENOTES HOURS EARLIER.            THE LOCATIONS OF THE ABOVE PUBLIC MARINE FACILITIES ARE SHOWN ON THE CHART BY LARGE PURPLE NUMBERS.            THE TABULATED "APPROACH-FEET (REPORTED)" IS THE DEPTH AVAILABLE FROM THE NEAREST NATURAL OR DREDGED CHANNEL TO THE FACILITY.            THE TABULATED "PUMPING STATION" IS DEFINED AS FACILITIES AVAILABLE FOR PUMPING OUT BOAT HOLDING TANKS.            (H) APPROACH DEPTH FLUCTUATES WITH LAKE LEVELS.</p>																																																																																																																																																																																																																																						

# Index of Abbreviations

Note—INT abbreviations are in bold type

<b>A</b>		
abt	About	D i
<b>Accom</b>	<b>Accommodation vessel</b>	L 17
<b>AERO, Aero</b>	<b>Aeronautical light</b>	P 60–61.1
Aero R Bn	Aeronautical radiobeacon	S 16
<b>Aero RC</b>	<b>Aeronautical radiobeacon</b>	S 16
<b>AIS</b>	<b>Automatic Identification System</b>	S 17.1–17.2
<b>AI</b>	<b>Alternating</b>	P 10.11
<b>ALC</b>	<b>Articulated Load Column</b>	L 12
<b>Am</b>	<b>Amber</b>	P 11.8
anc	Ancient	
ANCH, Anch	Anchorage	N 20
ANT, Ant	Antenna	E 31
approx	Approximate	
Apprs	Approaches	
Apr	April	
Apt	Apartment	E s
Arch	Archipelago	
<b>ASL</b>	<b>Archipelagic Sea Lane</b>	<b>M 17</b>
ATBA	Area To Be Avoided	M 29.1
Aug	August	
auth	Authorized	K 46.2
Ave	Avenue	
<b>B</b>		
B	Bay, bayou	
<b>B</b>	<b>Black</b>	Q 2
Bdy Mon	Boundary mark (monument)	B 24
Bk	Bank	
bk	Black	J as
<b>bk</b>	<b>Broken</b>	J 33
Bkw	Breakwater	F 4.1
bl	Black	J as
BM	Bench Mark	B 23
<b>Bn, Bns</b>	<b>Beacon(s)</b>	M 2, P 4–5, Q 80–81
<b>BnTr, BnTrs</b>	<b>Beacon tower(s)</b>	P 3, Q 110
<b>Bo</b>	<b>Boulder(s)</b>	J 9.2
Bol	Bollard	

<b>Br</b>	<b>Breakers</b>	K 17
br	Brown	J az
brg	Bearing	B 62
brk	Broken	J 33
<b>Bu</b>	<b>Blue</b>	P 11.4
<b>C</b>		
C	Can, cylindrical	Q 21
C	Cape	
C	Cove	
<b>c</b>	<b>Coarse</b>	J 32
Ca, ca	<b>Calcareous</b>	J 38
<b>CALM</b>	<b>Catenary Anchor Leg Mooring</b>	L 16
Cap	Capitol	E t
Cas	Castle	E 34.2
<b>Cb</b>	<b>Cobbles</b>	J 8
cbl	Cable	B 46
<b>cd</b>	<b>Candela</b>	B 54
Cem	Cemetery	E 19
<b>CG</b>	<b>Coast Guard station</b>	T 10
Ch	Chocolate	J ba
<b>Ch</b>	<b>Church</b>	E 10.1
Chan	Channel	
Chem	Chemical	L 40.1–40.2
CHY, Chy, Chys	<b>Chimney(s)</b>	E 22
Cir	Cirripedia	J ae
Ck	Chalk	J f
CL	Clearance	D 20–21, 26, 28
Cl	Clay	J 3
<b>cm</b>	<b>Centimeter(s)</b>	B 43
Cn	Cinders	J p
Co	Company	E u
<b>Co</b>	<b>Coralline Algae</b>	J 10, K 16
Co Hd	Coral Head	J i
Co rf	Coral reef	
COLREGS	International Regulations for Preventing Collisions at Sea	N a
<b>Consol</b>	<b>Consol Beacon</b>	S 13
constr	Construction	F 32

Corp	Corporation	E v
cov	Covers	L 21.2
cps	Cycles per second	B j
Cr	Creek	
CRD	Columbia River Datum	H j
crs	Coarse	J 32
c/s	Cycles per second	B j
Cswy	Causeway	F 3
Ct Ho	Courthouse	E o
Cup	Cupola	E 10.4
Cus Ho	Customs house	F 61
<b>Cy</b>	<b>Clay</b>	J 3
<b>D</b>		
D	Destroyed	
dec	Decayed	J an
Dec	December	
Deg	Degree(s)	B n
Destr	Destroyed	
dev	Deviation	B 67
DF	Direction Finder	
<b>DG</b>	<b>Degaussing Range</b>	N 25, Q 54
<b>DGPS</b>	<b>Differential Global Positioning System</b>	S 51
Di	Diatoms	J aa
<b>DIA, Dia</b>	<b>Diaphone</b>	R 11
<b>Dir</b>	<b>Direction light</b>	P 30–31
Discol	Discolored	K e
dist	Distant	
dk	Dark	J bd
<b>dm</b>	<b>Decimeter(s)</b>	B 42
<b>Dn, Dns</b>	<b>Dolphin(s)</b>	F 20
Dol	Dolphin(s)	F 20
<b>DW</b>	<b>Deep Water Route</b>	M 27.1, N 12.4
<b>DZ</b>	<b>Danger Zone</b>	Q 50
<b>E</b>		
<b>E</b>	<b>East</b>	B 10
<b>ED</b>	<b>Existence Doubtful</b>	I 1
EEZ	Exclusive Economic Zone	N 47

# Index of Abbreviations

Note—INT abbreviations are in bold type

Entr	Entrance	
ESSA	Environmentally Sensitive Sea Area	N 22
Est	Estuary	
exper	Experimental	
<b>Explos</b>	<b>Explosive</b>	R 10
Exiting, <b>exiting</b>	<b>Extinguished</b>	P 55
<b>F</b>		
<b>f</b>	<b>Fine</b>	J 30
<b>F FI</b>	<b>Fixed and flashing</b>	P 10.10
<b>F Gp FI</b>	<b>Fixed and Group Flashing</b>	P f
Facty	Factory	E d
<b>FAD</b>	<b>Fish Aggregating Device</b>	
Fd	Fjord	
FISH	Fishing	N 21
<b>FI</b>	<b>Flashing</b>	P 10.4
fl	Flood	H q
<b>Fla</b>	<b>Flare stack</b>	L 11
fly	Flinty	J ao
<b>fm, fms</b>	<b>Fathom(s)</b>	B 48
fne	Fine	J 30
<b>Fog Det Lt</b>	<b>Fog detector light</b>	P 62
Fog Sig	Fog Signal	R 1
FP	Flagpole	E 27
<b>FPSO</b>	<b>Floating Production, Storage and Offloading Vessel</b>	L 17
Fr	Foraminifera	J y
Fs, <b>FS</b>	<b>Flagstaff</b>	E 27
Fsh stks	Fishing stakes	K 44.1
FT, <b>ft</b>	<b>Foot, Feet</b>	B 47, D 20
Fu	Fucus	J af
<b>G</b>		
<b>G</b>	<b>Gravel</b>	J 6
<b>G</b>	<b>Green</b>	P 11.3, Q 2
G	Gulf	
GAB, Gab	Gable	E i
GCLWD	Gulf Coast Low Water Datum	H k
Gl	Globigerina	J z
glac	Glacial	J ap

gn	Green	J av
Govt Ho	Government House	E m
Gp FI	Group flashing	P 10.4
Gp Oc	Group occulting	P 10.2
<b>GPS</b>	<b>Global Positioning System</b>	
Grd	Ground	J a
Grs	Grass	J v
<b>grt</b>	<b>Gross Register Tonnage</b>	
<b>GT</b>	<b>Gross Tonnage</b>	
gty	Gritty	J am
gy	Gray	J bb
<b>H</b>		
<b>H</b>	<b>Helicopter</b>	T 1.4
<b>h</b>	<b>Hard</b>	J 39
<b>h</b>	<b>Hour</b>	B 49
HAT	Highest Astronomical Tide	H 3
Hbr Mr	Harbormaster	F 60
HHW	Higher High Water	H b
Hk	Hulk	F 34, K 20–21
Ho	House	
<b>hor</b>	<b>Horizontally disposed</b>	P 15
Hor CL	Horizontal clearance	D 21
Hosp	Hospital	E g, F 62.2
hr	Hour	B 49
hrd	Hard	J 39
ht	Height	H p
HW	High Water	H a
HWF&C	High Water Full & Change	H h
Hz	Hertz	B g
<b>I</b>		
IALA	International Association of Lighthouse Authorities*	Q 130
IHO	International Hydrographic Organization	
illum	Illuminated	P 63
IMO	International Maritime Organization	
In	Inlet	
in, ins	Inch(es)	B c
Inst	Institute	E n

<b>INT</b>	<b>International</b>	A 2, T 21
<b>Intens</b>	<b>Intensified</b>	P 46
<b>IQ</b>	<b>Interrupted quick</b>	P 10.6
ISLW	Indian Spring Low Water	H g
<b>Iso</b>	<b>Isophase</b>	P 10.3
ITZ	Inshore Traffic Zone	M 25.1
<b>IUQ</b>	<b>Interrupted ultra quick</b>	P 10.8
<b>IVQ</b>	<b>Interrupted very quick</b>	P 10.7
<b>J</b>		
Jan	January	
Jul	July	
Jun	June	
<b>K</b>		
K	Kelp	J u
kc	Kilocycle	B k
kHz	Kilohertz	B h
<b>km</b>	<b>Kilometer(s)</b>	B 40
<b>kn</b>	<b>Knot(s)</b>	B 52
<b>L</b>		
L	Lake, loch, lough	
<b>L FI</b>	<b>Long-flashing</b>	P 10.5
La	Lava	J l
Lag	Lagoon	
<b>LANBY</b>	<b>Large Automatic Navigational Buoy</b>	P 6
<b>LASH</b>	<b>Lighter Aboard Ship</b>	
<b>LAT</b>	<b>Lowest Astronomical Tide</b>	H 2
<b>Lat</b>	<b>Latitude</b>	B 1
Ldg	Landing	F 17
<b>Ldg</b>	<b>Leading Lights</b>	P 20.3
Le	Ledge	
LLW	Lower Low Water	H e
<b>Lndg</b>	<b>Landing for boats</b>	F 17
<b>LNG</b>	<b>Liquified Natural Gas</b>	
LoLo	Load-on, Load-off	
Long	Longitude	B 2
LPG	Liquified Petroleum Gas	
Lrg	Large	J a

\*Now known as the International Association of Marine Aids to Navigation and Lighthouse Authorities. The organization, formerly known as the International Association of Lighthouse Authorities/Association Internationale de Signalisation Maritime (IALA/AISM), continues to use IALA as an abbreviation for its full name.

# Index of Abbreviations

Note—INT abbreviations are in bold type

LS S	Life saving station	T 12
lt	Light	J bc
Lt Ho	Light house	P1
<b>Lt, Lt(s)</b>	<b>Light(s)</b>	P 1
Ltd	Limited	E r
LW	Low Water	H c
LWD	Low Water Datum	H d
LWF&C	Low Water Full and Change	H i
<b>M</b>		
<b>M</b>	<b>Mud, muddy</b>	J 2
<b>M</b>	<b>Nautical mile(s)</b>	B 45
<b>m</b>	<b>Medium (in relation to sand)</b>	J 31
<b>m</b>	<b>Meter(s)</b>	B 41
<b>m</b>	<b>Minute(s) of time</b>	B 50
Ma	Mattes	J ag
mag	Magnetic	B 61
Magz	Magazine	E l
Maintd	Maintained	P 65
<b>man</b>	<b>Manually activated</b>	P 56, R 2
Mar	March	
Mc	Megacycles	B l
Mds	Madrepores	J j
MHHW	Mean Higher High Water	H 13
MHLW	Mean Higher Low Water	H 14
MHW	Mean High Water	H 5
MHWN	Mean High Water Neaps	H 11
MHWS	Mean High Water Springs	H 9
Mi	Nautical mile(s)	B 45
min	Minimum	K 46.2
<b>min</b>	<b>Minute(s) of time</b>	B 50
<b>Mk</b>	<b>Mark</b>	Q 101
MI	Marl	J c
MLHW	Mean Lower High Water	H 15
MLLW	Mean Lower Low Water	H 12
MLW	Mean Low Water	H 4
MLWN	Mean Low Water Neaps	H 10
MLWS	Mean Low Water Springs	H 8
<b>mm</b>	<b>Millimeter(s)</b>	B 44

Mn	Manganese	J q
<b>Mo</b>	<b>Morse Code</b>	P 10.9, R 20
MON, <b>Mon</b>	<b>Monument</b>	E 24
<b>MR</b>	<b>Marine Reserve</b>	N 22
<b>MRCC</b>	<b>Maritime Rescue and Coordination Center</b>	
Ms	Mussels	J s
MSL	Mean Sea Level	H 6
Mt	Mountain, Mount	
Mth	Mouth	
MTL	Mean Tide Level	H 1
<b>N</b>		
<b>N</b>	<b>North</b>	<b>B 9</b>
N	Nun	Q 20
<b>NE</b>	<b>Northeast</b>	B 13
NGA	National Geospatial-Intelligence Agency	
NM	Nautical miles(s)	B 45
NMi	Nautical mile(s)	B 45
No	Number	N 12.2
NOAA	National Oceanic and Atmospheric Administration	
NOS	National Ocean Service	
Nov	November	
Np	Neap tide	H 17
<b>NT</b>	<b>Net Tonnage</b>	
NTM	Notice to Mariners	
<b>NW</b>	<b>Northwest</b>	B 15
NWS SIG STA	National Weather Service signal station	T 29
<b>O</b>		
Obs Spot	Observation spot	B 21
OBSC, <b>Obscd</b>	<b>Obscured</b>	P 43
Obstn	<b>Obstruction</b>	K 41
Oc	<b>Occulting</b>	P 10.2
Occas	<b>Occasional</b>	P 50
Oct	October	
<b>ODAS</b>	<b>Ocean Data Acquisition System</b>	Q 58
<b>Or</b>	<b>Orange</b>	P 11.7

OVHD	Overhead	D 28
Oys	Oysters	J r
<b>P</b>		
<b>P</b>	<b>Pebbles</b>	J 7
P	Pillar	Q 23
(P)	Preliminary (NTM)	
<b>PA</b>	<b>Position approximate</b>	B 7
Pass	Passage, Pass	
Pav	Pavilion	E p
PD	Position doubtful	B 8
Pk	Peak	
PLT STA	Pilot station	T 3
Pm	Pumice	J m
PO	Post office	F 63
Po	Polyzoa	J ad
pos, posn	Position	
Post Off	Post office	F 63
Priv, <b>priv</b>	<b>Private</b>	P 65, Q 70
<b>Prod well</b>	<b>Production well</b>	L 20
PROHIB	Prohibited	N 2.2
<b>PSSA</b>	<b>Particularly Sensitive Sea Area</b>	N 22
Pt	Pteropods	J ac
<b>Pyl</b>	<b>Pylon</b>	D 26
<b>Q</b>		
<b>Q</b>	<b>Quick</b>	P 10.6
QTG	Service producing DF signals	S 15
Quar	Quarantine	F e
Qz	Quartz	J g
<b>R</b>		
<b>R</b>	<b>Coast radio station providing QTC service</b>	S 15
R	Radio Station	S 15
<b>R</b>	<b>Red</b>	P 11.2
<b>R, r</b>	<b>Rock, Rocky</b>	J 9.1, K b
R Bn	Circular radiobeacon	S 10
R Lts	Air obstruction lights	P 61.2
R Mast	Radio mast	E 28
R Sta	Radio Station	S 15

# Index of Abbreviations

Note—INT abbreviations are in bold type

R Tower	Radio tower	E 29
R TR, R Tr	Radio tower	E 29
<b>Ra</b>	<b>Radar</b>	M 31–32, S 1
Ra	Radar reference line	M 32.1
Ra (conspic)	Radar conspicuous point	S 5
Ra Ref	Radar reflector	S 4
<b>Racon</b>	<b>Radar transponder beacon</b>	S 3
Radar Sc	Radar scanner	E 30.3
Radar Tr, RADAR TR	Radar tower	E 30.2
Ramark	Radar marker beacon	S 2
<b>RC</b>	<b>Circular radiobeacon</b>	S 10
<b>RD</b>	<b>Directional radiobeacon</b>	S 11
Rd	Radiolaria	J ab
Rd	Road, roadstead	
rd	Red	J ay
RDF	Radio direction finding station	S 14
<b>Ref</b>	<b>Refuge</b>	Q 124
Rep	Reported	I 3
Rf	Reef	
<b>RG</b>	<b>Radio direction finding station</b>	S 14
Rk	Rocks	J 9.1, K b
Rky	Rocky	J 9.1
<b>RoRo</b>	<b>Roll-on, Roll-off Ferry (RoRo Terminal)</b>	F 50
rt	Rotten	J aj
<b>Ru, (ru)</b>	<b>Ruin, ruined</b>	D 8, E 25.2, F 33
<b>RW</b>	<b>Rotating-pattern radiobeacon</b>	S 12
<b>S</b>		
<b>S</b>	<b>Sand</b>	J 1
<b>S</b>	<b>South</b>	B 11
S	Spar, spindle	Q 24
<b>s</b>	<b>Second(s) of time</b>	B 51, P 12
<b>SALM</b>	<b>Single Anchor Leg Mooring</b>	L 12
<b>SBM</b>	<b>Single Buoy Mooring</b>	L 16
Sc	Scanner	E 30.3
Sc	Scoriae	J o
Sch	Schist	J h

Sch	School	E f
SD	Sailing Directions	
Sd	Sound	
SD	Sounding doubtful	I 2
<b>SE</b>	<b>Southeast</b>	B 14
<b>sec</b>	<b>Seconds of time</b>	B 51
Sep	September	
<b>sf</b>	<b>Stiff</b>	J 36
sft	Soft	J 35
<b>Sg</b>	<b>Seagrass</b>	J 13.3
<b>Sh</b>	<b>Shells</b>	J 11
Shl	Shoal	
<b>Si</b>	<b>Silt</b>	<b>J 4</b>
<b>Sig</b>	<b>Signal</b>	<b>R 1, T 25.2</b>
Sig Sta	Signal station	T 20
S-L FI	Short-Long Flashing	P b
S/M	Sand over mud	J 12.1
sml	Small	J ah
SMt	Seamount	
Sn	Shingle	J d
<b>so</b>	<b>Soft</b>	J 35
Sp	Church spire	E 10.3
SP	Spherical	Q 22
Sp	spire	E 10.3
Sp	Spring tide	H 16
Spq	Sponge	J t
Spi	Spicules	J x
Spipe, S'pipe	Standpipe	E 21
spk	Speckled	J al
<b>SPM</b>	<b>Single Point Mooring</b>	L 12
<b>SS</b>	<b>Signal station</b>	T 20–36
<b>St</b>	<b>Stones</b>	J 5
St M, St Mi	Statute mile(s)	B e
STA, Sta	Station	F 41.1, S 15, T 3
stf	Stiff	J 36
Stg	Sea-tangle	J w
stk	Sticky	J 34

Str	Strait	
Str	Stream	H I
str	Streaky	J ak
sub	Submarine	K d
Subm	Submerged	K 43.1
<b>SW</b>	<b>Southwest</b>	B 16
<b>sy</b>	<b>Sticky</b>	J 34

## T

T	Short ton(s)	B m
T	Telephone	E q
T	TRUE	B 63
T	Tufa	J n
<b>t</b>	<b>Ton(s), Tonnage (weight)</b>	<b>B 53, F 53</b>
Tel	Telegraph	D 27
Tel off	Telegraph office	E k
<b>Temp, temp</b>	<b>Temporary</b>	<b>P 54</b>
ten	Tenacious	J aq
Tk	Tank	E 32
<b>TR, Tr, Trs</b>	<b>Tower(s)</b>	<b>E 10.2, E 20</b>
TSS	Traffic Separation Scheme	M 20.1
TT	Tree tops	C 14
TV Mast	Television mast	E 28
TV Tower	Television tower	E 29

## U

<b>ULCC</b>	<b>Ultra Large Crude Carrier</b>	
Uncov	Uncovers	K 11
unev	Uneven	J bf
Univ	University	E h
<b>UQ</b>	<b>Ultra quick</b>	<b>P 10.8</b>
<b>UTC</b>	<b>Coordinated Universal Time</b>	
<b>UTM</b>	<b>Universal Transverse Mercator</b>	

## V

<b>v</b>	<b>Volcanic</b>	<b>J 37</b>
var, VAR	Variation	B 60
vard	Varied	J be
vel	Velocity	H n
<b>vert</b>	<b>Vertically disposed</b>	<b>P 15</b>
Vert CL	Vertical clearance	D 20, 28

# Index of Abbreviations

Note—INT abbreviations are in bold type

<b>Vi</b>	<b>Violet</b>	P 11.5
Vil	Village	D 4
<b>VLCC</b>	<b>Very Large Crude Carrier</b>	G 187
vol	Volcanic, Volcano	J 37
Vol Ash	Volcanic ash	J k
<b>VQ</b>	<b>Very quick</b>	P 10.7
<b>VTS</b>	<b>Vessel Traffic Service</b>	
<b>W</b>		
<b>W</b>	<b>West</b>	B 12
<b>W</b>	<b>White</b>	P 11.1
<b>Wd</b>	<b>Weed</b>	J 13.1
<b>Well</b>	<b>Wellhead</b>	L 21
<b>WGS</b>	<b>World Geodetic System</b>	S 50
Wh	White	J ar
Whf	Wharf	F 13
WHIS, <b>Whis</b>	<b>Whistle</b>	R 15
<b>Wk, Wks</b>	<b>Wreck(s)</b>	K 20
Wtr Tr, WTR TR	Water tower	E 21
<b>Y</b>		
<b>Y</b>	<b>Yellow, Orange, Amber</b>	P 11.6–11.8
yd, yds	Yard(s)	B d
yl	Yellow	J aw
<b>μ</b>		
μs, μsec	Microsecond(s)	B f





# Index

<b>A</b>								
Abandoned railroad		D c	Automatic Identification System (AIS) transmitter		S 17.1–17.2	Board (leading beacon)		Q 102.2
Accommodation vessel		L 17	Awash, rock		K 12	Boarding place, pilot		T 1.1–1.4
Accurate position		B 32, E 2	<b>B</b>			Boat harbor, marina		F 11.1
Aerial cableway dish		D 25 E 31	Band, S & X		S 3.1–3.2	Boom		F 29.1
Aero light		P 60	Bar code		A d	Boulders international		J 9.2 N 40–41
Aeronautical radiobeacon		S 16	Barrage, flood		F 43	Boundary IALA region		Q 130
Air obstruction light		P 61.1–61.2	Barrel buoy		Q 25	Breakers		C d, K 17
Airfield		D 17	Barrier floating		F 29.1	Breakwater		F 4.1–4.3
Airport		D 17	oil retention security		F 29.2 F 29.1, Q q	Bridge		D 20.1–24
AIS		S 17.1–17.2	Bascule bridge		D 23.4	<i>bascule</i>		D 23.4
All-round light		P 42.1–43.2	Basin		F 27–28	<i>draw</i>		D 23.6
Alternate course		M c	Battery		E 34.3	<i>fixed</i>		D 20.1
Alternating light		P 10.11	Battery (fortification)		E 34.3	<i>lifting</i>		D 23.3
Amber		P 11.8	Beacon		Q 80–126	<i>light (traffic signal)</i>		T 25.2
Anchor berth		N 11.1–11.2	<i>articulated</i>		P 5	<i>passage signal station</i>		T 25.1
Anchorage areas		N 10–14	<i>buoyant</i>		P 5	<i>pontoon</i>		D 23.5
buoy		Q j	<i>leading</i>		Q 102.2, 120	<i>swing</i>		D 23.2
for sea-planes		N 14	<i>lighted</i>		P 3–5	<i>transporter</i>		D 24
Anchoring prohibited		N 20	<i>marking a clearing line</i>		Q 121	<i>under construction</i>		D d
Annual change		B 70	<i>marking measured distance</i>		Q 122	Broken		J 33
Anomaly, magnetic		B 82.1–82.2	<i>on submerged rock</i>		Q 83	Brown		J az
Antenna		E 31	<i>radar</i>		S 2–3.6	Bubbler curtain, bubbler		F 29.2
Apparent shoreline		C p	<i>radio</i>		S 10–16	Buildings		D 2, 5–6, 8
Approximate depth contour		I 31	<i>resilient</i>		P 5	Buoyage system, IALA		Q 130–130.7
height of top of trees		C 14	<i>topmarks</i>		Q 9–11, 82, 102.1	Buoyant beacon		P 5
position		B 7, 33, E 2	<i>towers</i>		P 3, Q 110–111	Buoy		Q 20–71
topographic contour		C 12	Bearing		B r	<i>cardinal</i>		Q 130.3
vertical clearance		D i	Being reclaimed		F 31	<i>isolated danger</i>		Q 130.4
Aquaculture		K 44.1–48.2	Bell		R 14	<i>lateral</i>		Q 130.1
Archipelagic Sea Lane (ASL)		M 17	buoy		Q a, R 21	<i>mooring</i>		Q 40–45
Areas		N	on land		T a	<i>new danger</i>		Q 130.7
pipeline		L 40.2, L 41.2	Benchmark		B o	<i>safe water</i>		Q 130.5
restricted		M 14, N 2.1	Berth		N 11.1–11.2	<i>scientific mooring</i>		Q r
to be avoided		M 14, 29.1–29.2	anchor		N 11.1–11.2	<i>special</i>		Q 130.6
wire drag		I 24	dangerous cargo		F 19.3	Buried pipeline		L 42.1
Articulated Loading Column (ALC)		L 12	designation		F 19.1, N 11.1–11.2, Q 42	Bushes		C o
Ash, volcanic		J k	visitors		F 19.2	<b>C</b>		
Astronomical tide		H 2–3	yacht		F 11.2	Cable		
			Bifurcation buoy		Q h	ferry		M 51
			Black		J as, Q 2	landing beacon		Q 123
			Blind, duck		K j–k	overhead		D 26–27, H 20
			Blockhouse		E 34.2	submarine		L 30.1–32
			Blue		J au, P 11.4	Cableway (aerial)		D 25
						Cairn		Q 100

# Index

CALM (Catenary Anchor Leg Mooring)	L 16	Clay	J 3	Continuous	
Caisson	F 42	Clearance		<i>quick</i>	P 10.6
Calcareous	J 38	<i>horizontal</i>	D 21	<i>ultra quick</i>	P 10.8
Calling-in point	M 40.1	<i>safe vertical</i>	D 26, i	<i>very quick</i>	P 10.7
Calvary cross	E 24	<i>vertical</i>	D 22, 23.1, 23.4, 23.6–28	Contour	
Camping site	E 37.1–37.2	Cleared platform	L 22	<i>depth</i>	I 30–31
Can buoy	Q 21	Clearing line	M 2	<i>drying</i>	I 15, 30
Canal	F 40	Clearing line beacon	Q 121	<i>topographic</i>	C 10, 12, H 20
<i>distance mark</i>	B 25.1–25.2	Cliffs	C 3	Control point	B 20–24
Candela	B 54	Coal head	J i	Conversion scales	A a
Cardinal marks	Q 130.3	Coarse	J 32	Conveyor	F g
Careening grid	F 24	Coast		Copyright note	A 5
Cargo transshipment area	N 64	<i>flat</i>	C 5	Coral	J 10, 22, K 16, h, m
Castle	E 34.2	<i>radar station</i>	S 1	Coral reef	
Casuarina	C 31.6	<i>radio station providing QTG service</i>	S 15	<i>always covers</i>	K 16
Causeway	F 3	<i>steep</i>	C 3	<i>covers and uncovers</i>	J 22, K m
Cautionary notes	A 16	Coast Guard station	T 10–11	<i>detached</i>	K h
Cemetery	E 19	Coastline		Coralline algae	J 10
Centimeter	B 43	<i>surveyed</i>	C 1–8	Corner coordinates	A 9
Chalk	J f	<i>unsurveyed</i>	C 1	Covers	J 21–22, K 11, 16, 21
Channel	I 20–22	Cobbles	J 8	Crane	F 53.1–53.3
Chart		Colored mark	Q 101	Crib	K i–j, L 43, b
<i>datum</i>	A 3, C a, H 1, 20	Colored topmark	Q 102.1	Crossing gates	M 22
<i>dimension</i>	A 8	Colors		Crossing, traffic separation	M 23
<i>number</i>	A 1–2	<i>beacons</i>	Q 2–5	Cubic meter	B b
<i>reference to another</i>	A 18–19	<i>buoys</i>	Q 2–5	Cultivated	
<i>scale</i>	A 13	<i>lights</i>	P 11.1–11.8	<i>fields</i>	C i
<i>title</i>	A 10	<i>topmarks</i>	Q 2–5	<i>shellfish</i>	K 47
Chemical dumping ground	N 24	COLREGS demarcation line	N a	Cultural features	D
Chemical pipeline	L 40.1–40.2	Columbia River Datum	H j	Cupola	E 10.4
Chimney	E 22	Column	E 24	Current	H 42–43, m, t
Chocolate	J ba	Compass rose	A c, B 70	<i>diagram</i>	H t
Church	E 10.1	Composite		<i>in restricted waters</i>	H 42
<i>dome</i>	E 10.4	<i>group-flashing</i>	P 10.4	Customs	
<i>spire</i>	E 10.3	<i>group-occulting</i>	P 10.2	<i>house</i>	F 61
<i>tower</i>	E 10.2	Conical buoy	Q 20	<i>limit</i>	N 48
Cinders	J p	Conifer	C 31.3, j	<i>office</i>	F 61
Circular (non-directional) aeromarine radiobeacon	S 10	Consol beacon	S 13	Cutting	D 14
Circular (non-directional) marine radiobeacon	S 10	Conspicuous landmark	E 2	Cycles per second	B j
Cirripedia	J ae	Conspicuous, radar	S 5	Cylindrical buoy	Q 21
		Container crane	F 53.2	Cypress buoy	C r
		Contiguous zone	N 44		
		Continental shelf	N 46		

# Index

<b>D</b>								
Dam		F 44	Designation of			Draft		M 6, N 12.4
Danger			<i>beacon</i>	Q 10		<i>area</i>		I 20–22
<i>firing area</i>	N 30, Q 50, 125		<i>berth</i>	F 19.1		<i>channel</i>		I 20–22
<i>isolated mark</i>	Q 130.4		<i>buoy</i>	Q 11		Dredging (extraction) area		N 63
<i>line</i>	K 1		<i>platform</i>	L 2		Drying		
<i>signal station</i>	T 35		<i>reporting point</i>	M 40.1		<i>contour</i>	I 30	
<i>zone</i>	Q 50		<i>tidal stream, position of tabulated data</i>	H 46		<i>height</i>	H 20, I 15	
Dangerous			<i>transit shed</i>	F 51		Duck blind		K j–k
<i>cargo berth</i>	F 19.3		Detector light	P 62		Dumping ground	N c, d, g	
<i>rock</i>	K 0–13, 14.2		Development area	L 4		<i>chemical waste</i>	N 24	
<i>wreck</i>	K 28		Deviation	F 21		<i>explosives</i>	N 23.1–23.2	
Dark	J bd		<i>dolphin</i>			Dunes	C 8	
Data collection buoy	Q 58		DGPS correction transmitter	S 51		<b>E</b>		
Datum			Diaphone	R 11		East	B 10	
<i>chart</i>	H 1, 20		Diatoms	J aa		<i>cardinal mark</i>	Q 130.3	
<i>sounding reduction</i>	H 1		Diffuser	L 43		Ebb tide stream	H 41	
Daymark (dayboard)	Q 10, 80–81, 110, I		Dike	F 1		Eddies	H 45	
Daytime light	P 51		Direction			Edition note	A 6	
Deadhead	K 43.2		<i>of buoyage</i>	Q 130.2		Eelgrass	C t	
Decayed	J an		<i>finding, radio station</i>	S 14		Elevation of light	H 20, P 13	
Deciduous			<i>of flow</i>	F 44		Ellipsoid	A 3	
<i>woodland</i>	C i		<i>light</i>	P 30.1–31		Embankment	D 15	
Decimeter	B 42		<i>of traffic</i>	M 10, 11, 26.1–26.2, 40.1		Entry prohibited area	N 2.2, 31	
Deep water			Directional radiobeacon	S 11		Environmentally Sensitive Sea Area (ESSA)	N 22	
<i>anchorage area</i>	N 12.4		Directions, compass	B		Established (mandatory) direction of traffic flow	M 10	
<i>route</i>	M 27.1–27.3		Discolored water	K e		Eucalypt	C 31.8	
Degaussing range	N 25		Dish aerial	E 31		Evergreen	C 31.2	
<i>buoy</i>	Q 54		Disposition of lights	P 15		Example of		
Degree	B 4		Distance	B		<i>conspicuous landmarks</i>	E 2	
Depth			<i>along waterway</i>	B 25.1–25.2		<i>fog signal descriptions</i>	R 20–22	
<i>charted</i>	H 20		<i>measured, beacons marking</i>	Q 122		<i>full light description</i>	P 16	
<i>contours</i>	I 30		Disused			<i>landmarks</i>	E 1	
<i>minimum</i>	K 46.2, M 27.2		<i>pipeline/pipe</i>	L 44		<i>routing measures</i>	M 18–29.2	
<i>observed</i>	H 20		<i>platform</i>	L 14		Exclusive Economic Zone (EEZ)	N 47	
<i>out of position</i>	I 11		<i>submarine cable</i>	L 32		Exercise area, submarine	N 33	
<i>safe clearance</i>	K 3, 30, f		Diurnal tide	H 30		Existence doubtful	I 1	
<i>swept</i>	I 24, a, b, K 2, 27, 42, f		Dock			Explanatory notes	A 11, 16	
<i>units used for</i>	A b		<i>dry, graving</i>	F 25		Explosive fog signal	R 10	
<i>unknown</i>	K 3, 13, 23, 28, 30, 40, a, L 21.1		<i>floating</i>	F 26		Explosives		
Depths	I		<i>wet</i>	F 27		<i>anchorage area</i>	N 12.7	
Derrick, oil	L 10		Dolphin	F 20–21		<i>dumping ground</i>	N 23.1–23.2	
			Dome	E 30.4		Extinguished light	P 55	
			Doubtful					
			<i>depth</i>	I 2				
			<i>existence</i>	I 1				
			<i>position</i>	B 8				

# Index

Extraction area	N 63
<b>F</b>	
Factory	E d
Faint sector	P 45.1–45.2
Fairway	M 18
Farm	
<i>marine</i>	K 48.1–48.2
<i>wave</i>	L 6
<i>wind</i>	L 5.2
Fast ice, limit	N 60.1
Fathom(s)	B 48
Feet	B 47
Fence	D g
Ferry	M 50–51
<i>terminal, RoRo</i>	F 50
Filao	C 31.7
Fine	J 30
Fireboat station	T c
Firing	
<i>danger area</i>	N 30
<i>danger area buoy</i>	Q 50
<i>practice signal station</i>	T 36
Fish	
<i>haven</i>	K 46.1–46.2
<i>marine farm</i>	K 48.1–48.2
<i>trap</i>	K 44.2–45, Q i
<i>weir</i>	K 44.2
Fishery zone limit	N 45
Fishing	
<i>harbor</i>	F 10
<i>limit (fish trap area)</i>	N b
<i>prohibited</i>	N 21.1
<i>stakes</i>	K 44.1
Fixed	
<i>bridge</i>	D 20.1
<i>flashing, and</i>	P 10.10, d
<i>light</i>	P 10.1
<i>point</i>	B 22
Flagstaff, Flagpole	E 27
Flare stack	E 23, L 11
Flashing light	P 10.4
Flat coast	C 5
Flinty	J ao
Float	K q, Q s

Floating	
<i>barrier</i>	F 29.1
<i>dock</i>	F 26
<i>oil barrier</i>	F 29.1
<i>wind farm</i>	L 5.2
<i>wind turbine</i>	L 5.1
Flood	H q
<i>barrage</i>	F 43
<i>tide (stream)</i>	H 40
Floodlit, floodlight	P 63
Fog	
<i>detector light</i>	P 62
<i>light</i>	P 52
<i>signals</i>	R
Foot	B 47
Footbridge	D 20.2
Foraminifera	J y
Foreshore	C c
Form lines	C 13
Fort	E 34.2
Fortified structure	E 34.1
Foul	
<i>area</i>	K o
<i>ground</i>	K 31.1–31.2
Front light	P 23
Fucus	J af
<b>G</b>	
Gable	E i
Gas	
<i>pipe line</i>	L 40.1
<i>pipeline area</i>	L 40.2
Gasfield name	L 1
Gate	F 42
Geographical positions	B 1–16
Glacial	J ap
Glacier	C 25
Globigerina	J z
Glossary	A e
Gong	R 16, Q b
Grass	C s, J v
Grassfields	C m
<i>area with</i>	J 20
Gravel	C c, J 6, 20

Graving dock	F 25
Gray	J bb
Green	J av, P 11.3, Q 2
Gridiron	F 24
Gritty	J am
Groin	F 6
Ground	J a
<i>tackle</i>	Q 42
Group	
<i>fixed and flashing</i>	P d
<i>flashing</i>	P 10.4
<i>occulting</i>	P 10.2
<i>quick</i>	P 10.6
<i>short flashing</i>	P c
<i>very quick</i>	P 10.7
Gulf Coast Low Water Datum	H k
Gulf Stream limits	H u
Gun	R 10
<b>H</b>	
Hachures	C f
Harbor	
<i>installations</i>	F 10–34
<i>limit</i>	N 49
<i>master's office</i>	F 60
Harbors	F
Hard	J 39
Health office	F 62.1
Height	H p
<i>datum</i>	H 20
<i>drying</i>	H 20, I 15
<i>light (elevation of)</i>	H 20, P 13
<i>rocks</i>	K 10–11
<i>spot</i>	C 10–11, 13, H 20
<i>of structure</i>	E 4–5
<i>tide</i>	H 20, P 13
<i>of top of trees</i>	C 14
<i>of wellhead</i>	L 23
Heliport, Helipad	D 18
Hertz	B g
High water	H 18, 20
High Water Full and Change	H h
Higher High Water	H 20, b
Highest Astronomical Tide (HAT)	H 3
Highway	D 10
<i>markers</i>	D a

# Index

Hillocks	C 4	Joss house	E 13	<i>direction</i>	P 30.1–31
Horizontal		<b>K</b>		<i>disposition</i>	P 15
<i>light</i>	P 15	Kelp	J 13.1–13.2, u	<i>elevation</i>	P 13
<i>clearance</i>	D 21	Kilocycle	B k	<i>exhibited only when specially needed</i>	P 50
Horizontally disposed	P 15	Kilohertz	B h	<i>faint sector, with</i>	P 45.1–45.2
Horn	R 13	Kilometer	B 40	<i>float</i>	Q 30.1–31
Hospital	E g, F 62.2	Knot	B 52, H o	<i>in line</i>	P 21.1–21.2
Hour	B 49	<b>L</b>		<i>intensified sector, with</i>	P 46.1–46.2
Hulk	F 34, K 20–21, 23	Lake	C 21, 23	<i>landmarks, on</i>	P 7
<b>I</b>		<i>intermittent</i>	C 21	<i>leading</i>	P 20.1–23
IALA Maritime Buoyage System	Q 130	LANBY	P f	<i>marking fairway</i>	P 20.1–23
Ice		Landing		<i>Moiré effect</i>	P 31
<i>boom</i>	F 29.1	<i>beacon (cable)</i>	Q 123	<i>period</i>	P 12
<i>fast (ice front)</i>	N 60.1	<i>boats, for</i>	F 17	<i>range</i>	P 14
<i>sea ice (pack ice) seasonal</i>	N 60.2	<i>seaplanes, for</i>	N 13	<i>sector</i>	P 40.1–46.2
<i>signal station</i>	T 30	<i>stairs</i>	F 18	<i>special</i>	P 60–66
Illuminated	P 63	Landmarks	E	<i>structures</i>	P 1–7
Imprint	A 4	Lane, submarine transit	N 33	<i>synchronized</i>	P 66
Inadequately surveyed area	I 25	Large	J ai	<i>times of exhibition</i>	P 50–55
Inch	B c	Large Automatic Navigational Buoy (LANBY)	P f	<i>vessel</i>	P e, Q 32
Incineration area	N 65	Lateral marks (IALA System)	Q 130.1	Light characters	P 10.1–10.11
Indian Spring Low Water	H g	Latitude	B 1	Lighted	
Inshore traffic zone	M 25.1–25.2	Lattice beacon	Q 111	<i>beacon</i>	P 4, Q o
Installations, offshore	L	Lava	C 26, J 9, I	<i>beacon tower</i>	P 3
Intake pipe	L 41.1–41.2, b	Layout of chart	A	<i>marks</i>	Q 7–8
Intense	P 46.1–46.2	Leading		<i>mooring buoy</i>	Q 41
Intensified sector	P 46.1–46.2	<i>beacons</i>	Q 120	<i>offshore platform</i>	P 2.1–2.2
Intermittent river	C 21	<i>lights</i>	P 20.1–23	Lighthouse	P 1
International		<i>line</i>	M 1	Lights	P
<i>boundary</i>	N 40–41	Least depth	K 26–27, 30	Lights exhibited only when specially needed	P 50
<i>chart number</i>	A 2	<i>in narrow channel</i>	I 12	Lights in line	P 21.1–21.2
<i>nautical mile, sea mile</i>	B 45	Leisure facilities	U	Lights Marking Fairways	P 20.1–23
Interrupted light		Levee	F 1	Lights with limited times of exhibition	P 50–55
<i>quick</i>	P 10.6	Lifeboat	T 12–13	Limit of	
<i>ultra quick</i>	P 10.8	<i>mooring</i>	T 13	<i>area feature in general</i>	C q
<i>very quick</i>	P 10.7	<i>station</i>	T 12	<i>area into which entry is prohibited</i>	N 2.2, 31
Intertidal area	J 20–22	Lifting bridge	D 23.3	<i>contiguous zone</i>	N 44
Isogonic lines (Isogonals)	B 71	Light	J bc	<i>continental shelf</i>	N 46
Isolated danger mark	Q 130.4	<i>arc of visibility, with restricted</i>	P 44.1–44.2	<i>danger line</i>	K 1
Isophase light	P 10.3	<i>character</i>	P 10.1–11.8	<i>development area</i>	L 4
<b>J</b>		<i>chart limits, off</i>	P 8	<i>dredged area</i>	I 20
Jetty	F 14, a–c	<i>color</i>	P 11.1–11.8	<i>Exclusive Economic Zone (EEZ)</i>	N 47
		<i>description</i>	P 16	<i>fast ice</i>	N 60.1
				<i>fishery zone</i>	N 45
				<i>fishery area</i>	N b
				<i>Gulf Stream</i>	H u
				<i>nature reserve</i>	N 22
				<i>no discharge zone</i>	N i
				<i>restricted area</i>	M 14, N 2.1
				<i>routing measure</i>	M 14–15

# Index

<i>safety zone</i>	L 3
<i>sea ice (pack ice) seasonal</i>	N 60.2
<i>unsurveyed area</i>	I 25
Linear scale	A 14–15
Local magnetic anomaly	B 82.1–82.2
Lock	F 41.1–41.2
<i>signal station</i>	T 24
Log pond	F 29.1
Logo	A 12
Long-flashing light	P 10.5
Longitude	B 2
Lookout	
<i>pilot station</i>	T 2 T e
Low water	H 19, 20
<i>line</i>	I 30
Lower light	P 23
Lower low datum	H d
Lower low water	H e
Lower water full & change	H i
Lowest Astronomical Tide (LAT)	H 2
<b>M</b>	
Madrepores	J j
Magnetic	B q
<i>anomaly</i>	B 82.1–82.2
<i>compass variation</i>	B 68.1–71 B 68.1–71, p
Main light visible all-round	P 42.1–42.2
Major	
<i>light</i>	P 1
<i>light off chart limits</i>	P 8
Manganese	J q
Mangrove	C 32
Manually activated	P 56, R 2
Marabout	E 13
Marginal notes	A
Marina	F 11.1
<i>facilities</i>	U a
Marine	
<i>farm reserve</i>	K 48.1–48.2 N 22
Maritime limit	N 1.1–1.2

Marks	
<i>cardinal</i>	Q 130.3
<i>colored</i>	Q 101
<i>isolated danger</i>	Q 130.4
<i>lateral</i>	Q 130.1
<i>lighted</i>	Q 7–8
<i>minor</i>	Q 90–102.2
<i>new danger</i>	Q 130.7
<i>safe water</i>	Q 130.5
<i>special</i>	Q 130.6
<i>wreck (new danger)</i>	Q 130.7
Marl	J c
Marsh	C 33
Mast	
<i>radar</i>	E 30.1
<i>radio, television</i>	E 28
<i>wreck</i>	K 25
Mattes	J ag
Maximum	
<i>authorized draft</i>	M 6
<i>speed</i>	N 27
Mean	
<i>High Water (MHW)</i>	H 5, 20, 30
<i>High Water Neaps (MHWN)</i>	H 11
<i>High Water Springs (MHWs)</i>	H 9
<i>Higher High Water (MHHW)</i>	H 13, 30
<i>Higher Low Water (MHLW)</i>	H 14
<i>Low Water (MLW)</i>	H 4, 20, 30
<i>Low Water Neaps (MLWN)</i>	H 10
<i>Low Water Springs (MLWS)</i>	H 8
<i>Lower High Water (MLHW)</i>	H 15
<i>Lower Low Water (MLLW)</i>	H 12, 20, 30
<i>Sea Level (MSL)</i>	H 6, 20
<i>tide level</i>	H f
Measured Distance	Q 122
Medium	J 31
Megacycle	B l
Megahertz	B i
Meter	B 41
Microsecond	B f
Mid-channel buoy	Q e
Mile	
<i>nautical (sea mile)</i>	A 15, B 45
<i>statute</i>	B 25.1–25.2, e
<i>three nautical mile line</i>	N h
Military area	N 30–34
Millimeter	B 44
Minaret	E 17
Mine (explosive)	N 23.1

Mine (ore extraction)	E 36
Minefield	N 34
Mine-laying practice area	N 32
Minor	
<i>impermanant marks</i>	Q 90–92
<i>light</i>	P 1, note after P 5
<i>light floats</i>	Q 30.1–31
<i>marks</i>	Q 100–102.2
<i>pile</i>	F 22
<i>post</i>	F 22
Minute	
<i>of arc</i>	B 5
<i>of time</i>	B 50
Mixed bottom	J 12.1–12.2
Moiré effect light	P 31
Mole	F 12
Monument	E 24
Moored storage tanker	L 17
Mooring	
<i>berth number</i>	Q 42
<i>canal</i>	F f
<i>ground tackle</i>	L 18, Q 42
<i>life boat</i>	T 13
<i>numerous</i>	Q 44
<i>scientific mooring buoy</i>	Q r
<i>Single Buoy (SBM)</i>	L 16
<i>Single Point (SPM)</i>	L 12
<i>trot</i>	Q 42
<i>visitors'</i>	Q 45
<i>buoy</i>	Q 40–45
<i>lighted</i>	Q 41
<i>tanker</i>	L 16
<i>telegraphic</i>	Q 43
<i>telephonic</i>	Q 43
Morse Code	
<i>fog signal</i>	R a
<i>light</i>	P 10.9
Mosque	E 17
Motorway	D 10
Mud	C c, J 2
Muslim shrine	E a
Mussels	J s
<b>N</b>	
National	
<i>limits</i>	N 40–49
<i>park</i>	N 22
Natural	
<i>features</i>	C
<i>watercourse</i>	I 16

# Index

Nature	
<i>reserve of the seabed</i>	N 22 J
Nautical mile	B 45
Nautophone	R 13
Neap tide	H 10–11, 17, 30–31
Nets, tunny	K 44.2–45
New	
<i>edition date</i>	A 6
<i>danger mark</i>	Q 130.7
Nipa palm	C 31.5, 32
No anchoring area	N 20
No bottom found	I 13
No discharge zone	N i
Non-dangerous wreck	K 15, 29
Non-directional radiobeacon	S 10
Non-tidal basin	F 27
North	B 9
<i>cardinal mark</i>	Q 130.3
Northeast	B 13
Northwest	B 15
Notes	A 11, 16
Notice board	Q 126, T d
Notice to mariners	A 7
Nun buoy	Q 20
<b>O</b>	
Obelisk	E 24
Obscured sector	P 43.1–43.2
Observation spot	B 21
Obstruction	K 40–48.2
light, air	P 61.1–61.2
Occasional light	P 50
Occulting light	P 10.2
Ocean current	H 43
ODAS buoy	L 25, Q 58
Office	
<i>customs</i>	F 61
<i>harbormaster's</i>	F 60
<i>health</i>	F 62.1
<i>pilot</i>	T 2–3
<i>quarantine</i>	F e

Offshore	
<i>Installations</i>	L
<i>platform, lighted</i>	P 2.1–2.2
<i>position, tidal levels</i>	H 47
Ogival buoy	Q 20
Oil	
<i>barrier</i>	F 29.1–29.2
<i>derrick</i>	L 10
<i>installation buoy, Catenary Anchor Leg</i>	L 16
<i>Mooring (CALM)</i>	
<i>pipeline</i>	L 40.1
<i>pipeline area</i>	L 40.2
Oilfield with name	L 1
One-way track	M 5.1–5.2, 27.3
Ooze	J b
Opening bridge	D 23.1
Orange	J ax, P 11.7
Ordnance, unexploded	K p
Outfall pipe	L 41.1–41.2
Overfalls	H 44
Overhead	
<i>cable</i>	D 27
<i>pipe</i>	D 28
<i>transporter</i>	D 25
Oysters	J r
<b>P</b>	
Pack ice, limit	N 60.2
Paddy field	C n
Pagoda	E 13
Painted board	Q 102.2
Palm	C 31.4
Park ranger station	T g
Particularly Sensitive Sea Area (PSSA)	N 22
Patent slip	F 23
Path	D 12
Pebbles	J 7
Perch	Q 91
Period of light	P 12
Pictorial sketches	E 3.1–3.2
Pier	F 14
<i>promenade</i>	F 15
<i>ruined</i>	F 33.2

Pile	F 22
<i>submerged</i>	K 43.1–43.2
Pillar	
<i>buoy</i>	Q 23
<i>monument</i>	E 24
Pilot	T 1–4
<i>boarding place</i>	T 1.1–1.3
<i>helicopter transfer</i>	T 1.4
<i>look out</i>	T 2
<i>office</i>	T 2–3
Pilotage	T 1–4
Pipe	
<i>intake</i>	L 41.1–41.2, b
<i>outfall</i>	L 41.1–41.2
<i>overhead</i>	D 28
<i>pneumatic (bubbler)</i>	F 29.2
Pipeline	
<i>buried</i>	L 42.1
<i>land, on</i>	D 29
<i>overhead</i>	D 28
<i>submarine</i>	L 40.1–44
<i>tunnel</i>	L 42.2
Platform	L 2, 10, 13–14, 22, P 2
<i>cleared</i>	L 22
<i>submerged</i>	K i
Point	
<i>base point for territorial sea baseline</i>	N 42
<i>fixed</i>	B 22
<i>Single Point Mooring (SPM)</i>	L 12
<i>symbols, position</i>	B 32–33
<i>triangulation</i>	B 20
Pole	Q 90
Police station, marine	T b
Polyzoa	J ad
Pontoon	F 16
<i>bridge</i>	D 23.5
Port	
<i>pilotage service, with</i>	T 4
<i>signal station</i>	T 21–23
Ports	F
Position	
<i>accurate</i>	B 2, E 2
<i>approximate</i>	B 7, E 2
<i>of buoy or beacon</i>	Q 1
<i>doubtful</i>	B 8
<i>of fog signal</i>	R 1
<i>of pilot cruising vessel</i>	T 1.1–1.3
<i>tidal levels</i>	H 47
<i>tidal stream data</i>	H 46



# Index

Positions <i>symbolized</i>	B B 30–33
Post <i>covers and uncovers</i> <i>office</i> <i>submerged</i>	F 22, K 43.1 K r F 63 K 43.1
Power <i>overhead cable</i> <i>submarine cable</i> <i>transmission line</i>	D 26, H 20 L 31.1–31.2 D h
Practice area (military)	N 30–34
Precautionary area	M 16, M 24
Preferred channel buoy	Q 130.1
Private <i>buoy</i> <i>light</i>	Q 70 P 50, 65
Production <i>platform</i> <i>well</i>	L 10 L 20
Prohibited <i>anchoring</i> <i>area</i> <i>diving</i> <i>fishing</i>	N 20 N 2.2, 31 N 21.2 N 21.1
Promenade pier	F 15
Protective structures	F 1–6.3
Pteropods	J ac
Public Buildings	F 60–63
Publication note	A 4
Pumice	J m
Pump-out facilities	F d
Pylon	D 26, E 29
<b>Q</b>	
QTG service	S 15
Qualifying Terms	J 30–39
Quarantine <i>anchorage area</i> <i>building, health office</i> <i>office</i>	N 12.8 F 62.1 F e
Quarry	E 35.1–35.2
Quartz	J g
Quay	F 13
Quick light	P 10.6

<b>R</b>	
Races	H 44
Racon	S 3.1–3.6
Radar <i>beacon</i> <i>conspicuous feature</i> <i>dome (radome)</i> <i>mast</i> <i>range</i> <i>reference line</i> <i>reflector</i> <i>scanner</i> <i>station</i> <i>surveillance system</i> <i>tower</i> <i>transponder beacon, racon</i> <i>transponder beacons on floating</i> <i>marks</i> <i>tower</i>	S 2–3.6 S 5 E 30.4 E 30.1 M 31 M 32.1–32.2 Q 10–11, S 4 E 30.3 S 1 M 30–32.2 E 30.2 S 3.1–3.6 S 3.6 E 29
Radio <i>direction-finding station</i> <i>mast</i> <i>reporting line</i> <i>reporting point, calling-in or way point</i> <i>station, QTG service</i>	S 10–18.7 S 14 E 28 M 40.2 M 40.1 S 15
Radiobeacon	S 10–16
Radiolaria	J ab
Radome	E 30.4
Railway <i>station</i>	D 13, b D 13
Ramark	S 2
Ramp	F 23
Range	P 14
Rapids	C 22
Rate	H n
Rear light	P 22
Reclamation area	F 31
Recommended <i>deep water track</i> <i>direction of traffic flow</i> <i>route</i> <i>track</i>	M 27.3, a–b M 11, 26.1–26.2, 28.1 M 28.1 M 3–4, 6
Red	J ay, P 11.2, Q 3
Reed beds	C 33
Reef	J 22, K 16, g–h, m

Reference to <i>adjoining chart</i> <i>charted units</i> <i>larger-scale chart</i>	A 19 A b A 18
Reflector, radar	Q 10–11, S 4
Refuge <i>beacon</i> <i>for shipwrecked mariners</i>	Q 124 T 14
Regions, IALA	Q 130.1
Relief	C 10–14
Reported <i>anchorage</i> <i>danger</i> <i>depth</i>	N 10 I 4 I 3.1–4
Reporting, radio	M 40.1–40.2
Rescue station	T 11–12
Reservation line	N f
Reserve fog signal	R 22
Reserved anchorage area	N 12.9
Resilient beacon	P 5
Restricted <i>area</i> <i>light sector</i>	M 14, N 2.1, 20–27 P 44.1–44.2
Retroreflecting material	Q 6
Rice paddy	C n
Riprap	P a
River <i>intermittent</i>	C 20 C 21
Road	D 10–11
Rock	J 9.1, K 10–15, a–b
Rocket station	T 12
Rocky <i>area which covers and uncovers</i>	J 9.1 J 21
Roll-on, Roll-off ferry terminal (RoRo)	F 50
Rotating-pattern radiobeacon	S 12
Rotten	J aj
Roundabout	M 21
Route	M 27.1–28.2
Routing Measures	M 18–29.2
Rubble	C e
Ruin	D 8, F 33.1

# Index

Ruined landmark pier	D 8 F 33.2	Sector lights	P 40.1–46.2	Soft	J 35
<b>S</b>		See adjoining chart	A 19	Sounding datum	I 10–16 C a, b, K h
Safe clearance depth	K 3, 30, f	Semaphore	T f	doubtful depth	I 2
vertical clearance	D 26, i	Semi-diurnal tide	H 30	out of position	I 11
water mark	Q 130.5	Separation line	M 12	unreliable	I 14
Safety fairway zone	M 18 L 3	scheme zone	M 10–13, 20.1–29.2 M 13	Source diagram	A 17
Sailing club	F 11.3	Services	T	South cardinal mark	B 11 Q 130.3
Salt pans	C 24	Settlements	D 1–8	Southeast	B 14
Sand	C c, J 1	Sewer	L 41.1–41.2	Southwest	B 16
Sandhills	C 8	Shading	C g	Spar buoy	Q 24
Sandwaves	J 14	Shapes of buoys	Q 20–26	Special lights	P 60–66
Sandy shore	C 6	Shark nets	F 29.1	marks	Q 130.6
Satellite Navigation System	S 50–51	Shed, transit	F 51	purpose beacon	Q 120–126
Scale	A 13–15	Shellfish bed	K 47	purpose buoy	Q 50–71
Scanner, radar	E 30.3	Shells	J 11	Speckled	J al
Schist	J h	Shingle	C c, J d	Speed limit	N 27
School	E f	Shingly shore	C 7	Spherical buoy	Q 22
Scoriae	J o	Shoal sounding on rock	K b	Spicules	J x
Scrubbing grid	F 24	Shore, shoreline	C 1–8	Spindle buoy	Q 24
Sea mile (nautical mile)	A 15, B 45	Short-long flashing	P b	Spire	E 10.3
Seabed, types of	J 1–15, a–bf	Shrine	E 13	Spoil ground	N 62.1–62.2
Seagrass	J 13.3	Signal fog stations	R T 20–36	Sponge	J t
Seal chart producer sanctuary	A 12 N 22	Silo	E 33	Spot height	C 10–11, 13, H 20
Seaplane anchorage	N 14	Silt	J 4	Spring tide seabed	H 16, 30–31 J 15
landing area, operating area	N 13	Single Anchor Leg Mooring (SALM)	L 12	Square meter	B a
Seasonal buoy	Q 71	Buoy Mooring (SBM)	L 16	shaped beacon	Q I
sea ice limit	N 60.2	Point Mooring (SPM)	L 12	Stake	K 43.2, Q 90
Sea-tangle	J w	Sinker	K n	Station Coast Guard	T 10–11
Seawall	F 2.1–2.2	Siren	R 12	coast radar	M 30, S 1
Seaward limit of contiguous zone territorial sea	N 44 N 43	Sketches	E 3.1–3.2	DGPS, providing corrections	S 51
Second of arc	B 6	Slack water	H 31	QTG, providing radio service	S 15
of time	B 51	Slipway	F 23	radar surveillance	M 30
		Small	J ah	radio direction finding	S 14
		Small craft leisure facilities mooring	U Q 44	railway	D 13
		Snag	K 43.2	rescue	T 11–12
				signal	T 20–36
				tide	H 30
				Statute	E 24
				Statute mile	B e

# Index

Steep coast	C 3	Surveyed <i>coastline</i>	C 1	<i>scale</i>	T 32.1
Steps	F 18	<i>inadequately</i>	I 25	<i>signal station</i>	T 33
Sticky	J 34	Suspended well	L 21.1–21.2	<i>table</i>	A g, H 30–31
Stiff	J 36	Swamp	C 33	Timber yard	F 52
Stock number	A d	Swept <i>area</i>	I 24, b	Time	
Stones	C 7, J 5	<i>channel</i>	I a	<i>signal station</i>	T 31
<i>area with</i>	J 20	<i>wire drag, by</i>	K 2, 27, 42, f	<i>units of</i>	B 49–51
Stony shore	C 7	Swing bridge	D 23.2	Tomb	E b
Storage tanker	L 17	Swinging circle	N 11.2	Ton, tonnage, tonne (weight)	B 53, m
Storm signal station	T 28	Symbolized positions	B 30–33	Topmark	Q 9–11, 82, 102.1
Straight territorial sea baseline	N 42	Synchronized light	P 66	Tower	E 20
Strand	C c	<b>T</b>		<i>beacon</i>	P 3, Q 110–111
Streaky	J ak	Tanker		<i>church</i>	E 10.2
Stream	C 20, H l, l c	anchorage area	N 12.5	<i>radar</i>	E 30.2
<i>Gulf</i>	H u	CALM	L 16	<i>radio</i>	E 29
<i>tidal signal station</i>	T 34	storage, moored	L 17	<i>television</i>	E 29
<i>tidal table</i>	H 31, 46	Tank	E 32	<i>water</i>	E 21
<i>tide</i>	H 40–41	Telegraphic mooring buoy	Q 43	Track	D 12, M 1–6, 27.3
Street	D 7	Telephone	E q	Traffic	
Strip light	P 64	<i>line</i>	D 27	<i>separation scheme (TSS)</i>	M 10–15, 20–26.2
Stumps of piles/posts	K 43.1–43.2	Telephonic mooring buoy	Q 43	<i>basic symbols</i>	M 10–15
Submarine		Television		<i>example</i>	M 18–29.2
<i>cable</i>	L 30.1–32	<i>mast</i>	E 28	<i>signal station</i>	T 21–22, 25.1
<i>cable area</i>	L 30.2	<i>station</i>	E 27	<i>surveillance station</i>	M 30
<i>exercise area</i>	N 33	<i>tower</i>	E 29	Training wall	F 5
<i>pipeline</i>	L 40–44	Temple	E 13	Transhipment	
<i>power cable</i>	L 31.1	Temporary		<i>area</i>	N 64
<i>power cable area</i>	L 31.2	<i>buoy (seasonal)</i>	Q 71	<i>facilities</i>	F 50–53.2
<i>transit lane</i>	N 33	<i>light</i>	P 54	Transit	
<i>volcano</i>	K d	Tenacious	J aq	<i>lane (submarine)</i>	N 33
Submerged		Terms relating to tidal levels	H 1–17, a–k	<i>line</i>	M 2
<i>crib</i>	K i	Territorial Sea	N 42–43	<i>shed</i>	F 51
<i>duck blind</i>	K k	Tidal		Transmission line	D 26–27, h
<i>jetty</i>	F b	<i>basin</i>	F 28	Transmitter, AIS	S 17.1–17.2
<i>platform</i>	K l	<i>harbor</i>	F 28	Transponder beacon	S 3.1–3.6
<i>production well</i>	L 20	<i>levels</i>	H 1–17, 20	Transporter	
<i>rock, beacon on</i>	Q 83	<i>stream</i>	H 1	<i>bridge</i>	D 24
<i>well (buoyed)</i>	L a	<i>signal station</i>	T 34	<i>overhead (aerial cableway)</i>	D 25
<i>wreck</i>	K 22–23, 26–30	<i>station</i>	H 46	Trap, fish	K 44.2–45, Q i
Subsidiary light	P 42.1–42.2	<i>table</i>	A g, H 31	Traveling crane	F 53.1
Subsurface Ocean Data Acquisition System (ODAS)	L 25	<i>streams and currents</i>	H 40–47	Trees	
Sunken		<i>table</i>	H 30	<i>height of top</i>	C 14
<i>danger (swept)</i>	K f	Tide		<i>types of</i>	C 31–32, i–k
<i>wreck</i>	K c	<i>gauge</i>	T 32.1–32.2	Triangular shaped beacon	Q i
Superbuoy	Q 26	<i>level terms</i>	H 1–17, a–k	Triangulation point	B 20
Supply pipeline	L 40.1–40.2	<i>rips</i>	H 44	Trot, mooring	Q 42
				True (compass)	B s

# Index

Tufa	J n		
Tun buoy	Q 25		
Tunnel <i>pipeline</i>	D 16 L 42.2		
Tunney nets <i>area</i>	K 44.2–45 K 45		
Turbine <i>wind</i> <i>underwater</i>	E 26.1, L 5.1 L 24		
Two-way <i>route</i> <i>track</i>	M 27.2, 28.1–28.2 M 4, 5.2		
Tyfon	R 13		
Types of <i>fog signals</i> <i>seabed, intertidal areas</i>	R 10–16 J 20–22		
<b>U</b>			
Ultra quick light	P 10.8		
Uncovers	K 11, 21, h		
Under construction	D d, F 30–32		
Underwater <i>installations</i> <i>rock</i> <i>turbine</i>	L 20–25 K 13–15 L 24		
Uneven	J bf		
Unexploded ordinance	K p		
Units	A b, B 40–54		
University	E h		
Unsurveyed <i>coastline</i> <i>depths</i>	C 2 I 25		
Unwatched, unmanned light	P 53, e		
Update	A 7		
Upper light	P 22		
Urban area	D 1		
<b>V</b>			
Variation, magnetic	B 68.1–71, p		
Varied	J be		
Various limits	N 60.1–65		
Vegetation	C 30–33, i–t		
Velocity	H n		
Vertical <i>clearance</i> <i>color striped</i> <i>lights</i>	D 22, 23.1, 23.4, 23.6–28 Q 5 P 15		
Vertically disposed	P 15		
Very quick light	P 10.7		
Vessel, light	P e		
Viaduct	D f		
Views	E 3.1–3.2		
Village	D 4		
Violet	J at, P 11.5		
Virtual AIS	S 18.1–18.7		
Visitor's <i>berth</i> <i>mooring</i>	F 19.2 Q 45		
Volcanic <i>ash</i>	J 37 J k		
Volcano	K d		
<b>W</b>			
Wall, training	F 5		
Warehouse	F 51		
Water <i>discolored</i> <i>features</i> <i>intake</i> <i>pipeline</i> <i>pipeline area</i> <i>tank</i> <i>tower</i>	K e C 20–25 L 41.1–41.2, b L 40.1, 41.1 L 40.2, L 41.2 E 21 E 21		
Waterfalls	C 22		
Watermill	E c		
Wave <i>actuated fog signal</i> <i>farm</i>	R 21–22 L 6		
Way point	M 40.1		
Weather signal station	T 29		
Weed	J 13.1–13.2		
Weir, fish	K 44.2		
Well <i>submerged</i> <i>suspended</i> <i>production</i>	E e L a L 21 L 20		
Wellhead	L 21.1–21.2, 23		
West <i>cardinal mark</i>	B 12 Q 130.3		
Wet dock	F 27		
Wharf	F 13		
Whistle <i>buoy</i>	R 15 Q c		
White	J ar, P 11.1		
Wind <i>farm</i> <i>signal station</i> <i>turbine</i>	E 26.2, L 5.2 T 29 E 26.1, L 5.1		
Windmill	E 25.1–25.2		
Withy	Q 91–92		
Woodland <i>coniferous</i> <i>deciduous</i>	C j C i		
Woods, wooded	C 30		
Works <i>at sea, (reclamation area)</i> <i>on land</i> <i>under construction, works in progress</i>	F 31 F 30 F 32		
World Geodetic System (WGS)	S 50		
Wreck <i>buoy (marking new danger)</i> <i>mast</i>	K 20–30, c Q 130.7 K 25		
<b>Y</b>			
Yacht <i>berths without facilities</i> <i>club</i>	F 11.2 F 11.3		
Yard <i>timber</i>	B d F 52		
Yellow	J aw, P 11.6		
<b>Z</b>			
Zone <i>Exclusive Economic Zone (EEZ)</i> <i>fishing</i> <i>inshore traffic</i> <i>seaward, contiguous</i> <i>separation</i>	N 47 N 45 M 25.1–25.2 N 44 M 13, 20.1–20.3		

# IALA Maritime Buoyage System Appendix 1

## Region A Lateral Marks

### Port Hand

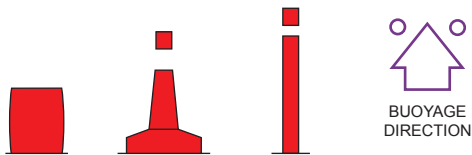

### Starboard Hand

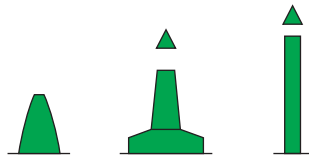

red	Color	green
cylindrical (can), pillar, spar	Buoy	conical (nun), pillar, spar
single red cylinder (can)	Topmark (if any)	single green cone, point upward

Lights (if any): may have any phase characteristic other than that used for preferred channels		
	Quick Flashing	
	Flashing	
	Long Flashing	
	Group Flashing	

### Preferred Channel to Starboard

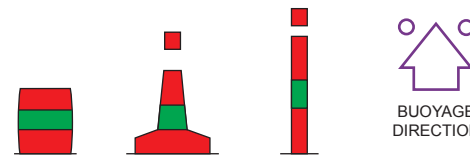

### Preferred Channel to Port

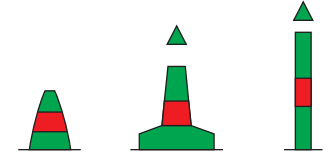

red with one green horizontal band	Color	green with one red horizontal band
cylindrical (can), pillar, spar	Buoy	conical (nun), pillar, spar
single red cylinder (can)	Topmark (if any)	single green cone, point upward

Lights (if any) are composite group flashing		
	FI (2+1)	

# Appendix 1 IALA Maritime Buoyage System

## Region B Lateral Marks

Port Hand

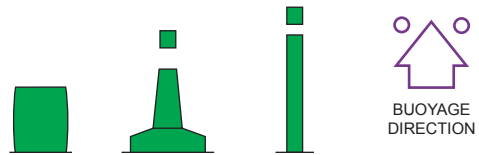

Starboard Hand

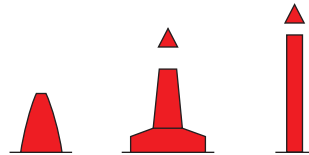

Preferred Channel  
to Starboard

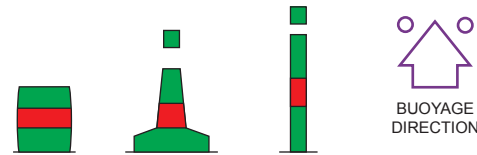



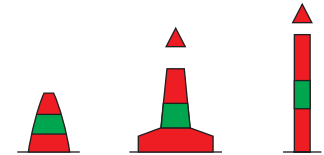







Preferred Channel  
to Port



green	Color	red
cylindrical (can), pillar, spar	Buoy	conical (nun), pillar, spar
single green cylinder (can)	Topmark (if any)	single red cone, point upward

green with one red horizontal band	Color	red with one green horizontal band
cylindrical (can), pillar, spar	Buoy	conical (nun), pillar, spar
single green cylinder (can)	Topmark (if any)	single red cone, point upward

Lights (if any): may have any phase characteristic other than that used for preferred channels		
	Quick Flashing	
	Flashing	
	Long Flashing	
	Group Flashing	

Lights (if any) are composite group flashing		
	FI (2+1)	

## Cardinal Marks in Regions A and B

Lights, when fitted, are white

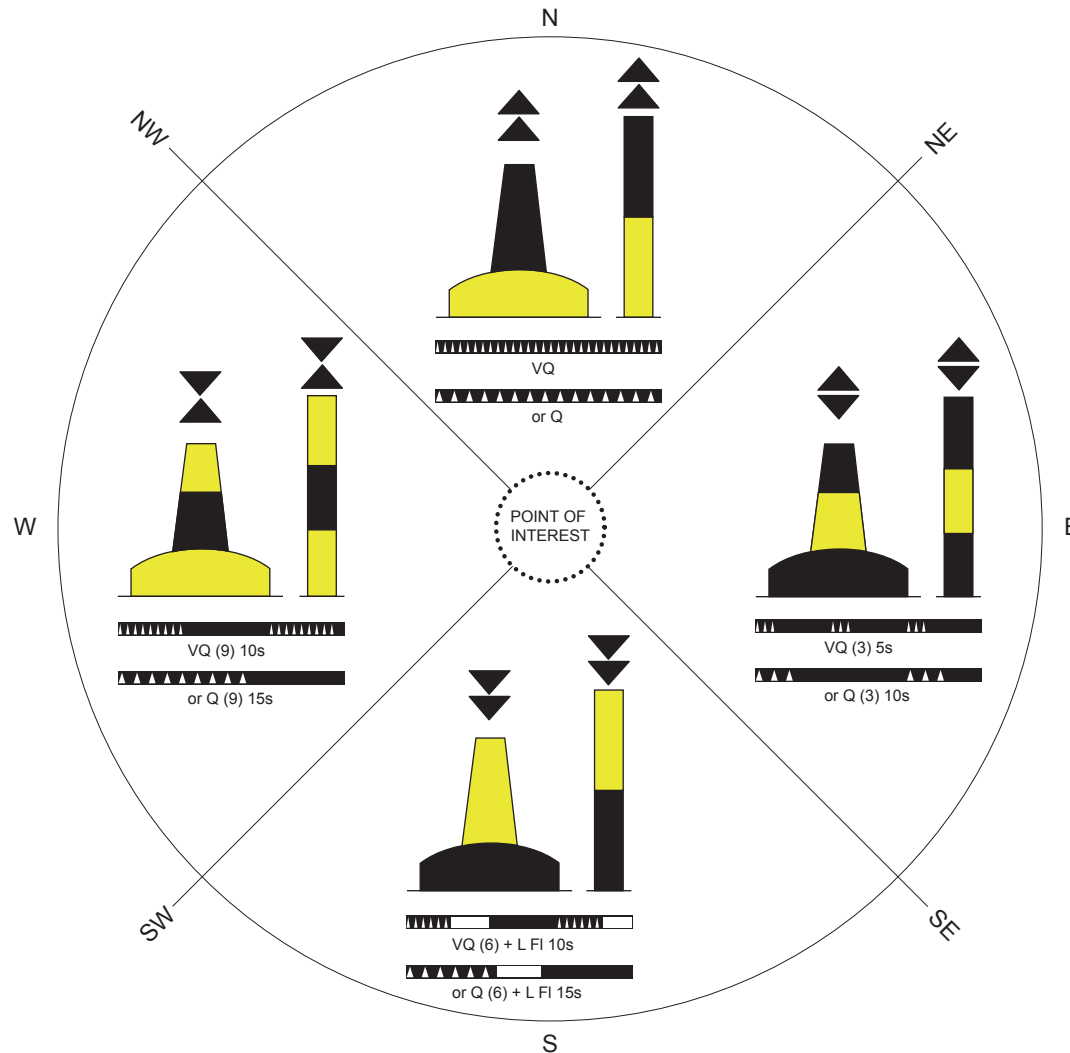

# Appendix 1 IALA Maritime Buoyage System

## Regions A and B

### Isolated Danger Marks

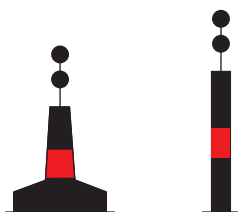

Color	black with one or more red horizontal band(s)
Buoy	optional, but not conflicting with lateral marks; pillar or spar preferred
Topmark (if any)	always fitted with double spheres

Lights (if any)	
Color	white
Rhythm	group flashing

### Safe Water Marks

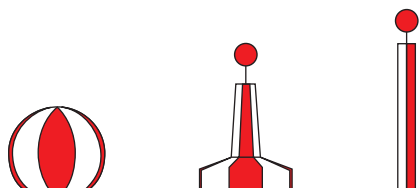

Color	red and white vertical stripes
Buoy	spherical, pillar or spar
Topmark (if any)	single red sphere

Lights (if any)	
Color	white
Rhythm	Iso
	Oc
	L FI 10s
	Morse "A"

### Safe Water Marks

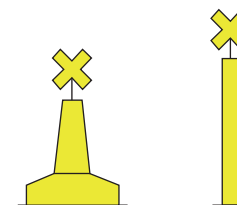

Color	yellow
Buoy	optional, but not conflicting with lateral marks
Topmark (if any)	single yellow "X" shape

Lights (if any)	
Color	yellow
Rhythm	Fl Y
	Fl (4) Y
	May have any rhythm other than those used for white lights on cardinal, isolated danger or safe water marks.





## Section Key

<b>A</b>		Chart Number, Title and Marginal Notes	INT 500 412 Mercator Projection Scale 1:100,000 at Lat. 59°30' 53rd Ed., Feb. 2019 DEPTHS IN METERS
<b>B</b>		Positions, Distances, Directions and Compass	 ±15° Magnetic Variation 4°30'W 2011 (8'E) LOCAL MAGNETIC ANOMALY (see note)
<b>C</b>		Natural Features	
<b>D</b>		Cultural Features	
<b>E</b>		Landmarks	
<b>F</b>		Ports	
<b>H</b>		Tides and Currents	
<b>I</b>		Depths	
<b>J</b>		Nature of the Seabed	
<b>K</b>		Rocks, Wrecks and Obstructions	
<b>L</b>		Offshore Installations	
<b>M</b>		Tracks and Routes	
<b>N</b>		Areas and Limits	
<b>P</b>		Lights	
<b>Q</b>		Buoys and Beacons	
<b>R</b>		Fog Signals	
<b>S</b>		Radar, Radio and Satellite Navigation Systems	
<b>T</b>		Services	
<b>U</b>		Small Craft (Leisure) Facilities	