

RADIO'S CONQUEST OF SPACE

by DONALD McNICOL

- YOSI
- MUIRHEAD
- KINTNER
- PICKARD
- FOULSER
- GOLDSCHMIDT
- HEAVISIDE
- KENNELLY
- ARMSTRONG
- MORECROFT
- LOGWOOD
- VON ARCO
- MEISSNER
- GOLDSMITH
- THOMSON
- LODGE
- BRANLY
- MARCONI
- FLEMING
- BRUNN
- ZENNECK
- HENRY
- DOLBEAR
- STONER
- BELLINI
- VAN DER BIJL
- SCHELLENG
- HEISING
- ALEXANDERSON
- WEAGANT
- FESSENDEN
- BEVERAGE
- JEWETT
- COLPITTE
- DUBILIER
- RICE
- HARTLEY
- TAGGART
- ROUND
- BOLITHO
- LATOUR
- LEVY
- PIERCE
- CADY
- LANGMUIR
- HEWLETT
- HERTZ
- DE FOREST
- EDISON
- PUPIN
- TESLA
- NICHOLS

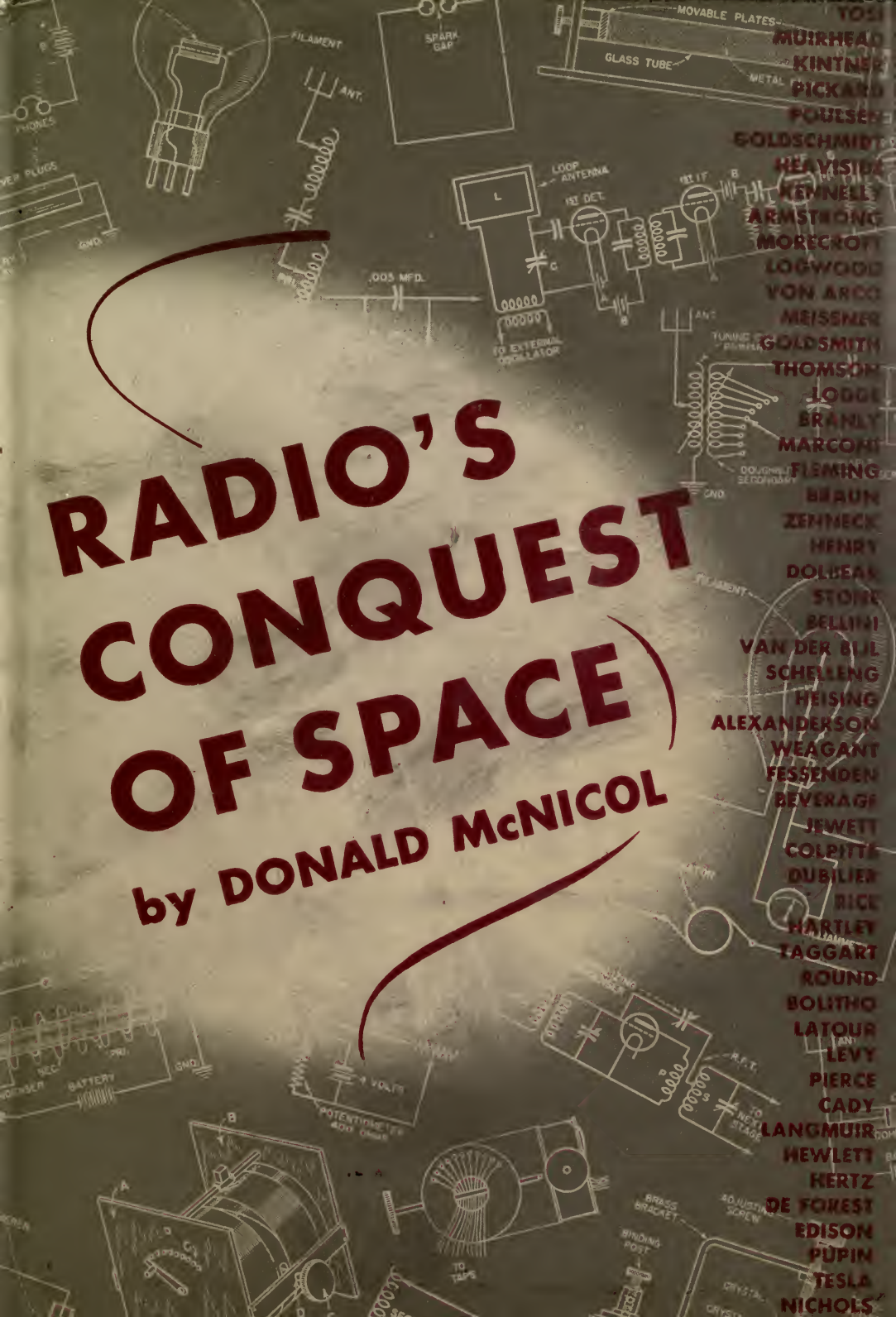

RADIO'S CONQUEST OF SPACE

The Experimental Rise in Radio
Communication

by

DONALD McNICOL

Here is the personalized history of what we know today as *radio*. It is the story of the men whose skill and imagination produced the inventions and refinements that have made radio a vast peacetime business and a formidable wartime weapon. Not only scientists, but also talented amateurs contributed to the progress of radio, and in all the Western nations, in laboratories and in lofts, they applied their ingenuity and resourcefulness to the perfecting of radio communication.

Although essentially nontechnical, the story includes descriptions and discussions of the technical developments from the time of Hertz's waves to the present day. The author shows how some discoveries were come upon accidentally and how others were made by more than one researcher working independently. He shows, too, how, once the possibility of communication without intervening wires had been demonstrated, a host of teachers, scientists, and amateurs attacked the various problems involved in improving transmitting and receiving equipment and antennas, in

[Continued on back flap]

From the collection of the

o P^{z n m}re^ainger^a
v Library
t p

San Francisco, California
2006

WASONS
CONQUEST OF SPACE

RADIO'S CONQUEST OF SPACE

CONQUEST OF SPACE

THE CONQUEST OF SPACE
BY RADIO



THE CONQUEST OF SPACE
BY RADIO

RADIO'S CONQUEST OF SPACE

The Experimental Rise in Radio Communication

By DONALD McNICOL

Past President, The Institute of Radio Engineers



MURRAY HILL BOOKS, INC.

New York



London

RADIO'S

MURRAY HILL BOOKS, INC.,
is a subsidiary of

RINEHART & COMPANY, INC.

The Experimental Rise in Radio
Communication

BY DONALD MCNICOL

First Edition, 1946. 128 pages. 5 1/2 x 8 1/2 inches.



MURRAY HILL BOOKS, INC.

120 EAST 57th STREET, NEW YORK 22, N. Y.

COPYRIGHT, 1946, BY DONALD MCNICOL

PRINTED IN THE UNITED STATES OF AMERICA

BY J. J. LITTLE AND IVES COMPANY, NEW YORK

ALL RIGHTS RESERVED

Preface

In this work the author makes no attempt to romanticize the history of radio. Rather, radio is treated as a great new utility created by men of genius who hearkened less to outside inspiration than to voices within themselves: men (and boys) of pioneering spirit who through enthusiasm and diligence studied and experimented, often with meager equipment, until desired results were attained. The work supplies a readable record of radio achievement having somewhat chronological treatment, which will enable radio workers to live over again days and nights of attachment to a labor that held their interest constant. The book, without mathematics, presents a narrative of experimental achievement which boys and young men will find stimulating, while at the same time they acquire a knowledge of how radio started and how it grew. The layman, also, by perusing this work may learn how radio operates, since the knowledge of its construction and working today is built up from its elementary beginning. And, because of the manner in which the various scientists, engineers, and experimenters are identified, the reader may recognize the many consecutive contributions as achievements of real people.

DONALD McNICOL.

*Roselle Park,
New Jersey.*

In this work the author makes an attempt to reconstruct the history of the study of the human mind, and to show how the various theories and methods have developed. The author is not a philosopher, but a psychologist, and his interest is in the scientific study of the mind. He is not a student of the history of psychology, but a student of the mind itself. He is not a student of the history of psychology, but a student of the mind itself. He is not a student of the history of psychology, but a student of the mind itself.

Prologue

1913
New York

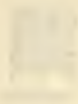

Acknowledgments

For the privilege of using portions of technical articles written by the author and published in *Radio Engineering*, *Projection Engineering*, and *Communications* magazines, my thanks are extended to the Bryan Davis Publishing Company, New York, and to Lewis Winner, editor. In appreciation of like permission to abstract from articles contributed to *Telegraph and Telephone Age*, thanks are extended to Carl A. Nelson, publisher. To George H. Clark, of the Radio Corporation of America, New York, the author is indebted for certain photographs and other illustrations, and for many hours of agreeable discourse on radio historical matters. And to Alfred A. Ghirardi, radio author and engineer, New York, thanks are due for consultation and for typescript reading.

Acknowledgments

The author is indebted to many persons at technical schools
where the data were obtained and published in *Radio Engineering*,
Electrical Engineering and *Communications Engineering*.
The author is indebted to the Bureau of Standards for the loan of
equipment. The author is indebted to the Bureau of Standards for the
loan of the *Radio Engineering* and *Communications Engineering* series.
The author is indebted to the Bureau of Standards for the loan of
equipment. The author is indebted to the Bureau of Standards for the
loan of the *Radio Engineering* and *Communications Engineering* series.
The author is indebted to the Bureau of Standards for the loan of
equipment. The author is indebted to the Bureau of Standards for the
loan of the *Radio Engineering* and *Communications Engineering* series.
The author is indebted to the Bureau of Standards for the loan of
equipment. The author is indebted to the Bureau of Standards for the
loan of the *Radio Engineering* and *Communications Engineering* series.

Contents

	PAGE
PREFACE	v
ACKNOWLEDGMENTS	vii
CHAPTER	
1. ELECTRICITY, THE FORERUNNER	3
2. HIGH VOLTAGE BY INDUCTION	11
3. ADVANCES IN ELECTRICAL KNOWLEDGE	18
4. ELECTROMAGNETIC WAVES	26
5. "WIRELESS" VENTURES FROM THE LABORATORY	36
6. FIRST STEPS IN AMERICA	47
7. INTERSTATION SELECTIVITY	57
8. IMPROVING TRANSMITTERS	69
9. WORKING TOWARD ANTENNA IMPROVEMENT	82
10. SPARK GAPS AND OSCILLATORS	98
11. DEVELOPMENT OF ELECTRIC WAVE DETECTORS	106
12. IMPROVEMENTS IN DETECTORS	120
13. WIRELESS SPANS THE ATLANTIC	132
14. THE NATURE OF WIRELESS RADIATION	144
15. THE MAGIC BULB	156
16. VACUUM TUBE DEVELOPMENT	169
17. ELECTRIC WAVE PROPAGATION	185
18. THE TREND TO SHORTER WAVE LENGTHS	197

CHAPTER	PAGE
19. THE PROBLEM OF ATMOSPHERIC NOISE	206
20. THE AUDION APPLIED TO WIRE TELEPHONY	218
21. EARLY WIRELESS TELEPHONY	222
22. VACUUM TUBES AND RADIO-TELEPHONE TRANSMITTERS	234
23. RADIO RECEIVERS	242
24. REGENERATIVE RECEIVERS	260
25. REVOLUTIONARY RECEIVER DEVELOPMENTS	272
26. THE ADVENT OF COMMERCIAL RADIO	285
27. TRANSMISSION PROGRESS	305
28. CHILDREN OF THE AUDION	317
29. DELIVERY OF THE SERVICE	329
30. THE EXPANDING SPHERE OF RADIO	351
NAME INDEX	365
SUBJECT INDEX	371

RADIO'S CONQUEST OF SPACE

RADIO'S CONQUEST OF SPACE

Electricity, the Forerunner

Like many other epochal achievements the conquest of space by radio was begun on a small scale, with meager knowledge and with improvised tools. As far back as the year 1820, a scholarly Dane of melancholy mien bridged space when he observed that by excited gesticulations a magnetic needle was endeavoring to announce the receipt of a momentous message from an electrically charged wire a short distance away. And now, in the year 1945, the world is geared to a variety of radio services. Not many occupations nor many private or public services have missed the revolutionizing influences of signaling through space.

There is substance in the view that radio came into the hands of men somewhat suddenly; for, considered in the range of the centuries, a generation of time may be marked off as a small measure, as a brief period. The suddenness of the advent of radio and the unpromising evidences with which it first attracted attention very likely were reasons why men and boys used it as a toy during about half the years the art was growing from an idea to a dominant force in the affairs of nations, industries, education, and entertainment.

In the popular mind the name of Guglielmo Marconi is inseparably linked with the discovery, or the invention, of wireless signaling. Marconi, of Italian-Irish extraction, in the year 1894 by chance picked up a periodical in which appeared an account of the electric wave experiments of Heinrich Hertz, and shortly thereafter came into possession of a book published in America by T. C. Martin, which, in Chapter 26, dealt with the subject of high-frequency alternating currents.

The term "wireless" as applied to radio is something of a misnomer. Although no wires are employed to bridge the space between transmitting and receiving stations, actually in apparatus assemblies much wire is used; also magnets, coils, condensers, transformers, microphones, and much other electrical equipment common to systems requiring interstation wire connection. In order to present a well-rounded story, therefore, it is necessary to review certain electrical inventions and developments that preceded radio, and which are in fact the laboratory gadgets from which radio instruments and systems are constructed.

A New Force

In the year 1729, in England, Stephen Gray gathered up the meager threads of prior knowledge and pointed out the difference between conductors and insulators of electricity. By experiment Gray demonstrated that certain substances, such as metals, are conductors and that other substances, such as glass and silk, are nonconductors, or insulators. At that early time the force known as electricity was little understood. In fact, a half century after Gray, Luigi Galvani, in Italy, experimenting with the elusive force, thought he had discovered it to be a vital fluid, a cause of vitality. But Galvani's compatriot, Alessandro Volta, reviewing the experimental results, learned that in fact Galvani had unknowingly discovered a new method of producing electricity—by chemical action.

There would be little point in directing criticism at Galvani or Volta because fourteen years elapsed before the appearance of the first battery for the production of electricity, that announced by Volta. As we proceed with this saga of radio we shall have occasion to note various other long-awaited discoveries which reposed on laboratory shelves, or in notebooks, because unrecognized, thus prolonging the waiting period. Previous to the year 1800, investigators had in hand as sources of electricity only the various forms of rotating cylinder, disk, and globe

machines seen in old textbooks, which were useful for only a limited range of experiments.

With the new source of electricity at hand, Volta's chemical battery, the philosophers of the time were enabled to extend their investigations and their explorations into the new, fascinating field of electricity, employing higher voltages and stronger currents than those previously available. Obviously, a single cell of battery could serve as one of a series of cells, the number of cells, or pairs of plates, determining the total voltage available at the end terminals of the entire series. At the Royal Institution, London, in 1809, Humphry Davy (then thirty years of age) set up a battery of two thousand cells. With the high voltage produced by this powerful battery he was enabled to produce electrical effects not previously known to the laboratories. With this battery Davy demonstrated that a continuous electric arc—or "arch," as he named it—could be maintained between conductors attached to the terminals of the battery, when the ends of the conductors were separated a short space. This was the forerunner of the arc lamp.

The advent of the chemical primary battery brought to the colleges and laboratories the world over a dependable source of direct current with which most of the earlier experiments were repeated and verified, and an entirely new line of investigation was made possible. Notwithstanding that the stage was set for giant steps forward in knowledge of electricity and magnetism, some years elapsed before, by accident or on purpose, advantage was taken of the availability of constant sources of direct current to unveil the mystery of the relationship between electricity and magnetism. The magnetic needle, the compass, was already in use, and had been for centuries. The method of magnetizing needles and small rods of iron and steel was to rub them on a lump of the natural magnet, the lodestone. Electricity was one thing and magnetism was an-

other, so far as the knowledge of the experimenters extended.

Electricity and Magnetism

It is remarkable that nearly twenty years should intervene between the advent of the chemical battery and the discovery of the relationship between electricity and magnetism. It is quite possible that an amateur experimenter, or an uncommunicative savant, somewhere tinkering with wires, batteries, and compass needles, had observed and been puzzled by unaccountable movements of magnetized needles, while his experiments with wires and batteries continued.

Diligent search through the prints of the period 1800-1819 fails to bring to light references which would hint that the truth had been discovered. As early as 1813, however, the light was breaking through. In that year, Hans Christian Oersted, a professor of natural philosophy, at Copenhagen, Denmark, published a work on the identity of chemical and electrical forces. In this work Oersted advanced conjectures concerning the relations between electric, galvanic, and magnetic "fluids," which he thought might be found to differ only in their respective degrees of "tension."

And then, six years later, Oersted, while addressing his pupils and holding a charged wire in proximity to a compass needle, was astonished to observe the needle swing quickly from the normal north and south direction and come to rest in a position at right angle to the charged wire. Where could one look for more momentous evidence of the fruits of experimental exploration! For six years Oersted entertained the thought that electricity and magnetism were different *states* of a common phenomenon. Concentrated thinking upon the subject prepared his mind to recognize any manifestation of the true relationship which might appear. Ever on the alert for even the faintest indication, the unseemly behavior of the compass needle mounted underneath a wire carrying electric current must

have seemed to Oersted the equivalent of a thunderous announcement. The Danish scientist was forty-two years of age at the time he made his great discovery. He lived to be seventy-four, long enough to see the early electromagnetic telegraphs and early machine generators of electricity started toward the development and expansion that ushered in the electric age.

Here is a circumstance worthy of notice—it has a bearing upon the long-term progress of science. One might wonder why Oersted, with his firsthand knowledge of the effect which electric current flowing in a wire has upon neighboring magnetic bodies, did not at once proceed to extend and apply his discovery. The discovery was not an end, but a means to an end. The discovery was of such vast significance, however, that reports of it quickly got about. All this was long before inventors discovered the virtues of legal advice and before the structure of patent protection had been erected. And for that matter it may be said for the men who were the founders of science that in general they regarded themselves as adequately compensated when their contemporaries accorded them the *honor* attached to discovery. In Oersted's time it was not humanly possible to visualize what the discovery of electromagnetism was to lead to, to yield.

But the secret bared by Oersted contained such vast possibilities that it was destined to be grappled with shortly thereafter by other inquisitive experimenters. Soon, Ampère was probably smiling as he repeated the Dane's experiment, and then within the following decade the far-reaching advances made by Sturgeon, Ohm, and Faraday were announced. While there are in the history of science numerous records of simultaneous, independent discoveries of important facts, the general advance has been conditioned upon a consecutive order of attack. One investigator contributes additions to existing knowledge of an art, and these new facts, becoming known to other thinkers, are taken up and carried forward to points where in turn fresh minds, taking advantage of all prior con-

tributions, are enabled still further to contribute discoveries and inventions.

The Electromagnet

The results of Oersted's experiments were published in July, 1820, and it was but two months later that André Marie Ampère, in Paris, duplicated the compass needle experiment. Ampère, well aware that only curiosity seekers would be interested in errant compass needles, directed his thinking toward a clarification of the principles involved, and from what he learned he was prepared in September of that year to appear before the members of the French Academy and announce certain fundamental principles of the new science of electrodynamics. How mysterious, how complicated it all must have seemed to the assembled savants! Among them there may have been a dreamer or a poet with the prescience to visualize uses for the new force, but others, with concerns of the day's work occupying their thoughts, forgot about it and went about their businesses.

But not Ampère! As if to make up for the twenty unproductive years between the discoveries of Volta and Oersted, Ampère in one week extended the experiments and showed that magnetic effects could be produced from currents flowing in wires, without bothering with magnetized needles: showed that electric currents in opposite directions repel, and that currents in the same direction attract each other. The French experimenter constructed a long coil of wire named a solenoid, which when connected to a battery exhibited characteristics common to natural magnets. With current flowing through the coil's winding in a given direction the coil had a north pole at one end and a south at the other. Reversing the direction of current flow reversed the sign of the magnetic poles. Thus the true nature of the relationship between electricity and magnetism was on the threshold of discovery. At this time Ampère was forty-five years of age, and was destined to continue in useful work another sixteen years, with mixed

feelings learning from time to time of the work of others in his own country, in England, and in America, wherein knowledge was extended with respect to electricity and magnetism, and when the dawn of the vast uses to ensue from these discoveries was breaking on the horizon of a new age.

Ampère's solenoid held great possibilities. It was a device that inspired speculation—a coil of wire through which electric current was flowing became magnetic! Everywhere experimenters tinkered with solenoids, but it was William Sturgeon, in England, who, in 1823, made the discovery that a bar of iron placed within the coil of wire acquired a magnetic strength many times greater than that of the solenoid itself; and, further, that when the circuit through the coil was interrupted (opened) the magnetism of the iron bar disappeared. Sturgeon, then forty years old, appears to have been so thrilled with his discovery that he was reluctant to rush into print. Evidently it was his desire to have ready for exhibition a presentable apparatus before demonstrating publicly what he had devised. The early experimenters were great fellows for polished-brass mountings and artistically turned elements when assembling scientific apparatus for display. In 1825 Sturgeon was ready to show what he had constructed, and in that year he presented his soft-iron electromagnet at a meeting of the Society of Arts. Thus arrived the electromagnet, a tool destined to be employed in a multitude of uses and now well understood by almost everyone.

Faraday, in England, was to do something new with variations of the electromagnet. The student of electrical history may sense a hiatus in important discovery between the time of Ampère's work and the revolutionizing discoveries made by Faraday ten years later, but during these years many minds were at work on the problems of electricity and magnetism: in England, Humphry Davy and William Hyde Wollaston, and in France, François Arago and others, carried out researches which added to the sum total of definite information available to experimenters.

Coming down to the year 1830, it may be noted that there were available for the work of research the wire conductor, the primary battery, the electromagnet, substances known to be insulators, and by that time were also at hand the galvanometer and the condenser—the latter known as the Leyden jar, invented in 1745. Here were tools to work with, and as a measure of the ground covered it may be stated at this point that within ten years the wire, the battery, and the electromagnet were being harnessed together to make up the wire telegraph system. But it is not likely that in the year 1830 even the most advanced experimenter was thinking about electric action at a distance without conducting wires. The scientific stage was set for further discoveries. But what new knowledge, what new tools were required to suggest to the experimenters of that period (many of them were known as philosophers) that signaling could be established through space without connecting conductors? It is easy now for us to say: "As one condition, higher voltages and high-frequency electric currents." And, although it may seem to us that the experimenters of that time were a bit blind to opportunity, the fact is that discoveries shortly to be made were to place in the hands of investigators the tools—mute in themselves, but pregnant with suggestion—for extended exploration.

Following closely the discoveries that contributed to the conception and development of radio signaling we shall first consider the experiments that led to the construction of induction coils and transformers, rather than those which led to the invention of machine generators of electricity. This because, regarded retrospectively, the need was for very high voltages and high frequencies of alternating current. Obviously the rotating machine generator of electricity would find at hand for many years fields of utility best served by generators of comparatively low voltage and large current output. The need was for a *multiplier*; an amplifier of voltage, even at the expense of a reduction of current volume.

High Voltage by Induction

A philosophical physician once declared that "It is most conducive to health to let one meal digest before taking on another," but in the case of electrical discovery and invention there have been numerous instances wherein discoveries were not fully digested, as to their import, when there emerged other discoveries so appetizing that they did not for long escape appreciative contemplation. Sturgeon's electromagnet was in the nature of a toy, a marvelous toy. Its behavior was intriguing. It was impossible at the time to foresee the thousand-odd uses to which it was destined to be put. There was not time enough to digest all its possible employments before Michael Faraday, in England, started upon a new inquiry.

Genesis of the A-C Transformer

Ampère had shown that by means of an electric current magnetism could be produced, and, following experiments carried out in France by Arago, Faraday in 1825, with rare insight, conjectured that by means of magnetism electricity might be produced. The record of his experimental inquiry carried on between 1825 and 1831 discloses mainly a long series of discouragements. It is probable that on more than one occasion in the course of the experiments the great truth was thundering for acceptance, but in an unknown tongue. The stumbling block was that Faraday had expected magnetism to produce a *sustained* electrical effect in a wire circuit. Reasoning that battery current flowing in a wire had a continuous effect upon a magnetic needle, Faraday's thought was that a magnet could in turn create a continuous flow of current in a conducting wire. The generalization known as the principle of the conserva-

tion of energy was not at that time in circulation as a check upon hypothesis. However, the apparatus Faraday employed to carry on his investigation, while it did not yield results in the form looked for, served him as the instrumentality through which he learned the truth, and other momentous discoveries were made.

The apparatus used in one series of experiments consisted of an iron ring upon which had been wound two separate coils of insulated wire. We might recognize this assembly as a prototype of a 1-to-1 ratio transformer. With a galvanometer connected to the terminal wires of one of the coils, Faraday caused an electric current to excite the companion coil. The instant the circuit of the battery coil was closed, the galvanometer connected in the other coil wound on the iron core indicated, by the movement of its pointer, that electric current was present. Here, then, was the long-awaited discovery. By means of magnetism it was possible to produce electricity!

At first it may have been with mixed feelings that Faraday noted that the galvanometer needle, after moving across the scale a short distance, immediately returned to its normal north-south position: this, notwithstanding that electric current continued to flow through the battery coil. In the experiment magnetism had caused electric current to flow for a brief moment. But of what use was a mere spurt of electric current? Pondering over the discovery that electricity could be produced by magnetism, and for the moment wondering whether use could be found for momentary currents so produced, Faraday proceeded to disconnect the battery, perhaps intending to "call it a day."

But at that instant the veil of obscurity was rent asunder. In a flash the diligent experimentalist noted that the moment the battery was interrupted, shutting off the flow of current, the galvanometer pointer moved first *away from*, and then *back to*, its position of rest. When understood, the significance of this was that when the battery

circuit was opened, the disappearing (changing) magnetism in the iron core induced momentary current in the coil to which the galvanometer was connected. Thus, closing the charging circuit magnetized the iron core and this in turn produced electric current in the companion coil, momentarily actuating the galvanometer, while opening the battery circuit produced the same effect in reverse.

In America, about four years after the work of Sturgeon in England, Joseph Henry conducted experiments with magnetic coils and electromagnets, succeeding in constructing the earliest really useful magnets; those previously in use having but feeble attractive power, due to imperfection in design.

The Induction Coil

Inasmuch as we are endeavoring in this work to adhere closely to the line of electrical development leading slowly forward to the production of electric waves used in radio, it may be recorded that upon the heels of Faraday's discovery the development which above all others served as a forward step was that of the induction coil, as it was called. This instrument, which was made possible by Faraday's great discovery, was destined to become as revolutionary in its potentialities as was the lever of Archimedes to succeeding generations of mechanics: each discovery presented a key to the multiplication of force. As of the period about which we are here writing, the impending development was that of the induction coil, an assembly of elements consisting of an iron core (not an iron ring) having a primary winding of insulated wire upon which was superimposed a secondary winding having a far greater number of convolutions, and an automatic circuit interrupter for the primary circuit.

Throughout the four or five years following Faraday's employment of separate coils of wire on a common iron-ring core to produce secondary electric currents, investigators in Europe and America devoted much time to stud-

ies of the principles involved, and to the construction of all imaginable forms of electromagnets, solenoids, and other coils for producing "electric shocks." All minds were turned toward discovering uses for the intense electric manifestations in the nature of shocks which affected persons who held in their hands the terminal wires connected to magnetic coils when battery circuits were rapidly closed and opened. Investigators tested and discarded scores of ideas. The situation was something akin to the "blind gropings of Homer's Cyclops round the walls of Jericho." Seemingly endless inquiries were made with respect to physiological and therapeutic possibilities. And something of interest did come from these explorations: even until modern times, "Faradic electricity" is indexed in many a medical work as having curative properties.

There was abroad in the little laboratories a vast zeal without knowledge. In the beginning even Faraday and Henry set about contriving means of producing larger shocking power. If the utility at first envisioned was not spectacular, the odd antics of persons severely shocked by electricity, were witness that although imponderable the new force held potentialities which were positive in nature. Faraday and Henry, independently, studied the phenomenon of the more intense spark at the *break* of the circuit, over that observed when the circuit was *made*. Each learned that the greater the number of turns of wire making up the winding of the secondary coil the larger would be the spark upon interrupting the primary (battery), circuit. Also, that when the circuit included the coil winding of an electromagnet the greater still would be the shock received at the instant the circuit was opened. It was almost as if destiny, impatient with the sloth of progress, adopted the procedure of administering wake-up jolts to the tinkers of low and high degree who were puttering around with batteries, wires, and magnets.

In January, 1835, about five years after he began his investigations, Henry communicated a paper to the Amer-

ican Philosophical Society "On the Influence of a Spiral Conductor in increasing the Intensity of Electricity from a single Cell of Battery." In the Edinburgh *Philosophical Magazine* of November, 1834, Faraday had announced the same observation, but Henry had previously in the *Annals of Philosophy*, May, 1832, and in *Silliman's Journal*, July, 1832, reported experiments pointing to the same conclusion. It would appear that the main thought at that time was to discover means of producing the most severe electric shock, or the greatest length of spark by utilizing an *inductive* circuit with small amount of voltage. In 1831, Faraday had used separate coil windings on a common iron-core; in effect, a primary and a secondary winding, but as the length of wire in each coil was the same, or nearly so, the sparking effect observed at the terminals of the secondary winding was not noticeably greater than that produced upon interruption of the primary winding itself. Obviously, once there had been set up an arrangement of wire and coil that would produce a spark of given length, employing a single cell of battery, this could be increased by adding additional battery cells in series.

The induction coil was the name given the early instrument designed to produce high voltage, and although the name was not completely informative as to the make-up of the instrument it was the one which occurred to the pioneer experimenters as suggestive of the action obtained. But the name took hold and is in use to the present time. Actually, there are two coils, even in the simpler designs—a primary and a secondary coil. There are few of the larger coils in use today and mostly these are used for laboratory experiments. Some of them now repose on museum shelves, mute tokens of vanished years.

To trace the somewhat rapid development of the induction coil it is necessary to skip from country to country—England, Ireland, Germany, and America. Following Faraday and Henry's discoveries, there was a race to see who could produce the longest electric sparks. At May-

nooth College, in Ireland, N. J. Callan made up an induction coil with a relatively small number of wire convolutions in the primary circuit; the secondary coil being of a much larger number of turns. With this assemblage Callan was enabled to produce shocks of great severity even though the primary was actuated from but a cell or two of battery. Callan's instrument was exhibited and described in 1837. It was in fact a step-up transformer of the induction-coil type, actuated by a rapidly interrupted direct current in the primary coil.

In that same year, in Germany, Bachhofer built a coil in which a bundle of small iron wires was used as the core in place of a solid iron rod previously used, and in Dublin, Ireland, Professor McGauley devised an automatic interrupter for the primary circuit. In America, Professor Charles G. Page, who had been experimenting with "shock coils," in 1838 communicated to *Silliman's Journal* a description of an induction coil with separate primary and secondary windings, a bundle of iron wires for the core, and a form of interrupter in the primary. The investigators in various countries, thousands of miles apart, were keeping fairly well abreast of each other, in the main working independently.

The utility of this new instrument for producing spectacular electrical effects was quickly recognized in all parts of the civilized world. No scientific laboratory was regarded as completely equipped until a high-power induction coil was procured. Consequently, the professional instrument makers, competitively interested, soon produced coils in improved and finely finished forms. In Germany, in 1851, Heinrich Ruhmkorff materially improved the method of winding the secondary coil; he set it up in sections in order to reduce the likelihood of a breakdown of insulation when the coil was in operation. Two years later Ruhmkorff added a device which fattened the spark and increased its length. This was in the form of an elec-

tric condenser, made by Armand Fizeau, which was connected across the contact points of the interrupter.

Fundamental, epochal discoveries are the mountain peaks of achievement. But it is not often that the original discoverers contribute the trimmings, the refinements. These things usually are the work of many other contributors. And all the steps we are here presenting unerringly led onward to radio. In America, in 1852, E. S. Ritchie constructed advanced types of induction coils which generated voltages sufficiently high to produce sparks 6 inches long, and in 1857 Ritchie made a coil for Columbia University, New York, which produced a spark $10\frac{1}{2}$ inches long.

Thus, subsequent to the year 1850, physicists had as a tool for experiment a practical high-tension induction coil which, in conjunction with Leyden jar condensers, afforded a means of generating and studying the effects of electric discharges on a scale not possible with the laboratory apparatus previously at hand. In the march of events toward the radio age the subject of the nature of electrical discharges was of first importance, for, as it turned out, it was by means of these discharges that electric waves were produced, employed in the course of time in establishing radio telegraph and radio telephone signaling.

Advances in Electrical Knowledge

According to an old legend, once upon a time a farmer's wife believed or imagined that her arduous daily work was lightened because always near her, aiding her, was a friendly gnome. He was never seen because he could not be caught when he was at work. Experimenters who worked with the early induction coils and Leyden jar condensers undoubtedly often were puzzled by observed characteristics of electric discharge through circuits, differing as these do from the steady effects produced in circuits powered by primary batteries. Here was an elusive phenomenon which could be caught only when it was at work. The experimenters were not searching for it because they did not know of its existence. A discovery of great significance was impending. As early as 1826, Félix Savary, a scientist of the time, while magnetizing a steel needle by the electric discharge from a Leyden jar, noted that the discharge did not in all circumstances have the same polarity. That is, it might be positive, and again negative. What could this possibly mean, and was it of any significance? The co-operative gnome was present and at work but wouldn't be caught. Later, others were to recall Savary's observation. But several years passed before the manifestation was identified as a fact, and it remained for Joseph Henry, in America, also engaged in magnetizing needles by means of the discharge from a condenser, to catch the gnome at work.

The Condenser Discharge

Following a series of experiments that began in 1840, Henry, on June 17, 1842, presented a paper to the American Philosophical Society recounting the results of an in-

investigation carried on by him with the object of unraveling the mystery of the condenser discharge. The nature of the discharge had been a puzzle to Savary and others for a score of years. Early enough there had been contrived a galvanometer to indicate the presence of electric current, for this was brought out by Johann Schweigger immediately following the factual announcements of Oersted and Ampère, but the galvanometer was of use only with unidirectional currents, or for single, momentary electric discharges. The galvanometer's indications, when the result of the discharge from a condenser, were quantitative rather than qualitative, so that little could be learned, by this means, of the nature of the discharge. The condenser could be given its charge from any available source of electricity, but the current of discharge, while spectacular in its effects, seemed to have few, if any, practical applications. The discharge would produce sparks and shocks, but many years passed before it became common knowledge what the sparks were in reality accomplishing.

In Henry's communication he stated:

The discharge, whatever may be its nature, is not correctly represented by a single transfer from one side of the jar to the other [from one plate of the condenser to the other]. The phenomena require us to admit the existence of a principal discharge in one direction, and then several reflex actions, backward and forward, each more feeble than the preceding, until equilibrium is obtained.

The secret was out—the discharge of a condenser in a circuit having inductance was not unidirectional but was plainly oscillatory. This discovery was of vastly greater importance than was recognized at the time. Once Henry's paper got around, others attacked the problem anew. The new spur to inquiry was not confined to America. In Germany, Hermann von Helmholtz,¹ particularly, carried on

¹ *Erhaltung der Kraft*, Berlin, 1847; *Tyndall's Scientific Memoirs*, London, Vol. 1, p. 143, 1853.

research, groping into the unknown for disclosures which were provokingly slow to come.

As distinguished from pure science, and from exploratory experimentation, the first step taken to apply engineering principles in the attack upon electrical problems was that of Georg Simon Ohm, in Germany who, as early as 1827, worked out mathematical formulas which permitted the calculation of *voltage*, *current*, and *resistance* values in circuits. But a dozen years passed before investigators anywhere looked upon Ohm's calculations as of practical utility. True, not many investigators had learned of Ohm's work. Around the world the interchange of scientific knowledge was slow. It was in the year 1838 that the first vessel driven entirely by steam arrived in America from England, and in America in that year experiments were being made with anthracite coal to replace wood as fuel for locomotives.

By the year 1842 the mathematical equations of Ohm's electrical laws were familiar to most of the experimenters, and variations and extensions of these laws had been promulgated by others, taking into account the factors of *capacity* and *inductance*. From this time forward electrical research was destined to attract the interest of mathematicians.

From Experiment to Mathematical Certainty

Certainly, in electrical research it was time for the mathematicians to launch an analytical attack. The experimenters, the discoverers, and the tinkers had accomplished wonders. It was as if they had discovered and produced the tubing, the prisms, the mirrors, and the mounts, and now someone else could go ahead and make a telescope.

In England, William Thomson² (Lord Kelvin), in the year 1853, gave out the first mathematical presentation of the nature of the oscillatory discharge. He showed that

² *Philosophical Magazine*, June, 1853.

in a given case the frequency of oscillation and the rate of dissipation can be calculated when the factors of inductance, capacitance, and resistance are known in terms of their values. The formulas resulting from Thomson's mathematical deductions have ever since been tools in the hands of electrical engineers. Thomson was then twenty-nine years of age; Faraday, sixty-two; Clerk Maxwell, twenty-two, and G. R. Kirchhoff, in Germany, twenty-nine. Thomson, Maxwell, and Kirchhoff were well versed in the application of mathematical reasoning to physical problems.

Faraday's scientific achievements were more the result of experimental skill and scientific intuition than of ability to reason mathematically. In 1857, writing to the youthful Maxwell, Faraday inquired: ". . . there is one thing I would like to ask you: when a mathematician engaged in investigating physical actions and results has arrived at his conclusions, may they not be expressed in common language as fully, clearly and definitely as in mathematical formulae? If so would it not be a great boon to such as I to express them so—translating them out of their hieroglyphics, that we also might work upon them by experiment?"

Many a present-day American youth has asked this same question, or has had it in mind. It may be that Michael Faraday had an advantage in living at a time long before the term "inferiority complex" gained currency, otherwise he might have been overwhelmed by the genius and attainments of Sir Humphry Davy, William Thomson, and Clerk Maxwell. Maxwell, with his great mathematical skill, introduced to science new concepts of electrical and magnetic forces with special bearing upon what takes place in the neighborhood surrounding electrically charged conductors. His essay published in 1865, entitled "A Dynamical Theory of the Electro-magnetic Field," propounded that electromagnetic effects travel through space in the form of transverse waves, similar to those of light and hav-

ing the same velocity. Maxwell's theories in a fully developed form appeared in his *Treatise on Electricity and Magnetism*, published in 1873. His contemporaries, and those who followed immediately, were not quick to grasp the complete significance of Maxwell's theories. One reason for the delay may have been that Maxwell did not present a mechanical explanation of electric and magnetic actions as these appeared to him, contenting himself with issuing the statement that such explanation was possible.

In the span of seventy-five years from Volta to Maxwell, as already outlined, the science of electricity and magnetism had been supported by a succession of diligent investigators, each well fitted by natural ability and temperament to add to and to carry forward the gains made in knowledge, to the end that higher planes of achievement were successively reached. The experimenters, as distinguished from the mathematicians, had been busy on the problems. In 1858, Berend Feddersen examined spark discharges by means of a revolving mirror and a year later by photography. In 1868, Jules Jamin and his associate Rogers devised an improved rotating mirror with which they were enabled to observe fairly closely the shape assumed by the oscillatory discharges, but the subject was now in the hands of the mathematicians and the next major advance toward the goal of radio was made in the year 1887, by Heinrich Hertz. After this date a new generation of scientists assumed the task of consolidating the discoveries and inventions of the past, adding by further invention what was required to usher in practical radio signaling.

In the year 1887, of the workers whose achievements have been described here, the following had died: Ampère, Arago, Volta, Henry, Maxwell, Kirchhoff, Ruhmkorff, Page, Faraday, Oersted, and Ohm. William Thomson survived and was becoming a veteran. Fortunately for the art there had been in training in various countries young men, then maturing, who were destined to contribute

largely to the radio idea. Maxwell's equations dealing with the electromagnetic theory of light and with wave propagation traveled the rounds of the colleges and laboratories for a space of ten or more years before the complete significance of his deductions gained general circulation. In 1885, twelve years after the publication of Maxwell's complete works, one of the small company who had grasped the full meaning of Maxwell's theories was Oliver Heaviside, in England, then thirty-five years of age. Heaviside was Maxwell's first disciple; the first to envision future useful application of the new ideas. In his extension of Maxwell's reasoning Heaviside treated of motions of electric charges at different velocities in relation to the speed of light waves or rays. Hertz's demonstrations in 1888, of the propagation of electromagnetic waves through space and their detection, were hailed by Heaviside as the first experimental proof of Maxwell's electromagnetic wave theories.

Wire Telephony

At this stage of our narrative it seems fitting to record that telephony by wire was invented at about the time Maxwell's electromagnetic wave theories were announced. Alexander Graham Bell's telephone, in America, was introduced in its early form in the year 1876. Other experimenters had during the previous fifteen years given thought to the possibility of transmitting speech over wire lines, and since the year 1844, telegraph lines had been extended to most of the cities of the world. With the telegraph an accomplished fact it was natural that the science teachers in colleges and the "electricians" of the period 1860-1875 should set out to run to earth every suggestion pointing in the direction of telephony.

Johann Philipp Reis, in Germany, in 1861, discovered that a vibrating diaphragm could be actuated by the human voice so as to cause the pitch and rhythm of vocal sounds to be transmitted over a wire and reproduced at a

distant point by means of electromagnetism. In a statement made by Reis in the year 1863, he said:

Two years ago I succeeded in effecting the possibility of the production of tones by battery current and in setting up a convenient apparatus therefor. If sufficiently strong tones are produced before the aperture, the membrane and the angle-shaped little hammer upon it are set in motion by the vibrations, the circuit will be at once opened and closed for each full vibration, and thereby will be produced in the iron wire of the spiral the same number of vibrations which are there perceived as a tone or combination of tones.

Bell's invention for the transmission and reproduction of speech consisted of a device for superposing magneto-electric currents upon a battery circuit, and a receiver consisting of an iron diaphragm mounted in contact with, or in close proximity to, a soft iron magnet. In 1874, Elisha Gray, in America, was at work on telephony by wire, inventing a method of transmission by means of which the intensity of the tones, as well as their pitch and rhythm, could be reproduced at a distance and subsequently Gray conceived the idea of controlling the formation of electric waves by means of the vibratory motion of a diaphragm capable of responding to all the tones of the human voice.

In 1876, Amos E. Dolbear, in America, substituted permanent magnets in place of the electromagnets and battery employed by other experimenters, and used the same type of instrument for both transmitting and receiving. In 1877, Thomas A. Edison, then thirty years of age, applied to the telephone a principle, that of the variation of resistance which carbon and various other substances undergo when subjected to change of mechanical pressure. This characteristic of carbon was not Edison's discovery; it had been known for some years. In Germany, Emile Berliner had made use of the principle in varying the current flowing in electrical circuits.

From that time forward the development of wire telephony was fairly rapid, although for the handling of mes-

sages between places more than a few hundred miles apart it was not a serious competitor of the Morse telegraph until about the year 1900.

We shall not here pursue the story of wire telephone invention and expansion. That is a separate subject. Telephone electricians everywhere had their hands full to get done all the new things they had to do to make a success of the transmission of speech by wire. It is of interest here to note that it was not until about the year 1912 that the telephone engineers began to take a direct interest in what the radio investigators had been about since the time of Maxwell. In passing, however, it is of interest at this point to note that experimenters had found that when contacts are made by blocks of carbon which touch each other, or between a carbon block or carbon granules and other conducting substances, pressure varies the electrical resistance of the circuit of which the contacts form a part. For soon it was to be discovered that the electrical resistance of a circuit which at some point included a "loose" contact, such as between two small sections of carbon, could be varied at will from a distance by means of electric waves transmitted through space.

Electromagnetic Waves

Somewhat akin to Penelope's web, the task of the experimentalists is never finished. A difference is that what is accomplished by day is not undone at night. Rather it would appear that there has been little or no pause night or day in the prosecution of research and invention in the development of wireless signaling. The key discoveries and important inventions did not arrive in accordance with a scheduled timetable, but appeared with a regard for regularity as capricious as that of most of the eventualities of human experience.

It may readily be understood that following the development of the high-power induction coil, about 1855, electromagnetic waves were in fact being produced daily in the laboratories—speeding uselessly and unrecognized through space in all directions from wherever stout electric sparks crackled on laboratory benches. On numerous occasions keen-eyed experimenters probably observed minute electric sparks in isolated wire or other metallic structures where there was no known reason for sparks to appear. And no doubt, many experimental circuits containing a number of elements not securely connected together electrically, gave indications of instability puzzling those engaged in the work.

Maxwell's announcement of 1873, of the existence of electromagnetic waves, was based on reasonable assumptions. Thenceforward the task was to devise means of detecting the presence of transmitted waves in space in such manner that their interception might sensibly be recognized. With the knowledge that electric waves, artificially produced, were at large, scattering through the atmosphere (or some other medium occupying the same space as the

earth's atmosphere), the experimenters were on the lookout for manifestations of the elusive impulses. In England, in 1879, David E. Hughes¹ noted that when an interrupted electric current was exciting a magnetic coil, a microphonic contact placed elsewhere in the room was affected at every interruption of the primary circuit. In Germany, Ludtge² made a similar observation at about the same time.

Hughes, extending his inquiry, found that various forms of microphonic joints were sensitive to electric action from a distance. He learned that a block of carbon resting on a bright steel surface was sensitive and self-restoring, while a loose contact, equally sensitive to radiation, would *cohere*, remaining in electrical contact (minimum resistance) after the passage of an electric wave, or whatever it was that caused the action. The thing was so new that there were differences of opinion. In 1880, Hughes's results were shown to Sir George Stokes and other prominent physicists of the time, but the idea that the phenomena observed were the result of passing electric waves was rejected by Stokes, his opinion being that the observed effects were simply those of ordinary *induction* as then understood.

Nevertheless, Maxwell's ideas on the subject of electric waves were surely, if slowly, gaining acceptance in the minds of the physicists. In 1883, George Francis Fitzgerald, in Dublin, Ireland, from theoretical considerations indicated that he believed it possible to excite electric waves in the *ether* by means of discharges from Leyden jar condensers. The truth was that condensers had been doing that very thing for a hundred and thirty-eight years—since E. G. von Kleist's time, and particularly since the early use of practical induction coils, about 1840, electromagnetic waves were being propagated in space at one time or another in every electrical laboratory equipped with

¹ Hughes revived the use of the word "microphone," employed fifty years previously by Wheatstone as the name of an acoustic apparatus for magnifying sounds.

² *Dinglers Polytechnisches Journal*, Vol. CXLVIII, p. 220, 1878.

condensers and coils. All this without the existence of the phenomena being suspected.

Hertz's Waves

Various of the early electrical discoveries were so distinctive that the physicists and experimenters identified as being the discoverers were accorded the honor of having their names attached thereto. There were: Ohm's law, Ruhmkorff's coil, Maxwell's theory, Henry's electromagnets, and Morse's telegraph. When the proof of Maxwell and Heaviside's electromagnetic wave theories emerged in

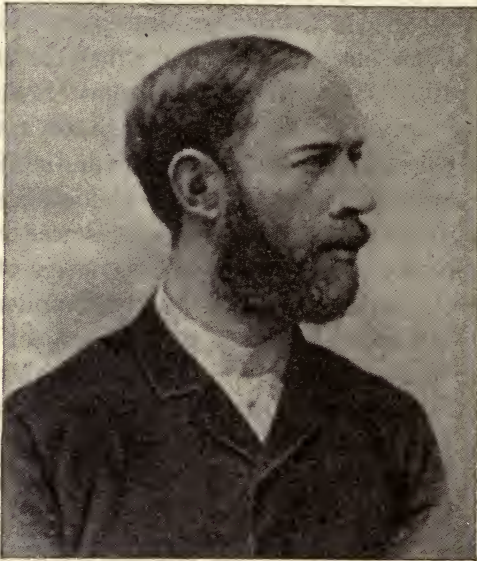

HEINRICH HERTZ

(From Lodge, *The Work of Hertz and Some of His Successors.*)

the experiments of Hertz, transmission through space was at once designated as being in the form of Hertz's waves. Hertz was a teacher in a high school in Germany, and in the year 1887, while delivering a class lecture and demonstrating with a Leyden jar condenser and two separate

coils of wire, he observed that the discharge from the jar through the coil attached to it caused the electrification of the other coil, provided—and here was the great discovery awaited since 1873—provided that there was a spark gap in the inducing circuit. Hertz was then thirty years of age, and following his discovery he was able soon to show that electricity can be transmitted in the form of electromagnetic waves, at a speed approximate to that of light. Hertz proved that electric waves show the phenomena of refraction, reflection, diffraction, and polarization, as do light waves. In his famous experiments Hertz employed as an exploring loop in the neighborhood of the electric discharge a rectangle of wire, cut at one point to provide a minute gap across which sparks might appear should proper electrical balances be established. When the tell-tale sparks were first observed in the gap in the exploring loop, there may possibly have obtained the fortuitous condition that the transmitting and receiving loops were in balance electrically, in syntony. Not that Hertz was unaware of this requirement, for in a paper which he published in 1887 one paragraph reads:

But it seemed to me that the existence of such oscillations might be proved by showing, if possible, symphonic relations between the mutually reacting circuits. According to the principle of resonance, a regularly alternating-current must act with much stronger inductive effect upon a circuit having the same period of oscillation than upon one of only slightly different period. If, therefore, we allow two circuits, which may be assumed to have approximately the same period of vibration, to react on one another, and if we vary continuously the capacity or coefficient of self-induction of one of them, the resonance should show that for certain values of these quantities the induction is perceptibly stronger than for neighboring values on either side.

After Hertz had continued his investigations for some time he learned that his countryman, W. von Bezold,³ had, in 1870, performed experiments with dischargers connected

³ *Poggendorff's Annalen*, Vol. CXL, 1870.

by wire to resonator rings, by means of which he observed the phenomena produced in a conductor by advancing and reflected oscillations. It is to be remembered, of course, that Hertz's great step forward was in the use of isolated resonator loops, that is, receiver rings not connected by wire with the oscillator system.

Hertz's experimental demonstrations were the long-sought verification of Maxwell's electromagnetic wave theories. Immediately in other countries university and college laboratories witnessed the beginning of an entirely new series of investigations. In England, Sir Oliver J. Lodge had, almost simultaneously with Hertz, detected electric waves transmitted along conducting wires. In a class lecture in 1889, Lodge *tuned* the circuit of a condenser to a neighboring condenser circuit which included a spark gap, demonstrating that when the second circuit was in syntony (resonance) with the first, its condenser would overflow (discharge).

The First Transmitters and Detectors

It was perhaps natural that it should take the experimentalists some time to get used to the idea of electromagnetic waves in space. They were more familiar with the action of magnetic lines of force in the neighborhood of conducting wires. With a strong current in the wire the *inductive* action might be detected at a considerable distance away from the charged wire by employing a sensitive magnetic-needle type of instrument. The *magnetic* field was one thing, but Maxwell, visualizing *electromagnetic* effects, pointed to the transmission through space of electric waves to distances far greater than those considered possible by magnetic action alone.

The splendid series of researches which followed Hertz's discovery disclosed that elements of an oscillating system may be a capacity (condenser) and an inductance, and means for charging the capacity; allowing it to discharge through the inductance. The resulting combination of

electrostatic and -magnetic fields moving outward into space constitute a train of electromagnetic waves, traveling at the speed of light. It was an astounding discovery that electric waves in space encountering obstacles consisting of nonconducting materials passed through them as light passes through glass. Hertz's early demonstrations indicated that when electromagnetic waves propagated into space arrive at a wire system, or conductor, components of the wave set up electric oscillations in the conductor, the effects of which depend upon the form of translation employed. The form of detector employed by Hertz in his classic experiments is illustrated in Figure 2.

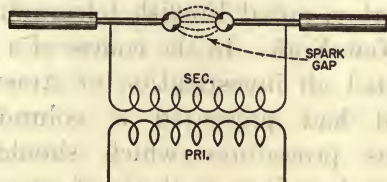

FIG. 1



FIG. 2

FIG. 1.—An early type of Hertz oscillator.

FIG. 2.—A metallic loop nearly closed, employed by Hertz to detect the presence of electric waves in space.

This, the first wireless receiver, was particularly adapted to the requirements of initial investigation. The ring could be given exact dimensions as to diameter, thickness of wire, and size of air gap, and while it was far from being an efficient absorber of energy, it was a persistent oscillator, well designed to respond to waves of predetermined length.

It might have been expected that, since the discovery that the condenser discharge is oscillatory had been made in America by Joseph Henry in 1842, a widespread attack would shortly have followed in America upon problems of research which this discovery might have suggested. But we have seen that the main extensions of discovery were made in England and on the Continent. And in those times the fruits of the college laboratories seldom came

to the tables of persons engaged in everyday work. There were no popular technical societies for the dissemination of scientific knowledge and information. Undertakings of large scope were to the fore in America, but these concerned mainly railroad construction, canal building, highway construction, iron foundries and steel mills—and the Civil War. Twenty-five years after Henry's epochal announcement—in 1867—the consolidated telegraph enterprise, recognizing the need for scientific and efficient operation of its vast ganglia of wire lines, perforce had to appeal to the English to send over an *engineer* qualified to make a survey of American lines, to recommend standards of voltage, current, and resistance for circuits and instruments. Cromwell F. Varley, noted English telegraph and cable engineer came to New York. In the course of a year Mr. Varley had completed an investigation of American telegraph practices and had presented a voluminous report outlining various procedures which should be adopted in order to bring American methods of operation up to standards common in England and on the European continent. Following the year 1867, therefore, it became clearly evident in the United States and Canada that the profitable operation of telegraph systems required something in addition to service promotion and financial manipulation. It may have been a shock to the promoters, but, in time, the outcome was that recognition was ultimately accorded to inventors, and to a new generation of *electricians* become *engineers*. This was well, for a few years later the advent of Bell's telephone was to call for the ministrations of trained electricians and mechanics, with added skill of engineers.

But, to resume the "biography" of wireless signaling, it is to be remembered that Hertz did not discover or invent wireless telegraphy. What he established by demonstration was that electric waves produced by electromagnetic means are propagated through space, and that the presence of these waves at points remote from the source

may be shown as electric energy in properly designed intercepting wire systems. This is what the mathematician Maxwell had earlier told the experimenters they should find to be so if they searched diligently and carefully.

Hertz lived but seven years after making his great discovery—dying less than a year before the first experiments were made in the employment of electromagnetic waves for signaling without connecting wires. By this is meant, the use of these ether waves for the transmission of signals to a distant point without wires and their intelligible reception at the receiving point.

The Ether

Employment of the word "space" as the name of the medium through which electric waves are propagated is in the interest of simplicity, and while in scientific circles there may be doubt about the exact nature of the medium, we have arrived at a step in the experimental rise in radio where it is necessary to record the progress of thought and speculation relative to the existence of the *ether*. The term "space" is convenient for the element through which the earth and astral bodies move, or in which they are immersed. It is convenient as a name for the medium, other than the earth's atmosphere, which serves as a vehicle for the transfer of electrical energy.

Christian Huyghens, a Dutch philosopher, in the year 1670 was perhaps the originator of the undulatory theory, which assumes that light is propagated by means of vibratory motion of an imponderable medium called ether. Sixteen years later, Isaac Newton published a work on natural philosophy setting forth his theories of force and of action and reaction; his conception of *mass*, and his explanation of *gravity*. Newton's standing as an authority was such that in his time it was like questioning the Bible for others to advance hypotheses at variance with those of the noted philosopher. Newton's idea that light consists of material particles projected from luminous bodies, referred to as the

corpuscular theory of light, continued as the generally accepted theory for one hundred years, until, in 1773, Dr. Thomas Young re-established the scientific status of the undulatory theory of Huyghens.

The last hope for the corpuscular theory seemed to have faded when, in 1851, Leon Foucault, in France, demonstrated the differences in the velocity of light rays through the air, through water, and in a vacuum. Foucault's calculations convinced his contemporaries of the correctness of the undulatory, or wave, theory of light. As a space-filling medium ether was then recognized as having the property of transmitting light waves at a velocity of 186,284 miles per second. Permeating the earth's atmosphere, and extending in all directions beyond the atmosphere, the medium was given the name of *luminiferous ether* to distinguish it in terminology from the various ethers of chemistry. For a time the word "ether" was seized upon to answer as a medium for a variety of observed phenomena. There was electric ether for electrical phenomena, magnetic ether for magnetic phenomena, and various other ethers to account for other effects.

It remained for Faraday to head off further indiscriminate invention of ethers. He suggested that the so-called luminiferous ether might be the one involved in all the phenomena observed. And Maxwell's disclosures, which followed the announcement of Faraday's conceptions of magnetic phenomena, propounded that the waves which transmit light and the electric waves set up by oscillatory radiating circuits are identical in their natures, travel at the same velocity, and *travel in the same medium*.

With Hertz's research results published and in circulation, many scientists and experimenters launched mathematical studies and experimental inquiries, hoping to extend the knowledge already accrued and to square the Maxwellian theories with already established practices (line-wire telegraphy and telephony then being carried on) and to find uses for electromagnetic waves which could be

propagated at will and detected at points remote from the source of the waves. In the years immediately following Hertz's announcement, additional light was thrown upon the general subject by several inquiring investigators. The names of some of the physicists so engaged indicate the international interest in the phenomena of electric waves; Horace Lamb, J. J. Thomson, L. Zehnder, Vernon Boys, Paalzow and Arons, D. E. Jones, Professor Fitzgerald, Minchin, Hicks, Boltzman, Rubens, Ritter, and Kolacek. In the United States at that time, and in their prime, were Michael I. Pupin, Nikola Tesla, Thomas A. Edison, A. E. Kennelly, E. J. Houston, A. G. Bell, J. J. Carty, and John Stone Stone. But not all of these Americans took an immediate interest in Hertz's announcement. In the present work it is not the intention to present biographies of the makers of radio; rather, the desire is to set down a "biography" of radio itself. Other, excellent publications present the life stories of the discoverers, the inventors, and the engineers.

"Wireless" Ventures from the Laboratory

The first designed detector of electric waves in space was the Hertz micrometer spark gap, or resonator, consisting of an insulated handle on which was mounted an open metal loop, the abutting ends carrying small metal spheres whose distance apart could be adjusted by means of a micrometer screw. For laboratory purposes this detector answered the needs of initial experiment and qualitative measurement. Throughout the years from 1888 until 1891, nothing of note appears to have been contributed in the way of improved means of detecting Hertzian radiation. To some college physicists, and more so to the electricians engaged in telegraph, telephone, and electric light work, "free electric waves in space" took on the semblance of the stuff of dreams. In 1888, Dr. A. E. Kennelly came from England to the United States in the service of a submarine cable company, soon to take up work in the Edison electric lighting laboratories. In that year Edward Weston was elected president of the American Institute of Electrical Engineers; Charles Cuttriss was making important improvements in ocean cable instruments; E. H. Lyons of the Bell Telephone Company was at work attempting to devise a telephone amplifying repeater (a task completed by others thirty years later); and Nikola Tesla was at work on alternating-current problems. A year later, Edison brought out his first kinoscope, and Elihu Thomson delivered a paper having the title "Alternating Currents and Electric Waves." It is not in the nature of an alibi to state that perhaps every qualified worker in electricity was at the time pretty well occupied. They were well occupied:

witness the electric light, electric railways, generators, motors, and numerous other electrical products.

Branly's Coherer

The four-year hiatus which occurred in the evolution or invention of an improved means of detecting electric waves in space came to an abrupt end when, in 1891, Edouard Branly, in France, discovered that a polished coat of porphyzied copper spread over an insulating surface, such as glass, was very considerably reduced in electrical resistance when subjected to electromagnetic waves. Branly found also that a small glass tube filled with metallic filings (coherer) exhibited this same characteristic, and that in the case of both of these detectors restoration to the high-resistance state could be accomplished by jarring them mechanically (see Figure 3).

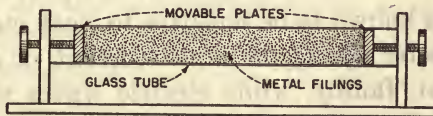

FIG. 3.—Glass tube containing metal filings used by Branly to detect the presence of electric waves.

It may be recognized that the Branly detector operated on the microphonic principle, and if the reader wishes he may wonder why something was not done earlier with what was suggested by Edison's microphone for telephony and Hughes's observation of 1879 in regard to microphonic contacts. But these lapses have occurred often in scientific development, and doubtless will continue to happen, all of which perpetuates the virtues of opportunity.

Throughout the years when the *coherer* type of detector was employed in radio telegraphy, various hypotheses were advanced to explain the functioning of the device. Branly suggested that the dielectric, or insulating, films separat-

ing the metallic elements of the detector might be modified in character by the action of arriving electric waves. Oliver J. Lodge, in England, suggested that the electrostatic attraction between the very close surfaces "squeezes out" the dielectric, thereby establishing metallic contact (welding) by pressure; possibly aided by a heat effect.

Janus, the Latin deity who, in the days of mythology, was reputed to preside over the beginnings of all things, may have returned to earthly responsibility for a spell when the art of wireless telegraphy had its beginning. About four years elapsed between the time of Hertz's discovery, and the advent of the Branly coherer. Dr. Lodge, in England, who as early as 1888 demonstrated the transmission of electric waves along wires, in his later experiments with waves in space was interested in the use of galvanometers for indicating the reception of transmitted impulses. Doubtless this was because the galvanometer was already at hand, and was known to be sensitive to weak currents. But the galvanometer was of the direct current, or slowly alternating current, family, while electric waves were of relatively high frequencies and the requirement was that when intercepted they had to be translated, converted. Branly's coherer accomplished this by virtue of the fact that the variations in the resistance of the filings in response to incoming signals could be employed to operate an audible indicator, locally.

The idea of employing electric waves in space in conjunction with wave detectors for the purposes of space telegraphy occurred to Captain Jackson, of the British navy, upon hearing Dr. Lodge's lecture of June 1, 1894, on the subject of Hertz's work. On the same occasion, Dr. Alexander Muirhead foresaw and estimated the importance of electromagnetic wave signaling. Captain Jackson immediately undertook experiments which enabled him, two years later, to transmit signals from ship to ship, over a limited range. Dr. Muirhead devised a receiving assemblage consisting of a coherer and a siphon recorder by

means of which incoming signals could be registered on a moving strip of paper tape.

Through some odd quirk of circumstances detailed information with respect to Branly's coherer was slow in reaching the attention of the scientists in Germany. Even later than 1894 they were still piddling with the original Hertz loop detector—excellent for qualitative indications, but little suggestive of distance or of signaling possibilities.

Marconi's Improvements

It was Guglielmo Marconi, in Italy, who took the first bold and practical step in the direction of utilizing Hertz's discovery for the purposes of adapting space telegraphy to increasing distances. Marconi had left school at the age of eighteen and later had been present at lectures on scientific subjects. But the young Italian gained his initial knowledge of Hertz's demonstrations in much the same manner as amateur experimenters the world over gained that same knowledge in later years. He related that in 1894 or 1895 he read an illustrated article in *Wiedemann's Annalen* dealing in an elementary way with Hertz's announcements. He read also parts of the book by T. C. Martin, entitled *Inventions and Researches of Nikola Tesla*, published in New York in 1894.

Although Marconi attacked the subject in an amateurish way, he had the inventor's knack, or gift, of being able to make important improvements; improvements which enabled him to increase considerably the distance over which wireless signaling could be carried on. Within six months after he began his Hertzian experiments, Marconi believed that electric waves sent out from an induction-coil and Leyden jar transmitter were actually reaching distances not suspected by the laboratory investigators. He improved the Branly coherer by moving the terminal electrodes closer together, leaving only a small pocket between them in which a small amount of metallic filings was deposited

(see Figure 4). This increased the sensitiveness of the detector and simplified the decohering process.

An important early discovery made by Marconi was that the distance of transmission was considerably increased when elevated conductors were set up at the sending and receiving ends. In 1896 he employed an antenna forty feet in height, and a year later, by guess or by scientific instinct, conceived the idea of grounding one terminal of the transmitter, while the other side of the oscillator was attached to the elevated antenna. At once further extension of distance was accomplished. At the receiving

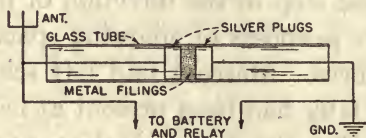

FIG. 4.—Illustration of assembly of Marconi's coherer. See Figure 19 for circuit details.

end the circuit extended from an elevated antenna, through the coherer to earth; while connected in parallel with the coherer were a sensitive direct-current relay and a local battery. Incoming waves caused the electrical resistance of the coherer to be considerably reduced, sufficiently so to permit current from the battery to energize the relay, attracting its armature. A *tapper* (decoherer) connected in the local circuit of the relay automatically jarred the filings, causing them to decohere, in readiness for the succeeding impulse or signal.

Marconi then had the elements of a practical wireless telegraph system, with which he was to have little bother until more than one space telegraph system was in operation in the same area. For several months he continued to experiment, making detail improvements in the apparatus and gradually extending the range of signaling.

By the early part of the year 1896 Marconi had a demon-

stration outfit which he believed worth exhibiting in quarters where the practical possibilities of the system might have appeal. It was time for "wireless" to venture forth from the laboratories in search of useful employment. Marconi's ability as a practical scientist and his commercial acumen, co-operating purposefully, started him off to market with his wares. The samples he took with him would not be impressive today, but in 1896 they were the wonder of Europe. As to a promising market for what he had to sell, the best one happened to be not far away. British interests controlled the lion's share of the submarine telegraph cables throughout the world. British land telegraphs were operated by the Post Office Department. And, the British Navy was made up of very, very many ships. Also, Marconi, being partly of Irish parentage, anticipated that his reception in London should not be unfriendly.

It was a stroke of good fortune for young Marconi that when he arrived in England the engineering head of the British Post Office Telegraph System was open-minded, kindly William H. Preece. Preece, familiar with what Dr. Oliver Lodge had been saying about signaling through space and with what Captain Jackson was attempting to do in the way of ship-shore signaling, at once took the young Italian under his wing, so to speak, and arranged for the setting up of the apparatus, and for demonstrations. What followed was historic, and in a way Marconi's arrival in London constituted an odd situation. Here was an Italian youth—then but twenty-one years of age—who had been experimenting with electro-magnetic waves for a matter of a year or so, journeying to the capital of Great Britain, headquarters of the world's submarine cable enterprise, to exhibit a system of wireless communication by means of which he had telegraphed a distance of a few miles.

Attendants on the scene at the time, while they were still alive (and had an audience), used to talk of the spectacle of the youthful Italian and sixty-two-year-old Wil-

liam Preece trudging, heads down, across the uneven terrain of Salisbury Plain, each carrying bundles of strange gear. Great emprise in its elements! Marconi's further capture of opportunity in England in 1896 may be appreciated by recalling that in that year William Thomson (Lord Kelvin) was seventy-two years of age; Oliver Lodge, forty-five; J. A. Fleming, forty-seven; Williams Crookes, sixty-four; Lord Rayleigh, fifty-four. Each of these men was a profound scientist and had, no doubt, kept pace with progress both before and after Hertz. Marconi was twenty-one!

It is true that following Marconi's demonstrations several of the scientists mentioned brought to the new art the direct and immediate benefits of scientific knowledge and experimental skill, which in large measure accounted for the astonishing increases in distance range accomplished within a few years. In scientific and in communication circles endless comment and speculation were precipitated by the simplicity, or boldness, of Marconi's short cut from the laboratory to the field of practicability.

The distances over which Marconi was able to communicate within a year or two of his first demonstrations prompted the thought expressed by some persons that perhaps Marconi had discovered a new system of electric waves, differing from those of Hertz; the latter having been employed in laboratories for demonstrations over a range up to only a couple of hundred feet. One of the earliest publications on wireless telegraphy which appeared in England, was a small book by Richard Kerr, in 1898. On page 85 of this work the author states:

So far as the Hertzian wave researches are concerned the two great authorities are Mr. Marconi and Dr. Oliver Lodge. But, if results later on should prove that Mr. Marconi is utilizing a new set of waves, say a set more penetrating than those of Hertz, we should have a case on all-fours with that of the X-ray discovery where Lenard hit upon the cathode rays, and Röntgen on those called after his name. And this seems not at all unlikely.

Without any extraordinary battery power Marconi seems to be working with waves that will penetrate anything.

It would seem that after all the contributions of Faraday, Maxwell, Thomson, Hertz, Heaviside, and Lodge, the orthodoxy of electromagnetic waves should have been more firmly established. That in 1897-1898, there still was open-mindedness on the subject must remain as a tribute to the enterprise engendered by Marconi's brilliant demonstrations.

Marconi's Contemporaries

It has already been stated that one of the books read by Marconi in 1894 or 1895, when he was twenty years of age and when he was seeking knowledge of high-frequency electric phenomena, was the book by Martin dealing with Tesla's researches in America. A search through this work to locate text that might have been of value or suggestive to Marconi does not bring to light anything which could have been particularly helpful to the young Italian if he was thinking of wireless signaling. The section of the book that approaches the subject of Hertzian waves is Chapter 26, which reproduces a lecture delivered in New York on May 20, 1891, entitled "Experiments with Alternate Currents of Very High Frequency."

Reviewing the text on page 174 of Martin's book, it would appear that Tesla entertained the idea that the bulk of the energy produced by the condenser discharge (energized by a high-tension induction coil) was taken up and converted into heat in the discharge area and in the conducting and insulating materials of the condenser. There appears no thought of detached waves being propagated into space. In view of the notion expressed in Kerr's book, published in England seven years after the publication of Tesla's New York lecture, that possibly Marconi was employing a form of radiation differing from Hertzian waves, it is not surprising that in America, in 1891, the truth had

not yet been fully recognized. Hertz's announcement of 1888 and Lodge's investigations conducted at about the same time were not immediately given wide circulation in published form. And even in quarters where the information was early received there was a natural disposition to gain knowledge of the subject by duplicating the original experiments. This was time-consuming, and accounts for part of the delay that ensued in arriving at a correct understanding.

Analyzing the state of the art as of that period in the only way possible—through its literature—there is no avoiding the conclusion that Marconi possessed the type of mind which seeks to apply principles to utilitarian purposes: the type of mind possessed by Morse, Bell, Edison, Westinghouse, and others of their generation.

At about the time that Marconi was carrying on his experiments in Italy, Professor A. S. Popoff, in Russia, was engaged in experiments with Hertzian wave phenomena. His first communication on the subject was forwarded to the Russian Physical Society in April, 1895, and was published in the January, 1896, journal of that organization. Popoff reasoned that inasmuch as a Branly wave detector responded to Hertzian radiation it should also respond to waves of the same nature produced by flashes of lightning. With this conclusion Popoff was most certainly on solid ground, as many years of the plague of "static" bears witness. The Russian physicist designed a circuit and apparatus arrangement almost identical with that at first used by Marconi—detector, tapper, and relay—and set this up at the Meteorological Observatory at St. Petersburg in July, 1895.

Popoff's receiver was attached to an already installed lightning rod of conventional construction. Thus lightning discharges, remote or nearby, produced electromagnetic waves which, impinging upon the lightning rod, caused the Branly tube to cohere and operate the relay and alarm, the latter operated by a local battery. Obviously, this

early radio storm warning registered electrical discharges taking place in receding as well as in approaching disturbances. Then when Popoff got around to it, he set up a radiating system whose outgoing impulses were under his control, but reasoning, perhaps, that electrically charged clouds had no radiating antenna, he at first equipped the terminals of the induction coil's secondary winding with metal spheres thirty to ninety centimeters in diameter. Although Popoff reported covering a range of five kilometers with this arrangement, neither elevated conductor nor ground connection were employed. The publication of Popoff's paper here referred to, together with the wide publicity given Marconi's demonstrations in England in March, 1896, at once made the intriguing project of wireless telegraphy a speculative subject in colleges, electrical workshops, and attic laboratories the world over.

In the late years of the nineteenth century the physicists were keenly alert to discover new manifestations of electric waves and to discover waves or rays of new and hitherto unsuspected categories. The envisioned project seemed as full of promise as canaries' eggs. An inanimate something, somewhere, might, with careful incubation, yield new utilities or mayhap tap the music of the spheres. Roentgen, in Germany, in 1895, discovered X rays, having characteristics similar to those of Hertzian waves, in that they penetrate certain substances which are opaque to light rays. X rays could be produced by apparatus similar to the induction-coil equipment used in wireless telegraphy, in connection with highly exhausted vacuum tubes of special design. The wave length of X rays, however, was short, compared to those originally employed by Hertz.

Returning to the story of wireless signaling, it may be illuminating to take note of what was to the fore in Germany, in which country, strangely, the workers appear to have been dilatory in getting started. One of the earliest German scientists to take up wireless study was

Dr. A. H. K. Slaby. It would appear that Dr. Slaby was aware of what Marconi had accomplished in the way of improving devices and circuits for space telegraphy, for, in Kerr's book of 1898, previously mentioned, Professor Silvanus Thompson is quoted as saying (page 82): "Dr. Slaby abandoned every one of the novelties introduced by Marconi and fell back upon methods previously known." The "previously known" methods were not identified.

It is a matter of record that Slaby was present on March 13, 1897, at tests carried out in the English Channel by Marconi, and that upon his return to Germany he undertook to extend the range of signaling with the instruments he had devised. In a statement Slaby conceded that the youthful Italian had "devised for the process an ingenious apparatus which by the simplest means attains certain results." In the course of time wireless progress was accelerated following technical contributions made by Ferdinand Braun, Slaby, Count Arco, E. Marx, George Seibt, and especially by J. Zenneck, whose mathematical skill enabled him to forge to the front.

In the year 1899, when he was twenty-nine years of age, Zenneck was assigned to conduct a series of tests of wireless signaling in the North Sea, and thenceforward his contributions to the theoretical and practical sides of the subject were of outstanding value in Germany and in other countries.

In France, in the early days of wireless, experimentation was carried on, beginning with Branly's invention of the coherer. The eminent physicists J. H. Poincaré, André E. Blondel, and Albert Turpain carried out theoretical investigations, and lectured on the subject of wireless. French army and navy interest in wireless signaling across bodies of water, and between ships, was studiously served by Gustave Ferrié and Commandant Tissot, and in the course of time the workers in France were to make telling contributions to the advance of the new art.

First Steps in America

Throughout the last decade and a half of the nineteenth century the captains of industry in America were busily engaged in large emprise, principally in the laying down of transcontinental railroads and branch lines and in setting up seemingly endless rows of poles for telegraph and telephone services. The schools and colleges were crowding the hours turning out medical doctors, doctors of divinity, and doctors of the law, the while the halls of learning were changing classroom illumination from gas-light to electric light. All hands were busy through long days. Days seemed not long enough to get all the work done. Possibly, like the philosophers of Laputa, they may have feared that the sun would burn itself out before the tasks had been completed.

And this was the period of the first provisional exploitation of the discoveries of Maxwell and Hertz.

Following Joseph Henry's announcement of 1842, of the oscillatory nature of the condenser discharge in an inductive circuit, and continuing to Hertz's time (1888), there were in America several physicists who in some fashion prosecuted research into the phenomena of science as uncovered from time to time in America and abroad, but out of none of these inquiries came anything startling in the nature of a contribution toward a solution of the mysteries laid bare by Maxwell, Heaviside, Thomson, and Hertz.

Early Lack of Recognition

It is true that from the time of the introduction of Morse's telegraph in 1844 until the beginning of the work of Elisha Gray, Alexander Bell, Emile Berliner, and others,

which ushered in wire telephony, many of those who had knowledge of electricity devoted their efforts to improving wire telegraphy. The introduction of the telephone in America in 1876 brought in its train a maze of problems, mechanical and electrical. In the beginning of that art the mechanical problems were perhaps the more pressing, for by solving these the telephone as introduced could be put to work to produce revenue.

It was natural that, because of the large size of the country and the great distances involved, the United States should offer a profitable field for systems of telegraphic and telephonic communication. The introduction of these electrical services found the country poorly staffed with men who possessed theoretical knowledge of electricity and electric circuits. That this was so is apparent from the fact that following Cromwell F. Varley's visit in 1867, telegraph interests brought over from France Georges de Infraville, in 1871, because he was a mathematician and had knowledge of electric circuit operation. The early electric light interests in 1882 brought F. B. Badt from Germany, to lend a hand with the paper work, and when the major telegraph company undertook to introduce high-speed telegraphy on its trunk lines, it was necessary to go to England for men familiar with the apparatus, and to America came S. P. Freir, S. H. Strudwick, and William Finn to engage in this extension. And then in 1885, Francois Van Rysselberghe came over from Belgium to introduce the first system of combined telegraph and telephone operation on American lines. All these visitors, except the Belgian, remained in America, and from them American communication workers learned much that was of benefit in building the services.

It has already been stated that very likely from Henry's time forward—after the introduction of electromagnets—experimenters on many occasions inadvertently set up electromagnetic radiation while carrying on investigations with other objectives in view, and that while radiation contin-

ued, small sparking effects were noted in wire or other metallic systems in the neighborhood of the source of the waves. Up to Hertz's time (1888) manifestations of this nature, when observed, were ignored; were not recognized as having practical significance. They were not understood. An explanation of their cause seemed beyond the human mind.

A particularly noteworthy instance of this order was the experience of Edison in the year 1875. In his laboratory sparks were observed in metallic systems situated in the neighborhood of a vibrating armature of the make-and-break electric bell type.¹ The succession of sparks at the contact points generated feeble electromagnetic waves that were being broadcast throughout the room. But no one present suspected that this was what was taking place. Although Edison, with the assistance of his aides, Charles Batchelor and James Adams, investigated the phenomena over a period of a month, nothing informative was learned as to the cause or the effect.

By a hairbreadth Edison missed a great discovery. That was twelve years before Hertz. The great American inventor had the intuition, however, to tag the observed phenomenon with a name which was not far from the truth—*etheric force*. A communication which appeared in a scientific journal at the time, written by Dr. G. M. Beard,² who had witnessed Edison's experiment, read in part:

At the present time the weight of evidence in my mind is in favor of the theory that this is a radiant force, somewhere between light and heat on the one hand and magnetism and electricity on the other, with some of the features of all these forces. If it be, as I have suggested, a kind of electricity which, after the manner of the shuttle, returns to its source by rapid forward and backward movements, it would yet be electricity under very different conditions from those under which we are wont to

¹ *Scientific American*, Jan. 8, 1876.

² *Ibid.*, Jan. 22, 1876.

consider it, and would be practically a new force. The more I experiment in this department, and the more closely I reflect on the results of experiments, the further I seem to be driven from the electrical toward the radiant theory of this force; and there would appear to be no ready escape from the conclusion that we have here something radically different from what has before been observed by science.

It will be recalled that Maxwell's main treatise was published about two years before the Edison observation, and it will at once occur to the student of radio history that had Edison, or any of his aides, read and understood Maxwell's proposals, very likely the errant sparks in the Edison laboratory would have been pursued to their lair, and Hertz anticipated.

The last experiment by Edison recorded in this series (December 26, 1875) shows that the spark effect was noted at a distance of 8 feet 4 inches, and it is intriguing to speculate on what the outcome might have been had the inquiry been directed toward experiments in reflection, refraction, and penetration.

One of Mr. Edison's biographers advanced the explanation:

When we think of those years of work and worry, when the quadruplex telegraph, the acoustic telegraph, the phonograph, the telephone, the dynamo, the incandescent lamp, and the three-wire system were born and nurtured, when men were to be taught and inspired, it is no wonder that the interesting "Etheric Force" should have been laid aside as one of the matters to be, perhaps, taken up some other time when there were more hours to a day.

At the time, surely, the electric light was of greater immediate importance than was wireless signaling. Certainly, in any event, the electric light extended the day's hours of working time, and thus supplied additional hours for labor. Edison and his associates could invest no more precious hours in pondering over the hidden reason for the appearance of vagrant sparks here or there about the labora-

tory. Away they went to the task of the electric light. As in the manner of Le Sage's Asmodeus, Edison had the desire to "wave aside all roofs" and get out into the open where there were things to be done which he understood.

Others were to reap the reward. The situation as it existed calls to mind Oliver Lodge's account, twenty years after the event, of how the twenty-one-year-old Italian youth, Marconi, reaped the harvest sown and harrowed by others. He wrote: ³ ". . . but so far as the present author was concerned he did not realize that there would be any particular practical advantage in thus with difficulty telegraphing across space instead of with ease by the highly developed and simple telegraphic and telephonic methods rendered possible by the use of connecting wires."

Initial Investigations

In America, in 1889, a paper entitled "Alternating Currents and Electric Waves" was presented by Elihu Thomson, then president of the American Institute of Electrical Engineers, dealing with the relations existing between Maxwell's deductions and alternating currents.

Also in 1889 Columbia University inaugurated a regular course in electrical engineering, organized by F. B. Crocker and Michael I. Pupin. Pupin was then thirty-one years of age. Within three years thereafter, Pupin, at Columbia, engaged in the study of electrical *resonance* and developed theories of tuned electrical circuits,⁴ which he described in a paper entitled "On Electrical Oscillations of Low Frequency and Their Resonance," published in the May and June, 1893, issues of the *Journal of Science*. Pupin presented a method of analyzing complex currents by selecting their components in inductively coupled resonant circuits. The method enabled him to examine the harmonics generated in circuits as a result of magnetic reactions in an iron core upon the magnetizing current itself. At Johns

³ *Signaling through Space without Wires*, p. 45.

⁴ United States patents 707,000 and 707,008.

Hopkins University, Professor Henry Augustus Rowland had attained results of this same order at about the same time or a little earlier.

In tracing American thought in the period following Maxwell's disclosures reference should be made to the work of Amos E. Dolbear, professor of physics at Tufts College. Dolbear at first proposed a system of communication without continuous conductors, by connecting a telephone



MICHAEL I. PUPIN

transmitter in the primary circuit of an induction coil in series with a battery. His proposal contemplated the use of an elevated conductor attached to one terminal of the secondary winding of the coil, the opposite terminal being earthed. In 1886,⁵ he proposed the substitution of a telegraph sending key in the primary circuit in place of the telephone transmitter. There was novelty in the employment of an elevated conductor. But this was a year before

⁵ United States patents 350,299 and 355,149.

Hertz. Had Dolbear employed a coil more powerful than the telephone type induction coil, and had he provided a spark gap in its secondary winding, in all likelihood he would have been sending out into space electromagnetic waves. Obviously, Dolbear was hopeful that by employing an elevated wire he might extend the range of the already experimented-with method of signaling by means of simple *induction*.

Even had Dolbear been successful, knowingly or unknowingly, in sending out electromagnetic waves, it was not until 1891 that experiments with wave detectors of the coherer type were made, so that without a means of intercepting, or picking up, electric wave signals an experimenter was no further ahead than was Maxwell in 1873.

In the seven years between Hertz and Marconi (1888-1895) the foremost American science professors carried on in the college laboratories experiments which in the main were intended to check, to confirm, results reported from European sources. Of those who were keeping abreast of the times one of the most eminent was Professor John Trowbridge, of Harvard University. American scientific literature of the period discloses that technical papers published in Europe were being gleaned in order that there should be no serious lag in the information available to interested American workers. But that there was a degree of lag is indicated when it appears that Professor Trowbridge did not at once envisage the prospect suggested by Maxwell and presented by Hertz. Possibly, like Dolbear, his viewpoint was too closely bound to the observed range of signaling by means of magnetic induction. It must have been difficult to conceive of electric waves traveling away from their source, through space, through obstructions, to great distances. In 1891, Professor Trowbridge stated:

It is hardly probable that any electrical method could be devised in which the air, or the ether of space, could advan-

tageously replace a metallic conductor on land for signaling over considerable distances.⁶

That was three years after Hertz's announcement, and the same year that Branly's coherer appeared in France. But it was practically the same thought expressed by Oliver Lodge, after Lodge had seen Marconi's demonstration. Trowbridge's declaration was of 1891; Lodge's in retrospect. In the beginning, neither of these outstanding physicists could see much of promise for wireless signaling. And they were not alone in their opinions. There were to be others after them, long after them, who "missed the boat," or almost missed it.

Tesla's Inquiries

Tesla's book containing his early lectures on high-frequency phenomena was published in New York in 1894. One of these lectures was delivered in New York in 1891; one in London in 1892, and one in Philadelphia in 1893. A review of the subject matter making up the 1891 lecture discloses that Tesla was to some extent familiar with what Hertz and Lodge had been doing. But this was four or five years before Marconi's convincing demonstrations, and as to priority of thought on the subject of electric waves in space, Tesla had at least the pronouncements of Maxwell, Hertz, and Lodge as spurs to imagination. From the text of his 1891 lecture it would appear that Tesla was of the opinion that the bulk of the energy of an oscillating system was consumed in impact and collisional losses—heat vibrations on the surface and in the immediate vicinity—and was not radiated into space to any considerable distance.

There is no escaping the conclusion that Tesla had not fully grasped the main point of Maxwell's message. Possibly, also, he had not up to that time had opportunity to analyze Hertz's results of 1888. In his 1893 lecture, Tesla said:

⁶ *What Is Electricity?* New York, 1896.

Some enthusiasts have expressed their belief that telephony to any distance by induction through the air is possible. I cannot stretch my imagination so far, but I do firmly believe that it is practicable to disturb by means of powerful machines the electrostatic conditions of the earth and thus transmit intelligible signals, and perhaps power.

Tesla's conception of the direction which "wireless" research should take hinged upon this 1893 pronouncement with respect to "disturbing" the electrical conditions of the

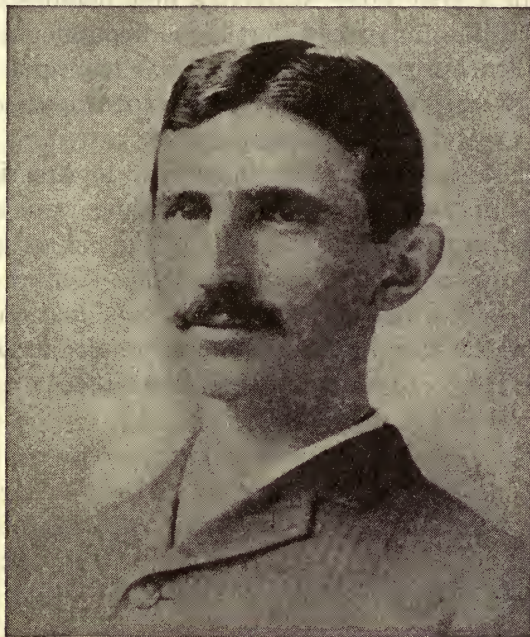

NIKOLA TESLA

As he looked in 1884, when he first came to the United States.

earth, and it was this dominant idea which drove him to the spectacular experiments carried on by means of Brobdingnagian towers erected at great expense on Long Island, New York, and on Pike's Peak, Colorado. At great expense, it was said, to a venturesome captain of industry. So far as

practical results are of interest this series of experiments proved unprofitable.

In fact, it might have been clear that the prior experiments of J. B. Lindsay, of Morse, Preece, Trowbridge, and others in telegraphing, and by Bell and others in telephoning, comparatively short distances by means of induction, and by earth conduction, had exhausted all immediate possibilities in these directions. There was, of course, novelty in Tesla's faith in higher powers. In June, 1897, a little more than a year after Marconi's first demonstrations in England, Tesla announced that he had completed a system that enabled him to telegraph *through the earth* to a distance of twenty miles, and that his experiments convinced him that greater distance was possible.

That these inquiries were under way in America at the same time that electric wave investigations were being conducted in Europe reflects the state of the art at the time of Marconi's descent upon London in 1896. And at that time there was no person, anywhere, with imagination equal to visualizing the world-girdling etheric pranks of Lord Haw-Haw and Tokyo Rose in the years 1941-1945!

Interstation Selectivity

The terms "resonance," "tuning," "syntony," and "selectivity" are in general synonymous, and are submitted here somewhat in the historical order in which they have been employed since Maxwell's time.

In the utilization of electromagnetic waves for transmitting signals through space it early became apparent that a commercial future for the invention would depend upon the development of means whereby more than two stations might satisfactorily carry on communication simultaneously in the same area. In the older, wire systems of telegraphy and telephony continuous wire conductors connect the respective stations, so that as many separate communications may be carried on simultaneously as there are individual wires (this, aside from the modern additions of multiplex, phantom, composite, and carrier-current channels over single wires, pairs, or other multiples).

In the case of wireless transmission employing electromagnetic waves, the medium through which the signals pass between all stations is the same. Hertz's early oscillators and the original space telegraph system devised by Marconi were deficient in that, in a common area, transmission from one station interfered with transmission from another station. Wireless signaling for practical purposes could not advance far beyond the spectacular stage until something was done to provide a degree of syntony, of tuning, to avoid interference.

Maxwell's mathematical deductions accounted for measurement of wave length, and in his writings he suggested what the factors would be found to be. Lodge, in 1888,¹ conducted experiments in the production and detection of

¹ *Philosophical Magazine*, August, 1888, p. 228; *The Electrician*, Vol. 21, pp. 607-608, 1888.

electric waves on a system of parallel wires suspended on insulators around a large room, excited by discharges from two condensers. He secured experimental evidence of nodes and loops on such wires, and worked out a method of measuring the approximate wave length.

But in 1896, when William Preece assisted Marconi, both of them on foot, to carry the wireless demonstration gear out into the open English fields, no one could have found in the boxes anything in the semblance of tuning devices. Nine years previously Hertz had, in a paper, discussed *resonance phenomena*; but without bothering about such refinements, Marconi, with a fiery glow of heart, rushed over to England to exhibit his handiwork. It is probable that the promiscuous propensities of the emanations from the oscillating system he at first employed were recognized by Marconi as a drawback. But then, Magellan didn't wait for the building of the Panama Canal to sail from the Atlantic to the Pacific and on to Leyte, where he encountered the two kings!

In Marconi's British patent, No. 12,039 (the first patent on wireless), no reference was made to tuned circuits, and throughout the years 1896-1899, little if anything was done to apply tuning to wireless signaling. Actually, the detector (the filings coherer) employed was indiscriminate, and it was directly connected in an untuned antenna circuit.

Marconi had, in 1898, introduced a sort of "signal booster," which he named an oscillation transformer, into the receiving circuit. Those who worked with it called it a "jigger." The antenna included a primary winding of a few turns, which was coupled to a secondary winding applied to the detector. But no intentional tuning was provided.

With regard to Lodge's demonstrations of syntony, employing parallel conducting wires, it is well to recall that Oliver Heaviside had recognized that the propagation of electric waves along wires was in all essentials identical (in respect to the laws governing the motion) with the propagation of electric waves through space. Heaviside employed

the terms "inductance," "reluctance," "reactance," "permeance" and "permittance," which in time were to become household words in the terminology used by engineers identified with the advancement of wireless signaling.

Early Attempts at Circuit Tuning

Marconi is on record as stating that in 1895 he studied Hertz's reports of experiments performed seven years previously, and he stated further that he realized that if Hertz's oscillator was to actuate a receiving system successfully, these would have to be tuned together: the sending and receiving circuit systems would have to be of the same oscillation period. When straight wires or metal plates were employed at each terminal or when loops or rings of wire were used, these should be of the same physical dimensions. But, as already mentioned, Marconi's patent of 1896 made no reference to tuning. In some of Marconi's early demonstrations parabolic reflectors of the Hertz form were used with the objective of radiating energy as by means of mirrors.

It was not until 1898 that Marconi employed inductance coils in antenna circuits. His noteworthy patent No. 7,777, issued in 1900, showed four tuned circuits. At the transmitter the spark-gap oscillator was coupled to the antenna, and through the functioning of an adjustable capacity in the gap circuit and a variable inductance in the antenna the circuits could be brought into resonance. In the literature of the art, credit is given to Ferdinand Braun, in Germany, for having devised a coupling arrangement of this same order. The resonant coupling provided for more persistent trains of oscillations in the antenna, with consequent betterment of effective radiation.

In receiving circuits the antenna was tuned to incoming signals by incorporating variable inductances, and the detector circuit, inductively coupled, was tuned to be in resonance, by employing variable inductance. These pioneer first-moves were for the purpose of increasing effective trans-

mitted power and to render circuits more sensitive and selective to particular frequencies (wave lengths).

In Oliver Lodge's lecture of 1894, on the subject of Hertz's work, he pointed out the need for a persistent train of oscillations if selectivity was to be obtained between oscillator and receiver, and stated that conspicuous energy of radiation and persistent oscillation were incompatible—referring to a single circuit. In 1897, Lodge had had opportunity to study the results of the early Marconi demonstrations, with respect to the factors involved in extending the distance of operation. These observations, supplementing his own laboratory work, led to the invention² of a radiator system that employed an inductance in association with a large capacity antenna for the purpose of prolonging the train of waves sent out and improving selectivity.

In Germany the laboratory physicists, as distinguished from the experimenters and tinkers who often blunder through to achievement, had been at work on Hertz's discovery, and by the time six or seven years had passed they began publishing technical papers containing the results of their deliberations. By the year 1895, Oberbeck,³ and V. Bjerknes⁴ had also reached the conclusion that the practical utility of electric waves in space was likely to be dependent upon syntonizing balancing of associated circuits. In Germany also, Ferdinand Braun⁵ proposed a transmitting system to be designed for the purpose of producing waves of greater lengths than those radiated by the simple oscillator, due to Augusto Righi, at first employed by Marconi. Braun's early proposals were more in the nature of prophecy than of claim to invention, his suggestion being for a transmitting system with a closed oscillatory circuit, containing capacity and inductance, but even as late as 1899 the employment of coupled circuits in a transmitting system should have been novel.

² British patent 11,575, 1897.

³ *Wiedemann's Annalen*, Vol. XXV, p. 63.

⁴ *Wiedemann's Annalen*, Vol. LV, p. 21.

⁵ British patents 1,862 and 22,020 (1899).

The technique of tuning in electric wave signaling may seem to have been slow in developing, but the fact is there was much to learn. The subject was new and the workers few. Further, it had not yet become common for scientific societies to offer stimulating rewards for scientific achievements. At the time, in certain instances, theories were worked out on paper but got no further. In other instances physicists who were delving into theoretical considerations had not at hand the means with which to check theory. Also, it is well known that there have been, and still may be, physicists gifted with the ability to prosecute pure research but whose inclination toward experimental demonstration is heavy-footed.

In later years (1910 forward) this situation was considerably remedied by bringing together in single organizations, often under one roof, the mathematicians, the physicists, the experimentalists, and the engineers. Prior to the advent of the science laboratories of the large corporations, in the main the forward steps were made by investigators, remotely separated, who labored independently in small laboratories or in colleges. And although this situation is not likely ever to be completely changed, it results in much duplication of effort, if in independent, simultaneous discoveries of importance around which there shall always be no end of disagreement and dispute as to priority.

At this point we are engaged in tracing the growth of ideas involved in operating several space telegraph stations simultaneously in a common territory, and in improving methods of transmission to the end that greater distances might be worked over. These were the problems confronting Marconi and others in the four or five years following the initial trials in England in 1896. Looking back over the situation as it existed at that time we may recognize that the step covered by Marconi's Patent No. 7,777 in 1900, constituted a distinct advance and held promise.

At the receiving end, Marconi utilized separate absorbing and detection circuits, coupled together, permitting tuning to a given frequency. An examination of the wiring ar-

rangements included in this development shows that advantage was taken of the 1897 improvements made by Lodge, and also of those suggested by Braun. Marconi was a personable young man, and as he mingled with older men in the communication business and with the various physicists who were interested in what he was about he was in a favorable position to apply directly what he learned from week to week.

Additional stations were set up, the distance was increased over which wireless signaling became possible, and the problem of tuning became more pressing. Actually, it was not until several years later, when more sensitive detectors replaced the coherer and continuous waves became available that tuning became thoroughly practicable. But Marconi was all for pushing on with what he had, making improvements and additions where and when possible. It is of interest to note the early extensions of coverage. In March, 1897, Marconi telegraphed a wireless a distance of 8 miles. In November of the same year this was extended to 18 miles. In the following July the range had been pushed up to 25 miles, and in 1899 skeptics here and there puckered their brows in wonderment when Marconi announced that with his apparatus he had telegraphed a distance of 150 miles.

So long as but one experimenter, or organization, set up wireless service in a particular area the difficulties of interference were under the degree of control necessary to prevent conflicting transmissions. But the promising new art had to advance, and it was the Mother of Invention that applied the spur.

Wireless News Reporting Debut Balked

In October, 1899, Marconi had been engaged by the New York *Herald* to bring over wireless equipment which it was hoped could be used to report the progress of boats sailing in the international yacht races off the Navesink Highlands, New Jersey. A brave attempt was made to render the desired service and some results were attained, but

they were not of a character to make sailormen who wave signal flags feel jealous. And then, in 1901, when the proud *Shamrock* was pitted against the hopeful *Columbia*, the same service was undertaken by Marconi's aides. Alas, in the meantime, in the United States a wireless telegraph company had been organized to exploit the early inventions of Dr. Lee de Forest. Alack, another group of enterprising Americans also had assembled some wireless equipment with the intention of reporting the progress of the race. The situation was that which Marconi, Lodge, and the German workers had with misgivings anticipated. Three rival wireless telegraph systems (in the main all alike) were attempting to operate simultaneously in a common area. All this while each organization perforce had to shuttle the sending equipment of its system, installed on fast tugboats, across the wind-swept waters.

The over-all result was what might have been anticipated. Immediately it was apparent that whatever had been thought of, or patented, in the way of selective systems of operation assuredly had not been incorporated as elements of the equipment employed on this memorable occasion; or, if tuning systems were used they were conspicuously unsuccessful. The interference created such etheric confusion that managers of submarine cable companies again slept well o' nights.

This situation could not be permitted to continue. Even had Wall Street blundered into the picture, buying the rival operating organizations and all their wares so that discipline might be applied, operating a single wireless circuit in a particular territory never would have been profitable. No, the thing to do was to go home and try all over again. The wireless Tower of Babel set up at Navesink Highlands in 1901 was for years the butt of many a pungent quip in wireless workshops—and in telegraph cable offices.

Radiomen of a later day will sense that the trouble with the first attempts at tuning in actual wireless signaling was lack of sharpness. In the writings of Hertz, Lodge, Thomson, Heaviside, Bjercknes, Oberbeck, Braun, Zenneck, and

others there was clear suggestion pointing to the need for syntony. But when the experimentalists identified with the early attempts to set up stations for wireless signaling got out into the open, with nothing save cerulean sky to connect the stations, there was an understandable feeling of frustration, which took the form of questioning whether the theories of the laboratory, where proper conditions



LEE DE FOREST

could be established and where the factors were under control, were truly applicable across the voids.

It turned out to be fortuitous that various of the physicists of the pioneering days in science engaged in investigations not directly related to wireless signaling but whose achievements were of an order which could be drawn upon by wireless workers. Arc lighting, the electric motor, and the dynamo, alternating current technology, and alternating-current transformers were the fruits of widespread scientific application. Beginning with the work of Antonio Pacinotti, in Italy, in 1860; Zénobe Gramme, in Belgium, in

1870, the Gaulard and Gibbs work on transformers, 1883, down to the work of William Stanley, George Westinghouse, Tesla, Pupin and John Stone Stone in America, the foundation was laid for the larger works of electrical engineering. When the published results of the work of these investigators, and others, got into circulation, wireless researchers began to get a clearer picture of what they would have to accomplish if wireless was to be successful.

Resonance, it was learned, occurs in a circuit when a sustained alternating voltage, the frequency of which is equal to the natural frequency of the circuit, is applied to its ends. Resonance exists in a circuit that possesses the proper balance of capacity and inductance. Further, complete resonance obtains when the frequency is such that the inductive reactance exactly equals the capacitative reactance. Also, the electrical properties of a circuit tuned to resonance are dependent upon whether the inductance and capacity are connected in series or parallel.

It was learned that in the case of series resonance the current is a maximum when a single lumped capacity and a single lumped inductance are connected in series between the terminals to which an alternating voltage is applied, and either inductance or capacity or frequency varied to obtain resonance. To continue, sharpness of resonance, to sustained alternating current, is a quantity expressing the measure of change of current value in a simple series circuit for a given alteration in either the capacity or the inductive reactance when resonance obtains. Sharp tuning is indicated if a small change in the frequency of the applied alternating voltage results in the induced current falling off rapidly on both sides of the resonant point.

Damping and Coupled Circuits

From the foregoing the reader may hazard the guess that following the yacht race wireless reporting of 1901, such as it was, the prosecution of wireless enterprise was in a fair way to becoming an engineering undertaking. The term "coupling" came into use when the early attempts were

made to tune the sending and receiving circuits, and soon the term "damping" appeared. Briefly, damping refers to the rate at which an oscillation dies away. Damped oscillations, therefore, are those which decrease rapidly in amplitude. The oscillations produced by the early transmitters of the spark-gap type were rather highly damped, each spark producing a train of oscillations that quickly died out.

A *coupler* came to be known as an apparatus used to transfer radio-frequency power from one circuit to another by associating portions of these circuits. As time went on, refinements of coupling provided for inductive, capacitive, or resistance arrangements. In inductive couplings where two associated coils are used, *very loose* coupling is that in which the secondary coil exerts no appreciable reaction on the primary coil, while *loose* coupling is that in which there is an appreciable but slight reaction effect. *Close*, or *tight*, coupling permits interaction between the two coils, which changes the decrements of the oscillations.

By *amplitude* is meant the maximum value reached by an alternating quantity, either positive or negative. *Decrement*, or logarithmic decrement, may be regarded as a constant of a simple radio circuit, being 3.1416 times the product of the resistance by the square root of the ratio of the capacity to the inductance of the circuit.

These terms came into use gradually as the factors they represent came to be better understood. In the year 1900, the mathematics of wireless was in the lead of practical demonstration. The elements of the transmitter assembled by Marconi consisted of an induction coil capable of producing sparks six to twelve inches in length between the terminals of the secondary winding, oscillator spheres, Leyden jar condensers, Morse sending key, battery and antenna wire (Figure 5). So long as the induction-coil type of transmitter with open-gap discharger was employed, there was little hope of being able to send out electric waves that could be confined to close limitations of frequency (wave length). And while this condition continued there was little to be gained by attempting to make receivers selective.

So that, after all, it might turn out that the mathematicians were right in regard to syntony and tuning of wireless signaling circuits, but the experimentalists would have to devise transmitters which sputtered less than did the noisy "spark coils," and which would permit sending out more uniform and orderly radiation.

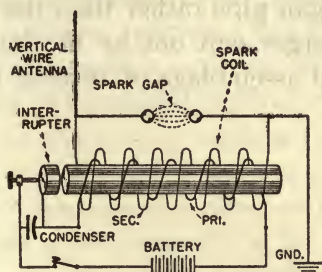

FIG. 5.—Wiring of induction-coil type of wireless telegraph transmitter. On an iron core is wound the primary (heavy line) and on top of that the secondary (light line). The terminals of the secondary, or high-tension, winding, extend to the spark gap, while the primary winding is in series with a battery, sending key and circuit breaker. In practice a condenser was connected across the spark gap.

The induction-coil type of transmitter used by Marconi in 1896 continued for many years as the means by which electric waves were produced for signaling purposes. In some installations it was still employed as late as 1923. It was ever a device beloved by amateurs. Wherever its crackling noisy sparkings were heard you knew at once that something mysterious, as well as spectacular, was going on. Its limitations were early realized by those endeavoring to extend operating range and striving to develop selective signaling methods. Depending upon the oscillatory discharge of a condenser, the process of energy transmission was intermittent. The condenser had first to be charged, and then discharged, resulting in the production of successive groups of damped oscillations. A group might consist of from twenty to one hundred oscillations, and in general the frequency of oscillation was of the order of a million. Because of the intermittent nature of the process of charge

and discharge, actual radiation of energy took place only about $\frac{1}{100}$ part of the time the transmitter was operated.

Workers sensed the need for a type of transmitter which would send out continuous trains of waves of sustained amplitude. It was anticipated that waves transmitted by an apparatus of this type would resemble the sound waves emitted by an organ pipe rather than the succession of explosionlike discharges sent out by the induction coil, condenser, spark gap assemblage of revered memory.



The diagram illustrates a circuit for the production of continuous waves. It shows a transformer with a primary winding connected to an AC source and a secondary winding connected to a series combination of a condenser and a spark gap. The spark gap is designed to operate at a high frequency, producing a train of waves of sustained amplitude. The circuit is completed by a ground connection.

The production of continuous waves of sustained amplitude is a fundamental requirement for the transmission of information by radio. The apparatus described in the diagram is designed to meet this requirement by producing a train of waves of sustained amplitude. The spark gap in the circuit is the key component, as it is capable of producing a train of waves of sustained amplitude. The condenser in the circuit is used to store energy and to smooth out the pulses of energy produced by the spark gap. The transformer is used to step up the voltage of the AC source to the level required for the operation of the spark gap. The ground connection is used to complete the circuit and to provide a reference point for the voltage of the AC source.

Improving Transmitters

In the beginning, promoters could visualize a profitable use for wireless mainly by making a bid for a share of the paying message traffic passing over the wires and cables of the world. Privacy of message handling would be essential for such service. In the case of wireless this would call for highly selective reception, and so soon as possible, directive transmission. For Marconi and other early organizers the immediate practical use envisaged for the new system was that of signaling between ships and between ship and shore. Viewed in retrospect, we know now that although great strides were to be made in signaling on the high seas, even between continents, during the first two decades of the century, those two decades plus two additional years were to pass before wireless, having become radio, was destined to be

The whisper that leaps the hemispheres; the song that echoes round the world; the cadence that rides the ether in a thousand tongues.

The new service was to become known as *radio broadcasting*. Broadcasting! The very thing that Marconi and others in the early days viewed with dismay while they contemplated competition with submarine telegraph cables.

But then, broadcasting, once millions of homes were equipped with broadcast radio receivers, was to do away with the need for Paul Revere; was to make it unnecessary ever again for barnstormers to "shout from the housetops"; no longer should there be enforced impotence upon "voices in the wilderness"; messengers from the Plain of Attica, or elsewhere, should never again have to sprint afoot from Athens or anywhere else carrying news of success or defeat.

Radio broadcasting was destined to convert listening audiences of a few hundred persons into world-wide audiences of hundreds of millions, all at the same time listening to the same speaker, or the same crooner.

The broadcasting proclivities of Marconi's puny apparatus contained no hint of the fame and fortune someday to be garnered by a few score of the American infants of the early nineteen hundreds. While the physicists, engineers, experimenters, and amateurs were occupied slowly but surely erecting the edifice of radio, Bing Crosby, Jack Benny, Fibber and Molly, Huey Long, Father Coughlin, and the Town Hallers were growing up. Unknowingly they were exercising their voices for stentorian employment on rostrums from which were to be reached daily fifty million customers.

But before these economic glories could materialize there was still work to be done by the radio builders. That those two decades were to be busy years for the makers of radio we shall discover as we proceed with this narrative.

Arc Transmitters

In those years wireless signaling was in need of more efficient transmitters and of improved radiation. A search through the records of the prior art to uncover inventions or proposals, which might be availed of, to devise improved methods of electric wave transmission, discloses, as one innovation, that in America, Elihu Thomson, as early as 1892 had in a patent application¹ proposed a method of producing high-frequency current from a direct-current source. This was done by connecting a condenser and a tuning inductance to an open metallic spark gap, which also was connected through two additional inductances to a source of direct current. The arc formed was constantly extinguished by means of an air blast or a magnetic blow-out. The principle of operation was that before the arc was formed and just after it was extinguished, the con-

¹ United States patent 500,630.

denser was given a charge from the direct-current source. Re-establishment of the arc permitted an oscillatory discharge to take place. The inventor stated that oscillations up to 50,000 per second could be produced by these means.

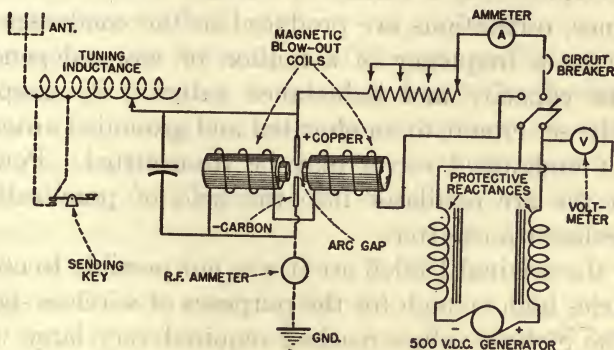

FIG. 6.—Circuits of an arc transmitter.

A year later, W. D. Dudell, in England, presented a paper on the subject "Rapid Variations of Current Through the Direct-Current Arc." In his British patent, No. 21,629 (1900), Dudell showed that if a suitable arrangement of capacity and inductance were connected across the terminals of a continuous-current arc, the gap being between rods of carbon, a high-frequency current was set up in the condenser circuit and a musical sound produced by the arc. Dudell proposed using his oscillator as a transmitter for wireless telegraphy, observing that the arrangement should have particular applicability where it was desired to transmit electromagnetic waves tuned to a definite frequency.

Here was a promising improvement over the induction-coil transmitter, and it was destined to see service. Three years after Dudell's arc system was described, Valdemar Poulsen, in Denmark, contributed an improvement by enclosing the arc in a vessel containing hydrogen or coal gas, and forming the arc between a metal terminal, the positive, and a large carbon terminal, the negative. By subjecting the arc area to the influence of a strong magnetic field, much

higher frequencies could be obtained than by means of the double carbon gap in air.

Poulsen's apparatus was a logical development of the Thomson arc and the singing arc of Dudell. When the arc in gas is shunted by a suitable condenser in series with an inductance, oscillations are produced in the condenser circuit having a frequency of a million or more, depending upon the capacity and inductance values. By coupling the condenser circuit to an elevated and grounded antenna, trains of undamped waves may be transmitted. Poulsen brought the arc oscillator into the field of practicability as a wireless transmitter.

With the original Dudell arc it was not possible to obtain frequencies high enough for the purposes of wireless signaling. The highest values reached required very large units of capacity and inductance. For a wave-length range of from 300 to 8,000 meters, the frequency must range from 40,000 to 1,000,000 per second, and this was accomplished with the Poulsen additions.

The introduction of the arc method of producing oscillations started the world over an entirely new crop of investigations which, in the main, brought only minor, detail improvements; in some instances variations in the elements employed in assembling the transmitter obtained similar results by somewhat different means. Arguments were advanced purporting to show that the Poulsen arc was not a true singing arc, but who in wireless work cared about that! The arc produced a "sweet" note.

The arc method of wireless transmission was to find considerable employment in America. Peter Cooper Hewitt had demonstrated the sensitiveness of the conductivity of mercury vapor to the varying influences of a magnetic field, and within the first decade of the twentieth century, Frederick K. Vreeland proposed the use of a mercury-vapor tube arc, which had merit in that difficulties being experienced with arc electrodes were considerably minimized, and the terminal voltage could be made much higher. Voltages

up to 6,000 per tube were applied and, although it might seem that there was no need for such high primary potentials, the possibilities from this seemed preferable to the alternative of using a number of arcs in parallel, as was at the time proposed for increasing the energy available with the carbon arc method.

Before leaving the subject of the arc oscillator, until it may again be taken up in connection with the development of radio telephony, it may be stated here, as an indication of how the method was extended to meet the growing needs of wave telegraphy in following years, that the Poulsen arc generator was developed up to units of 400 kilowatts, ranging down to units of 2 kilowatts, in thirteen sizes, the most widely used being a 5-kilowatt size. Up to the year 1920, eight hundred stations, ranging up to 25 kilowatts had been equipped, and eleven units of 200 to 400 kilowatts were built and installed. This notwithstanding the lapse of several years after the invention of the arc system before it was applied to wireless on a commercial scale.

Through the years following 1900 there was no end of discussion on the subject of *continuous* waves for wireless signaling, but the number of stations employing *spark* systems had been rapidly increasing throughout the world, and there was widespread striving to eliminate the defective features of the latter. Following the initial tests in England, the objectives of greater distance and of tuning soon occupied the minds of the workers. It did not take long for the experimenters in Europe and in America to recognize that a serious deficiency of the spark method was the long inactive interval between the first spark of one wave train and the last oscillation (of effective amplitude) in the preceding train.

The Synchronous Rotary Spark Gap

In America, Tesla, in 1896,² invented a system for the production of high-frequency currents, an important ele-

² British patent 20,981 (1896). See also British patent 8,575 (1891).

ment of which was a synchronous rotary discharger. It consisted of an iron-core step-up transformer, the primary supplied from available alternating-current mains, the secondary having connected across its terminals a rotary discharger and the primary of an air-core transformer, with a condenser in each leg. An odd quirk in this connection is that in his patent Telsa made no reference to the application of this generator of high frequencies to wireless telegraphy. But a dozen years later the method was standard in many of the wireless stations in operation. The secondary terminals of the oscillation transformer connected to antenna and earth, respectively, accomplished more efficiently what the induction coils connected in the same manner had been expected to do.

Of course, prior to the year 1896, there had been little beyond academic interest in America in what Hertz had discovered. It was not until Marconi appeared on the scene in that year that experimenters directed attention to studies of the principles of space signaling, and then informative literature began to arrive in this country, appearing in technical journals.

One of the earliest illustrated descriptions of Marconi's apparatus published in America appeared in the journal *Telegraph Age* (later *Telegraph and Telephone Age*), issue of November 1, 1897. This article presented an understandable account of the elementary equipment used in the 1896 and 1897 trials in England, including the elevated antenna and the earth connection. A month later, in the *Journal of the Franklin Institute*, appeared a review of Marconi's early demonstrations. These descriptions were followed at intervals by references in American journals to what was being accomplished in England and other European countries, and it was not long until a horde of amateurs in America were tinkering with homemade induction coils.

Of the well-informed Americans who early took up the study of wireless one was Reginald A. Fessenden, Canadian born, who became professor of electrical engineering at Pur-

due University and at Western University of Pennsylvania. Reference has been made herein to Nikola Tesla's announcement of 1897, to the effect that he had succeeded in telegraphing a distance of twenty miles *through the earth*. In connection with this announcement it is of passing interest to inquire what Tesla's contemporaries were thinking about his reported achievements in signaling without connecting wires. In the *Electrical World*, August 7, 1897, there appeared an editorial which read, in part:

It is stated on authority of the New York *Herald*, under a caption ten lines high, that Mr. Nikola Tesla is about to discharge upon the suffering world an electrical disturbance which, in the language of our esteemed contemporary, "travels on the alternating currents with which the earth and air are charged, at the rate of several million miles per second." It is also stated that "the disturbance from the machine is felt instantly all over the globe." While we are not told whether the feeling accompanying the disturbance is pleasant or otherwise, it is to be inferred from the lurid language in which these remarkable results are made public that the cataclysmic forces of nature are to be unchained and go careering through the realms of the air at the will of the inventor. . . .

In that same issue of the *Electrical World* appeared an interesting article from the pen of Professor Fessenden, in which he revived the subject of telegraphic connection between America and Russia by way of Bering Strait. In one paragraph Fessenden stated:

Putting on one side the utterances of electrical fakers about "wobbling the earth," the fact remains that there are at present practical means by which messages can be transmitted without wires . . . one is Marconi's system of telegraphy, with an improved form of Lodge's ball transmitter, and the coherer receiver.

Fessenden's Alternator

As we came to know Fessenden in later years, we could visualize his expression of impatience with what he re-

garded as visionary pronouncements. In 1897, Fessenden carried on experiments with detectors of electric waves, the results of which were incorporated in a thesis. He investigated also the variations in radiation with frequency changes and determined that it should be possible to construct an alternating-current generator of sufficiently high frequency and output to provide ample radiation for wire-

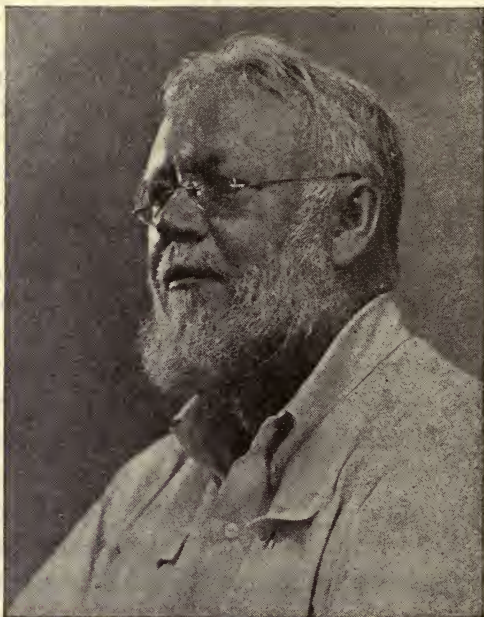

REGINALD A. FESSENDEN

less signaling purposes. Obviously, complete success in this would in the course of time replace the transformers, which had begun to render obsolete the original induction coils. But the cup of success is not filled all at once.

In 1900 an order was placed for an alternator patterned after Fessenden's plans, but owing to difficulties that developed in design and manufacture the machine was not ready for testing until 1903. The first unit turned out was a 1-kilowatt output at 10,000 cycles. A second ma-

chine came along in 1906, which with $\frac{1}{2}$ -kilowatt output operated at 75,000 cycles, and a year later a more promising unit appeared having an output of 2 kilowatts at 100,000 cycles.

These alternators embodied several ingenious features. The armature (having a resistance of 6 ohms) was driven at a speed up to 10,000 revolutions per minute, the frequency obtained being 60,000 cycles. When driven at a greater speed, by a steam turbine, a frequency of 100,000 cycles was obtained. These machines were new to the electrical art, and in their design and construction engineers were employed whose names in the course of time became known the world over in connection with space telegraphy. The more prominent of these were: Steinmetz, Alexanderson, Haskins, Dempster, Geisenhomer, Stein, and Mansbendel.

The first important use made of the new alternator by Fessenden was at his Brant Rock, Massachusetts, experimental wireless station in 1906. Machines of this type, further improved by Alexanderson, were destined in the years following 1917 to play a large part in the establishment of commercial radio telegraph service across the oceans.

Practical Considerations

At the beginning of wireless signaling it was clear that one important difference between land-line telegraph installations and wireless equipment was that each wireless station would require its own power plant. The distance range of a station was, in the early days, dependent upon the power employed. In land-line telegraphy and in submarine cabling the voltages required are very small compared to radio voltages, and in the case of land-line telegraphy from two to thirty or more individual stations can be connected by a single conducting wire, power being required only at the two terminal stations; often at but one of these.

High-frequency alternators, being of special design and construction, were sure to be costly and their use justified only at stations where a considerable amount of traffic was to be handled and at stations intended for transmitting very long distances.

The Thomson-Dudell-Poulsen arc apparatus had certain advantages in this respect, which made the system more adaptable for medium- and small-sized stations, and for isolated stations where sources of commercial primary power were not at hand. The alternator idea did not find particular favor in England and it was a decade or more before machines of this type were installed there to furnish power for overseas services. J. A. Fleming, who had been associated with Marconi since 1898, was in doubt as late as 1904 about the practicability and efficiency of high-frequency alternators for wireless. His views evidently were based on experience, which indicated for pure, free waves to be radiated in detached form by a transmitting system it would be necessary to have very high frequencies and very sudden reversals of electric force.

Nor was Fleming alone in his view. Professor C. R. Cross, in America, on one occasion stated:

Alternating-currents in the sending antenna will not produce Hertz waves in the ether. Motions of some kind would be produced, but they would be of a quite different character. Hertzian waves are produced only by the disruptive discharge.

As was Fleming at the time, Professor Cross was still a believer in the "whip-crack" efficacy of the ebullient spark. To mark how this notion had taken hold of the imaginations of the early workers, it may be recalled that in the early legal contests between Marconi and American wireless interests, Marconi declared:

The difference between Hertzian oscillations and ordinary alternating-currents is most certainly not one of degree. It is clear to me that there is no Hertzian wave telegraphy without

the essential feature for producing Hertzian waves, which is the Hertzian spark.

Other Spark Advances

While the Poulsen arc system and the alternators of Alexanderson and Fessenden were bidding for consideration as producers of sustained (continuous wave) oscillations, innumerable attempts were made to improve transmitters of the spark type so that these might be expected to keep up with the expanding demands for wireless service, particularly at sea.

As a record of the trend of thought along this line reference may be made to the proposals of S. M. Eisenstein and J. Sahulka. Eisenstein, employing three-phase current supply to energize the primaries of three transformers or induction coils, in which the current from each phase passed through the primaries in turn, caused the production of oscillations at three spark gaps, one after the other. By this means the transmitter could be maintained in excitation even when using a current of comparatively low frequency. The purpose was to avoid the inactive intervals between the sparks of a train, previously recognized as objectionable, and thus make the energy supplied to the antenna approach in uniformity that of a sustained frequency. This scheme was a step in the desired direction as, clearly, the inactive intervals were in large measure bridged over. But there remained a lack of constancy between successive discharges; although it was not fully recognized at the time, an element that was wanting was an improved form of spark gap. This was to be forthcoming.

The solution of the difficulty proposed by Sahulka³ (in Austria) sought to accomplish the same purpose by mechanical instead of electrical means. He believed that the main cause of the inactive intervals between wave trains from spark transmitters was that during the whole time the spark continued the current source was practically

³ German patent 176,011 (1906).

short-circuited, its terminal potential difference being reduced to zero. The voltage, he contended, could increase only gradually upon cessation of the spark, due to the inductance of the circuit and the process of again charging the condenser. To remedy this condition Sahulka employed a rotating commutator of special design. The device differed from Tesla's rotary discharger in that two condensers were employed, alternately switched from a charging circuit to the oscillatory circuit. The surface areas of the commutator segments were such that the contacts for charging were of shorter duration than those for discharging. This provided that the discharge connection was maintained long enough to reduce to a minimum the breaks between successive wave trains.

While unending efforts were being made to devise ways of producing electric waves without employing induction coils, often fitted with inefficient vibrators to interrupt the primary circuit, partisans of the Ruhmkorff instrument were industriously seeking means of improving that device. It was conveniently portable and easily installed. In France in 1900, Dr. Oudin invented a bipolar resonator, the principle of which was applied three years later by Professor Rochefort in designing a transmission system for wireless signaling. The Oudin apparatus was similar to the air-core high-frequency coils of Tesla, but as utilized by Rochefort a single air-core coil was energized by an oscillating circuit consisting of a bridged spark gap, condensers in series, and connection to the secondary circuit of an induction coil. The induction coil retained the advantage of a low-voltage, direct-current source of power to actuate the primary. The single air-core was in fact an antenna tuning inductance, arranged so that taps might be made along its length to obtain various transmitting frequencies.

A noteworthy feature of the early Rochefort assembly was the improved form of induction coil employed. Previous induction coils had been built with the iron core in a horizontal position, one reason for this being that as long

as the magnetism of the core was employed to attract the armature of the make-and-break interrupter, the armature could be mounted in a vertical position so that it should vibrate in a vertical plane. With the use of independent circuit breakers, such as the electrolytic type invented in 1899 by Dr. Wehnelt, there was no need to attach a vibrator to the induction coil proper. The interrupter could be mounted separately. The Rochefort coil was of the vertical type, and the potential developed at the terminals of the secondary was unipolar. To achieve this end the secondary was formed of a double winding of wire, returning and reuniting at the pole from which it started. By this method of double winding the tension at the center of the coil was negligible, but was greatly accentuated at the terminals.

But the doom of the induction coil was sealed when more stable means of producing electric waves gradually arrived at the stage of practicability. This, notwithstanding that the sputtering coils were to continue for another decade of time as a source of unalloyed inspiration for a host of amateur wireless experimenters in all parts of the world.

Working Toward Antenna Improvement

In order to understand the improvements made in spark gaps and oscillators from the time of Marconi's early demonstrations until the introduction of vacuum-tube oscillators nearly two decades later, it may be informative here to scan the trend of thought bearing on the nature of electric wave propagation and what had been done to improve radiation from antenna systems.

The chronicler, seeking to gauge the exact knowledge of an art at a given period must needs extend his inquiry into the contemporary work in colleges, laboratories, and workshops of several countries. Reviewing the subject from an eminence of time nearly half a century later, there is no way but to glean the literature of the science as published in treatise and discussion forms. The task is less arduous when a historian can call upon personal recollection and have recourse to notebook files containing chronological series of references, dated and classified.

For many years after Hertz—indeed, for years following Marconi's convincing demonstrations—the phenomena experimented with were far from being understood in terms acceptable to all those engaged in research and experimentation. The fact that there are still (1945) principles to be cleared suggests that in the year 1900 convincing explanations were out of the question. An interpretation persisting for a time was that there existed mutual induction between the separated elevated conductors (antennas) employed at the respective communicating stations. But the gradual increase in the distance over which operation was accomplished removed support from this view. Also, the proof that, by wireless, communication could be established between stations far enough apart to be screened



Beam antenna and line of towers for long-wave antenna, Rocky Point, Long Island, New York, station. (Courtesy of Radio Corporation of America.)

from each other by the curvature of the earth left induction advocates without supportable argument.

Some of the early workers advanced the suggestion that the observed effect was of an electrostatic nature. But these advocates were lost in the bright clouds of their hopes when someone else countered that, if so, the effect should diminish in inverse proportion as the cube of the distance, and quickly disappear as energy capable of actuating any then known detecting device.

Following the marked gains in distance achieved by Marconi by grounding one terminal of the transmitter and of the receiver in 1897, workers were impressed with the idea that possibly there was conductive action through the surface of the earth. Tesla appears to have had no doubt of this, even though, apparently, he was not thinking of electromagnetic radiation. Certainly the earth played a part, else why should Marconi reach greater distances after applying ground contacts? But here again was confusion when signaling tests were carried out between a station on the ground and a wireless receiver carried aloft in the basket of a balloon!

When no general agreement could be had as to the exact nature of electric wave phenomena, it was a passable statement for a physicist in the year 1900 to say that wave propagation was a combination of several causes, one or the other predominating, depending upon existing conditions.

At an International Electrical Congress, held in Paris in the year 1900, a paper was presented by André Blondel and Gustave Ferrié, both of whom were identified with early wireless research, which contained a thoughtful and intelligent review of the art as it was understood and practiced at that time. Three paragraphs from this paper are worthy of quotation:

Electric oscillations are produced along the wire and in the neighboring ether in the space between the antenna and the earth. From the seat of this disturbance originate the waves, which are propagated into surrounding space. These waves are

polarized and form surfaces of revolution around the antenna. The lines of electric force are in meridional planes and connect perpendicularly with the earth; the magnetic lines of force are in circles having the antenna for a common axis. But as a result of this polarization and of the effect of concentration, well known in the propagation of waves along wires or metallic surfaces, the electric density is much greater at the surface of the earth, directly connected with the oscillator, than in the atmosphere; and in large part the magnetic lines appear to slip along the earth. This concentration, moreover, is the greater the more perfect the conductivity of the surface over which the waves proceed, and the loss of energy in this transmission is thereby lessened.

Yet, this concentration does not prevent the diffusion of an important part of the energy into all space in the form of hemispherical waves, the effects of which are less intense than those near the earth, but nevertheless noticeable.

The receiving wire cut at all points by the magnetic lines of force, is the seat of resultant electro-motive force proportional to the intensity of the field and to the rapidity of the oscillations. The higher the antenna the more lines are cut. With a given length fewer lines are cut as we ascend farther from the earth, but the range seems to be slightly extended, due to a conduction effect.

And, for the time that was a pretty good working hypothesis.

In the early work transmitting antennas and receiving antennas were much alike in construction, both of them of temporary appearance. A time was to arrive when they would differ considerably. Indeed, away off in the future there were to be receivers which would be so sensitive as to require no outdoor, elevated antennas. But transmitting antennas were destined to expand in bulk and to be of more intricate construction. In the course of time the Gargantuan towers which support transmitting antennas were to extend aloft to heights not far short of that of the botanical prodigy made famous by Miss Gracie Fields in her favorite music-hall song.

However, resuming the narrative at a point where difficulties incident to dependable transmission were presented, it was natural that as the transmitting devices were studied with a view to increasing signaling range and to bringing about selectivity attention should be given also to antenna design and construction.

Directional Studies

The gain in distance by employing an elevated, vertical antenna associated with an earth connection was so encouraging that from 1897 until 1899 this method of transmission prevailed. Thought then began to turn toward possible *directive*, if not *selective*, advantages by employing antennas not vertical in all their elements. Attempts were made to send out directed waves by depending upon an anticipated interference of waves from two antennas located a half wave length apart.¹

In England in 1901, J. Erskine Murray carried out experiments with variations in antenna design, which perhaps would have anticipated results obtained by later workers had he been in a position to follow through to success. It had been noted that a directive effect followed when a sending antenna was suspended in a horizontal or an inclined position, thus departing from the single vertical conductor. With the horizontal antenna it was said that radiation took place through a small, solid angle; direction of radiation being altered by changing the direction of the antenna. And now if we jump across the Atlantic to America we may take note of what was afoot here with respect to antenna design, at the beginning of the century.

In the year 1896, when Marconi was demonstrating his first crude apparatus to the telegraph authorities in England, there was in America a twenty-three-year-old descendant of John Alden, who had a Ph.D. degree in view

¹ S. G. Brown, British patent 14,449 (1899); John Stone Stone, United States patent 767,970, filed June, 1901; John Stone Stone, United States patent 716,955, filed January, 1901.

at Yale University. This young man, Lee de Forest, was destined to play a large part in the extension of wireless signaling to utilitarian purposes. We shall have more to say about Lee de Forest when we come to consideration of the wonderworking vacuum tube—de Forest's Audion. But six or seven years before the tube appeared, de Forest



JOHN STONE STONE

was experimenting with the transmitters and receivers of the time.

From what has been recorded here relating to the introduction and growth of space telegraphy it may be realized that in the year 1900, four years after the first faltering steps had been taken, the art was in that formative stage properly designated as its infancy. Dr. de Forest then began an attack upon the problems presented. Speculation, hypothesis, opinion, and cut-and-try were the agencies out of which success was to come. Employed in Chicago at

the time, de Forest had as associates Edwin H. Smythe and Clarence E. Freeman, and what was perhaps the first description of the wireless telegraph instruments devised by these experimenters appeared in the journal *Western Electrician*, July, 1901. This was less than two months after Marconi had taken out his first American patent.

The first noteworthy demonstration of the assembled instruments outside the laboratory was when signals were transmitted from a shore station on Lake Michigan to a station on a yacht offshore, when a signaling range of five miles was attained. In the summer of 1901, de Forest journeyed to New York, and soon the De Forest Wireless Telegraph Company, of New Jersey, was organized. As the purpose here is not to trace the tortuous financial fortunes of companies organized to promote wireless, but rather to trace the experimental rise of the science, references are to the technical contributions made from time to time—the bricks and mortar with which the edifice of radio was erected.

In 1901, de Forest proposed the use of an antenna system made up of a relatively short vertical arm, continuing in a horizontal section to a second vertical arm. In patents applied for by de Forest, in May, 1904, he described a method of determining direction of transmission. This contemplated the use of a grid of vertical wires, supported so that it might be rotated on its vertical axis. In a receiving system the strongest signals were picked up when the plane of the gridlike structure was at right angles to the direction from which the signals came.

De Forest found that by employing a grid 15 by 6 feet as an antenna and rotating this until maximum strength of signal was observed it was possible, within limits, to determine the direction of transmission. The student of wireless will recognize in these measures the beginning of developments that were to bring new and varied uses for signaling. On this important subject many bright minds were at work. Noteworthy proposals were made by Ales-

sandro Artom, in Italy; André Blondel, in France; Ferdinand Braun, in Germany; G. W. Pickard and John Stone Stone,² in America. To Artom, perhaps first is due no little credit for stating underlying principles of the direction finder, widely used in various services in later years.

Stone was, in 1904, granted some forty patents, the spe-



GREENLEAF WHITTIER PICKARD

cifications of which treated chiefly of resonant and coresonant systems. The descriptions did not disclose key inventions in wireless, but presented numerous combinations of open- and closed-circuit oscillators and resonators, which brought within the realm of practicability much of the thought and experimentation of the previous four years bearing on directive signaling, selectivity, and increase in distance.

² United States patent 716,134 (1901).

At the International Electrical Congress, St. Louis, Missouri, September, 1904, Stone presented an informative paper on the subject "The Theory of Wireless Telegraphy," which was one of the earliest American expositions of the science of wireless signaling. In fact, this paper, with one presented a year later,³ contained the most complete mathematical treatment of the subject made available to American physicists and experimenters.

As we are here dealing with the growth of ideas relating to wave transmission, reference should be made to Stone's proposal in 1904, to employ a radiating circuit extending from an earth connection, through the secondary of an oscillation transformer and by way of a short vertical lead, to a large metallic plate mounted parallel with the earth. He proposed that the plate should preferably be circular, with its diameter measurement great, compared to its distance from the ground.

The method was an elaboration of Lodge's proposal of seven years earlier. It was a refinement because of the clearly worked-out reasons for shape and dimensions of the metal plate, and distance above the earth at which it should be mounted. From the start, however, it was regarded as introducing mechanical trouble to employ metal plates, and when it was learned that the same ends would be served by employing grids of wires (counterpoise systems), and more satisfactorily, the employment of elevated plates was neither extensive nor long continued.

In England, in 1904, Dudell and Taylor investigated the properties of antennas designed to have relatively short vertical sections—that commonly known as the inverted L type. From the published results of those tests it appeared that marked directive properties were not observed.

A year later Marconi, in a patent application and in a lecture at the Royal Society of Arts, treated of the directional effects of the horizontal-type antenna both for trans-

³ Read before the Electrical Section, Canadian Society of Civil Engineers, Montreal, Canada, Mar. 9, 1905.

mitting and for receiving. At that time and later there was considerable controversy relative to the directive properties of antennas of this type. T. L. Eckersley, in England, held that the directive effect of an inverted L antenna "is of very small amount," while J. A. Fleming stated that "any bent oscillator, however arranged, has no asymmetry of radiation for very large distances."

But a few years later Professor Fleming declared that such a directional antenna "is now generally employed in long-distance, high-power stations intended to communicate with corresponding stations at a distance," and that it radiated most strongly in its own plane and away from its open end.

In the 1905 specification Marconi had stated that, while antennas of this type are preferably grounded at one end only, "they may be attached to ground at their far ends, or at other points, and inductance and capacity may be inserted in these earth connections." It is of interest to note that the above paragraph was prophetic of the multiple-tuned antenna system attributed to E. F. W. Alexanderson,⁴ in America, erected at large transoceanic stations of the Radio Corporation of America about fifteen years later.

In later years, C. S. Franklin,⁵ in England, stated that "when correctly adjusted as regards phase" such an antenna radiates most strongly in a direction at right angle to its length; which view differed from that originally held by Marconi and Fleming. In his 1905 work, Marconi, as related in his Royal Society lecture just referred to, had observed that the most advantageous length of the horizontal wires, in order to obtain good results at a maximum

⁴The multiple-tuned antenna is an arrangement for using a number of ground connections in parallel to secure a low ground resistance. In its general form it consists of a long flat-top antenna having a number of downleads attached at approximately equal intervals along its length, each downlead being connected through a tuning inductance of suitable value for the wave length employed.

⁵*Journal, A.I.E.E.*, August, 1922.

distance, was about one-fifth of the length of the transmitted wave, when the wires were placed at a distance above the earth, but the receiving wires should be shorter if placed on the ground.

Marconi's reference to maximum effect when horizontal antenna is one-fifth the length of the incoming waves is of interest in view of the contrasting work of H. H. Beverage, Chester W. Rice, and E. W. Kellogg, in America, about sixteen years later. Following the latter investigation, receiving antennas came into use for transoceanic long-wave service, which were of the order of one wave length, roughly about nine miles long. These antennas were set up parallel with the direction of propagation of the signals. After Marconi's work in 1905 on horizontal antennas, the subject was taken up in an analytical manner in several countries.

For a moment we might look at the important contributions made by Alessandro Artom, in Italy, whose researches and experiments were carried out at the Royal Industrial Museum, Turin. His results were published in a paper communicated to the Royal Academy of Lincei, Italy, entitled "A New System of Wireless Telegraphy." This was in 1904. It was Artom's idea that the principle of the rotating magnetic field which had sprung from optics might find a logical application in corresponding phenomena produced by electric oscillations. Such a class of circularly and elliptically polarized rays of electric energy, he reasoned, should be present in a determinate direction as the properties of the electric and magnetic rotating fields.

In Germany, ten years previously, Zehnder⁶ had demonstrated certain characteristics of elliptically polarized waves by employing two plane-polarizing grids consisting of a number of parallel wires fastened to a frame, placing the grids parallel with each other a short distance apart, with their wires crossed. When the two grids are mounted closely together they act as a wire gauze, reflecting polar-

⁶ *Berichte der Naturforschenden Gessellschaft*, June 21 and Sept. 2, 1894.

ized radiation, but when the crossing wires of the grid are an eighth of a wave length apart and the plane of the incident radiation is at 45 degrees to the wires the reflected radiation will be circularly polarized. Further, a change in their positions will make it elliptical.

The production of circularly and elliptically polarized waves by reflection from metallic grids, in the year 1894, must have been, to say the least, an interesting laboratory demonstration. That was six years after Hertz, but two years before Marconi. When Artom revived the subject in 1903 he was provided with facilities by the Italian naval authorities to investigate the predicted properties of these waves, as to the disymmetry of the electromagnetic field produced. His method of producing circularly or elliptically polarized waves consisted in causing disruptive discharges between a plurality of discharge gaps arranged at the vertices of a triangle, the current supplied to the gap terminals differing in phase; the disruptive discharges differing also in direction due to the angular position of the gaps.

The advantage sought in this method was to send out radiation from a transmitting station in a compact cone in, or nearly, a single direction, normal to the plane of the discharge terminals and to the plane of the antenna, both planes being parallel with each other. Artom's tests of 1903 and 1904 indicated that the system had definite advantages in the way of selective signaling.

Somewhat later, Artom's inventions were taken in hand by his compatriots Ettore Bellini and Alessandro Tosi, and carried forward to a state of general practicability. These investigators developed an ingenious system of directive wireless signaling which had various special and useful applications. In the form patented in 1907,⁷ the antenna consisted of two equilateral triangles of wire, open a short distance at the top, and around a central vertical wire. At the middle point of the base of each triangle was connected

⁷ United States patents 943,960 and 945,440.

in series, the secondary winding of a transformer, the two secondaries mounted to form a rectangular cross. A single primary winding for both secondaries was mounted in a parallel plane, pivoted at its mid-point immediately below the crossed secondaries. In one arrangement the primary was in series with the spark gap and the vertical wire of the antenna system, the other terminal of the gap being earthed. There were variations of this hookup, one of

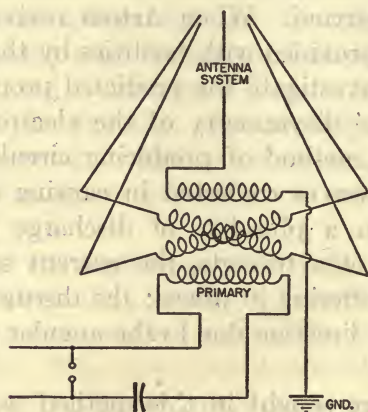

FIG. 7.—One form of the Bellini-Tosi directive antenna.

which is shown in Figure 7. To transmit in a desired direction the primary was rotated to point in that direction. The oscillations in the secondaries divided into components in accordance with the parallelogram law, the triangular elements of the antenna being excited accordingly and the maximum of radiation being in the direction in which the primary pointed.

Oddly, for seventeen or eighteen years little was done to investigate the possibilities of Zehnder's and Artom's findings with reference to circularly and elliptically polarized waves. It was not until the pressing problems of short-wave signaling were presented, or once more pre-

sented, that Pickard and Alexanderson, in America (1925, 1926), directed attention to the subject.

"Static" Reduction

G. W. Pickard, as early as the year 1900, studied the vagaries of the "atmospherics" which then plagued wireless receivers (and which still plague listeners-in at times) and later carried out a series of searching inquiries into the nature of the phenomena. In 1906, Pickard filed a patent application (United States patent 842,910) covering the invention of an aperiodic shield, or cage, to be erected around the operating antenna, and so designed as to permit the passage through it of signaling waves but to shut out all or part of any "static" impulses arriving at the station. A similar arrangement was described in Germany, in 1912, by M. Dieckmann, which became known as the Dieckmann cage.

There was so much that was unknown. There were so many things to try. It will be remembered that Hertz's original ring, or loop, antenna was employed in the earliest demonstrations of space signaling, the distances covered being quite short. With the introduction of the earthed antenna in 1897, ungrounded loops were laid aside (to be resurrected many years later when powerful transmitters and sensitive receivers became available). For special services, such as "direction finding," loops came into use again during World War I.

In the attack upon the problem of static elimination the possibilities of loop antennas occurred to wireless workers soon after message service was undertaken. Static effects in the headphones used by wireless telegraphers caused false signals, with consequent mutilation of the words transmitted. In 1905, Pickard worked out ideas covering the design of double-loop antennas, as covered by his patent application of September 3, 1907 (No. 956,165). In the same year Pickard filed a patent application covering a

combination loop and open antenna, in principle similar to the Bellini-Tosi arrangement brought out a little later.

Ground versus Counterpoise

A variation in station radiation systems that early engaged the thought of engineers was that of substituting a counterpoise, or earth screen, for the actual ground contact introduced by Marconi. John Stone Stone, in America, Braun and Zenneck, in Germany, and others developed the theory of the counterpoise, which consisted of a large flat conducting surface placed horizontally immediately above the earth's surface. Its purpose was to act as the opposite of the elevated antenna, and consisted of a system of suspended wires instead of a plate.

In 1903 and 1904 the German school of thought, following the suggestions of Count Arco, was strongly inclined toward the employment of suitable counterpoises instead of positive earth connections. It is to be remembered that the elements which label the first wireless telegraph system as Marconian are the elevated antenna and the earth connection. It was Arco's conviction⁸ that it would be impossible to convert large amounts of energy into electric waves by directly earthing one side of the system, as was Marconi's practice. So far as the study had progressed at that time Arco maintained that the capacity of the antenna was limited and an increase of energy could be had only by augmenting the charging current.

Several of the large stations erected in various parts of the world by Germany were equipped with extensive counterpoise systems. At the famous—or infamous—station erected at Sayville, Long Island, prior to World War I, the counterpoise system consisted of a radial screen of wires suspended on posts about twenty feet in height and extending out some distance from the antenna base.

British and American engineers were inclined rather to have faith in positive grounding systems for long-distance

⁸ *Electrical World and Engineer*, July 22, 1905.

operation. J. A. Fleming, in England, stated that all practical experience shows that to produce telegraphic effects at a great distance, the lower ends of the radiating and receiving antennas must be conductively connected to the earth, or what is equivalent, must be connected to earth through a condenser of large capacity; currents must flow into and out of the earth in the neighborhood of the antenna."

Fleming distinguished between two forms of indirect earthing, one in which is employed a single wire, plate, sphere, or other capacity horizontal to the surface of the earth and the other a condenser of large capacity, one side of which is connected to the antenna coupling and the other to the earth by means of a regulation grounding plate or other surface.

And so theory proceeded to march along with results observed in actual practice; theory at times in step with practice and again ahead or behind, but ever aiding and guiding to the end that someday practice should embody applications and procedures founded on sound reasoning, adjusted from time to time to accord with further discoveries.

Spark Gaps and Oscillators

The oscillator employed by Hertz in 1888 consisted of a pair of metal spheres connected across the terminals of the secondary circuit of the induction coil. A variation of the arrangement included an additional, and larger, sphere or plate directly connected to each of the knobs of the spark gap. In 1889-1890, Lodge experimented with oscillator devices similar to those used by Hertz. In his 1894 lecture on the work of Hertz, Lodge exhibited a form of radiator which consisted of a spark-gap arrangement made up of a very large central sphere situated midway between smaller terminal spheres. Augusto Righi, in Italy, later improved this assembly by mounting the spheres in a container made of insulating material and filled with oil. Thus it may be realized that the Hertz and Righi oscillators were quite simple contrivances, and it was with these that Marconi carried on his early experiments.

As previously related, those who experimented with induction coils and oscillators throughout the years 1888-1895 appear to have had no suspicion that the radiated energy would be effective at distances beyond a few yards. In 1894, Lodge mentioned a possible range of one-half mile, employing as the detector the early form of filings tube, but up to that time his experience had been with distances of forty to sixty yards. Marconi and Popoff had the daring to cajole electric waves in space to disclose their presence at distances from the oscillator far in excess of the ranges previously thought of by others.

In small installations the spark gaps employed usually comprised but two metal knobs, of copper, brass, or zinc. The adjustment of the knobs as to distance apart while in use was somewhat critical. With the knobs far apart

the resistance of the gap might be too great, causing excessive damping. When the sparking distance was too short, arcing took place, which was simply a direct discharge that did not produce effective electric oscillations. Also, when the knobs were adjusted too close together there was likelihood of the associated condenser discharging across the gap before the condenser charge had reached maximum, resulting in weak oscillations.

Early in the work it was learned that the best results were obtained when the spark was of a "bright," crackling nature. With such sparks passing across the gap, oscillations were produced which set up electric wave radiation, the oscillations expending their energy in creating a state of alternate electric strain and magnetic flux—the fountain-head of electric waves. It was understood that in wave form the energy was conveyed away from the oscillator into the surrounding medium, progressing outward with the supposed velocity of light.

A Dependable Spark Gap Sought

It may well be realized that with the spark gap the seat of the oscillations, innumerable investigations were launched with a view to devising a type of gap which would be efficient as a radiator of wave energy, regular in operation and free from mechanical defects. Along this line of effort a noteworthy step was taken by R. A. Fessenden, in 1901,¹ when he proposed a form of gap between sparking terminals enclosed by insulating material and subjected to a critical air pressure.

With simple, open gaps, Fessenden believed there should be an oscillation energy gain proportional to the length of the spark up to one inch of length, beyond which gap separation there would be no increase in radiation. He devised a gap one terminal of which was a metal rod of small diameter, the other a metal plate or disk. The terminals were sealed into a chamber in which the air pressure could

¹ United States patent 706,741, filed November 5, 1901.

be raised to, say, 80 pounds per square inch. With this arrangement Fessenden stated that radiation and spark length were proportional, thus permitting of increased radiation by extending the gap separation considerably beyond one inch. Obviously, as the gap separation was increased it became necessary to enlarge the condenser capacity associated with the gap and to maintain a correspondingly higher secondary potential.

The general introduction of arc lighting about the year 1888 was due to the development of alternating-current generators and transformers, and although for lighting purposes low-voltage direct-current and incandescent lamps largely replaced arcs for interior lighting, alternating currents associated with step-up transformers were destined to have wide application in industry. As early as 1894 transformers were built having secondary outputs of 10,000 volts, and by the year 1900 transformers were made, operating on 60 cycles, having outputs of 210,000 volts. From the early days of wireless, workers looked longingly at the transformers as a substitute for the spark coil.

Lee de Forest, in America, in 1902 and 1903, employing an alternating-current generator, step-up transformer, and condenser, used a spark gap with a third metallic element situated between the two terminal knobs, similar to the Lodge oscillator of an earlier date. De Forest, however, employed disks of metal about one-fourth inch in thickness, the diameter of the disks also being one-fourth inch. The efficacy of a "short, fat spark" for dependable telegraph signaling over the distances at that time attempted had been noted by several workers, especially by amateur experimenters in America. In the de Forest gap the separation between the terminal disks and the central disk was in each case $\frac{1}{64}$ inch. The transformer could be employed wherever primary alternating current was available, either directly or by means of converters. But the problem of the spark gap still remained, and as that was the seat of the

oscillations it was subjected to continuous study and experimentation.

In Germany, in 1906, Max Wien introduced a form of discharger subsequently referred to as a "quenched spark gap." Pretty much the same device had been invented in America six years previously by T. B. Kinraide,² but it did not at the time attract wide attention or have considerable use.

As observed by de Forest and others, it was early apparent that there was a particular length of spark gap which would have the smallest damping and consequently the greatest integral effect. This gap, in air, was found to be quite small; of the order of one millimeter. Wien noted that with a very short gap consisting of two smooth plates of good conducting metal, their surfaces parallel, the spark was rapidly extinguished (quenched) due to the cooling effect of the metal surfaces, the condenser discharge then consisting of but one or two oscillations. With the primary discharge circuit coupled to a secondary, the transfer of energy to the latter resulted in many oscillations of one period only. The Wien gap was made up of seven or more copper plates in series, separated by mica rings. Modifications of this form of gap were used by von Lepel and Peukert, in Germany, and by Fleming, in England. Lepel used a paper ring to separate two water-cooled flat, or conical, surfaces. Peukert provided a thin film of oil between two rotating metal surfaces.

The employment of the quenched-spark arrangement provided that the sparks follow each other so regularly as to give out a clear musical tone, often called the "singing spark." The quenched-spark oscillator came into use at a time when an improvement of this order was greatly needed.

Although it had been a simple matter to calculate inductance and capacity values which, incorporated as elements of transmitting and receiving circuits, should make

² United States patent 623,316 (1899).

possible selective signaling, in practice it was common experience that the tuning accomplished was not within narrow limits of frequency. With the quenched gap distinctive tones could be given to individual transmitters. At once this was recognized as an advantage in operating several stations in a common territory. Until such time as accurate tuning systems could be developed, if undesired signals could not be kept out of a particular receiving circuit, early workers viewed the situation as not impossible when the interfering signals were of a different tone.

The Disk Discharger

In Marconi operations in 1905, a gap was used, known as the Fleming-Marconi gap. It consisted of two balls or disks of iron or steel, mounted on separate shafts driven by motors. The shafts carrying the spheres were revolved at a slow rate by means of gears. Motors, gears, and spheres were mounted in a closed chamber in which air or other gas could be compressed. Thus, the discharge was practically noiseless, which, in the interest of peace and quiet, was a welcomed improvement over the noisy, open gaps.

Two years later, the Marconi workers introduced a disk discharger by means of which the persistency of oscillation was made to approach in regularity that of the arc system, or other generator of continuous waves. It consisted of a metal disk having copper studs firmly fixed at regular intervals on its periphery, and placed transversely to its plane. The disk was caused to rotate very rapidly between two other disks, by means of a motor or turbine. The side disks also rotated in a plane at right angle to that of the middle disk. The studs were of such length as to just touch the side disks in passing, thereby bridging the gap. For large installations this discharger proved efficacious. At the Marconi Clifden transatlantic station, where a frequency of 45,000 with a potential of 15,000 volts across the condenser was used, the spark gap, of the type here men-

tioned, was practically closed during the time of one oscillation when the peripheral speed of the disk was 600 feet per second.

The result was that the primary circuit continued to oscillate without material loss due to resistance of the gap. The number of oscillations taking place was governed by the thickness of the side disks, the primary being abruptly opened as the studs on the middle disk departed from the

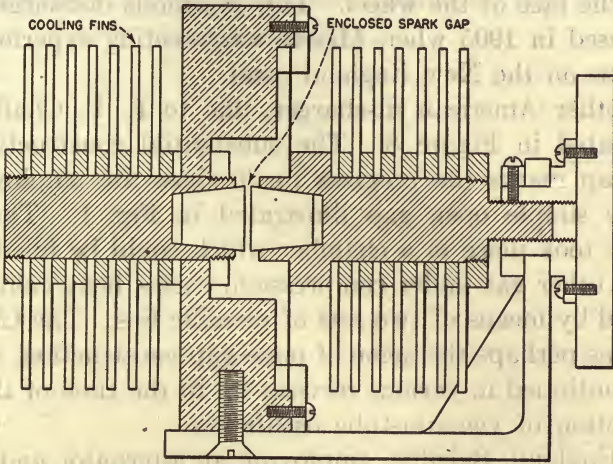

FIG. 8.—Cross section of the Chaffee spark gap.

side disks. The sudden rupture of the primary circuit served to quench any oscillations which continued in the condenser circuit.

Other Dischargers

At the time this excellent discharger was introduced, several years had to come and go before the oscillating properties of de Forest's audion were to dazzle the minds of wireless workers, and additional years had to pass before the vacuum tube was to be applied practically as an oscillator for transmission. In the interim, although continuous-current arc transmitters and high-frequency alternators

were to have somewhat extensive use, improvement of the "gap" for spark transmitters continued to be an absorbing subject.

In America, Walter W. Massie developed a form of gap consisting of a hollow wheel slotted on its face and revolved between two terminal electrodes by means of a motor. To control the temperature of the gap elements, air was drawn inside the wheel by a fan connected to the shaft, similar to blower devices; the air being forced out through the slots onto the face of the wheel. This ingenious discharger was first used in 1905 when Massie was erecting experimental stations on the New England coast.

Another American discharger, due to E. L. Chaffee, is illustrated in Figure 8. The substantial construction of this gap marks the progress made since the employment of the simple open gap illustrated in Fig. 1. The discharge took place in a chamber which could be filled with air or other gas under compression, excess heat being dissipated by means of two sets of metallic fins. The Chaffee gap was perhaps the acme of open-gap construction, and it was continued in various services up to the time of the introduction of vacuum-tube oscillators.

In England, Balsillie, employing an alternator and step-up transformer, in 1909 had in use a form of rotary spark gap so constructed that, when rotated, a considerable air pressure was produced at the opposite electrodes when they were in closest proximity to each other. By regulating the speed of the rotating member the discharge from the condenser could be interrupted from 300 to 1,500 times per second. The gap comprised two outside electrodes, each $4\frac{1}{2}$ inches wide on the sparking edge, placed in close proximity to a longitudinally toothed wheel. The wheel, five inches long, had truncated teeth cut in its periphery, the design providing for from twenty to thirty sparks in parallel for each condenser discharge. Quite small gaps were used; with a 1-kilowatt transmitter, $\frac{1}{64}$ inch, and with a 2-kilowatt transmitter, $\frac{1}{32}$ inch.

This device provided a fairly definite frequency and a musical tone; the note, of course, being independent of the frequency of the alternating current used to charge the condenser.

These chapters so far have in the main dealt with the early systems and devices employed in sending out telegraphic signals by means of electric waves, so called, and in logical sequence it may be proper now to review various of the detectors discovered, invented, improvised, or otherwise acquired by the physicists, engineers, and amateur workers in early wireless signaling.

Development of Electric Wave Detectors

Should we at this stage of our narrative lift the veil to see what the future may have in store in the way of electric wave detectors, we might dismiss or gloss over descriptions of the various ingenious detectors used or experimented with following the introduction of Branly's filings tube in 1891. But that would not serve the demands of history. It would not answer the habitual eagerness for knowledge. In the year 1900 the future appeared as of small interest compared to what was at that period being striven for by innumerable physicists, engineers and experimenters. In all parts of the world, seemingly busy minds were engaged in the search for the nonpareil of Hertzian wave receivers.

During the years when crystal detectors were widely used, it was no uncommon experience for a ship or a shore station radio operator, going off duty, to take away in a vest pocket a prize section of galena, silicon or carborundum, believing that he possessed the most sensitive crystal in all the world. Determined to retain close possession of the prized mineral, the telegrapher thus avoided risk of its being appropriated by a coworker, or its sensitiveness imperiled by maltreatment.

In the annals of science the hunt organized and directed by Thomas A. Edison in the years 1879 and 1880 to discover a suitable bamboo fiber for incandescent lamp filaments, involving various expeditions which scoured the forests and jungles of tropical countries, stands as a record of research, industry, and perseverance. But the search instituted a decade later for the most sensitive material

or substance to place between the metal electrodes of electric wave detectors may well be set up as a monument to the inquiring pioneers who participated thus in the advancement of signaling through space.

In the early "coherers" of the Branly type almost everything was tried from tin to gold and from gelatin to steel. The search for the perfect coherer material early changed into a search for the most sensitive detector of the crystal type; search for the best electrode and electrolyte combination for electrolytic detectors; experimental development of "magnetic" detectors, and so on up to the time of the advent of the three-electrode audion. Even after the arrival of the audion, the crystal type of detector was continued in service for a decade as a competitor of the vacuum tube, for as a simple detector the tube was little, if any, more sensitive than the best crystals.

The Search for the Perfect Detector

In the search for the perfect detector was engaged the energy of a larger number of physicists, experimenters, engineers, and boys in almost every country of the world than had ever before directed attention toward a single objective. The extensiveness of the Crusades for the recovery of the Tomb, the migrations of the oppressed from east to west, even Edison's expeditions and caravans in the tropics in search of elusive fibers, were limited concentrations compared to the world-wide attack upon the wireless detector problem.

In the laboratory, Hertz had detected electric waves in space a short distance away from his induction-coil transmitter, the presence of the received energy being indicated by minute sparks at the slightly separated ends of a split metal ring. Plainly, a detector of this sort required a considerable amount of energy to function. At a distance of a few hundred feet from a transmitter of the usual power, the Hertz resonator (detector) could hardly be expected to give useful indications of intercepted waves.

In the original laboratory apparatus there was little of telegraphic suggestion. As a telegraph possibility distances of a mile or more would have to be bridged.

Coincidentally, and fortunately, a converging line of knowledge was at an opportune time destined to attract the attention of the workers in wireless. This knowledge concerned devices which had been noted to be sensitive to small currents in metallic conductors and to space effects caused by electric sparks in their neighborhood.

It may be recalled that Marconi, and also Popoff, in 1895 had available the filings coherer tube of Branly, introduced five years previously. But long before Branly's time, wave-responsive characteristics of imperfect-contact assemblies had been noted by other inquisitive physicists. Munk, of Rosenschoeld, as early as the year 1835, had described the increase in the electrical conductivity of filings of tin, carbon pieces, and other substances when situated in the neighborhood of a Leyden jar in operation. Munk was said also to have reported that restoration to a state of high resistance was accomplished by shaking or disarranging the loose particles after they had been subjected to the discharge from the condenser. That was so many years before Maxwell's theories were propounded, and Hertz's discovery, that no charge should be laid at Munk's door, of dereliction in not getting to the bottom of the causes of the phenomenon.

The Coherer Appears

There is record that seventeen years after Munk's observation, S. A. Varley, in England, noted that metallic powders presented high resistance to potentials as high as 100 volts, the outcome of which was that Varley invented a form of lightning arrester, in the year 1866. The arrester consisted of two metal terminals between which was deposited a small portion of metallic filings. The device actually worked as a lightning arrester, although neither Varley nor anyone else in his time knew why. Twenty-

two years later Hertz would have explained that flashes of lightning produced electric waves which, arriving at the lightning arrester, caused the filings to cohere, thus shunting the charge to earth by way of a ground rod. Varley employed the arrester to protect instruments at telegraph stations from damage by lightning. Obviously, the arresters had to be shaken, or tapped, following each lightning storm. In 1870, Varley presented a paper before the British Association describing the experiments that led to the development of the arrester, but in the paper there was no hint of the real reason why the filings cohered.

The phenomenon of the fickle filings was impartial in selecting quarters for disclosure. In Italy, in 1885, Calzecchi Onesti observed the variation in electrical resistance of metal filings when subjected to electric discharges. Onesti's experiments appeared to have been extended toward investigating the action of imperfect contact devices when connected in series with the secondary winding of an induction coil, effects being noted when the primary was opened and closed. But this was three years prior to Hertz, and although from the record it would appear that Onesti was being flirted with by the still unrevealed, but whispering, truth later grasped by the German professor, it may be concluded that Onesti's observations, Munk, Varley and Hughes's (the last-named referred to in an earlier chapter) should be viewed as fruit plucked too early, so far as the needs of space signaling were concerned.

It is unlikely that Branly knew of the prior experiences with metal filings, for it was while he was studying medicine that he conceived the principle upon which the coherer was constructed. But what a wealth of suggestion there is in all of this for both tutored and untutored experimenters! Hughes, Munk, Varley and Onesti, all preceded Hertz. Branly followed Hertz. Had Hertz known of the discoveries of his predecessors with regard to pockets of metallic filings, it is hardly probable that he would have for long dallied with metallic, split rings.

A pregnant suggestion contained in these matters is that young men when reading technical papers and books should ever be on the lookout for truths unintentionally partly hidden. Among students, he is brightest who becomes "a snapper-up of trifles."

To continue: In England, in 1889, Lodge¹ noted that two metal knobs sufficiently close together cohered when a spark passed between them. In France, Branly² carried out a somewhat complete investigation into the phenomena of imperfect contact arrangements, announcing the results in 1891. He experimented with metallic films on glass, with rods, with pastes, and with filings. The metallic filings assembly proved to be the most regular in action, and in construction it could be made rugged and simple. At once it became a laboratory instrument of interesting behavior.

In his 1894 lecture on the work of Hertz, Lodge exhibited coherers of the Branly filings type: in fact it was Lodge who gave the device the name "coherer." As a laboratory device the Branly coherer was bandied about the laboratories from 1891 until 1894, being used to demonstrate electric wave phenomena over such distances as were convenient in college rooms. As already pointed out, it was Marconi, in Italy, who first (1895) undertook to investigate the maximum distance over which a coherer would respond to transmitted electric waves of the Hertz type. Marconi was, doubtless, unaware that in February, 1892, Sir William Crookes, in England, in a paper published in the *Fortnightly Review*, in plain words suggested the immediate possibility of wireless telegraph signaling by means of radiation from a Hertz oscillator and the detectors then known. Marconi must be given credit, however, in that having satisfied himself that the thing was practicable, he barged across the Channel into Sir William Crookes's front yard, so to speak, to demonstrate that practicability.

Marconi's astonishing demonstrations of 1896 and 1897

¹ *Journal, I.E.E.*, Vol. XIX, pp. 352-354, 1890.

² *Comptes Rendus*, Vol. CXI, p. 785; Vol. CXII, p. 90.

at once directed attention to the coherer. But if the coherer was to be used as a wave detector that would cause a telegraph instrument to be actuated, it was essential that the filings be immediately restored to the high resistance state at the cessation of each series of oscillations representing the "dot" and "dash" elements of the Morse code. The promptness with which the coherer was made ready for succeeding signals largely determined the speed in letters per minute at which signaling could be carried on.

The "tapping back" process, therefore, was made automatic. Reduction of the resistance of the coherer as a result of arriving waves permitted a local battery to energize the coils of a telegraph relay connected in series with the coherer. The armature of the relay, in turn, through its local circuit, was made to actuate a tapper resembling a vibrating electric bell, the hammer of which knocked against the coherer tube, or its base support, so long as the resistance of the coherer remained at minimum.

A difficulty at once experienced was that the small sparks at the make-and-break contact of the decoherer produced electric effects which disturbed the intended operation of the coherer. Lodge, in 1895, devised a clockwork mechanism arrangement which, operating mechanically, introduced no sparking. And when the amateurs in America began playing with coherers little time elapsed until several ingenious methods of decohering the filings were applied. Harry Shoemaker, in 1901, mounted the coherer in a vertical position, the filings resting in a V-shaped pocket at the lower end. In the filings mixture were both iron and nickel particles. The coherer tube was surrounded by a soft iron sleeve on which was wound a coil of insulated wire, the winding being in series with a local battery and the armature circuit of the receiving relay. With each closure of the armature contact the filings were attracted upward by the electromagnet, and upon cessation of an incoming signal the armature opened, de-energizing the magnet, allow-

ing the filings to drop downward and thus become de-cohered.

Variations of the Coherer

Branly, in France, doubtless was greatly elated that his humble filings tube was being experimented with all over the world. Young Marconi, the Italian, was becoming famous. And, unavoidably perhaps, the nature of the publicity and the reported news was such that on all tongues there was talk about Marconi and his coherer. Then, as if to make up for his seeming neglect of his invention of 1901, Branly began studies out of which came a new detector, in 1902, which was based on the simple contact of a polished and an oxidized surface (Figure 9).

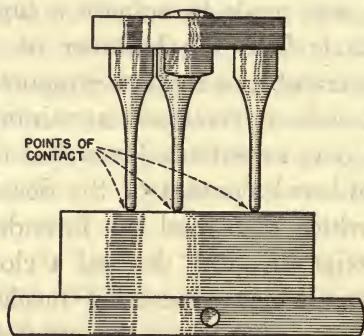

FIG. 9.—Branly tripod detector.

To obtain the contacts of polished and oxidized surfaces, Branly arranged the detector in the form of an upper disk of metal fixed with three rods of tempered steel, tapering and pointed at their ends. The points of the rods were rounded and given a high polish, after which they were given a very thin layer of oxide by heating in air to a suitable temperature. The reason for the three rods was to provide separate contacts, so as to ensure dependable working. The tripod thus formed was placed on a disk of steel, highly polished.

The cohering effect upon the arrival of incoming elec-

tric waves was between the points and the polished surface. When well designed and constructed this device was as sensitive as the filings coherer and had the merit of being more easily and more regularly decohered, a single light tap being effective.

In England, during 1902 and 1903, Oliver Lodge and Alexander Muirhead, co-operating in wireless research, put out an apparatus for space signaling in which the coherer employed consisted of a small steel disk, rotated continuously in contact with a column of mercury. Between the two was interposed a thin film of oil, the disk being revolved by clockwork. The film of oil was the sensitive separating medium, serving the same purpose as the film of oxide in the Branly device. In the Lodge-Muirhead detector, contact established due to arriving waves was automatically disrupted by virtue of the continuously moving electrode, the disk. With this detector a potential difference of one volt was sufficient to break down the resistance of the insulating film. In some experiments this detector was employed to operate a siphon recorder such as that used in submarine cable operation.

And so the busy experimenters continued to experiment and to devise. Tissot, in France, in association with Rochefort, Slaby and Arco, in Germany, Popoff, in Russia, between 1900 and 1903, introduced ingenious variations of the Branly and the Lodge-Muirhead detector. But the coherer in any form was destined to give way to other types of detectors better suited to the needs of practical signaling. At its best the coherer was slow in operation, was given to producing false signals in translating devices employed in connection with it, was not adaptable to refinements in tuning, and in general was a temperamental device, notwithstanding that it was employed from 1894 to 1900, and later, as the most practical means of registering the presence of electric waves. Moreover, as late as 1905, the Slaby-Arco form of coherer was still widely used in German wireless telegraph stations.

The minds of the foremost thinkers of the time turned to the need for a detector that would be a current-operated device; that is, a quantitative rather than a qualitative instrument such as was the coherer. There was experimental inquiry into the possibilities of electrolytic action. Previously, sharp needle points in contact with oxidized surfaces had been tried out, and it was a logical concept to investigate effects produced by electric waves when a metal electrode was placed in contact with an electrolyte.

So, like Hagar's children, the physicists and the tinkers again were away to the realms of speculation. Some of the workers who, about the beginning of the twentieth century, made valuable discoveries were Pupin, de Forest, Fessenden, Vreeland and Stone in America; Neugschwender, Aschkinass and Schloemilch, in Germany; Ferrié, in France. Neugschwender had, in 1898, performed an experiment as follows: The silver-plating on the reverse side of a section of mirror glass was divided into two completely separated parts by means of a razor cut. On the slit a drop of water was deposited, and then an electric circuit was made up consisting of a cell of battery, a telephone receiver, and the two separated sections of silver-plating on the glass. When this arrangement was subjected to the effects of electric waves produced in its neighborhood, it was noted that the resistance of the circuit increased considerably, remaining at or near maximum so long as wave transmission was continued; immediately resuming normal resistance when radiation ceased.

Aschkinass, a year later, noted the same effect, and when his notes were published, Neugschwender again took up the subject, on this occasion examining with a powerful microscope the edges of the silver-plating. It was discovered that an electrolytic action had taken place; minute particles of the silver-plating had been torn away from the anode side of the minute gap by the action of the local battery current.

In America, de Forest and Smythe, in 1899, carried out

identical experiments and out of these came a detector which these workers named a "responder." It consisted of a tube fitted with two metal plugs separated by a space of about $\frac{1}{100}$ of an inch, the gap filled with an electrolyzable viscous mixture of oil or glycerine, water, peroxide of lead, and metal powder.

It was de Forest's belief that the action of the responder was essentially electrolytic in character, current flow from the local battery causing minute particles to be detached from the anode and carried across the electrolyte to the cathode; thus, in effect, causing to be built up across the gap a bridge of conducting particles which quickly lowered the electrical resistance of the gap. In the responder, de Forest facilitated the bridge-building process by immersing the particles of metallic powder in the glycerine and water electrolyte.

One of the most fascinating accounts³ in all research literature is that of how de Forest noted the establishment of the conducting paths across minute gaps—"Tiny ferry-boats, each laden with its little electric charge, unloading its invisible cargo at the opposite electrode"—and the disruption of these conducting paths when subjected to radiation of a transmitter of electric waves.

The Electrolytic Detector

In the fall of that same year, M. I. Pupin read a paper before the American Physical Society describing the principle of electrolytic detectors of electric waves. In one of the arrangements described⁴ one of the elements was very small and the electrolyte employed was nitric acid. It was an odd subject to attract the interest of Pupin at that time. He was deeply immersed in the problems of wave transmission over wire lines, from which, later, important inventions materialized.

³ De Forest, "Electrolytic Receivers in Wireless Telegraphy," International Electrical Congress, St. Louis, Missouri, 1904.

⁴ United States patent 713,045 (April 1, 1898).

Over in Germany, Schloemilch, in 1903, reported the discovery of what he called "polarization cells" in which he employed very small Wollaston wire anodes having gold or platinum cores, silver-plated so that they could be drawn to very fine diameters. When down to a diameter of two or three mils the silver-plating was dissolved away. The employment of a wire of such small diameter closely simulated the conducting path condition existing in the de Forest responder when the minute metallic bridge was built up by electrolytic action.

In America at this period, R. A. Fessenden had the subject of electrolytic detectors in the open basket on his desk. Early in 1903 he introduced a detector which he named the *Barretter*. In it a platinum wire anode reduced to a diameter of 0.00006 inch was used in association with larger terminal wires, in the form of a small loop, and shielded from the air by being sealed in a tube. The name "barretter" was derived from an old French word meaning "exchange," since it was believed to possess the property of exchanging the energy of the received oscillations for a continuous current. The principle of the hot-wire barretter as devised by Fessenden was this: if a wire having a specific heat factor of such value that the latent energy required to raise its temperature to a certain excess above the air is relatively compared with the energy lost by radiation during the time of a signal; then if such a wire is connected in a local battery circuit, when a given amount of current flows through it there will be a corresponding change in the magnitude of the current produced by the local battery. Or, briefly, its action was thermal.

The barretter was liked by experimenters and by wireless telegraphers who had been using some form of coherer, but the extreme delicacy of the minute wire loop was troublesome from an operating standpoint. Often the wire of the loop was disrupted due to excess current. In Fessenden's work the hot-wire device soon gave way to the liquid

barretter, in which a column of liquid was substituted for the platinum wire previously used. A Wollaston wire of three mils diameter was so mounted that one of its ends was immersed in an acid or alkaline solution contained in a small platinum vessel. This detector was patented by Fessenden on May 5, 1903, and his explanation of the theory of its operation was that the effect of incoming electric waves was to decrease the electrical resistance of the path through the detector, from bare point to platinum container, since the temperature coefficients of liquids is generally negative, and as the resistance is decreased instead of being increased, the signal effect was primary as distinguished from secondary.

From its inception the bare-point electrolytic detector held allure for the investigators and for the telegraphers. Here was a detector of electric waves possessing all the worth-while traits of the best of the previously used imperfect contact coherers, and none of their eccentricities. In itself it was silent. It was automatic. It required no external decohering accessory and from the scientist's viewpoint was a beautiful device. There is little to wonder at that numerous bright minds had been at work on the idea, and less wonder that there followed seemingly unending controversy as to the priority of invention.

The wireless historian's intuition leads him to make special note of those forward steps around which raged dispute as to principles of operation and as to priority of discovery. Writers of political history are, doubtless, due to this same consideration, guided unerringly to turning points and to key situations.

The German savants whose work has been referred to undoubtedly were on the right track, but judging from the records it is not apparent that they soon enough carried their investigations far enough. The same may be said about the work of Blondel and Ferrié, in France—with respect to this form of detector. On the European continent, possibly due to a professional gulf between the

college savants and the workers engaged in practical applications, there was lost motion: lost opportunity. In America, in 1903, de Forest and Fessenden, independently, were delving into this very subject, and at the same time both were actively engaged in promoting wireless telegraph service. Research and engineering practice were on the same bench, which largely accounted for the immediate, wide use of the electrolytic detector after its introduction. In 1903, also, F. K. Vreeland, in America, contributed constructive ideas with respect to the design and construction of practical electrolytic detectors.

It is an enlightening commentary on the existing facilities for physical exploration available to the wireless workers of 1903 and to the processes of reasoning that prompt scientific workers to form definite conclusions, when we examine the views expounded at that time bearing on the principle of operation of the electrolytic detector. Pre-science being a gift denied most mortals, the workers of 1903 could not know that the simple, rugged crystal detector, and the wonderworking audion, as detectors, were but three years away. The electrolytic detector was then an instrument at hand, a wireless accessory more sensitive than the devices previously used for the same purpose. With the introduction of de Forest's responder and Fessenden's electrolytic detector, debate continued as to the principle of operation when under the influence of electric waves.

De Forest held that the device was electrolytic in nature. Fessenden appears to have had the conviction that it operated by virtue of heat generated in the electrolyte immediately surrounding the immersed portion of the fine wire when Hertz waves were passing. Schloemilch⁵ was in doubt as to whether it operated by virtue of its polarization capacity or of its ohmic resistance. M. Reich,⁶ in Germany, believed that it acted by the polarization of the

⁵ *Electrical World and Engineer*, Dec. 10, 1904.

⁶ *Ibid.*

small surface of the immersed portion of the fine wire anode, and his opinion was shared, on both theoretical and experimental grounds, by M. Dieckmann,⁷ in Germany. Vreeland stated his belief that the action was electrolytic, dependent upon polarization.

You might wonder why they were unable to make up their minds. But that is the nature of the true physicist. What someone else believes means nothing to him. He is satisfied only with the conviction that comes to him through his own reasoning.

The controversy as to the principle upon which the electrolytic detector operated attracted the attention of numerous bright minds. Inquiries glided on like the rivers that water the valleys. In America, late in 1904, Dr. J. E. Ives launched a series of experiments with a view to determining precisely the nature of the action. In these examinations Ives was aided by G. W. Pickard, then twenty-seven years of age, who since the age of twenty-one had been engaged in the study of wireless.

The Ives investigation was stated to have shown that the detector was electrolytic in action, and not a heat-operated device; its operation depending upon the polarization by electrolysis of that portion of the surface of the fine platinum wire in contact with the electrolyte. The ability of the device to respond to Hertz radiation was explained by Ives as resulting from an electromotive force generated in the antenna by electric waves, the voltage causing a partial breaking down of the polarization layer enveloping the fine point, thus reducing the resistance of the local circuit in which the translating device (telephone receiver) was connected. Pickard carried out an independent series of experiments and it was stated by Ives that Pickard's results were in accord with his own findings.

The electrolytic detector was used by Fessenden as late as 1908 and 1909, in his experiments in wireless telephony. The present writer recalls using one of them on shipboard in the Pacific late in 1909.

⁷ *Ibid.*

Improvements in Detectors

In the early wireless transmitters the amount of energy radiated was small, with the result that in receiving antenna systems the energy intercepted was infinitesimal. So small, in fact, that the possibility of using electro-magnetically operated receivers, of the wire telegraph type, was thought to be impracticable. The idea was not, however, overlooked that a way might be found to utilize the active field created around a coiled portion of the receiving antenna to operate a signaling instrument directly.

Fessenden and Samuel M. Kintner, in America, in 1899, experimented with galvanometer-type receiving instruments, and in one arrangement the two series field coils of a mirror galvanometer were connected directly in the receiving antenna, the moving element being a suspended ring, mounted at an angle of 45 degrees to the plane of the two field coils. For the small actuating current available the system was not promising, mainly owing to the fact that the current in the ring was in nearly 90-degree phase relation with the magnetic field producing it, with consequent small torque.

Kintner later extended the experiments in an attempt to devise a receiver having a rotary field. The two-phase currents were obtained by spacing two vertical antennas one-quarter wave length apart, each antenna connected to two field coils in series, surrounding the movable element of the galvanometer. This was an early attempt to apply wire-line engineering to the problems of wireless.

In the year in which Marconi first demonstrated his system in England, Ernest Rutherford appears to have been skeptical of the operating dependability of the filings coherer then used. As occurred in later years to Fessenden

and Kintner in America, Rutherford entertained the thought that there must be other possible means of translating the received impulses into intelligible signals. He devised an electromagnetic receiver with which he claimed to have picked up wireless signals at a distance of one-half mile, but it proved to be too slow in operation and its use was abandoned in favor of the coherer.

Magnetic Detectors

Six years later (1902), Marconi introduced a form of magnetic detector¹ which from the start proved to be dependable, being widely used in Marconi stations throughout the following five or six years (see Figure 10).

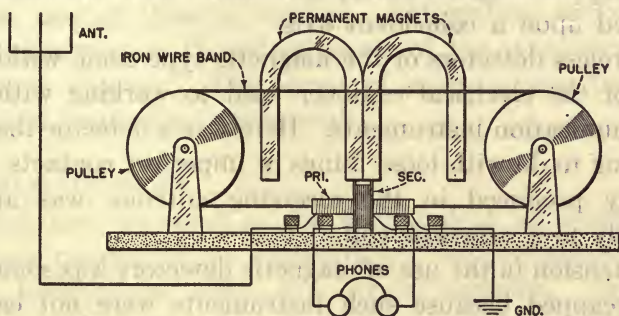

FIG. 10.—General construction of Marconi's magnetic detector.

This detector consisted of a band of fine iron wires, magnetized by being passed through a magnetic field produced by a pair of permanent magnets. The moving, magnetized band passed through the core space of a primary coil, the secondary winding being connected to a telephone receiver. The primary winding was connected in series with the antenna and earth. It may be recognized that the arrangement was simply that of a miniature transformer, except that the core moved continuously, lengthwise,

¹ United States patents 884,986; 884,987; 884,988; 884,989.

through the primary coil, the core magnetized by the permanent magnets.

Antenna current due to the incoming electric waves passed through the primary winding and, as at each dot and dash the magnetic conditions of the windings were altered, the telephone receiver reproduced the signals picked up by the antenna. Employing this form of detector, Marconi picked up signals at a distance of 500 miles in the daytime and 1,600 miles at night.

The scene shifts to America, where we find that in 1903 Lee de Forest² had ready for service a magnetic detector consisting of a number of cores disposed about a common axis, separate coils for the cores being connected in series. Permanent magnets closely associated with the coils were rotated upon a coincident axis.

Wireless detectors of the magnetic type came within the ken of the electrical engineer used to working with wire communication instruments. Here was a detector that had nothing to do with loose filings or imperfect contacts. The energy produced in the receiving antenna was applied directly to a magnetic coil.

Extension in the use of magnetic detectors was somewhat handicapped because such instruments were not easy to construct. Their assembly was a task for professional mechanics. And in wireless progress through the early years the physicists and the company promoters had the invaluable aid of a host of amateurs, mostly boys, the world over whose experimenting and tinkering with all sorts of makeshift apparatus, under all conditions of climate, weather, and atmospheric obliquities yielded important results.

So, in the main, magnetic detectors had to make their own way in the service of the organized wireless companies. In England, in 1905, Ewing and Walter introduced a form of magnetic detector in which two small continuous-current magneto machines with shuttle-wound armatures were con-

² United States patent 887,069.

nected with their voltages in opposition, so adjusted that normally no current flowed in the terminal circuit. The core of the armature, instead of being made up of the usual laminations, was formed of a coil of iron wires the ends of which were brought out and connected to the receiving circuit. The antenna current, therefore, affected the core, producing the effect of increasing its permeability. Hence the winding of that armature revolved in a stronger field, generating a higher voltage, upsetting the electrical balance of the system, the output being in the nature of a direct current capable of actuating a galvanometer, a sensitive relay, or a telephone receiver. The device was, perhaps, based on Ewing's hysteresis tester, which had been used to measure the drag between the field and the iron, when one of these is moving. Integration undoubtedly played a part in the effectiveness of the instrument as a wireless detector. The speed of rotation was from five to eight revolutions per second.

Crystal Detectors

And now we come to the nonpareil of all wireless detectors, beloved of the amateurs and the professional wireless telegraphers alike—the crystal detector. The boys could make them out of the junk obtained from old alarm clocks, discarded fishing tackle, or superannuated door fasteners. Ingenuity was rampant, uniformity in design was scorned, but it was through the medium of these detectors that the conquest of space really got under way.

Somewhat as the Dumbarton Oaks, Bretton Woods, Quebec, and Teheran conclaves mark the end of one international era and the beginning of another, the International Electrical Congress held at St. Louis, Missouri, in the year 1904 turned out to be a general recapitulation of scientific progress up to that time, also a presentation of new ideas for development in the years ahead. At this gathering scientists from all progressive countries presented original papers recounting accomplishments or discussed new prob-

lems for attack which would occupy the minds of ambitious physicists and engineers thenceforth.

By the year 1904 considerable progress had been made in wireless signaling. A year previously, at Berlin, a protocol was signed by Germany, Austria, Spain, Hungary, France, Italy, Russia, Great Britain, and the United States dealing with the handling of traffic between shore stations and ships. Again, in Berlin, on November 3, 1906, twenty-seven nations signed the articles of the International Wireless Telegraph Convention. Actually this was the final draft of the 1903 protocol. The Germans managed to have the word "radio" substituted for "wireless" in the articles of this convention, but it was many years before the term "radio" became current in other countries; in fact, not until the arrival of broadcasting. In America the operating companies were "wireless" companies until 1918, and in Great Britain the term "wireless" is still in use.

At the St. Louis Electrical Congress of 1904 the papers presented by Lee de Forest, J. A. Fleming, John Stone Stone, and others contained the last word of accomplishment to that time. Stone's paper dealt with wireless theories, de Forest's with electrolytic detectors, and Fleming's dealt with the "Present State of Wireless Telegraphy."

In view of the steep rise in the extension of wireless signaling for practical purposes which followed the introduction of the electrolytic and the crystal detectors, it is of interest to take note of the state of the art at the time of the St. Louis Conference. About that time Fleming undertook in his writings to popularize the word "kumascript" as a name for any form of detector of Hertzian waves, but the idea was not received favorably in other countries and, as a consequence, did not long continue in the literature of radio. The host of American amateur workers, for instance, would have nothing to do with a word so little suggestive of particular purpose or utility.

Fleming's paper in 1904 clearly reflects the status of the

detector just prior to the advent of the electrolytic device. He said:

It is impossible to describe here a tithe of the forms of kumascopes which have been devised, but it is probably correct to say that all the effective Hertzian wave telegraphic work is being done at present either by a few forms of contact kumascopes, the principal one of which is the nickel-silver filings tube of Marconi, or else by means of some form of magnetic kumascopes [magnetic detector].

Thus the early, astonishing wireless telegraph demonstrations, ship-shore, ship-to-ship, and transatlantic, had been carried out with the coherer, and later the magnetic detector, as the receiver-actuating instrumentality. A point worth noting here is that in 1904 in the published material there was no hint of crystal detectors or electronic tube detectors. But, as was the case with Hertz's epochal discovery, and with Branly's, it is instructive and significant to observe how soon after the introduction of crystals, and the audion, prior investigations could be uncovered which were claimed as being contributory; indeed, in some instances, as being anticipatory.

The extreme simplicity of the crystal detector, its low cost, and its sensitiveness, diverted the minds of many investigators from the possibilities, if any, of betterment of the strictly electromagnetic receivers, as a result of which the crystal form of detector quickly reached a high degree of perfection, and was widely used.

Mineral Type Detectors

In America, in 1906, G. W. Pickard³ invented the silicon detector. In that year also H. H. C. Dunwoody,⁴ then with the American de Forest Wireless Telegraph Company, invented the carborundum detector. The word "invented" is used here in a conventional sense and as marking the time

³ United States patents 836,531 and 877,451.

⁴ United States patent 837,616.

at which crystal detectors appeared in the field of operation. When it happens that the recognized inventor of a new device, or of an important improvement, is the person in a position to disclose a considerable amount of prior investigation and development along the same line, the subject is doubly interesting, and the inventor, then, naturally occupies a fairly secure position.

Pickard, early in 1902,⁵ observed that certain of the so-called self-restoring coherers, notably the carbon-steel microphonic type were operative without the use of local battery. The necessary condition for this operation seemed to be a good electrical contact between the elements, as distinguished from the light, or coherer, form of contact. Later in that year, Pickard noted that almost any junction of dissimilar conductors made an operative wave detector, provided certain conditions of area of contact, and pressure were complied with. Still later, he investigated electric furnace products, which, from their hardness, high specific resistance, and relative infusibility, seemed suitable as constant thermojunctions of small area. After trial of a large number of elements and compounds, pure silicon was found to possess high thermoelectromotive force against any metal contact, a relatively high and constant contact resistance, and great stability. The outcome was the invention of a detector formed of a silicon surface and a small metal surface or point pressed in good contact therewith (see Figure 11).

In America also, in 1905, L. W. Austin,⁶ while conducting an investigation into certain matters connected with electromagnetic wave phenomena for Fessenden interests, independently discovered that thermoelectric contacts acted as detectors of electric waves. The term "thermoelectric" is used in this connection because it was current in 1906 as accounting for the action of detectors of the type here considered.

⁵ *Electrical World*, Nov. 24, 1906.

⁶ United States patent application 319,241, May 29, 1906.

As previously stated, Dunwoody developed the carborundum detector in 1906. Pickard also had experimented with carborundum crystals early in that year, determining that the most stable form was a single crystal, clamped between two flat copper terminals. A potentiometer-shunted source of local battery was employed to create a minute flow of current in one direction through the crystal and its contacts. De Forest,⁷ discussing the Dunwoody carborundum

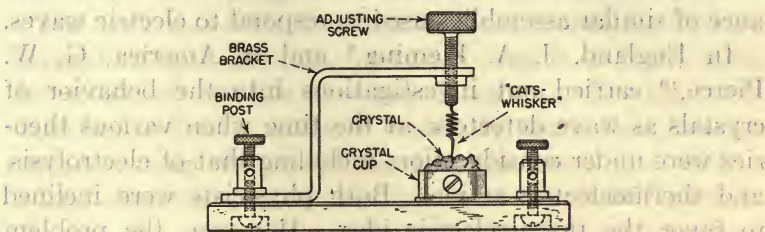

FIG. 11.—Crystal detector employing silicon or galena.

detector, stated his belief that its sensitiveness was independent of pressure of contact. He believed that the area of contact was important, and that the detector operated on the thermoelectric principle.

There had been a considerable spread of prior art which dealt with aspects of this general subject, but it may be that it was not all known to the radio workers of 1902-1906. Braun,⁸ in Germany, in 1874, published an account of his investigations of asymmetric or unilateral conduction of current by certain of the natural (mineral) metal sulphides. His inquiry, of course, had nothing to do with the detection of electric waves, but concerned the properties of crystals as elements of conducting circuits. Braun advanced the theory that perhaps there was an expansion of the crystal-line structure, due to the applied voltage, the expansion

⁷ *Electrical World*, Sept. 8, 1906.

⁸ "On the Conduction of Current through Sulpho-Metals," *Poggendorff's Annalen*, Vol. CLII, p. 550, 1874.

acting in one direction to increase the effective area or number of minute contact points of one of the metal electrodes with the mineral, and in the other to decrease this area; a sort of Peltier effect, but by no means convincing.

When it is recalled that until recent years the theory of operation of the partially oxidized disk rectifier, widely used for charging storage batteries from alternating-current sources, was still a matter of conjecture, it may be realized that in 1906 there was reason for mystery in the performance of similar assemblies used to respond to electric waves.

In England, J. A. Fleming,⁹ and in America, G. W. Pierce,¹⁰ carried out investigations into the behavior of crystals as wave detectors; at the time when various theories were under consideration, including that of electrolysis, and thermoelectric action. Both physicists were inclined to favor the thermoelectric idea. However, the problem was continuously attacked and, while the truth was elusive, progress was made by the process of elimination, which narrows the array of hypotheses kept to the fore until the erroneous ones are disposed of.

Writing, in 1909, about the behavior of molybdenite as an element of a detector, Pierce said:¹¹ "The large thermoelectric force of molybdenite against the common metals, together with its large negative temperature coefficient of resistance, lends plausibility to the hypothesis that the rectification is due to thermo-electricity." Professor Pierce was aware of the considerations which pointed away from the "heat" theory and in his later writings did not support the idea.

J. A. Fleming, as late as 1915, was still in doubt about the theory of operation of crystal detectors, stating:¹² "It is possible that the cause may be thermoelectric."

From observations made during his investigation of this

⁹ *Cassier's Magazine*, September, 1908.

¹⁰ *Physical Review*, June, 1907.

¹¹ *Electrician* (London), Dec. 24, 1909.

¹² *Elementary Manual of Radio Telegraphy and Radio Telephony*, p. 224.

subject, L. W. Austin¹³ concluded that the rectified current, being in general approximately proportional to the square of the alternating current applied, naturally suggested heat action.

Various other experimenters¹⁴ found it difficult to abandon the thermoelectric theory of the crystal detector. The probability that there would be a heat effect at the junction of the metal point and the surface of the crystal was one that it did not seem possible to explain away.

The very thorough investigation carried out by Pickard brought to light all that it seemed possible to learn about the action of crystals as wave detectors. Tracing backward from effect to cause, it was early noted that the current actuating the telephone receiver associated with a crystal detector was of the nature of a rectified current. That is, the alternating current produced in the antenna by passing electric waves was, after passing through the detector, changed into unidirectional current, made up of succeeding pulses of one sign.

Pickard ascertained that it was necessary to have a large area contact on one side of the crystal and that the direction of rectification was always the same for the same crystal. In some of the crystals early experimented with, the thermoelectric current (generated when the assembly was made up as a thermocouple) was in the same direction as the rectified current. This was an effect that would lead an investigator to conclude that thermoelectric current was in the opposite direction to the rectified current.

With the rectifier principle apparently established, Pickard suggested that the name *solid rectifier* be given to detectors of the mineral type to distinguish them from electrolytic and gaseous rectifiers, or valves. Of the mineral group, in addition to the carborundum type, four other solid rectifiers developed by Pickard, came into general

¹³ "Some Contact Rectifiers of Electric Current, 1908," *Bulletin*, Bureau of Standards, Washington.

¹⁴ V. C. Wynne, *Modern Electrics*, September, 1913, p. 551.

use. These were the silicon, zinc oxide (perikon), molybdenite, and pyron (iron sulphide), of which the perikon proved the most efficient.

As used in service the construction of these detectors was quite simple. Disregarding workmanship and fine appearance, a solid rectifier made up at a cost of fifty cents worked as well as one costing ten dollars. The silicon type had a small section of mineral fixed in a metal cap constituting one terminal, the other terminal being a fine metal point, adjustable as to pressure on the crystal. The carborundum type had a block of the substance fixed between two metal plates. The galena unit was the same as the silicon in design, except that the fine metal point was maintained in lighter contact with the crystal. An improved form of perikon detector provided contact between zincite and copper pyrites or bornite.

To account for the action of crystals as rectifiers, no aid seemed to be forthcoming from theories of electric action in conductors nor from any of the exceptional "effects" observed by scientists over a long period of years. By applying the electron theory in an analysis of crystal action, Pickard, in 1909, advanced the theory of electron shift at the point of contact. As a perfect contact of small area is one of the requisite conditions for the manifestation of the rectifying property, it appeared evident that the current flow in the rectifying conductor must be extremely constricted in the immediate neighborhood of the small contact. Such extreme constriction of current path in material where the conduction is not metallic might lead, he thought, to greater electron impoverishment for current flowing in one direction than in the other. The effect would thus be to cause the conductor and contact of small area to act as a rectifier.

The crystal detector throughout its approximately ten years of commercial use served two desirable ends. It was employed as a detector in thousands of small and large radio installations set up for commercial operation on land

and in ship stations, tiding over the years during which the wonderworking, billion-dollar audion was being nurtured through adolescence; particularly the six years 1906-1912 before the full potentialities of the vacuum tube were understood.

Also, the crystal, being an inexpensive device, enabled a host of amateur experimenters¹⁵ in America and other countries to set up small stations, primarily as an excuse for shunning the woodpile and sawhorse, but out of which came many suggestions for improvements in detail and much experimental data of immediate use to watching scientists engaged in solving the larger problems of radio signaling.

¹⁵That is, with rare modesty they called themselves amateurs. In reality, as it turned out, many of them were amateurs as Thomas A. Edison and Henry Ford had been amateurs.

13 Wireless Spans the Atlantic

The time is drawing to a close when source material can be written about the beginning of radio: the pioneers already are few in number. Later, other histories will be written, but what is then presented will perforce have to be based upon the early published matter. For this reason early workers in radio, who write historically from their personal knowledge, must be careful about what they set down. Many years ago an essayist wrote: "No anchor, no cable, no fences avail to keep a fact a fact. Babylon, and Troy and Tyre, and even early Rome have already passed into fiction." Thus there is the hazard that in some future time the detail accomplishments of the early radio investigators and the amateur experimenters may take on the mantle of tradition. Human beings are so given to basking in the sunshine, with little thought about how the sunshine came to be provided, that over the centuries there may ensue nothing disastrous should the traditions of radio glamorize the facts. But it is the present writer's belief that so long as it may be done all effort should be directed toward "keeping a fact a fact."

These thoughts prompt us at this point to review certain events in radio which were current topics throughout the years when the electrolytic, magnetic, and crystal detectors were employed, and during the six or seven years when the audion was used as a simple detector; when it was realized by those identified with radio telegraph undertakings that there was need for a method of amplifying the radio-frequency energy reaching the detector, by means of a local e.m.f., which latter could be maintained at any desired value and in a stable condition. Augmenting the radio-frequency energy at the receiver would be in accord with

wire telegraph practice wherein a sensitive relay is caused, through armature contacts, to operate a reading sounder, the relay's armature and the sounder being in circuit with a local battery. Many attempts were made to devise microphonic relays responsive to the minute rectified currents of the crystal detector, but in service none of these contrivances was found practicable.

With the particular requirement clearly in mind, R. A. Fessenden, in 1902, conceived the idea of the heterodyne,¹ by means of which "beat" currents might be employed. The unique principle of the thing was that if two radio-frequency currents of slightly different frequencies are impressed upon a circuit these will successively assist and oppose, being in and out of phase progressively, the result of the interference being that a third value is produced, known as a beat frequency. Then rectifying the resulting wave the detector output contains a wave having the same modulation (dot and dash break-up) as the original signal, but with a frequency equal to the difference between the received and the interfering frequency.

It will appear that the initial method of applying the superimposed, interfering frequency (by means of an alternating-current machine generator) was cumbersome, but it is to be noted that the audion, the development of which is traced in a later chapter, although introduced in an elementary form in 1906, was not available as an oscillator until six or seven years later.

The word "heterodyne" was coined from the Greek words "heteros" and "dynamis," signifying "other" and "force," to imply that the received signal in the telephone is reproduced by energy of the received waves plus that from a local source of e.m.f. Obviously the pitch of the tone in the telephone could be varied by varying the frequency of the locally applied e.m.f. Thus if a current of 50,000 cycles per second is impressed on a circuit on which a current of 50,500 cycles per second already is impressed, the resulting,

¹ United States patent 706,740 (1902).

or "beat," current will have a frequency of 500 cycles per second.

The heterodyne principle of reception introduced no new instrumentality. The interfering local e.m.f. could be applied by coupling the output of a high-frequency alternator, or alternating arc, to the receiving antenna. The heterodyne principle was destined to have expanded applications in radio and, in 1905, Fessenden applied for additional patents.² In the following years many ingenious applications of the principle were worked out by F. K. Vreeland, J. V. L. Hogan, E. D. Forbes, H. E. Hallborg, A. F. Van Dyck, Louis Cohen, and G. W. Lee, and others, all of whom were then associated with Fessenden interests.

The heterodyne principle, although conceived by Fessenden as early as 1902, remained a laboratory device of engaging possibilities until it was given a thorough test in competition with the "tikker" system of receiving continuous waves, in 1910. These tests, for which facilities were provided by the United States navy, were carried out in that year; first between the Fessenden station at Brant Rock, Massachusetts, and stations on board the fast cruisers *Salem* and *Birmingham*, and later from the navy's station at Arlington, Virginia, to the USS *Salem*. It was demonstrated that heterodyne reception was possible up to a distance of 3,000 miles, and that heterodyne signals were on the average five times as loud as signals from the same source and over the same distance when the electrolytic or crystal detector was employed simply as a rectifying device without applying the locally generated interference (heterodyne) oscillations to the antenna circuit.

This system held possibilities of vast importance, which were destined to reach fruition following the discovery, in 1912-1913, that the audion could be utilized to produce oscillations for a variety of purposes. With the diminutive audion available to produce the interfering oscillations, a

² United States patents 1,050,441 and 1,050,728, granted in 1913. See also United States patent 1,141,717, Lee and Hogan (1915).

substitute for the machine generator and arc generator, important improvements were soon made in the design of radio receivers. The *external* heterodyne (coupled to the receiving antenna) could be replaced by an *internal*, or self-heterodyne, circuit, an oscillating audion performing the desired function. Out of it all was evolved the superheterodyne radio receiver, popular for broadcast radiophone reception in 1926 and since that time.

To preserve continuity in the story of the experimental rise in radio it may be in order here to mention the "ticker," or ticker, already referred to. This device was developed by V. Poulsen (of arc generator fame) as a receiver for use where continuous waves were employed. It consisted of a mechanical vibrator, connected in the secondary circuit of the antenna coupler, which included a telephone receiver and a condenser in parallel. As the vibrator rapidly opened and closed the condenser circuit, the condenser was charged and discharged correspondingly, the charging current being that due to the antenna oscillations. Thus groups of audible signals reached the telephone identical with the telegraph dot-and-dash elements of letters transmitted from the distant station.

Rudolph Goldschmidt, in Germany, invented an interrupter of this type, which was called a "tone wheel," for use as a receiver of undamped (continuous) waves such as those transmitted by the alternator of his invention. A metal wheel with alternate insulating and conducting segments, rotating under a conducting brush, was connected to the antenna, the brush being in series with a telephone receiver. The wheel was rotated at such a speed that for each alternation in the antenna due to incoming oscillations one conducting tooth passed under the brush. In this manner the high-frequency oscillations were "cut up" into audible groups corresponding with the transmitted telegraph signals.

In America, L. W. Austin designed a rotary type of ticker comprising a rotatable grooved wheel in the groove of which

one end of a fine steel wire rested. When the wheel was rotated by means of a motor the chattering contact thus formed between wheel and wire served to render audible incoming oscillations in a receiving antenna connected thereto. In America, also, C. V. Logwood independently devised a rotary ticker of this order. In addition to their service applications, these latter "choppers" found favor with amateur radio enthusiasts. They could be constructed from parts at hand and from leftovers of other experimental excursions.

It was natural that the men working with the early receivers should do all possible to improve reception, and along the same line of development we are here discussing mention should be made of an arrangement devised early in 1905, by a twenty-one-year-old Navy radio electrician, R. B. Wolverton. His proposal was to increase the number of segments in the mercury turbine interrupter from the original two to six. Then the driving motor was speeded so as to produce a high, singing note in the headphones.

Wireless Ranges Gradually Increased

In an earlier chapter it was related that, in 1899, Marconi brought to the United States a wireless operating outfit with which an attempt was made to report the progress of the competing yachts in the international race between the *Shamrock* and the *Columbia*. After the conclusion of this disappointing engagement, Marconi carried out a series of trials of wireless between two United States warships, at the request of the naval authorities, during which signals were exchanged up to a distance of 36 miles.

On the return voyage to England, Marconi fitted the steamer on which he sailed with an installation of his equipment. It was a discouraging vigil, listening for wireless signals from wherever they might come. There was only an occasional experimental station anywhere in the world, and that of very limited range. He was elated,

however, when the vessel arrived within forty miles of the English coast, to pick up signals from a land station.

Upon his return to England, Marconi had arrived at the conclusion that the time had come to make an attempt to communicate across the Atlantic, England to America. It may be realized that this project was in the nature of an inventor's dream, when it is recalled that in 1899 temperamental wireless communication was tried out between the South Foreland lighthouse, England, and Wimereux, France, and that in July of that year two wireless-equipped British warships managed to exchange faint signals at a distance of 85 miles. Even in 1900, the operating distance had been extended to but 150 miles, and that at sea.

There were those who thought that Marconi might better employ his wit and talents in some emprise more promising than wireless telegraphy appeared to be. But he was a determined young man and he liked the work, and within two years thereafter in some measure he accomplished his purpose to bridge the Atlantic. In the interim there was much to be learned about the propagation of electric waves over long distances. Tests and experience would in time produce informative answers to many questions, but in the meantime there seemed little that the best-informed physicists could do other than to speculate.

In Chapter 9 of this work is incorporated a statement of the theory of electric wave propagation prevalent in the year 1900. In general, the understanding was fairly accurate, even though at that period no great distances had been covered. Moreover, a host of problems grew out of the attempts to bridge distances, which involved surmounting the curvature of the earth.

There is to be noted here an outstanding difference between the problems of "wire line" and "wireless" signaling. In telegraphy and telephony by wire the betterments were results of (in large part) improvements made in the media extending between the terminal instruments—the line and the cable. In radio signaling, the inventor, in order to

produce systems that will be improvements, has only the field of the terminal instruments in which to work. The medium connecting transmitting and receiving installations is not subject to treatment of a sort that would affect the grade of transmission through it of radio signals. The

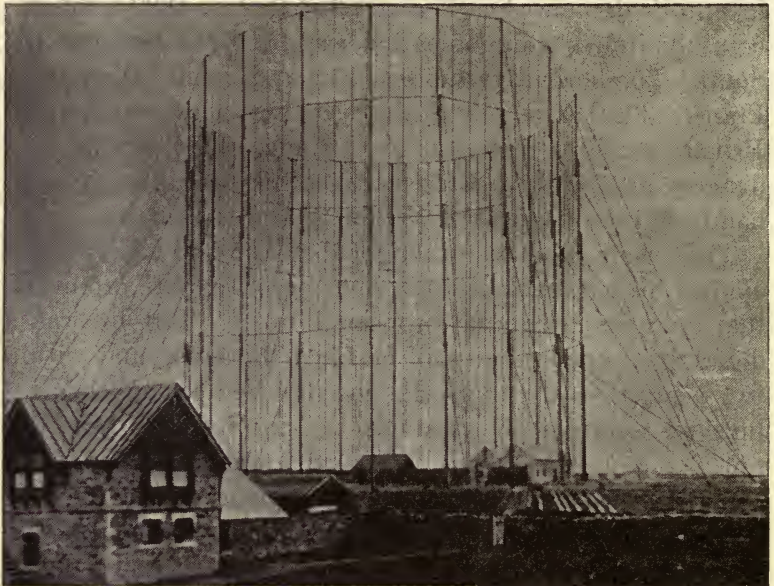

POLDHU STATION

Antenna-supporting masts at Poldhu, England, erected in 1900 for transoceanic wireless tests. (Courtesy of Radio Corporation of America.)

medium employed in wireless is forever assailed by weather effects, by sunspot effects, by aurora borealis disturbances, by lightning discharges, by earth currents, and so on. It is as if boys were forever throwing loose coils of hay wire, broom wire, baling wire, and barbed wire up among the telegraph or telephone wires strung on poles. Almost but perhaps not quite so devastating as that would be to wire services.

Faint Whisperings across the Atlantic

On December 21, 1901, Marconi was reported to have succeeded in telegraphing by wireless from a station at Poldhu, Cornwall, England, to a temporary receiving station set up near St. John's, Newfoundland. All that was claimed at the moment was that the letter *S* in Morse code dots had been received at St. John's. This astonishing report immediately precipitated widespread diverse opinion and conjecture as to how the transmitted energy could possibly indicate its presence at a point 1,800 miles from its source. In France, one official advanced the notion that the submarine telegraph cables extending across the Atlantic acted as a guide to the radio waves. Andre Blondel assumed that the layers of the ether at the surface of the ground have a maximum electrical density, comparable to a sort of electrical mist, extending to a height about that of the usual antenna. The same conditions obtaining at each end, the receiving antenna he assumed would be more influenced when entirely immersed in this hypothetical mist than when it was extended to greater heights.

Others clung faithfully to the idea that the theory of the propagation of light rays should afford an explanation of the behavior of Hertzian waves. Some held that the waves were propagated by diffraction, increasing as the waves were longer. But there was the stern reality that in crossing the Atlantic the waves had to surmount an obstacle more than 186 miles high, the curvature of the earth.

Emile Guarini, in France, and Professor La Grange, in Belgium, distinguished between the progress over the surface of the earth, or through it, of the electric and magnetic components of electric waves. Guarini³ referred to experiments of his which convinced him that

An electric field can traverse obstacles only with loss of energy [deviations and absorptions], while a magnetic field traverses

³ *Scientific American*, May 9, 1903.

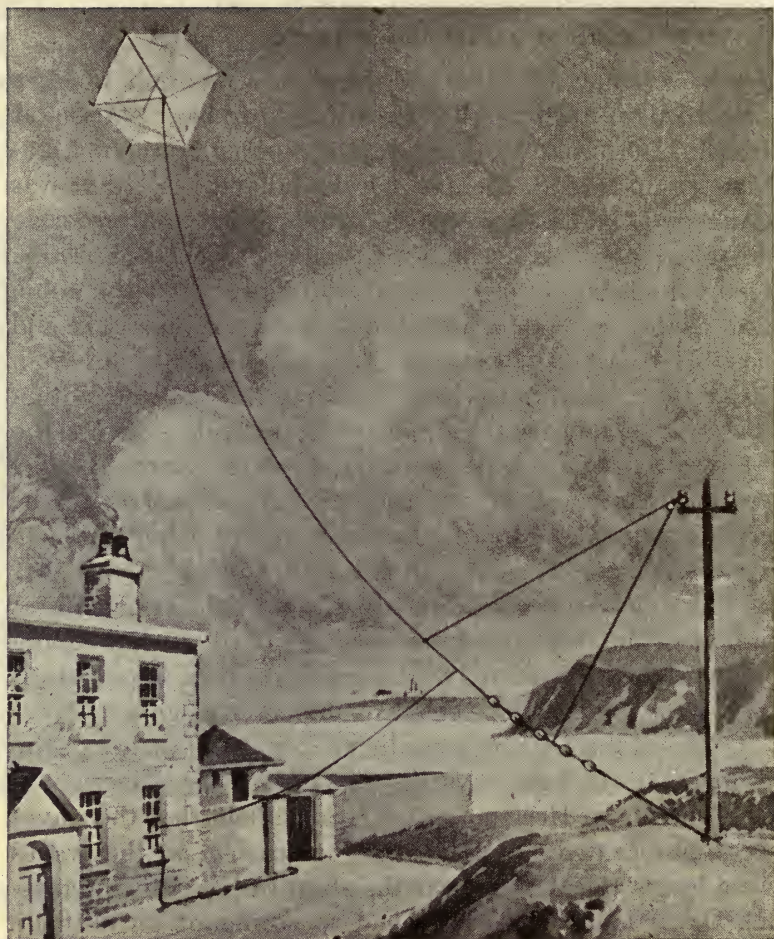

SIGNAL HILL, ST. JOHN'S, NEWFOUNDLAND

Station where Marconi instruments were set up for the first transatlantic wireless signals, December 12, 1901. (Courtesy of Radio Corporation of America.)

the earth's crust without serious difficulty and with moderate loss.

The amount of "bending" of electric waves around the earth's surface in traveling from England to Canada may be understood when it is stated that a ray of light starting

from England in a horizontal direction would pass over the nearest point of land in Canada at a height of approximately one thousand miles. And then at operating distances in excess of one thousand miles a new series of transmission phenomena was encountered. In 1902, Marconi, during a voyage across the Atlantic, observed an effect of daylight on the strength of signals. Signals from the English station were readable at night to a distance of sixteen hundred miles, while in daylight they were not received even faintly beyond a distance of eight hundred miles.

A theory of this phenomenon was that daytime transmission was less effective as a result of ionization of the air in the immediate neighborhood of the sending antenna; caused by ultraviolet rays from the sun.

Theories Upset and Speculation Rife

Small wonder then that when, in 1901, Marconi sent signals across eighteen hundred miles of space, there should be speculation as to the mechanism of transmission of the waves. No doubt that the energy departed from the sending antenna and existed for a fraction of a second in a medium extending continuously between sending station and receiving station. There was the question as to the nature of the medium, but the action of the sending antenna by means of which the distance effect was produced seemed to be consistent with the understanding that electromagnetic waves were produced and radiated.

Remembering the query in Kerr's book of 1898, as to whether Marconi was, perhaps, unknowingly using a new system of electric waves differing from those of Hertz, following the transatlantic demonstration of 1901, the question again was asked, whether the very long distance covered was consistent with the properties of pure Maxwellian or Hertzian waves. To Oliver J. Lodge occurred the notion that "bound ether" accounted for the propagation of waves around the surface of the earth, the thought being that the ether present in the earth and its atmosphere was in some

fashion bound or locked as an inherent element of the whole.

At the time of Marconi's epochal demonstration, December, 1901, in sending signals across the Atlantic, there was the probability that for the first time the submarine telegraph cable companies might wonder what was going on. Actually, at that time there was a world-wide need for extensions of communication facilities, and the cable companies were going about their own business. In 1900, Germany laid down a submarine telegraph cable stretching from Emden to New York by way of Fayal. The Commercial Cable Company laid an additional transatlantic cable. A transpacific cable was laid jointly by Great Britain, Canada and Australia, between Vancouver, British Columbia, and Australia, completed in October, 1901. Plans were complete for laying the Mackay interests' cable across the Pacific, and the United States War Department in that same month laid a cable up the Pacific coast to Juneau, Alaska.

Nevertheless, there were no more interested spectators of the wireless event of December 12, 1901, than the highly intelligent staff members at the transatlantic cable stations. It had been the custom for many years in submarine cable service for the staffs at the widely separated stations throughout the world to exchange Christmas greetings each year by means of cablegrams.

On the Christmas Day, less than two weeks following the transmission of the letter *S* across the Atlantic in December, 1901, the staff at the North Sydney, Nova Scotia, cable station dispatched the following message to the office at the other end of the cable, at Liverpool, England:

Best Christmas greetings from North Sydney,
Hope you are sound in heart and kidney,
Next year will find us quite unable,
To send exchanges o'er the cable:
Marconi will our finish see,
The cable co's have ceased to be;

No further need of automatics,
Retards, resistances, and statics.
I'll then across the ether sea,
Waft Christmas greetings unto thee.

From the English station came the reply:

Don't be alarmed, the cable co's,
Will not be dead as you suppose.
Marconi may have been deceived,
In what he firmly has believed.
But be it so, or, be it not,
The cable routes won't be forgot;
His speed will never equal ours;
Where we take minutes, he'll want hours.
Besides, his poor weak undulations,
Must be confined to their own stations;
This is for him to overcome,
Before we're sent to our long home.
Don't be alarmed my worthy friend,
Full many a year precedes our end.

There was encouragement in this, and it warranted an acknowledgment. A final cablegram from the American to the English station read:

Thanks, old man, for the soothing balm,
Which makes me resolute and calm.
I do not feel the least alarm,
The signal "s" can do no harm;
It might mean "sell" to anxious sellers;
It may mean "sold" to other fellers.
Whether 'tis "sold" or simply "sell,"
Marconi's "s" may go to—well!

The Nature of Wireless Radiation

In the year 1901 wireless signaling had in truth a long way to go before it was to be a serious competitor of submarine cable signaling for intercontinental message traffic. That time would come but the time was not yet. There was still much to be learned about the real mechanism of radio transmission across space. Many minds were at work on the problem in England, in France, in Germany, in America, and elsewhere.

Structure of the Wave

In America, Nikola Tesla,¹ as late as the year 1912, entertained the belief that in a radiating system employing a spark-gap oscillator and an earth connection in addition to an elevated antenna, transmission takes place through space, conduction effects being excluded. But when an arrangement whereby the spark gap is replaced by an energy-storing inductance, one side connected to earth, the other to an elevated antenna, the distant receiver will be energized by currents conducted through the earth while an equivalent electric displacement occurs in the atmosphere.

Tesla's notion was that "the distant receiver is operated simply by currents conducted along the earth, energy radiated playing no part." Loss of signal energy as distance is overcome he explained as being due to evaporation of moisture from that side of the earth at the time turned toward the sun, the conducting particles carrying off some of the electric charge imparted to the earth at the transmitting station. Inasmuch as evaporation is considerably greater during day hours, Tesla's novel theory advanced

¹ *Electrical Review and Western Electrician*, July 6, 1912.

an explanation that might seem to account for the longer ranges of operation at night than in the daytime.

Nor was it likely in the wide search for theories, which might contain a convincing degree of plausibility or prove to be the lucky "shot in the dark," that the possibility of a part being played by the earth's natural magnetism should be overlooked. Although eight years later, E. V. Appleton,² in England, and H. W. Nichols and J. C. Schelleng,³ in the United States, were to designate the relation of the earth's magnetic field to wave propagation under certain conditions (in 1917), J. S. Clemens,⁴ in the United States, advanced the theory that in order to transmit signals over the earth's surface without conducting wires it would be necessary only to "excite" the magnetic lines already in the air. It was Clemens's notion that the high voltage applied to a radio antenna acted to excite the natural magnetism, resulting in the creation of magnetic waves that traveled outward, following the curvature of the earth by virtue of the fact that in the region of the earth magnetic lines are present.

The electromagnetic theory of light having been postulated by Maxwell, and the existence of electromagnetic waves, artificially produced, having been demonstrated by Hertz, most of the terminology and nomenclature associated with light rays quite naturally attached to the radiation mechanism of wireless signaling. Indeed, no explanation of the early success in space signaling had an acceptable foundation except that which could be stated in terms employed by Hertz: reflection, refraction, polarization, and interference, which terms are common to the light wave theory. But light waves travel in straight lines unless reflected or refracted, and there are but a few substances which either the direct rays or the refracted rays can penetrate. The phenomena of light and dark hours on the sur-

² *Proceedings, Physical Society* (London), Part 2, February, 1925.

³ "Propagation of Electric Waves over the Earth," Nichols and Schelleng, *Bell System Technical Journal*, April, 1925.

⁴ *Electrical Experimenter*, March, 1917.

face of the earth had long since disclosed the main properties of waves from the sun. Hertz's waves were known to be highly penetrative and Marconi's transocean demonstration indicated that they reached points so far distant from their source that (except for certain sun-effect losses) no dark hour period existed.

Kennelly-Heaviside Layer.

One of the earliest to advance a convincing explanation of the mechanism of Hertzian wave transmission over distances involving the curvature of the earth, was Dr. A. E. Kennelly, of Harvard University. In an article published in the *Electrical World*, March 15, 1902 (three months after Marconi's first transatlantic test), Kennelly stated:

There is well-known evidence that the waves of wireless telegraphy, propagated through the ether and atmosphere over the surface of the ocean, are reflected by an electrically-conducting surface. On waves that are transmitted but a few miles the upper conducting strata of the atmosphere may have but little influence. On waves that are transmitted to distances that are large by comparison with fifty miles it seems likely that the waves may also find an upper reflecting surface in the conducting rarefied strata of the air. It seems reasonable to infer that electro-magnetic disturbances emitted from a wireless sending antenna, spread horizontally outward and also upward, until the conducting strata of the atmosphere are encountered, after which the waves will move horizontally outward in a fifty-mile layer between the electrically-reflecting surface of the ocean beneath, and an electrically-reflecting surface, or successive series of surfaces, in the rarefied air above.

If this reasoning is correct, the curvature of the earth plays no significant part in the phenomena, and beyond a radius of, say, 100 miles from the transmitter, the waves are propagated with uniform attenuation cylindrically, as though in two-dimensional space. The problem of long-distance wireless wave transmission would then be reduced to the relatively simple condition of propagation in a plane, beyond a certain radius from the transmitting station. Outside this radius the voluminal energy of the waves would diminish in simple proportion to the distance,

neglecting absorption losses at the upper and lower reflecting surfaces, so that at twice the distance the energy per square

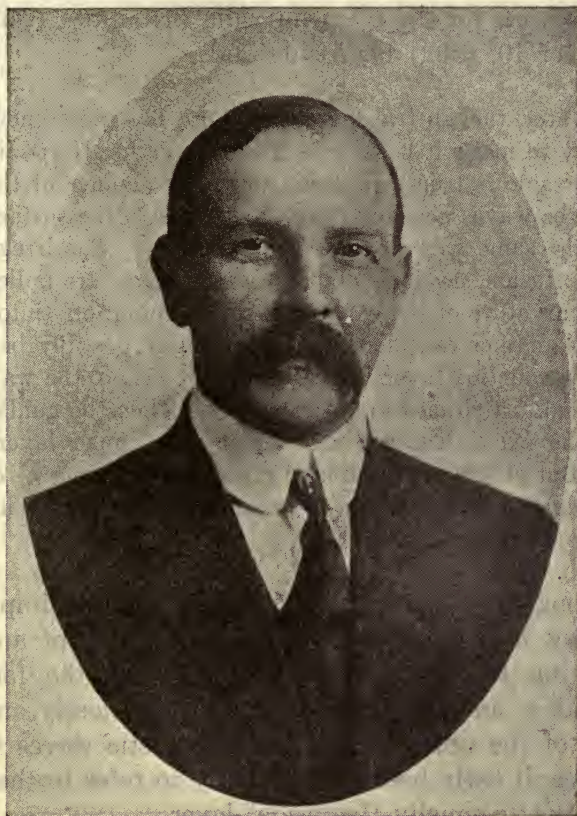

A. E. KENNELLY

meter of wave front would be halved. In the absence of such an upper reflecting surface, the attenuation would be considerably greater.

Based on measurements made by J. J. Thomson, Kennelly believed that it would be safe to infer that at an elevation of about fifty miles above the earth's surface there exists a rarefaction of the earth's atmosphere which, at ordinary temperatures, accompanies a conductivity to low-frequency alternating currents about twenty times as great as that of ocean water.

The probability of a reflecting layer in the upper atmosphere occurred also to Oliver Heaviside, very likely independently, in June, 1902. At that time, writing an article on telegraphy for the *Encyclopaedia Britannica* (published, December 19, 1902) Heaviside said:

Sea water, though transparent to light, has quite enough conductivity to make it behave as a conductor for Hertzian waves, and the same is true in a more imperfect manner of the earth. Hence, the waves accommodate themselves to the surface of the sea in the same way as waves follow wires. The irregularities make confusion, no doubt, but the main waves are pulled round by the curvature of the earth, and do not jump off (into space). There is another consideration. There may possibly be a sufficiently conducting layer in the upper air. If so, the waves will, so to speak, catch on to it more or less. Then the guidance will be by the sea on the one side and by the upper layer on the other. But obstructions, on land especially, may not be conducting enough to make waves go around them fairly. The waves will go partly through them.

Although the first public suggestion of the importance of taking into consideration the probability of an upper conducting layer was made by Kennelly, the fact that Heaviside's announcement followed so closely, and his studies of the reflection of electromagnetic waves were so extensive, it early became customary to refer to the condition as the "Kennelly-Heaviside" layer.

There is no need to commiserate with the scientists of 1902 because they were unable to work out a theory of radio transmission that everyone could understand, that everyone would accept, when we remind ourselves that as late as 1925-1926 the Kennelly-Heaviside layer was in some quarters still on probation.⁵ Two years after the Kennelly announcement, J. A. Fleming, of the Marconi organization, in his paper read at the St. Louis Electrical Congress, asked the question:

⁵ H. W. Nichols and J. C. Schelleng, "Propagation of Electric Waves over the Earth," *Bell System Technical Journal*, April, 1925.

How is it that the bending of the electric radiation takes place? If it is due to a simple diffraction, then it is proportionately to the wave-length vastly greater than anything of the kind we find in connection with the ether waves which produce luminous sensations. It may be suggested that we have here one of the facts which indicate that the radiation sent off from an earthed antenna is not identical in every way with that sent out from an insulated Hertz oscillator.

Here was a task for the giants: a problem for the best intellects. Intelligible signals had been transmitted between points on the earth's surface 1,800 miles apart without the use of line wires. How account for this through reasoning applied to explain the behavior of light rays, or of sound waves in air?

Attempts to determine whether diffraction could occur to a sufficient extent to account for the observed facts were by some thinkers supposed to involve the ratio of wave length to the earth's diameter. The optical analogies discussed by Fleming, and others, did not seem to lead in the direction of understanding. Naturally, many of the bright minds in the world were engaged in attempts to unravel the mystery, among whom were E. Lecher, W. V. Rybczynski, and A. Sommerfeld, in Germany; H. Poincaré and H. Abraham, in France; J. Nicholson, W. H. Eccles, MacDonald, Love, and Watson, in England.

The researches of these physicists extended through the years from 1901 to around 1919. Sommerfeld, in 1909 (*Annalen der Physik*, Vol. XXVIII, No. 4), assumed that part of the radiation is a surface or cylindrical wave which follows the contour of the earth, analogous to the transmission of electric waves over wire lines, the waves being rapidly damped in a downward direction, and subject to damping in the direction of propagation. Sommerfeld's idea was that the surface wave following the contour of the earth was not diffracted; or, at least, diffraction was not essential to its progress over long distances. Sommerfeld's theory was later modified by Rolf and van der Pol, to whom reference shall be made in a later chapter.

The Electrical Mechanism of Radiation

The electrical engineering concepts and the terminology that grew up based upon the association of electrostatic and electromagnetic effects in and around conducting wires, for educational purposes served well to build the art of engineering, and although the electron theory, which reaches deeper into elemental causes, has come to have wide applications, it was natural that the early radio studies should be couched in the terminology long established.

The theory of radio transmission stated in the Blondel-Ferrié paper of 1900, referred to in an earlier chapter, was an epitome which in few words set forth the consensus of the foremost thinkers of that time. The terms there used explained that in the transmitting antenna the lines of electric force are in meridional planes, connecting perpendicularly with the earth; the magnetic lines of force being in circles having the antenna as a common axis. Thus the electrostatic and electromagnetic components of electric waves were set forth in an understandable manner.

The relative significance of these components in wire telephone circuits had, eleven years previously, been investigated by J. J. Carty, in connection with "cross-talk" phenomena. In a paper read before the New York Electric Club, in 1889, Carty showed that the disturbing current induced in neighboring wires was due to electrostatic induction, the electromagnetic effect being a consideration only when the wires are in close proximity. A reason for this is that in telephone lines the current is relatively small. In the case of electric power lines the electromagnetic field may be the greater factor.

The very fact that when the existence of electromagnetic waves was first proved high-frequency currents were employed to produce them was, no doubt, responsible for the notion that electric waves were purely a high-frequency phenomenon. The writings of Maxwell and Heaviside were freighted with suggestion that an alternating e.m.f. alone

was the essential. Obviously, experimental investigation alone was not likely to afford the discovery that radiation takes place at low frequencies; it was a subject for the mathematicians, and in the course of time the mathematicians gave an answer, notably John R. Carson, in America.

The effect of any alternating current in a conductor is to create in the space surrounding it electromagnetic and electrostatic fields, linked together. With an alternating e.m.f. applied to a conductor these fields are in a continuous state of change. They reverse, expand, and contract according to the variations in the direction and the intensity of the current. When the frequency is high, say above 20,000 cycles per second, a considerable portion of the energy is radiated into space in the form of electromagnetic waves having the same frequency as the actuating current.

It will be understood that at very low frequencies the energy radiated is inconsiderable, and that when the frequency employed is of a high order radiation travels outward into space.

It would be erroneous to suppose that the theory that electromagnetic waves are transmitted as detached waves through space, the hypothetical ether serving as the medium of transfer, was arrived at in a manner so convincing that all students of the subject were in agreement with its postulation. From Newton's time (1686) until the present, the wave theory of light has been subjected to occasional analyses, and to attack. And, as the wave theory of light and the wave theory of radio have been associated in some degree of harmony since Hertz's time, the experimental rise of radio has been accelerated or retarded as those engaged in the work have had to devote time to running down new theories at variance with those of the historic order.

Isaac Newton regarded it as beyond reason to conceive of waves or vibrations in any fluid being propagated outward without an immediate and continuous bending such as would quickly terminate their outward progress. In

more recent times, Dr. Einstein has thrown discredit on the simple wave theory of light, which is either aid or confusion for those engaged in applying the electromagnetic wave theory in radio signaling—depending upon what lies ahead in the way of further disclosures.

It may appear that thirty years ago there was a continuous "open season" for theories of radio transmission. An independent soul, here or there, was within his constitutional rights when he took the stand that Maxwell could have been mistaken! Heaviside, one wireless devotee declared, "was too eager to shout 'me too' with respect to the Maxwellian pronouncements." In the United States, in 1916, a wireless student published a book⁶ on the subject of wireless transmission in which he took the ground that transmission is purely electrostatic, the air acting as one side of the communication circuit and the surface of the earth the other. His idea was that the air is a fair conductor for high-frequency currents and that the energy sent off by a transmitting antenna is conveyed to the receiving antenna with the air serving as the medium—ether playing no part in the transfer. With this theory the deductions of Maxwell and the demonstrations of Hertz would fall, even though, as the author declared, a reason would stand out accounting for the manner in which the waves follow the curvature of the earth, adhering to a path in which air is present.

Early writers on radio felt that they were clear on the points that within a distance of about one-half wave length from a vertical antenna there exist no complete electric waves, for within this distance some of the lines of force still remain attached to the antenna, and that a free Hertzian oscillator emits free waves which are propagated outward and travel through space as do light waves; and that a grounded oscillator gives off ground waves—half-waves whose electrostatic lines, instead of being self-closed, terminate on the earth. Poincaré, in France, and Vreeland, in America, in 1904 concluded from the latter that the

⁶ Frank E. Summers, *Revolutionary Theories in Wireless*, Memphis, Mo.

waves follow the conducting surface of the earth and sea over which they slide.

In America, also, Dr. J. E. Ives, writing in the *Electrical World*, September 26, 1908, enlarging on the work of Zenneck and Hack, in Germany, discussed the mechanism of electric wave production and of detachment from an antenna, dealing entirely in terms of electrostatic flux, the magnetic component being disregarded. Ives stated that when an antenna is initially charged the electric flux surrounding the antenna slides down to earth, and an attempt was made to account for the subsequent detachment of the flux from the antenna by electric forces resident in the flux; that is, in the tension along the flux lines and in the distension perpendicular thereto.

With an alternating e.m.f. applied to a transmitting antenna, the electrostatic field is constantly varying, and when electrostatic induction is varying a magnetic field is produced. The reverse also is true. The surging to and fro of the electric charge in the antenna entails, therefore, a magnetic field, which makes up part of the detached energy. As the energy in wave form detaches, the magnetic component is preponderant; and, as noted by Lowenstein,⁷ at a distance of one-sixth of the wave length, the magnetic intensity is 40 per cent greater than the electric intensity. Further, at a distance of one-half wave length the two values are equal.

An examination of the technical literature of radio throughout the two decades 1900-1920, together with personal recollection of discussion which took place at periodical meetings of engineers during this period, emphasizes the fact that very creditable practical progress was made notwithstanding that all workers were not in agreement in regard to the mechanism of electric wave production and propagation.

Following the Kennelly-Heaviside announcements of

⁷ Fritz Lowenstein, "The Mechanism of Radiation and Propagation in Radio Communication," *Proc. Inst. Radio Engineers*, June, 1916. (Paper read on Dec. 1, 1915.)

1902, the theory of refraction gained credence, and as the function of the earthed sending antenna became better understood the sliding, surface-wave theory seemed based on logical reasoning. Engineer writers of 1905-1906 presented both these theories of transmission. The thought had not yet become clear that waves from a given transmitter might travel to a distant station in the form both of a "sky" and an "earth" wave.

Experience gained from actual operation of radio stations in time contributed materially to a clearer understanding. Lowenstein's paper of 1915 summed up the understanding current at the time in these words:

Also, in view of the curvature of the earth, does it not seem more natural to speak of a conducted radio frequency current and to look upon the electric and magnetic field traveling with it as its accompanying result than to designate radio transmission as identical with the radiation of a Hertz oscillator *modified* by a conducting equatorial plane *and* by bending of radiation lines due to the earth's curvature *and* to the existence of the conducting upper strata.

Here was a summation of the various theories which had survived, and there was present the implication that the waves might travel long distances and perform their signaling function whether they journeyed as waves on the surface of the earth or continuously bent in the direction of propagation by diffraction from an upper reflecting layer.

In discussing the Lowenstein paper L. W. Austin made the point that it should be remembered that neither the upper wave nor the lower wave can exist without the other.

In Lowenstein's paper, as in Ives's paper, in early writings of Poincaré, of Fleming, and in Pickard's paper of May, 1909, presented before the Wireless Institute, New York, electric wave phenomena were considered from the electrostatic angle. While the advanced physicist had no difficulty with this interpretation, there is little doubt that omission of reference to the magnetic component was confusing to less advanced students and to practical engineers. Indeed, it was not until Dr. John Howard Dellinger, of the United

States Bureau of Standards, boldly called attention to discrepancies of expression and statement that the literature of the art began to show uniformity, in such fashion that thenceforth students encountered less of discrepancy and less omission of important factors.

Dellinger, in a paper on "Principles of Radio Transmission and Reception with Antenna and Coil Aerials," read before the American Institute of Electrical Engineers, in October, 1919, discussed mathematically the mechanism of radiation. If there was a notion that the electrostatic and electromagnetic effects neutralized each other, Dellinger dispelled the idea by pointing out that the two disturbances do not exactly neutralize each other, due to the finite time of propagation from one side of the circuit to the other—the result giving rise to radiation from a metallicly closed circuit. He showed that the electrostatic and magnetic fields in a radiated wave are not independent phenomena; they are strictly equivalent, and but two aspects of the same thing. Further, he demonstrated that the current received in an antenna calculated from the electrostatic was exactly the same as that calculated from the magnetic field, making it clear that any effect of a transmitted wave may be considered as due to either the electrostatic or magnetic field accompanying it.

The science writer, especially in the early days of an art, is handicapped somewhat by a lack of terminology common to all students. It is inescapable that he should have to draw upon analogy and upon the terminology of older arts, long established. In early treatises on wireless the term "whip crack" as applying to the action of a discharge oscillator in producing electric waves was widely used, accompanied by such terms as "snapping off of lines of force," to account for the formation of detached waves moving outward from an antenna. Such terms were ambiguous, but perhaps unavoidable in the beginning. The gradual development of accurate terminology has largely corrected this, the development being an accompaniment of the development of radio engineering itself.

The Magic Bulb

In earlier chapters was traced the evolution of electric wave detectors from the nearly closed loop used by Hertz to the solid detectors of the crystal class, throughout a period of about fifteen years. Crystal detectors were destined to continue in service at many ship stations and at numerous shore stations up to the time of World War I and later. But at last there was something new under the sun. The wonderworking audion bulb had arrived.

Few outstanding inventions did not arrive in the wake of processes of evolution which, unerringly, if unknowingly, erected edifices of knowledge out of which invention might materialize. This was true of the Branly coherer, brought out in 1891. The evolution of the coherer, through the work of Varley (1852), Hughes, and Ludge (1879), Hertz (1887), Lodge (1889), and then Branly, although the early contributions were not related to wireless uses, continued along lines that led to successive disclosures of importance to wireless signaling.

There is in this situation nothing that detracts from the importance of the ultimate, key invention. Rather, it is usually a tribute to the genius of the inventor that he was able to consolidate the various seemingly unrelated ideas, and combining these to produce a useful device not thought of by prior workers identified, unknowingly, with its evolution. The invention of the audion by Lee de Forest, in America, was quite naturally preceded by observations and discoveries in several countries; easy enough to identify as to their worth after the invention of the audion, but which, previously, were not regarded as of particular merit.

Throughout the fifty years before Hertz, experimenters in laboratories, working with induction coils and con-

densers, had noted mysterious sparks in metallic systems in the neighborhood, all of which was understandable after Hertz but not before. And so, very likely, it was with effects observed by investigators years before de Forest and Fleming (1904-1906). The evolution of the audion may be traced by taking note of published statements and announcements which, viewed retrospectively, were in fact discoveries that contributed toward an unforeseen but useful development.

Discoveries Preceding the Audion

To place a finger on a fecund seed which by an accommodating imagination could be designated as a primeval forebear of the vacuum tube (as a trilobite of Paleozoic time might be tagged the first crawling thing) we might cite a publication of the year 1853, by Professor Buff, of the University of Geissen. Buff's paper¹ dealt with the electrical properties of flame, and his conclusion was that gaseous bodies, rendered conducting by strong heating, were capable of exciting other conductors, solid as well as gaseous, electrically. In 1853, the incandescent lamp was twenty-four years distant in the future, so Buff had to employ glass tubes into which he inserted small strips of platinum separated by air space; the air within the tube being heated by the application of heat to the external surface of the tube.

With this crude device, Buff was said to have demonstrated that electric current from a primary battery could be maintained in a steady state through the path of the gas in the tube, whereas with the tube cold no indication of passing current could be observed on a connected galvanometer. In this we have an early reference to electric conduction through gases.

In the year 1883, Thomas A. Edison was at work on problems connected with the electric light, introduced four years earlier. The discovery by Edison, of the "effect" which

¹ *National Telegraph Review*, July, 1853.

twenty-three years later was to be disinterred to live again as a principle of the Fleming valve and the de Forest audion, was clearly a by-product of an investigation into the characteristics of early incandescent electric lamps. Edison had been plagued by the gradual loss of luminous efficiency of the lamps because the bulbs became blackened due to a dark deposit on the inner surface of the glass.

In the course of his puzzlement over this undesired effect Edison noted that frequently there was on the glass in the

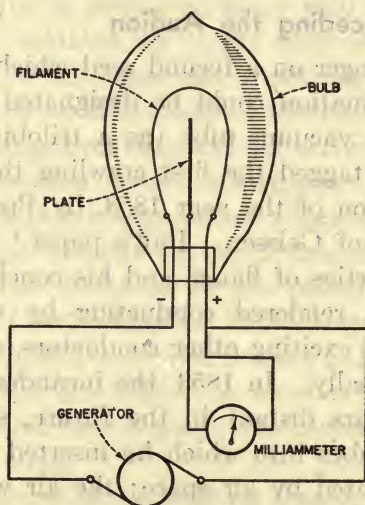

FIG. 12.—Circuit for demonstrating the Edison effect.

plane of the filament a line that was not blackened. Further, and of key importance, he observed that the leg of the filament which cast the shadow was always the one connected to the positive side of the circuit. It appeared as if the side of the filament connected to the negative lead were throwing off minute particles from the carbon filament which traveled past the positive leg, depositing themselves on the glass everywhere excepting directly in line with the positive leg.

Here a breath-taking discovery dallied provokingly just

around the corner. But that was five years before Hertz; twelve years before Roentgen, and thirteen years before the penetrating electron was identified. In studying the effect, Edison had constructed lamp bulbs containing filaments and also small plates situated between the two legs of a filament. By connecting a galvanometer to the plate and to the positive side of the filament, as shown in Figure 12, the meter then indicated current flow across the gap within the bulb.

Edison was able to extend the investigation to the point where he was aware that a stream of what he supposed to be carbon particles from the negative leg of the filament rendered the path across the gap conducting. Always a firm believer in patent protection, Edison filed an application² covering the discovery (Patent 307,031) in which was incorporated a significant clause: "This current I have found to be proportional to the degree of incandescence of the conductor, or the candle-power of the lamp."

Many years after the discovery of the "effect," in discussing the subject, Edison said: "As I was overworked at the time in connection with the introduction of my electric light system I did not have time to continue the experiment." It is just as well, perhaps, that the great inventor returned to the problems of electric lighting, for, due to his concentration on that subject, the general introduction of incandescent lamps proceeded satisfactorily. And, for that matter, a "valve" or an "audion" dumped into the laps of the physicists of the time very likely would have had a precarious experience. That was twenty-three years ahead of its ordained natal day!

It should not be supposed that physicists in other countries would not by design or accident uncover new electrical actions which in some of their elements were anticipatory of what was in store. As early as 1725, Charles François Du Fay noticed that a conductive path for elec-

² Clayton H. Sharp, *The Edison Effect and Its Modern Applications*, New York, 1921.

tricity was formed between a hot sphere and a cold one. In 1873, Frederick Guthrie found that at red heat an insulated iron ball would retain a charge of negative, but not positive, electricity.

In Germany in 1882, Julius Elster and Hans Friedrich Geitel³ began an investigation of the ionization produced by incandescent metals, and employed an exhausted glass vessel containing an insulated platinum plate, mounted close to which stretched a fine metallic filament brought to incandescence by electric current. Out of these inquiries came additions to knowledge on this general subject, but the researches into phenomena in evacuated bulbs were not carried far until about five years after Edison's discovery.

In Germany, also, Wilhelm Hittorf⁴ demonstrated that a small electromotive force could sustain an electric current between a hot carbon electrode and a cold electrode, in the highest vacuum obtainable at the time, provided the hot electrode was connected to the negative pole of a battery.

Edison was on friendly terms with William H. Preece, the head of the British Post Office Telegraphs, and in 1884, gave Preece samples of his bulbs with filament and midfilament plates, with which the asymmetrical conductivity of current between the separated electrodes had been demonstrated. In the same year Preece reported the action of the phenomena at a meeting of the Royal Society. At that time J. A. Fleming was electrician for the Edison Electric Light Company, London.

Other citations could be submitted to show that the mystery bulb was bandied about the laboratories as a curiosity; a device that possessed engrossing peculiarities, but for which no one at the time could think of a use.

The connection between the properties of the Edison bulb and the unknown cleared up somewhat following Roentgen's announcements of 1895. Studies thereafter

³ *Wiedermann's Annalen*, Vol. XVI, 1882.

⁴ *Ibid.*, January, 1884.

instituted led to the discovery that a hot electrode in a vacuum tube emits electrons. Thomson's researches on the conductivity of gases, published in 1897, disclosed the discovery of a new body having a mass but $1/1845$ part of that of the hydrogen atom. This body was, by its discoverer, first called a corpuscle. Here was useful knowledge by the bookful. The clouding of the glass bulbs used as incandescent lamps had given up its secret.

It was not until several years later, however, that it occurred to wireless workers to investigate the possibilities of evacuated bulbs as detectors of electromagnetic waves. Workers struggling with the problems of wireless prior to 1904 were hopeful that the magnetic detectors of Rutherford and de Forest would provide the desired improvement over the coherer form of detectors. But the evacuated bulb was a prodigy of the laboratory, a product with a promising destiny. Its properties as a radio device could not long elude the penetrating scrutiny of certain young men who were then thinking of wireless, day and night.

Recalling his examination of the Edison bulb nearly twenty years previously, J. A. Fleming, in 1904, toyed with the idea that it might have possibilities as a wave detector. In that year he had made up a detector of this type which in the course of time became known as the Fleming valve, or two-electrode tube (see Figure 13).

An incandescent lamp bulb with carbon filament had a metal plate included within the glass or a metal cylinder placed around the filament, the plate or cylinder having an external terminal connection in addition to the filament terminals.

The knowledge that accrued from the discoveries of Roentgen and J. J. Thomson, particularly, in the two decades 1883-1903, with reference to conduction through gases, rectification of alternating currents, and emission of electron streams from hot bodies in vacuums, supplied the explanation of the action of the Edison two-electrode bulbs and of those constructed by Fleming in 1904: that is, when

the filament is rendered incandescent by current actuating it, the space between the filament and the metal plate, occupied by a rarefied gas, possesses unilateral conductivity, and negative electricity (to use a simple term) passes from the filament to the plate, but not in the opposite direction.

The colloquial term "so what?" was not current in the year 1904; had it been current, it is probable that wireless workers of the time, learning of the Fleming valve, would

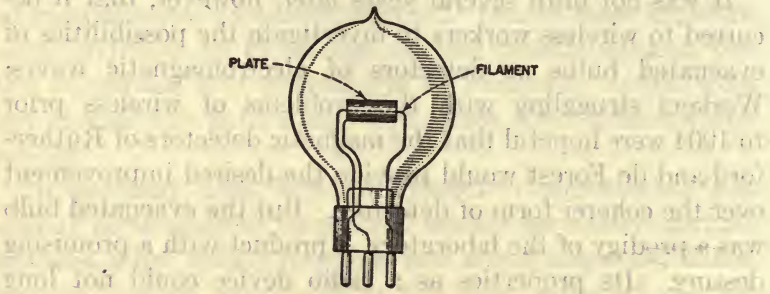

FIG. 13.—The Fleming valve, or two-electrode tube. The filament conductor passes through a tubular plate element.

have been heard to voice it. The valve was a rectifier of alternating currents, similar in action to the electrolytic and crystal detectors. It was no more sensitive than the magnetic detectors then being widely used.

If a bulb so constructed has its filament supplied from a direct-current source and another external circuit is made up connecting the negative side of the filament and the metal plate, the circuit extended through an indicating instrument (galvanometer or headphones) and to an antenna system, by coupling or otherwise, the oscillating current induced in the antenna by incoming waves will be rectified in the gap between filament and plate. The rectified current will then actuate the translating instrument.

Fleming's patent (U.S., No. 803,684, of 1905) for the diode, or two-electrode valve, was basic and throughout the life of the patent it held a key position in the field as a

detector. The Fleming valve was little, if any, more sensitive than the electrolytic and solid detectors, and as a two-electrode detector not many were used, compared to the vast number of crystal detectors employed in radio telegraphy. It was just another form of alternating-current rectifier.

The Audion

In the evolution of the vacuum tube the scene shifts to America, where Lee de Forest had, as early as the year 1900, made observations of conduction through gases, the significance of which was a subject for speculation during the following four or five years. By 1904, de Forest had the tube detector subject well in hand. His patent applications filed in November, 1904, and in January, February, and April, 1905, disclosed tubes with two plates, or "wings" (see Figure 14).

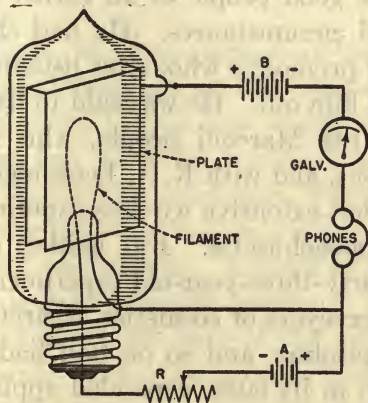

FIG. 14.—The de Forest audion of 1906, with filament and two plates, or "wings," and without grid.

The year 1906, in the United States, was an eventful year. In April the devastating earthquake and fire occurred in San Francisco. The Commercial Pacific cable was extended from the Philippines to China and Japan. The tantalum filament electric lamp was introduced, and

the New York Central Railroad began to electrify its lines out of New York. From Niagara the first long-distance high-tension electric lines were placed in service. And, on December 1, Lee de Forest with jubilant feet strode purposefully into the office of his patent attorney. He had come with a new idea. With pencil he sketched the outlines of a vacuum tube, with the usual filament and plate shown in position, but with a third element now included.

The de Forest tube of 1906 had been called a three-electrode tube, but it had a filament and two plates. The patent application for the three-electrode tube containing a grid between filament and plate was filed on January 29, 1907, and the patent, No. 879,532, issued on February 18, 1908. But the first public announcement of the new tube was made on March 4, 1907.

At the time of making this great invention de Forest was in what the good people of an earlier time modestly called straitened circumstances. He had shown the 1906 tube to financial promoters who, after listening to his story, politely ushered him out. He was said to have sought employment with the Marconi people, who were installing occasional stations, and with R. A. Fessenden, who was engaged in somewhat extensive wireless experimental work at Brant Rock, Massachusetts. But neither concern had a place for the thirty-three-year-old experimenter.

If only the purveyors of cosmetics, cigarettes, cold cures, chewing gum, gasoline, and so on had had an inkling of what the audion in its later, expanded applications was to accomplish in the way of sales promotion, de Forest might have been able to borrow the few hundred dollars necessary to pay the patent expenses.

The name audion was given to the device by C. D. Babcock, one of de Forest's assistants, derived from the Latin verb *audire*, meaning to hear, and *ion* from the Greek *ienai*, meaning to go—a device to make electricity in motion audible.

Controversy Over the Audion

About the time the patent application of 1906 was filed, covering the filament and two-plate form of audion, de Forest presented a paper before the American Institute of Electrical Engineers, New York, following which there was considerable discussion of its principles of operation. Fleming's explanation of the Edison bulb and the two-electrode valve, used as a detector for wireless, was that it performed as a simple rectifier. In describing the principle of the audion, de Forest advanced the theory that there was a relay action having nothing to do with rectification.

A historically inclined student reviewing the mass of literature, trial evidence, and technical discussions bearing upon the theory of the audion, which continued for years after the device appeared, can hardly avoid the conviction that de Forest builded better than he (or anyone else of that day) knew.

Michael I. Pupin, who was present at the reading of the 1906 paper, complained about the employment of Old World language terms to coin new words as names for inventions. There had been the barretter, and the heterodyne, and now the audion. And then, Professor Pupin felt at a loss to account for the audion's action, asking, "Why does it operate?" and stating, "I have no explanation to offer . . . if Dr. de Forest cannot explain it, I certainly cannot." This attitude on the part of the eminent professor was scientific candor of a commendable order. He did not understand how the tube operated and said so. He was of the opinion also that the tube's inventor, de Forest, did not understand why it worked as a detector.

In answer to a question as to whether the claimed relay action of the tube was due to ionization of the residual gas within the bulb or to electrons emitted from the electrodes, de Forest replied: "I think it is due to the ionization of the residual gases; the gases still exist in the lamp,

because the vacuum is only that which obtains in all incandescent lamps."

By the year 1906 considerable had been learned about the emission of electrons from hot bodies, but de Forest may have had in mind that Roentgen rays are able to pass through gases and as they pass through the gas ionize it, splitting up the molecules into positive and negative ions, as stated by J. J. Thomson in 1903. From this reasoning de Forest concluded that Hertzian waves arriving at the audion acted in the same or a similar manner.

Small wonder that the audion of 1906 was not clearly understood. Had it been a sentient thing there is little doubt that it would have been disappointed at its reception among men. On all sides it should have beheld men gazing upon it wonderingly, that's all. It was a new thing. Dudell's oscillograph had been introduced in 1898, but few engineers were familiar with its uses, or had apparatus of this type available for examining the characteristics of vacuum tubes, even in 1906.

In Fleming's use of the valve detector a single battery was employed—the battery supplying current to light the filament. A tap was made from the negative side of this battery, connected through the secondary of the antenna coupler, thence through the translating device and to the plate of the two-electrode tube. De Forest in 1906 applied separate batteries to maintain potentials at the terminals of the enclosed plates.

The disclosures announced in de Forest's 1906 paper before the A.I.E.E., in New York, quickly found their way overseas, where they were subjected to the scrutiny of rivals as well as of well-wishers. Obviously, J. A. Fleming, in England, doubtless with mixed emotions, read the reports with avidity. Shortly thereafter Fleming was in print in London and New York technical journals questioning some of de Forest's claims to invention. De Forest's reply to one of these publications is of importance at this point because it undertook to answer Fleming's criticism,

and because it was written about two months after the presentation of the A.I.E.E. paper—after the discussion and comments in New York had been analyzed.

Writing to the editor of the *Electrical World* (issue of that journal, Dec. 22, 1906), de Forest said:

“In his letter printed in your issue of December 8, Professor Fleming has done me the injustice of expressing an opinion based on an extract only of my paper regarding the audion. In a more complete abstract of that paper in the *Electrician* of London, it is seen that I mention not only the device described by Professor Fleming in 1904, but point out the real genesis of this device by Elster and Geitel in 1882, or eight years prior to its rediscovery by Fleming in 1890. The German investigators were at that early date demonstrating the remarkable unidirectional quality of a gas at low pressure when the cathode is an incandescent wire or filament, and illustrated the exact device employed subsequently by Professor Fleming and myself. However, the figure illustrated in your abstract of my paper clearly shows the local battery in the telephone circuit, which makes all the difference between a possible rectifier of alternating-current of very considerable voltage and a relay or trigger device, whereby the flow of the local current is affected to an extraordinary degree. In one case we have merely a rectifier with a direct-current motor [the galvanometer], which is thus actuated by the energy of the rectified received oscillations themselves—an effect apparent with intensely strong impulses only. The audion, on the other hand when properly connected in a tuning circuit, shows a sensitiveness at least ten to thirty per cent greater than that of the electrolytic receiver using the fine Wollaston anode. The difference which Professor Fleming questions may be tersely stated as that between a few yards and a few hundreds of miles, between a laboratory curiosity and an astonishingly efficient wireless receiver employing the same medium, but operating on a principle different in kind. The differences in the actual phenomena involved in the Elster-Geitel tube and the audion have been described at some length in my paper.

I have been unable to obtain any sign of rectification of high-frequency currents with the device unless their potentials exceed twenty or thirty volts, potentials which of course are impossible

at wireless telegraph receiving stations. In the Wehnelt incandescent cathode valve or rectifying tube [disclosed in 1903] this lower voltage limit to complete rectification is observed. In the audion, however, especially in the bi-wing type, where the oscillations are applied to an independent electrode, there is the exact opposite of the rectification effect observed in a direct-current instrument in series with the battery of the local circuit. When only tolerably strong signals are received, the galvanometer deflection is *reduced*, and that frequently to one-third or one-half of the normal throw. . . ."

In the accumulating literature of the art there was a general recognition of two distinct actions within the tube, depending upon whether the tube was highly exhausted or contained appreciable gas. In the former it was realized that a pure electron discharge occurred between heated filament and cold plate, while in the latter ionization occurred due to collision between the emitted electrons and the ions resident in the contained gas. Years later (in 1915) Irving Langmuir, in America, showed that the current in the plate circuit is limited for a given plate voltage by reason of a *space charge* within the tube. He stated that the electrons flowing between the heated filament and the cold plate constitute a negative electric charge in space which repels the electrons escaping from the filament, causing some of them to return to the filament. Only a portion, therefore, of the electrons emitted from the filament reach the plate; the remainder, being repelled by the electrons in space, return to their source. In the course of time it became practice to use "soft," or gaseous, tubes as detectors and "hard," or highly exhausted, tubes as amplifiers.

But these later refinements were with the three-electrode audion containing a grid in place of one of the two "wings" embodied in the 1906 audion. The insertion of the grid in 1907, after its function was fully understood, was destined to give impetus to extensions of radio telegraphy, make radio telephony practicable, and revolutionize long-distance wire telephony.

Vacuum Tube Development

It was natural that Roentgen's announcements, in 1895, relating to mysterious, penetrating rays which, because their properties were not at first understood, were called "X rays," should send the German savants off into new fields of exploration. At the time Fleming, in England, and de Forest, in the United States, were laying the foundation of the vacuum tube art, R. von Lieben and Eugen Reisz,¹ in Austria, were carrying out experiments with a gas valve containing a form of ionizer based on the discovery of Wehnelt that strongly heated oxides of certain salts, particularly those of calcium and barium, emit electrons at low voltage.

Later forms of the Lieben-Reisz tubes² employed a content of mercury vapor. A rather high e.m.f. was required on the anode, and the tube used was considerably larger than the audion bulb. The German wireless telegraph workers used the tube in a few installations, but the Germans, it would seem, were not as yet alive to the long-distance possibilities of wireless. What they had at hand in the way of electrolytic and solid detectors appeared to be good enough for the short distances attempted. The earliest reference to a German three-electrode vacuum tube was in a communication that appeared under the authorship³ of O. von Baeyer. This described a tube in which the anode (plate) was a cylinder and the cathode a wire placed along its axis. The third, or grid, electrode was in the form of a wire gauze cylinder, mounted between the cathode and anode.

¹ *Philosophical Magazine*, Vol. X, p. 80, 1905

² *Electrician* (London), Vol. LXXII, p. 726, 1914.

³ *Verh. d. Ges.*, Vol. VII, p. 109, 1908.

Physicists in various countries, beginning with O. W. Richardson's application of the electron theory of metallic conduction to the electron emission from heated metals, in 1903,⁴ had new vistas opened to them. New investigations of thermionic currents, and of electron emission phenomena in evacuated tubes were launched; notably by Wehnelt, 1904; Lillienfeld and Soddy, 1908; Fredenhagen, Langmuir, Pring, and Parker, 1912; Pohl, Pringsheim, Porter and Coolidge, 1913; Wiedemann and Hallwachs,⁵ 1914. But the engineers, electricians, and others engaged in devising apparatus betterments and circuit improvements for radio signaling continued from 1907 until 1913, and later, to use the audion as a simple detector and as an amplifier only.

Developments after the Appearance of the Audion

In the textbooks published between 1907 and 1912, a typical explanation of the action of the audion would have been as follows:

The audion is based on the fact that when a filament, plate and grid are sealed in an evacuated glass bulb, a current can pass from the filament to the plate (while the filament is incandescent) but not from the plate to the filament. By connecting a local battery to the plate and filament a flow of electrons is set up which travels from the filament to the plate, and any change or variation in the local battery current will cause a like variation in the volume of electron flow, filament to plate. This phenomena is taken advantage of, in audion circuits, by connecting the receiving antenna to the grid of the tube, to the end that the incoming waves, in response to the dot and dash elements of the Morse code, alternately obstruct and permit to flow, the streams of electrons in the plate circuit which contains the local battery and the translating telephone receiver. These variations in the strength of the current in the telephone actuate its dia-

⁴ *Philosophical Transactions*, 1903, 201, 516.

⁵ For references to the work of these thirteen investigators see *Proceedings, I.R.E.*, September, 1915, pp. 262-266.

phragm in accordance with the signal impulses reaching the antenna.

And in the audion simple detector hookup that is about what takes place, but the audion connected in another manner possesses properties which enable it to do more than that. Up to 1912, the tube contained an undiscovered secret. Discoveries made in 1912-1913 showed that it could be employed as a generator of electric oscillations, and then followed quickly applications of the new principle. These brought in their train terms which in the intervening years have become familiar to radio workers: regeneration, reaction, feedback, tickler, oscillating audion, and so on.

The time was ripe for these discoveries. Workers who were on the trail of the elusive secret were Lee de Forest, E. H. Armstrong, C. V. Logwood, Irving Langmuir, and van Etten, in America; C. S. Franklin and H. J. Round, in England; A. Meissner and G. von Arco, in Germany, and S. von Strauss, in Austria. A year before the announcements of de Forest, Armstrong, and Logwood, a French patent (13,726, of 1911) had been issued to the Austrians Lieben, Reisz, and Strauss, covering the use of three-electrode tubes for amplifying radio signals. In a cascade arrangement the plate circuit of the first tube was connected through the primary of a transformer, the secondary of which was connected to the grid of the second tube. Thus, by amplification, incoming signals were rendered louder than when a single tube was used.

It was a logical conception to replace the telephone receiver in a single tube receiving system with a transformer, the secondary winding of which could be connected to the input circuit of a second tube, but doing this without accurate knowledge of the characteristics and properties of the tube left much to be accomplished in the way of stabilizing circuit performance, which knowledge was to be gained slowly and piecemeal by radio engineers.

Various reasons were advanced to account for the fact that the audion throughout the first five or six years of

its existence was employed to only a limited extent in radio telegraph signaling. Among these reasons were that "wireless" as a commercial utility was given a damaging setback in those years because various stock-jobbing schemes⁶ laid claim to important earnings many years in advance of what was likely to be possible: that the majority of the persons using wireless receivers was made up of boys who were interested as amateur experimenters, to whom the high cost of the early audions acted as a check on sales; that the audion was, as a simple detector, little, if any, more sensitive than the electrolytic and solid detectors, which latter were quite inexpensive; that patent litigation under way or threatening prevented the use of the device by wireless telegraph companies operating many of the ship and shore stations in marine service. The Marconi Company (British), the largest operating concern, was not at liberty to use the audion until more than a decade after its introduction by de Forest.

It was of some significance that the discoveries were made just prior to World War I. The pressing needs of extensive and special communication facilities on land and sea, in the sky, and in submarine operations throughout the conflict accelerated enormously the utilization of the tube for communication purposes.

The transfer of the development of the vacuum tube to the large commercial electrical laboratories in America, about five years after the arrival of de Forest's three-electrode tube, provided, willy-nilly, that leadership in this development should mature in the United States in advance of other countries. The Fleming valve and the first de Forest audion were simply detectors. They were new instrumentalities in about the same sense as Faraday's 1-to-1 ratio transformer of 1831 was new. (It would have

⁶ *Success Magazine*, June and July, 1907, contained a long, illustrated article entitled "The Wireless Telegraph Bubble," by Frank Fayant, which presented a factual, if illuminated, account of some of the early wireless telegraph company promotions.

been a transformer had alternating current been available to operate it.) What Callan, Page, and Ruhmkorff did for the induction coil de Forest did for the vacuum tube receiver by inventing the local, B battery circuit, which at once made the device an amplifier. With a single audion an amplification of 5 was indicated, and with three audions connected in cascade an energy amplification of about 120 times that of the input was obtained, with the tubes on hand prior to 1914.

Following the events of 1912-1914, de Forest was subjected to no little criticism for having nursed the audion through its babyhood and adolescence without earlier discovering the full potentialities of the device. But on this score there should have been many red faces. Some people known to the author have not to this day shaken off the distinction *humilis* come by when others, somewhat suddenly, uncovered the audion's inner secrets. But, then, it should be remembered that during those five relatively sterile years audions were in the hands of many of the world's most advanced scientists, engineers, and experimenters, and the audion was more a listener than talker. An audion of that time is illustrated in Figure 15.

It may be recalled that there was a seven-year hiatus between Hertz's announcement of 1888 and Marconi's achievement of 1895, and that following the young Italian's early demonstration in England several eminent scientists voluntarily accounted for their lack of penetration; all quite plausibly.

The operation of vacuum tubes in cascade, previously mentioned as having been accomplished by de Forest and by German engineers, whereby received wireless telegraph signals were amplified to some extent, was eclipsed by the 1912-1913 inventions of de Forest, Logwood, and Armstrong. The latter, a student at Columbia University, in 1912, had an amateur wireless telegraph outfit at his home, fashioned by himself. Experimenting with receiver circuits, using an audion, he was impressed with the idea

that the incoming radio-frequency oscillations might be boosted in strength by passing back some energy from the plate circuit by means of inductance and capacity. By experiment he demonstrated that some of the signal energy could be "fed back" into the grid circuit, thus producing "regeneration" and, as a consequence, much stronger signals in the headphones.

The notes presented by Armstrong indicated that he came upon the feedback principle in the summer of 1912;

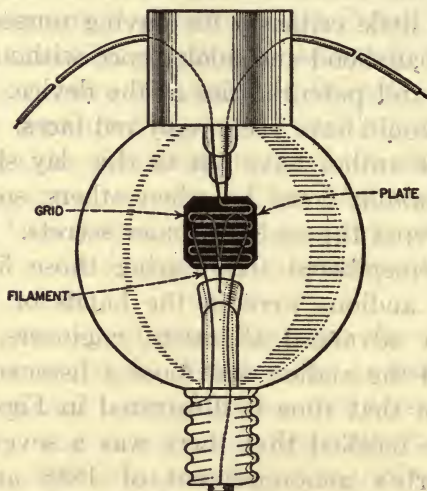

FIG. 15.—Early type of audion, with filament, plate, and grid.

that he had a sketch of his circuit arrangement witnessed on January 31, 1913, and filed an application for a patent on October 29, 1913.

De Forest's records disclosed that the regeneration principle occurred to him on August 6, 1912; that on August 29 of that year demonstrations of its operation were made, and that on April 17, 1913, in his laboratory oscillating audion circuits were in actual operation. Application for a patent covering this invention was filed by de Forest and C. V. Logwood on March 12, 1914. At that time, and

later, Logwood's name did not appear prominently in connection with these important discoveries, but the present writer recalls that it was Logwood who, in the early spring of 1913, gave him the first inkling of the significance of the oscillating properties of the audion. Logwood was a mild-mannered man, modest, almost diffident, and had been denied robust health. He was employed in de Forest's laboratory as an assistant at the time of these discoveries. Of Logwood, de Forest stated: "Logwood's patents, aside from the ultraudion which was a joint patent with myself, were for detail improvements. His genius was outstanding. He possessed an uncanny ability for rapidly diagnosing and solving many intricate radio problems. . . ."

Various legal contests over the validity of patents are on record in which testimony as to the thing, the time, and the person differed sharply. Often the fact as to time is the main issue; that is, priority. And often accuracy as to the nature, the functioning of the thing is a matter of recollection. From that recollection emerges opinion, or belief, as to what a person accomplished, and when. Legal lights and engineer witnesses, trained in prosecuting patent litigation, one group on one side of a case, another group on the other side, often leave learned jurists in a quandary when testimony is all in. The court weighs the evidence of veracity, witness competence, and witness interest, and when a patent case is decided, one side has been convinced that the court was either biased or incompetent to judge.

There is involved always the history of the development of the invention. That history may have been written by more than one person, and the versions may differ materially as to the facts. Emerson wrote that "There is properly no history, only biography." The notes made by or the work recollected by an inventor constitutes biography. And the Emperor Napoleon, when he asserted that history is a fable agreed upon, may have given an explanation of some instances where there appeared to be a heavy preponderance of evidence favorable to one claimant.

Historians of science often are in quandaries. From conflicting claims it is many times impossible to state definitely that the thing and the time are in fact as an interested inventor declares them to have been. But the historian cannot say (and still dispense happiness) as Admiral Schley, in Caribbean waters in 1898, declared: "There is glory enough for all!" That would displease all claimants. No, the historian must perforce, like the court, use his best judgment. A historian is fortunate when he can from his own memory call up evidence upon which his own beliefs are founded. With this he has the assurance of experience.

Armstrong's Discoveries

In the evolution of radio, E. H. Armstrong's contribution to progress bordered on the romantic to the extent that a tinkering amateur, independently, suspected the existence, trailed to its lair and discovered a principle of electrical action which contributed in large measure to the vast radio industry as it exists at the present time. Armstrong was but fifteen years of age when, in 1905, he engaged in amateur wireless experiments, continuing to work with the elementary gear then available. In 1908 he came into possession of a great prize—a Fleming valve, and two or three years later procured a de Forest audion. Thenceforward he made rapid progress. One can imagine the youth pondering over weighty matters, most of them new to science. Doubtless there were times when he had to be dragged away to bed, leaving unsolved a problem that seemed near solution. Armstrong is, or was, a musician of parts. He could play the harmonica. Who knows but that when he arrived at an impasse in his tests he did or did not resort to the sedative, dulcet tones of the tin-cased reeds, the music box which whiskered minions of the Hudson's Bay Company employed to lure prime beaver pelts from the packs of trapper Indians. Mayhap, through the medium of the little harp he soared away on the sprightly

wings of Chopin's Butterfly Etude, or wallowed in the rambling, ponderous lines of the Prague Symphony of Mozart!

Thousands of youths throughout the world were tinkering with wireless in the years before and after 1912. Fathers on innumerable occasions listened to weird reports of sanguine sons relative to "hookups" of their contrivance by means of which it was easy to hear far distant stations "with the phones on the table," while with any other receiver it was necessary to clamp the "phones" close to the ears, and listen "hard."

Occasional freak reception, so called then, undoubtedly played a part in many of these experiences, but the reasons for freak reception were not to be understood clearly until years later when the intense study directed upon the subject by engineers engaged in the investigation of variations in broadcast performance uncovered the truth.

Armstrong was one of those sanguine youths. Although he was at the time taking a college course in electrical engineering, he was, so far as radio is concerned, an attic laboratorian. His accomplishment in 1912 in obtaining loud signals, by means of audion circuits of his own devising, prompted him to tell his father about it with the hope that money would be forthcoming to pay for patent proceedings. Possibly his father had talked with other fathers in his circle, and had been impressed by a peculiar similarity in the tales he had heard with that of reports presented to the others. There was delay in raising the required funds. Here, an invention went begging which was to produce hundreds of millions of dollars for manufacturers, commercial communication companies, and shopkeepers.

This was romance of the only sort that science can know, but young Armstrong probably felt that he was the central figure in a tragedy.

The events of 1913 were somewhat bewildering to radio workers. Commercial radio telegraphy, including ship-

shore service, had been making slow headway. In 1912 the Marconi Wireless Telegraph Company of America acquired the coastal stations and other assets of the United Wireless Telegraph Company. In that year the disastrous loss of that great ship the S.S. *Titanic* (April 15) attracted wide attention to the value of wireless telegraphy on ship-board as a means of saving life when accidents occur. In 1912 a radio international conference was held in London, which approved important regulations looking to uniformity of practice in wireless operations throughout the world.

In the case of wireless, the commercial stagnation that obtained from the early days of the art until the arrival of the oscillating audion and its regenerative uses was at an end. And in August, 1914, the Great War in Europe was begun, which was to have as a by-product, not considered in the calculations, a greatly accelerated development of radio telegraph and radio telephone signaling.

The Audion Defined

In 1914, therefore, there was a pressing need for a clearing up of the situation with regard to the audion. What was its principle of operation? What its possibilities? These and other questions awaited answers in terms understandable to the host of workers, professional and amateur, engaged in radio undertakings. It was Edwin Armstrong who gave the first popular explanation of the properties of the audion and its associated circuits in radio receivers. In the *Electrical World* of December 12, 1914, Armstrong published a paper entitled "Operating Features of the Audion," and at the March 3, 1915, meeting of the Institute of Radio Engineers, in New York, he read a paper captioned "Some Recent Developments in the Audion Receiver."

These papers presented oscillographic examinations of tube characteristics, in which investigation Armstrong was aided by Professor John H. Morecroft, of Columbia Uni-

versity. At that time the Institute of Radio Engineers had been but recently organized and had no rooms or auditorium of its own. The occasional meetings were held in a lecture hall at Columbia University. At the meetings of the institute in 1914 and 1915 foundations were laid for a new industry, for radio history, for noteworthy individual attainment, and for modest fortunes. Radiomen present at those meetings recall vividly the animated arguments, the waving of arms, the shouts, and the battles with chalk on the blackboard. J. H. Morecroft, ebullient, sure of his ground, voiced impatience that everyone present should not at once agree with his conclusions. E. H. Armstrong, ponderous for a young fellow of twenty-five, thoughtful, not unduly exultant, but aware from experimentation of the audion's possibilities, was convincing. Dr. Alfred N. Goldsmith, twenty-seven years of age, but even then suave, gifted, contributed lucid, if engaging, explanations of what all the uproar was about. Other men present who were destined to do notable work in radio included Roy A. Weagant, John Stone Stone, C. V. Logwood, Michael I. Pupin, Lee de Forest, and F. A. Kolster. Also present were Alan Hazeltine, persuasive, calmly deliberative, twenty-eight years of age; J. V. L. Hogan, twenty-five, whose resonant basso voice carried conviction as he wielded the chalk and quoted pertinent formulas; Lloyd Espenschied, twenty-five, sedulous by habit, storing his absorptive mind with the stuff of invention; and David Sarnoff, remarkably aware of what was being discussed for one destined to attain the heights in departments of radio other than engineering. He was then twenty-four years of age.

Reprints of the I.R.E. papers appeared in technical and semitechnical journals in the United States and other countries, so that experimenters were at once enabled to set up radio receiving circuits far surpassing in performance those previously in use.

Armstrong's paper of December, 1914, set forth that the fundamental principle of the audion as detector and ampli-

fier is that, starting with the grid and filament at zero potential difference (no terminal e.m.f. applied to the grid), when a negative charge is imparted to the grid the current flowing in the plate circuit is decreased; and, when a positive e.m.f. is applied to the grid an increase in current strength takes place in the plate circuit.

The audions examined in the oscillographic studies disclosed that the tube is essentially an electron relay; that is, the gas present is exceedingly small, the current flowing from filament to plate being thermionic. And, distinguishing between the action of the tube as a detector and as an amplifier, Armstrong accounted for the detector action as follows:

Since the incoming oscillations are too high in frequency to affect directly the telephone receiver, the audion must be so connected and adjusted that the cumulative effect of a group of oscillations in the grid circuit is translated into a single low-frequency pulse or variation in the telephone [plate circuit] current. This may be done in two ways, one depending on the non-linear form of the operating characteristic of the audion and the other depending on the so-called valve action between hot and cold electrodes at low pressures. . . . The main part of the discharge through the telephone is in the same direction as the current due to the "B" battery, constituting an increase in the current actuating the telephone. As this action is repeated for each group of incoming oscillations, a series of wave trains causes what might be regarded [in its action on the telephone] as an alternating-current in the telephone superposed on the continuous current and having a fundamental frequency equal to the number of wave trains per second.

As an amplifier, assuming that the filament is incandescent and the positive terminal of the B battery is connected to the plate, "an alternating e.m.f. impressed between grid and filament causes variations in the plate current; the positive pulse producing an increase, and the negative pulse a decrease in the plate current."

In Armstrong's paper of September, 1915, the oscillating property of the audion is described thus:

Any repeater, which is also an energy amplifier, may be used to produce continuous oscillations by transferring part of the energy of the circuit containing the battery back to the controlling circuit to keep the latter continuously excited. By providing a close enough coupling between the grid and the plate circuits, sufficient energy is supplied to the grid to keep it in continuous oscillation, and as a consequence thereof oscillations of similar frequency exist in all parts of the system.

The term "feedback," which came into use soon after Armstrong's papers were published, may perhaps be clarified in its significance by considering a receiving circuit in which an audion serves as a detector and as an amplifier. With the incoming signal from the receiving antenna affecting the grid element of the tube, the desire is that the voltage in the grid circuit may obtain reinforcement from the energy in the plate circuit supplied from the B battery. If, then, the plate circuit is inductively or capacitively coupled to the grid circuit, some of the amplified signal voltage in the plate circuit is "fed back" to the grid, in effect producing regeneration of signal energy.

The Audion as an Oscillation Generator

The full significance of the fact that the audion could be associated with other circuit elements so as to produce oscillations for transmission purposes did not at once occur to those who first employed the tube to amplify received signals. The discovery of the amplifying property was a step forward of such measure that the investigators paused to scan the terrain conquered before viewing the ground ahead with the thought of selecting footing for still another leap.

At an Institute of Radio Engineers' meeting in November, 1915, L. W. Austin, while describing the installation of the new naval radio station at Darien, Canal Zone, said

with respect to the receiver used, "The secondary receiving circuit is connected to the grid electrode and to the plate, forming the ultraudion connection."

In the discussion that followed the presentation of this paper there was a craning of necks toward the seat occupied by E. H. Armstrong. Austin's reference to the employment of de Forest's ultraudion assembly it would appear was expected to set off fireworks. But in the remarks made by Armstrong there was a measure of restraint. He said:

Before discussing this paper I would very much like to have a little more information about the operation of the apparatus that Dr. Austin used? I am fairly familiar with the regenerative audion and its use as a self-heterodyne, but nothing seems to have been published about the manner of operation of the so-called "ultraudion." This occasion is the first opportunity I have had for getting some firsthand information about it, so I am going to ask Dr. de Forest if he will not be good enough to explain how it works. In the absence of an explanation by Dr. de Forest, I wish to advance the following explanation: You might expect from the name that there is something super-mysterious about the action of this device, and from the manner in which the ultraudion is drawn in Dr. Austin's paper there is good ground for this belief. But when the circuit is redrawn it becomes at once evident that it is an ordinary regenerative circuit, dependent for its operation on a coupling between grid and wing circuits.

It was perhaps just as well that Dr. de Forest was not present at the meeting. The fireworks were postponed. In his discussion of Austin's paper, contributed later, de Forest stated:

As to replying to any remarks of Mr. Armstrong's, I stated on a former occasion that I must refuse to be drawn into any discussion. However, I wish to point out that it must be obvious to anyone examining circuit 1, of the de Forest-Logwood ultraudion patent 1,170,881, that the ultraudion is not and cannot be a "regenerative circuit." There is only one oscillating circuit. This circuit is such that a sudden change of potential impressed

on the plate of such a character as produces, in its turn, the opposite change of value of potential, etc. Thus, the to-and-fro action is reciprocal and self-sustaining. It is "regenerative" in the sense that a reciprocating engine with piston and slide valve is "regenerative," or in the same sense that an ordinary electric bell or buzzer is regenerative. If any member can obtain comfort from calling the ultraudion circuit "regenerative," he is entirely welcome to do so.

And this was perhaps the first skirmish between interests which were to battle valiantly for years so that lawyers and judges might someday decide why and how the audion in reality operated as a regenerative detector or amplifier, and as an oscillator.

It was not long, however, until the audion was put to work at both ends of radio systems—serving as transmitter and as receiver. It was an astonishing discovery, once the full import of the thing became clear. The brief period between the discovery of the amplifying property of the tube and the promise of transmitting utility is reminiscent of Joseph Henry's discovery in 1842 of the oscillating properties of the condenser discharge. In Henry's time some persons may have inquired "Of what use is this knowledge?" but it was not until forty-five years later that Hertz gave the answer.

It is of interest here to recall the wording of early descriptions of the reaction principle in receivers; that "the ratio of transformation of the transformers should be so adjusted as to get the maximum signal strength without causing the audion to generate oscillations." And then it was shown that the audion has the property of generating oscillations of the same order as those generated by the arc machines of Poulsen and the high-frequency machine generators.

The tubes available in 1913, and the transmitting circuits in which a little later they were tried, permitted of generating potentials of limited power; but it was not long

until improvements were made which raised the status of the tube to its dual role. The names of some of the engineers identified with noteworthy improvements are H. D. Arnold, W. D. Coolidge, A. W. Hull, W. G. Housekeeper, H. J. van der Bijl, W. C. White, and H. J. Round. These men by their inventions made practicable the production of tubes rivaling in output the massive alternators employed in transoceanic radio telegraph service. And for radio telephone purposes the tube oscillator supplied the element previously missing for satisfactory operation.

References to some of the important literature of the subject which followed the pioneer discoveries of de Forest, Logwood, Round, and Meissner, as well as of others, are given in a footnote.⁷

⁷ I. Langmuir, *Proceedings, I.R.E.*, Vol. 3, p. 261, 1915.

W. C. White, *General Electric Review*, September, 1916.

C. V. Logwood, *Electrical World*, Apr. 21, 1917.

Alfred N. Goldsmith, *Wireless Age*, June and July, 1917.

A. W. Hull, *Proceedings, I.R.E.*, February, 1918.

Electric Wave Propagation

It may be well here to summarize the situation with respect to the theories of wave propagation as these had survived the wear and tear of experience up to the year 1925. The exhaustive tests carried out and observations made by United States naval authorities, 1910-1913, under the capable direction of L. W. Austin, on waves longer than 500 meters, brought forth a considerable amount of data of a suggestive nature. Out of these specific observations came the widely respected Austin-Cohen formula for radio transmission, which indicated that the intensity of the received wave fell off more rapidly, as compared with the distance traversed by the wave from its source, than would be indicated by a simple inverse-square law.

Widespread Studies of Wave Propagation

The attack directed upon the problem by several mathematical physicists, for instance, B. J. van der Pol (see *Philosophical Magazine*, Vol. 38, p. 365, 1919), pointed to the probability that with reflected waves the intensity-reduction factor of received waves would be greater than suggested by the Austin-Cohen formula. In Chapter 14, reference is made to Sommerfeld's conception of the processes involved in wave propagation. Twenty years after Sommerfeld, B. Rolf¹ and B. J. van der Pol² modified his theory, and in the course of the passing years it came to be understood that for medium frequencies the ground wave, that is, the direct wave, is predominant during day hours up to a particular distance and that the reflected

¹B. Rolf, "Graphs to Sommerfeld's Attenuation Formula for Radio Waves," *Proceedings, I.R.E.*, Vol. 18, No. 3, pp. 391-402, March, 1930.

²B. J. van der Pol, *C.C.I.R. Document No. 70*, March 31, 1931, prepared by the International Broadcast Union.

sky wave is dominant for longer distances, particularly during night hours, although it is more variable than the ground wave.

But much in the way of penetrating inquiry preceded by many years the Rolf and van der Pol investigations, some of which was drawn upon by later experimenters. In 1912, W. H. Eccles, in England, set up the hypothesis of an elevated reflecting layer so intensely ionized as to prevent any considerable penetration, thus reflecting the waves, aided by ionization of the middle strata of atmosphere, and tending to bend them earthward.

Writing about the progress of radio experimentation prior to the popular introduction of electron physics, the writer believes it would be a digression should this subject be gone into here in detail. The interested student will find in the footnote³ references to technical literature of twenty years ago dealing with the subject of electrons related particularly to electrical engineering.

Assuredly it was a fortuitous circumstance that electric waves were found to be effective in signaling between points on the earth's surface thousands of miles apart and screened from each other by the intervening earth hump. Had it been experienced in the early tests that stations screened from each other by the earth's curvature could not communicate, it would at once have been apparent that all radiated waves traveled only in straight lines through the atmosphere and tangentially out into space.

It was not that nature was niggardly in revealing its secrets. Rather it was that the experimenters perforce had to grope patiently, with the aid of crude, elementary indicating registers until an accumulation of observed effects could be consolidated which might set up a pattern of paths

³L. A. Hazeltine, *Electrical Engineering*, Chap. VII, The MacMillan Company, New York, 1924.

H. J. Ryan, "The Study of Ions and Electrons for Electrical Engineers," *Journal, A.I.E.E.*, September, 1925.

that, when followed, would lead toward unfolding knowledge.

As Sir Oliver Lodge so aptly asserted, in February, 1928:

That ether waves are constrained by the atmosphere to follow the curvature of the earth's surface is an unexpected bonus on the part of Providence, such as is sometimes vouchsafed in furtherance of human effort.

Effect of Ionization in the Upper Atmosphere

To radio engineers in charge of the early operations, impatient for practical results, it may have been sufficient to know that in general the waves follow the surface of the earth as conduction currents or waves gliding along the surface, as waves in the ether residing between the earth and an upper layer of refracting properties, or as a combination of these effects. On the other hand, the research engineer is not a man of prescribed stint; his unsolved problems may be laid aside temporarily, but they may not be shelved until the entire truth is uncovered.

Eccles's renewed investigation of 1912 into the nature of the upper atmosphere, with respect to its wave refracting properties, attracted the attention of investigators in all parts of the world, and the result was that within a decade or so organized research produced a useful amount of observed data which has been of direct value to engineers engaged in establishing and carrying on a variety of radio services.

In the course of the years there had developed general agreement that the ionization in the upper air exists because of high-velocity electrons reaching the atmosphere from the sun. The action of the earth's magnetic field on the electrons was thought to concentrate them in the region of the poles, accompanied by a herding effect toward the dark side of the earth. In England, S. Chapman and E. A. Milne⁴ by calculation concluded that the distribu-

⁴ *Quarterly Journal, Royal Meteorological Society*, Vol. 46, 1920.

tion of ionization, as a result of absorption of high-velocity electrons in the atmosphere, remains at practically zero below a height of 25 miles. From that approximate height up to a distance of $33\frac{1}{2}$ miles above the earth, ionization gradually increases, falling again slightly more gradually to a small value at about 56 miles.

And, in America again, A. Hoyt Taylor, of the United States naval radio, writing in the May, 1924, issue of *QST* said:

The intensity of signals received on these (high) frequencies is so great that I am forced to conclude that these waves do not follow at all the ordinary laws of transmission. To me this would indicate that there is so complete a reflection of these waves at some upper and probably ionized layer of atmosphere. . . .

A critic might say that there was considerable hypothetical reasoning in much of this, that there was guessing. The fact was that about the period 1920 there was urgent need for clarification. Seemingly pushed around (in the ether) to make way for new commercial radio services, the amateur experimenters sought new realms in the higher frequencies, and aware that their signals before arriving at the intended destinations would perambulate about the celestial spheres, it was of first importance that all possible be learned about the aerial routes traversed by the signals.

In England, in 1924, George Larmor presented a concept of the problem which became known as the Eccles-Larmor hypothesis. This held that the wave, having passed the lower atmosphere with some attenuation, traveled in the ionized layer at greater speed than it would in vacuum and that, due to this increase in velocity, the wave bent in conformity with the curvature of the earth.

Recognizing that sunlight produces at least some of the ionization in the refracting region, it appeared important to note that in the dark portion of the earth's surface, at

night, there is a height above the earth where sunlight may be found. For instance, in the neighborhood of New York the vertical distance to that region in the sky, where sunlight prevails at midnight on June 21, assuming no refraction by the atmosphere, is 363 miles. This has a considerable bearing on the variations in effective range of short and long radio waves. In carrying on radio communication between points widely separated on the earth's surface there are occasions when both sending and receiving stations are in a sunlight zone. There are instances where one station is in the dark while the other station is in the light and instances where both stations are in darkness.

In the transmission of waves having a length of approximately 17 meters it appeared to the investigators that sufficient ionization for satisfactory reflection is produced only by sunlight and occurs probably in the neighborhood of 200 miles up, and probably not over 400 miles up. It would appear also that after midnight in the absence of sunlight the ions present in the upper regions may not be sufficient effectively to reflect the shorter waves while still being sufficient to reflect the comparatively longer waves in the region of about 67 to 111 meters. With the latter, signals are strong at night but are greatly reduced in strength when sunlight appears at either the sending or the receiving station.

With respect to the position occupied by the hypothetical Kennelly-Heaviside reflecting layer, it may be said that "height" means the distance above the earth at which in the thin atmosphere the rate of increase in the electron density with height becomes less—the region of maximum electron density.

It was, and still is, an intriguing problem, that of investigating electron distribution in the upper atmosphere, with the thought of determining the heights above the earth at which radio waves are reflected earthward as a result of variations in the electron content (density) of the attenuated air. Radio workers never have been optimistic that

there is anything they can do with respect to controlling the vagaries of the ionosphere, any more than men have ever been able to influence the habits of the troposphere or stratosphere. But by studying the vagaries, the nature, of the various so-called layers extending beyond the earth's ozone layer, it has already been possible to tabulate informative data of great value in determining radio distance ranges for night and day, for seasonal transmission, and for waves of various lengths.

Skip-distance Phenomena

A condition of radio transmission referred to as "skip-distance effect," which for a quarter of a century had puzzled operators of radio circuits, was in 1925 subjected to investigation on a promising scale. This phenomenon refers to the distance from a radio transmitter to the first point at which the reflected wave returns to earth. W. R. G. Baker and C. W. Rice, in America, pointed out that the skip distance for a given wave length is minimum in the middle of the day and maximum on a winter night, the variations being accounted for by alterations in the height, the thickness, and the state of electron density of the refracting area.

Observations on a comprehensive scale by A. Hoyt Taylor, up to 1925, resulted in the compilation of a large amount of data dealing with short-wave working, skip distances, and fading. Classified as reported from a large number of observer stations, these showed that a daytime wave of 30 meters long registered effectively at any distance up to 50 miles, but in some cases at distances between 50 and 500 miles the signals were not in evidence, while at distances between 500 and 1,500 miles the signals again were readable. Shorter waves showed a longer skip. Fifteen-meter waves, for instance, ceased to be audible beyond 10 miles, skipped 1,500 miles, and were again audible at 3,000 miles. This was with daytime transmission from a

5-kilowatt transmitter. This general principle is illustrated in Figure 16.

At nighttime in winter 100-meter waves were heard at distances up to 8,000 miles; 50-meter waves, up to 10,000 miles; while 40-meter waves skipped 500 miles and reached all distances beyond. The 30-meter waves skipped 4,000 miles, 20-meter waves skipped 7,000 miles, and both could be heard at all distances beyond. In general, Taylor noted

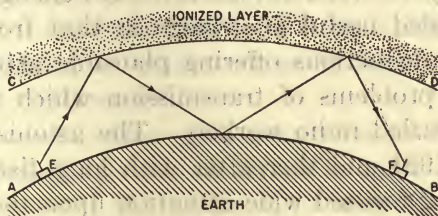

FIG. 16.—Radio waves travel in accordance with the refraction theory. The curved line *AB* represents the surface of the earth and *CD*, the refracting ionized layer at a height above the earth. A wave sent out from a station at *E* may be reflected to and from the earth and the upper layer as it progresses from *E* to *F*, the skip distance depending upon the length of the wave.

that for shorter waves observations indicated better reception in the region extending from the first skip zone to 2,000 miles, than in the region 2,000 to 4,000 miles, where at least one reflection downward to earth was involved; and that from 5,000 to 10,000 miles, short-wave signaling was dependable. This was explained on the basis that with increase of distance naturally a larger number of wave paths are presented, rendering it unimportant should one wave encounter obstruction.

Taylor regarded the skip-distance observations as demonstrating that two portions of the transmitted wave may be differentiated; one following the surface of the earth

and decreasing rapidly in strength until dissipated, while the other travels upward to the refracting region and thence downward to earth having suffered little attenuation. For the broadcast band of frequencies, 220 to 540 meters, receivers situated within a hundred miles of the transmitter are very little affected by variations contributed by the overhead components because the ground wave within that distance is strong.

The important investigations carried on in America, 1924-1927, by H. W. Nichols, J. C. Schelleng, and R. A. Heising afforded useful knowledge in that from these inquiries came deductions offering plausible explanations of some of the problems of transmission which through the years had puzzled radio workers. The astonishing results obtained in 1924 and thereafter with long-distance, short-wave signaling focused wide attention upon the differences in signaling range of waves of various lengths, at night and in daylight hours. Very long waves of the order of 10,000 meters, and short waves of the order of 100 meters, were found to be suitable for long distances, while in daylight hours waves of intermediate lengths had little utility for signaling over long ranges.

From tables worked out by Chapman and Milne, previously referred to, it was shown that for given wave lengths there are heights at which maximum absorption occurs. For 50-meter waves this height was estimated at approximately 40 miles, and for wave lengths of 3,000 to 10,000 meters the level was estimated at approximately 60 miles up. Other investigators charted sky routes differing from these as to reflecting heights for different wave lengths. The eminent Danish engineer, P. O. Pedersen, in 1927, published a review of his own and others' researches into radio transmission phenomena, stating that ultra-violet radiation from the sun is the chief determining factor, although radiation from the stars of very high temperatures also has some influence on the transit of very long waves. Pedersen's correlations indicated that ionization is at its

maximum value at an altitude of about 81 miles (130 kilometers) by day and 100 miles (155 kilometers) at night, with the lower boundary at a height of about 56 miles (90 kilometers).

As Pedersen pointed out, the ray path depends on both the earth angle and the frequency. Long waves, he concluded, will be reflected without severe losses from a height of about 56 to 62 miles (90 to 100 kilometers) even for great earth angles, both electrons and ions being effective in turning the rays earthward. In time, Pedersen's figures were altered to conform with later studies and observations as to the heights at which waves of various lengths are turned back earthward.

In America, the admirable researches of Pickard⁵ into the cause of short-period variations in radio reception disclosed well-defined short-period variations of more than 10 percent amplitude in transmission over a distance as short as seven miles. In this case the direct path from transmitter to receiver was no more than one tenth of the angular path over which reflected waves would have to travel. While observations over a path as short as this may deal with conditions not present in transmission over long distances, Pickard concluded that the principal factor affecting transmission was absorption due to ionization alterations in the atmosphere.

Other American investigators of the time who were industrious in tabulating the results of observations included John L. Reinartz, of the A.R.R.L. staff. In 1925, Reinartz presented an ionized reflecting layer hypothesis to account for the amazing behavior of short waves, particularly the skip-distance phenomenon. And the Carnegie Institute physicists G. Breit and M. A. Tuve concluded from their observations that the ionized layer extends from a height of about 50 miles upward to over 100 miles.

⁵ G. W. Pickard, "Short Period Variations in Radio Reception," *Proceedings, I.R.E.*, December, 1923.

Theories Concerning Fading Signals

In England, in 1925, Appleton and Barnett reported observations indicating that fading was due to the interaction of two sets of waves arriving at the receiver, one set traveling along the surface of the earth, the other reaching the receiver by the angular route upward to the refracting layer and thence downward to earth. When the two waves reach the receiver simultaneously the energies are additive, but when they arrive consecutively, or out of step, there is resulting interference which has the effect of decreasing the energy actuating the receiver. It may be noted that the deductions are similar to those announced by Pickard a year or two earlier.

Nearly a decade before practical radio-telephony was introduced, and while comparatively long waves were being employed for radio telegraph purposes, Lee de Forest⁶ had suggested the probability of the plural path of wave travel between transmitter and receiver as being the cause of nighttime short-period variations in signal strength.

The term "fading" as employed in radio signifies a variation with time of the strength of received signals at a given place, and as pointed out by Nichols and Schelleng, variation with time of the characteristics of the transmitting medium (space) implies that a signal having variable amplitude at a receiving point may result from a signal transmitted originally with constant amplitude and frequency.

Problems of Broadcast Radio Transmission

When, following World War I, radio broadcasting forged to the front, bringing to the engineers new pressing problems, investigations were begun into the nature of electric wave propagation in the broadcast frequencies. In America, Bown, Martin and Potter arrived at the conclusion that the amplitude of received signals is subject to any misfortune which may befall the carrier wave, and that

⁶ *Proceedings, I.R.E.*, Vol. 1, No. 1, 1913.

one way to reduce the fading effect would be to suppress the carrier wave, replacing this with a constant-amplitude carrier at the receiver.⁷

In radiophone broadcasting the transmission of a carrier wave and two sidebands requires on the part of the medium very uniform behavior—an accomplishment sometimes difficult of attainment. The Bown-Martin-Potter investigation brought to light definite indications of selective fading, showing that fading is a function of frequency as well as of time. The fact that oscillographic records obtained by these engineers showed that in the case of broadcast transmission the carrier and sideband signals do not necessarily fade together as a unit led them to conclude that a major cause of fading is wave interference of this nature.

It may seem that in the growth of radio there has been a continuous succession of new terms which have plagued students. Actually, the use of new terms always means that more has been learned about wave transmission and that new discoveries are better understood when they are given distinctive names. In the present narrative of radio, the art's growth has been traced down to about the time of radiophone broadcasting, and it is only now that the terms "carrier" and "sidebands" appear in the nomenclature. These have just been mentioned in connection with the Bown-Martin-Potter paper and concerned the situation wherein a broadcast station put on the air a modulated carrier frequency having two sidebands, each 10 kilocycles wide. The understanding that sidebands were present was not new at the time of the 1925 paper referred to. References to sidebands were made as early as the year 1914, by H. S. Osborne and by C. R. Englund, of New York.

It may be gathered from the foregoing that by 1925, the various problems of radio transmission were being attacked in many countries. In addition to the American and British engineers whose names appear in this chapter as

⁷ Ralph Bown, D. K. Martin, R. K. Potter, "Studies in Radio Broadcast Transmission," presented before I.R.E., November 4, 1925.

being in the forefront of research, in Germany, A. Meissner and G. H. Barkhausen carried on researches which brought much useful knowledge to the surface. Indeed, up to the close of 1927 the state of knowledge of wave propagation for both long and short waves was founded on observational data obtained by these engineers and others. This, in addition to contributions made by amateur experimenters in America, to be referred to in the following chapter.

The popular conception of radio waves (prior to the comparatively recent utilization of microwaves) was that they penetrate solid materials and that, as they travel through space in the form of ether waves, the presence of air in the path presents an obstacle no less transparent to them than are wooden walls or glass windows. Radio waves are Maxwellian, Hertzian, and are electric. While radio wave motion may be set up as an ether phenomenon, progressing outward from an antenna through the atmosphere, the fact that the atmosphere at certain elevations contains clouds of electrons at once establishes the atmosphere in a place of importance as a factor in radio transmission.

The Trend to Shorter Wave Lengths

With engineers patiently groping for the intangible, figuratively peering beyond and aloft toward that which is concealed, the experimental rise in radio becomes literally a project of the conquest of space. Experimenters dispatching aerial messengers (radio signals) far off into the voids charged with the task of bringing back to earth reports of their migrations and their celestial experiences eagerly co-ordinate the answers returned to them. And, if the garnering of the desired knowledge seems to have led over erratic, tortuous courses, necessitating long vigils beside tape recorders and viewing screens or with earphones clamped tight, it is true that the conquest has been the achievement, not of one or two, but of a host of men, all plunging forward from a beachhead established by the physicists Kennelly and Heaviside more than forty years ago.

Long Waves Accepted as Commercial Transmission Medium

In Chapters 4, 9, and 17, the subject of electric wave propagation was carried along somewhat in the order that advancing knowledge made possible. With the transmitting apparatus initially employed by Hertz, wave lengths from 30 centimeters to a few meters were sent out, and in the early demonstrations, where elevated antennas were used, wave lengths of from 300 to 600 meters were employed. In long-distance undertakings the tendency as time went on was to employ much longer waves; in some applications waves 30,000 meters long were employed. On transatlantic radio-telegraph commercial circuits wave lengths of from 12,000 to 20,000 meters have been used

at the high-power coastal stations. In this service, almost from the beginning the large commercial companies favored very long waves between 8,000 and 25,000 meters. A sort of dictum grew up that for satisfactory working twenty-four hours daily, over long distances, a wave length of $\frac{1}{500}$ part of the distance separating the stations would be the most suitable. On the pre-World War I circuit between Nauen, Germany, and Sayville, Long Island, this meant a wave length of 12,000 meters.

In radio there was the advantage that high power could be applied at transmitting stations to overcome distance. When the first transatlantic submarine telegraph cable was laid in 1858, it was ruined as a conductor within a few hours because of the application to it of a voltage considerably in excess of that to which it should have been subjected. Restricted to lower voltages, the cable engineers perforce had to devise more sensitive receiving instruments. But with long-distance radio-telegraph operation, especially when but a few circuits were set up, there was no need for apprehension as to the delicacy of the conducting medium-space. Long-distance commercial telegraphy then became largely a matter of long waves and high-power transmitters, the purpose being to have at the receiver a working margin of signal current above the energy reaching the receiver from extraneous sources; a received-current strength sufficient to maintain a margin despite fading and daylight vicissitudes encountered by the waves in space.

American Amateurs Pioneer the Shorter Wave Lengths

Before resuming the somewhat chronological treatment of the growing knowledge of radio transmission it seems appropriate here to note certain outstanding contributions made by omnipresent amateur experimenters who cultivated a hobby which became an avocation and then a vocation. American amateurs, through the activities of the American Radio Relay League, in co-operation with the radio staff of the Bureau of Standards, Washington, carried

on fading tests through the years immediately following World War I, from which much useful information was derived. In September, 1920, S. Kruse, of the A.R.R.L., delivered a paper before the Radio Club of America, New York, presenting the first report on the fading tests.¹ In this paper the principle was proposed that fading might be due to the production of interference bands in the vicinity of the receiving station by the reflection of the waves from any reflecting surface, such as a cloud or fog bank, the Kennelly-Heaviside layer, or other ionized surfaces, and that variation in such surfaces caused variation in the signals as received.

This concept of the phenomena encountered in operation was followed by a statistical study by C. M. Jansky, Jr., which pointed out that on the 200-meter wave a noticeable decrease in intensity was observed at distances of about 150 miles, with increase again at greater distances. Since the distance varied with the wave length, there was the probability that the decrease was due to ground absorption and that signals received beyond this point were due to propagation along the Kennelly surface.

The astonishingly long ranges of radio telegraph operation reported, beginning in the year 1924, were the result in large measure of the wave-band explorations carried out by American amateurs. For radio-telegraph purposes the amateurs had been allotted a swath in the electromagnetic spectrum represented by wave lengths in the neighborhood of 200 meters. The popularization of radiophone broadcasting, which began in 1920, at once blocked the amateurs' excursions into the regions above 200 meters—if they were to retain standing as law-abiding, live-and-let-live citizens. Vacating the troublesome frontier, the amateurs trekked to regions in space known to be unoccupied by authorized signaling services. Out of their explorations into the bands ranging from 200 down to 5 meters, and lower, came knowl-

¹ Clinton B. De Soto, *Two Hundred Meters Down*, Hartford, Conn., 1936.

edge of the utility of these new communication regions with the result that it was not long until many additional channels were opened for service.

Increasing Demand for Channels Spurs Short-wave Development

Beginning about 1920, owing to the sudden extensive demand for wave lengths for radiophone broadcasting, it became advisable to explore the possibilities of wave lengths shorter than 200 meters, the latter being about as low on the scale as it had until then been necessary to go to provide a sufficient number of channels for the few services inaugurated. Soon it was discovered that much of merit had been neglected, and within a few years highly satisfactory radio-telegraph operation was being maintained over very long distances by the use of waves less than 100 meters in length. Indeed, the scale was explored with good results down to 15 meters, with possibilities of fractional wave lengths.

In the course of the years the advent of vacuum-tube oscillators and amplifiers for receiving systems made practicable the utilization of shorter waves. The availability of transmitting and receiving systems capable of close regulation as to wave length called for the development of a more refined technic of radio, in which the amateur workers contributed a considerable share. They were aided by studies carried out by physicists and engineers identified with radio research. In England, in 1919, C. S. Franklin began experiments with short waves as a particular project, perhaps for the first time presenting data² based on observation, which was informative and which attracted wide attention. Numerous American radio amateurs were actively engaged in these important studies and tests, a few of whom were K. B. Warner, C. D. Tuska, Don C. Wallace, F. H. Schnell, Ross A. Hull, and J. J. Lamb.

From the time of Marconi's early long-distance work

² *Jahrb. Drahtlose Tel.*, Vol. XXI, 1923.

until Franklin's inquiries of 1919 into the properties of short waves, the tendency, as mentioned earlier, was to work toward longer wave lengths, as experience appeared to show that long waves performed more regularly through varying day and night conditions and were less subject to the annoyance of fading. Thus, years before there developed a shortage of channels, the commercial radio-telegraph companies, exercising choice, selected the very long waves for long-distance working.

When radiophone broadcasting stations began to multiply, with rabbit-like fecundity, all these stations had perforce to accommodate themselves to the wavelengths already assigned by national authority to public service, those ranging from 200 to 550 meters. This situation was precipitated in 1921 and for a time resulted in a condition not unlike the confusions of the Tower of Babel.

Engineers who had for years been identified with the development on a large scale of long-wave signaling, in the five years 1922-1927 studied closely the possibilities of the broadcast range of frequencies. In America, 1925-1926, E. F. W. Alexanderson began a study of the behavior of propagated waves from a new angle. In Chapter 9, on the subject of antennas, a description is given of the work of Artom, in Italy, in 1903, with a view to sending out circularly and elliptically polarized waves, a result of which was the development by him, and by Bellini and Tosi, of systems of directive signaling which in time had useful applications.

Assuming that in earth-bound, long-wave technic the transmitted waves are vertically polarized by virtue of the vertical, earthed antenna, it occurred to Alexanderson that, in view of the performances reported in short-wave working, the subject of horizontally polarized waves was worth investigating. By means of square loop radiators mounted vertically and tuned to a wave length of 50 meters, Alexanderson aimed to regulate the phase and direction of the currents so that the composite antenna would produce

unidirectional radiation in the plane of the loop. In a test organized for this purpose, Alexanderson³ discovered that one of the loops by accident had been reversed in connection. Out of this mishap (the only recorded miscalculation ever perpetrated by Dr. Alexanderson) came the discovery that the currents in the vertical sections were in such direction as to neutralize each other; the two top conductors carried current in the same direction, and these latter being horizontal, it was concluded that the very effective radiation observed (as actuating a distant receiver) was horizontally polarized.

Soon, various antenna forms for horizontally polarized radiation were placed in service, the findings indicating that in most cases horizontal transmission and reception with short waves was superior to the older method using vertical polarization.

It is remarkable how, in each new attack on theories of wave propagation, recourse is had to the terminology of optics. The language of A. J. Fresnel, the French optician (1788-1827), used in 1927 to explain theories of Hertzian wave propagation, is either a tribute to the completeness of the French physicist's theories of refraction and polarization in optics (forty years before Clerk Maxwell) or a commentary on the inadequacy of scientific terminology applicable to radio engineering. In using optical terms, particularly polarization, writers dealing with theories of electric wave propagation have to remember the view obtained that the electric field is vertical only near the surface of the earth and that a horizontally polarized magnetic field exists only near the ground.

Practical Recognition of the Importance of Antenna Design

The material gain in knowledge of transmission phenomena, beginning particularly about 1924, included useful information about the practical signaling range of waves

³ "Polarization of Radio Waves," *Journal, A.I.E.E.*, July, 1926.

of various lengths. The theory that very long and very short waves are best for long-distance signaling and that certain intermediate wave bands are limited in their distance-reaching possibilities removed from problems of antenna design some of the engineering details that belonged elsewhere. It may well be realized that from the beginning of the art the thought was ever to the fore that the problems both of transmission and of reception were largely matters of antenna design—the transmitting antenna determining the character of the signal sent out, and the receiving antenna designed to intercept that signal. Throughout the two decades prior to 1924, a continuous attack on the problem was maintained, out of which a large amount of useful data accrued:

Much of the earliest antenna engineering in America was done by John Stone Stone, Oscar C. Roos, and H. E. Hallborg. As was the case in other departments of radio research, the needs of war, following 1914, directed the thoughts of skilled investigators to antenna engineering. Between 1915 and 1923, particularly, antenna engineering of outstanding merit was accomplished by G. W. Pierce, Edward Bennett, Stuart Ballantine, and L. J. Peters, in America. This was the period preceding the intensive study of the possibilities of short waves. In the antenna investigations conducted prior to 1924, objectives were to determine the most efficient design for the range of wave lengths over which the transmitters and receivers of the time were operated.

Edward Bennett, in 1916, in a technical paper discussed the subject of *high* versus *low* antennas, and two years later he presented a paper before the Institute of Radio Engineers entitled "Feasibility of the Low Antenna in Radio Telegraphy." These papers marked a change in the views of some engineers that signaling should improve in dependability if antennas were reared to great heights.

In some of Marconi's early work, before the time when much was known about the true nature of wireless trans-

mission, the Italian inventor investigated the possibilities of directed transmission by means of parabolic reflectors. Metal reflectors were mounted behind, and close to, the sending spark gap, the idea being that the outgoing waves, instead of being dissipated in all directions from the antenna, would travel in a more or less concentrated beam in one desired direction. At that early time, however, no one had managed to contrive a method of accurately producing electric waves short enough for this purpose. During World War I, when the exigencies of war put a premium upon inventive effort, Marconi succeeded in producing waves 2 meters in length by means of a coupled-spark transmitter. With waves of this order and using parabolic reflectors he was reported to have sent out a fairly compact beam effective at a distance of 6 miles. A year later, 1917, in England, Marconi renewed the experiments, employing an improved compressed-air spark-gap transmitter and a 3-meter wave. Effective directive properties were obtained up to a distance of 20 miles.

By the year 1922, vacuum-tube transmitters had been developed in service so that they were practicable, simplifying the process of producing short waves. There was allure in the mechanical appearance of the rather large metallic parabolic reflectors, the brass or copper surfaces highly polished and shining. In early trials of wireless telephony, Marconi engineers used reflectors at both sending and receiving stations, employing 15-meter waves. It was reported that they had obtained fair results up to a distance of nearly 100 miles, and by 1922, Marconi engineers had carried forward directive radio to a stage wherein telegraph signaling was carried on up to a distance of 2,500 miles, using short waves and metallic reflecting screens. It was announced that the transmitting power used was considerably less than when no reflectors were used over the same distances. This form of transmission became known as "beam transmission."

Under the direction of Arthur H. Morse, managing di-

rector of the Canadian Marconi Company, a long-distance beam station for wireless telegraph service was erected at Montreal, Canada, and other similar stations were erected elsewhere in the British dominions. In the specifications of 1924 for beam radio between England and stations in the commonwealths abroad, embraced in what was termed the Imperial Chain, the beam was defined as having a width of 30 degrees, outside of which the strength of radiation was not to exceed 5 per cent of that at the axis.

In modern times the beam system is extensively employed in various services, including that of airplane radio.

Advancing knowledge of radio transmission through space was, throughout the decade prior to 1928, materially aided by recognition of the importance of the meteorological aspects of the subject. This, in addition to methods devised for determining refractive heights and angles, might suggest terming this division of the general subject the "science of catadi-radio," according with the companion terms "catacoustics" and "catadioptics."

The different behavior of short waves from that of long waves and the variety of results with day, night, and seasonal transmission in the course of time produced informative engineering data which served as bases for investigations and explorations into the ultrahigh frequencies, very high frequencies, microwaves, and line-of-sight phenomena.

The Problem of Atmospheric Noise

Just what is static, I would like to know;

They say its thunder, lightning, rain and snow,

But I've a theory I would like to spin:

I think it's just a special kind of sin.

Marconi Service News, 1919.

Wire telegraph lines are subject to disturbances from lightning storms along the route, with resulting signal distortions. But wire-line operating currents usually are strong enough to override all but the very heavy discharges. Other forms of interference with wire operation can be cleared up by the attention of line repairmen. Radio signals coming long distances through the upper reaches of the atmosphere are subject to a multitude of disturbing electrical effects which may continue for hours, making it difficult for receiving operators to discriminate between the intended signals and the parasitic registrations. And there can be no recourse to the ministrations of repairmen. Whatever may be done to thwart the elves of the ether, to render harmless their interfering pranks, must be done at the terminal stations. Nothing can be done to smooth the path aloft over which the message travels.

The problem of excluding from radio receiving systems electrical effects caused particularly by atmospheric electric disturbances has been a part of the business since Marconi's first coherer-operated relay gave out its first click. At the start it was understood that the huge sparks of lightning produced electric waves of various lengths, and it was obvious that these waves would encounter wireless antennas and therein produce currents which would momentarily actuate the instruments.

Practically all the workers in other branches of radio, particularly Stone, de Forest, Pickard, Fessenden and Austin, in America, Braun, in Germany, Brown, in England, and Bellini and Tosi, in Italy, gave continuous thought to the subject of disturbance elimination, or control. In the design of transmitters, receivers, and antenna systems, the thought was ever uppermost that if possible some element should be incorporated which should at least mitigate the nuisance of interference, most of which was charged to atmospherics, or static.

Early Attempts to Eliminate Static

There is warrant only for the presentation of representative ideas advanced for the overcoming of static trouble. A review of the systems tried out in practice discloses trends of thought that keep pace with advancing knowledge of radio transmission. Prior to the advent of radiophone broadcasting in 1920 static interference was the bane of commercial radio telegraph service, army and navy communication, amateur wireless, and experimental work. Soon after broadcasting began, the public in hundreds of thousands learned something about the difficulties experienced by the workers who for twenty-five years had been attempting to establish wireless service of a reliable and accurate character, which would offer an alternative, competing facility. The submarine telegraph cables had been in use across the Atlantic since 1865, and were rendering dependable and rapid service, service that could not be rendered by radio systems, hampered by extraneous interferences that garbled the intended signals.

Following the end of World War I, when the people took back from the armed forces and the government the operation of communication facilities, a heroic attempt was made to devise ways and means of setting up dependable radio service. A patient public, while according a measure of support, had to bear with an inferior radio telegraph service between the United States and other countries.

Up to the year 1916, little of merit had been accomplished in limiting the disturbing effects of static, so far as the long-wave transocean circuits were concerned. The disturbances were most severe in the summer months, and displayed daily variations in intensity, being at a minimum between sunrise and noon, and increasing to a maximum at sunset; from that time forward they remained practically constant until shortly before sunrise. The situation, then, was that from June to October reasonably good reception in America from the continuous-wave high-power stations in England and Germany was possible only between sunrise and noon of each day; during the remainder of the day it varied from poor to impossible.

It may well be understood that unending inquiries, investigations, and surveys were set afoot with a view to learning the nature of parasitic currents and their sources, and of devising ways of suppressing or of reducing interfering manifestations. It had for some years been recognized that static disturbances are of different sorts; they result from a variety of causes. In addition to the effects produced in receiving systems due to local lightning storms, three other types of disturbance were early noted: designated "grinders," "clicks," and "hissing." These terms were used by W. H. Eccles, in England.

In transatlantic working, the grinders were by far the greatest cause of interference with wireless signals. Generally, both grinders and clicks were in evidence, but it was noted that in the summer months when disturbances were at maximum, as grinders increased in violence, the clicks tended to diminish in severity. The hissing sounds were less in evidence, and were discovered to be due to discharges between the antenna and the earth, in grounded systems.

R. A. Fessenden, in America, as early as 1905 introduced a device which it was hoped would be a "bug catcher" for static. He named it an interference preventer; the name imposed a considerable task upon the system. The arrangement consisted in the antenna circuit which extended

to two branches, each coupled to a common secondary circuit, the latter including the detector and the earphones. Each of the primary branches included an adjustable condenser by means of which one of the branch leads to ground could be detuned, with respect to the frequency of the incoming signals. The idea was that in the detuned branch the signaling current would be reduced, but the current due to static would not be materially retarded, and would neutralize or cancel out the current due to static flowing in the opposite leg which was tuned to the frequency of the intended signal. In following years several variations of this form of interference preventer were brought forward by other workers, but the general experience was that "bug traps" set to catch interloping impulses were not sufficiently discriminating, a result being that the desired signals also were reduced in strength, an end not desired.

In England, H. J. Round introduced a "balanced" detector arrangement which had the merit that, at least, limited the upper level of sound produced in the earphones used for telegraphy. A receiving system was designed that would not respond to currents of an intensity much above that developed in the antenna by the incoming signal: currents exceeding in strength those of the intended signals were excluded.

Weagant's Attack

Roy A. Weagant, a graduate of McGill University, Montreal, Canada, after five years with the Fessenden wireless undertaking, entered the service of the American Marconi Company in 1912. Within a few years thereafter, under his direction, a comprehensive survey was made of the nature and cause of static. Although the determinations made by Weagant were the result of experience with waves ranging from 5,000 to 10,000 meters, later checking showed that when shorter waves were employed the results were much the same. It was early learned that currents induced in a radio receiver from atmospheric sources have

a period and damping determined by the electrical constants of the receiver circuits." A receiver adjusted to give maximum response to intended signals was, unfortunately, adjusted to give maximum response to intercepted atmospheric currents!

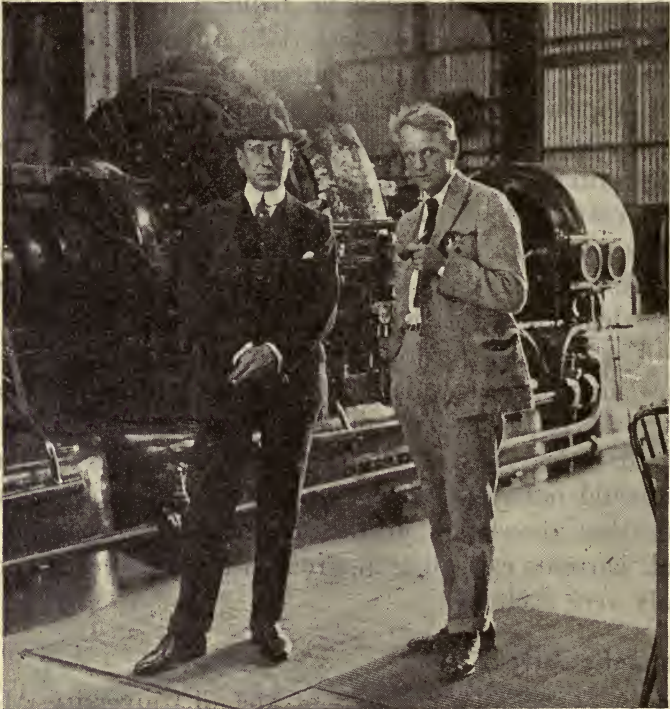

GUGLIELMO MARCONI AND ROY A. WEAGANT

Standing near Alexanderson alternator at Rocky Point, Long Island, New York, transmitting station in 1920. (Courtesy of Radio Corporation of America.)

Weagant's conclusion was that static disturbances of the predominating grinder type behaved as though due to heterogeneously polarized, electromagnetic, highly damped waves, propagated in a direction perpendicular to the earth. Antenna systems designed by him were said to retain a

good working margin of the received antenna current, while largely excluding currents due to static.

The need of the time was for receiving systems that would provide static-free reception of long waves from European stations. As such receiving stations should preferably be erected near the coast, in open country, the needs of dimension of the structure could be made to accord with desired theoretical limitations. For this purpose, Weagant had set up two single-turn loop antennas 400 feet high, each with a base line 1,000 feet long, the centers approximately 5,000 feet apart. The loops were mounted in the same plane and the line connecting them was in a direction toward the sending station in Wales, from which it was intended to receive. The four wires from these large external loops were connected at the station to a selecting system resembling the Pickard and Bellini-Tosi arrangements referred to in Chapter 9.

From test observations Weagant assumed that the grinder noises were caused by electric charges traveling perpendicularly to the earth's surface, either from below or from above the antenna. By employing a mile-long double loop placed in line with the direction of reception he hoped to secure the following advantage: signals arriving at the outlying loop would affect the receiver a fraction of a second before current developed in the loop nearer the receiver, while the currents generated by static charges would be set up in both loops at the same instant. The static currents would thus be in phase, while the e.m.f.s, generated by the signal wave, would be out of phase. The two-loop arrangement aided in reducing the grinder noises, but to reduce the click disturbances Weagant found it necessary to add a third loop in the center. Clicks, it developed, result from horizontally propagated stray currents, not from vertically moving charges.

Experiments in Europe and America

Clearing up the mystery of static was not a simple undertaking to which known electrical engineering principles could be applied. In England, in 1911, H. M. Airy¹ suggested that much of the disturbance originated in the upper atmosphere due to electron arrivals from outer space, and Pickard, in America,² discussed the probable relation between ionization conditions in the upper atmosphere and electric wave phenomena. In long-distance wireless working it was early discovered that not all the disturbances observed in receiving systems originate in lightning discharges. L. W. Austin pointed out that a brilliant lightning flash hardly provides a disturbance twenty miles away. On the other hand, Pickard held to the idea that much of the interference originates in the tropics—in southern lightning discharges, the electric waves thereby created being reflected back and forth between the upper refracting layers and the earth.

The whole problem was baffling in its manifestations. The effects were capricious, elusive. As late as 1919, C. L. Farrand,³ in America, advanced the idea that the origin of static is at the center of the earth, the radial propagation of static charges to the surface of the earth affecting all stations substantially in the same manner.

The attack upon the static problem was widespread. Investigators in most countries maintained continuous watch over its manifestations as noted in radio receiving systems. In Germany, H. G. Moller and M. Bauemler, and in France, H. de Bellecize, were in the forefront of those studying the causes and effects of the undesired impulses. And in America, in 1919, H. H. Beverage, employing a receiving wire nine miles long, noted that signals from Europe gained in strength up to four or five miles along

¹ *Electrician*, Apr. 14, 1911, p. 29.

² Before New England Wireless Society, Dec. 7, 1912.

³ *Proceedings, I.R.E.*, October, 1920, p. 395.

the horizontal antenna, and from that point on the signal strength decreased. He found also that disturbing static effects decreased when the northeast end of the antenna wire was earthed. In this work Beverage was aided by Philip S. Carter.

In some of L. W. Austin's work along this line, reported in 1925, he declared that in Europe about 30 per cent of the disturbance called static originated in lightning storms and that 75 per cent of the parasitic impulses had their seat in rain areas. He observed also that in the United States, along the Atlantic coast, static originates in the southwest, while on the Pacific coast it appears to hale from the mountain country. In midwest America, he noted, disturbances are variable in nature, associated with lightning storms and rain conditions.

In America also, C. W. Hansell and George L. Usselman, in 1925, using a frequency-modulated transmitter, were able to reduce static effects. Two years later, using short waves and frequency modulation, Beverage succeeded in reducing considerably the operating difficulties due to parasitic voltages.

Buried Antennas

The practice of operating radio receivers by current due to a potential difference between an elevated conductor and the earth was based on Marconi's successful early operations and on electrical engineering procedure as applied in wire-line communication. Antennas insulated in space, with one extremity connected to a wave responsive device, directly or by magnetic coupling, the other terminal of the device, or coupler, attached to the earth, comprised an assembly of gear that was understandable in its functioning. However, with the antenna up in the air and plainly in position to intercept all and sundry vagrant electrical effects passing or circulating in its vicinity, it was not likely that the possibilities of the Pickard or the Dieckmann cage arrangement would be overlooked. Nor was it likely

not to occur to some investigator to consider the wave intercepting capability of a bare or an insulated conductor laid upon the surface of the earth, and also of a conductor laid in a trench in the earth's surface one or more feet deep.

Obviously, such a receiving antenna would not gather as much of the energy sent out from a given transmitter as would an elevated antenna erected in the same place but it



E. F. W. ALEXANDERSON

might gather sufficient energy from transmitting stations not too far away to be of use in special applications. And undoubtedly a buried antenna would be less affected by static and other atmospheric disturbances. From one angle it was a case of hiding the antenna away from the trouble-making gremlins that attacked it in free space.

In Germany, as early as 1912, Kiebitz, Mosler, Hausrath, and Braun reported experiments with this very object in view. In America, J. H. Rogers, at the same time or a little later, carried out an elaborate series of experiments to determine the practicability of buried antennas for reception

and transmission. Still earlier, in 1909, George H. Clark, of the United States navy conducted experiments with underwater antennas, but owing to the fact that only the crystal detector, without amplifying accessories, was available as a receiver the results obtained were not entirely convincing.

Rogers, in 1916, had in operation an experimental system of underground antennas at his private radio station at Hyattsville, Maryland. One buried conductor was 1,400 feet long, with the receiver connected at its center. Various other lengths of conductor were tried, and antennas were laid in several directions, and at various depths, from a few inches to several feet. These antennas were studied and experimented with intermittently throughout a period of two years by officers of the navy communication service, and the reports⁴ showed that with such antennas it was possible to receive signals at any wave length, long or short, provided amplifying receivers were used in connection therewith. The underground antenna was found to have directive properties in that signals arriving at right angles to a given conductor, or pair of conductors, were excluded, while signals from a parallel direction were received with sufficient intensity. Disturbances following violent lightning storms were found to have but immaterial effect on the buried antennas. The opinion was that antennas of this type have useful application for army and navy special uses, and for particular short-distance commercial working.

Still another ambitious attempt to develop a receiving system to meet war emergency requirements in World War I, was that devised by E. F. W. Alexanderson, known as the "barrage receiver." The system embraced a bridge type of receiver in association with a highly directional combination of aperiodic antennas, with unilateral directional characteristics, on the principle of the early Pickard

⁴ A. Hoyt Taylor, "Short Wave Transmission and Reception on Ground Wires (Subterranean or Submarine)," *Proceedings, I.R.E.*, August, 1919.

and Bellini-Tosi systems. By means of phase-shifting devices and differential coupling of the associated antennas to a common receiving set, the incoming signals from a given direction were to some extent balanced out. It was with a receiving system of this type that H. H. Beverage,

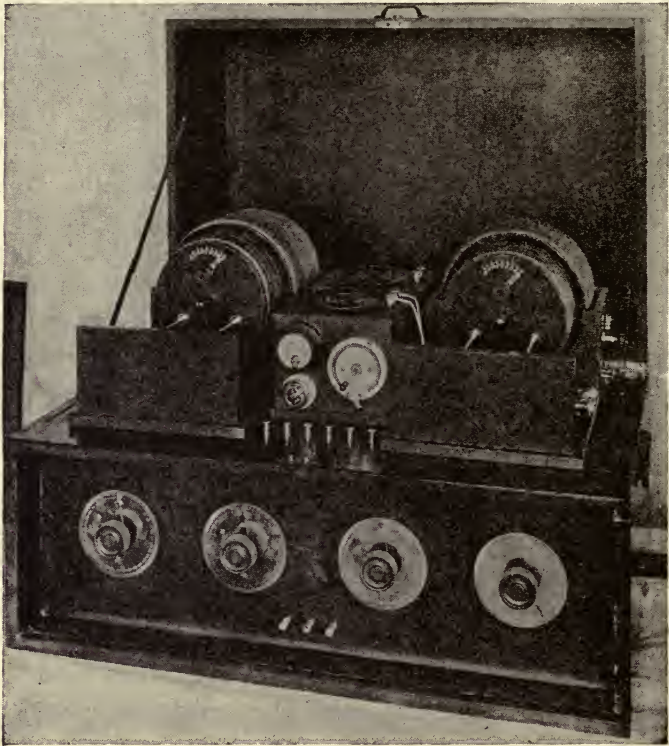

FIG. 17.—An early radio receiver with a "barrage" section, incorporating bridge circuits, and used in connection with directional antennas to reduce objectionable interference.

in 1919, at a Long Island station, studied reception conditions from South American stations.

Naturally, much thought was given to antenna design with the hope that an array might be discovered which would be selective for the desired signals, excluding fre-

quencies higher and lower than that of the signals—whether the undesired waves originated in static sources or in other radio transmitting systems. Antenna systems made up of associated loops and various forms of horizontal, ungrounded elements were for long known to have directional properties, and in later years in the operation of broadcast receivers including efficient amplifying units, loop antennas without earth connection would, it was hoped, exclude various disturbances.

The public's use of radio receivers to intercept broadcast vocal and instrumental entertainment—later OPA rationing and ceiling-price information—largely increased the avenues through which static-producing agencies might project discord into the affairs of families. Radiophone receivers designed for long-distance reception and employing outdoor, elevated antennas are particularly subject to attack from atmospherics, in the same manner as radio telegraph systems.

The Audion Applied to Wire Telephony

The American Telephone and Telegraph Company had for years been engaged in extending the range of talking circuits by wire, and had succeeded in talking direct between New York and Denver. Effort was concentrated upon the ambitious project of establishing talking circuits all the way across America, from New York to San Francisco. Ingenious telephone repeaters of the mechanical and mercury-arc types had been invented and constructed, by means of which it was hoped to greatly extend the range of wire-telephone service.

Oddly enough, it was in the year that the three-element audion was invented by de Forest, that Theodore N. Vail was called back from retirement on his Vermont farm to resume the presidency of the big telephone company. Telephone expansion had been slowing down. The causes of the stagnation may have been quite natural to the time; they may have been a consequence of too rapid growth in particular departments, or the extensive springing up of independent telephone companies may, by competition, have tightened the revenue income.

This was in 1907, and the audion with its vast telephonic possibilities was in existence, not far away, awaiting development and application. To broaden wire-telephone service Vail appeared to entertain the idea that the thing to do was to convert some of the millions of telegrams handled yearly by the telegraph companies into telephone conversations, hoping that would give the answer to falling telephone promotion. Forthwith the American Telephone and Telegraph Company secured control of the Western Union Telegraph Company, and Vail assumed the presi-

dency of that company also. We shall not here review the steps taken to prove this solution of the telephone company's predicament a success or failure. But a plausible case might be presented to show that the telephone folks were so occupied with other matters during the years following 1907 that the audion was overlooked.

The telephone company's engineer historians, in retrospect, have fairly and courageously made acknowledgment of the oversight. Thomas Shaw, writing in the *Bell System Technical Journal*, of October, 1944, of the time situation under consideration, said:

There was, of course, considerable chagrin that these prospects had not been recognized much earlier in the telephone company's research work on repeaters, but no time was wasted in attempts to develop alibis.

A little more than two months after de Forest became aware of the enlarged potentialities of the audion, he set up at the West Street, New York, laboratories of the Western Electric Company an audion assembly to demonstrate the amplifying properties of the tube. That was on October 30 and 31, 1912. H. D. Arnold, of the laboratories' staff, who had been at work on the mercury-arc repeater since January, 1911, on November 1, 1912, was shown the de Forest audion left at the laboratories for study as a likely element of a telephone repeater. Thenceforth telephone history was made, and in the course of a couple of years New York was talking by wire telephony satisfactorily with cities on the Pacific Coast. The telephone company acquired certain rights in the audion which enabled its engineers to go ahead and do the great things they accomplished in making the audion the wonder-working bulb it became.

The Audion's Possibilities Explored

The acquisition by the dominant telephone interests in America of the right to use the de Forest audion as a tele-

phone repeater brought the tube into the laboratories of the company manufacturing telephone equipment. In this well-equipped communication laboratory, staffed with competent and resourceful engineers, beginning in 1913 the audion and its properties and possibilities were subjected to critical study.

The device was examined from the theoretical standpoint by Dr. G. A. Campbell, whose work on loaded telephone lines, years before, had contributed largely to the success of long-distance wire telephony. In the laboratories, in addition to Arnold, there were F. B. Jewett, E. H. Colpitts, H. J. van der Bijl and others, who devised various accessories in the way of circuit elements, including systems of modulation to give approximately undistorted speech, which improvements took definite form by the year 1914.

With the widespread and energetic attack directed upon it, it was not likely that any remaining secrets the audion possessed would long remain undiscovered. The development of the audion telephone repeater prospered so rapidly that, by the latter part of January, 1915, Theodore N. Vail inaugurated telephone wire service between New York and San Francisco.

With respect to radio telephony, a situation which may have had a bearing on the line of research at first followed by the telephone engineers was that, as late as 1915, executives of the company had not been alarmingly impressed by the occasional sallies of enthusiasm proceeding from the laboratories of purely radio organizations.

It may seem justly a matter of wonder that this was the situation, but in a pamphlet issued in 1915 by Theodore N. Vail appeared the paragraphs:

... selection is not secrecy, as any receiver can be adjusted to all lengths and frequencies.

The intensity of these radiations is so great that any large number of sending stations erected near each other would seriously interfere with and confuse each other's outgoing transmission, and even a small number would absolutely destroy the

tenuous incoming vibrations, and all could be destroyed by extremely high tension and high-frequency radiation in close proximity.

And:

The great obstacle to dependable usefulness with commercial possibilities—the causes which confine this great achievement to particular undependable uses—are natural conditions as yet and probably forever uncontrollable.

But the Great War had begun in Europe, and soon vast financial resources were to be made available for the development and carrying out of any promising project which, even though new, might contribute toward preparedness for any eventuality. The engineers were to have wide opportunity.

[The following text is extremely faint and largely illegible, appearing to be bleed-through from the reverse side of the page.]

[The following text is also extremely faint and illegible, likely bleed-through from the reverse side.]

Early Wireless Telephony

With continuous wave arc transmitters and solid rectifier detectors available during the first decade of the twentieth century, and in regular use for wireless telegraphy, it was but natural that the minds of the engineers should turn toward the possibility of transmitting and receiving speech by radio. In considering the possibility of speech transmission it was apparent that the early damped-wave transmitters used for telegraph signaling would be entirely unsuitable for telephony. For telephone transmission a plain requirement was that between transmitter and receiver it would be necessary to set up a continuous stream of radiation, normally constant in wave length, or amplitude, or both. If there were interruptions, these would have to be very rapid if speech was to be transmitted intelligibly. Further, on the stream of radiation it would be necessary to impress, or superimpose, quantitative changes in accordance with acoustic vibrations to be sent out. A receiver would be required which would give, quantitatively, audible indications of these changes in the character of the incoming waves, a function known as modulation.

In early radiophone tests the Poulsen arc and the Fessenden-Alexanderson alternator methods of producing continuous high-frequency oscillations were useful in getting over the first hurdles. Fessenden's liquid barretter appeared to have possibilities as a receiver of modulated continuous waves, as also had the crystal detectors.

Arc Type and Other Early Transmitters

R. A. Fessenden was perhaps the most industrious of the early scientists who directed thought to the problem of space telephony. As early as 1899, Fessenden noted that a

telephone receiver connected to a radio receiving system reproduced faithfully the "tone" of a Wehnelt interrupter actuating the induction coil of a distant transmitter, sending telegraph signals, and it at once occurred to him that by employing a transmitting source having a frequency above audibility radio telephony should be possible.

For Fessenden's use, S. M. Kintner designed an interrupter that was to have a spark frequency of 10,000 per second, and although the frequency turned out to be somewhat less than this, it was reported that speech transmission of a sort was obtained late in the year 1900. During Christmas week of that year speech was transmitted and received between two stations at Cob Point, Maryland, situated about one mile apart. The speech was, as Fessenden related, "poor in quality, but intelligible." This, one should remember, was when the very early demonstrations were being made in wireless telegraph signaling.

Throughout the succeeding three or four years Fessenden worked on methods of producing more suitable high-frequency, sustained oscillations. Compressed nitrogen and compressed neon gas oscillators were tried, also quenched-gap and flywheel types of spark dischargers. In 1904, with a nitrogen gap and a spark frequency of 20,000 per second, it was reported that Fessenden had in some fashion demonstrated radiophone transmission over a range of 25 miles, the articulation being fairly clear.

In the meantime the alternators described in Chapter 8 were coming into use. In 1906 an alternator was employed in speech tests between Brant Rock and Plymouth, Massachusetts, a distance of 11 miles; and in July, 1907, the range of operation had been extended to nearly 200 miles, between Brant Rock, Massachusetts, and Jamaica, Long Island. In December of that year trials were made between Brant Rock and Washington, D.C. There is record also of a test between Brant Rock and a receiving station at Machrihanish, Scotland, when on two occasions the

transmitted speech was received. The distance was about 3,000 miles.

Experience with wireless telegraphy and telephony at Brant Rock showed that with the apparatus available in 1907 the power required for telephony was from five to fifteen times as great as that required for telegraph code signaling, and that for given power telegraphy could be carried on from two to four times as far. It may be imagined that the experimenters were not sticklers for quality of voice transmission. There was marvel enough in what was accomplished.

De Forest also had interested himself in the possibilities of telephony by radio and had set up equipment comprising an arc generator of sustained waves and an audion receiver. In July, 1907, de Forest radiophone equipment was given a trial in reporting the yacht races on Lake Erie, the range extending up to twenty miles. A few months later in that year twenty-six vessels of the United States Pacific fleet were outfitted with de Forest equipment. The de Forest people were optimistic. The navy folks were hopeful, but in any event an opportunity was provided for experimentation from which something was learned.

Abroad, in Germany, it was reported that in December, 1907, the wireless telegraph workers succeeded in transmitting speech from Berlin to Nauen by employing an arc transmitter of the water-cooled flame-arc type with twelve arcs in series.

In early radio telephone work, a main difficulty was that the usual carbon type microphone was unsuited for radio, because of its inability to pass the necessarily large actuating current. To remedy this defect Fessenden designed what he named a "trough" transmitter. It consisted of a soapstone annulus to which were clamped two plates having platinum-iridium electrodes. Through a hole in the center of one plate a rod passed, attached at one end to a diaphragm and at the other to a platinum-iridium spade. The two outside electrodes were water-jacketed. With a tea-

spoonful of carbon granules in the central space this transmitter was said to carry a current of 15 amperes continuously.

Fifteen amperes was a lot of current to have in any kind of microphone, but high power for transmitting purposes was necessary, and at that time there were no amplifiers. There was no way to amplify weak current in the microphone circuit, through several stages up to the antenna power. Even those who in 1907 knew about the audion were not thinking of it as an amplifier. Engineers having the time and ambition to prosecute radio telephone research prior to 1913 had as their main problems: devising microphones which would operate on large current volume; determining the most suitable location in the circuits for the microphone; and providing better means of modulating the radiated waves.

For applying acoustic control of the outgoing radiation some experimenters employed microphones in association with either the sending antenna or the oscillation generator circuit. A microphone could be used in shunt with a part of the antenna inductance, or capacity, or in a separate circuit coupled to the antenna. There was also the possibility that the microphone might be used to modify the supply current to the oscillator, where the arc was employed, or to affect any associated variable element controlling the amplitude of the waves produced. By inserting the microphone in the antenna circuit the alterations of microphone resistance produced by voice vibrations caused approximately corresponding variations in the antenna current and, as a consequence, of the amplitude of the radiated waves.

A really serious, and ambitious, attempt was made by William Dubilier, in 1908-1909, to determine to what extent the radiophone apparatus then available could be used in practice. Dubilier was then but twenty years of age. He was then, as ever since, buoyant, progressive, and ingenious. Demonstrations were made between stations at

Tacoma and Seattle, Washington, a distance of thirty miles. A tower 320 feet in height was used to support the antenna, which was of the construction then known as the umbrella type. A water-cooled arc transmitter was used, and the earth connection was by means of an elaborate system of wire netting buried several feet in the earth. Dubilier profited from experience and from learning, and in following years he was in Russia and in England engaged in wireless emprise on a profitable scale. Later, in America, he was an early demonstrator of the practicability of airplane wireless, following which he engaged in manufacturing, and prospered.

Problems of Modulation

It all was new to the workers. The things that were tried were empirical rather than scientific. With the design of altering the frequency and the amplitude, John Stone connected the microphone in a circuit coupled to the main inductance unit of the oscillation generator circuit. In the coupled circuit the currents were varied by the varying resistance of the microphone, the effective inductance of the coil being thereby varied accordingly. A suggestion was made in 1908 to employ a condenser telephone of the Dolbear type for varying the wave length by altering the capacity of the generating circuits or the antenna.

In this latter arrangement the approach and recession of a conducting diaphragm to and from a fixed conducting plate varied the capacity, and thus affected the potential difference of a conductor in connection with one of the plates and a source of e.m.f., and so was made to affect the resonance of the antenna circuit. Whatever looked good on paper was given a tryout.

In Germany, in 1907, Ernest Ruhmer was on a warm trail when he put forward the idea that if the circuit from a local battery is connected to the microphone, thence to the supply circuit of an arc oscillator, then the arc may be caused to pass to and fro between the oscillatory and

nonoscillatory states in response to changes in resistance of the microphone; the movements of the diaphragm then being translated into periods of radiation and no radiation. As might be looked for, a difficulty experienced was that the transit from oscillatory to nonoscillatory state was hardly quick enough for good results, but in principle the hookup was similar to the application of B battery to the plate circuit of the de Forest audion.

In that same year the German wireless operating organization, in a patent application,¹ proposed a method of operation by means of which alterations in the resistance of the microphone were to produce large fluctuation of the amplitude of the radiated waves. To accomplish this, a strongly excited arc circuit very loosely coupled to the antenna was proposed, and a closed microphone circuit also coupled to the antenna.

Dissemination of Technical Knowledge Aids Progress

If every wireless worker who has advanced claims as being the inventor of radio telephony had a resourceful biographer, and these biographies were published, there is no doubt that a historian would have no choice but to discount much of the writing. When a historian's aim is to select for treatment and description each essential contribution, or one of each type of contribution which survived for a time, or which in turn opened a door beyond which further knowledge of value was waiting, he cannot avoid omitting reference to some of the contemporaneous work done by experimenters in various parts of the world working on the same problems.

And there is no point in ridiculing some of the little steps taken, which in view of present-day knowledge appear to have been elementary and trivial. The present author can from experience assure the reader that in 1907-1908 no worker knew just which direction to take, in order to be first to reach pay dirt. What seemed possible then in the

¹ British patent 26,530 (1907).

way of speech transmission by radio was but experimental in quality. The "mike" of those early years was not sufficiently suggestive of puissance to attract the enthusiasm of the rabble rousers of the time.

A reason for referring at this point to the experiments of A. Frederick Collins, in America, is that the work he carried on qualified him to write knowingly and interestingly about his experiments and those of his contemporaries. The inventor type of investigator was secretive, announcing what he accomplished through publications issued by the patent office. Collins was of a different mold, even though he was more writer than inventor.

In any event, as early as 1902 Collins carried on experiments with crude arc oscillators, and in the years following kept in close touch with what was being accomplished in America and abroad. He maintained a laboratory in New York that enabled him to duplicate what others had done, and to make detail improvements. With radiophone apparatus constructed by him early in 1903,² he tested a service between a shore station and a ferryboat on the Hudson River. There was no need for such service because of the very short distance, and in any event the speech quality was too poor to enlist interest beyond curiosity.

It was Collins's illustrated articles in the technical journals beginning in 1900 that gained for him a wide acquaintance in wireless circles. These articles contained the sort of detailed information awaited by American telegraphers and by the amateur tinkers who had been thrilled by newspaper stories about Marconi's experiments in England. Collins seemed less concerned with the idea of inventing and patenting than with the urge to write about his own experiments and those of other workers. A direct and worth-while result of this was that a nucleus of amateur experimenters in wireless were at that early date provided with descriptive text enabling them to set up equipment for the duplication of experiments performed by the fore-

² *Electrical World and Engineer*, June 20, 1903, p. 1046.

most workers. Undoubtedly Collins's articles on wireless started many of the amateurs and engineers on the road to whatever success they achieved. Collins also established a manufacturing company for the elements of wireless signaling equipment, and many American universities and colleges procured their first wireless apparatus from that source, elementary though it was.

By 1908-1909, wireless telegraphy had come into a considerable amount of world-wide publicity of a favorable character owing to wireless having been instrumental in saving lives at sea when marine disasters occurred. Capitalizing on this assurance of usefulness, some of the experimenters in wireless telephony organized companies to exploit their inventions or improvisations. Collins's associates prevailed upon him to head a wireless telephone concern, and soon stock-selling agents were abroad in the land. It was a time when sellers of stocks were being haled into court, where exploitation enthusiasm quickly evaporated.

European Experiments with Wireless Telephony

It was unlikely that the wireless experimenters in Europe would lag far behind American workers in finding out whether the wireless telegraph gear could not be made to talk. In France, in 1908 and 1909, two French navy lieutenants, Colin and Jeance, carried out a series of interesting experiments between a shore station at Toulon and a station on board a warship, and it was reported that they had succeeded in conversing, with a fair degree of clearness, to a distance of 120 miles. The features of interest were the use of air-core transformers in coupling and microphones in multiple. The microphone assembly was placed in shunt with a section of the antenna coil of an open-core transformer, the primary of which was connected in the oscillation circuit, fed from an arc generator. The voice transmitter consisted of several microphones in multiple mounted compactly on a hollow base. It was thought that in this manner the "packing" of the carbon granules might

be avoided, and at the same time the heat due to the rather large current flowing in the microphone circuit might be distributed throughout the series of carbon chambers. Of course, one mouthpiece served to convey the air waves of sound to the several microphones.

Up in Denmark, about this same time, V. Poulsen, who, as referred to in an earlier chapter, had developed the arc oscillator to a high degree of usefulness, tried out wireless telephony, pretty much along the same lines as the French navy lieutenants, and in Italy, in 1907, Professors Majorana and Vanni brought out a type of telephone transmitter for wireless purposes based upon the capillary properties of fluid jets. A stream of liquid flowing from a suitably constructed opening divided itself into drops that followed each other at practically constant intervals. The frequency could be observed acoustically by allowing the drops to fall on an elastic membrane which then gave out a sound of corresponding frequency. When mechanical oscillations were superimposed on the fluid jet, periodical constrictions could be observed which were of very nearly the same frequency as the superimposed oscillations. The drops thus forced the membrane on which they impinged to give out sounds of a corresponding frequency. Drops falling on a level surface at right angles to their direction formed a layer varying in depth with the frequency of the drops. The microphone consisted of the usual mouthpiece and a membrane fixed to a glass tube which moved freely under the vibrations of the membrane and through which slightly acidulated water flowed.

In this arrangement the liquid passed out of an opening in the glass tube, striking the upper surface of a "collector" consisting of two cylindrical pieces of platinum insulated from each other. On striking the center of the collector the fluid spread over the surface, connecting the two halves electrically. A battery connected in circuit with a telephone and the collector sent a constant current through it so long as the membrane was not affected by sound

waves. When the membrane vibrated, the aperture began to oscillate, varying the flow of the drops so that the fluid on the collector was continually altered in thickness.

It may seem that this was a complicated and delicate mechanism, and so it was, but the Italian workers reported that with this arrangement suitably connected to a spark-gap oscillator the intensity of the spark corresponded with the sound vibrations, thus modulating the outgoing radiation from the antenna.

The Italians, under the aegis of Marconi's initial wireless experiments in Italy, felt that they had the responsibility not only of keeping abreast of wireless advance, but if possible of showing the way. In ancient Rome they built stout engineering works, but what would a Roman engineer have thought had he been told that the time would come when a message could be sent from Rome across the mountains, and Gaul, and the seas to Britain as quickly as he could swallow a dish of Lucrine oysters?

The Search for New Continuous-wave Generators

Remembering that the oscillating properties of the audion were not discovered until 1912-1913, the reader may understand that the engineers working on the problem of wireless telephony throughout the years 1906-1914 had available the high-frequency machine generators and the arc oscillators. Rudolph Goldschmidt,³ at one time chief engineer for the British Westinghouse Company and professor at the technical college at Darmstadt, in the year 1911 invented an ingenious type of machine generator, which was at once a generator and a frequency transformer. Used in radiophone experiments this generator was found to have peculiar merit. Its use was sufficient to control the exciting current by means of one or more microphones, and as the exciting current was a direct current of low voltage, equivalent to only 4 per cent of the total high-

³ *Proceedings, I.R.E.*, March, 1914.

frequency power of the machine, its suitability appeared obvious.

The high cost of machine generators and the rather special and complicated nature of the arc generators were, in those pre-audion years, incentives to the development of simpler means of supplying high-frequency continuous oscillations.

A system that attracted attention in America shortly before the development of the audion oscillator began was that introduced by the Clapp-Eastham Company.⁴ The method used was to charge a condenser by low-frequency alternating voltage about 30,000 times a second, the discharge being divided by means of a rotary sectored gap into definite groups recurring at a rate of about 1,200 per second, the group frequency determining the tone in the receiver—the spark frequency not being noticeable in the headphones. It was called a “Hytone” system of transmission.

In the realm of sustained waves it was found that by using a coupling of about 65 per cent and a well-cooled rotary gap, single impulses could be produced in the gap circuit which would transmit their energy to the oscillating circuit with good efficiency. These impacts occurred so rapidly that the antenna received new energy before its energy absorption had damped out its oscillations, yielding sustained waves.

The advent of the oscillating audion as described in Chapter 16, so far as radio telephony is concerned, ushered in a new era of transmitter development. The audion may be used to generate radio-frequency alternating currents of any desired frequency. Experience with the audion in the early improved receivers, wherein the grid-potential plate-current characteristic indicated that a slight change in the grid potential caused a relatively large variation of the plate-circuit current, was the clue to the discovery of its

⁴ Melville Eastham, “The Hytone Radio Transmitter,” *Proceedings, I.R.E.*, December, 1914.

oscillating properties. Soon it became plain that if a three-electrode tube be connected so as to produce continuous oscillations, and a microphone and battery be connected inductively or conductively to the grid circuit, the grid potential would rise and fall in accordance with the modulations of the human voice, and the amplitude of the radio-frequency carrier wave would be modulated at vocal or other sound frequencies.

It was not all quite so simple as that, and much remained to be accomplished in the way of circuit refinements in order to render radio telephony commercial.

The vacuum tube as a high frequency generator

It is not in the telephone business that we find the first application of the vacuum tube as a high frequency generator. The vacuum tube was first used in the radio industry as a detector and amplifier of radio waves. The vacuum tube was first used in the radio industry as a detector and amplifier of radio waves. The vacuum tube was first used in the radio industry as a detector and amplifier of radio waves.

Vacuum Tubes and Radio-Telephone Transmitters

At this stage of the narrative dealing with the evolution of radio it is not necessary to remind the reader that space had not yet been conquered, notwithstanding what had so far been accomplished. The conquest of space, where radio is concerned, consumed the time extending between the years 1896, and, roughly, 1920. Indeed, following 1920 and to the present time, continuous betterments have been added and the way has been opened for many extensions of radio services. There seems little doubt that improvement will continue, and that at the end of the next quarter century radio workers of that time may view the radio equipment of the year 1946 as having been crude. Nevertheless, when persons who have in their homes even inexpensive radio receivers may in the space of half an hour hear news reports from Chungking, Ankara, Rome, Moscow, London, Paris, Manila, and Sydney, there is warrant for thinking that a deal of space conquering has been going on during the past half century.

The Vacuum Tube as a High-frequency Generator

But to pick up the radiophone transmitter problem where we left that subject in the previous chapter, it may be said that with a vacuum tube employed as the generator of oscillations and another tube serving as the voice modulator an end was seen to all previously used means of setting up radio telephone transmission. The audion bulb for receiving purposes is small in size, but obviously tubes could be constructed having larger dimensions, suitable for generating large currents, and that is what came to pass with surprising rapidity. Tubes were soon available for the

production of high frequencies at high powers, having grid potentials of 150 volts negative, the plate circuit potentials ranging up to 2,000 volts and higher.

In 1913 Meissner, in Germany, and Round, in England, devised radio transmitting systems in which the three-electrode tube was employed to generate the energy to be radiated from the antenna. Round was perhaps the first to apply the tube for this purpose. In the early trials the transmitter (microphone) was connected directly in the antenna circuit. Connected also in the antenna circuit was a glow lamp which gave out full brilliancy when the system had been adjusted to resonance and the desired oscillatory condition established. With this early hookup it was reported at the time that Round had succeeded in telephoning a distance of 50 miles. Later, the microphone was connected to the grid circuit, making possible better control of modulation.

In America, proposals having in view improvement of transmitting circuits were made by Carl Englund, R. A. Heising, Lloyd Espenschied, R. V. L. Hartley, John R. Carson, August Hund, and others. Improvements brought forward by these engineers were of fundamental importance and constituted the bases upon which were designed elements of the dependable radiophone systems of the years following.

By means of a tube oscillator radio telephone system, the American Telephone and Telegraph Company's engineers, in March, 1915, carried on a conversation between a station at Wilmington, Delaware, and a station at Montauk Point, New York, a distance of 300 miles. With equipment developed from these tests the engineers, in the fall of 1915, transmitted speech to Paris, France, and to Honolulu, Hawaii, from the Arlington (near Washington) station of the United States Navy.

This spectacular demonstration of radio telephony, under the press of activity in connection with World War I, at once attracted attention to the possibilities of the system,

and although twelve years were to pass before commercial radio telephony was attempted between America and Europe, there is no doubt that the 1915 demonstrations paved the way in men's thinking for the special applications over shorter distances made during and after the war. In addition to the telephone company's engineers, mentioned as being in on these great accomplishments, the following also participated: E. B. Craft, F. B. Jewett, E. H. Colpitts, H. W. Nichols, L. M. Clement, A. M. Curtis, H. E. Shreeve, H. D. Arnold, N. H. Slaughter, A. A. Oswald, and R. H. Wilson.

One of the outstanding radio developments of the war years 1914-1918 was the improvement made in the design and manufacture of vacuum tubes. The somewhat fragile tubes in use previously were not suitable for war operations in which ruggedness and uniformity in performance were essentials. The experience gained by the telephone company's engineers from 1912 to 1917 in designing tubes suitable for the needs of the telephone wire-line repeater enabled them when the need arose to meet successfully the specifications laid down by the Signal Corps. Dependable and uniform tubes were produced for both transmission and reception uses, by various American manufacturers of tubes. In the first long-distance tests, in 1915, tubes were used with a rating of 25 watts, a complete radiophone transmitter requiring 500 tubes in order to radiate approximately $1\frac{1}{2}$ kilowatts of useful power. Two or three years later tubes of 250 watts rating were being widely used. By the year 1921, water-cooled tubes of 10 kilowatts rating had been produced; in 1923, 20-kilowatt tubes were achieved; and a few years later 100 kilowatt tubes became available.

Seeking to learn the history of radio telephone development it is important to note that the voice was transmitted through space in 1900, by Fessenden, and that in the following six or seven years Fessenden, de Forest, and others mentioned herein had radio telephone systems in

operation in some fashion, employing the arc oscillator and the machine generator of oscillations. Throughout the interim 1907-1914, while no end of experimentation was carried on in various countries, little outstanding progress was made toward radio telephony of commercial quality. The difficulties were, as has been related, that suitable microphones were not procurable, and the methods of voice modulation employed were not such that faithful reproduction was obtained in the receivers. Also, the arc and the alternators were cumbersome, expensive, and ill suited for mobile stations where sources of commercial electric power were not at hand.

The discovery of the oscillating property of the audion largely remedied this situation, and although only war needs from 1915 until the end of 1918 were served by the improved equipment, it is perhaps true that during these four years greater real progress was made than would have taken place in ten or more years of peacetime effort. A result was that shortly after the close of the war the various nations, friends and foes, had in being a great new utility for which many persons supposed no peacetime use existed, but which, differing from the torpedoes and hand grenades developed contemporaneously, contained elements which possibly should make of it an agency for good will, peace and understanding.

Vacuum Tubes as Modulators

With the vacuum tube in hand for the production of sustained oscillations, the subject of the microphone and the problem of improved modulation were presented in a light that made satisfactory solutions plainer and easier. Methods of modulation which came into use during the intensive developments for war needs included the *absorption* method and the Heising *constant-current* method. By means of the method variously referred to as *diverting*, *detuning*, or *absorption* there was effected a reduction in antenna current when the modulator was in operation, to a

value below that obtaining when the modulating voice was not applied, an example of which was the employment of a microphone directly in the oscillating circuit, thus varying its resistance. Or, variously, inductively coupled with the oscillating circuit, or by using a three-electrode tube to absorb energy in its plate circuit, the absorption controlled by speech currents impressed on the grid circuit.

The Heising modulator, in principle variously referred to as nonabsorption, constant current, or power modulation, was characterized by alternate increase and decrease of radiated energy above and below the value produced normally by the oscillator.

Experimental experience soon showed that there were various ways in which the radiated carrier wave of radio telephony could be modulated in order to produce at the distant receiver the sounds impressed on the transmitter microphone. In the radiophone tests from the Arlington naval station, in 1915, previously referred to, the Western Electric Company's engineers who assembled the equipment employed a method of voice modulation due to H. J. van der Bijl,¹ which operated on the principle of amplification control.

A small-size tube operating on a plate potential of 120 volts was used to generate the requisite sustained waves of constant amplitude. The circuit of the microphone was provided with an amplifier so that the signal impressed on the modulator would have an amplitude sufficient to carry the sustained wave over the range of the modulator's control. The modulated radio-frequency current had an outlet by way of a tuned circuit and passed through two stages of amplification, the second stage delivering energy to the antenna. The first amplifier was made up of from 2 to 12 tubes connected in parallel, the number depending upon the number of power oscillator tubes employed. The power amplifier consisted of from 300 to 550 tubes, tuned

¹ United States patent 1,350,752.

circuits being used to pass the radio-frequency wave from the first amplifier to the grids of the power tubes.

A modification of the van der Bijl hookup here described consisted of a modulator tube having two grids instead of the customary single grid, and having the sustained wave from the oscillator supplied to one grid while the signaling frequency was supplied to the other. It was pointed out by Heising² that the action of the two grids with their individual e.m.fs. was approximately the same as that when a single grid was employed, with two e.m.fs. superimposed. The system was known as the *double-grid* modulator.

In this connection it may be noted that radio transmission systems patented by C. V. Logwood³ and E. H. Colpitts,⁴ were based on the principle that the grid of a tube, being a control member, could be employed to control the amplitude of the carrier wave by virtue of signaling frequencies impressed upon it.

Taking up now the constant-potential⁵ system of modulation, it may be said that this consists of a signal amplifier tube in series with a radio-frequency amplifier tube. The former, in a sense, serving as a modulator tube, varies the power supply to the radio-frequency amplifier, according to signal frequencies impressed on the grid of the former. The latter tube with constant radio-frequency e.m.f. applied to its grid converts this modulated power into radio-frequency power, resulting in a modulated carrier wave being delivered directly to the antenna.

The 1915, transocean radiophone trials were carried out with the van der Bijl modulator, but with America's entry into the struggle of World War I, the need arose for radio communication systems for airplane service, and R. A. Heising, who had designed the trial transmitter for transocean tests, at first used the van der Bijl modulator, em-

² R. A. Heising, "Modulation in Radio Telephony," *Proceedings, I.R.E.*, Dec. 1, 1920.

³ United States patent 1,218,195.

⁴ United States patent reissue 14,380.

⁵ United States patent 1,137,315.

ploying three successive stages embodying oscillator, modulator, and amplifier, but the equipment was cumbersome and heavy. Heising had previously procured a patent for the constant-potential modulator and then devised the constant-current modulating system, since universally known as the Heising modulator, employing but two stages. This system was incorporated in the required airplane outfits of

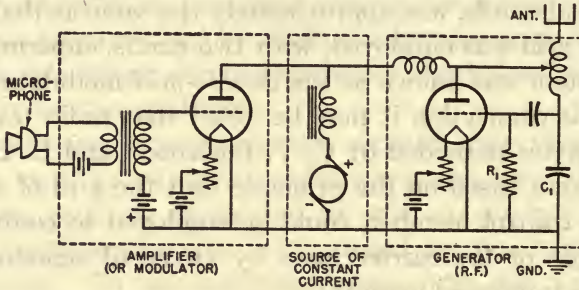

FIG. 18.—Modulator circuit due to R. A. Heising, developed about the time of the transocean radiophone tests of 1915.

1917, and in thousands of sets manufactured for the armed services.

For moderate power two tubes only were required; a voice amplifier and a carrier current generator. The arrangement is shown schematically in Figure 18. At once there was a reduction of required power, weight and bulk, and it may be said that it was the advent of the Heising modulator that ultimately made radio telephone service practicable.

To recapitulate, it may be well to say that modulation in radio telephony was early recognized as referring to the variation at an audio frequency of the amplitude of the sustained constant frequency carrier wave, in accordance with the wave shape representing the speech frequencies. As pointed out by C. C. Culver: ⁶

⁶ *Proceedings, I.R.E.*, October, 1923.

In considering any modulation system there is naturally involved the question of the relative importance of the non-signaling amplitude of the carrier current, and the variation taking place in this due to the modulation brought about at the transmitting station. For a given amplitude of non-signaling carrier wave which may reach a receiving station, the response in the telephone receiver is, of course, proportional to the change in the amplitude of the carrier wave, this in turn depending upon the modulation at the transmitting station. However, the actual amplitude of the carrier current is also an important factor. This is evident when we consider the relation of the amplitude of the non-signaling carrier current to the maximum change which can take place in this current. Even though complete modulation obtains, the current amplitude cannot have a minimum value less than zero or a maximum greater than twice the non-signaling value. . . .

With a view to providing a system of modulation that would not seriously overload the tubes as a result of modulation being applied, and would permit of a smaller total number of tubes required to effect modulation, Culver and Logwood,⁷ independently worked out a grid-leak method. The usual grid-leak resistance was replaced by a three-electrode tube, the plate-to-filament resistance of the tube being controlled by means of voice vibrations through a modulation transformer connected to its grid, the control tube functioning as a variable resistance.

It was a fortuitous circumstance that the full capabilities of the little vacuum tube were bared to American workers almost on the eve of World War I. Under the impetus of the war effort, great forward strides were made in making radio practical.

⁷ United States patent application, filed July 2, 1921; No. 1,440,834.

Radio Receivers

I am all the voices of the earth and the murmur of the multitude merged in one vast articulation.

I am the message from the microphone. I am the conqueror of the void. I am the triumph of the centuries—I am Radio.

—Robert H. Davis

Distinguishing between the detector element of radio receivers and the complete receiver assemblies, it is deemed advisable to deal somewhat chronologically with receivers in a separate chapter. In earlier chapters descriptions of electric wave detectors were presented and the principles of operation outlined; in Chapter 7 the principles of circuit tuning are presented.

In the beginning it was realized that by tuning the transmitting and receiving circuits to the same frequency, greater distances could be covered, and within two or three years following Marconi's first demonstrations other inventors entered the field of radio and the need for *selectivity* was given special attention. Little headway could be made in operating a number of wireless stations in a common area unless a particular sending station could work with a given receiving station without confusion of signals from other transmitters.

So long as the strongly damped wave, induction-coil system of transmission was employed close tuning was not practicable. While in radio service the arc oscillator and machine alternator methods of producing electric waves came into use following 1907, the number of stations employing continuous waves was, until ten years later, small compared to the number using the older system or modifications of it.

The results of the attempts at tuning prior to 1912 were

mainly in the nature of increased distances of operation between given transmitters and given receivers. Remembering that exact methods of determining the frequency of transmitted waves were not in use until after 1920, it may be realized that the waves sent out from antennas throughout the years 1900-1912 occupied a rather wide frequency swath in space, seldom uniform in outline.

So that the historical situation may be clear, it may be well to state here that Marconi, de Forest, Fessenden, Blondel, and other early radio workers were quite aware that receiving antennas erected in the path of transmitted electric waves had set up in them to-and-fro currents, the energy of the currents being the energy of the moving fluxes set up by the passing waves. They understood also that the alternating currents in the antennas were capable of being built up, or successively increased in strength, by the impulses of succeeding waves, provided the receiving circuit was in resonance with the frequency of the incoming waves. Further, it was known that in order to have selective signaling it would be necessary that the receiving antenna and associated apparatus be tuned to the wave length of the transmitter at the distant station. All quite understandable as to theory, but not so easy to work out in practice with the early equipment.

A Review of Early Receivers

The first wireless telegraph receivers, those using the filings coherer as a detector, were simple in design and construction compared to the multitube receivers of later years. In the year 1900, aside from the crude tuning coils inserted in the antenna, a receiving set for wireless telegraphy (it could not have been used for radio telephony) consisted of a coherer, decoherer, telegraph relay, and telegraph sounder or tape register, as shown in Figure 19.

These instruments, together with a few cells of primary battery, made up the outfit necessary to receive telegraph signals through space at distances up to 100 miles or more,

depending upon the power of the transmitter and upon atmospheric conditions.

Prior to 1905 receivers were in use which included antenna loading inductances,

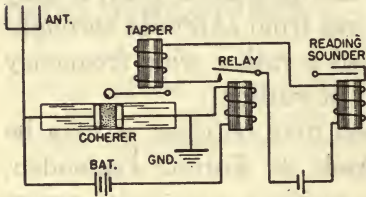

FIG. 19.—Wiring of components in a radio-telegraph receiver employing a coherer as detector. The coil and associated hammer constitute the decoherer.

adjustable tuning coil and a small condenser, while in shunt with the detector, a telephone receiver and local battery in series could be connected.

A typical Fessenden receiver of the time of the barretter, as shown schematically in Figure 20, had an adjustable tuning inductance in series with the antenna and earth connection. Adjustable contacts of the secondary inductance were connected to the terminals of the detector, the lower leg connected through a condenser to avoid short-circuiting the battery through the coil. In shunt with the detector a telephone receiver was connected in series with a potentiometer-shunted local battery.

variable by means of contact arms, also air-core oscillation transformers. The practice was to connect one side of the primary of the coupler (transformer) to a loading coil switch, the other side being connected to earth. The secondary of the coupler was connected in series with the detector, an

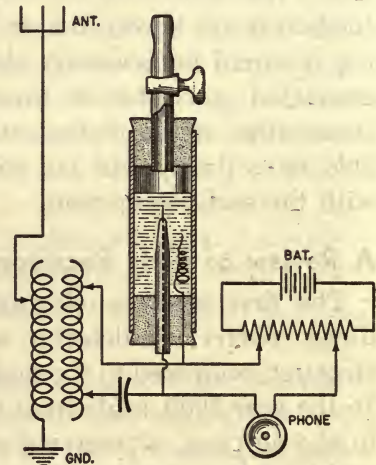

FIG. 20.—Fessenden's liquid barretter detector and associated receiving circuits.

When the electrolytic and crystal detectors followed the

coherer as the *multum in parvo* of receiving devices, almost everyone engaged in experiments tried out differing ways of connecting the detector with the receiving antenna. Although the receiving oscillation transformer had been introduced early the advent of the crystal detector was followed by wide use of single antenna tuning coils connected directly between antenna and ground. The detector terminals were connected to two sliding contacts which

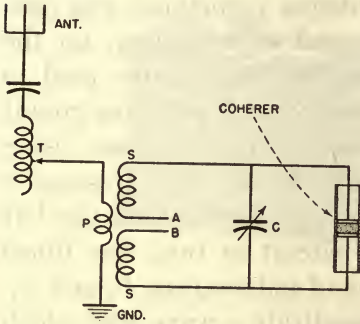

FIG. 21

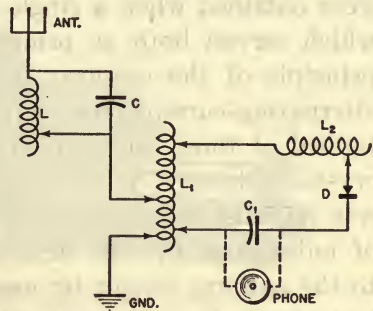

FIG. 22

FIG. 21.—Radio receiving circuit used prior to 1904. The antenna connects through a condenser to a variable inductance T , thence to the primary of an oscillation transformer P , and to ground. The secondary terminals S connect to the coherer, and the mid-point terminals A and B may have additional inductance or capacity connected therewith. A condenser C tunes the secondary circuit.

FIG. 22.—Typical tuned receiving circuit employing a crystal detector D .

could be moved so as to make electrical contact with individual turns of the coil winding. Many attempts were made to set up receiving circuits which distinguished between voltage-operated and current-operated detectors. This led to no end of argument and much talk for talk's sake.

In the oscillation transformer, or coupler, the primary consisted of a few turns of rather large, insulated wire, while the secondary had a larger number of turns of smaller wire, the two being mounted so as to be in inductive relation. With the primary adjustable (as to the number of turns in series with the antenna), the advantage of reso-

nance with the frequency of the intercepted waves was gained, and by virtue of the oscillatory action of the coupler windings, maximum voltage was applied to the terminals of the detector. It was thought also that by giving the antenna current a direct path to ground (see Figure 21), the detector in the secondary circuit would be less subject to disturbances from static sources.

It was found, however, that practically as good results were obtained when a single antenna inductance was used which served both as primary and as secondary, on the principle of the autotransformer or compensator used in alternating-current power applications. A receiving circuit typical of those with which good results were had, using crystal detectors, is illustrated in Figure 22. Resonance was established by adjusting the two contacts on the left of inductance L_1 ; the detector circuit in turn was tuned to the antenna circuit by means of inductances L_1 and L_2 . Inductance L and capacity C constitute a wave trap which may be tuned to eliminate an undesired interfering signal.

There were many variations of this type of receiving circuit and of the forms of tuning coil used from about 1901 until 1912. A difficulty developed when very long waves became popular, in which case the antenna inductance of single-layer construction took on Brobdingnagian dimensions. Often several coils a yard long made up an impressive superstructure mounted above or around a small receiving set.

Improvements in the design of oscillation transformers of the compact, loose-coupler type came into use about 1908 (see Figure 23). And as these were made up with a series of turn taps on both primary and secondary windings and with a rotary or sliding adjustment of coupling between the two windings, the best was accomplished in the way of receiver tuning until such time as radio transmitters employing continuous waves and closely regulated transmitting frequencies came into use.

By the year 1910 the growth of ship-shore wireless traffic

had become such that on many occasions delays and losses resulted, which were charged to station interference. The engineers of the time were stirred into renewed activity in an effort to devise ways and means of operating the increasing number of radio installations with less interference. Forthwith methods were worked out for measuring outgoing and received waves so that there might be knowledge of their dimensions and characteristics. Workers who at that

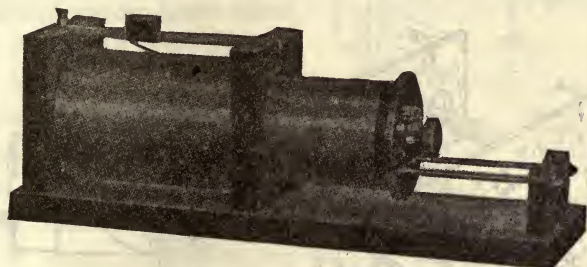

FIG. 23.—Common type of early (1908) loose coupler, with outside primary winding and sliding contact, the secondary winding being movable in and out of the primary and equipped with an end switch for cutting in any number of turns of the secondary winding.

time contributed substantially toward this desirable end included G. Eichorn, Georg Seibt, Frank, and Donitz, in Germany; J. A. Fleming, H. J. Round, and C. C. Moncton, in England; G. W. Pickard, Lee de Forest, J. O. Mauborgne, J. E. Ives, J. A. Murgas, F. A. Kolster, A. S. Blatterman, M. E. Deviny, P. Mertz, and G. W. Pierce, in America.

The situation a year or so prior to the international radio conference held in London, in 1912, with regard to inductively coupled tuners, was that while several types of tuner had been employed not much was known (or had been published) with respect to the interaction of the currents in one of the windings upon the other.

Improved Tuning Principles and Practices

The German engineers had been using a form of coupler that became known as the "doughnut" tuner. Later this

was used at Marconi stations, and by 1909 or 1910 was widely used by amateur experimenters. As illustrated in Figure 24, it consisted of a hollow cylinder of insulating material on which was wound a single layer of No. 22 copper wire. A sliding contact on a rectangular metal rod made it possible to have in circuit any desired number of turns. A coil wound on a cylinder 6 inches in diameter had a wave length up to 1,500 meters. The secondary, or dough-

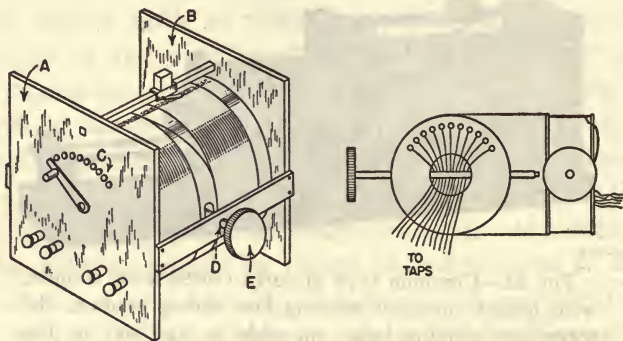

FIG. 24.—“Doughnut” receiving tuner of the period around 1910. *A* and *B* are the retaining ends; *C*, the secondary contact switch; *D*, the adjusting shaft; and *E*, a handle by means of which the coupling between primary and secondary is varied.

nut, winding, mounted within the cylinder on which the primary was placed, was wound with No. 28 wire and had fixed to it a shaft extending out through the primary cylinder so that the coupling relations of primary and secondary might be varied. To facilitate close tuning the secondary winding was tapped every few turns, the taps connecting to contacts over which a switch arm could be moved.

Tuners of this type, known as loose couplers, together with associated variable condensers, were employed in the best of the receiving sets in use in the period 1908-1913. A typical circuit is shown in Figure 25. A receiving set comprised a loose coupler, one or more variable condensers,

a detector, and a pair of headphones. Elementary and simple, but looked upon as wonderful by family visitors privileged to enter attic workshops.

An intelligent attack upon the theory of the inductive coupler was that carried out in 1910-1911 by J. O. Mauborgne, at that time instructor at the army signal school at Fort Leavenworth, Kansas (thirty years later chief signal officer of the United States Army).

Mauborgne found that, with the usual design of inductive coupler, the secondary coil moved beyond the point of maximum coupling in either direction, making two positions of the secondary coil with respect to the primary, where the coefficient of coupling had the same value. The maximum coefficient of coupling existed when the turns of the primary coil, regardless of the number of turns, were so placed that they were exactly over the center of the secondary coil. By computation and experiment Mauborgne showed that varying the coupling of the two coils varied the wave length, and that regardless of what degree of coupling was used the receiver was tuned to two wave lengths at the same time. Out of these studies came useful information relating to "close" coupling, "loose" coupling, and "very loose" coupling.

It seemed clear that, for long waves, increasing the number of turns of the primary in circuit increased the wave length of the tuner; likewise, increasing the coupling increased the wave length, and for long waves the full secondary inductance and large amounts of primary should be used, with close coupling. For short waves, small amounts of primary and secondary inductances and very loose coupling gave best results in receiving.

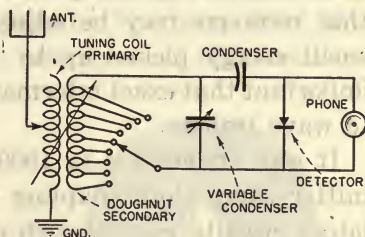

FIG. 25.—Wiring arrangement of a radio receiving circuit employing a doughnut tuner.

Building on these investigations, a year or two later, Mauborgne, assisted by G. W. Pierce and E. R. Cram, published an excellent work on the uses of a wavemeter in wireless telegraphy, which was of immediate value to experimenters. Remembering that a reason for employing wave-length regulating elements in radio receivers is so that receivers may be adjusted to make the most of the small energy picked up by the receiving antenna, it was important that exact information be acquired with reference to wave trains.

It was understood in 1909, and earlier, that in a transmitter using close coupling in the closed and open oscillatory circuits, even though resonance obtained, the station sent out two waves, one greater and the other less than the wave length or frequency to which both circuits were individually tuned. But as late as 1910 there was still doubt as to the nature of the wave emitted by a uniform straight rod oscillator in free space with a spark gap at the center of its length; that is, the natural wave length of a single-wire antenna, freed from encumbrances or artificial loads, and connected to earth.

On this point there existed two schools of thought. H. Abraham, in France, for instance, maintained that the wave length of a free double oscillator was a little over (a few percent) twice its rod length; so that a rod, say 10 meters long, with a small spark gap in the middle, would emit a fundamental wave whose length would be a few centimeters more than 20 meters. The other school, which may be identified by the views of MacDonald, in England, maintained that the wave length was a little over two and one-half times the length of the rod, so that the 10-meter, free double oscillator would emit a fundamental wave length of about 25 meters. J. E. Ives, in America, in 1910, carried out a series of experiments which tended to corroborate the views of Abraham.

It is illuminating to keep in mind the character of the change that took place in radio from the period prior to

1920 when in the amateur field particularly there were approximately as many transmitters as receivers in use—and the ensuing period during which the number of receivers increased, so that there were hundreds of thousands of receivers to each score of transmitters in service.

Returning to the subject of the evolution of the radio receiver, it may be recorded that by the year 1913 the design of variocouplers took on new form, as illustrated in

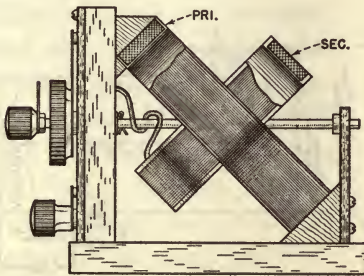

FIG. 26.—Rotary receiving tuner, or variocoupler, of 1913. Both primary and secondary coils are tapped. The inside, secondary coil is rotated by the small knurled knob on the shaft.



FIG. 27. — A typical plug-in "honeycomb" tuning coil.

Figure 26 by the type of coupler introduced, perhaps first, by P. Mertz, in America. This coupler was the forerunner of the highly efficient variocouplers and variometers employed in the broadcast receivers brought out to meet the overwhelming demand created by the exploitation of broadcasting in 1921. This coupler and modifications of it were used also in commercial radio telegraph operation and by thousands of amateur experimenters from its timely introduction, and continued as a favored instrument even in competition with efficient "honeycomb" coils (Figure 27) brought out during World War I, and first introduced by Morton W. Sterns, in America.

Improvements made in the design of inductive couplers following 1913 were, in an important measure, due to analyses carried out by G. W. O. Howe, in England, and F. A. Kolster, in America. The question of distributed capacity in the coil windings, which had been encountered in earlier years, was re-examined by these engineers in a thorough fashion, a result of which was that in time the

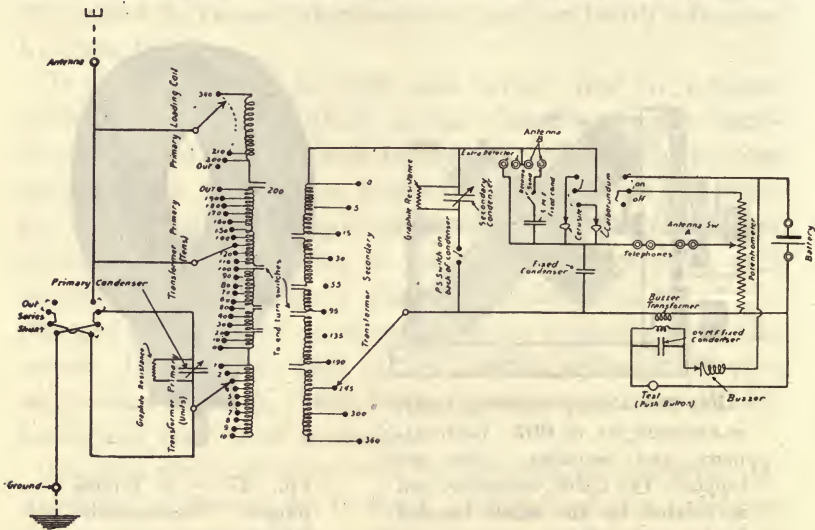

FIG. 28.—Schematic diagram of Marconi receiver of 1913.

coupling units employed were considerably improved in efficiency.

Standard receiving sets manufactured by and issued for service by the Marconi Wireless Telegraph Company of America (later the Radio Corporation of America) in 1913 may be regarded as reflecting the best practice of the time. It may be recorded, however, that at that time the Armstrong regenerative circuit, and the de Forest ultra-audion circuit were just emerging from their chrysalises at Yonkers, New York, and at High Bridge, New York, respectively; and also, that the patent situation was such that the Marconi Company was not yet at liberty to use the audion in

service, and therefore *was* deprived of the advantages of regeneration.

The Marconi receiver was of the two-circuit, inductively coupled type comprising an inductive coupler with variable condenser, coupling controller, blocking condenser, a Carborundum detector, and a cerusite crystal detector. Either crystal could be used as desired. The circuit is shown in Figure 28.

The inductive coupler consisted of a fixed primary and a movable secondary mounted on a rod and controlled in its motion by a flexible metal band passing over a number of pulleys, by which means the coupling could be

varied over a wide range simply by turning a small knob. Both primary and secondary tuning coils were divided into sections connected to the controlling switches in such a way that "dead ends" were avoided. These sets were designed for operation on wave lengths up to 7,000 meters.

Perhaps the most highly developed receiver used by the British Marconi Company, employing the magnetic detector, particularly in ship service through the years before the audion circuits became available to Marconi interests, was the set known as the multiple tuner. In Figure 29, showing the schematic circuits of the multiple tuner, it may be noted that there are three circuits, each distinct: the antenna circuit, an intermediate circuit, and a detector circuit. All these were tuned to the incoming wave length. The antenna circuit had an adjustable inductance *A*, inductive windings *B* and *S*, and a variable condenser *C*, the latter two constituting a wave trap to eliminate undesired signals. The coil *B* induced oscillations in *D* and in *E*,

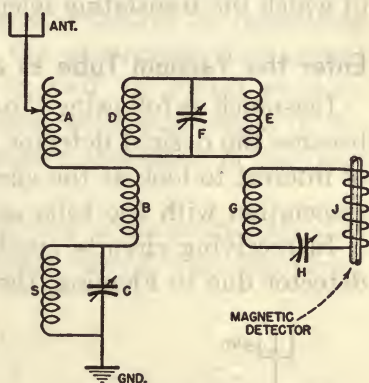

FIG. 29.—Circuit diagram of Marconi multiple tuner designed to improve selectivity.

resonance being obtained by means of the variable condenser F . The detector circuit from coil G included, in series, an adjustable condenser and the primary winding of the magnetic detector (see Figure 10) into the secondary of which the translating telephones were connected.

Enter the Vacuum Tube as a Detector

Inasmuch as following the events of 1912-1913 the audion became the desired detector for use in radio receivers, it is of interest to look at the circuit arrangements employed in association with the tube as time wore on.

In receiving circuits employing the two-electrode valve detector due to Fleming, the valve occupied a place in the

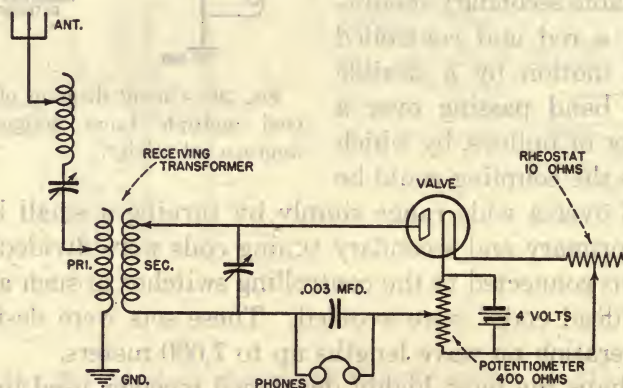

FIG. 30.—Receiving circuit employing the Fleming valve detector.

hookup the same as that given to the crystal detector in receivers using crystals, as indicated in Figure 30. This circuit embodied all the improvements up to that time. It was a shining harbinger of things to come.

The receiving circuit (Figure 31) employed with the de Forest audion of 1906, comprising two plates and a filament, was made up in a somewhat different manner. Here, a B battery was used, in addition to the battery supplying current to heat the filament, and the translating telephones

were connected in the plate circuit. It may be noted that the two plates were connected, a wire from the plates passing to the secondary of the antenna coupler. Actually, the first valve circuits, and the first audion circuits for radio receivers were little, if any, more effective in registering intercepted waves, than were the electrolytic and crystal detector receivers. However, in 1907, de Forest replaced one of the plates by a grid, which at once brought to the audion the wonderful potentialities described in previous chapters.

And, although it was not until five or six years later that the advantage of tuning the plate circuit was discovered,

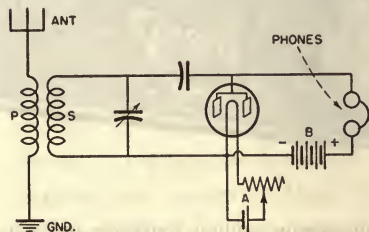

FIG. 31.—Typical audion receiving circuit, 1906.

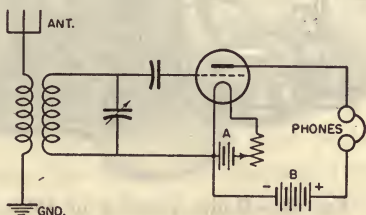

FIG. 32.—Circuit employing the three-electrode audion; patent issued to de Forest, February 18, 1908.

the receivers in which the audion was used as a detector from 1907 until 1913 consisted of unimportant variations of the arrangement shown in Figure 32.

By the year 1913, de Forest had developed receiving circuits which made it possible to employ several stages of amplification, thereby increasing the sound of received signals in the translating telephones. Audion sets were on the market in which the audion served simply as a detector (Figure 33), and sets were constructed embodying a detector and two stages of audio amplification, a bulb employed in each stage.

The early audions in their physical make-up were actually of incandescent lamp manufacture. They were made

by glass-blower lamp manufacturers. With the tubes produced prior to 1912 it was the practice to use a B potential of not more than 50 volts, as it was understood that voltages materially higher than this caused excessive ionization, with attendant tube trouble. The air was exhausted from the bulb to about the same degree as in commercial incan-



FIG. 33.—Radio receiver of 1913, comprising audion detector and contained tuning element, with dead-end switches.

descent lamps. It was not until after the audion's full usefulness came to light that there was immediate need for the application of higher voltage in the plate circuit.

In the earlier audion receiving circuits, in some instances a "stopping" condenser was inserted in series with the wire leading to the grid of the tube. With the low-vacuum tubes available at that time there were sufficient ions in the tube ordinarily to prevent accumulation on the "insulated" grid of a troublesome negative charge, which if permitted to build up would quickly obstruct the flow of current from plate to filament; that is, the current due to the B battery. The condition here under consideration may be understood when it is said that when an incoming wave by way of the receiving antenna reaches the grid of the tube the positive component of the wave passes freely from grid to filament, while the negative component tends simply to pile up a

charge on the grid. With a small condenser in series with the grid, then, upon the termination of a group of incoming oscillations, the charge accumulated on the negative or grid side of the condenser, has no outlet other than by way of the grid itself.

De Forest corrected this difficulty by connecting a high-resistance "leak" circuit around the stopping condenser, of the order of 1 megohm, in this manner providing a way of escape for the negative charges which otherwise would accumulate on the grid element of the tube and make trouble.

Thus the provision of a leakage circuit around the grid condenser effected a material improvement in the operation of receiving circuits in which tubes were employed. The de Forest audion detector and three-stage receivers described in December, 1913,¹ embodied the ultraudion arrangement,² in which the grid-leak resistance appeared. In this circuit arrangement shown in Figure 34 there was no regeneration control other than the filament rheostat, the tube oscillating over a rather broad band of frequencies. Tuning was accomplished by varying the turns of antenna inductance and by adjusting the variable condenser. The receiver was quite critical as to filament current, which had to be just right for the best results.

Improvements in the design and construction of variocoupler units had fortunately kept pace with the expanding sphere of the audion, so that when the regenerative, feedback circuit came into use there were at hand efficient variocouplers, and also modifications of the coupler called variometers. The latter comprised two short cylindrical coils with the inner and smaller diameter coil pivotally mounted within the larger, stationary coil. The inner coil was connected in series with the outer one and could be rotated about its axis through 180 degrees. Properly connected as to the direction of the respective windings, in one posi-

¹ *Proceedings, I.R.E.*, March, 1914.

² *Electrical World and Engineer*, Feb. 20, 1915.

tion with opposing magnetic fields the inductance was at approximately zero value, while by altering the position relation of the coils the inductance was increased as required in tuning.

Chapter 16, dealing with tube development, presents significant dates bearing upon the discovery of the audion's long-held secrets. The discovery was of such vast importance to a budding industry that the closeness of Armstrong's disclosures to those of de Forest was certain to precipitate a legal contest. For nearly a score of years lawyers, stenographers, and court staffs waxed prosperous while the battle

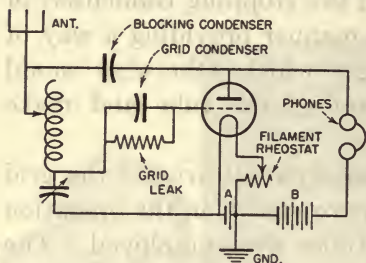

FIG. 34.—Ultraudion circuit of 1913.

ebbed and flowed. And then, ultimately, de Forest was awarded priority for the feedback invention.

The discovery of the regenerative and oscillating properties of the audion and of the significance of tuning the plate circuit opened the way for the design of receiving circuits far surpassing in usefulness any circuit arrangement previously employed.

In addition to the momentous steps immediately taken in America and England to apply the discoveries to practice, the physicists and engineers on the Continent were not slothful in devising improved systems of reception based on the tube's full powers. In Germany, A. Meissner, in March, 1913, experimented with a tube oscillating circuit, and on December 12, 1912, Siegmund Strauss, in Austria, applied for a patent to cover the design of a tube oscillator. It is a marvelous thing how momentous truths circulate simultaneously, almost, in places far apart!

In France a number of experimenters soon were in the forefront of the headlong advance toward the day of more sensitive and more selective radio receivers. Among these

latter were Lucien Lévy, Marius C. A. Latour, H. Abraham, M. Goulton, Captain Metz, and Lieutenants Brillouin and Manescau.

It was unavoidable that from this point forward there was to be a deal of duplicate effort and of achievement. Many of the advances made in one country were almost simultaneously duplicated in other countries. It was probably the same with submarines, warplanes and bombs! However, the evolution of the multitube receiver may be traced by noting the successive steps taken in America from the time of the discovery of the regeneration principle.



The diagram illustrates a circuit for a multitube receiver, showing the connection between the power source, the variable capacitor, the vacuum tube, and the transformer.

In the early days of radio, the vacuum tube was the only device that could amplify a signal. The vacuum tube was a glass envelope containing a vacuum and a few electrodes. The vacuum tube was the heart of the radio receiver, and it was the vacuum tube that made it possible to receive and amplify a signal from a distant station.

Regenerative Receivers

One great blessing which American students and experimenters have had has been that organizations of a scientific, technical, and semitechnical nature have been open to them. The periodic meetings of these associations have presented opportunity for inventors and engineers to explain and describe their inventions and opportunity for students to pick up firsthand information about what is to the fore from time to time. The Radio Club of America, Incorporated, of New York, is one of these valued associations. In the year 1915, George E. Burghard was president and Louis G. Pacent was vice president. It was before the members of this club that in April, 1915, E. H. Armstrong appeared to talk about the regenerative circuit.

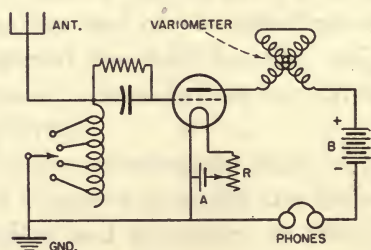

FIG. 35.—Schematic diagram of early single-circuit regenerative receiver. The variometer controlled the amount of regeneration.

In the regenerative receiver, as then presented, a single adjustable antenna inductance was employed for antenna tuning. A typical circuit hookup is illustrated in Figure 35. Regeneration was accomplished by connecting a variometer in the plate circuit, thereby producing amplification

of the loudness of signals heard in the headphones. A single-circuit regenerative receiver also was provided by connecting a "tickler," or feedback, coil in the plate circuit of the tube (in the manner illustrated in the two-circuit receiver of Figure 36A) instead of using a variometer in the plate circuit.

In two-circuit receivers, illustrated in Figure 36A, it may be noted that the antenna had a direct circuit to

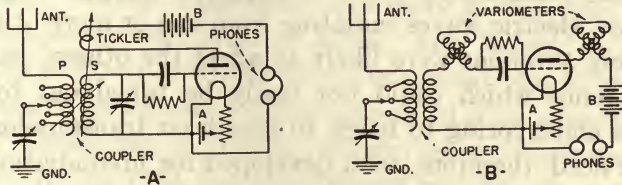

FIG. 36.—Diagrams of two early two-circuit regenerative receivers. In the circuit on the left the amount of regeneration is controlled by varying the coupling between the tickler and secondary coils.

ground through the primary of a variocoupler and a variable condenser, while the secondary coil of the coupler also had a variable condenser associated with it for the purpose of tuning it to the incoming frequency as set up in the tuned antenna circuit. Important elements of improved design (also shown in Figure 35) were the comparatively high resistance leak from the grid, associated with a grid condenser. Regeneration was accomplished by mounting a third (tickler) coil close enough to the primary and secondary coils to be in inductive relation therewith. Honeycomb coils admirably answered the requirements for primary, secondary, and tickler, as three of these units, each properly wound for its purpose, could be conveniently mounted on a compact rack. Instead of using a tickler coil to produce regeneration of signal strength and a variable condenser for tuning the grid circuit, two variometers were sometimes employed, one in the plate circuit and one in the grid circuit, as shown in circuit B, Figure 36.

Several of the regenerative circuits early in service em-

bodied no provision for avoiding reradiation into space by way of receiving antennas acting as sending antennas. The inclusion of an audion in a receiving circuit, an audion which under certain conditions generates oscillations, was not a menace to neighborhood comity until receiving antennas multiplied by the hundred thousands for the purpose of picking up any sort of information and entertainment from the early broadcast stations. With several receiving antennas mounted on one housetop, or in an ordinary-size back lot, electric waves radiating from one or more of these receiving antennas were likely to affect the others, causing interference which could not easily be tuned out by set owners endeavoring to listen to broadcast transmission.

The need, therefore, soon developed for nonradiating receivers, but as hundreds of thousands of the offending sets had been installed by eager purchasers, naturally a considerable length of time was to elapse before replacements were made. The "radiating" receivers caused mysterious "howls" in neighborhood receiving sets, and when the cause of the annoyance became known a campaign of education was launched which to some extent mitigated the evil. It was learned that care had to be taken in the adjustment of the feedback coupling. If this was too "close," the least disturbance in the plate circuit caused the grid, by its control action, to maintain the changed conditions, setting up undesired oscillations which had a mischiefmaking outlet by way of the elevated antenna. It was learned also that for best receiving results it was necessary that the detector tube circuits be adjusted so that the oscillation state was not quite reached. By loosening the tickler adjustment and by maintaining the filament current at a strength just sufficient to give the best possible reception, the tendency of sets of this type to radiate was reduced.

Radio-frequency Amplification

In the early regenerative feedback and ultraudion receivers the incoming antenna currents were amplified and

rectified, in the detector tube, then passed on to audio-amplification stages. It was natural that engineers engaged in developing improved receivers should sense that the radio-frequency currents oscillating in the antenna circuit in response to incoming waves might be amplified, or "boosted," so that in the case of very weak incoming waves the energy passed to the detector tube would be considerably increased in strength.

Abroad, German engineers were early in the field with radio-frequency amplification ideas. Von Bronk¹ in 1911 invented a circuit in which the plate current of a tube was, by means of an air-core coupler, associated with a secondary circuit containing a crystal detector and telephone receiver. And in 1913, Schloemilch and von Bronk procured a patent² covering a receiving system in which a radio-frequency tube was followed by a crystal detector and an audio-frequency tube circuit. A modification showed a single tube serving both as a radio-frequency amplifier and as an audio-frequency amplifier, and a crystal employed as a detector. In later years this arrangement was the basis of various ingenious hookups called *reflex* circuits.

In America in 1913, Alexanderson³ invented a multistage radio-frequency amplifier, comprising two stages of radio-frequency amplification followed by a tube detector, the radio-frequency stages being transformer-coupled, and the grid or secondary circuits tuned. About the same time, Langmuir applied for a patent⁴ covering a receiver system comprising two stages of radio-frequency amplification, a tube detector with grid-leak rectification, and one stage of audio-frequency amplification. The grid-leak function here referred to was distinct from the high-resistance grid leak in series with the grid of a tube, first shown in circuits by

¹ British patent 8,821 (1913).

² United States patent 1,087,892 (1912).

³ British patent 147,147 (1913).

⁴ British patent 147,148 (1913).

de Forest, and concerned a potentiometer-shunted battery from the grid of the detector tube (the third tube), connected across a grid condenser, thence to the secondary of the radio-frequency coupling, the primary of which connected with the plate of the second radio-frequency tube.

Actually the conception of the advantages of radio-frequency amplification preceded by a year or more the invention of the regenerative circuits. It was out of combined inventions that the superheterodyne inventions of Lévy, in France, and Armstrong, in America, as well as other efficient receivers and modifications were later evolved. It was recognized that only by the employment of radio-frequency amplification could the long-distance possibilities of the radio receiver be exploited. The addition of radio-frequency stages, however, introduced elements which, unless the circuits were properly designed and expertly handled in operation of the set, rendered the receiver somewhat unstable in performance compared to the simpler circuits not employing radio-frequency amplification.

With the broadcast frequencies particularly, the maximum amplification of a tube circuit was reached just before that point at which the tube oscillated. In tuned radio-frequency circuits undesired self-generated oscillation occurred unless means were provided to prevent this. Yet, it was learned that radio-frequency stages should be tuned if they were to be expected to provide good selectivity—sharp tuning. In radio receiver circuits using radio-frequency stages, the effectiveness of the method used to prevent or suppress local oscillations determined largely the characteristics of the receiver as to sensitivity, selectivity, and tonal quality.

A popular instrument brought out shortly following the general introduction of broadcasting was the tuned radio-frequency receiver. It was among the higher priced units, but it was good for distance reception and, for those days, had good output volume. In a conventional tuned radio-

frequency receiver the modulated radio-frequency signals from broadcast stations are amplified to the desired degree by the radio-frequency amplifier, the signals passing to the input circuit of the detector, or demodulator tube. This tube separates the radio-frequency carrier wave from the modulating audio frequencies impressed upon it, leaving only the original modulation.

Figure 37 shows a diagram of a five-tube tuned radio-frequency receiver without oscillation control other than

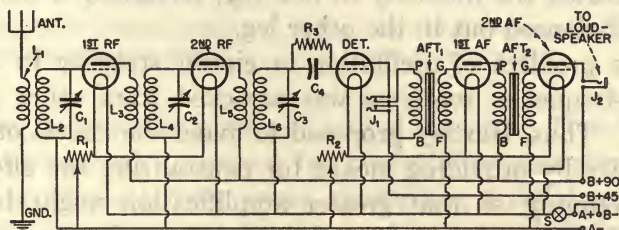

FIG. 37.—Schematic diagram of an early tuned radio-frequency receiver.

that provided by rheostat (R_1) control of filament voltage. In tuning the receiver, the condensers C_1 , C_2 and C_3 were set at approximately the same dial readings. The markings shown are the customary terminal connections. It will be noted that following the detector there are two stages of audio-frequency amplification, transformer-coupled.

The fact that the rheostat, required to stabilize the circuits and prevent oscillation, caused energy loss prompted engineers to devise simpler, automatic methods of accomplishing this purpose. When this need became clear remedial measures soon appeared.

The race toward the solution of the oscillation difficulties in radio-frequency amplifiers was participated in by numerous engineers well aware of the need. Among the methods of correction proposed were inductive neutralization, the potentiometer method, so-called "losser" methods, and capacity neutralization. Some of those who did something

practical about it were C. W. Rice,⁵ and R. V. L. Hartley,⁶ in America, and John Scott Taggart,⁷ in England.

The electrostatic capacity inherent in the audion in the early regenerative receivers, cascade amplifiers, and other early tube receiving circuits was not for some years suspected of being a disturbing element, something to be got rid of. Rice proposed neutralization of the grid-plate capacity by setting up an auxiliary circuit including inductance and capacity. In a bridge assembly the tube capacity constituted the quantity in one leg; obviously a quantity to be balanced out in the other leg.

The problem of oscillation or circuit stability in tuned radio-frequency receivers was attacked from other directions. Thus, Hartley proposed to avoid the effects of tube capacity by providing means for neutralizing the effect of the coupling, so that greater amplification might be obtained and still maintain stability of performance. He utilized the radio-frequency energy in the plate circuit through a reversed feedback connection, thus opposing the energy due to regeneration through the tube.

Another method of accomplishing the purpose was announced in 1926 by Edward H. Loftin and S. Y. White, wherein by means of constant coupling, nonreactive radio-frequency amplification was reported to be practicable.

In 1919, a highly satisfactory method of correcting the difficulty, based on capacity neutralization, was brought out by Alan Hazeltine, in America.

The Neutrodyne Receiver

The early de Forest and the German receivers which employed tubes in cascade for amplification were relatively ineffective owing to inherent unstable characteristics of the early vacuum tubes, which existed because of the relatively high capacity between the grid and the plate. Applied to

⁵ United States patent 1,334,118.

⁶ United States patent 1,183,875.

⁷ British patent 217,971.

radio-frequency amplification, capacity neutralization removed the undesirable effects of capacity within the tube.

The principle of Hazeltine's neutrodyne circuit is illustrated in Figure 38, showing C_1 as the inherent capacity

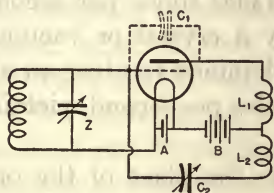

FIG. 38.—Fundamental neutrodyne receiver circuit.

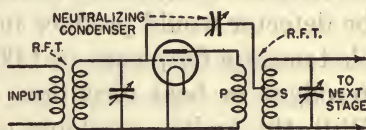

FIG. 39.—Radio-frequency stage of a neutrodyne receiver.

existing between the plate and grid of the tube. Hazeltine's patent⁸ covered a method for neutralizing capacity coupling in three-electrode tubes, comprising a coil connected between the plate and the filament and an auxiliary coil and neutralizing capacity in series and connected between the grid and the filament. The auxiliary coil was coupled with the first coil, the coefficient of coupling being substantially unity, and the ratio of turns equal to the ratio of the coupling capacity to the neutralizing capacity. Voltage occurring in the plate circuit cannot produce an effect in the preceding tuned grid circuit, represented by Z , provided the condenser C_2 is properly adjusted, and the neutralization thus accomplished is independent of the frequency.

Figure 39 illustrates the radio-frequency stage of a commercial neutrodyne receiver showing one particular neutralizing arrangement.

The Audion and the Heterodyne

In Chapter 13 the principle of "beat" currents and the heterodyne was presented as originally developed by Fessenden in the application of high-frequency machine generators of electric oscillations for radio signaling. In 1908 Fessenden applied the heterodyne principle to receivers. If

⁸ United States patents 1,489,228; 1,450,080; 1,533,858.

the frequency of an incoming signal wave were 500,000 cycles per second and another current were impressed on the circuit at a frequency of, say, 501,000 cycles, then the amplitude of the combined currents would rise to maximum and fall to minimum successively 1,000 times per second. The combined currents, rectified by a crystal or vacuum-tube detector would produce in a telephone receiver an audible tone at a frequency of 1,000 cycles per second, yielding heterodyne or beat reception.

With the audion available to take the place of the previously employed external heterodyne, quite naturally the entire question as to the principle of the Fessenden invention was again brought into the open when the audion in 1913 was employed as a producer of oscillations. What was almost an orgy of invention soon followed, precipitated perhaps by J. V. L. Hogan's technical paper on tests of heterodyne reception presented before the Institute of Radio Engineers, in New York, in July, 1913. Late in that year patent applications were filed by Round and Franklin, in England, and by Meissner and Arco, in Germany. Forthwith, also, a prolonged debate began bearing on the degree of amplification of received current accomplished by the heterodyne method.

Following Hogan's paper, L. W. Austin, in a *Bureau of Standards Bulletin*, of April 1, 1914, stated: "The reports indicate that the heterodyne is somewhat more sensitive than the slipping contact [described elsewhere herein], but the difference is not great." Dr. Louis Cohen⁹ held that heterodyne amplification could be increased indefinitely by increasing the local current (using an ideal detector of unlimited current-carrying capacity), while B. Liebowitz⁹ undertook to show mathematically that "the true heterodyne amplification" is 4 times. E. H. Armstrong¹⁰ stated that the results with the tube auto-heterodyne appeared to support the views of Liebowitz, while G.

⁹ *Proceedings, I.R.E.*, July, 1915.

¹⁰ *Ibid.*, October, 1917.

W. O. Howe,¹¹ in England, by several different methods of considering detector and heterodyne action as compared with "chopper" detection of received energy, found that if the detector gives an audibility current proportional to the received current, the maximum amplification of audio power was 2.43, not increasing indefinitely with increase of locally applied current.

The whole matter of the heterodyne principle is important as an illustration of how the radio receiver art in practice continued in advance of generally accepted theory throughout several years following 1913. Armstrong's research¹⁰ brought to the surface much that aided in clearing up the misunderstanding when he found that by separation of the various effects there existed three types of amplification: the first, or *equal* heterodyne, type occurring when the local oscillating current is equal to the signaling current; the second, or *optimum* heterodyne, occurring when the local current is increased to the critical value for maximum response in the indicator; the third, or *regenerative* type, resulting from the amplifying action of the tube and its associated circuits. The roughly approximate numerical values of the three types were 5, 20, and 50.

E. V. Appleton,¹² in England, in a technical paper on this subject showed that the amplitude of the combination tone produced in the receiver telephone reached an optimum value for a certain value of the local oscillation amplitude, distinguishing between anode rectification and grid condenser action. Also, that the magnitude of the combination tone was directly proportional to the strength of the signal oscillation when optimum heterodyne current is applied locally, while the ratio of the optimum value of the combination tone to that appearing with equal heterodyne is inversely proportional to the strength of the received signal.

It must not be lost sight of that Hogan's tests of 1910,

¹¹ *Ibid.*, October, 1918.

¹² *Ibid.*, November, 1923.

and those which followed, were made with electrolytic and crystal detectors. With detectors of the contact type, giving an audibility current proportional to the square of the received current, the amplification might greatly exceed 4. In Hogan's report of the *Salem* tests, he stated that the greatest amplification factor measured was 12, the average throughout the tests being 5.

In a regenerative receiver circuit arranged for rectification and amplification of the incoming telegraph signals, one audion may serve as detector and as generator of oscillations. This is known as autodyne reception. With the antenna circuit tuned to the frequency of the incoming waves, and the tube circuit adjusted to produce local oscillations of a slightly different frequency, beats of audible frequency will actuate the telephone receiver connected in the receiving circuits.

With the audion generating interference currents necessary for heterodyne reception, little time was lost in applying the principle to receiving sets using audions. Hogan, in May, 1915, supplementing by discussion Armstrong's paper of March of that year showed circuits of a receiving system employing an audion as detector, and another audion as generator of the heterodyne frequency. In 1915, L. W. Austin employed beat reception with audions at the Darian, Canal Zone, naval station.

But then, the "War to end wars" had begun in Europe and several years were to wear on savagely before it would be possible to learn much about the progress of radio made by the engineers, Allied and enemy, of the nations engaged in the struggle. Following the entry of the United States into the war, all effort was directed toward the inventing and producing agencies, by means of which the war could be won by the Allies as quickly as possible. In connection with American participation in the operations there was formed a Division of Research and Inspection of the United States Signal Corps. Into this group came several of the bright minds of radio, including E. H. Armstrong, W. A.

MacDonald, J. H. Pressley, H. W. Houck, Harold M. Lewis, and W. H. Priess. The research headquarters was set up in Paris, France.

It was of more than passing interest that the communication agencies of the co-operating armies should have such men in conference as H. J. Round and J. B. Bolitho from England; Marius C. A. Latour and Lucien Lévy from France; and Armstrong and his associates from the United States. The work of all these radio engineers has been referred to in previous chapters. The French, under Latour, produced a six-stage amplifier known as the L-3 type. The British, under Round, produced a seven-tube amplifier known as the No. 55. For the uses of the A.E.F., the Americans adopted the L-3 receiver of the French, as it was the amplifier immediately available. It was quickly learned that, for the communication needs as they rapidly developed, there was a demand for greater amplification. And here again we find the genius of the Americans measuring up to the requirements.

Revolutionary Receiver Developments

Armstrong's four or five years' experience with regenerative receivers, oscillating audions, and the heterodyne gave him a fund of just the right kind of knowledge, not only to solve the problem posed in France, but to apply it in the design of a type of radio receiver which would be an improvement over others in use.

The Superheterodyne Principle

After the close of the war (World War I) Armstrong related¹ how, with his war experience in mind, the idea occurred to him to solve the problem of improved receiver design by selecting some fixed low frequency which could be handled well by the vacuum tubes available in France in the summer of 1918, converting the signals to this frequency for amplification. He built an effective fixed-tuned amplifier for that frequency, and then transformed the incoming frequency to this readily amplifiable value by heterodyne and rectification.

There was the probability that greater amplification could be obtained from the average tube at low radio frequencies, where tube and circuit losses are less than at higher radio frequencies, also the advantage of a fixed-tuned amplifier operating at a low frequency, yielding superior stability, obviating interaction between it and the higher frequency input tube circuits, and providing simplified tuning.

The production of ultra-audible frequencies by heterodyning had been pioneered in France by Lévy, in England by Round, in Germany by Meissner; and in America the immediate outcome of Armstrong's deliberations was the

¹ *Proceedings, I.R.E.*, December, 1919, and March, 1924.

development of a receiver system that came to be known as the *superheterodyne*. The early circuit arrangement is illustrated in Figure 40, wherein both rectifications were accomplished by three-electrode tubes of the audion type.

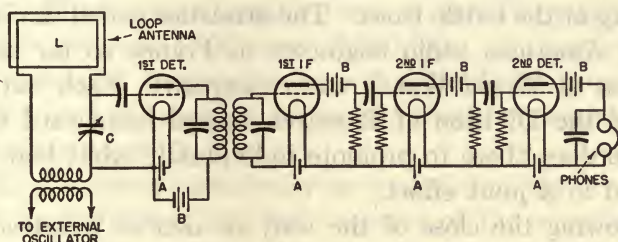

FIG. 40.—General circuit of early superheterodyne receiver.

Although any form of stage coupling could be used, in the low-frequency amplifier resistance-coupled amplification is shown following the input circuit. Armstrong² explained that in this arrangement the tuned circuit LC was adjusted to some appropriate frequency and, if desired, could be made regenerative by any form of reactive coupling. If the frequency to be received was 5,000,000 cycles, this could be stepped down to 500,000 cycles, re-amplified, and detected. He concluded that an advantage of this method of amplification was that the tendency to oscillate, due to reaction between the output of the amplifier and the input, is eliminated, because the frequencies are widely different.

Armstrong designed an eight-tube receiver consisting of a rectifier tube, a separate heterodyne oscillator, three intermediate-frequency amplifiers, a second detector, and two audio-frequency stages. The intermediate stages were coupled by tuned air-core transformers designed to tune to a frequency of about 100,000 cycles, with adjustment for regeneration. Amplification of voltage as noted at the input of the second detector (the amplifier being just below the oscillating point) was approximately equal to a radio-frequency amplification of 500.

As Armstrong related, the first sets were somewhat critical in adjustment and considerable skill was required in operating them. And, at this stage of the experimental work, on November 18, 1918, the morning's calm was shattered by stentorian announcements heralding the end of gunplay at the battle front. The armistice ended the labors of the American radio engineers in France so far as the business of World War I was concerned! Each national unit of the Division of Research turned homeward to its own borders, there to promote individually what had been gleaned in a joint effort.

Following the close of the war, as soon as technical literature began again to circulate, it was learned that German radio engineers had made progress in devising radio receivers of improved sensitivity and selectivity during the war years. One of the Germans, Walter Schottky, in March, 1918, in designing a system for radio reception for the communication minions of the Kaiser, had, it appeared, followed a path of reasoning that took him over ground similar to that explored by Armstrong and his American associates in the company of the British and French engineers. To attain the end he sought Schottky's first idea was to undertake to provide special amplifying tubes having large electronic currents and low internal resistance. But later he reached the conclusion that, as the amplification of very short waves involves a large loss of energy in the amplifier tubes, there was advantage in converting short waves into longer waves at the point of pickup, amplifying the latter only, and thus avoiding loss of received energy while still dealing with ultra-audible frequencies. As recorded by Schottky² in March, 1918:

This is accomplished by heterodyning another frequency differing by about 10 per cent so that the beat wave becomes high-frequency. [Thus producing the desired low intermediate frequency.]

² German patent D.R.P. 368,937 (June 18, 1918).

In the fall of 1919, Armstrong, on home soil, undertook to determine the results obtainable by pushing the heterodyne method of reception to the limit of its possibilities, by constructing a resistance-coupled intermediate-frequency amplifier employing five tubes of high amplification factor. The voltage amplification of the five stages was probably between 5,000- and 10,000-fold. A complete set with two-tube frequency converter, five-tube amplifier, detector, and one stage of audio amplification gave promising receiving results.

It is of interest historically to record that the long-distance possibilities of the early models of the superheterodyne receiver were demonstrated in December, 1920, when Paul Godley, representing the American Radio Relay League, at a temporary receiving station set up on the west coast of Scotland, received signals from a number of amateur transmitting stations in America. The receiver used by Godley comprised a regenerative tube rectifier, a separate oscillator, four stages of resistance-coupled intermediate-frequency amplification, a second rectifier, and two stages of audio amplification.

It will be recalled that it was in December, 1920, also that radiophone broadcast transmission had been developed to a degree of practicability warranting regular schedule operation, such as in that month established by KDKA at Pittsburgh. A red-letter month, December, 1920, in the history of radio!

The development of the superheterodyne receiver for broadcast reception was continued by Armstrong assisted, in 1922, by Harry W. Houck. For public use it was desirable to lessen the number of controls. A step in this direction was taken by designing an intermediate-frequency amplifier for a given frequency and for a band of 5,000 cycles above and below that, which would cut off sharply on either side of the desired band; the operating adjustments accomplishing simply the change of incoming frequency down to the band of the amplifier.

In the spring of 1922 a receiver was constructed consisting of one (nontuned transformer) radio-frequency stage, a rectifier tube, an oscillator tube (used as a separate heterodyne), a three-stage iron-core transformer-coupled intermediate-frequency amplifier for a band of 20,000 to 30,000 cycles, a second detector tube, and two stages of audio amplification.

To prevent the intermediate-frequency amplifier from oscillating, each stage was separately shielded. The use of a radio-frequency stage ahead of the first detector eliminated radiation of the oscillator frequency by the loop circuit.

Obviously, the over-the-counter cost of a receiver of this type was high, particularly at a time when persons who owned receivers had fashioned them from homemade or purchased parts, or were accustomed to crystal-type receivers which could be purchased for twenty dollars or less. With the six-volt tubes made available in 1922, the A battery current for the superheterodyne receiver was 10 amperes. The arrival later of the low-current dry-cell tubes made possible a considerable reduction in the cost and maintenance of receivers.

Attempts were made to reduce the number of tubes required without lowering the sensitiveness of the receiver, by arranging so that a single tube would serve a double purpose. But there was no large success in this until Houck³ proposed to connect two tuned circuits to the oscillator: a simple circuit tuned to the frequency of the incoming signal, and a regenerative circuit adjusted to oscillate at such a frequency that the second harmonic of this frequency, beating with the incoming frequency, produced the desired intermediate frequency.

The connections for this arrangement are shown in Figure 41, where circuit L_1C_1 is tuned to the incoming signals; circuit L_2C_2 is tuned to one-half the incoming frequency, plus or minus one-half the intermediate frequency.

³ *Proceedings, I.R.E.*, March, 1924, p. 545.

As stated by Armstrong "by reason of asymmetrical action of the tube," there were created in the circuits a variety of harmonics. The second harmonic combining to produce beats with the incoming signals, of the desired intermediate-frequency. By way of L_3C_3 and L_4C_4 , the resulting frequency was applied to the amplifier circuit. Be-

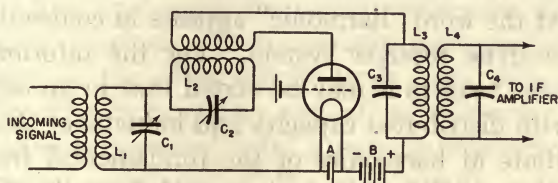

FIG. 41.—Input circuit of second-harmonic superheterodyne receiver.

cause L_1C_1 and L_2C_2 were tuned to widely different frequencies, a change in the tuning of one had no appreciable effect upon the tuning of the other.

A further step taken by Armstrong was to have the radio-frequency amplifier also amplify the intermediate frequency. Thus the signals were amplified at radio frequency by the first tube and applied to the grid of the second-harmonic oscillator by means of an untuned radio-frequency transformer. The combined signal and heterodyne currents then were rectified by the second tube, producing a current of the intermediate frequency; passed to the grid of the first tube and amplified there; and passed to the second stage of the intermediate amplifier.

Shortly then, the commercial development of the superheterodyne receiver passed into the laboratories of the large manufacturers associated with the Radio Corporation of America, where refinements were incorporated that made it an efficient six-tube receiver. In the unit produced commercially for broadcast reception the first tube in the circuit (of the six-tube receiver) is the first detector or frequency changer; the second tube functions as an oscillator; the

third, fourth, and fifth tubes are the intermediate-frequency amplifiers; and the sixth tube is the second detector.

In recounting the history of radio development throughout the past fifty years, there is warrant, and space, only for treatment of the highlights which were fundamental steps forward. Unavoidably, terms appear in the text which had no earlier introduction in the story. In the foregoing text the word "harmonic" appears in connection with the heterodyne receiver system. For the information of nonengineer readers it may be stated that in an oscillatory circuit with distributed capacity and inductance the system will oscillate at harmonics of the fundamental frequency. The fundamental frequency is regarded as the first harmonic, the second harmonic having twice the frequency of the fundamental. Vacuum tubes when employed as oscillators normally have harmonic frequencies produced in the output circuit. A crystal oscillator and tube assembly operating at a fundamental frequency of 2,000 kilocycles would have present in the output circuit frequencies of 2, 3, 4, and so on, times the fundamental frequency. The second harmonic of 2,000 kilocycles would be 4,000 kilocycles, the third, 6,000 kilocycles, etc. Harmonics are not peculiar to radio frequencies, being also present in circuits operated at low frequencies. In an electric power or light circuit operating at 60-cycles, there is a second harmonic of 120-cycles, and others at the higher multiples.

It was not with the idea of following Hollywood's promotional line that, after the close of World War I, designers of radio receivers resorted to the use of the prefix "super" to distinguish the new from the old. The reason for the prefix was that improvements were made in the elements of the heterodyne and the regenerative receiver which projected those sets into the super class. Thus, they were called the superheterodyne and the superregenerative receiver. To make it triplets the excellent neutrodyne receiver was added to the list at about the same time. There were also the regenoflex receiver, tuned radio frequency, and various

reflex receivers. It was a period when it appeared that the bulk of radio research and improved construction was in the field of receivers.

Reflex Receivers

E. H. Armstrong undertook the extension of the regenerative principle into a field beyond that previously explored by him, and out of the experiments came the super-regenerative receiver. In the simple regenerative circuit the energy in the plate circuit feeds back into the grid circuit by way of coupling, and at an increasing rate as the coupling is increased, until a point is reached at which the apparent resistance of the grid circuit is overcome, setting up oscillations. If, at the approach of the oscillatory state, a resistance could be inserted in the grid circuit that would absorb the extra energy, and be removed when that is accomplished, the process being repeated with the requisite rapidity, the advantage of regeneration would be considerably increased. Three methods of accomplishing this came to the surface. Resistance could be applied to the circuit by means of an additional tube circuit coupled to the grid, periodically tuned and detuned to the frequency of the circuit. Or, the additional circuit could be coupled to the plate. Or, a combination of these two arrangements could be employed to accomplish the desired end.

The public market for radio receivers which sprang up beginning in 1920 soon took on such promising proportions that it appeared radio was to become a business in place of a hobby. The growing demand for receivers stirred the engineers to produce better ones. In England, L. B. Turner,⁴ by means of tubes, prevented the regenerative circuit from generating oscillations, by impressing a negative potential on the grid of just sufficient value to maintain the state at which self-oscillation could not occur. Return to the sensitive state was accomplished by relay action caused by increase in the plate current of the tube, shunting

⁴ British patent 130,408; United States patent 276,856 (1919).

the feedback coil as a result of which the source of added energy was shut off. Thus the potential of the grid dropped to a value below that which would produce oscillations.

Also, in England, J. B. Bolitho⁵ improved on the mechanical relay idea by connecting a second tube to the oscillating circuit of Turner's arrangement with a reversed feedback connection, supplying the plate circuit of the second tube with alternating current. The novelty here was that at the "spill-over" point of the first tube the reversed feedback of the second tube, acting at a time when the voltage supplied to the plate was positive, served to damp out the free oscillations started by the first tube, thus causing the grid of the first tube to return to the nonoscillation state. It is helpful here to keep in mind that multi-grid tubes were not brought out until later years.

And in America, C. V. Logwood, in March, 1921, filed a patent application covering means whereby apparently regeneration was fully availed of without undesired oscillation effects. His proposal was to use a mechanical exciter, such as an alternator, shunted by a resistance and capacity in series and connected to filament and plate of the tube of the regenerative receiver. (Presumably a tube could be used as the exciter.)

Armstrong on his part proposed various more or less related methods of accomplishing the desired purpose. Recognizing that the limit to which regeneration can be carried is the point at which oscillations begin (since at that point further amplification ceases), he devised means to permit the circuit to spill over into oscillation, then quench the oscillation instantly, repeating this cycle at a rate of perhaps 25,000 times per second or higher. That is, the circuit was permitted to periodically approach the point of oscillation and then to back up or recede. This was accomplished by supplying an additional "quench" frequency, impressed on the circuit so that the characteristic of the tube which tends to make it oscillate is under control. The super-

⁵ British patent 156,330 (1921); United States patent 1,407,245 (1922).

regenerative circuit thus overcame the limitations of earlier regenerative circuits by introducing into the detector circuit a quenching voltage of a frequency somewhat above the audible range. In Figure 42, the oscillator tube *O* produces the supersonic frequencies for quenching, which are impressed upon the regenerative tube *R*, the latter tube functioning also as a detector.

The superregenerative receiver with one stage of audio frequency added and employing a loop antenna served with fair satisfaction during the early days of popular broadcasting. There was still much to be done with the output circuits in order to render faithful reproduction, with desired volume.

While work in connection with perfecting the superregenerative circuit was being carried on, numerous engineers experimented with betterment possibilities of the simple regenerative circuit, and several ingenious methods were proposed by means of which it appeared possible to

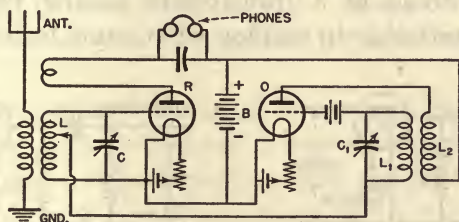

FIG. 42.—Diagram of early superregenerative receiver.

control the amplifying energy fed back to the grid circuit. Arrangements were brought out by Roy A. Weagant, R. V. L. Hartley, A. H. Grebe, John L. Reinartz, and others. Receivers produced and placed on the market, and which had considerable sales, included Grebe's split-variometer receiver, and L. M. Cockaday's improved ultraudion receiver.

Receiver circuits based on superregeneration, as distinguished from those referred to in the above paragraph, included one brought out by E. T. Flewelling and another

by M. L. Muhleman, the latter known as the Autoplex. These two systems accomplished superregeneration with one vacuum tube and a minimum of circuit components. Both were capable of operating a loudspeaker without additional audio-amplifier tubes. Also, in both systems, the single tube served as a regenerative amplifier, detector, and quenching oscillator.

This was the free-for-all era in radio, when individual ingenuity had free rein to design, produce, and sell. In the course of time the mass demand for radio receivers was to grow to such volume that large manufacturing companies would, perforce, take on the task of supply. It was a glorious period while it lasted. It was Americanism at its zenith.

It may be in place here to refer briefly to means of transferring energy from one stage to another in receivers, other than those described in foregoing text wherein air-core transformers or couplers are employed to join successive sections. Instead of a transformer having two separate coils it is practicable to employ what came to be called im-

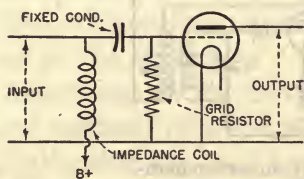

FIG. 43. — Impedance-coupled radio-frequency circuit.

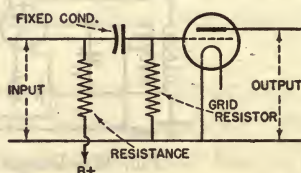

FIG. 44. — Resistance-coupled radio-frequency, or audio-frequency, circuit.

pedance coupling (see Figure 43). The energy to be applied to the input of the tube is that set up across the terminals of the impedance coil, a coil having inductance, and may or may not have an iron core, depending upon whether it is to be used for passing radio-frequency or audio-frequency currents. In Figure 44, plain "resistance" coupling is shown, the input voltage being that due to the

difference in potential between the terminals of the input resistance.

In Figure 45, the wiring of an impedance-coupled audio amplifier is shown to the right of a detector tube. Here

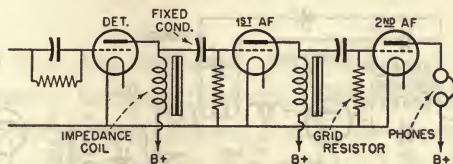

FIG. 45.—Circuit of two-stage impedance-coupled audio-frequency amplifier.

one winding serves both as primary and as secondary. The condensers in series with the grids of the two tubes are for the purpose of blocking the current path from the B battery, which would be by way of the impedance coil to the grid. Where impedance coils appear in Figure 45, resistors could be connected instead. Based on this form of coupling excellent audio-amplifier circuits have been devised.

It has been related that von Bronk and Schloemilch, in Germany, in 1913, introduced a receiver circuit employing tubes and also a solid rectifier. This circuit was the forerunner of several highly ingenious radio-receiver systems introduced shortly after the advent of popular broadcasting. The newcomers were called reflex receivers, because in the hookup one tube was made to serve the purposes of two. One of these circuits is shown in Figure 46, wherein a variometer is used for tuning purposes. The primary and secondary windings of two audio-frequency transformers are denoted by P and S , while A may be the halves of the stationary member of a split variometer and R the rotary member. The crystal detector is shown at D . Dual amplification is accomplished in the tube VT_1 . The received radio-frequency signals are first amplified by this tube, then rectified by the crystal (or another tube) and passed back

to the input circuit of the tube and thus further amplified at audio frequencies.

In America, W. H. Priess, in 1916-1917 in the service of the navy, invented various circuit combinations employ-

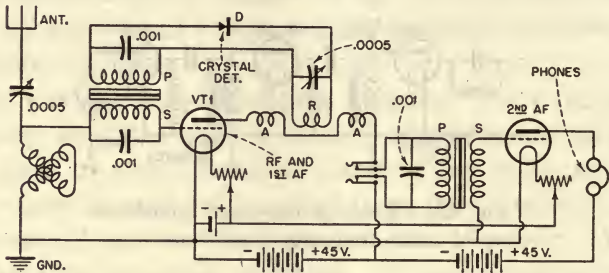

FIG. 46.—Circuit diagram of the once-popular reflex receiver.

ing reflexing. La Tour, in France, in December, 1917, applied for an American patent⁶ for a reflex receiving system.

During wartime, when the nations' resources are consolidated with individual and collective effort, contributing to a pressing objective, patent protection for particular inventions occurs usually to the far-sighted, who realize that wars come to their ends. When war ends, there is at once termination of community interest. Individual interest again resumes its even tenor or its troubled course.

⁶ United States patent 1,405,523 (1922).

The Advent of Commercial Radio

Following the first experimental trials of wireless telegraphy, those who had supplied the pocket money to finance the experiments began to look about for places where the system, elementary though it was, could be put to work. In the year 1900 the world appeared to be adequately supplied with wire telegraphs, submarine cables, and wire telephony; so wireless was destined to have before it a rough road, until one day it should suddenly come into a service field of its own—this in addition to its expanding usefulness in competition with wire services. However, let us briefly run through some entries to register some of the commercial steps taken in introducing wireless as a utility.

Wireless Telegraphy and Radio Telephony

In an earlier chapter reference was made to yacht-race trials of Marconi's apparatus in 1899, off New York harbor, and to tests of the equipment late in that year between two ships of the United States Navy. In the following year the Marconi International Marine Communications Company was organized in London. In 1901 Marconi stations were in service in the Hawaiian Islands and on the Canadian eastern coast. Marconi's announcement in December of that year that he had succeeded in transmitting test signals across the Atlantic at once attracted wide publicity and interest. In 1902 the Marconi Wireless Telegraph Company of America was organized, also a Canadian Marconi Company. In the United States, the National Electric Signaling Company and the Pacific Wireless Telegraph Company were established. The United States Signal Corps set up stations in Alaska between Safety Harbor and St. Michael. In March, 1904, the Western Union Telegraph

Company announced that messages would be accepted at its offices for passengers traveling on ships. At that time thirty-two vessels were equipped with Marconi apparatus—on the Atlantic route. In 1907 the Marconi Company announced the opening of commercial service between Glace Bay, Nova Scotia, and Clifden, Ireland, and in that year six incorporated wireless telegraph companies in the United States operated 122 stations, during the year handling 163,617 messages, the income reported to be \$122,154 and the expenses \$169,782. The financial picture in reality was somewhat worse than this, as various of the enthusiasts and devotees of wireless, engaged in the operations, for a time worked for board and laundry.

In 1909 the United States government called for bids for wireless equipment and the following companies submitted bids: Marconi Wireless Telegraph Company, Telefunken Wireless Telegraph Company (German), Massie Wireless Telegraph Company, of Providence, the Radio Telephone Company, New York, and the Stone Telegraph and Telephone Company, of Boston. The United Wireless Telegraph Company (de Forest) had stations in operation and was endeavoring to set up overland operation between cities.

The financial promoters of the early "wireless" companies were quite aware of the advertising value of wonder, of mystery. There was little in the make-up of the early wireless telegraph apparatus which even remotely suggested the possibility of wireless telephony. The technical workers were fully occupied with the effort to set up dependable telegraph working. They were agreeable to allowing the subject of telephony to rest until the stiff problems of wireless telegraphy had been solved, and while this was quite proper, and inescapable, on the part of the technicians, no such limitation guided the deliberations of the promoters.

The early wireless companies organized in America were not handicapped at the start by being given corporate

names which implied restriction of field of service. With a nonchalant buoyancy of outlook and an abiding faith in what engineers could accomplish, the promoter blithely inserted the word "telephone" into the name of his company. A wonder is that their prescience did not extend so far as television!

While the promoter's desire was that his technical staff should be able to demonstrate practical telegraph working, in naming his company, he often placed the word "telephone" ahead of the word "telegraph." The first company in America, organized in 1901, was named the American Wireless Telephone and Telegraph Company, followed by the Continental Wireless Telephone and Telegraph Company, and others. The promoters were, in aspiration at least, in advance of the engineers.

The scientist, the inventor and the engineer are not much given to capitalizing the future. They are explorers who label and card-index only that which they know has been accomplished, and it was in this manner of proceeding that the engineers developed radio telephony out of wireless telegraphy.

To continue the chronology: In 1911, the United Wireless Telegraph Company reported having five hundred stations in service, including ship installations. The company had a capital of \$10,000,000 common and \$3,000,000 preferred stock, but soon was bankrupt, and, after court action, three of its top officials were domiciled in Atlanta penitentiary as a result of alleged stock frauds. This brings events up to about the time of the emancipation of the de Forest audion—1912. In that year the Marconi Wireless Telegraph Company of America acquired United's assets and services and was in a position to begin the upbuilding of a going concern. Following the end of World War I, the American Marconi Company became the Radio Corporation of America, with Edward J. Nally as its first president.

At the time the Radio Corporation of America was or-

ganized radio telephony was a prospect, as an associate service with wireless telegraphy. Few, if any, were thinking of radio broadcasting of the scope of symphony orchestras, fireside chats, cigarette and lipstick sales, and fifty million home receivers. That vast utility had to barge in, almost, on its own account—when the opportune time arrived.

At the end of World War I the nations found themselves in possession of at least one war development that was in no danger of being scrapped with the surplus ships, guns, and helmets—radio telephony.

Radio telegraphy had made vast gains during the war years. In 1918 authentic statistics for radio telegraph installations throughout the world showed a total of 6,600 stations, of which 720 were coastal stations, 5,700 on ships, and 180 inland; and soon after the war radio telegraph service was established (or resumed) between practically all countries.

Promotion of Radio Telephony

But what about this war-nurtured service, radio telephony? Obviously, in its embryo state it could not successfully be applied in competition with wire-line service. Radio was not secretive. A great multiplicity of stations could not be satisfactorily operated simultaneously in a given territory. These were perhaps considerations which prompted land-line telephone interests to view with little immediate concern the possibility of radio competition.

In the meantime new forces were at work. Where, prior to the war years, radio telephone exploitation had been left to the individual scientists and small radio companies organized to raise money for its experimentation and promotion, following the close of the war several of the large electrical manufacturing companies found themselves in possession of patent rights, radio manufacturing facilities, and staffs of radio engineers familiar with the radio art. For instance, in the fall of 1920, the Westinghouse Electric

and Manufacturing Company acquired control of the International Radio Telegraph Company which operated five stations on the Atlantic coast. (All the private radio telegraph companies taken over by the government on July 31, 1918, for war uses, were returned to their owners on February 29, 1920.)

In 1919 the General Electric Company acquired control of the American plant and other assets of the Marconi Wireless Telegraph Company of America, becoming the Radio Corporation of America. Coattails flew around corners and got caught in speedy revolving doors as smart men hurried hither and yon to conferences. The teakettle of grand emprise simmered, boiled merrily, and then whistled. The whistling sounds were in the nature of benedictions showered upon the General Electric Company by admirals of the navy. Down Broadway the Radio Corporation's conception was given a humorous, if impious, twist that amused those who watched events and did the General Electric Company no harm.

In August, 1921, the Radio Corporation took over the International Company's stations owned by Westinghouse, leaving only the Independent Wireless Telegraph Company, on the Atlantic coast, and the Federal Wireless Telegraph Company, on the Pacific coast. The business then of these companies was mainly ship-shore. In a few years the Radio Corporation took over the operations of the Independent Company.

Here was created a situation that does not often have so happy an outcome. The Westinghouse Company's engineers who had radio inclinations welcomed the acquisition by their company of the International Company, but when control of that company later passed to the Radio Corporation, the Westinghouse engineers (as radio engineers) were back where they had stood at the end of the war—with radio knowledge, radio experience, and with valuable patent rights. It does not call for a vivid imagination to picture Frank Conrad, M. C. Rypinski, and L. W. Chubb, Westing-

house engineers, in conference or individually speculating upon the query, "What now?" These engineers, and others of that staff, were all set to go when the race was called off, and each was of the mold that gets into a race even though he has to organize a race of his own.

And that was about what took place. Conrad believed that with a radiophone transmitter in operation on regular schedule, say certain times during the week, sending out music and other entertainment, there should be an audience consisting of perhaps a few hundred amateurs and radio experimenters, and if the service was publicized perhaps hundreds of others would procure receivers. It was Conrad's discovery that what had been said agreeably to this notion was evidently true.

As early as October, 1919, Conrad had set up experimental radiophone equipment at his home at Wilkinsburg, Pennsylvania. In September, 1920, he gave to the press a notice that on a certain evening he would send out by radio music from a phonograph mounted near the microphone.

The First Experimental Broadcasting

A few months later Conrad's private station was discontinued and an experimental broadcast station, KDKA, was set up at East Pittsburgh by the Westinghouse Company, through the quickened interest of Harry P. Davis, vice-president of the company. The station was opened on regular evening schedule on December 23, 1920.

The first intimation radio engineers in New York had of what was "cooking" at Pittsburgh came on the evening of October 6, 1920, at a dinner at the Beaux Arts Restaurant, attended by L. W. Chubb, M. C. Rypinski, L. R. Krumm, J. V. L. Hogan, Alfred N. Goldsmith, Donald McNicol, and Lloyd Espenschied, the latter four members of the board of direction of the Institute of Radio Engineers. From the eminence of time, twenty-five years later, those who attended the dinner may recall the en-

thusiasm of Chubb and Rypinski with regard to the envisioned glories of broadcasting music regularly as a business undertaking.

Compared to the others present, Chubb and Rypinski were not old in the radio business. The radio business, as new arts will, had kicked the others around a bit. They listened attentively to an epic ancient "Radiophones in a million homes." But the scope and the sweep of the thing were new, and mayhap more than one of Chubb's dinner guests thought of the request made by the Bard of Avon when he said:

Show me one scar characterized on your skin;
Men's flesh preserved so well do seldom win!

About two months after this, KDKA was launched upon the air and, for radio, a new and promising era had begun.

Following the procedure in this work of other noteworthy departures, it is of interest to scan prior attempts to broadcast by radiophone. De Forest in 1907, in testing the twenty-odd radiophone transmitters intended for the use of navy vessels, sent out music from a phonograph, and in the summer of that year, phonograph selections were transmitted to fill in gaps while the yacht races on Lake Erie were in progress. In 1907, also, de Forest had Madame Eugenia Farrar sing two songs into his microphone, which were heard at the naval radio office in Brooklyn. The 1907 radiophone demonstrations were made with the equipment available at that time, the quality being poor compared to that possible in 1920.

It was only after the advent of the oscillating audion that anything in the nature of practical radio telephony was possible. In 1915 several experimenters began to build radiophone transmitters employing tube oscillators. Thenceforth progress was rapid, even though no one could think of radio earning millions of dollars yearly by promoting sales through free entertainment, like the itinerant minstrels who sold Indian Sagwa liniment.

In 1915 and 1916 several demonstrations of radio telephony were made. Engineers of the Western Electric Company, in November, 1915, radioed music from Washington to New York as an entertainment feature at a dinner. In the fall of 1916, de Forest from his High Bridge, New York, station sent out election returns, heard by the few amateur listeners within range. In 1916, also, Harold J. Power, of

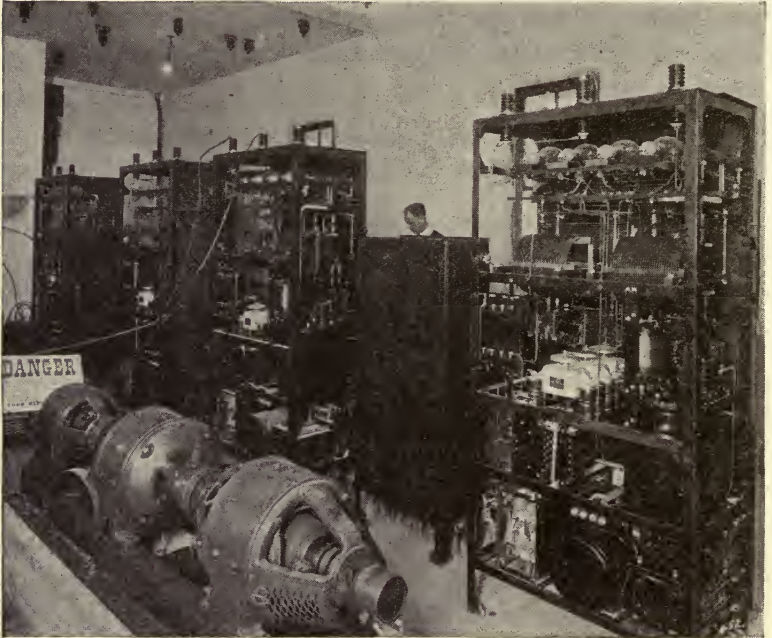

INTERIOR VIEW, STATION WJZ, 1923

Interior view of WJZ broadcast station, on Forty-second Street, New York, installed in 1923. Station designed to have simultaneous transmission on two wave lengths. The transmitting and modulating tubes on top shelves of panels, rear view. (*Courtesy of Radio Corporation of America.*)

Medford Hillside, Massachusetts, transmitted music occasionally in December of that year.

Radio telephoning in the early years was, as now, expensive, and the entire cost of operation devolved upon the

experimenter without any idea of financial return. The listeners were the amateur wireless telegraph experimenters, whose sets would pick up the music radiophoned. Also, radio operators on ships within range could hear the music. Radio receiving sets were not as yet generally on sale and the public looked upon receivers as highly complicated devices requiring expert knowledge in their operation. And, very important, loudspeaker horns or trumpets had not yet made their appearance. Listening-in was accomplished by means of earphones.

The American Marconi Company's research department, under the direction of Dr. A. N. Goldsmith, was located at City College, New York. In 1916-1917, Goldsmith conducted experiments in telephoning by radio. One transmitter, for low-power direct current, employed as oscillators four UV-202 tubes in parallel and 235 volts on the plates. Persons having receivers with detector and two-step amplifiers could pick up transmission from such a set 75 miles away. In 1917, Goldsmith constructed a larger transmitter, operating on 1,500 to 2,000 meters, the antenna power in excess of $1\frac{1}{2}$ kilowatts.

The antenna employed for transmission was a flat top about 150 feet high and with a length (of the flat top) of about 500 feet. The down-lead was attached approximately at the center of the top section and came down to the transmitter at ground level. The flat-top consisted of six parallel wires. Plate voltage was about 2,000, obtained from two direct-current generators in series. The modulators of a year or two later were for the future, so the City College transmitter was modulated from an ordinary telephone transmitter through a suitable amplifier into the modulating tubes. At Schenectady, E. F. W. Alexanderson, of the General Electric Company, co-operating in these tests employed an alternator together with magnetic amplifier for modulation purposes.

Transmission from City College was picked up as far away as North Dakota (about 1,500 miles) where Dr. A.

Hoyt Taylor was then serving as a professor of electrical engineering, and experimenting with wireless.

In December, 1919, Robert F. Gowen, of the de Forest staff, set up at his home at Ossining, New York, a $\frac{1}{3}$ -kilowatt radiophone transmitter with which he transmitted music. The wave length was 330 meters and the antenna



STATION WJZ

Broadcasting station WJZ on Forty-second Street, New York, 1923.
(*Courtesy of Radio Corporation of America.*)

current 2.4 amperes. This demonstration attracted some attention among amateurs and for several weeks a schedule of transmission continued, beginning at 11:00 P.M. daily.

In Montreal, Canada, in February, 1920, under the direction of D. P. R. Coats and J. O. G. Cann, a transmitter for radio telephony was constructed, music being sent out on Tuesday evenings; ultimately, it became nightly, operating at 500 watts. Only the wireless telegraph experimenters and ship operators in port at the time knew of the tests.

Rapid Growth of Broadcasting

In the main the tests and demonstrations made prior to 1920 had in view the development of telephoning by radio. When music was sent out the idea was that this would be only local coverage and of interest to occasional experimenters. However, the immediate success met with by the Westinghouse Company in placing KDKA on a regular schedule prompted the company to tackle the larger field in New York by setting up a broadcasting station there, and it followed that WJZ was opened at Newark, New Jersey, on October 23, 1921. In this plant greater power was made available by the employment of two 250-watt oscillator tubes, three 250-watt modulator tubes, and two 500-watt amplifiers. The plans of Conrad, Rypinski, Chubb, and Krumm were taking shape.

The first broadcasting station of the Radio Corporation of America, WDY, was that at Roselle Park, New Jersey, established in the fall of 1921. Roselle Park was where the company had a large manufacturing plant, which had been used for war production, and also a large antenna structure. There was no New York studio, so it was necessary for the station management to transport singers and musicians by taxicab back and forth to New York, 20 miles away. To remedy this situation and to accomplish other ends, about the beginning of 1922 the Radio Corporation and the Westinghouse Company joined fortunes in the operation of WJZ at Newark, closing the Roselle Park station.

And then, in 1923, a new and glorified WJZ was opened by the Radio Corporation on Forty-second Street, New York, and in 1925 the 50-kilowatt station was opened at Bound Brook, New Jersey, with connections to studios in New York.

KDKA grew out of Conrad's amateur wireless telegraph station 8XK. Then followed the installation of radio-phone transmitters for broadcasting at such a rate that by

the end of 1922 there were about 600 stations in service or under construction. Surely the stars of radio's horoscope were in conjunction in 1921, for it was in that year, on its twenty-fifth birthday, that broadcasting descended upon the earth after the manner of a spiritual visitation. The publicity department of a large company excitedly caught the enthusiasm and spread across the country the tidings that radio broadcasting had been inaugurated at KDKA, WJZ, and other stations hastily completed. All of this at once created a national demand for radio receivers, which forthwith put three shifts at work in factories equipped to produce the required apparatus. Many thousands of mechanically inclined citizens made up their own sets from parts purchased here and there. Electrical manufacturers met the initial demand by supplying elementary crystal receivers at a price that wasn't high but yielded a comfortable profit.

With hundreds of millions of dollars annually earned from the sale of receivers, the manufacturers believed they were in a position to support the broadcasting stations to the end that the golden circle might be maintained and enlarged. Some top-notch vaudeville entertainers, outstanding singers, and actors of the legitimate stage looked askance at the entertainment innovation, but one at a time they gave up resistance, until ultimately even world-famous actor-stars were endorsing particular brands of soap by radio.

By the year 1927 it was estimated that 6,000,000 of the 22,000,000 homes in North America were equipped with receivers of one kind or another, and that an average of 25,000,000 persons daily listened to whatever was sent out by the stations. By 1927 there were 680 licensed broadcast stations in the United States, of which about 250 were broadcasting on daily schedules. It was estimated also that the 16,000,000 homes on the continent not then equipped with receivers were being supplied at the rate of about 1,000,000 sets each year. And the first license

granted by the Department of Commerce at Washington for the operation of a broadcast station was issued in September, 1921. In the use of a radio telephone transmitter to broadcast in all directions to a large number of home receivers, radio telephony at last found its own vast field of usefulness, a field awaiting exploitation and not served by any other agency.

In other countries the radio broadcasting idea was developed a year or so following the popularization of the service in America. From London and Manchester, beginning on November 14, 1922, at first news bulletins and weather reports were sent out. The British Broadcasting Company was incorporated on December 16, 1922, with J. C. W. Reith as general manager. The company was granted a monopoly of broadcasting operations in the British Isles. The earnings of the company were derived from annual license fees (the same as in Canada) charged all persons owning radio receivers. By January, 1923, 25,000 licenses had been taken out, by February the number had increased to 53,000, and following the opening of additional broadcast stations at Birmingham and Newcastle, the number of licenses had grown to 492,000.

In other European countries the broadcasting enterprise was taken up slowly and cautiously by the bureaucratic governments, but within a few years radio broadcasting stations were serving the peoples of practically every country in the world.

The American Telephone and Telegraph Company's New York broadcast station, WEAJ, on September 7, 1922, scheduled the first advertiser-sponsored program, that of a real estate company. In 1926 the National Broadcasting Company was formed and acquired station WEAJ, yet continued to operate it as a companion to WJZ and other stations of the network.

The Columbia Broadcasting System was organized on September 18, 1927, with J. Andrew White as president, the system operating a network of sixteen stations. W. S.

Paley became president on January 3, 1929. The Mutual Broadcasting System, with WOR, Newark, New Jersey, as a nucleus got started on September 30, 1934, having four stations in the initial network.

Continuous Striving to Improve Broadcasting

The wonder of radio broadcasting was thrilling, and for a while the novelty of "picking up" music from a station perhaps hundreds of miles away and the experience of selecting at will a program from any one of a dozen sending stations were wonderful enough without requiring perfection in reproduction. But as the number of listeners multiplied and the people became accustomed to the service, observation became more critical. The result of this was that broadcast station engineers continuously were given the benefit of a multitude of observation posts, many of which reported frequently and frankly on the grade of transmission.

Soon millions of persons became familiar with the terms "static," "fading," and "interference." The data the engineers were able to collect from reports sent in, and from their own investigations, made possible the renewed study of various phenomena on a scale that made progress possible.

Among the well-qualified engineers who engaged in broadcast work at the beginning was Raymond F. Guy. In 1921 he entered Westinghouse service at WJZ, Newark, continuing in the service of the Radio Corporation of America, which began in 1924. At that time he headed the engineering section, which had in hand the task of designing and constructing R.C.A. stations. Then in 1929 he joined the National Broadcasting Company as radio facilities engineer. Much of the outstanding improvement made in radio broadcasting has been the result of the work of Guy and his engineer associates.

Broadcasting, so far as the majority of listeners are concerned, has to do with the transmission of electric waves

overland. Much had been heard in the early days of wireless telephony about the perfect medium, the "distortionless ether." However, investigations carried on by Guy, Pickard, Austin, Weagant, and the telephone company's engineers in America, and by various investigators in other countries, early disclosed that space, as a medium for speech transmission, contains various elements (some of them transient and difficult to analyze) which present difficulties less likely to respond to treatment than factors such as those inherent in wire conductors.

The practice in broadcast telephony has been to send out a modulated high-frequency wave, made up of a band of frequencies ten kilocycles wide, but as pointed out by Bown, Martin, and Potter.¹

Analyzed into its elements and studied in detail, the modulated high-frequency wave is revealed as being an intricate fabric of elemental waves so interwoven with each other that no one of them can be disturbed without changing in some degree the complexion of the whole. For perfect results the whole band must arrive at the receiver with an amplitude continuously proportional to that leaving the transmitter, or the inflexions or expression of the speech or music will not be correctly reproduced.

Out of the examinations and studies of these engineers came the conclusion that interference between the components of the transmitted wave, in their travel from the transmitter to the receiver, is a major cause of signal variation. Providing good reception from broadcast stations presented new problems, varying somewhat from those which concern radio telegraphy. While it is true that the human ear is more intrigued by variations in intensity than by an average level of high intensity, the ear's response is not proportional to the intensity of the sound. It would seem that the ear by nature can select one sound upon which the mind may concentrate, disregarding others.

¹ Ralph Bown, D. K. Martin, and R. K. Potter, "Some Studies in Radio Broadcast Transmission," *Proceedings, I.R.E.*, February, 1926.

In an earlier chapter something was said in relation to elements of a radiated wave designated as the sky wave and the earth wave. Ralph Bown and his associates called attention to the fact that when two single-frequency, plane-polarized waves start out at the same time from a common source and travel by separate routes, converging at a distant point, the nature of disturbance at that point (as indicated by a radio receiver located there) is determined by the relative space phases of the planes of polarization, as well as time phases of the amplitude, of the two incoming waves.

It is a tribute to the scientific perception of Lee de Forest that early in his investigations he sensed the conditions of wave transmission which cause fading and interference. In a paper read before the newly formed Institute of Radio Engineers on November 6, 1912, speaking of these phenomena, he said:

... under these conditions there are acting at the receiving station two trains of waves which have traveled with unequal velocities. Consequently there will be a phase displacement between them and interference at certain localities. These are the nodes at which total or partial extinction of the oscillations occurs. . . . If the reflecting layer is half-way between the stations, its height is sixty-two miles under the conditions here assumed. Five minutes is sometimes the interval during which the effect persists. For its disappearance the ionized layer need rise only one-half of one wave-length. Almost never have both the waves faded at the same time. This shows that the reflecting stratum is at a great height. It is possible that the so-called "freak" performance in radio is due to this interference effect.

Radio Telephony across the Atlantic

It was natural that the rapid progress made in developing broadcast telephony should revive the idea of the possibility of establishing transocean commercial radio telephony. Obviously, there was not a profitable field for radio

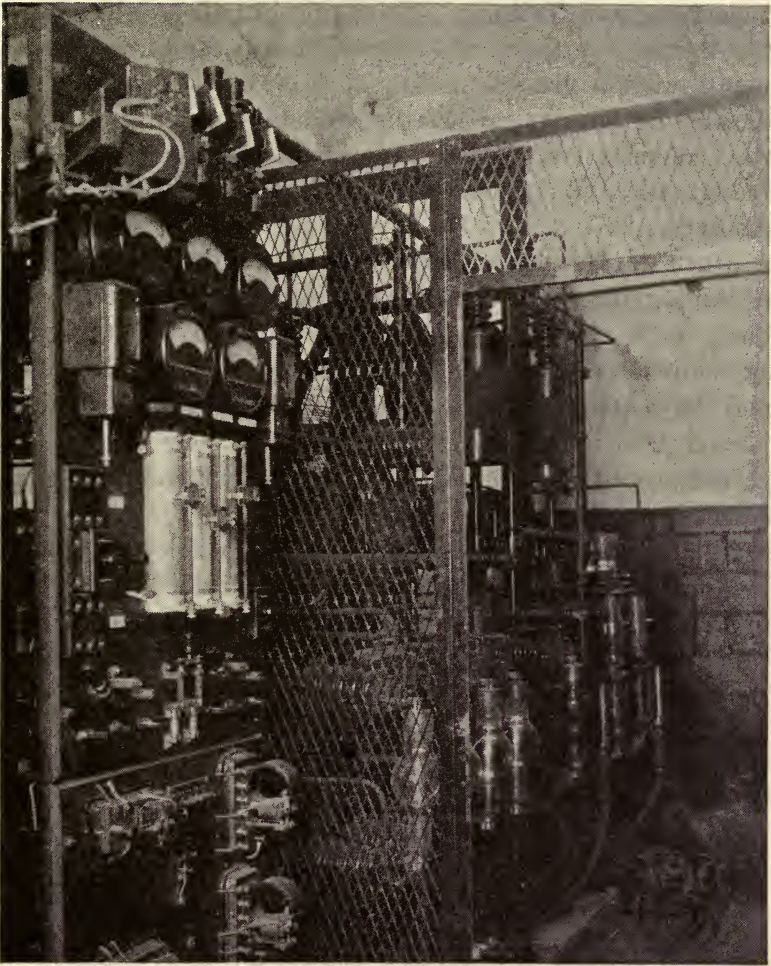

TUCKERTON TRANSMITTER

The 5-kilowatt, 600-meter continuous-wave tube transmitter at Tucker-
ton, New Jersey, 1926.

telephony where wire telephony already was dependably established. In any event, this was apparently true prior to the discovery of the peculiar properties of the micro-waves shortly before World War II. Transocean radio telephony, on the other hand, held out a possibility of exploitation, and in this field the engineers of the American

Telephone and Telegraph Company and the engineers of the British telephone system carried on a series of experiments with a view to learning the requirements, and to developing terminal apparatus necessary to maintain two-way conversation. These experiments culminated in the inauguration of transatlantic radio telephone service in January, 1927.

Much of the study of the phenomena involved in determining the requirements was carried along simultaneously with examinations into the vagaries of broadcast transmission and reception and, the medium being the same and the apparatus employed being similar, it might be expected that a considerable amount of new knowledge gained would have a bearing on the problems of broadcasting as well.

In the operation of commercial radio telephony and broadcasting, a difference in system requirements is that in the case of the latter it is of fundamental importance that the matter sent out shall be transmitted in such form that practically any type of radio receiver may be used to pick up the waves and transform these into sound, while with commercial telephony it is of importance that the waves carrying the words shall actuate only the receivers necessary to the conversation.

Out of the concurrent studies came the knowledge upon which much of the best of present-day broadcasting and commercial radio telephony is based. No little portion of this knowledge was developed by engineers of the American Telephone and Telegraph Company heretofore mentioned, and also by Austin Bailey, C. N. Anderson, H. T. Friis, G. C. De Coutouly, and G. D. Gillett, of the same organization, and by W. R. G. Baker, A. N. Goldsmith, Julius Weinberger, and Carl Dreher, of the Radio Corporation of America.

The significance of the word "carrier" as employed in radio telephone operation is related to an extensive prior

art² which followed closely the building up of wire telephone and wire telegraph services from the early days almost up to the time of the advent of the audion oscillator. When the high-frequency current produced by tube oscillators and associated circuits, and modulated by voice waves, is sent out in wave form, the original high-frequency (carrier) wave is accompanied by a sideband of higher frequency than the carrier wave and by a sideband of lower frequency. The sidebands represent the frequency range necessary for the transmission of speech, but it was early discovered that it is necessary only to transmit one of these, notwithstanding that ordinarily both sidebands are transmitted.

Tests of transatlantic radio telephony were made in 1915, and following the close of World War I,³ engineers of the American Telephone and Telegraph Company carried on experiments in one-way radio telephone transmission across the Atlantic. This was in 1923. In respect to the character of reception obtained in Europe, the results were an improvement over the earlier demonstrations. In 1924-1925 an extended program of measurements was initiated to ascertain the transmission conditions obtaining throughout the twenty-four hours of the day and the various seasons of the year, the measurements including transmission on several frequencies in each direction from radiotelegraph stations. In addition to the telephone channel, which was operated at 57 kc.

In addition to Arnold and Espenschied, some of the other engineers identified with these campaigns in the conquest of space were A. A. Oswald, J. C. Schelleng, W. H. Nichols and C. R. Englund. Like a well-organized exploring expedition this space-searching project resulted in the compilation of scientific data of the first importance.

² E. H. Colpitts and O. B. Blackwell, "Carrier Current Telephony and Telegraphy," *Journal, A.I.E.E.*, February, 1921.

³ Arnold and Espenschied, "Transatlantic Radio Telephony," *Journal, A.I.E.E.*, August, 1923.

The probing carried on day and night established facts with regard to the diurnal variations encountered, disclosing that a relatively constant field strength prevailed during the daylight period, and that there was a decided drop in transmission accompanying the occurrence of sunset along the transmission path between the widely separated test stations. Also, that the arrival of nighttime caused a rapid rise in field strength, which continued until the approach of daylight. The arrival of daylight at the European station caused a rapid drop in signal strength which continued into a morning dip similar to, but smaller than, the reduction at eventide; after which fairly steady daylight field strengths prevailed.

The indications obtained by these engineers confirmed that solar radiation is the controlling factor that determines diurnal and seasonal variations in the character of the received signal, transmission from east to west and west to east exhibiting similar characteristics.

When transatlantic radio telephony got under way the single sideband method, due to John R. Carson, was employed, the other sideband as well as the carrier wave being suppressed by filters, prior to amplification; the latter arrangement being due to George A. Campbell. The energy from a high-power amplifier was concentrated in one sideband radiated from the sending antenna, the power level being about three times as great as it would be if the carrier wave and both sidebands were transmitted, as customary in broadcasting.

Transmission Progress

Broadcasting stations were destined to take on a field of service similar to that of newspapers. What they were to send out was to be picked up by ear instead of by eye. The time was to come when they would daily, perhaps hourly, send out news matter. For manufacturers they were to promote sales through radioed announcements. The news matter and the sales announcements were to be interlarded with entertainment in the form of music, singing, and radio drama, with comedy sketches, round-table discussions, and routine for morning exercises, all addressed to the ear of the listener. The newspapers similarly publish news matter and the advertisements of manufacturers and producers, interlarding these with the comments of columnists, poetry, fiction, and comic strips, all addressed to the eye of the subscriber. The history of newspapers or of a newspaper always is of interest, but the history of printing is quite a different tale from that of the history of newspapers.

This work, therefore, purports to be a history of the mechanism and the machinery of radio, not of broadcast stations or of radio or broadcasting companies. In the course of time interesting histories of radio broadcasting will be written.

In this treatment our task is simplified only to the extent that the high lights of the technical advances concern the equipment of radio transmitting stations. Risking repetition in the interest of clearness, it may be stated as of the five or six years following the opening of KDKA, at Pittsburgh, that in ordinary broadcasting the stations sent out

radiation made up of the carrier wave and the modulating sidebands. The carrier wave was the one to which the radio receiver is tuned by adjusting the set's dials. The sidebands were introduced when voice waves affected the microphone (or music, or sound waves of any kind).

In transocean radio telephony the speech frequencies were transmitted by the method known as single sideband, carrier suppressed, and a receiver capable of responding to transmission of this type was designed to create the suppressed carrier wave locally. The first public demonstration of the single sideband, eliminated-carrier method of radio transmission, was made on January 5, 1923, by the engineers of the American Telephone and Telegraph Company, in telephony tests between New York and a station in England.

In the technical paper referred to in footnote 1, Chapter 26, the telephone engineers presented the results of a thorough survey of the conditions encountered in broadcasting up to that time. Their examinations into the causes of fading confirmed that different frequencies do not fade together, and when it is remembered that there are three frequencies making up the customary broadcast transmission—the upper sideband, the carrier, and the lower sideband—the significance of selective fading will be apparent. The three frequencies exist as three separate waves bound together only at the transmitter. If, therefore, selective fading in any instance causes the carrier wave to attenuate or, rather, not to appear at the receiver, it is plain that the sidebands, should they reach the receiver, can only “beat” together in the detector of the receiving set. From this it may be seen that it was essential that the carrier wave—for good reception—should reach the receiver in about the same outlines it had when it left the transmitter, and it will be apparent also that reception would vary, depending upon whether the components of the signal wave encountered any vicissitude or arrived in a condition indicating no interference.

State of Progress

Here, then, we have a measure of the progress made in the knowledge of wave transmission over the years. With three methods of transmission under consideration—carrier and upper and lower sidebands; carrier and single sideband; and suppressed carrier wave—it might be concluded that the choice for dependable service would be the method having a wave of the smallest number of components, which is the single sideband with carrier suppressed. And this is perhaps the method of transmission that would be the least subject to interference. But the fact is that the particular method of transmission employed by a broadcast station is mainly important to the listener situated on the outer fringe of the station's range. Were single-sideband, suppressed-carrier transmission used, it is obvious that owners of receiving sets would perforce have to supply themselves with sets that would locally supply the carrier wave, and this with close accuracy as to frequency and phase. But the broadcast listener would be in no mood as yet to have this requirement imposed upon him. A possible alternate solution, which was early visioned, is through the use of the single sideband, suppressed-carrier system of transmittance from a central, high-power broadcast station to regional broadcast stations, which in turn could rebroadcast the matter received by the carrier and double-sideband method.

Station Interference

In the early days of radio, whether or not a transmitting station was able to adhere to a designated channel in the ether was a matter of concern only to a small number of persons. But with a dozen broadcasting stations transmitting simultaneously from a single city, it may be realized that it was of the utmost importance that each station operate within the bounds of its assigned frequency.

Even now, when a station has assigned to it a definite

frequency, it has been customary to maintain between that station and other stations in the same area idle gaps in the ether, not used. For illustration, with a station separation of 10 per cent the relations might be: for station A, 270 meters (1,111,000 cycles); for station B, 300 meters (1,000,000 cycles). Obviously, the closer the stations adhere to their assigned frequencies, the less there will be of interference in listeners' receivers.

Many persons, still habitual users of radio receivers, may recall the radio conditions of the early nineteen-twenties, when it was no unusual thing to hear two or three radioed programs at the same time, the listener's task being to do everything possible by dialing to tone down the unwanted stations so that his mind might struggle with the program from the desired station. The situation was one in which the engineers, in the early years, found little but frustration in their attempts to keep broadcast programs from wandering away from their dutiful courses.

For a time it looked as if to wiggle out of that one would require the exercise of qualities such as those possessed at a later date by George Stevens, the Kingfish, of radio fame. But radio's star of destiny shone too brightly for any impasse to last long. For radio problems the answers were always somewhere about, and so it was in this emergency.

Control of Oscillation Frequencies

Long before the advent of radio it had been known that there are certain crystals which, while being heated or cooled, produce electrical effects. Crystals producing electricity in this manner are said to be pyroelectric. It was known that tourmaline, for instance, when heated attracts light bodies to its extremities. Also there was the phenomenon of piezoelectricity, dating back to inquiries made by Abbé Huay, in France, in the year 1800. The expression "piezo" is derived from the Greek word "piezein" which signifies "to press."

Silvanus Thompson, in England, in 1884, showed that

if two opposite edges of a hexagonal prism of quartz are pressed together, one becomes positive, the other negative electrically. About the time of World War I, A. C. Crehore and A. McL. Nicolson, in the United States, renewed investigation of the electrical properties of crystals. It was Nicolson's discovery that a piezoelectric crystal fixed between electrical contacts produced continuous oscillations when connected into a vacuum tube circuit, the action being related to mechanical movement of the crystal. Shortly thereafter, W. G. Cady¹ showed that the oscillation period of the crystal held the frequency of an electrical oscillator constant. He noted the sharp resonance properties of a quartz crystal, permitting frequency stabilization that was more constant than was possible with a simple electric oscillator. Cady showed a circuit having no electrical tuning, describing it as "a mechanically tuned feedback path from plate to grid of an amplifier," and later showed a crystal system connected between plate and grid, with no tuned circuit; also an identical crystal system between grid and cathode. At the time there was considerable discussion as to whether inductance or capacity accounted for the action.

Then, K. S. Van Dyke,² whose deductions were amplified by E. M. Terry, showed that the resonant element (the crystal) did not entirely account for the stabilization of the frequency. When a circuit is itself an oscillator, without the crystal, then the system may be said to be crystal controlled when a crystal is included. The early applications of the crystal were based upon the assumption that a linear relation obtained between grid voltage and the current in the plate circuit of the tube employed. Subsequent investigations, however, disclosed further variables and elements, several investigators attacking the problem from different viewpoints and hoping to uncover the whole truth.

¹ *Physical Review*, Vol. 17, p. 531, 1920; Vol. 18, p. 142, 1921.

² *Ibid.*, Vol. 25, 1925.

For radio applications Cady discovered that a quartz crystal may be employed as a resonator having use as a standard or gauge of frequency, and that by means of crystals the frequency of self-oscillating circuits may be maintained constant. Almost contemporary with the work of Cady, valuable contributions were made to the crystal oscillator art by G. W. Pierce.³

The natural quartz crystal may be regarded as a hexagonal cylinder surmounted by a hexagonal pyramid having four principal axes of symmetry. Three of these axes exhibit electric phenomena, inasmuch as pressure exerted on the crystal in a direction parallel to any one of these produces electric charges of opposite sign at the terminals



FIG. 47.—Four piezoelectric slabs cut from a quartz crystal.

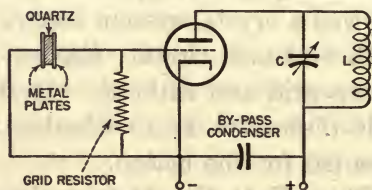

FIG. 48.—Circuit connections for a piezoelectric oscillator.

of the axis, and electric charges of opposite sign applied at the extremities of the axis produce a small compression in the crystal itself. The fourth axis of the crystal exhibits optical properties. As employed in piezoelectric oscillators in early applications, crystals were cut in such manner that the optical axis was in a plane of the oscillator and perpendicular to one of its sides. See Figure 47.

Although various crystals exhibit the piezoelectric property, it was learned that the natural quartz crystal, because

³ *Journal, Academy of Arts and Sciences, October, 1923.*

of its freedom from deterioration and its mechanical strength, was the most suitable for the purpose. A section of the crystal is taken at right angles to its length, and when this is placed between two metal contacts it is ready for use as an oscillator. Within the required limits for radio the natural mechanical vibration frequency of a given crystal is converted into electric vibrations, or oscillations, the oscillation frequency of a given crystal depending upon its dimensions. The thinner the crystal the higher its frequency; for a vibration frequency of 1,000,000 per second, a crystal of about the thickness of a silver half-dollar is required. This frequency remains constant provided the temperature of the crystal is maintained reasonably constant. The quartz crystal was a gift from nature to radio which, although simple and inexpensive, almost ideally met a need which had become pressing when channels multiplied to a large increase.

Application of the Crystal

An elementary application of the crystal is shown in Figure 48, where the crystal unit is connected in the grid circuit. In a self-oscillating tube circuit adjusted to the resonant frequency of the crystal, the action of the latter is to maintain the frequency of the circuit in step with its own natural oscillation period, provided that there occurs no excessive change in plate voltage, filament voltage, or load. Following the early work on crystal oscillators, soon associated circuits were devised by means of which a single piezoelectric plate could be employed as a standard for a wide range of frequencies used in radio signaling, and methods were devised for grinding plates to have very accurate frequency characteristics.

An important advantage of various interests, various independent laboratories, together with a host of bright and industrious amateur and experimental workers engaged in radio research, is that when the original scientific investigations, such as those of Cady and Pierce, result in the in-

vention of a new and useful device, the invention is at once taken up and given a wide and thorough service application.

Thus within a few years after the crystal oscillator appeared it was employed by amateurs using a few watts of power, as well as by large broadcasting stations having up to 50-kilowatt ratings. In the broadcast transmitters which had been successful in operating at nearly exact frequencies, it had been necessary to employ master oscillators. The crystal oscillators then took over this function.

An early example was the General Electric Company's 50-kilowatt station at Schenectady, New York, operating on 790 kilocycles (380 meters). At this station a quartz crystal was used for frequency control. A 5-watt tube and the crystal, in combination, served as a high-frequency generator, the output of which was determined by the natural rate of contraction and expansion of the crystal; a rate of 790 kilocycles per second in this instance.

The 5-watt tube directly connected to the crystal worked into a 50-watt tube, resulting in amplification of the original energy at the desired, fixed frequency. By connecting the 50-watt tube in turn to a 250-watt tube, further amplification was obtained, and so on to a fourth stage of amplification where a 1,000-watt tube was connected; thence amplification proceeded to a water-cooled 20-kilowatt tube (formerly the position occupied by the master oscillator). The 20-kilowatt tube, instead of being a self-excited generator of oscillations, was excited by the preceding stages of crystal-controlled amplification. The 20-kilowatt tube then excited a bank of eight 20-kilowatt power tubes, which produced the energy to be radiated from the antenna.

In America, in 1923-1924, C. W. Hansell and S. W. Dean, of the Radio Corporation of America, constructed the first high-power long-distance transmitter which made use of piezoelectric control of the radiated frequency. By the year 1939 V-cut crystals were made available, which hold a radio transmitter to its assigned frequency, within two

parts in a million, for each degree centigrade change in temperature. Other crystals were the X, Y, and AT-cuts.

In various radio services millions of these oscillators are in use daily, and in the numerous military communication undertakings of World War II piezoelectric technology played an important role.

Broadcast Transmitters

Differing from radio receivers which may be manufactured by the thousands of a particular model, radio transmitters, in the main, have been custom built, each transmitter designed for a particular service requirement, and in some instances for a particular location. The number of transmitters of any one design has seldom exceeded twenty, and the average number per design has been about fifteen. Gradually, transmitters came to be fitted with efficient accessories, and while the very large stations were licensed to use high power, the demand grew for transmitters in the 100- to 250-watt range, having high-fidelity characteristics.

In design, broadcast transmitters worked their way through various forms as experience was gained. The early transmitters were of what was termed "bread board" design, and then came the composite assembly in which the components were mounted in pipe framework, more or less open. After that arrived those constructed of angular frames and flat panels. About 1935 there appeared transmitters of the cabinet, self-contained type, making for compactness and accessibility. A feature was the concentration of all controls on a single, relatively small panel. Such features as Class B modulation, V-cut crystals, and alternating-current operation became the rule for transmitters of this class. In this particular line of transmitters the carrier frequency is generated by an 843 tube in an improved crystal oscillator circuit. The V-cut crystal has a temperature coefficient only a fraction of that of the X- and Y-cut crystals used in earlier transmitters—its use

making possible closer frequency control with less complicated temperature control arrangements—and the crystal oscillator circuits are in duplicate.

The oscillator is followed by a buffer amplifier, employing an 865 tube, and this in turn by an intermediate amplifier having a single 203-A tube. This latter drives a power amplifier, which is a push-pull hookup with two 203-A tubes, when the unit is used as a 100-watt transmitter or as an exciter. When used as a 100-to-250-watt transmitter, four 203-A tubes in multiple push-pull are used.

The radio-frequency stages are Class C and are self-biased. The audio circuits are operated push-pull, in the input, to ensure proper regulation in driving the modulated stage, which latter comprises two 203-A tubes in push-pull, Class B, transformer-coupled to the last radio-frequency stage.

Vacuum-tube transmitters were installed at the Chatham, Massachusetts, station of the Radio Corporation of America in 1921. In the following year that company began the substitution of tube transmitters on ships to replace the spark transmitters which for many years had been in service. In the marine sets, as at first installed, a master oscillator was employed to drive a power amplifier stage. A transmitter employing one or more amplifier tubes between the oscillator and the antenna system came to be called a master-oscillator power amplifier. In 1921, the long reign of spark transmitters and of solid-rectifier receivers was rapidly drawing to a close. Their work was done, and the museum shelves soon claimed those instruments which still by chance retained a gleam of their pristine polish.

There has not been, nor is there likely to be, prolonged cessation from devising improvements in radio transmitters. It is a continuing art, in research departments, in manufacturing establishments, and in radio stations. Much of the betterment has been the result of suggestions made by hundreds of bright young radio men who serve the

numerous broadcast stations as engineers or technicians. It is obvious that a very important component of radio transmitter assembly is the amplifier. In order to provide a linear relationship between input and output, tube amplifiers, as a rule, are operated over what is known as the straight section of their characteristic curves. That being but a part of the curve, the tube efficiency is not high. For broadcast transmitters, the higher powers required that the whole range of action of the tube be called upon.

As early as 1937, a high-efficiency transmitting amplifier, devised by W. H. Doherty,⁴ of the Western Electric Company, New York, was installed in a 50-kilowatt station, CBF, at Montreal, Canada. This amplifier system is incorporated in all Western Electric transmitters from 1,000 watts upward. In this amplifier the output tubes were divided into two groups, one group biased so that it contributes no output until the load is greater than the unmodulated carrier power. The other group carries all the load, at carrier output, which obtains during the bulk of the program time. With increasing load the first group takes up the task, and in addition to contributing to the output, causes the second group, through coupling, to add to the output. While half the tubes of the amplifier remain in reserve until the load builds up to a point where they can be operated efficiently, the average efficiency of the amplifier increases to over 60 per cent.

In radio transmission, improvement in the design of vacuum tubes continued through the years to play an important part. In 1925, C. W. Hansell and George L. Usselman, of the Radio Corporation, had contrived a 15-meter tube transmitter for short-wave message traffic in daytime service between the United States and Europe and South America. This transmitter worked at 7 kilowatts on 20 megacycles, employing a 20-foot high antenna, the whole at a cost of about \$15,000. When this service was first

⁴ *Bell Laboratories Record*, June, 1936; United States patent 2,210,028 (Aug. 6, 1940).

established 200-kilowatt machine alternators and 400-foot high antennas, one and one-half miles long, costing \$1,500,000, had been set up to handle the traffic, without particularly good results.

And in the short-wave fields also, Nils E. Lindenblad, of the Radio Corporation, in 1931, developed proof that lower frequencies could be multiplied in triodes subjected to axial magnetic fields, generating 115 volts at between 400 and 500 megacycles.

Important contributions in this field were made by I. E. Mouromtseff, of the Westinghouse Company. He developed a method of determining transmitting tube characteristics in the grid positive region. This engineer also contributed materially to the development of the first water-cooled transmitting tubes used in high-power radio. There is not space to enumerate the numerous detail improvements in radio made by these engineers. And they are not through yet. They will continue to devise, to invent.

Children of the Audion

Where should this music be? I' the air,
Or the earth?

It sounds no more—and sure it waits upon
Some god of the island.

The Tempest, I, ii

In Chapters 15 and 16 the genesis of the audion is dealt with in some detail. Actually, the wonderworking bulb is entitled to a history book of its own, but in this chapter it is the purpose to take up the audion's development and its applications in radio where the story broke off in the earlier chapters mentioned.

Lee de Forest's audions were manufactured for him at McCandless's miniature lamp works on Murray Street, New York. These were made in small quantities and for de Forest's use only. The present writer has vivid recollections of sundry visits at the McCandless walk-up shop in 1909, in the endeavor, for a consideration, to procure an audion or two. The bulbs were temperamental in nature, fragile, their filaments being of the irresponsible begetting common to Christmas-tree lamps of polychromatic delights. But they were intriguing. The very glow of the filament of a tube poised in the midst of other gear on a bread-board wireless receiver gave spirit to the entire outfit.

Following the historic events of 1912-1913, the manufacture of tubes scattered to several shops. We shall not take up the time of the reader here with a telling of the audion's fortunes by way of the "bootleg" manufacturers and vendors nor through the manufacturing establishments which sprang up east and west, in the open and under-cover, a few laps ahead of patent embarrassments. When the tube became of immediate importance and use to the

big telephone company in line-wire repeater service, that company's manufacturing subsidiary, the Western Electric Company, soon began the manufacture of tubes in quantities, tubes that were tubes, for their own needs.

A few years later, when the Radio Corporation acquired rights in the audion, other manufacturers began production. At first the Radio Corporation sold four types of receiving tubes. Two of these were made by the Westinghouse Company and two by the General Electric Company. The Westinghouse tubes were designed and manufactured at East Pittsburgh, Pennsylvania, and the General Electric tubes, designed at Schenectady, New York, were made in the General Electric lamp works, one at Nela Park, Cleveland, Ohio, the other at the Edison Lamp Works, Harrison, New Jersey, which latter plant eventually became the Radiotron Works of the Radio Corporation itself.

In the course of time, other manufacturers took on tube manufacture as patents expired and as new inventions were made in tube design and construction, notably the de Forest Company, Sylvania, Raytheon National Union, Arcturus, Ceco, Ken Rad, Hytron, and in later years various others.

The large electrical laboratories and manufacturing companies lost no time in taking the little audion apart and making it over into several families of tubes. Irving Langmuir, of the General Electric Company, discovering that electrons in a space free of gas build up a space charge that limits the current, as early as 1912 developed tubes having a power rating of several kilowatts.

Early in tube manufacture it was found that only metals of the smallest known content of occluded gas were suitable, and such metals had to be capable of being drawn to a fineness of 0.0004 inch and kept within tolerances that were close with respect to diameter, roundness, and hardness. They had to be pliable enough to permit coiling, and weaving into tiny screens. Under high temperature they had to be stable with regard to elasticity. In early tubes

platinum coated, was employed, and then tungsten, molybdenum, and certain alloys were substituted.

The problem of the filament was equally important and by 1914, thoriated tungsten filaments, devised probably by Langmuir, were in use for radio and by the telephone company for repeater tubes.

After the close of World War I, the considerable variety of tubes developed during the war years were made available for commercial uses, and in the following years a seemingly continuous differentiation took place in designing tubes for particular purposes and for special services. In 1921, when the public demand for radio receivers suddenly grew to vast proportions, typical tubes which were hurried into production included the Radio Corporation's UV-200 and UV-201 intended primarily for 6-volt storage battery operation and later, the WD-11 tube for dry-cell filament operation. The three-electrode tubes then available required direct-current supply for filament heating, and sets were manufactured and sold which had cabinet space for several dry cells (or a storage battery) for filament operation, and for three or more somewhat bulky 22½-volt dry batteries for the plate circuits. When dry cells were used for filament heating, set owners as a rule switched on their receivers only for limited periods. If left on for long periods the battery life was short. It was this situation which popularized the 6-volt storage-battery filament supply. But acid batteries in millions of home living rooms introduced difficulties which posed new problems for receiver designers. The need was widely recognized for vacuum tubes that would operate on ordinary public service lighting current at 110 volts, and this demand was met, ultimately, by the production of tubes containing a fourth element, known as a heater. This was in the form of a metal fixture within the tube and situated in close proximity to the filament. Alternating current applied to the filament caused it to heat up and in turn heat

this neighboring isolated cathode, which latter then became the source of the electrons in the tube.

In 1922 the Radio Corporation of America and other manufacturers of receivers employed UV-199, UV-171, and UV-201-A tubes having thoriated tungsten filaments. These were for direct-current filament heating.

The majority of radio receivers throughout the country, being located in communities where commercial power was available for house lighting, spurred the designers to produce receivers that would be all-electric operated, that is, directly connected to the house lighting circuit, not requiring either dry cells or storage batteries for the A or the B circuit. By means of transformers mounted within the receivers the 110-volt commercial power was stepped down to 6 volts for filament operation, and a transformer-rectifier-filter system, also connected to the alternating current, supplied power for the B circuits.

The alternating-current tubes soon replaced other tubes except where no alternating-current power was available. In these tubes the cathode, which becomes the source of the electrons in place of the filament in the direct-current system, consists of a sleeve, usually of cobalt, nickel, or iron, the outside of the sleeve being coated with oxides of barium and strontium. These metallic oxides give off electrons freely at relatively low temperatures. A popular type of the early alternating-current tubes was the UY-227, having a filament supply of 2.5 volts, fed from a winding of the power transformer.

By calling off the names of the audion's numerous progeny, it is possible to visualize how elementary the audion was in 1907; even in 1912. Once the highly sensitive superheterodyne receivers and higher-gain tubes got into circulation, following World War I, peculiar unwanted "noises" appeared in the output, which interfered with fidelity of reproduction. Parasitic sounds seemed to invade all receivers, and receiver designers had a bothersome task in distinguishing and cataloguing the interlopers. When

the otherwise efficient superheterodyne began to cut up it was recalled that, in Germany, Schottky, in 1918, had predicted on theoretical grounds that there existed two important fluctuation effects in vacuum-tube amplifiers (shot and thermal effects) occasioned by the finite size of the electrical carriers.

In 1923, A. W. Hull, of the General Electric Company's laboratories, was assigned the task of studying these noises, during which investigation he found that the shot effect was to blame, in the case of the superheterodyne disturbance. Out of this inquiry emerged a new and promising member of the audion family—the screen-grid tube in which feedback was greatly reduced; that is, a tube in which the grid and plate are screened from each other. Forthwith appeared the UX-222 tube, which found wide use in radio-frequency amplifiers. It resembled the UX-201-A tube, except that it had a metal cap at the top of the glass bulb connected to the control grid.

Fluctuation Noise

The difficulty encountered is worthy of note, since the studies directed upon it brought into the open characteristics of electron tubes which added materially to the growing book of knowledge. Stuart Ballantine, of the Boonton (N.J.) Research Corporation, conducted an investigation¹ into the role played by gas ionization in vacuum tubes, which subject had been on the project agenda of more than one engineer from the time the audion was introduced. Setting forth the problem and his findings, Ballantine stated:

Ions formed by collision in electronic amplifier tubes move toward the cathode and control-grid and produce momentary increases in the space-charge limited current (current pulses). These current pulses are random in time and produce fluctuation noise analogous to the shot-effect. . . . Both the noise and the increase in the average value of the electron current due to

¹ *Physics*, September, 1933.

the presence of ionization may be calculated in terms of the "size of the elementary event" or the integral of the current pulse. It is not feasible to calculate the latter directly but it may be evaluated indirectly by measurements of the increase of average current. The noise calculated from the values so obtained . . . is in close agreement with that observed experimentally. The production of noise in tubes with oxide cathodes containing mercury vapor, argon, and the gases naturally evolved from the electrodes and from the tube walls has been investigated experimentally as affected by pressure and electron current density. In the case of a tetrode containing mercury vapor or evolved gases the variation with pressure is linear up to 10^{-3} mm; in case of argon the noise varies as the 1.1 power of the pressure. In the mercury vapor tetrode the variation as the $3/2$ power of the plate current was found, as compared to the $5/3$ law, expected theoretically. These measurements were made at 620 kilocycles. The noise per frequency interval was measured as a function of frequency over the range 500-1, 500 kilocycles. At pressures of the order of 10^{-4} mm mercury vapor a decrease at the higher frequencies was observed; with argon the noise was uniform. With mercury vapor at higher pressures (ca. 4×10^{-3}) the noise spectrum became peaked, the frequencies of the peaks depending upon the electron current flowing (electrode potentials). The hypothesis that these peaks are due to oscillations of positive ions in the potential trough surrounding the cathode is in accord with the principal experimental facts. With further increase in pressure continuous oscillations are produced, sustained apparently by a regenerative action of the space charge upon the oscillating ions. The frequencies of these oscillations are affected only by the electrode potentials and not at all by the external electrical circuit.

Friendly, personable Stuart Ballantine comes to mind. Numerous New York radio workers can from memory visualize his appearance as he discoursed learnedly on this recondite subject. His death was untimely, due to a weakness which, long endured, left no escape except through work—work far into the night hours, driven by a characteristic urge to peer beyond the veil that obscures undiscovered scientific truths: work which left few waking hours

in which to think of the swiftly falling sand in the hour-glass of time.

It was from studies such as this that early in the decade beginning in 1930 came the variable-mu, or super-control, tube. In this type of screen-grid tube strong negative voltages on the grid were found not to force the plate current to zero value, and the difficulty of cross-modulation, until then experienced, was prevented. The tube was adapted to automatic volume control (see also Chapter 29) for intermediate-frequency and radio-frequency amplifiers and for loudspeaker output.

The Pentode Tube

In radio, as in everything else, one thing leads to another. In radio tubes, electrons from the filament striking the plate in the tube may, if traveling at sufficient speed, dislodge other electrons. In diodes and triodes these fancy-free electrons as a rule make no trouble for anyone because no positive electrode other than the plate itself is present to attract them, so that eventually they are drawn back to the plate. A plate thus bombarded by electrons gives off what is termed secondary emission.

In the case of screen-grid tubes the proximity of the positive screen to the plate offers a strong attraction to these secondary electrons, particularly if the plate voltage drops lower than the screen voltage. This effect reduces the plate current and limits the permissible plate swing in four-electrode tubes. Inserting a fifth electrode in the bulb, as in the pentode tube, removes the plate current limitation. The fifth element is called a suppressor grid, usually connected to the cathode. Because of its negative potential with respect to the plate, the fifth element retards the secondary electrons, shooting them back to the plate away from temptation.

The pentode tube joined the audion family in 1929, but it did not mix socially on a large scale until a year or two later. With a given input the pentode tube delivered

larger output than other tubes then in use, and it was made up in two types, a screen-grid type for voltage amplification and a power output amplifier type. The field ahead for the pentode was that wherein a desire developed for radio receivers with a minimum of tubes, which would still give good reception. In some receivers employing seven tubes, by using pentodes the bulbs could be reduced to four.

As the growing number of bright young radio engineers became acquainted with the beauties of the vacuum tube there was free-for-all opportunity to uncover new possibilities. There was no ceiling on ingenuity or invention; nor were feather-bed rules with respect to hours of work imposed from without.

Prior to the year 1928, tube development and application tended to call for "all-purpose" tubes; one tube type for various tasks. A three-electrode tube was used as a radio-frequency amplifier, an audio-frequency amplifier, an oscillator, and a detector. The engineers were aware that a single type tube was not performing efficiently in all these positions in a radio receiver, but the business was still young, and the public, paying money for receivers, regarded a vacuum tube as a vacuum tube. When a tube in a set owner's receiver "went bad," he had no idea other than that any tube he might purchase as replacement should serve in any position in the set. After a while, when radio servicemen established repair shops, a diversity of tube types became practicable.

Then tube design changed and special types appeared, each more suitable for particular uses. There arrived on the market, super-control radio-frequency amplifiers, heptodes, pentodes, and so on. Following these, multi-unit tubes that embodied in one bulb functions which previously required two or more tubes made their appearance. Among these were duplex diodes, duplex-diode pentodes, pentagrid converter tubes, and various other special types. These resulted in a saving of space and receiver cost that ac-

counted for the development of smaller and less expensive home, portable, and automobile radios. The era of roll-your-own, home-made radio receivers was passing. Mass production at large factories was turning out receivers that could be purchased for less money than their cost would be if constructed from parts purchased here or there. Radio sales shops sprang up like gas stations along a new two-lane highway.

As tube designers progressed with internal changes in tubes there was little likelihood that they would overlook altering the dimensions and shape of the bulb—all to good purpose. With the demand for radio receivers of still smaller dimensions, such as "midgets," there was need for further space conservation, calling for smaller tubes and these were promptly forthcoming, as also were other miniature accessories, each capable of doing what was required of it in receiver circuits.

A Radio Corporation of America product, the acorn tube, appeared in 1935. This was particularly useful in portable preamplifiers for remote-control work and in ultrahigh frequency receivers. It had reasonably low plate resistance with a comparatively high amplification factor. Low filament current made the use of small A batteries possible, and the small size and weight of the tubes made for compactness and portability. With midget transformers and other parts of reduced size the acorn tubes permitted reduction in dimension. In that year also all-metal vacuum tubes were introduced, which had mechanical advantages and more perfect and simple shielding. Contrary to early expectations, however, the metal tubes have not supplanted the glass-envelope types.

It is noteworthy that a gain, or amplification factor, of 3 in the early 201-A tubes has been increased to as high as 2,500 in some of the supercontrol radio-frequency pentode voltage amplifiers. Tubes of this type made possible the manufacture of inexpensive 4-, 5- and 6-tube receivers of the table model type, within reach of all pocketbooks.

There came along also the beam-power tube, such as the 6L6 and 50L6, now used in most radio receivers.

Ultrahigh-frequency Needs

The renewed exploitation, about 1936, of the ultrahigh frequencies was handicapped to some extent because of the inadequate equipment available to produce, dependably, an order of power output meeting current demands. The engineers knew that as the frequency of a radio-frequency generating device is increased, the efficiencies and consequent outputs are reduced. The critical frequencies of different types of triodes vary with the physical characteristics. In some instances high-capacity tubes suffered at frequencies as low as 7 megacycles. Although low-capacity triodes were built to operate on frequencies as high as 300 to 600 megacycles, the physical dimensions of most of these had to be reduced (in order to minimize lead inductances and interelectrode capacities) to such extent that the power capabilities were of the order of only a few watts.

There was need for a tube that would have an output of a kilowatt or more at frequencies in the vicinity of 100 megacycles. Such a tube came into being from the works of Eitel-McCullough, Inc., and was known as the 1,000-UHF. It was an imposing tube, 13 inches high, with a bulb width of 5 inches. The plate dissipation was rated at 1,000 watts, provided the tube was blower-cooled. In early applications this tube was used principally in push-pull arrangement because of the ease with which circuit symmetry could be achieved. The years ahead were to witness important improvements in the design of tubes for very high-frequency radio operation, as this field presented new opportunities for widely expanded employment of radio signaling. The vacuum tubes for this and related uses were destined to flower about the time of World War II. In postwar years there will be additions to tube terminology as a result of the application of devices such as the

Klystron, serving as a general-purpose radio-frequency source of approximately 3,000 megacycles.

As an index of what has taken place through the fast-moving years in the way of development, design, and manufacture of new, improved, and more complicated classes of tubes for performing various tasks, the following functional classification of the tube types, employed in sound-radio receiving equipment as of the year 1945, is enlightening.

Functional Tube Classification

Diode	Triode-hexode (octode) mixer
Triode voltage amplifier	Pentagrid converter
Triode power amplifier	Electron ray tuning indicator
Tetrode	Multi-unit tubes consisting of
Pentode voltage amplifier	various combinations of the
Pentode power amplifier	foregoing in single envelopes
Beam power amplifier	Half-wave rectifier
Hexode	Voltage-doubler rectifier
Heptode	Full-wave rectifier
Pentagrid mixer	Voltage regulator

Tubes of these general classifications are made in many types for operation from filament current sources of various voltages ranging from 0.7 to 117 volts.

In the year 1939, more than 140 tube types were announced by manufacturers, and in the year 1941 about 130,000,000 tubes were sold for civilian radio receivers. In all, some 820 different types of receiver tubes appear in the catalogues of tube manufacturers at the present writing. The tube types are numerous because, even though only a comparatively small number of these are being used in present-day receiver models, most of them must be carried in stock for replacement purposes in older models still in service. There is small wonder that the producers of tubes and receivers are desirous of standardizing a list of about forty tubes. A task, this, for the postwar years.

The spectacular progress of vacuum tube development

over the years had one Cinderella-like denouement worth recording here in concluding this chapter. It will be recalled that the early two-element tube, the Fleming valve, at first heralded as a radio detector, and for some years having limited use for such purpose in British Marconi service, was superseded as a detector when the three-element tube, the audion, was invented by de Forest. Relegated to the background to sit out the audion's popularity, the Fleming tube in time found more prosaic employment as one form of current rectifier in certain circuit applications. And then years after the patent litigation had ended and the patents had expired, the lowly "valve" blossomed forth to reign as a detector in its own right, christened anew as a "diode" (a two-electrode tube containing an anode and a cathode).

At the present time diodes (now having closer spacing) are employed in most radio receivers. They are still not particularly sensitive as detectors, but modern receivers have a sufficient number of tubes so that the incoming signal is well amplified before it reaches the detector. Also, diodes have the advantage that, with proper circuit design, signal distortion is inconsiderable. In effect, the reincarnated Fleming valve, the diode, is able to rectify incoming signals of larger current volume with less distortion than any other available detector. Improvisers can connect the grid and plate of a three-electrode tube together to fashion a diode, but Cinderella is jubilant, enjoying her renaissance.

Delivery of the Service

It may be a whimsical thought, but what might the effect be should some Deems Taylor, as radio concert commentator, instead of expatiating at length upon the uneventful life of the far-off, long-dead composer of the piece, announce that the performance for which the maestro was warming up his symphony orchestra was to be transmitted to the listeners, through the air, into their homes, received through the series of intricate processes described in this work; processes created by de Forest, Stone, Armstrong, Hull, Arnold, Ballantine, Heising, and numerous other radio scientists and engineers? A difficulty might be to phrase a routine for the narrator which would be informative as to the technology involved without causing the same boredom that long biographical deliveries produce. The notion may be eccentric, but then it could be anticipatory of some beneficent eventuality.

A succession of "soft" generations in America could possibly someday account for an America fallen prey to an alliance of aggressor nations whose citizens had for long been nurtured on stern routines. Generations arriving on the American scene and entering into the blessings, benefits, and conveniences of the work of technology (for instance, radio) are disposed to take these things for granted, with no thought (or knowledge) of how it all came about and with little or no knowledge of the persons whose ingenuity and labors brought the services into being. It might be profitable and be a remedy if education were to incorporate with technical instruction something about the human effort expended in creating the facilities which arriving generations find at hand, like the sunshine and the trees. In this there should be opportunity to inspire

emulation; to go forth and accomplish things such as have been accomplished by actual persons whom students have been told about or about whom they have read.

In Chapters 23, 24, and 25, our narrative deals with radio receivers, and now it is desired to describe some of the devices which have been used to render audible the silent electric waves of space once the radio receiver has plucked them from the void and transformed them into a true semblance of the character and volume of the sounds which at the distant transmitting station called the electric waves into being.

Although in Marconi's early experiments, and for a few years thereafter, in short-distance signaling, relay-operated tape registers were used in radio telegraph receiving systems to record the incoming signals, the employment of certain of the detectors as early as 1900 made it of advantage to use telephone receivers to read the incoming messages. The great sensitiveness of the telephone receiver, compared to any other known indicator of the presence of electric currents, at once permitted signaling over longer distances. For radio telegraph purposes, therefore, the telephone receiver has for long been used as a dependable instrument.

In the course of time tape recorders were again to come into use (at greatly accelerated speeds), and it was to become practice to operate printing telegraphs and facsimile systems by radio.

Headphones

The telephone receivers at first used were of the type designed for land-line telephone work, having a magnet-winding resistance of about 70 ohms. For radio uses it was soon learned that by winding the magnets to have a largely increased number of ampere turns, and by mounting two earpieces on a headband, the sensitiveness was increased.

Blondel, in France, in 1898, used a telephone receiver

for wireless telegraph reception, and Marconi in his transatlantic tests of 1901 used a telephone receiver in connection with a coherer detector. With the coming of improved detectors the telephone was found to be particularly adapted for signal reading. When the carborundum detector and the Fleming valve detector arrived following 1905, telephone receivers of about 8,000 ohms resistance were found to be suitable, while with the magnetic detector, telephone resistance of 120 to 180 ohms was satisfactory, because the telephone was in a local circuit. And in some other instances telephones of like low resistance were satisfactory when connected in the secondary winding of small transformers.

Throughout succeeding years several ingenious telephone receivers were developed and experimented with. G. W. Pierce, in America, invented a dynamometer telephone; and in Europe receivers introduced by Ader and Goloubitsky were successfully used. In Germany, Berger brought out a monotone receiver for wireless use. In England, in 1899, S. G. Brown invented a type of telephone receiver employing a vibrating member comprising a steel reed and a light, conical, aluminum diaphragm, attached at its center through the reed and at a short distance from the core axis. The idea was to provide a tuned vibrating member, or set of members, which would respond to various periodicities as required.

In 1914-1915, just as the contact detectors were about to give way to the audion-operated receivers, various attempts were made to amplify the signals rectified by the crystal detector by arranging so that the diaphragm of a connected telephone would in turn actuate a microphonic contact of a secondary circuit. The secondary circuit with local battery had sufficient energy to operate a horn type of telephone receiver. Devices of this type were proposed by Homer Vanderbilt and Stanley Hyde, in America, and were at about the same time experimented with by engineers of the French wireless telegraph service.

About 1917, C. A. Culver, in America, developed a new form of receiver particularly for wireless signaling, in which a tuned reed was associated with an electromagnetic system and an external acoustic resonating chamber (see Figure 49).

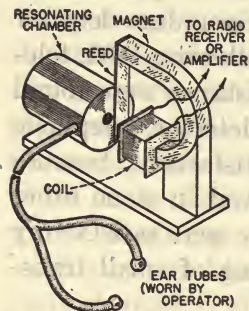

FIG. 49.—Culver telephone receiver of 1917.

From the year 1885 forward, investigations into the theory and efficiency of the telephone receiver were popular projects in college laboratories, as well as in the laboratories of the telephone companies. Engineering data gathered in investigations carried out by Professor A. G. Webster, in America, beginning in 1890, and later by Professor George D. Shepardson, of the University of Minnesota, also by A. E. Kennelly, of Harvard, constituted an important part of the knowledge on this subject made accessible to engineers entering the field at later dates.

What was perhaps the first headset telephone receiver especially designed for and sold for wireless purposes was that produced by W. C. Getz, of Philadelphia, in 1905 or 1906. The magnets were wound on a yoke so as to present both magnetic poles to the diaphragm, the spools wound with No. 40, silk-insulated wire, having a total resistance (in two receivers) of 2,000 ohms. The diaphragms were made of a compound of iron and a more ductile metal, such as gold, and were rolled very thin.

At about this same time C. Brandes, in America, began the manufacture of a line of receivers sold mainly to amateur experimenters, which were quite sensitive, and which, following the advent of broadcasting, sold in large quantities.

The Demand for Loudspeakers

Prior to the revolutionary radio events of 1912-1913, the energy available to actuate the telephone receiver was so

small that any type other than the earphone was of little use in practice. It was not until a way was found to amplify the received energy that there was a possibility of using loudspeaking telephone receivers which did not need to be held close to the ear. Loudspeakers of a rather inefficient type had since 1904 been in use in railroad telephone service on circuits used for train dispatching, but these required rather large operating currents, and the small horn fixed to the receiver introduced such distortion of speech that the instrument was tolerated only because there was nothing better to be had.

The idea of efficient loudspeakers for radio uses occurred to Oliver J. Lodge,¹ in England, years before there seemed any likelihood of finding use for them. He patented a speaker with a coil connected to a diaphragm, the coil "floating" in a strong magnetic field. However, when the demand was suddenly created, about 1922, for a satisfactory loudspeaker for radio broadcast reception there was none available. Excellent headphones produced by Brandes, Murdock, Baldwin, and the Western Electric Company were, luckily, in production and were extensively used until such time as suitable loudspeakers could be turned out by the manufacturers.

Soon ordinary phonograph quality was attained by attaching horns to telephone receivers, and for a time inventors were busily engaged in attempts to design horns that would effectively reproduce what the telephone type of receiver registered. When, following 1921, the public was able to procure radio receivers with some form of horn or loudspeaker, the standard of output was that of the phonograph after twenty-five years of development. Much of phonograph output was "tinny" in character, but it was sound reproduction of a sort. Radio output in the year 1922 with headphones was about as good or better than phonograph reproduction, but only two or three persons wearing headphones could listen in at a radio receiver.

¹ British patent 9,712 (1898).

And the telephone receiver was so sensitive that atmospheric electric disturbances were annoying when diaphragms were close to a person's ears. With the early horns and trumpets used in radio reception the sound was loud enough for a good-sized room, but the quality was little better than that of ordinary phonographs. The sheer wonder of any kind of radio made set owners noncritical. But the engineers knew the quality of the reproduction was not good. It was their problem to improve it.

The evident demand and the growing market for loudspeakers for radio receivers at once attracted the interest of large manufacturing companies, as a result of which the task of designing suitable loudspeakers came to the laboratories where trained engineers were waiting to do the work. Among the engineers who pioneered loudspeaker development appear some whose names may not have been mentioned earlier in this narrative of radio: From about 1922 to 1930, and somewhat later, the following engineers were outstanding in audio-reproduction invention: C. L. Farrand, E. W. Kellogg, C. R. Hanna, J. Slepian, Chester W. Rice, J. P. Minton, A. Ringel, A. Nyman, W. H. Martin, I. B. Crandall, J. P. Maxfield, H. C. Harrison, I. Wolff, H. F. Kranz, R. L. Wegel, Harvey Fletcher, Harry F. Olson, and Frank Massa.

In the course of the years very considerable improvements were to be made in audio amplifiers, which introduced changes in the engineering of loudspeakers, but in 1923, as stated by Nyman,² essential features which pertain to loudspeakers are that they shall produce uniform intensity of sound at all frequencies from 25 to 5,000 cycles per second; that there shall be absence of resonance points capable of responding at a frequency different from that applied, or giving an excessive volume of sound when their own frequencies are applied; that they shall have the ability to reproduce a combination of frequencies with a

² A. Nyman, "Electrical Loudspeakers," *Journal, A.I.E.E.*, June, 1923.

volume of each frequency proportional to the input; and that there shall be absence of distorting harmonics at any individual frequency applied. This seemed a large order in view of what was practicable in 1923; indeed, in later years some of these desirable features were developed through other means than the loudspeaker itself.

And since those years the desirable frequency range has been extended upward to some 8,000 vibrations per second for receivers of the high-fidelity type. A reason for the range specified by Nyman will be apparent from the fact that the fundamental-frequency range of a pipe organ is from 16 to 4,138 vibrations per second; of a piano, from 27 to 4,096 per second. The practical fundamental-frequency range of musical sounds, then, may be regarded as extending between 40 and 4,000 vibrations per second. However, the harmonics are to be reckoned with, and if the second harmonics, at least, are to be reproduced faithfully, an upper limit of 8,000 vibrations per second must be reached.

Each tone is composed of its fundamental frequency and several harmonics of higher frequencies, and in the design of loudspeakers it was found less difficult to provide for faithful reproduction of the higher notes than of the lower tones. A loudspeaker that will not reproduce a frequency as low as 256 (middle C on the piano), if it registers the note, is responding to harmonics of 256. A loudspeaker that gives out a tinny sound on the lower tones may in fact be responding only to the harmonics.

The problem of the loudspeaker was one which in its elements extended beyond the purview of the radio engineer. The solution of the problem was one which required on the part of the engineer a thorough knowledge of acoustics, of horns, of the propagation of sound waves in air, such



FIG. 50.—Horn type of loudspeaker.

as that applied by the designers of phonograph sound chambers.

In the beginning the designers of loudspeakers had the assurance that voice and musical tones were reaching the diaphragm of the telephone receiver, actuated by the radio receiving system, with a fair degree of fidelity, as evidenced by the performance of the high-resistance earphones. The task was to preserve as nearly as possible this quality while enormously increasing the volume of air set in motion by the diaphragm.

The design of improved types of sound-producing units of the general make-up of telephone receivers, with permanent magnet, electromagnet, and diaphragm, continued as a joint undertaking of radio engineers and telephone engineers, as a result of which numerous proposals for improvement were investigated.

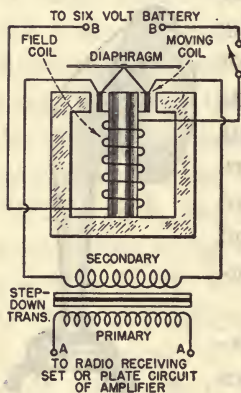

FIG. 51.—Detailed sketch of the Magnavox loudspeaker.

Early attempts to construct loudspeakers involved the association of a telephone receiver unit with a cone-shaped horn, as shown in Figure 50, but the volume of sound thus obtainable was small owing to the close spacing between the diaphragm and the pole pieces of the electromagnet; for the purposes of loud volume the diaphragm could not move freely and rapidly enough through a wide enough space.

Loudspeaker Developments

The movable coil type of loudspeaker, such as that proposed in Oliver J. Lodge's early patent and used in the Magnavox loudspeaker, permitted a much wider movement of the diaphragm without risk of chattering against the pole pieces of the magnet. Such a design is illustrated in Figure 51. The air gap through which the movable

coil traveled had in it a strong magnetic field, excited by a field coil. The moving coil was actuated by the signal-producing current. The principle of this arrangement had been applied many years earlier in submarine cable telegraphy in the design of the mirror galvanometer.

Another form of loudspeaker, which was introduced early and had numerous variations, was that known as the "enclosed armature" type, shown in Figure 52. This design was also employed successfully in the telephone receiver units due to Baldwin.

In this latter assembly, a small iron armature is situated in the center of a magnet coil, suspended by two thin wires. In one form the coil was surrounded by two U-shaped pole pieces forming two air gaps, the magnetic flux in the gaps being supplied by a permanent magnet. The current in the coil caused the armature to rock, which motion was in turn communicated to the diaphragm by means of a light connecting rod. Receivers of this type respond to frequencies up to and beyond 10,000 cycles per second.

A loudspeaker unit similar to that just described, designed somewhat on the lines of polar relays used in multiplex telegraphy by wire, had a thin armature situated between the four pole pieces (see Figure 52). In this unit the pole pieces were magnetized by a permanent magnet, the coils on the extremities being so connected and so placed that diametrically opposite pole pieces exerted attraction simultaneously. The motions of the armature were communicated to a corrugated aluminum diaphragm by way of a connecting rod. In loudspeaker units where the motion of an armature is transmitted to the diaphragm by way of a connecting rod, it is not necessary that the

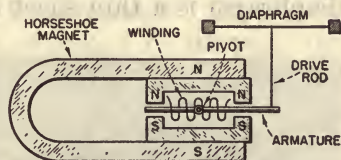

FIG. 52.—Detailed sketch of one of the early balanced armature loudspeaker units.

diaphragm be made of iron or other magnetic material, in which case mica, parchment, balsa wood, aluminum, or other light material may be used.

Actually, this forward step opened the way for the design and manufacture of several types of loudspeaker which measured up to the ideas of the engineers, and contributed to the public popularity of radio broadcast reception.

The loudspeakers of the early nineteen-twenties were largely the work of Irving Wolff and Abraham Ringel, and found use in Radio Corporation receivers.

For large rooms and auditoriums, C. W. Hewlett developed an induction type of loudspeaker, shown in Figure 53, which found some application. In this instrument the diaphragm is a thin sheet of aluminum rather loosely supported between two flat coils, the turns of wire being so spaced that there is sufficient freedom for the air waves produced by the diaphragm.

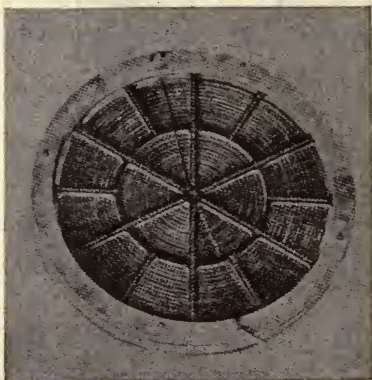

FIG. 53.—Hewlett induction-type loudspeaker.

Current from a direct-current source passes through the coil windings in such direction that a radial field is set up in the region of the diaphragm. The radio receiver output circuit is connected to the coils of the speaker in such manner that both coils serve as primaries to induce currents in the diaphragm. This proved to be a distinct departure in loudspeaker design as, other than the action of the diaphragm, there were no moving parts in the instrument.

In radio broadcast receivers as developed up to the year 1923, it was apparent that either the low tones were not reaching the diaphragm of the loudspeaker or the diaphragm was not adequately responding to these tones.

Forthwith engineers investigated the characteristics of transformers used in audio-frequency stages of amplification, and more efficient transformers were designed and produced; transformers which passed on to the telephone-type unit the low tones in faithful outline. Improvements were made in coupling, and bypass condensers, and impedance and resistance units employed in amplification. With the benefits of these improvements demonstrated, it was evident that in the final reproduction where the low notes failed to appear, the loss was occurring in the loudspeaker.

Departure from wire telephone practice occurred when it was learned that, for radio loudspeaker requirements, larger diaphragms could be used to advantage. Laboratory investigations carried on by C. L. Farrand, C. W. Rice, the Western Electric Company's engineers, and others resulted in the introduction of more efficient cone types of loudspeakers as represented by the Farrand speaker, Western Electric 540-AW, and the Pathé speaker.

The questions of diameter, thickness, shape, and material of diaphragms naturally were important. Theoretically it would appear that the movement of the diaphragm should be that of a true piston, that is, it should remain perfectly flat while vibrating in response to the actuating currents. It should have a maximum of rigidity commensurate with light weight. The early diaphragms of 2 inches diameter were replaced by diaphragms ranging from 2 to 36 inches, and larger. In the Hewlett speaker of 1921, a diaphragm of 24 inches diameter was employed. With diaphragms of larger sizes vibration amplitudes as large as $\frac{1}{32}$ inch took place. In the Gaumont speaker used in France, the diaphragm was in the form of a cone and was made up of thin silk on which was cemented a single layer of fine aluminum wire. Here was an extremely light and sensitive diaphragm and one free from resonance effects. In the speaker element the reaction of the voice currents in the

aluminum coil with the radial component of the magnetic field produced the driving force.

In America, C. W. Rice designed a loudspeaker on the Gaumont principle, improving the performance of the instrument considerably by providing a more flexible support for the rim of the diaphragm, as a result of which the low tones were reproduced more effectively. Rice introduced a diaphragm made up of a single layer of copper wire embedded in rubber, which was 4 inches in diameter and weighed 11 grams.

It was noted that the absence of the low tones in a loudspeaker was due in part to the circulation of air between the space in front of and in back of the diaphragm, allowing the sound waves produced by the motion of one side to cancel those produced by the simultaneous motion of the opposite side. Rice corrected this difficulty by employing a large baffle board that so increased the length of the path from the front to the back of the diaphragm that the cancellation effect did not occur for the low-frequency notes. With this baffle the total power radiated for a given movement was nearly 4 times that where the diaphragm is enclosed. A baffle 30 inches in diameter was employed in the first speakers of this type.

In the loudspeaker investigations of Rice and Kellogg, it was determined that a simple 45-degree cone, 0.007-inch to 0.010-inch paper, about 6 inches in diameter, with flexible support for the rim, consisting of a layer of very thin rubber, $\frac{1}{4}$ inch wide and under slight tension, made a satisfactory sound radiator.

With the rigidity possible with the light materials of cone speakers, it was early apparent that in the larger diameters the entire sounding surface does not vibrate with every note given out. Notes in the higher sound frequencies are produced in the center area of the diaphragm, while the low-frequency notes are produced by the area extending from the center to the rim. That is, as the voice or instrumental frequency increases, the outer area

of the cone will tend to remain stationary, the active (vibrating) area of the cone decreasing as the frequency increases. Conversely, the lower the note the greater the area of the cone set in vibration.

Improvement in the design, construction, and performance of loudspeakers had a wide and important bearing on the popularization of radio for entertainment purposes. But once the radio engineers turned their energies to inventing and improving loudspeakers there seemed no end to the variety of types that could be produced. Old principles were drawn upon to be put at work in radio. A loudspeaker called the condenser type appeared and gave good performance. About the year 1860, in Europe, the "singing condenser" was discovered, being a lightly rolled electric condenser made by placing a paper dielectric between two sheets of tin foil and using one electrode in opposition to the other sheet. When an alternating current was impressed across the tin-foil electrodes, the condenser gave out a musical note that must have astonished the experimenter who first heard a sound from such a source. The tone of the note, of course, depended upon the frequency of the impressed voltage.

The condenser type of loudspeaker functions because a mechanical stress is generated between the two electrodes as they are electrically charged, and when the charges vary the electrodes are moved back and forth according to the vibrations of the current. If two plates of such a condenser have considerable dimensions, then the sounds emitted by the movement of the electrodes have sufficient volume to serve as a radio loudspeaker.

Refinements in Radios for the Home

With the advent of radio broadcasting the demand grew rapidly for home receivers. The Radio Corporation in 1922 issued a receiver enclosed in a steel box, containing a single circuit tuner and a crystal detector. With a pair of headphones and antenna wire, the set sold for \$25.50. Some-

what more elaborate crystal sets were marketed at \$32.50 and \$47.50. The least expensive vacuum-tube receiver was a one-tube set manufactured by Westinghouse and marketed by the Radio Corporation. The tube was a WD-11 in a regenerative circuit, for battery operation. With batteries this receiver sold for \$75.90. General Electric Company receivers employed three tubes (detector-amplifier) and sold for \$250. And even at these prices for simple sets, it was a year before the suppliers were able to catch up with orders on hand.

During the decade when improvements were gradually being made in the efficiency of loudspeakers, other advances were keeping pace. Beginning about 1922, made-up power packs began to appear, called "B-eliminators," as substitutes for dry-cell B battery supply, where commercial lighting current was at hand. In 1925 "all-electric" receivers began to appear for direct connection to public power circuits, and requiring no batteries.

One difficulty, which did not seem particularly to annoy the public but which radio engineers viewed as little short of a curse, was that of "blasting" while dialing from one station to another. A person operating a receiver might tune in a program coming from a distant transmitter, or from a low-power broadcaster, requiring that the controls be adjusted for loud volume. Then, without thinking to alter the volume control the listener might turn the station-selecting knob for the purpose of picking up a different program. The new station selected might be but a short distance away or it might have much higher power than the station previously tuned in, and as a result the loudspeaker was very likely to emit stentorian blasts, alarming the neighbors. The rumpus was ended, of course, when the listener, as quickly as he could, toned down his volume. The engineers knew this wouldn't do. Something had to be done about it, and quickly.

A remedy for this disturbing condition was devised early

enough, but there were so many things to be done that some years passed before a remedy was applied. As early as 1923, a proposed method of automatic volume control was described in a patent application by Stuart Ballantine, but it was not until five years later that a passable method for automatic control of loudspeaker volume was applied.

Automatic volume control was designated as a system whereby the output voltage of a receiver is maintained at a practically constant value no matter what the strength of the incoming signal may be. The direct-current component of the output from the detector is utilized to control the bias on one or more variable-mu tubes in the radio-frequency amplifier which precedes it in the receiver circuits. The dynamic curve of the variable-mu vacuum tube is such that an increase of bias on the tube tends to lower its amplification, while a decrease in bias tends to increase the amplification. Increase in signal strength reduces the amplification of the preceding stages, maintaining the output volume practically constant.

With the early methods of automatic volume control the true sharpness of resonance of the receiver was obscured. Since the audible output tended to remain constant over a wide range of input levels as the receiver was tuned through resonance, the ear no longer served as a dependable monitor while tuning the receiver. Steps taken to improve receiver performance, therefore, included visual indicators of resonance, such as meters operating on the cathode current of the controlled tubes, neon lamps operating from the unregulated screen voltage, and so on.

In radio advance toward perfection, or near-perfection in service performance, there may appear to have been occasional hurdlings over stubborn obstacles toward desiderate objectives, reminiscent of the well-known railroad car windows, which no one seemed ever able to raise to admit fresh air, the need for which action being ultimately met by the air conditioning of trains.

A case in point is the situation with respect to the early broadcast receivers which had one or more stages of radio-frequency amplification, requiring that two or more variable condensers be tuned to the same frequency. Early receivers had on their front panels a dial and adjusting knob for each condenser. The public, operating radio receivers, had no thought other than that the multiplicity of dials was unavoidable. But the engineers were unhappy about the numerous adjustments in tuning-in stations. The procedure was time-consuming, and the separate condensers were not always tuned accurately, resulting in poor reception. It occurred to J. V. L. Hogan to leave the condensers where they were but to mount them on a common shaft. Thus a single dial replaced several dials. As the dial of these "ganged" condensers is turned all circuits are tuned alike.

In the year 1934, all-wave receivers appeared on the market, having tuning ranges covering services operating both on long waves and on the "short waves" of that period, and three years later what was termed push-button tuning was incorporated in receivers offered to the public. Several methods of push-button tuning were proposed, one of which was that of the Meissner Manufacturing Company. This system could be used in superheterodynes and tuned-radio-frequency receivers having a two- or three-section tuning condenser. It was recommended for single-band, two-gang receivers, providing full automatic operation of such sets. In receivers having three-gang condensers, but two sections were tuned by the push-button condenser assembly. If, however, the signal strength of the stations selected was adequate for good reception on a four-tube receiver, a receiver with five or more tubes would render satisfactory service when used with this push-button condenser assembly. The Meissner tuner provided selection of any one of six predetermined stations. A seventh button was used to return the receiver to normal manual tuning when desired.

Importance of Push-pull Tube Circuit

The output of radio receivers, in loudspeakers, is in large measure dependent upon correct amplification in the audio circuits of the receiver. Audio amplification may be of various types, such as resistance-coupled, transformer-coupled, and so on. The objective in any system is to provide distortionless amplification, and in this connection radio engineers have an understanding of the very great contribution made to radio by the so-called "push-pull" circuit assembly. They have an understanding also of the value of push-pull in wire-telephone repeater service, in radio transmitters, and in many other systems.

But only those engineers and experimenters who coaxed and nursed earlier amplifier hookups have an approximately close estimate of the virtue, the beneficence of push-pull when ultimately it flowered—ultimately, because, like the rose that wasted its sweetness on the desert air, push-pull was *born to blush unseen* for many a year. It was about forty years before push-pull came to radio that the first links in the chain of development were forged. A reason for the start being made about the year 1877 was that that year marked the widespread experimental attention directed to the possibilities of the infant telephone. Operating current in telephony was of small intensity, as was also the operating current in submarine telegraph working. So much so that from the beginning a need was recognized for current magnifiers, that is, amplifiers, so that there might be more definite and positive receiving-end currents and circuits operable over longer distances.

To place in position a first steppingstone, the reader might stretch his imagination a little and note British patent 2,909, issued to Thomas A. Edison on July 30, 1877, covering the invention for reproducing sounds at a distance. In the patent there is no mention of the word "telephone," but the drawings that accompanied the patent application depicted elements which shortly were to have a bearing

upon telephone development. For present purposes, reference to a Wheatstone-bridge arrangement of circuits in the Edison patent is the point of interest. This reference is brief, but viewed in retrospect it is seen that had the idea been fully developed, a discovery not at the time contemplated might have been made. The principle was applied in the Edison quadruplex telegraph system of the early eighteen-eighties, evidenced in the differential windings on the electromagnets of polarized relays—the winding of one coil extended to a companion coil in order to “clear out” magnetism and hasten the effect of current reversals.

Then between 1877 and 1915 there appeared a long series of inventions designed to improve telephone speech transmission, particularly in the reduction or elimination of distortion. A score or more patents were issued, over the years, based in the main upon the “double-microphone” method of voice transmission. None of them proved successful, due in large part to the fickleness of the loose-contact carbon block, or pocket of granules, interposed between the microphone diaphragm and the other transmitter contact.

By the year 1900 the telephone was struggling out of its swaddling clothes with a determination to set up service beyond the range of that time. A quickened quest was afoot for a telephone repeater. A rich reward was offered as the succulent plum for whoever should first come forth with a promising relay or repeater. We shall not here digress into that field (the answer came in 1912-1913, with the emancipation of the audion, as stated in Chapter 22). Rather we shall note only a step or two taken along this line, which connect with what was to eventuate in the domain of push-pull.³

In 1903, Isadore Kitsee, versatile, industrious, and prolific inventor of communication circuits and gadgets, filed a patent application in which there was evidence of the gathering up of prior thought for the purpose of making

³ *Communications*, November and December, 1943.

a new use of old devices. In this patent is shown an incoming single line acting on the telephone receiver magnet, attracting the armature which compressed the traditional pocket of carbon (or other medium) granules. In response to the incoming voice currents there was compression on one side of the armature and decompression on the other side. This action alternated in correspondence with the arriving alternations. The armature, the variable-resistance elements, and the receiver magnets were in circuit with batteries connected respectively to the primary windings of the output induction coil, and so to outgoing line. There it was! The double-element, double-primary transmitter (microphone) had worked its way to the other end of the line and had become a receiver—with the hope of becoming a repeater.

Ellwood Grissinger, in United States patent No. 1,198,212, issued on September 12, 1916 (applied for on February 24, 1902!), disclosed practically no variation from the arrangement of Kitsee. One difference was in the ingenious mechanical arrangement by means of which the variable resistance elements were actuated. This patent had the distinction of being acquired by the American Telephone and Telegraph Company, in 1916, a year after the issuance to E. H. Colpitts, of that company, of a patent covering a push-pull type of microphone.

And then a patent was issued to Thomas B. Dixon, of New York (United States patent 1,197,460) on September 5, 1916 (applied for on February 5, 1908; renewed January 24, 1916), which presented an inertialess, distortionless method of using the advantages of the divided primary winding of an output transformer. Instead of employing a slow-acting, pressure-contact scheme to obtain the push-pull effect in the induction coil or transformer, Dixon invented the method of directing beams of distortionless radiation from a mirror attached to the moving coil of a cable receiver upon a bank of selenium cells, each cell or bank of cells being in circuit with one side of the tapped

primary. The inertialess selenium cells took the place of the variable-resistance elements of the prior art's carbon buttons, or pockets of carbon granules. The advantages, therefore, of the split-primary, push-pull arrangement of the transformer became available for signaling.

In the meantime a converging line of effort gave to the world the audion. In 1915, United States patent 1,137,384; serial 839,318, filed May 18, 1914; application for re-issue filed April 9, 1917, serial 180,871, was issued to E. H. Colpitts, New York.

In the Colpitts push-pull amplifier-circuit arrangements, vacuum tubes appear in positions which in the prior art were occupied by pockets of carbon granules or by selenium cells.

The ultimate (vacuum-tube) push-pull arrangement accomplished more than was contemplated by earlier systems having similar circuit appearance. In a vacuum-tube push-pull hookup, when a voltage is induced in the secondary winding of a center-tapped input transformer, at the instant the positive component is applied to the grid of one tube, the negative component will be applied to the grid of the companion tube. If a C bias connected to the center of the input winding is 35 volts, and if across the entire secondary winding a peak alternating voltage of 20 appears, one tube has its negative grid voltage increased by 10 volts, to 45 volts, while the other is decreased by 10 volts, to 25 volts. One plate current decreases accordingly, the other increases. These alternating variations in plate current flow through the output winding and are transferred to the load. From this it is apparent that the current variations in the two plate circuits are out of phase by 180 degrees, one increasing, the other decreasing, a like amount. Their effect is additive in the output transformer (or choke). It is said that one tube "pushes" current through the output, the other "pulls" current through it. The terms "push" and "pull" are not accurate scientifically, but they were introduced early as convenient terms in explanation.

While the effect of the two tubes in a push-pull amplifier stage is additive, as mentioned above, this is true only so far as the fundamental wave form is concerned. The undesirable even harmonics of the fundamental wave, on the other hand, cancel each other and thus reduce harmonic distortion which is likely to be troublesome in power amplifier stages utilizing a single tube.

Push-pull, when it arrived untrammelled, was a lusty bidder for opportunity, which was immediately accorded the system. It had had a long and mixed ancestry. Soon its utility became established, and it has earned hundreds of millions of dollars in radio, talking pictures, and various other applications.

With respect to amplifiers it may be said that the achievement of a satisfactory *volume* of audio output did not in all systems result in undistorted reproduction. The advent of the terms "signal-to-noise ratio" and "signal-to-hum ratio" implied that there was a disposition of compromise abroad. If unwanted noise and unwanted hum could not at first be entirely eliminated from radio receiver outputs, some advantage was gained when it was provided that there should be an increase in the signal-to-noise ratio—a wider difference in the volumes of the wanted and the unwanted outputs.

In the period of the early thirties while a world-wide economic depression prevailed which adversely affected industry and markets, owners of radio receivers had worries more absorbing than those incidental to receiver noise or hum. Manufacturing incentive to produce improved receivers was at a low ebb. But it was about this time that an important step was taken which in the course of time, after much trial and calculation, was to afford a remedy.

The principle of negative feedback was introduced for reducing distortion, minimizing hum, and improving the frequency response in the normal range of amplifiers. In this system a fraction of the output voltage of an amplifier is fed back to the input in phase opposition to the signal

voltage. The result of this is that the voltage applied to the first grid is decreased, requiring larger gain to produce the same output as before the application of feedback. Then the actual input of the voltage of the amplifier is the difference in value between the signal voltage and the feedback voltage applied. For improved circuit stability these two voltages are not exactly equal, the feedback voltage being the smaller, but both should be large in relation to the difference voltage applied to the first grid. Practically, the feedback voltage is independent of tube constants or supply voltage; independent of the amplifier gain. In effect the difference between the two voltages becomes greater, so that the voltage applied to the grid of the first tube becomes greater, thus compensating for the reduced gain of the amplifier.⁴

Negative feedback has been commonly applied to audio-frequency amplifiers in receivers for reduction of nonlinear distortion and frequency discrimination in the amplifier itself or in the load circuit. Following the introduction of negative feedback there remained much to learn about the circuit factors, which turned out to be a task for the engineer-mathematicians in working out negative feedback exact equations.

⁴H. S. Black, "Stabilized Feedback Amplifiers," *Bell System Technical Journal*, Vol. 13, pp. 1-19, January, 1934.

The Expanding Sphere of Radio

Youth!

All possibilities are in its hands,
 No danger daunts it, and no foe withstands;
 In its sublime audacity of faith,
 "Be thou removed!" it to the mountain saith,
 And with ambitious feet, secure and proud,
 Ascends the ladder leaning on the cloud!

—Longfellow, "Morituri te Salutamus"

Radio, still a youth among the great industries of the world, has a destiny that no man can foresee. But the workers in radio at any given period, or at any state of progress of the art, put to work what they had invented and constructed. They knew well that it wasn't perfect, yet determined that through application and experience improvement should be achieved. How well they have succeeded in applying their inventions and improvements may be learned by reviewing briefly the wide range of services in daily operation up to the time of World War II. Some of these are transocean radio telegraphy to practically all countries; transocean radio telephony; radio-photo transmission; broadcasting, national and international; automobile radio; train communication; truck-transport communication; marine ship-ship and ship-shore communication; walkie-talkie communication; weather service; communication with remote trading stations, such as fur posts; airplane radio; police and fire radio; forest service communication; point-to-point high-frequency service; television; Navy radio; Army communications.

There will be little occasion to continue this narrative of radio much beyond the point where the subject is historical. However, inasmuch as during World War II there was a dearth of publication covering the late advances in radio,

a holiday in publicizing inventions and patents, it seems desirable to fill out the canvas up to the time of publication of this work. This procedure should, in any event, mark off a starting point for future historians of radio.

In the years immediately preceding the war, and through the war years, subjects which engrossed the attention of radio workers include those which might be designated electronics, television, facsimile, microwaves, frequency modulation, and radar.

That which is anticipated as coming within the scope of electronics embraces many operations in industry wherein the vacuum tube will serve as an agency of efficiency, of economy, and of speeded-up mass production. For the present it may be said that radio constitutes about 80 per cent of the applications of the science of electronics. Television, being part radio and part photography, should have a history of its own.

The subject of ultrahigh and very high frequencies and microwaves for radio and a variety of other employments is worthy of attention here because it marks a migration from the earlier cultivated fields of long electric waves to fertile areas of vast possibilities in the higher oscillation frequencies (short waves).

It has come to pass that ultrahigh frequencies are now the long waves while microwaves are the short waves of the future, the regions in which postwar radio development is likely to flower.

Microwaves

In certain operations of radio, with respect to the length of the electric waves employed, the progression from long to short coincided with the dictates of fashion in women's skirts, becoming shorter with the years. Following 1912, experimenters and private stations were by law, restricted to wave lengths no greater than 200 meters, this because waves longer than that were reserved for government and commercial useful services. But in 1923, a band extending

from 200 to 150 meters was thrown open for exploitation, and in that year the Bureau of Standards, Washington, conducted satisfactory tests on 105 meters, followed by A.R.R.L. tests at 100 meters. By 1924, the Radio League's experimenters were working on 20 meters, and a year later, on 1 meter, or a little less.

Thus, the region of the radio spectrum was invaded wherein down to a wave length somewhat below 10 meters communication is carried on mainly by means of waves reflected by upper sky levels, as explained in an earlier chapter.

There may be seeming confusion at present with respect to the place of microwaves in the radio spectrum, but this will be resolved in time. A decade hence it may be that evolution of thought will have brought about simpler differentiations, but for the present it is of advantage to distinguish in understandable terms between frequencies used in a variety of services. The terms "long waves," "short waves," and "microwaves," and "low frequency," "high frequency," and "ultrahigh frequency" are designations which type particular services as to distance range of operation and as to continuity of service throughout the 24 hours and through varying atmospheric conditions.

Any receiving instrument or device actuated by radio transmission is designed so that it may be tuned to a particular range in the radio spectrum, excluding higher and lower frequencies. This spectrum may be regarded as including frequencies ranging from about 30 kilocycles to 100,000 megacycles per second, and it is helpful to remember that 1,000 cycles equal 1 kilocycle, and that 1,000 kilocycles equal 1 megacycle.

Each amplitude-modulated radio broadcast transmitter operates on a frequency assigned to it, and it has been the practice to consider, (to avoid interference with other transmissions) that a station's band of frequencies should not be more than 10 kilocycles wide. For frequency-modu-

lated transmissions, television, facsimile operation, and so on, bands much wider are necessary.

It is informative to compare the characteristics of microwaves with those of other frequency designations. Adhering to terms at present in use, we have: VHF (very high frequency), 30,000 to 300,000 kilocycles; UHF (ultrahigh frequency), 300,000 to 3,000,000 kilocycles; and SHF (super-high frequency) 3,000,000 to 30,000,000 kilocycles. The last two groups combined are usually considered as constituting the microwave range.

Some interests seeking channels in the ether for one purpose or another proceed on the theory that there are channels enough for all contemplated, or possible, services, and to spare. In the VHF band there are theoretically 27,000 ten-kilocycle channels; whereas in the microwave range there are 2,970,000 ten-kilocycle channels. Obviously, when bands wider than 10 kilocycles are required, the available number of channels is much less than the figures given.

Indexing microwaves for communication uses between stations in line of sight prompts the query as to why some of the longer waves are of practical use in long-distance two-way communication, and microwaves in a range so limited as to distance. Waves as short as about 10 meters are still of sufficient length to be bent back earthward upon reaching the ionized layers of the stratosphere, affording skip-distance transmission over thousands of miles, as noted in previous chapters. However, in the sky-wave portion of microwave radiation the waves are too short to be bent back to earth. Thus, only the earth-bound portion of microwave radiation, so to speak, is available for communication purposes and other uses, and this only between points in line of sight between elevated antennas.

As the line-of-sight range of transmission of microwaves involves the obstacle of the curvature of the earth, it is evident that the elevations of the respective sending and receiving antennas are related to the range of operation in distance. There would appear to be an almost breath-

taking number of services which might be carried on within a score or twoscore miles, by direct operation. And, obviously, by means of relays to connect line-of-sight stations, it may be understood why there are predictions of revolutionary changes to come in the business of electric communication.

But through the postwar years all of this will develop concurrently with new vacuum-tube techniques, as the frequencies employed in various radio fields approach the centimeter-wave range. An understanding of the transit time of electrons between the electrodes even of diodes and triodes is essential to proper tube design, in connection with which new departures, new names, will appear in the gallery of radio scientists. Some future radio historian will recount the achievements of such workers as F. B. Llewellyn, D. O. North, W. C. Hahn, G. F. Metcalf, R. H. Metcalf, R. H. Varian, S. F. Varian, L. Tonks, Irving Langmuir, A. V. Haeff, G. C. Southworth, Simon Ramo, and others.

Frequency Modulation

Elsewhere herein it has been explained that to transmit speech or other sounds by radio, the intensity of the electric waves sent out from the transmitter must be varied in accordance with the intensity of the sound. The method in which this is accomplished by varying the amplitude of the wave is called amplitude modulation. A few years prior to the beginning of World War II, much began to be heard about frequency modulation, by which method the waves are radiated at fixed intensity but their frequency varied.

There was ever allure for the investigator in the concept that modulation could be accomplished in a variety of ways, by operating on any one of three parameters of a wave, namely, amplitude, phase, or frequency. The idea of varying the frequency in wireless-telegraph signaling occurred to early workers years before satisfactory methods of producing continuous waves were developed, and years

before radio telephony became a promising project. In the year 1902, C. D. Ehret,¹ of Philadelphia, filed patent applications contemplating the transmission and reception of telegraph signals, or speech, by varying the frequency. Once sustained frequencies became available, a system then known as "frequency modulation" was used in keying long-wave telegraph transmission, because it appeared simpler to vary the frequency than to interrupt high radio-frequency power in code signaling.

In 1925, C. W. Hansell and George L. Usselman, of the Radio Corporation of America, employed this system in keying radio telegraph circuits. But that system of operation which ten years later was to be known as frequency modulation had no relation to these early variations in signaling practice.

It was but three or four years prior to the diversion of commercial effort to the demands of communication in World War II that versatile Edwin H. Armstrong by long-practiced perseverance succeeded in attracting attention to the virtues of frequency modulation over a wide range of service frequencies.

Armstrong determined that natural and man-made electric disturbances which affect radio reception have roughly the same characteristics as amplitude-modulated signals. Hence, he proposed keeping the amplitude of the signals constant, altering the frequency when modulation is applied. This provided a signal differing in characteristic from that of radio or electrical "noise." A radio receiver was then designed to respond only to variations in frequency, by the use of a discriminator (detector) circuit and respond hardly at all to changes in the amplitude of the signals. This latter was achieved by the employment of what is termed a "limiter tube" operated at the saturation point in face of a reasonable frequency-modulation signal input. The circuit, therefore, would not respond to any amplitude variations above the saturation level of the

¹ United States patent 785,803 (March 28, 1902).

limiter-tube. The limiter tube circuit produces an increasing output for increases of input up to a certain point; then the output does not change, even though there is an appreciable increase in input.

Advantages of FM transmission are gain in signal strength, as the transmitter can be operated at full power regardless of the strength of the audio modulation applied; reduced disturbing noise, permitting effective increase in the signal-to-noise ratio in reception; and a reduction in interference from other radio stations operating on the same channel by a factor of as much as 30 to 1 when compared to amplitude-modulated signals.

What first appeared to be a drawback to the introduction of FM was that to secure its advantages a band of frequencies wider than that necessary for amplitude-modulated systems was required, for example, a band width of 150 kilocycles, 75 kilocycles on each side of the carrier frequency used. However, the late growth of radio techniques in the very-high frequencies, where band widths have not been at such a premium, opens the way for a wide application of FM operation. The first high-power FM transmitting station, W2XMN, was placed in operation in the spring of 1939, and within a year a dozen other stations were in operation.

With the impending invasion of the very-high-frequency realms of the radio spectrum by various projected communication and other services, the scramble is again under way, as it was about the year 1924 for elbowroom in the short-wave register of that period. Each service calculates what it will need in the way of frequencies, and the Federal Communications Commission has the task of distributing the usable frequencies to what it believes to be the best advantage of all.

With respect to FM service, the Commission has favored raising the frequency from 42-50 megacycles to 84-102 megacycles to avoid, as they assert, sky-wave interference. On the other hand, the promoters of FM broadcasting de-

clare that this would cost the public millions of dollars and paralyze the industry for two years in the postwar period. No matter what new frontiers in space radio invades, there always appear new and unusual services waiting for the aerial gangways to be opened.

There is warrant in this work only for the foregoing historical reference to FM, to place it chronologically with respect to previously recorded radio developments. Detail study of the system is for the textbooks.

Radio's Future—Television and Radar

If we have succeeded in confining the range of this work to a treatment purely of radio, there is little occasion in the concluding paragraphs to devote space to a consideration of the history of radio's numerous by-products. The principles and operation of television are described for practical study in textbooks. It is peculiarly true of radio science that the workers of a given period have been able to review the records of earlier years and to profit therefrom, recovering from shelved or abandoned ideas principles for which uses have been found. Someday the poets may catch up with what radio workers have been about during the past fifty years. Only the poets have the words for what is in men's souls, the cipher to decode the emotions in men's minds and hearts. And what emotions some of the workers in radio have experienced! On a summer night in the year 1921, Harold H. Beverage, of New York, then in Brazil to learn the strength of radio signals reaching South America, while observing the signals arriving from a station in the Philippine Islands was startled to note that the signals were arriving not only by way of the Pacific Ocean and across South America, but also from the east, halfway around the world and across the Atlantic. Peary and Byrd, perhaps, would know of thrills of that nature.

The Kennelly-Heaviside predictions of 1902 and the later confirmations of the reflection of radio waves from the

upper atmosphere back to the earth, dealt with in earlier chapters, were destined to bear strange fruit. For that matter, Hertz's primitive experiments of 1886 demonstrated that radio signals are reflected from solid objects, and in 1904, a German physicist was granted patents in several countries for a proposed method of applying this principle in an obstacle detector and a navigation aid.

Throughout the years of World War II, rivaling other newfangled devices and robot bombs, the term "radar" came to signify the working out of vast new operations on land, on the oceans, and in the air. The name was coined from its use as a radio detection and range finder. The history of radar may not be completely told until all countries engaged in World War II have been heard from through their technical journals—possibly not until courts of law have had the final say. However, inasmuch as this spectacular by-product of radio is sure to be subjected to much study in the years immediately ahead, and because its utility opens up new vast possibilities for radio expansion, it may be informative in this closing chapter to mark some of the early milestones which measured progress.

In England, in 1919, Robert A. Watson-Watt filed patents covering radio direction-finding systems, and in America, in 1925, the principle of pulse ranging was employed by Dr. Gregory Breit and Dr. Merle A. Tuve, of the Carnegie Institution, Washington, for measuring the distance to the ionosphere. In the United States, also, Dr. A. Hoyt Taylor and Leo C. Young, in 1922, observed radio reflection from a passing steamer in the Potomac River. In 1930 these physicists noted the reflection of electric waves from a cruising airplane.

In 1934-1935 a small group of civil servants and RAF officers considered a well-worked-out plan for detection of aircraft by a pulse method, based on Watson-Watt's developments. The first installation was made in 1935 on an island off the east coast of England. By 1936 five sta-

tions, about twenty-five miles apart, were set up to protect the Thames estuary. In America, in 1934, engineers in the service of American commercial manufacturing companies were at work on the device. To mention one staff, Irving Wolff and his R.C.A. associates in this year began work which culminated, in 1937, in the manufacture of practical apparatus ready for the national services.

In Great Britain, in 1937, the Air Ministry ordered fifteen additional radar stations, and by the time of the Munich crisis, in 1938, these stations were detecting incoming German airliners before the planes came within sight of the English coast. By 1938 these stations were in operation under the Royal Air Force command.

The word "radar" does not refer to a single instrument. A particular installation of radar may be a 100-lb. outfit, for use on a fast airplane, or it may be a scattered arrangement of shacks and trucks having its own telephone central, with a huge antenna structure, and with a company of soldiers to man it. A radar installation may consist of five tons of equipment disposed about the deck of a fast carrier, or for specific services it may be a couple of watertight containers within the confines of a PT boat.

The early equipment, for land detection stations, was bulky. So much so that in 1932, the then Secretary of War of the United States after considering its possibilities in warfare officially suggested that the device might be of more use to the army than to the navy. In 1934 plans were made to devise a system wherein the sending and receiving equipment could be accommodated on a single ship. In this undertaking important work was accomplished by Robert M. Page of the United States Naval Research Laboratory, Radio Division. In 1936 a complete outfit was installed on a navy ship and by 1938-1939 a thoroughly practical shipboard model had been designed, operating on 1½ meters. In 1936, also, the army's first pulse radar was designed as a system at the Signal Corps laboratories.

For airplane detection, the late Paul Watson and Major

General Roger B. Colton, of the Signal Corps laboratories, employing improved transmitting tubes, worked at $1\frac{1}{2}$ meters and introduced lobe switching and other refinements, which led to the development of an antiaircraft detector for searchlight control and gun-laying.

On August 8, 1940, the German air force attacked England, and on September 7 the mass raids against London began. In that year the decision was made that the British and American physicists and engineers should combine their activities in connection with radar, and Sir Henry Tizard came to the United States to contribute toward co-ordination of effort. It had become plain that for all the various radar services contemplated, resort must be had to shorter wave lengths. The British were able to make a telling initial contribution by supplying an improved magnetron tube, which could be adapted to the pressing needs.

In the United States, a Microwave Committee was set up, headed by Dr. Alfred L. Loomis, to explore the microwave radio spectrum for radar utility purposes, and although in the beginning there was no satisfactory source of power for the projected frequencies, this was remedied by adaptations of the magnetron tube, work being done at the Massachusetts Institute of Technology under Dr. Lee A. DuBridge. In January, 1941, this laboratory obtained echoes from its first microwave radar set, and throughout the year rapid progress was made.

It was not radar's fault, out on the American ramparts, that the Japanese airmen scored at Pearl Harbor on December 7, 1941. The Signal Corps radar installation, if in an elementary form, was in operation and ready for service. Young Joseph L. Lockard, private, on his own initiative, swept the skies with the outreaching, invisible fingers of the available equipment and detected planes approaching Pearl Harbor, locating the planes about a half-hour's flight time from Hawaii. As one link in the chain between detection and the American guns, Lockard at once reported to

a superior officer who, thinking that a squadron of planes was due from California, concluded that it was these planes Lockard and radar had spotted, and took no action—or so it was reported. Followed quickly onslaught from the skies, and destruction.

The earliest radar installations were operated on wave lengths of several meters with correspondingly broad beams, except in cases where very large antenna structures were employed. At the beginning of the war wave lengths of a meter and a half were about as short as was practicable. Under the pressure of war's needs and with no expense spared, microwaves soon were harnessed to radar.

In the main radar's transmitter and receiver are located at the same place, and may have a common antenna. The transmitter sends out energy only a small part of the time, in the form of pulses, which may be but a few millionths of a second in duration. Between sending pulses the receiver records the echoes.

That radar is, in the main, the name of a radio service is evident from the fact that the assembly includes a modulator, a radio-frequency oscillator, an antenna with suitable scanning mechanism, a radio receiver, and an indicator. The radio-frequency oscillator is usually a vacuum tube of suitable design; or it may be a group of tubes which oscillate at the desired radio frequency and yield the desired bursts of power when connected to the modulator. The receiver usually is of the superheterodyne principle, housed in a small box. The departure from radio communication signaling construction resides in the indicator, which in most cases comprises one or more cathode-ray tubes. In one presentation the electron beam is given a deflection proportional to time in one direction, say horizontally; and proportional to the strength of the pulse or echo in the other, say vertically. If no signals are visible a bright horizontal line appears (the "time base") across the face of the tube, the distance along this line representing elapsed time after the outgoing pulse. A returning

echo gives an inverted V-shaped break (called a pip) in the line at the point corresponding to the time it took the echo pulse to return to the receiver. The position of the image along this line indicates the distance to the reflecting object.

In another form of presentation, the echo pulses establish a sort of map on the face of the cathode-ray tube. The picture is not the same as that presented by television. The "blobs," as they are called, do not actually look like ships or airplanes, but are interpretable by trained operators. When the maplike picture appears, the echo signal, instead of causing a break in the time base, intensifies its brilliance for an instant. Each signal, therefore, appears as a bright spot of light at a position corresponding to the range and the bearing of the target. In this case the time base starts at the center of the indicator and moves radially outward in a direction corresponding to that in which the antenna is pointing, the time base rotating in synchronism with the antenna.

The Signal Corps radio set SCR-268 is a mobile, trailer-mounted radar outfit for use by anti-aircraft batteries to help them locate, track, and shoot down enemy airplanes. It determines the height, direction, and distance of the plane. By electronic lobe switching the plane is caught between two beams, both horizontally and vertically, and tracked continuously. The echo appears on three cathode-ray oscilloscopes mounted in front of the operators on duty. Each operator watches a pair of visual echoes seen in the viewing screens, and maintains adjustment so that the echoes remain of equal height. As they do this, accessory apparatus automatically points remotely located anti-aircraft guns and searchlights at the target.

Radar's spectacular projection into the sanguinary business of warfare so soon after its various utilities were recognized left no time to accord public honors to the radio workers who developed it. As one naval radio officer, aware of radar's usefulness through the war, declared: "For the

makers of radar the bells did not ring, the Bible was not quoted, nor were gold medals distributed."

So, with this brief account of radar, radio's most recent gift of vast promise to man, the thought here intrudes that, instead of memorializing the Conquest of Space, in this narrative we have been moving toward a boundary line marking the beginning of a new campaign in the Conquest of Space.

Name Index

- Abraham, H., 149, 250, 259
Adams, James, 49
Ader, 331
Airy, H. M., 212
Alexanderson, E. F. W., 77, 91, 201,
202, 215, 263, 293
American Radio Relay League, 193,
198, 275, 353
American Telephone and Telegraph
Company, 218, 235, 297, 301, 306
American Wireless Telephone and
Telegraph Company, 287
Ampère, André Marie, 7
Anderson, C. N., 302
Appleton, E. V., 145, 193, 268
Arago, Dominique F. J., 9
Arco, George von, Count, 46, 96, 113,
171
Armstrong, Edwin H., 171, 174, 176,
182, 260, 268, 272, 275, 356
Arnold, Harold D., 184, 219, 236
Arons, L., 35
Artom, Alessandro, 88
Aschkinass, 114
Austin, Louis W., 129, 136, 154, 181,
185, 212, 268

Babcock, C. D., 164
Bachelier, Charles, 49
Bachofer, 16
Badt, F. B., 48
Baeumler, M., 212
Baeyer, O. von, 169.
Bailey, Austin, 302
Baker, W. R. G., 190, 302
Ballantine, Stuart, 203, 321, 343
Balsillie, 104
Barkhausen, G. H., 196
Barnett, M. A. F., 193
Beard, G. M., 49
Bell, Alexander Graham, 23, 35
Bell System Technical Journal, 219
Bellecize, H. J. de, 212
Bellini, Ettore, 93, 215
Bennett, Edward, 203
Berger, 331
Berliner, Emile, 47
Beverage, H. H., 92, 212, 216, 358
Bezold, W. von, 29

Bijl, H. J. van der, 184, 220
Bjerknes, V., 60
Black, H. S., 350
Blackwell, O. B., 302
Blatterman, A. S., 247
Blondel, André E., 46, 84, 88, 330
Bolitho, J. B., 271, 280
Boltzmann, L., 35
Bown, Ralph, 194, 299
Boys, Vernon, 35
Brandes, C., 332
Branly, Edouard, 37, 111
Braun, Ferdinand, 46, 59, 60, 88, 127
Breit, Gregory, 193, 359
Brillouin, Lieut., 259
British Broadcasting Company, 297
British Marconi Company, 171, 253
Bronk, O. von, 263
Brown, S. G., 331
Buff, Prof., 157
Burghard, George, 260

Cady, W. G., 309
Callan, N. J., 15
Campbell, George A., 220, 304
Canadian Marconi Company, 205,
285
Cann, J. O. G., 294
Carson, John R., 151, 236, 304
Carter, Philip S., 213
Carty, John J., 35, 150
CBF (Montreal), 315
Ceco Company, 318
Chaffee, E. L., 104
Chapman, S., 192
Chubb, L. W., 289, 290
Clark, George H., 215
Clemens, J. S., 145
Clement, L. M., 236
Clifden Station, England, 102
Coats, D. P. R., 294
Cockaday, L. C., 281
Cohen, Louis., 134, 268
Colin, Lieut., 229
Collins, A. F., 228
Colpitts, E. H., 220, 347
Colton, Roger B., 360
Columbia Broadcasting Company,
297

- Commercial Cable Company, 142
 Coolidge, W. D., 170, 184
 Continental Wireless Telephone and
 Telegraph Company, 287
 Conrad, Frank, 289, 290
 Coutouly, de, G. C., 302
 Craft, E. B., 236
 Cram, E. R., 250
 Crandall, I. B., 334
 Crehore, A. C., 309
 Crocker, F. B., 51
 Crookes, William, 42, 110
 Cross, Charles R., 78
 Culver, C. A., 332
 Culver, C. C., 240
 Curtis, A. M., 236
 Cutriss, Charles, 36
- Davis, H. P., 290
 Davy, Humphry, 5, 9
 Dean, S. W., 312
 De Forest, Lee, 63, 86, 100, 114,
 115, 124, 156, 167, 171, 174, 193,
 224, 291, 300
 De Forest Wireless Telegraph Com-
 pany, 88, 125, 318
 Dellinger, John Howard, 154
 Dempster, J. T. H., 77
 Deviny, M. A., 247
 Dieckmann, M., 95, 119, 213
 Dixon, Thomas B., 347
 Doherty, W. H., 315
 Dolbear, Amos E., 24, 52
 Donitz, 247
 Dreher, Carl, 302
 Dubilier, William, 225
 Du Bridge, Lee A., 361
 Dudell, W. D., 71, 90
 Du Fay, C. F., 159
 Dunwoody, H. C., 125
 Dyck, A. F. von, 134
 Dyke, K. S. von, 309
- Eastham, Melville, 232
 Eccles, W. H., 149, 186, 208
 Eckersley, T. L., 91
 Edison, Thomas A., 24, 49, 106, 157,
 346
 Ehret, C. D., 356
 Eichorn, G., 247
 Einstein, Albert, 152
 Eisenstein, S. M., 79
Electrical Experimenter, 145
Electrical World, 146, 153, 167, 178
Electrician, 169
 Elster, Julius, 160
 Englund, C. R., 195, 236
 Espenschied, Lloyd, 179, 236, 290,
 303
 Ewing, J., 122
- Faraday, Michael, 7
 Farrand, C. L., 212, 334
 Farrar, Mme Eugenia, 291
 Fedderson, Berend, 22
 Federal Communications Commis-
 sion, 359
 Federal Wireless Telegraph Com-
 pany, 289
 Ferrie, Gustave, 46, 84, 114
 Fessenden, Reginald A., 74, 99, 116,
 133, 164, 208, 223
 Finn, William, 48
 Fitzgerald, G. F., 27
 Fizeau, Armond H. L., 17
 Fleming, J. A., 42, 78, 91, 97, 124,
 128, 148, 154, 157, 161
 Fletcher, Harvey, 334
 Flewelling, E. T., 281
 Forbes, E. D., 134
 Foucault, Leon, 34
 Franklin, C. S., 91, 171, 200
 Fredenhagen, 170
 Freir, S. P., 48
 Fresnel, A. J., 202
 Friis, H. T., 302
- Galvani, Luigi, 4
 Gaulard, Lucien, 65
 Geisenheimer, 77
 Geiter, Hans F., 160
 General Electric Company, 289, 312
 Getz, W. C., 332
 Gibbs, John D., 65
 Gillett, C. D., 302
 Godley, Paul F., 275
 Goldschmidt, Rudolph, 135, 231
 Goldsmith, Alfred N., 179, 290, 293,
 302
 Goloubitsky, 331
 Goulton, M., 259
 Gowen, Robert F., 294
 Gramme, Zénobe T., 64
 Gray, Elisha, 24, 47
 Gray, Stephen, 4
 Grebe, Alfred H., 281

- Grissinger, Elwood, 347
 Guarini, Emile, 139
 Guthrie, Frederick, 169
 Guy, Raymond F., 298

 Hack, 153
 Haeff, A. V., 355
 Hahn, W. C., 355
 Hallborg, Henry E., 134, 203
 Hallwachs, W., 170
 Hanna, C. R., 334
 Hansell, C. W., 213, 312, 315, 356
 Harrison, H. C., 334
 Hartley, R. V. L., 266, 281
 Hausrath, 214
 Haug, Abbé R. J., 308
 Hazeltine, Alan, 179, 186, 266, 268
 Heaviside, Oliver, 23, 59, 146
 Heising, Raymond A., 192, 235
 Helmholtz, Hermann von, 19
 Henry, Joseph, 19
 Hertz, Heinrich, 22, 28, 98, 141
 Hewitt, Peter Cooper, 72
 Hewlett, C. W., 338
 Hicks, H. J., 35
 Hittorf, Wilhelm, 160
 Hogan, John V. L., 134, 179, 268, 290, 344
 Houck, H. W., 270, 275
 Housekeeper, W. G., 184
 Houston, E. J., 35
 Howe, G. W. O., 252, 268
 Hughes, David E., 26
 Hull, A. W., 184, 321
 Hull, Ross A., 200
 Hund, August, 235
 Huyghens, Christian, 33
 Hyde, Stanley, 331
 Hytron Company, 318

 Independent Wireless Telegraph Company, 289
 Infraville, Georges de, 48
 International Electrical Congress, 84, 88, 123
 International Radio - Telegraph Company, 289
 Ives, J. E., 119, 153, 154, 250

 Jackson, Capt., 38
 Jamin, Jules, 22
 Jansky, C. M., Jr., 199
 Jeance, Lieut. R., 229

 Jewett, F. B., 236
 Jones, D. E., 35

 KDKA, 275, 291
 Kellogg, E. W., 92, 334
 Kennelly, A. E., 35, 36, 146, 332
 Kenrad Company, 318
 Kerr, Richard, 42, 141
 Kiebitz, F., 214
 Kinrade, T. B., 101
 Kintner, S. M., 120, 223
 Kirchoff, G. R., 20, 21
 Kitsee, Isadore, 346
 Kleist, Ewald G. von, 27
 Kolacek, 35
 Kolster, F. A., 179, 247, 252
 Kranz, H. F., 334
 Krumm, Louis R., 290
 Kruse, S., 199

 La Grange, Prof., 139
 Lamb, Horace, 35
 Lamb, J. J., 200
 Langmuir, Irving, 168, 170, 171, 263, 318
 Larmor, George, 188
 Latour, M. C. A., 259, 271, 284
 Lecher, E., 149
 Lee, G. W., 134
 Lévy, Lucien, 259, 271
 Lewis, Harold M., 270
 Lieben, R. von, 169
 Liebowitz, B., 268
 Lilienfeld, J. E., 170
 Lindenblad, Nils E., 316
 Lindsay, J. B., 56
 Llewellyn, F. B., 355
 Lockard, Joseph L., 361
 Lodge, Oliver J., 30, 37, 98, 110, 141, 187, 333
 Loftin, E. H., 266
 Logwood, Charles V., 136, 171, 179, 239, 280
 Loomis, A. L., 361
 Love, J. E., 149
 Lowenstein, Fritz, 153
 Ludgte, 27
 Lyons, E. H., 36

 McCandless Lamp Works, 317
 MacDonald, H., 149
 MacDonald, W. A., 270
 McGauley, Prof., 16

- McNicol, Donald, 290
 Majorana, Prof. Q., 230
 Manescau, Lieut., 259
 Mansbendel, 77
 Marconi, Guglielmo, 39, 42, 58, 90,
 108, 121, 137, 141
 Marconi International Marine
 Communication Company, 285
 Marconi Wireless Telegraph Com-
 pany, 178, 252, 285
 Martin, D. K., 194, 299
 Martin, T. C., 3, 39
 Martin, W. H., 334
 Marx, E., 46
 Massa, Frank, 334
 Massie, Walter W., 104
 Massie Wireless Telegraph Com-
 pany, 286
 Mauborgne, J. O., 247
 Maxfield, J. P., 334
 Maxwell, James Clerk, 20, 57, 145
 Meissner, A., 171, 196, 235, 258
 Meissner Manufacturing Company,
 344
 Mertz, Paul, 247, 251
 Metcalfe, G. F., 355
 Metcalfe, R. H., 355
 Metz, Capt., 259
 Milne, E. A., 192
 Minchin, 35
 Minton, J. P., 334
Modern Electrics, 129
 Moller, H. G., 212
 Moncton, C. C., 247
 Morecroft, John H., 178, 179
 Morse, Arthur H., 204
 Morse, S. F. B., 44
 Mosler, 214
 Mouromtseff, I. E., 316
 Muhleman, M. L., 281
 Muirhead, Alexander, 38
 Munk, 108
 Murgas, J. A., 247
 Murray, J. Erskine, 86
 Mutual Broadcasting Company, 298

 National Broadcasting Company,
 297, 298
 National Electric Signaling Com-
 pany, 285
National Telegraph Review, 157
 National Union Radio Corporation,
 318

 Neugschwender, 114
 Newton, Isaac, 33, 151
 Nichols, H. W., 145, 148, 192, 236,
 303
 Nicholson, J. W., 149
 Nicolson, A. McL., 309
 North, D. O., 355
 Nyman, A., 334

 Oberbeck, W. P., 60
 Oersted, Hans Christian, 6
 Ohm, Georg Simon, 7, 20
 Olson, H. F., 334
 Onesti, Calzecchi, 109
 Osborne, H. S., 195
 Oswald, A. A., 236, 303
 Oudin, Dr., 80

 Paalzow, 35
 Pacent, Louis G., 260
 Pacific Wireless Telegraph Com-
 pany, 285
 Pacinotti, Antonio, 64
 Page, Charles G., 16
 Page, Robert M., 360
 Paley, W. S., 298
 Pedersen, P. O., 192
 Peters, L. J., 203
 Pickard, Greenleaf W., 88, 119, 125,
 130, 154, 193
 Pierce, G. W., 128, 203, 310, 331
 Pohl, 170
 Poincaré, H., 46, 149, 154
 Poldhu Radio Station, 139
 Pepoff, A. S., 44, 98, 108
 Porter, 170
 Potter, R. K., 194, 299
 Poulsen, Valdemar, 71, 135, 230
 Power, Harold J., 292
 Preece, W. H., 41, 58, 160
 Pressley, J. H., 270
 Priess, W. H., 270, 284
 Pringsheim, 170
 Pupin, Michael I., 35, 51, 115, 165,
 179

QST, 188

 Radio Club of America, 199, 260
 Radio Corporation of America, 91,
 252, 277, 288, 289, 298, 318
 Radio Telephone Company, 286
 Ramo, Simon, 355

- Rayleigh, Lord, 42
 Reich, M., 118
 Reinhartz, John L., 193, 281
 Reis, Johann P., 23
 Reisz, Eugen, 169
 Reith, J. C. W., 297
 Rice, Chester W., 92, 190, 265, 334, 340
 Richardson, O. W., 170
 Righi, Augusto, 60, 98
 Ringel, Abraham, 338
 Ritchie, E. S., 17
 Ritter, J. W., 35
 Rochefort, Prof., 80, 113
 Roentgen, W. K., 42, 45, 159
 Rogers, J. H., 214
 Rolf, B., 149, 185
 Roos, Oscar, 203
 Round, H. J., 171, 184, 209, 235, 271
 Rowland, W. A., 51
 Rubens, 35
 Ruhmer, Ernst, 226
 Ruhmkorff, Heinrich D., 16, 80
 Rutherford, Ernest, 120
 Rybczynski, W. V., 149
 Rypinski, M. C., 289, 290
 Rysselberghe, François van, 48

 Sahulka, J., 79
 Sarnoff, David, 179
 Savary, Felix, 18
 Sayville, N. Y., Telefunken station, 96, 198
 Schelleng, J. C., 145, 148, 192, 303
 Schloemilch, 114, 116, 263
 Schnell, F. H., 200
 Schottky, Walter, 274, 321
 Schweigger, Johann, 19
 Seibt, Georg, 46
 Sharp, Clayton H., 159
 Shaw, Thomas, 219
 Shepardson, George D., 332
 Shoemaker, Harry, 111
 Shreeve, H. E., 236
 Slaby, A. H. K., 45, 113
 Slaughter, N. H., 236
 Slepian, J., 334
 Smythe, E. H., 114
 Sommerfield, A., 149
 Soto, C. B. de, 199
 Southworth, G. C., 355
 Stanley, William, 65
 Stein, Adam, 77
 Steinmetz, Charles P., 77
 Sterns, Morton W., 251
 Stokes, George, 27
 Stone, John Stone, 35, 65, 89, 96, 114, 124, 203
 Stone Telegraph and Telephone Company, 286
 Strauss, Seigmund von, 171, 258
 Strudwick, S. H., 48
 Sturgeon, William, 7
 Summers, F. E., 152
 Sylvania Company, 318

 Taggart, John Scott, 265
 Taylor, A. Hoyt, 188, 190, 293, 359
 Telefunken Wireless Telegraph Company, 286
Telegraph and Telephone Age, 74
 Terry, E. M., 309
 Tesla, Nikola, 35, 54, 74, 144
 Thompson, Sylvanus P., 46, 308
 Thomson, Elihu, 36, 70
 Thomson, J. J., 35, 147, 161
 Thomson, William, 20, 42
 Tissot, C., 46
 Tizard, Sir Henry, 361
 Tonks, L., 355
 Tosi, Alessandro, 93
 Trowbridge, John, 52
 Turner, L. B., 279
 Turpain, Albert, 46
 Tuska, C. D., 200
 Tuve, Merle A., 193, 359

 United States Naval Research Laboratories, 360
 United Wireless Telegraph Company, 178, 286
 Usselman, George L., 213, 315, 356

 Vail, Theodore N., 218, 220
 Van der Bijl, H. J., 184, 220
 Van der Pol, B. J., 149, 185
 Van Dyck, A. F., 134
 Van Dyke, K. S., 309
 Van Etten, 171
 Vanni, Prof., 230
 Van Rysselberghe, François, 48
 Varian, R. H., 355
 Varian, S. F., 355
 Varley, Cromwell F., 32, 48
 Varley, Stephen A., 108
 Volta, Alessandro, 4

- Von Baeyer, O., 169
 Von Bezold, W., 29
 Von Bronk, O., 263
 Von Helmholtz, Hermann, 19
 Von Lepel, 101
 Von Lieben, R., 169
 Vreeland, Frederick K., 72, 118, 134

 Wallace, Don C., 200
 Walter, 122
 Warner, K. B., 200
 Watson, E. A., 149
 Watson, Paul, 361
 Watson-Watt, R. A., 359
 WDY, 295
 WEAf, 297
 Weagant, Roy A., 179, 209, 281
 Webster, A. G., 332
 Wegel, R. L., 334
 Wehnelt, A., 81, 223
 Weinberger, Julius, 302
 Western Electric Company, 219,
 292, 315, 333
Western Electrician, 87

 Western Union Telegraph Com-
 pany, 218
 Westinghouse, George, 44, 64
 Westinghouse Electric Corp., 289,
 316
 Weston, Edward, 36
 White, J. Andrew, 298
 White, S. Y., 266
 White, W. C., 184
 Wiedemann, 170
 Wien, Max, 101
 Wilson, R. H., 236
 WJZ, 295
 Wolff, Irving, 338, 360
 Wollaston, William Hyde, 9
 Woolverton, R. B., 136
 WOR, 295
 Wynne, V. C., 129

 Young, Leo C., 359
 Young, Thomas, 34

 Zehnder, L., 35, 94
 Zenneck, Joniathan, 46, 153

Subject Index

- Alternators, high-frequency, 74, 223, 231
Amateurs, radio, 193, 198, 199, 228
Amplification, audio, 273, 282, 283, 350
 cascade, 171, 173
 class B, 314
 class C., 314
 factor, 325
 radio, 132, 180, 255, 262
 push-pull, 345
Amplitude of oscillations, 65
Antennas, buried, 213
 counterpoise, 90, 96
 design of, 202
 directive, 86, 93, 217
 double-loop, 95, 211
 earthed, 95, 153
 elevated, 40, 52
 Hertz loop, 95
 high, vs. low, 203
 horizontal, 86, 250
 inverted L, 90
 loop, 211, 217
 multiple-tuned, 91
 underwater, 215
 wave, 92
Aperiodic shield, 95
Arc oscillator, 70, 224, 226
Arcturus Company, 318
Atmospherics, 44
 (See also Static)
Audio amplification, 273, 282, 283, 350
Audion, 156, 163
 action of, 170, 178, 180, 220
 oscillator, 171, 181
Austin-Cohen formula, 185
Autodyne reception, 270
Automatic volume control, 323, 343
Autoplex receiver, 281
B battery, 173, 180, 256
B battery eliminator, 342
Balanced detector receiver, 209
Baldwin headphones, 333, 337
Barretter detector, 116
Beam transmission, 204, 205
Beat frequencies, 133, 267
Bound ether, 141
Break spark, 15
Broadcasting, 69, 194, 294, 295, 313
Bug trap, 208
Bureau of Standards, 198, 343
Cage, Dieckmann, 95, 119
Capacity, electrostatic, 20
Carrier currents, 195, 302, 305
Cascade amplification, 173
Cat's-whisker detector, 130
Chopper reception, 269
Circularly polarized waves (see Waves)
Coherer, Branly, 37, 58
Compass needle, 5
Condenser discharge oscillatory, 18
Condenser loudspeaker, 341
Conduction, through the earth, 84
 through gases, 161
Continuous waves (see Waves)
Convention, first radio, 124
Counterpoise ground, 90, 96
Coupler, loose, 66, 246, 249
 vario, 245
Coupling of circuits, 59, 61, 65, 249, 266
Cross talk between wires, 150
Crystal detectors, 123, 126
Crystal oscillators, 309, 312
Curvature of the earth, effect of, upon radio, 139, 146, 154, 186
Damping of oscillations, 65
Dark-hour radio coverage, 141, 145
Decoherer, 40, 107, 111
Decrement of oscillations, 66
Detectors, electromagnetic-wave, audio, 156, 163, 254
 barretter, 116
 Branly, 37
 Carborundum, 125
 cat's-whisker, 130
 coherer, 37, 106, 111
 crystal, 123, 126
 de Forest, 115
 electrolytic, 114, 115
 Hertz loop, 29, 107
 kumascoppe, 124

- Detectors, electromagnetic-wave,
 Lodge-Muirhead, 113
 magnetic, 121, 122, 253
 molybdenite, 128
 Neugschwender, 114
 perikon, 130
 pyron, 130
 responder, 115
 Schloemilch, 114, 116
 silicon, 125
 solid, 129
 thermoelectric, 126
 valve, 158, 162
- Direction finder, 89, 95
- Discharger, synchronous rotary, 74,
 101
- Distortion of signals, 207
- Doughnut tuner, 247
- Eccles-Larmor hypothesis, 188
- Edison effect, 159
- Electric waves along wires (*see*
 Waves)
- Electromagnet, 7
- Electromagnetic waves (*see* Waves)
- Electrons, 161, 169
- Electrostatic field, 153, 155
- Ether, 27, 33
- Etheric force, 49
- Fading of signals, 190, 194, 198, 306
- Faradic electricity, 14
- Feed-back circuit, 181, 257, 260
 negative, 266, 280, 349
- Frequency modulation, 213, 355, 356,
 357
- Galvanometer, 19, 120
- Gang condenser tuning, 344
- Gaps, spark, 29, 59, 74, 79, 98, 101,
 104, 204, 223
- Generators, high-frequency 74
- Grid leak, 241, 257, 263
- Harmonics, 51, 278, 335
- Headphones, 330, 331, 332
- Heaviside layer, 189
- Heterodyne reception, 133, 267, 272
- Honeycomb tuning coil, 251, 261
- Hytone system of transmission, 232
- Inductance factor, 20, 59
- Induction coil, 15, 52, 66, 81
- Induction system, 27, 52
- Induction telegraphy, 27, 52, 82
- Interference preventer, 208
- Intermediate frequency, 273, 274,
 275
- Interrupter, Wehnelt, 81
- Ionization of atmosphere, 187
- Jigger, 58
- Kennelly-Heaviside layer, 189
- Keving, transmitter, 213, 355
- Kumascop (*see* Detectors)
- Leyden jar condenser, 10, 18, 28,
 108
- License for broadcasting, first issued,
 297
- Light waves, 34, 145
- Limiter tube circuit, 357
- Line-of-sight transmission, 354
- Lodestone magnet, 5
- Loose coupler, 66, 246
- Losser method of tuning, 265
- Loudspeakers, 333, 334, 335-341
- Luminiferous ether, 34
- Magnavox loudspeaker, 336
- Magnetic detector, 121, 253
- Magnetic field, 30, 155
- "Make" spark, 15
- Mercury-vapor arc oscillator, 72
- Microphones, 27, 225, 227, 230
- Microwaves, 353
- Mirror, revolving, 22
- Modulation, absorption method of,
 237
 constant-current, 237
 double-grid, 239
 frequency, 213, 355, 356, 357
 Heising, 237
 requirements, 241
 van der Bijl, 238
- Multiple tuner, 253
- Multiplier of voltage, need for, 10
- Neutralization of grid-plate capa-
 city, 266
- Neutrodyne receiver, 267
- Nodes, current, 58
- Oscillation control in receivers, 257,
 265, 280, 308
- Oscillator, master, 312, 314

- Oscillator systems, 98, 171, 234, 258, 311
- Oscillatory discharge, 18
- Oscillograph, 166
- Oscilloscope, 363
- Parabolic reflector, 59, 204
- Peltier effect, 128
- Permeance factor, 59
- Permittance factor, 59
- Peukert spark gap, 101
- Piezoelectricity, 308
- Polarization cells, 116
- Power packs, 342
- Push-pull amplification, 345
- Quartz crystal frequency control, 309
- Quench frequency for oscillation control, 280
- Quenched spark gaps (*see* Gaps)
- Radar, 359, 364
- Radiating receivers, 261, 262, 265
- Radio-frequency amplifiers, non-reactive, 266
- Rays, Roentgen, 42, 45
- Reactance factor, 59
- Receiver, telephone, 330-332
- Receivers, radio, all-electric, 342
- all-wave, 344
 - autodyne, 270
 - autoplex, 282
 - early, 243
 - French L-3, 271
 - gang, condenser tuned, 344
 - midget, 325
 - neutrodyne, 267
 - push-button, 344
 - reflex, 263, 279, 283, 284
 - regenoflex, 278
 - single-circuit, 341
 - split-variometer, 281
 - superheterodyne, 272
 - superregenerative, 281
 - two-circuit, 253, 261
 - tuned radio-frequency, 264, 271, 278
 - ultraudion, 182, 252, 281
- Recorder, siphon, 38
- tape, 2, 330
- Rectification of current, 128, 129
- Reflection of waves, 145, 148, 186
- Reflex circuit, 263, 279, 283
- Refraction of waves, 145, 146, 149, 153
- Regeneration of signals, 174, 183
- Regenerative receiver, 257, 273
- Regenoflex receiver, 278
- Reluctance factor, 59
- Repeater, telephone, 36, 219
- Resistance-coupled amplifier, 275, 283, 345
- Resonance factor, 51, 57, 65
- indicated by glow lamp, 235
- Responder detector, 115
- Reversed feed back, 266, 280
- Rheostat control of oscillation, 257, 265
- Selectivity of tuning, 57, 60, 243
- Shield, aperiodic, 95
- Shielding of circuits, 276, 325
- Shocks, electric, 16
- Short waves, 197
- Sidebands, 194, 303, 305
- Signal-to-noise ratio, 349
- Signal Corps, United States, 270, 285, 360
- Skip-distance phenomena, 190
- Sky wave, 154
- Sliding-contact reception, 269
- Solenoid magnet, 9
- Space charge in tubes, 168, 318
- Spark gaps (*see* Gaps)
- Split-variometer tuning, 281
- Static disturbance, 44, 95, 206, 207, 356
- clicks, 208
 - grinders, 208
 - hissing, 208
- Stopping condenser, 256
- Sunspot effects, 188
- Superheterodyne receiver, 272
- Superregenerative receiver, 281
- Suppressed carrier, 304
- Synchronous rotary gap, 74
- Syntony of circuits, 57
- Tape register, 330
- Tapper decoherer, 40
- Telegraphy by wire, 137
- Telephony, radio, 220, 222, 225, 229, 235, 288, 292, 304, 306
- wire, 23, 219
- Three-electrode tube (*see* Tubes)

- Ticker, 134, 135
 Tickler coil, 260
 Tone wheel, 135
 Transformer, air-core, 80, 245, 273
 oscillation, 58, 74
 power, 11, 65, 100
 Transmitter, arc, 70
 radio, 30, 66, 234, 312
 tube, 204, 313, 314
 Trough transmitter, 224
 Tubes, vacuum, acorn, 325
 all-metal, 325
 all-purpose, 324
 alternating-current, 320
 beam power, 326
 blower-cooled, 326
 cathode-ray, 362
 classification, functional, 327
 diode, 162, 328
 dry-cell, 319
 duplex-diode, 324
 gas ionization in, 321
 German, 169
 hard, 168
 heater, 319
 klystron, 327
 Lieben-Reisz, 169
 magnetron, 361
 manufacture of, 318-320
 noise in, 320, 321
 pentagrid converter, 324
 pentode, 323
 screen-grid, 321
 secondary emission in, 323
 shot effect in, 320, 321
 soft, 168
 three-electrode, 164, 319, 320, 324
 two-electrode, 162, 328
 variable- μ , 323, 343
 water-cooled, 326
 Tuned radio-frequency reception, 264
 Tuners, doughnut, 247
 honeycomb, 251, 261
 Tuners, multiple, 253
 variocoupler, 251
 variometer, 251, 257
 Tuning in radio, 30, 57, 59, 65, 344
 Ultrahigh frequencies, 353
 Ultraudion receiver, 182, 252
 Vacuum tubes (*see* Tubes)
 Valve detector, 158, 162, 328
 Variocoupler, 251
 Variometer, 251, 257
 Very high frequencies, 353
 Volume control, automatic, 323, 343
 Wave meter, 250
 along wires, 38, 58
 Waves, electromagnetic, 26, 57, 60, 196
 carrier, 306
 circularly polarized, 92
 continuous, 73, 231
 corpuseular theory of, 34
 diffraction of, 29
 earth, 154, 201
 elliptically polarized, 92
 ground, 185
 horizontally polarized, 201
 long, 197, 201
 micro, 353
 polarization of, 29, 145
 propagation of, 85, 144
 reflection of, 29, 145, 185
 refraction of, 153
 short, 197, 200, 316
 sky, 154
 ultra-high, 353
 undulatory theory, 33
 used by Hertz, 197
 vertically polarized, 201
 very high frequency, 353
 Whip-crack spark, 78, 155
 X rays, 42, 45, 169

[Continued from front flap]

overcoming the obstacles of long distances and atmospheric noise, and in broaching nature's secrets as to the behavior of radio waves in space.

Donald McNicol, a past president (1926) of the Institute of Radio Engineers, is particularly well equipped to write the account of radio's evolution, for he was, in effect, a practicing radio engineer long before the term "radio engineer" was thought of. In 1900 he constructed the first experimental wireless transmitter and receiver in the Midwest and in 1907 organized the first amateur radio club in Salt Lake City. In later years he has been an editor of technical journals, an instructor in electrical communication at Columbia University, and a general consultant in the communications field. In spite of his numerous activities during these years, he found time to write eight other books.

Mr. McNicol has drawn on his wide personal acquaintance among the men of radio and on first-hand observation over the years to give us this interesting and informative account of the achievement of radio. Besides his personal recollections, he had the advantage of his own extensive reference library. His story will jog the memories of the old-timers, the men who, like the author, grew up with radio. And it will inspire the newcomers to greater achievement and provide a broad background of knowledge for everyone interested in radio—teacher, engineer, student, technician, amateur.

MURRAY HILL BOOKS, INC.
New York

Toronto

OTHER MURRAY HILL BOOKS on the Background of Modern Science

SOUL OF AMBER

The Background of Electrical Science

by ALFRED STILL

The history of electricity from earliest times — when, manifested as a special property of amber, it was known as the magical "soul" of amber — through the contributions of such men as Franklin, Volta, Ampère, Ohm to the threshold of its present-day, universal utility. But more than that, it is the history of the men who promoted scientific investigation and of the concurrent intellectual progress.

SOUL OF LODESTONE

The Background of Magnetical Science

by ALFRED STILL

The story of the "soul" of lodestone — that is, *magnetism*, an important basic concept in electrical science — as it contributed to civilization's progress. The author, an electrical engineer, tells how men observed, speculated, theorized, experimented, and finally achieved an understanding and full utilization of magnetic properties.

TELEVISION PROGRAMMING AND PRODUCTION

by RICHARD HUBBELL

The past, present, and future of the studio side of television broadcasting presented by a pioneer producer who is now Production Manager and Television Consultant of Crosley Corporation, Broadcasting Division. This book will be of value to every one associated with the medium, and especially to broadcasters, advertisers, writers, directors, actors, designers. The author analyzes television programming, advises on studio technique and equipment, and suggests the direction for improvements in the art. A comparison of American and British techniques is of particular interest.

MURRAY HILL BOOKS, INC.

New York

Toronto