



Counting on Success

Mathematics Achievement in Irish Primary Schools

Paul Surgenor
Gerry Shiel
Seán Close
David Millar

Prepared for the Department of Education and Science by the Educational Research Centre



INSPECTORATE



Counting on Success

Mathematics Achievement in Irish primary schools

Paul Surgenor
Gerry Shiel
Seán Close
David Millar

Prepared for the Department of Education and Science by the Educational Research Centre

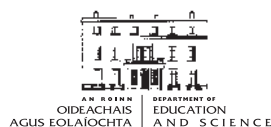

INSPECTORATE

Copyright © 2006, Department of Education and Science

Cataloguing-in-Publication Data

Surgenor, Paul

Counting on Success: Mathematics Achievement in Irish Primary Schools /
Paul Surgenor...[et al.].

Dublin: Department of Education and Science

vi, 48p., tables, 30 cm

Includes bibliographical references.

1. Mathematics - Study and teaching (Primary) - Ireland.
2. Mathematical ability - Testing
3. Educational tests and measurements - Ireland
4. Educational surveys - Ireland

I Title.

2006

372.7076 – dc/22

Designed by TOTAL PD

P77662 30-01 8/06 Brunswick Press Ltd. 11,000 (17217)

Published by the Stationery Office, Dublin

To be purchased directly from the
**Government Publications Sales Office,
Sun Alliance House,
Molesworth Street, Dublin 2**

or by mail order from

**Government Publications,
Postal Trade Section,
51 St. Stephen's Green, Dublin 2
Tel: 01-647 6834 Fax: 01-647 6843**

€8.00

ISBN: 0-7557-7319-5



Contents

	Preface	v
1	The Context of the Assessment	1
2	Assessment Instruments and Procedures	5
3	Mathematics Achievement of Pupils in Fourth Class	9
4	Pupil Characteristics and Mathematics Achievement	13
5	Home Background and Mathematics Achievement	17
6	Classroom Environment and Mathematics Achievement	21
7	School Characteristics and Mathematics Achievement	25
8	Learning Support for Mathematics	29
9	Inspectors' Views on Teaching and Learning Mathematics	33
10	Recommendations	37
	Appendices	43
	Appendix A: Sample Test Items	43
	Appendix B: Proficiency Levels - Summary Descriptors	46
	Glossary	48

Preface

The 2004 National Assessment of Mathematics Achievement (NAMA 2004) is the fifth in a series of national assessments of Mathematics in Irish primary schools, dating back to 1977, and the first since the introduction of the 1999 Primary School Curriculum: Mathematics (PSCM).^{1,2} Since an assessment of pupils' achievement in Mathematics was carried out in Fourth class in 1999 using a test similar to that used in the current study, it was possible to compare performance in 1999 and 2004. This report summarises the findings and recommendations of the main report on NAMA 2004. Readers who are interested in a more detailed treatment of the findings are referred to the main report on the study.³

We gratefully acknowledge the help of members of the Advisory Committee for NAMA 2004 who provided advice on the implementation of the study, and assisted with the interpretation of the results. The committee members were Seán Ó Cearbhaill (Department of Education and Science: Chairperson), Paraic Barnes (Department of Education and Science), Shirley Brook (Church of Ireland Board of Education), Seán Close (St. Patrick's College), Sarah Fitzpatrick (National Council for Curriculum and Assessment), Maria Murphy (National Parents' Council - Primary), Deirbhile Nic Craith (Irish National Teachers' Organisation), Dónal Ó hAiniféin (Gaelsoileanna), Valerie O'Dowd (Primary Curriculum Support Programme), Seán de Paor (An Foras Patrúnachta), and Gerry Shiel and Paul Surgenor (Educational Research Centre).

The support of colleagues at the Educational Research Centre is also acknowledged. Thomas Kellaghan (Director) provided advice throughout the study and feedback on earlier drafts of this report. Mary Rohan, Hilary Walshe and John Coyle provided help with the administration of the assessment. Jude Cosgrove and Eemer Eivers, who worked on the parallel National Assessment of English Reading, provided feedback on the assessment instruments. Martina Byrne worked as a research assistant during the early stages of the study.

¹ Department of Education and Science/National Council for Curriculum and Assessment. (1999a). *Primary school curriculum: Mathematics. Content*. Dublin: Stationery Office.

² Department of Education and Science/ National Council for Curriculum and Assessment. (1999b). *Primary school curriculum: Mathematics. Teacher guidelines*. Dublin: Stationery Office.

³ Shiel, G., Surgenor, P., Close, S., & Millar, D. (2006). *The 2004 National Assessment of Mathematics Achievement*. Dublin: Educational Research Centre.

1 The Context of the Assessment

Terms of Reference

The purpose of NAMA 2004 was to describe performance in mathematics at Fourth class level in primary schools, identify variables associated with achievement, and compare performance with performance on the 1999 National Assessment of Mathematics Achievement (NAMA 1999). The terms of reference for NAMA 2004 were as follows:

- To conduct a study of the mathematics achievements of a representative national sample of pupils in Fourth class in primary schools.
- To compare the performance of pupils in 2004 with the benchmarks established in NAMA 1999.
- To examine the use of calculators by pupils in Fourth class.
- To examine associations between mathematics achievement and relevant pupil, teacher, and school factors, and report on any changes arising since the 1999 national assessment.
- To examine ways in which the teaching and assessment of mathematics have evolved since the introduction of the revised Primary School Curriculum: Mathematics in 1999.
- To make recommendations about the teaching and assessment of mathematics in schools.

Outcomes of Previous National Assessments and Studies Involving Mathematics

Early national assessments involving pupils in Second, Fourth, and Sixth classes focussed on Number. Studies in 1977, 1980, and 1985 indicated that pupils were strongest in dealing with operations with whole numbers, and weakest in the area of problems.^{4,5} NAMA 1999, found that pupils performed best in the Data and Number strands, and least well on Measures and Shape & Space.⁶ Performance was strongest on items requiring the use of lower-level skills, such as Understanding & Recalling and Implementing, and weakest on items that required higher-level processes such as Reasoning and Applying & Problem Solving.

⁴ Department of Education, Curriculum Development Unit, Primary Section. (1980). *Turaisc ar theagasc na matamaitice sna bunscoileanna* (an dara eagrán). [Report on the teaching of mathematics in primary schools, second edition]. Dublin: Author.

⁵ Department of Education, Curriculum Development Unit, Primary Section. (1985). *Turaisc ar theagasc na matamaitice i rang VI (1984)*. [Report on the teaching of mathematics in sixth class]. Dublin: Author.

⁶ Shiel, G., & Kelly, D. (2001). *The 1999 National Assessment of Mathematics Achievement*. Dublin: Educational Research Centre.

Boys scored marginally higher than girls, but the difference is not statistically significant. Significant associations with mathematics achievement were noted for level of parental education, and if the school was designated as serving a disadvantaged area.

A DES study of literacy and numeracy in disadvantaged primary schools in 2005 indicated that two-thirds of pupils in the most disadvantaged schools achieved at or below the 20th percentile on standardised tests (compared to 20% nationally), and that performance declined as pupils progressed through the school.⁷

Principal teachers in NAMA 1999 identified a lack of learning support, inadequate in-service training, and multi-grade classes as the most significant problems in the teaching and learning of mathematics. Lack of pupil and parent interest and a shortage of computer resources were considered more problematic in schools designated as disadvantaged than in non-designated schools.

Just 4.5% of pupils in NAMA 1999 were in classes in which calculators were available during at least some mathematics lessons, though access to a calculator was not significantly associated with achievement. Most pupils attended schools which had policy statements on the teaching and learning of mathematics, provision for pupil assessment, and communication of information on pupils' progress in mathematics to parents. While most schools had policies on teaching computation and administering standardised tests, just 30% of pupils attended schools which had policies on teaching strategies for mathematics problem solving.

In NAMA 1999, most teachers prepared an annual plan and a weekly or fortnightly plan, though these were often based on pupils' textbooks, and the accompanying manuals. *Curaclam na Bunscoile*⁸ and the *Plean Scoile* were rarely drawn on. Few teachers had attended an in-career development course in mathematics since their initial training or in the 12 months preceding the survey.

Implementation of the 1999 Primary School Curriculum: Mathematics

While the 1999 Primary School Curriculum: Mathematics (PSCM) is broadly similar to its predecessor in terms of mathematics content, it advocates greater use of resources and practical activities at all class levels to develop mathematics concepts. It espouses a constructivist approach to teaching problem solving, advocates group work, and introduces the use of the calculator from Fourth class onwards. While the curriculum was introduced in 1999, primary schools did not begin its implementation until 2002-2003, following a national programme of inservice education delivered by the Primary Curriculum Support Programme.

⁷ Department of Education and Science. Inspectorate. [DES]. (2005). *Literacy and numeracy in disadvantaged schools [LANDS]: Challenges for teachers and learners. An evaluation by the inspectorate of the Department of Education and Science*. Dublin: Stationery Office

⁸ Department of Education (1971). *Curaclam na bunscoile - Lámhleabhar an oide., Cuid 1*. [Primary school curriculum - Teacher's handbook, Part 1]. Dublin: Stationery Office.

According to the NCCA primary curriculum review, teachers were most satisfied with the Number strand, and least with Data (and the Chance component of Data in particular).⁹ While group work was generally limited, teachers reported that practical work was the greatest success of the curriculum. In this study, as well as in a DES study of newly qualified teachers,¹⁰ catering for the diversity of children's individual strengths and needs was identified as an issue.

The study of newly qualified teachers also reported that 28% of beginning teachers felt themselves to be poorly prepared to teach mathematics, compared to 12% and 16% for English and Irish respectively. Recommendations most frequently made to teachers by Inspectors concerned the use of a range of concrete materials in mathematics lessons, the provision of challenging activities for more able pupils, the use of real-life problem-solving situations in lessons, and a reduced emphasis on the role of the textbook.

A recent review of primary pre-service teacher education, *Preparing Teachers for the 21st Century* (2002), noted that there was a need to strengthen student teachers' preparation to teach mathematics in primary schools.¹¹ Specific recommendations focused on the introduction in colleges of education of a professional mathematics course, with the objective of improving students' competence in the subject and developing their teaching skills.

An evaluation of curriculum implementation in primary schools by the DES Inspectorate (2005) indicated that, while teachers generally had a good understanding of the structure of the mathematics curriculum, whole-school planning was weak in over one-half of schools, and classroom planning was weak in two-fifths of classrooms.¹² It stated that teachers had difficulty relating mathematics to other areas of the curriculum, and in developing a structured approach to teaching the language of mathematics.

A need for more effective use of standardised tests was noted in the evaluation of literacy and numeracy in disadvantaged schools by the DES Inspectorate (2005).¹³ The study also recommended provision of learning support for all pupils with very low achievement in mathematics, greater emphasis on numeracy (particularly whole number, place value, and estimation), and improved links with parents of pupils in the middle and senior classes.

⁹ National Council for Curriculum and Assessment. [NCCA]. (2005). *Primary curriculum review. Phase 1*. Dublin: Author

¹⁰ Department of Education and Science. Inspectorate. [DES]. (2005). *Beginning to teach: Newly qualified teachers in Irish primary schools*. Dublin; Stationery Office

¹¹ Working Group on Primary Preservice Teacher Education (2002). *Preparing teachers for the 21st Century*. Dublin: Stationery Office.

¹² Department of Education and Science. Inspectorate. [DES]. (2005). *An evaluation of curriculum implementation in primary schools: English, mathematics and visual arts*. Dublin: Stationery Office.

¹³ Department of Education and Science. Inspectorate. [DES]. (2005). *Literacy and numeracy in disadvantaged schools [LANDS]: Challenges for teachers and learners. An evaluation by the inspectorate of the Department of Education and Science*. Dublin: Stationery Office

2 Assessment Instruments and Procedures

In this chapter a brief overview is presented of the instruments and the sampling procedures used in NAMA 2004.

Framework and Item Specifications

In 1999, the Educational Research Centre developed a test that was compatible with the framework (content strands and process skills) of the 1999 Primary School Curriculum: Mathematics. Of the original 125 items used in NAMA 1999, 116 were retained for the 2004 assessment, 9 were updated, and a further 25 were added to assess mathematics in the context of calculator availability. This provided a total of 150 items which were divided into 6 sections, distributed over 5 test booklets, with each booklet comprising 3 sections. Each pupil was assigned one booklet. Each booklet included a common section (Section B), and 2 additional sections, giving 75 items in total (see Table 2.1).

Booklet	First Section	Second (Common) Section	Third Section
1	A	B	C
2	C	B	D
3	D	B	E
4	E	B	F*
5	F*	B	A

*Calculator Section (pupils had access to calculator for this section only).

Table 2.2 shows the distribution of items by content strand and skill for the full 2004 item set.

Strand	N	%	Skill	N	%
Number	58	38.7	Understanding & Recalling	19	12.7
Algebra	7	4.7	Implementing	42	28.0
Shape and Space	21	14.0	Reasoning	31	20.7
Measures	48	32.0	Integrating & Connecting	10	6.7
Data	16	10.7	Applying & Problem Solving	48	32.0
Total	150	100.0	Total	150	100.0

The test consisted of a combination of multiple-choice (53.3%) and short-answer (46.7%) items. The common section (Section B) consisted mainly of multiple-choice items, while the calculator section consisted mainly of short-answer items. Examples of types of item are presented in Appendix A.

Questionnaires

The questionnaires common to NAMA 1999 and 2004 were a *School Questionnaire* (which asked principal teachers for information on the organisation of mathematics instruction at school level), a *Teacher Questionnaire* (which asked teachers of mathematics in Fourth class about instructional practices), a *Pupil Rating Form* (which asked teachers for contextual information about each pupil who participated in the survey), a *Pupil Questionnaire* (which sought to assess pupils' attitudes to school, study, and other activities), a *Parent Questionnaire* (which asked parents about their social and educational backgrounds and how they supported their child's mathematics development at home), and a *Questionnaire for Inspectors* (which asked inspectors about the implementation of various aspects of 1999 PSCM). A *Learning Support Teacher Questionnaire* was included in 2004 to address the work of learning support teachers in the areas of English and mathematics.

Sample

The target population for NAMA 2004 included all pupils in Fourth class in Irish primary schools with the exception of pupils attending private schools, special schools, or special classes in ordinary schools. Pupils with a learning/physical disability that would prevent them from attempting the test, and 'newcomer' pupils whose proficiency in English was so low they could not attempt the test, were also exempted. It was emphasised to the test administrators that exclusions should be rare.

In addition to six selection strata,¹⁴ schools were sorted according to disadvantaged status, Gaeltacht status, and the proportion of female pupils in the school. Using a random-start, fixed-interval selection procedure, schools within each stratum were selected with probability proportional to size. Of the 136 schools selected to participate in NAMA 2004, 130 participated, and a total of 4171 pupils were surveyed.

Administration of Tests and Questionnaires in Schools

Selected schools were informed of the study, and each school that agreed to participate returned a completed School Form that gave the numbers of pupils enrolled. Gaeltacht schools and scoileanna lán-Ghaeilge were asked to indicate if they wished to administer

¹⁴ Schools were selected in conjunction with the 2004 National Assessment of Reading in First and Fifth classes. Three school sizes (small, medium, and large) by two class options (having either 4th and 5th classes, or 1st, 4th, and 5th classes) created six strata.

the NAMA 2004 mathematics test in English or Irish. In cases where a school had more than two classes at a particular class level, two classes were selected at random. Otherwise, all listed classes were selected. Schools were then sent the names of participating classes and copies of the questionnaires. A letter from the National Parents' Council (Primary), which encouraged parents to complete the questionnaire and to return it to the school, accompanied the Parent Questionnaire.

An inspector of the Department of Education and Science monitored the administration of the mathematics test. Class teachers administered the test and the Pupil Questionnaires, except in a few small schools, in which the inspector assisted with test administration. Inspectors collected all completed and unused test booklets, questionnaires, and rating forms and returned them to the Educational Research Centre.

The implementation of the survey was generally successful, and reflected the strong commitment to the study of inspectors, principal teachers, class teachers, learning support teachers, parents and pupils. Unlike 1999, no school elected to use the Irish form of the mathematics test.

Response rates for each test/questionnaire were uniformly high, and ranged from 93% (for the test booklets) to 99% (for the Teacher Questionnaire).

Scaling

To facilitate comparisons between results of NAMA 1999 and NAMA 2004, the performance of pupils in 2004 was placed on the scale that was used in 1999. A scaled score was then available for each pupil who participated in the 2004 study on the scale for the 1999 study, allowing for a comparison between the two years.

Mathematics Proficiency Levels

A mathematics proficiency scale was developed to allow for the provision of more specific information on the achievement of pupils performing at different levels on the test. This involved generating a description for each test item based on the main underlying content strand and skill, arranging all the items in order of difficulty, and identifying suitable cut-off points.¹⁵ Cut-off points were identified where there was a clear shift in the type of processing between two sets of items. This resulted in six levels, ranging from Advanced (Level 5) to 'Below Level 1'. Pupils scoring at a particular level have about a 50% chance of getting items at that level correct. They have a greater than 50% chance of getting items at lower (easier) levels correct, and a less than 50% chance of getting items at higher (more difficult) levels correct. Pupils scoring below Level 1 have a less than 50% chance of getting the easiest (Level 1) items on the test correct.

¹⁵ Since Item Response Theory was used to scale the mathematics test, it was possible to place pupils and test items on the same underlying scale.

Although they may have mathematics skills, those skills are not assessed by NAMA 2004. Summary descriptions of the proficiency levels can be found in Appendix B, while a complete description can be found in the full report.

3 Mathematics Achievement of Pupils in Fourth Class

The achievement of Fourth class pupils is described, with reference to the overall mathematics scale, the mathematics strands and skills in the assessment framework, and the mathematics proficiency scale.

Performance on the Overall Scale

The mean score for 1999 was 250 scale score points and for 2004, 251. The difference between these scores is not statistically significant, indicating no change in overall performance between 1999 and 2004.

Performance by Mathematics Strands and Skills

Each item in the assessment was categorised according to the mathematics strand and process skill it assessed. Average percent correct scores were computed for each strand and skill. On content strands, pupils achieved the highest mean percentage correct score on Data (69% correct), and the lowest on Measures (49% correct). Mean percent correct scores for content strands in 1999 and 2004 are presented in Figure 3.1, using items common to both years. Statistically significant differences were obtained for Shape & Space and Data, both of which were higher in 2004 than in 1999 (by about 5%).¹⁶

Figure 3.1: Mean Percent Correct Scores for Content Strands, by Year

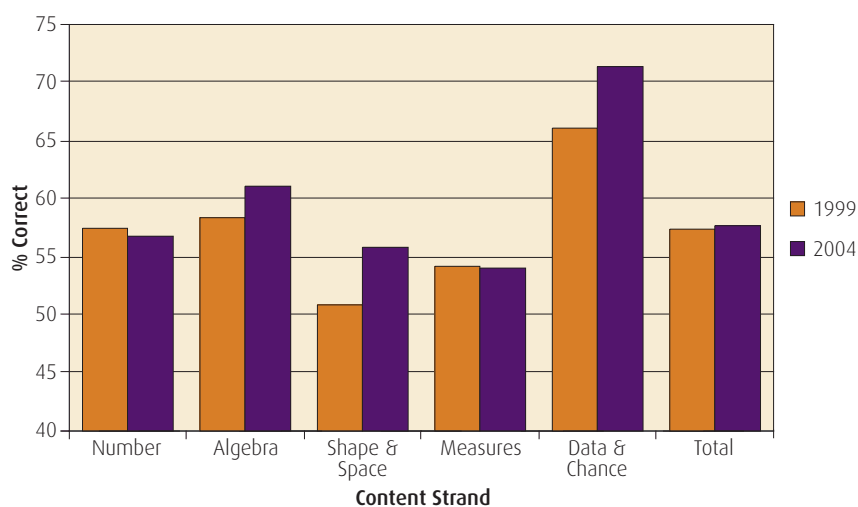

¹⁶ The outcomes by content area were examined first for the 2004 dataset (150 items). Figure 3.1 refers to the reduced set of 116 common items.

Pupils achieved the highest mean scores on items assessing basic mathematics skills - Understanding & Recalling (62% correct) and Implementing (58%) - and the lowest on items assessing higher-order skills, including Applying & Problem Solving (48%). A comparison of performance using items common to the 1999 and 2004 assessments revealed only one significant increase in 2004. This was for the skill area 'Reasoning', which improved by 4% (see Figure 3.2).¹⁷

Figure 3.2: Mean Percent Correct Scores for Mathematics Skills, by Year

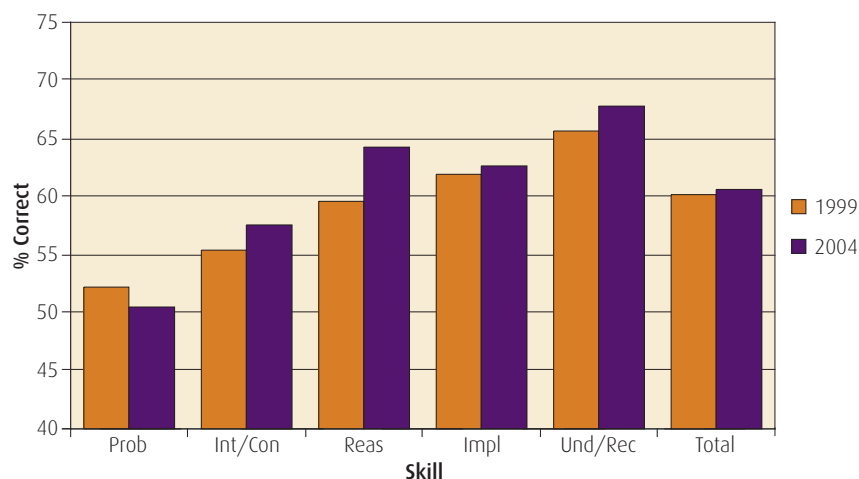

Prob = Applying & Problem Solving; Int/Con = Integrating & Connecting; Reas = Reasoning; Impl = Implementing; Und/Rec = Understanding & Recalling.

Performance on the Mathematics Proficiency Scale

The percentage of pupils achieving at each proficiency level is presented in Table 3.1. See Appendix B for a more detailed listing of item descriptors

Table 3.1: Numbers and Percentages of Pupils at Each Proficiency Level on the Overall Mathematics Scale			
Level	Descriptor	Examples of tasks that pupils should be able to complete	% of Pupils
Level 5	Advanced	Implementing procedures for estimating sums and quotients; solving non-routine two-step problems involving fractions and measures	11.7
Level 4	High	Recalling and using definitions of parallel and perpendicular lines; partitioning 2-D shapes using fractions; solving routine problems involving the calculation of perimeter	25.7
Level 3	Moderate	Rounding whole numbers; estimating products of whole numbers; solving non-routine 1 step problems involving operations with fractions	26.1
Level 2	Basic	Visualising and identifying properties of 2/3-D shapes; solving routine/non-routine problems involving operations with whole numbers	21.7
Level 1	Minimum	Recalling basic number facts; identifying place value; solving simple, routine word problems; chance	12.3
< Level 1	Below Minimum Level	Achievements not assessed by NAMA	2.6

¹⁷ The outcomes by mathematics skill were examined first for the 2004 data set (150 items). Figure 3.2 refers to the reduced set of 116 common items.

Just under 12% of pupils achieved at an 'Advanced' level (Level 5). Pupils at this level would be likely to succeed on the most complex tasks on the test and would also be expected to do well on items at lower levels. Almost three-quarters achieved at Levels 2, 3, or 4. Almost 15% of pupils (those scoring at Level 1 or below) had low levels of mathematics achievement.

Performance on Calculator Items

The mean percent correct score on the calculator section was just under 40, compared to an average of 55 across all sections. Booklets which included the calculator section were identified as significantly more difficult than booklets which did not. Item descriptors corresponding to selected calculator items and the percentage of pupils who answered them correctly, are presented in Table 3.2.

Description	% Correct	Difficulty*
Identify the number in a number sentence that should be left out to make it correct (e.g. $175 + 236 + 318 + 240 = 733$).	66.1	Easy
Indicate the missing operation to make a number sentence correct [e.g. $27 _ (31 _ 11) = 540$].	49.1	Moderate
Solve a routine problem involving operations with fractions (e.g. The normal price of a toy is €13. Its price is reduced by a quarter in a sale. What is the sale price?)	25.8	Difficult

* Difficulty levels were arrived at by identifying the 33rd and 67th percentiles on the distribution of percent correct scores for items in the calculator section.

Teachers' Judgements About Pupils' Mathematics Achievement

In both 1999 and 2004, teachers rated the performance of pupils in their classes, indicating the class level at which each pupil was functioning. In both years, approximately three-quarters of pupils were judged to be performing at Fourth class level or higher. In both years also, about 6% of pupils were judged to be functioning at a Second class level. The mean scores achieved by pupils judged to be performing at each class level were similar in 1999 and 2004, again indicating consistency in teacher ratings.

Main Findings

- The average scale scores of pupils in 1999 and 2004 were similar.
- In 2004, pupils achieved the highest mean percent correct score on the strand Data (69%), and the lowest on the Measures strand (49%). Performance on the Shape & Space and Data strands improved significantly between 1999 and 2004.
- Pupils performed best on the skill Understanding & Recalling (62%), and least well on Applying & Problem Solving (48%). Performance on Reasoning items improved significantly between 1999 and 2004.
- Almost 12% of pupils achieved at an advance level (Level 5) on the overall proficiency scale, while 15% achieved at or below the minimum level (Level 1).
- Pupils achieved a significantly lower mean score on the calculator section than on any other section, indicating that they found the calculator items to be more challenging.

4 Pupil Characteristics and Mathematics Achievement

In this chapter, relationships between pupil characteristics and mathematics achievement are described.

Demographic Characteristics of Pupils

A correlational analysis of key demographic variables revealed only two characteristics that correlated significantly with mathematics achievement: gender and membership of the Traveller community.

Male and female pupils' overall mean achievement scores did not differ significantly. At the 10th and 25th percentiles, females achieved higher scores than males, but differences are not statistically significant. From the 50th percentile upwards, males outperformed females, with differences reaching statistical significance at the 75th and 90th percentiles (Figure 4.1). Male pupils significantly outperformed females on one mathematics content area: Measures.

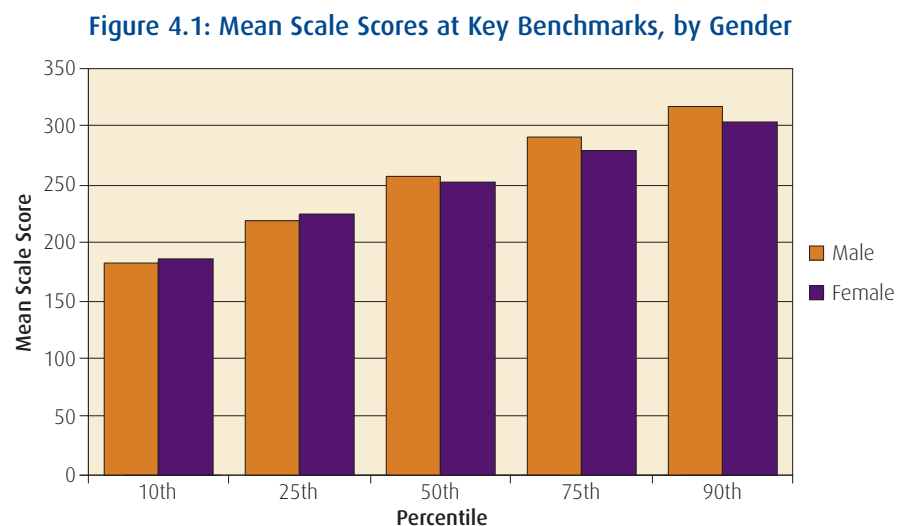

On the mathematics proficiency scale, a significantly higher percentage of male (15%) than of female (8%) pupils scored at Level 5.

Pupils from the Traveller community performed at a lower level than non-Traveller pupils at each of five key benchmarks (10th, 25th, 50th, 75th, and 90th percentiles).

Attendance at School and Participation in Extra Classes

Pupil attendance at school ranged from 60% to 100%, with a mean of 95%. Pupils with higher rates of attendance achieved significantly higher mean scale scores than pupils with lower rates.

A relatively small percentage of pupils participated either in extra (after-school) mathematics lessons (8%) or in a mathematics club (10%). These pupils achieved significantly lower mean scores in mathematics than pupils who did not participate in these activities.

Classroom-Related Pupil Characteristics

Pupils with high general academic ability, who work with limited supervision, and who demonstrate greater attention and persistence are more likely to achieve higher mean mathematics achievement scores. With the exception of 'academic ability', female pupils were rated higher than male pupils by their teachers on a range of classroom-related characteristics.

When considering strategies to cope with difficult mathematics tasks, more female than male pupils claimed that they would more frequently ask a teacher or a friend for help. The most commonly reported strategy for both male and female pupils was to 're-read and try again', which was the strategy that most strongly correlated with achievement.

Of the three scales designed to identify pupils' perceptions of mathematics (*Self-efficacy in Maths, Enjoyment of Maths, and Motivation for Maths*), only self-efficacy (i.e., confidence to solve mathematics problems) was associated with mathematics achievement. Females had significantly less confidence in their own mathematical abilities, but higher levels of enjoyment of mathematics, than male pupils. Levels of self-efficacy were also lower among pupils who attended school less frequently, though higher attendance was associated with lower scores on the enjoyment of maths scale. Older pupils in Fourth class had significantly lower motivation than younger pupils.

Comparison with the 1999 Study

The difference between the mean mathematics achievement scores of males and females was not significant in either 1999 or 2004 (Table 4.1).

Gender	Mean 1999 Score	Mean 2004 Score
Male	250.4	252.5
Female	249.6	248.9

Teacher ratings of pupil characteristics, such as general ability and persistence, were similar in 1999 and 2004, indicating the stability of the perception of such characteristics over time.

Main Findings

- Although there was no overall gender difference in achievement scores, male pupils scored significantly higher than female pupils at upper percentiles.
- Male pupils achieved a significantly higher percent correct score than females on items assessing Measures.
- Members of the Traveller community achieved a lower mean achievement score than non-members.
- Higher levels of participation in extra lessons and mathematics clubs were associated with lower mean achievement scores.
- Female pupils were rated by their teachers as more likely than males to exhibit certain learning characteristics, including ability to work with limited supervision, and persistence.
- More female than male pupils reported using 'Re-read and try again' as a strategy for coping with difficult mathematical tasks. This was the only strategy which was significantly associated with mathematics achievement.
- Males were more confident than females in their mathematics ability, though they claimed to enjoy the subject less.
- Pupils with higher school attendance achieved a significantly higher score on the mathematics test, and reported higher levels of self-efficacy in maths, but less enjoyment of the subject, than pupils with lower attendance rates.

5 Home Background and Mathematics Achievement

A parent/guardian of each child who participated in NAMA 2004 provided information relating to the child's home environment and resources, family structure and socioeconomic status, and involvement in, and support for, education and homework.

Family Structure

More than 4 out of 5 pupils lived with two parents. In the great majority of lone-parent families (90%), the parent/guardian was female. The mean mathematics achievement score of pupils who lived with two parents is significantly higher than the mean of pupils who lived with one parent. Pupils with no siblings, or with four or more siblings, had the lowest mean scores. The ordinal position of a pupil in his/her family was not associated with mathematics achievement.

Family Socioeconomic Status

Pupils with at least one parent in full-time employment had a significantly higher mean mathematics achievement score (258) than pupils whose parents were in part-time work (238), or were not working (218).¹⁸ Pupils from higher socioeconomic backgrounds (i.e., those in the top third of a distribution based on the highest occupation of either parent) achieved a higher mean achievement score than pupils from lower socioeconomic backgrounds (Figure 5.1).

Figure 5.1: Pupils' Mean Mathematics Achievement Scores, by Socioeconomic Background

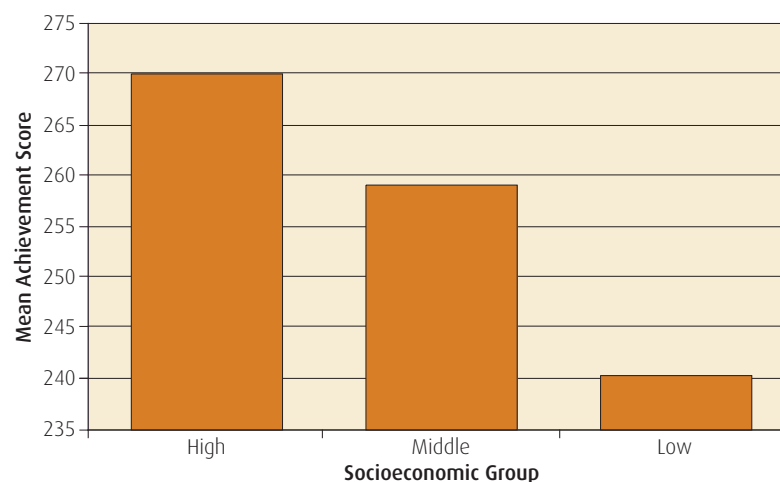

¹⁸ Parents' employment status was based on the highest level of employment of either parent.

Mean mathematics scores were also associated with level of parental education. Pupils of parents whose highest qualification was Junior Certificate level or lower achieved significantly lower mean scores than pupils whose parents had a Leaving Certificate, while pupils of parents with a basic degree and pupils whose parents had an advanced third-level qualification achieved significantly higher mean scores than pupils of parents with Leaving Certificate only.

Parental Involvement/Support

Almost two-thirds of parents were considered by their child's class teacher to be very supportive of their child's education, and, not surprisingly, children of these parents achieved a higher mean mathematics score. Children of parents who frequently engaged in mathematics activities and games at home (such as estimating cost and change or working with quantities) achieved a significantly higher mean score than the children of parents who never engaged in such activities.

While most parents had attended a parent-teacher meeting in the previous year, few parents (3%) had ever been involved in a parenting programme specific to mathematics. Although the mean achievement score of pupils whose parents had attended such a programme was lower (possibly because schools attended by lower-achieving pupils are more likely to offer a parenting programme), their enjoyment of the subject was greater than that of pupils whose parents had not attended a programme. Pupils whose parents attended formal parent-teacher meetings had more confidence in their own mathematics ability than pupils whose parents did not attend. Pupils' mean mathematics achievement scores and confidence in their own mathematics ability were positively associated with the extent of their parents' satisfaction with their progress in mathematics.

Home Resources

Pupils who, according to their parents, had access to the Internet, a suitable study area, or a calculator in their home achieved significantly higher mean scores than pupils who had not (Figure 5.2).

Figure 5.2: Mean Mathematics Achievement Scores, by Availability of Educational Resources in the Home

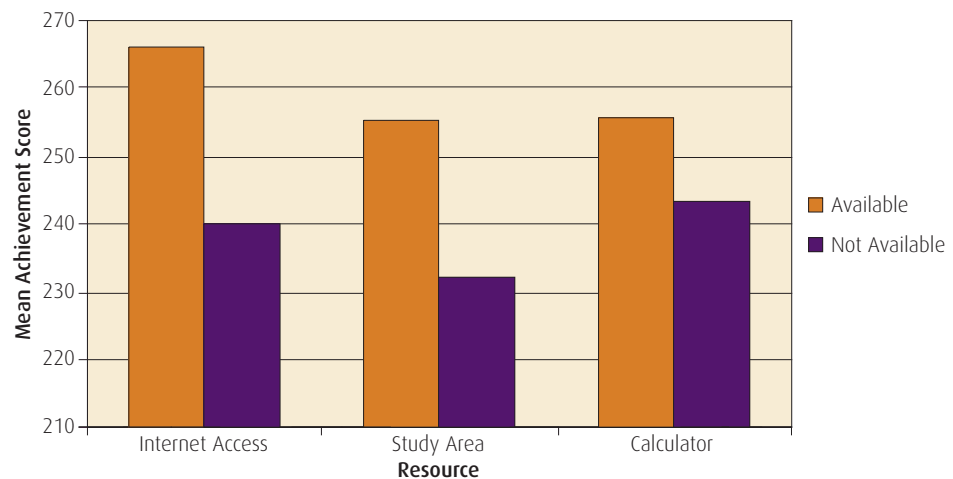

Pupils who had access to a computer at home also achieved a significantly higher mean achievement score than pupils who had not. Most pupils had access to a television, a games console, and a video/DVD player at home. Pupils with access to these resources in their bedroom had significantly lower mathematics achievement scores than pupils without access.

Based on time spent on a series of activities each day, lowest scores were achieved by pupils who spent no time on mathematics study and pupils who spent between one and two hours a day playing computer/console games. Highest scores were achieved by those who spent up to two hours per day on sport, extra classes, or reading for enjoyment, and not more than one hour on mathematics study. Pupils who spent more than one hour a day watching television or playing computer/console games achieved significantly lower scores than pupils who spent less than an hour a day on these activities.

Mathematics Homework

Over half of pupils received mathematics homework three or four times a week, and most spent approximately 15 minutes or less doing it. Pupils who were assigned homework three or four times a week had a significantly higher mean mathematics achievement score than pupils who were assigned homework every day.

According to parents, more than 7 out of 10 pupils received less than 15 minutes help with their mathematics homework every night. Pupils who were given no help had a significantly higher mean achievement score than pupils who were given greater amounts of assistance. Pupils needed most help with homework involving word problems and memorising tables.

Comparison with the 1999 Study

Besides greater access by pupils to home computers and less mathematics homework on a daily basis, few significant differences were noted for home background variables between 1999 and 2004.

Main Findings

- Pupils who lived with both parents/guardians had a higher mean mathematics achievement score than pupils who lived in a lone-parent family.
- Pupils from high socioeconomic status families achieved a higher mean score than pupils from middle or lower socioeconomic families.
- Pupils' mathematics achievement scores increased as the level of educational attainment of their parents increased.
- Pupils' confidence in their own mathematics ability was associated with degree of parents' involvement in the school, and parental satisfaction with their children's progress in mathematics.
- Achievement scores were higher for pupils whose parents reported that they integrated mathematics into everyday activities in the home.
- Pupils who had access at home to a calculator, the Internet, and a place to study, achieved on average, higher mean mathematics achievement scores than pupils who had not.
- Pupil participation in out-of-school activities such as sports, reading, music, dance, or language classes was associated with higher mathematics achievement.
- Lower mean mathematics achievement scores were attained by pupils who spent no time studying mathematics and by pupils who spent more than one hour a day playing computer/console games.

6 Classroom Environment and Mathematics Achievement

Most pupils were taught by a teacher who was permanent (88%), female (77%), and held a recognised teaching qualification (94%). Just over three-fifths of pupils were taught in single-grade classes, and almost one-quarter in classes with two grades. The overall average class size was 27.2. It was 27.0 in single-grade Fourth classes, and 27.3 in multi-grade classes that included Fourth class. Single-grade Fourth classes were smaller in designated (22.7) than in non-designated (28.6) schools.

In-Career Development

Teachers said that they had attended an average of 2.4 days of in-career development (ICD) in mathematics in the five years prior to the study, and just 0.3 days in the 12 months preceding the study. Almost 8% of pupils were taught by teachers who had at least five years teaching experience but who had not attended any course days on mathematics offered by the Primary Curriculum Support Programme (PCSP) in the past five years. When asked to indicate their satisfaction with the coverage of specific aspects of the Primary School Curriculum: Mathematics (PSCM) in ICD courses provided by the PCSP, most teachers were satisfied with the coverage of the Number strand, while coverage of Shape & Space and Data was considered less satisfactory. Teachers were least satisfied with the amount and quality of ICD courses dealing with mathematics skills, particularly Implementing, Applying & Problem Solving, and Communicating & Expressing. Areas in which teachers would like to see coverage introduced or increased include classroom-based assessment, interpreting standardised test scores, engaging pupils in group activities, identifying learning difficulties, and using calculators and information and communication technologies to teach mathematics.

Teaching Mathematics

Pupils received an average of 3 hours 36 minutes mathematics instruction per week. Pupils in single-grade classes received slightly more instruction (221 minutes) than pupils in multi-grade classes (209 minutes). Most time in all classes (83%) was allocated to actual instruction, with the remaining time allocated to management and administration.

The most commonly-used resources were textbooks and tablebooks; concrete materials and calculators were used less often (Table 6.1). Calculators were used mostly for routine computation and checking answers. The vast majority of pupils (92%) hardly ever or never used a calculator in a test or exam.

Table 6.1: Percentage of Pupils Whose Teachers Reported Using Resources for Teaching Mathematics with Various Frequencies

	N	Daily Usage	Once/Twice a Week	Once/Twice a Month	Hardly Ever or Never
Textbooks	4140	95.5	4.0	0.4	0.0
Tablebooks	4079	45.0	32.3	11.5	11.1
Workbooks/sheets	4084	20.4	47.3	26.6	5.8
Concrete materials	4104	8.7	42.8	44.4	4.1
Calculators	4085	4.7	17.4	44.5	33.4
Computers	4018	2.7	15.2	26.4	55.7
Other	4140	2.7	20.8	23.7	26.7

Almost one-third of pupils were taught by teachers who used the pupil edition of the class text as their main source in planning lessons, and a further 20% by teachers who drew on the accompanying teacher manual. Other sources, such as the 1999 PSCM and the School Plan for Mathematics, were used less frequently.

Almost 80% of pupils were taught by teachers who administered standardised tests of mathematics once a year, while 15% were in classes in which standardised tests were not administered. Most pupils (89%) were in classes in which teacher-made tests were used, and just 10% were in classes in which diagnostic tests were used.

Learning Support and Resource Teaching

Over one-quarter of pupils were taught by teachers who said they were unfamiliar with the *Learning Support Guidelines* as they relate to mathematics, and almost two-thirds by teachers who had not contributed to the development of school policy on the provision of learning support in mathematics. Most teachers agreed that there was some degree of integration, where relevant, between class and learning support/resource teaching programmes in mathematics.

School Climate and Mathematics

Over 90% of pupils were taught by teachers who agreed or strongly agreed that the attitude towards the 1999 PSCM in their school was positive, and that their school had a clear set of goals and priorities for teaching mathematics. However, one-quarter of pupils were taught by teachers who disagreed that the school had a clear set of goals and priorities for staff development.

Teachers' Comments on the PSCM

A total of 66 comments on the PSCM were made by 46 teachers. Just over 12% of comments expressed satisfaction with the curriculum. Negative comments related to large class sizes, a shortage of teaching resources, difficulties in teaching mathematics to certain groups (pupils with learning support needs, newcomer pupils, pupils with varying levels of ability in mathematics, and pupils in multi-grade classes), less-challenging textbook content, and poor availability of textbooks (especially in Irish). While comments about ICD and implementing the PSCM were positive, the need for ICD specific to particular class levels was suggested.

Teachers' comments largely suggest that they experience some difficulty in attending to the needs of pupils with varying abilities, a difficulty compounded by a perceived pressure to complete the full mathematics curriculum with all pupils, and by a shortage of resources.

Associations between Classroom Variables and Pupil Achievement

Three classroom variables correlated significantly with achievement. One indicated a tendency for larger classes to be associated with higher achievement. The others concerned more frequent use of computers, and greater teacher satisfaction with ICD. These were also associated with somewhat higher pupil achievement in mathematics.

Comparison with the 1999 Study

More pupils in Fourth class were taught by younger, less-experienced teachers in 2004 than in 1999. Average class sizes were significantly lower in 2004 than in 1999 in single-grade Fourth classes. Numbers in multi-grade classes did not change significantly.

Between 1999 and 2004, there was a significant decrease, which was larger in single-grade classes (47.5 minutes) than in multi-grade classes (19.7 minutes), in the amount of time allocated each week to teaching mathematics in Fourth class. Nevertheless, current allocation is in line with the recommended allocation (3 hours per week) in the PSCM.

Not surprisingly (given the introduction of calculators in the 1999 PSCM) calculator usage increased from just under 5% of pupils in 1999 to 67% in 2004. However, two-thirds of pupils who used calculators in 2004 did so no more than once or twice a month. There was no significant change in the percentage of pupils whose teachers indicated that they used a computer in mathematics classes. However, the use of software for practising mathematics skills and concepts, adventure games involving mathematics, and Internet resources for learning mathematics increased significantly between 1999 and 2004.

In 2004, 92% of pupils were taught by teachers who had attended an in-career development course in mathematics offered by the PCSP or other providers in the five years prior to the study. In 1999, just 16% of pupils were taught by teachers who had attended an in-career development course in the previous five years, before in-career development for the revised curriculum was available.

Main Findings

- Teachers in single-grade Fourth classes allocated an average of 221 minutes per week to teaching mathematics, while teachers in multi-grade classes allocated an average of 209 minutes to Fourth class pupils.
- Teachers used published mathematics schemes more often than other sources, including the PSCM, as their main source in planning lessons.
- Over 90% of pupils were taught by teachers who agreed that there was a positive attitude in the school towards the 1999 PSCM.
- Teachers' comments included expressions of satisfaction with the PSCM, the negative effect of large class sizes on curriculum implementation, lack of teaching resources, insufficient time for teaching mathematics, and difficulty with curriculum implementation in multi-grade classes.
- Single-grade Fourth classes were smaller in 2004 than in 1999.
- The percentage of pupils using calculators in mathematic classes increased significantly between 1999 and 2004, though, in 2004, two-thirds of pupils who used calculators did so no more than once or twice a month.
- The proportions of pupils whose teachers had attended in-career development in the five years prior to the 2004 survey, and in the 12 months prior to the survey, increased significantly since 1999, in line with implementation of the 1999 PSCM.

7 School Characteristics and Mathematics Achievement

School-level variables considered relevant to performance in mathematics are examined under the headings of school structure and composition, provision of learning support and resource teaching, issues affecting the teaching of mathematics, home-school links, and curriculum implementation.

School Structure and Composition

The mathematics achievement of pupils was not associated with the size or gender composition of the schools they attended, or with the percentage of pupils in the school whose first language was not English or Irish. Associations with mathematics achievement were found for four school-level variables: geographical location, designated disadvantaged status, average socioeconomic status, and average attendance rate.

Pupils who attended schools in rural areas achieved significantly higher scores than pupils who attended schools in cities, but did not differ in mean achievement from pupils in large or small towns. The mean achievement score of pupils in schools designated as disadvantaged (220) was significantly lower than the mean score of pupils in non-designated (256) schools. Figure 7.1 shows the percentage of pupils achieving at each mathematics proficiency level in designated and non-designated schools. While 35% of pupils in designated schools achieved scores at or below Level 1 (indicating minimal or no mathematics skills), the figure in non-designated schools was 12 percent.

Figure 7.1: Percentage of Pupils Achieving at Each Mathematics Proficiency Level, by Designated Status of School

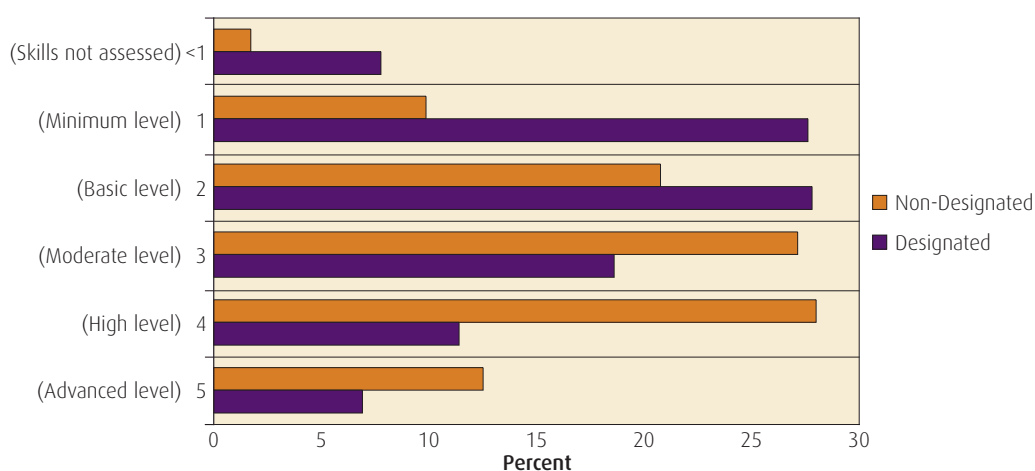

The socioeconomic status (SES) of the school (based on the average SES of the pupils' parents) correlated positively with mean pupil mathematics achievement: pupils from high-SES schools achieved a significantly higher mean score than pupils in medium- and low-SES schools.

The mean school-level attendance rate was 95 percent. Pupils attending schools that had a higher rate of attendance (i.e., above the 50th percentile on the distribution of average school attendance rates) had a significantly higher mean achievement score (258) than pupils attending schools that had a lower mean attendance rate (243).

Provision of Learning Support and Resource Teaching for Mathematics

A significantly higher percentage of pupils in designated than in non-designated schools were judged by their principal to require learning support for mathematics (Table 7.1). Across all schools, fewer than half of the pupils who were considered to need additional support received it. Over twice the percentage of pupils in designated schools (19%) than in non-designated schools (8%) were judged to be in need of resource teaching in mathematics. Provision for learning support for mathematics was lowest in Junior and Senior Infant classes and highest in senior classes (Third to Sixth class).

	Designated *	Non-Designated**	Total***
	Mean %	Mean %	Mean %
Learning Support			
Need LS	23.35	14.27	15.58
Receiving LS	6.63	6.83	6.80
Resource Teaching			
Need RT because of learning disability	18.74	8.46	9.75
Receiving RT	7.54	5.31	5.61

* N = 569; ** N = 3062; *** N = 4171

Issues Affecting the Teaching of Mathematics in Schools

From a list of 21 problems that might affect the teaching of mathematics in their school, principals of schools attended by 61% of the sample of pupils identified a shortage of learning support teachers for mathematics as a serious impediment to effectively teaching mathematics. This was followed by issues such as large classes (34%), a shortage of substitute teachers (25%), inadequate classroom accommodation (19%), and multi-grade classes (18%). Levels of pupil and parent disinterest were judged to be significantly higher in designated than in non-designated schools, while problems with staffing and accommodation were reported to be less serious in designated than in non-designated schools.

Home-School Links

Only 20% of pupils attended schools which had a programme to support parents in helping their children with mathematics at home, with designated schools more likely to offer such a programme. The most common type of programme offered was a class for parents on teaching methods in the school; and the least common, a basic maths skills programme.

Over 84% of pupils attended schools that had a parents' association, though having/not having an association was not significantly associated with mathematics achievement. In schools which had a parents' association, 82% of parents had attended a meeting in the year in which the survey was carried out. Attendance at such meetings did not correlate significantly with mathematics achievement.

Curriculum Implementation

In general, principal teachers expressed positive attitudes towards the 1999 PSCM. In response to a list of curriculum-related statements, most principals agreed that teachers were receptive to the mathematics curriculum, and that the curriculum had resulted in a more practical emphasis in teaching, while few agreed that the curriculum had an impact on pupils' problem solving skills and mathematics achievement.

Most school plans included provision for assessment and for the maintenance of pupils' achievement records. Few included statements relating to teaching problem-solving strategies, provision for pupils with learning difficulties in mathematics, or provision of enrichment activities for more advanced pupils.

A mean of 8.5 hours had been spent at staff meetings since the beginning of the academic year. Marginally more time was spent discussing the teaching and assessment of English (20% of all time at meetings) than of mathematics (18%). In general, more pupils in Third to Fifth classes than pupils at other class levels sat standardised tests once a year. Progress tests were generally administered on a more regular basis.

Comments from Principals

Principals' comments reflected a general level of satisfaction with the implementation of the mathematics curriculum. Positive comments related to the use of strands as tools for planning lessons, opportunities to develop understanding of concepts, and more time for group work as a result of reduced content. Concern was expressed, however, that the curriculum provided fewer challenges for average and above average pupils. There were also concerns about the availability of revised textbooks and inadequate provision of learning resources. Inadequate provision for learning support for mathematics was a common concern, especially when compared with provision for learning support in English. It was suggested that the 10th percentile on standardised tests was too low a

cut-off point to identify pupils for learning support, and needed to be reconsidered. Other issues included scepticism over calculator usage, parental support, and volume of work, though many acknowledged that it was still too early to comment on the current mathematics curriculum.

Comparison with the 1999 Study

The mathematics achievement of pupils in designated schools was broadly similar in 1999 and 2004, with over one-fifth of pupils each year scoring at or below the 10th percentile. Some issues considered to be very serious by principals in 1999 were regarded as less serious in 2004 (teacher in-career development, problems accessing equipment and materials, and multi-grade classroom arrangements). Similarities between comments expressed in 1999 and 2004 include concern about inadequate learning support provision and a desire for greater emphasis on more practical activities and group work in mathematics.

Main Findings

- Pupils attending schools in rural areas had a significantly higher mean mathematics achievement score than pupils attending schools in cities.
- Pupils who attended schools designated as disadvantaged achieved a significantly lower mean mathematics score than pupils in non-designated schools.
- Significantly more pupils in designated than in non-designated schools were judged to be in need of learning support for mathematics.
- A shortage of learning support teaching time, large class size, lack of provision for learning support, and inadequate teaching resources were identified by principal teachers as problematic in delivering effective mathematics teaching.
- Most school plans did not adequately address provision for pupils with learning difficulties.
- Comments from principal teachers suggest a general satisfaction with the implementation of the mathematics curriculum, but a concern that it fails to challenge some higher-achieving pupils.

8 Learning Support for Mathematics

Issues relating to learning support for mathematics are considered in this chapter. Of 172 respondents who completed the Learning Support Teachers' Questionnaire, 36% provided learning support for English only, 3% provided learning support for Mathematics only, and 62% provided learning support for both mathematics and English. Except in the first section, data in this chapter are based on the responses of teachers who provided learning support for mathematics.

Provision of Learning Support for Mathematics

Over half (51%) of pupils attended schools in which learning support was provided for mathematics. Teachers indicated that of the 14.4% of pupils in Fourth class who they considered were in need of learning support, less than half (6.5%) were receiving it (Table 8.1). Almost 3% of pupils in Fourth class had discontinued learning support, with the majority of these no longer considered to be in need of support.

In addition to pupils in receipt of learning support, almost 4% of pupils were in receipt of resource teaching in mathematics due to a mild or moderate general learning disability, or a specific learning disability.

Table 8.1: Percentage of Pupils in Need and in Receipt of Learning Support, and Percentage Discontinued (Fourth Class Only)

		In Receipt of LS				LS Discontinued			
		Yes		No		Yes		No	
		N	%	N	%	N	%	N	%
In Need of LS	Yes	272	6.5	328	7.9	14	0.3	585	14.0
	No	0	0	3566	85.6	107	2.6	3459	83.0

Data based on the Pupil Rating Form completed by class teachers for each pupil in NAMA 2004

The mean mathematics achievement scores of pupils in need and in receipt of learning support or resource teaching for mathematics were significantly lower than the mean score of pupils who were not in need or in receipt.

Background of Learning Support Teachers

Over three-fifths (62%) of learning support teachers provided support in one school only, while fewer than 10% provided support in more than three schools. Although teachers had a mean of 23.8 years teaching experience, the mean length of time they had been engaged in learning support was 6.4 years. Just under half of respondents had completed a one-year, part-time course sanctioned by the Department of Education and Science, or its equivalent, and 9% were in the process of completing one. Teachers who had completed the course expressed satisfaction with its more practical aspects, such as assessing pupils' learning difficulties in mathematics and implementing the *Learning Support Guidelines* as they relate to mathematics. They were less satisfied with topics pertaining to working effectively with parents and class teachers.

Satisfaction with PCSP courses relating to the curriculum was generally high, particularly for topics relating to curriculum implementation and the underpinning framework. Teachers expressed most dissatisfaction with how pupils' learning difficulties in mathematics and planning learning programmes for pupils receiving learning support were addressed

Work of Learning Support Teachers

Teachers spent just a quarter of their time providing pupils with learning support for mathematics, and 2% of their time working with class teachers on issues related to learning support for mathematics. Much of the remaining time was allocated to providing learning support for English.

When considered as a percentage of the total number of pupils in receipt of learning support in English and mathematics combined, total learning support provision for mathematics comprised less than one quarter (24%) of teachers' total caseloads. As displayed in Figure 8.1, more pupils were in receipt of learning support for English than for mathematics, and provision for English also started at an earlier age than for mathematics.

Figure 8.1: Comparison of Distribution of Learning Support Caseloads for English and Mathematics, by Class Level

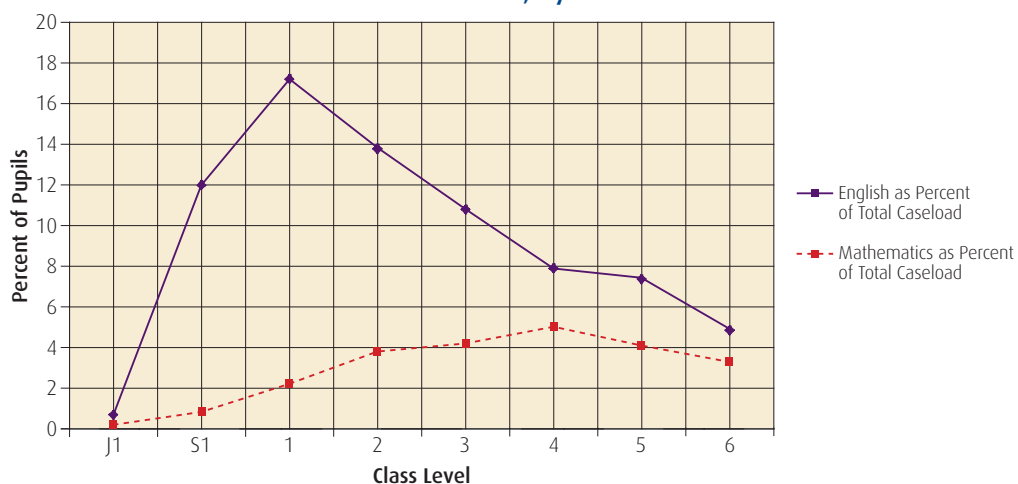

Virtually all learning support teachers felt involved in the maintenance of regular plans and progress reports for pupils, though fewer were involved in implementing strategies for early identification to prevent learning difficulties. Standardised testing was the procedure most frequently used to identify and select pupils for learning support for mathematics; other frequently used criteria included advice from other professionals, parental concerns, and teacher checklists.

During class, the greatest emphasis was placed on the content strand of Number, the least on Data. The skills of Implementing and Integrating & Connecting were emphasised more than higher-order processes such as Applying & Problem Solving, Reasoning, or Communicating & Expressing.

Almost three-quarters of learning support teachers agreed that the *Learning Support Guidelines*, as they relate to mathematics, were being implemented in their school, and most found them useful in their work. However, only 15% of learning support teachers believed that class teachers were 'very familiar' with the *Guidelines*, and over a quarter (27%) believed that they were 'not familiar' with them.

Most learning support teachers (86%) were satisfied with the availability of structured materials, environmental materials, and computer hardware/software for teaching mathematics. Few were satisfied with the availability of diagnostic tests.

Perceptions of Learning Support Provision in Schools

Seventy-eight percent of learning support teachers believed that they shared responsibility with class teachers for the progress of pupils' learning, while 74% characterised learning support provision for mathematics as a team effort that involved all teachers. Less than half (45%) believed that learning support was meeting the needs of pupils with learning problems in mathematics in their schools, and almost two-thirds believed that there was not a clear policy for learning support in mathematics in the school in which they received the questionnaire.

Learning Support Teachers' Comments

The most frequently recurring issues raised by learning support teachers related to inadequate levels of support for mathematics, particularly when compared with provision for English. A perceived lack of learning support for mathematics was seen as impeding planning and communication with class teachers, and reducing time spent with pupils in need. Additional comments related to limited learning resources, a need to develop diagnostic tests based on Irish norms, a need to review the appropriateness of the 10th or 12th percentile as a cut-off point for selecting pupils, and a lack of time for learning support in mathematics.

Comparison with the 1999 Study

There was a slight increase in the percentage of pupils in schools in which learning support for mathematics was provided between 1999 (44%) and 2004 (51%), though fewer pupils attended designated schools in which provision was available in 2004 (26%) than in 1999 (48%). The percentage of pupils considered to be in need of learning support in mathematics in 2004 (14%) was significantly lower than the percentage considered to be in need in 1999 (21%). The percentage in receipt of learning support for mathematics in 1999 (8%) was marginally higher (but not in a significant degree) than in 2004 (7%). It is likely that any decline in learning support provision has been offset by the increased availability of resource teaching in mathematics for pupils with general or specific learning difficulties.

In 1999, teacher recommendations were rated by 67% of teachers as the most important criterion for identifying pupils with learning difficulties in mathematics, with only 28% of teachers using standardised tests as the primary method of selection. In 2004, almost all learning support teachers (98%) said that performance on standardised tests was the most important criterion.

Main Findings

- Just over half of pupils attended schools in which learning support for mathematics was provided.
- Six and a half percent of pupils were in receipt of learning support in mathematics; 8% were considered to be in need but not in receipt at the time of the survey; and almost 4% were receiving resource teaching that included mathematics.
- Fifty-eight percent of learning support teachers of mathematics had completed, or were completing, the one-year, part-time course sanctioned by the Department of Education and Science or equivalent.
- Learning support classes focused primarily on the strands of Number, Measures, and on the skills of Implementing, and Integrating & Connecting.
- Few learning support teachers believed class teachers were 'very familiar' with the *Learning Support Guidelines* as they relate to mathematics.
- Learning support teachers were generally satisfied with the availability of structured and environmental materials for teaching mathematics.
- Differences in provision of learning support for English and mathematics were identified frequently in the additional comments provided by learning support teachers.

9 Inspectors' Views on Teaching and Learning Mathematics

In this chapter, the responses of 50 inspectors who completed a questionnaire about the teaching of mathematics in Fourth class are presented. Respondents had worked as inspectors for an average of 10.2 years. In the two years prior to the survey, they had observed an average of 30 mathematics lessons each involving pupils in Fourth class, and had completed an average of 16 School Reports (*Tuairiscí Scoile*) that included mathematics in Fourth class.

Planning, Grouping for Instruction, and Homework

Inspectors were asked to indicate their views on the effectiveness of a range of approaches to teaching mathematics. Very effective approaches identified included grouping pupils for instruction, and the use of ICT and calculators. The daily use of workbooks/worksheets was identified as ineffective.

In general, inspectors were satisfied with the quality of both short- and long-term aspects of planning. Greater dissatisfaction was expressed with the balance between whole-class work, group work, and individual work in single-grade than in multi-grade classes. All but 15% of inspectors expressed satisfaction with the amount of mathematics homework assigned to pupils.

Teaching and Assessment of Mathematics

Highest levels of satisfaction with the teaching of strands of the PSCM were recorded for Number, Measures, and Shape & Space, while highest levels of dissatisfaction were expressed for Data and Algebra. In their assessment of the teaching of mathematics skills, inspectors expressed most satisfaction with Understanding & Recalling and Implementing, and least with Communicating & Expressing, Reasoning, and Applying & Problem Solving.

A majority of inspectors expressed satisfaction with the availability of resources for each of the five mathematics strands in the curriculum, though a sizeable percentage expressed dissatisfaction with the availability of resources for Algebra and Data. A large majority (86%) expressed satisfaction with the feedback given to pupils during class work, while 62% expressed satisfaction with the feedback offered to pupils on independent work completed in class. Just half of the inspectors expressed satisfaction with the quality of feedback offered to pupils on homework.

Although 4 out of 5 inspectors expressed satisfaction with the administration of standardised tests of mathematics, only half that number were satisfied with the interpretation of test results. Inspectors were more dissatisfied than satisfied with the use of informal assessments of mathematics in classrooms, and just over 60% expressed dissatisfaction with the administration of diagnostic tests of mathematics, a reflection of the low usage of such tests in some classrooms.

Dealing with Individual Differences

The vast majority of inspectors (84%) were satisfied with teachers' work in identifying and addressing pupils' common errors in mathematics. However, over half were dissatisfied with the ways in which pupils' misconceptions and learning difficulties were identified and addressed, and over four-fifths expressed dissatisfaction with the teaching of mathematics to lower-achieving pupils. Just over 40% of inspectors expressed satisfaction with the identification and selection of pupils for learning support for mathematics, while only a quarter expressed satisfaction with the co-ordination of the work of class and learning support teachers.

Professional Development in Mathematics

Almost three-quarters of inspectors rated teachers' knowledge of mathematics concepts and processes and their understanding of the 1999 PSCM as 'very comprehensive' or 'comprehensive'. On the other hand, 70% described teachers' knowledge of methods for teaching mathematics as somewhat limited.

Inspectors indicated that the strands Data and Algebra should be emphasised more strongly in both pre-service and in-career development courses on mathematics. Reasoning and Applying & Problem Solving were the skills identified by the largest majorities of inspectors as most in need of attention, while almost one-half also indicated that Implementing required additional attention.

Almost two-thirds of inspectors identified a need for greater attention to engaging pupils in practical mathematics activities in pre-service and in-career development courses. Other topics considered to require more emphasis included interpreting the results of standardised tests, approaches to teaching mathematics, using ICTs, and grouping children.

Inspectors' Comments

While inspectors' comments on the inclusion of concrete materials following implementation of the 1999 PSCM were positive, concern was expressed that materials were not as widely used as they should be, particularly in senior classes.

Inspectors noted a reduced emphasis by teachers on problem solving in middle and senior classes relative to junior classes. Specific comments referred to a need for greater attention to teaching problem solving strategies explicitly, and a need to ensure that the language structures required for problem solving were in place.

Textbooks were considered to be overused in both planning and teaching, despite the fact that teachers themselves were knowledgeable about the curriculum and the use of concrete materials/equipment. Inspectors recommended more activities designed to develop the language of mathematics and apply mathematical concepts to real-life contexts. Comments on grouping noted the prevalence of whole-class instruction which, it was suggested, did not meet the needs of lower-achieving pupils.

Inspectors identified a need to provide more learning support for mathematics, and to ensure greater integration between class and learning support programmes.

Main Findings

- Strategies identified by inspectors as being effective for teaching mathematics included grouping pupils for instruction and the use of ICTs and calculators.
- Inspectors were most satisfied with the teaching of the Number, Measures, and Shape & Space content strands, and with the skills of Understanding & Recalling and Implementing.
- Inspectors were least satisfied with the teaching of Data and Algebra, and the teaching of the higher-order skills of Communicating & Expressing, Reasoning, and Applying & Problem Solving.
- A majority of inspectors expressed dissatisfaction with teachers' ability to interpret the results of standardised tests of mathematics.
- Only 4 in 10 inspectors expressed satisfaction with the identification and selection of pupils for learning support for mathematics, and a quarter were satisfied with the integration of the work of class and learning support teachers.
- While almost three-quarters of inspectors considered teachers' knowledge of mathematical concepts and processes to be comprehensive, 70% felt that teachers' knowledge of methods for teaching mathematics was somewhat limited.
- Inspectors advocated more systematic and explicit approaches to teaching problem solving, and less emphasis on textbooks in favour of activities designed to develop the language of mathematics and to apply mathematical concepts to real-life contexts.

10 Recommendations

Recommendations based on the findings of this study are presented under the key areas to which they relate. These include mathematics content strands and process skills, mathematics proficiency levels, pupils with low achievement levels, gender differences, home-school links, planning for and organising mathematics in schools and classrooms, use of resources in classrooms, learning support for mathematics, and teacher education in mathematics.

Mathematics Content Strands

- R1** Teachers should support pupils' development in Shape & Space by engaging them to a greater degree in tasks involving reasoning about shape and space in school and in other contexts.
- R2** Teachers should extend work relating to data collection, data analysis, and constructing and interpreting graphs to subjects such as geography and science, as well as to real-world problem contexts. Opportunities to apply knowledge about Number, Measures, and Shape & Space strands in other subject areas and in real-life contexts should be sought.
- R3** Teachers should accord greater emphasis to the Measures strand by providing opportunities for pupils to transfer the knowledge and skills acquired in practical activities to non-routine problems.

Mathematics Process Skills

- R4** Schools and teachers should place a stronger emphasis on teaching higher-order mathematics skills, including Applying & Problem Solving, to all pupils by implementing in a systematic way the constructivist, discussion-based approaches outlined in the *Guidelines* accompanying the 1999 PSCM.
- R5** The Department of Education and Science should support the implementation and evaluation of pilot projects linked to problem-based approaches to teaching mathematics such as Realistic Mathematics Education (RME).



Mathematics Proficiency Levels

R6 The value to teachers of proficiency levels for interpreting and reporting the outcomes of mathematics tests should be examined and, if appropriate, their use should be extended.

Pupils with Low Achievement in Mathematics

R7 Schools and teachers with large numbers of pupils from disadvantaged backgrounds should implement the recommendations for the improvement of numeracy outlined in the LANDS report, including those related to school-level planning, the creation of suitable classroom environments for mathematics, the provision of extensive practice in developing mathematics skills in all curriculum strands, the development of stronger links between class and learning support teachers, and the analysis of standardised test results to inform planning.

R8 The DES should pay particular attention to the development of numeracy skills in the context of implementing the DEIS Action Plan, by appointing advisors to work with schools, and by ensuring that other support systems, including in-career development for teachers and support programmes for pupils with learning difficulties, are put in place, and their effects on achievement are monitored in the short and medium terms.

R9 Designated disadvantaged schools should take appropriate steps to build on existing initiatives such as the participation of parents in parent-teacher meetings and in mathematics classes for parents, to ensure the ongoing involvement of parents in their children's mathematics development.

R10 The achievement in mathematics of pupils in various at-risk groups, including pupils in designated disadvantaged schools, Traveller children, and 'newcomer' pupils for whom the language of instruction is not their first language, should be monitored in future national assessments, increasing the representation of pupils in these subgroups in the national sample if necessary.

Gender Differences in Mathematics Achievement

R11 Research should be conducted to investigate the nature of emerging gender differences in performance in mathematics at primary-school level. Relevant aspects might include school composition, instructional practices, and pupil dispositions.

Home-School Links and Mathematics Achievement

R12 Schools and teachers should support parents in developing their child's proficiency in mathematics, through provision of information on changes in curriculum and teaching methodologies, advice on engaging children in mathematics-related activities at home, and guidance on using homework (including the amount of time to allocate to homework) to support learning.

R13 Parents should seek ways to support the development of children's mathematics proficiency at home, through engaging them in informal mathematics activities including games involving estimation, providing them with relevant resources, and giving them appropriate support in completing homework activities.

Planning for and Organising Mathematics in Schools and Classrooms

R14 Schools should base their development plans for mathematics on the PSCM, and should ensure congruence between school plans and class plans for mathematics. Both types of plan should include arrangements for grouping pupils for mathematics teaching, strategies for teaching problem solving, provision for pupils with learning difficulties, and provision for high achievers.

R15 Teachers should ensure that there are links between school plans and class schemes in mathematics. Opportunities for collaborative planning and analysis should be organised by school management in order to facilitate class teachers and support teachers in jointly implementing programmes for children with learning difficulties in mathematics.

R16 Schools and teachers should ensure that adequate time is available during mathematics lessons to implement the approaches to developing problem solving skills outlined in the 1999 PSCM. These include making hypotheses, constructing mathematics models, drawing diagrams, looking for patterns, experimenting with strategies, and discussing outcomes in small-group and whole-class contexts.

R17 Future national assessments of mathematics should continue to monitor the effects of reduced dedicated teaching time on pupil achievement in mathematics, taking into account the integration of mathematics into other subject areas.

Use of Resources in Mathematics Classrooms

R18 Schools and teachers should ensure that an appropriate range of resources (including environmental resources) are used in mathematics lessons at all class levels. There is a need to use resources on a more frequent basis in at least two mathematics strands in particular - Shape & Space and Data.

R19 Schools and teachers should extend the use of calculators and ICTs to teach mathematics, in line with the guidelines on the 1999 PSCM. Calculators and ICTs should be used not only to develop skills such as basic computation, but also to enhance mathematics reasoning and problem solving skills.

R20 Schools and teachers should be facilitated and supported through professional development training, in extending the use of calculators and ICTs in mathematics classes as tools for teaching and learning.

Learning Support for Mathematics

R21 The DES and schools should monitor implementation of the general allocation model for assigning support teachers to schools to ensure that adequate provision is made in all schools for pupils with learning difficulties in mathematics.

R22 The DES and schools should ensure that learning support teachers have access to an appropriate initial course when they undertake learning support teaching for the first time, and to other relevant courses on an ongoing basis thereafter.

R23 Teachers should be supported by the DES and school management in planning the co-ordination of class and learning support programmes for pupils with learning difficulties in mathematics.

Teacher Education in Mathematics

R24 The DES, its agencies, and schools should adopt a structured approach to planning in-career development for teachers in mathematics. Time should be given in ICD courses to supporting teachers in implementing approaches to teaching higher-order mathematics skills including Applying & Problem Solving, and to addressing issues in the areas of classroom assessment, the interpretation of standardised tests, identifying learning difficulties, grouping pupils for instruction, and using calculators and ICTs to support mathematics teaching and learning.

R25 Colleges of Education should provide professional mathematics courses that would build on students' mathematical literacy skills and develop their ability to reason mathematically in teaching contexts.

R26 Schools and other agencies should support beginning teachers in reflecting on, and developing, their knowledge about teaching mathematics.

Appendices

Appendix A: Sample Test Items from NAMA 2004

For each item, the content strand, skill category, principal processes, and the item type (multiple choice or short answer) are given. The performance of pupils in NAMA 2004 on an item similar to the sample item is also summarised, and the number of pupils who attempted the item is noted.

Sample Item 1

Content strand: Number

Skill category: Integrating & Connecting

Principal process skill: Connect modes of representing fractional numbers

Item type: Multiple-choice

Which of these figures has one third shaded? (Circle one letter, A, B, C, or D)

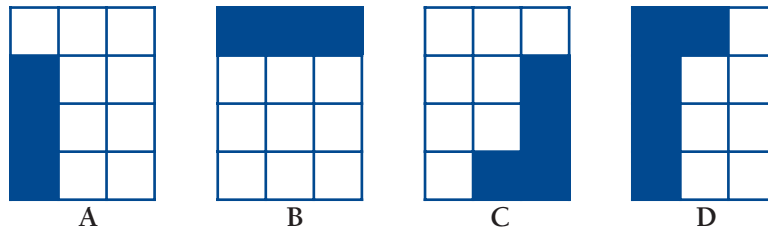

Answer: C

Similar Item	N	% Correct
A20	1669	39

Sample Item 2

Content strand: Algebra

Skill category: Integrating & Connecting

Principal process skill: Connect verbal and symbolic problem representations

Item type: Multiple-choice

holds the number of press-ups Eva does every morning. Which of these shows the total number of press-ups Eva does in a week?

A $7 + \square$

B $7 \times \square$

C $\square \div 7$

D $5 \times \square$

Answer: B

Similar Item	N	% Correct
B14	4171	61

Sample Item 3

Content strand: Shape & Space

Skill category: Understanding & Recalling

Principal process skill: Understand and recall meaning of parallel and perpendicular lines

Item type: Multiple-choice

Which of these shapes has perpendicular lines?

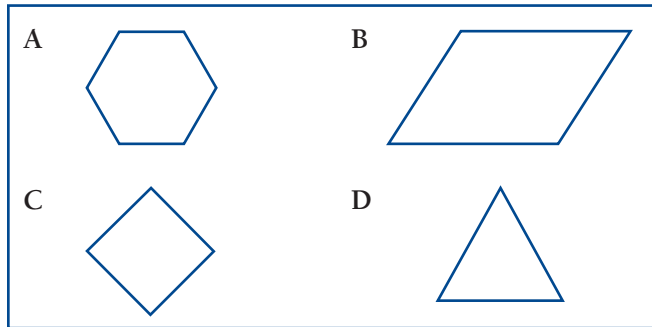

Answer: C

Similar Item	N	% Correct
B24	4171	60

Sample Item 4

Content strand: Measures

Skill category: Applying & Problem Solving

Principal process skill: Solve routine problems involving measure of length

Item type: Short Answer

How much taller is the cylinder than the box?

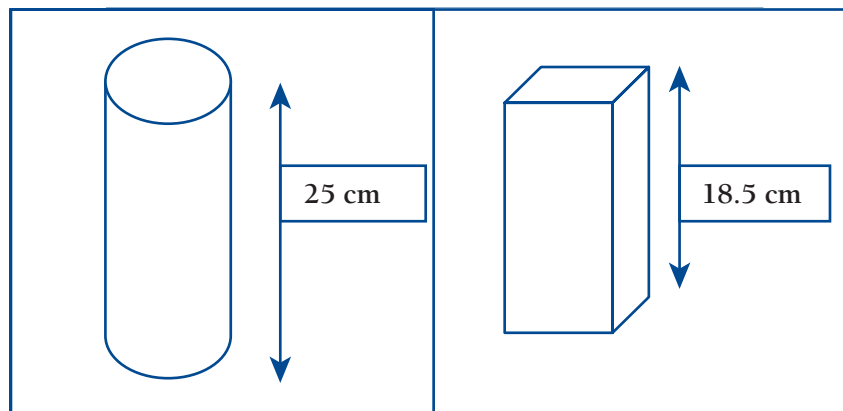

Answer: 6.5 cm

Similar Item	N	% Correct
B23	4171	42

Sample Item 5

Content strand: Data

Skill category: Reasoning

Principal process skill: List systematically all possible routes on a map

Item type: Multiple-choice

This part of a map shows five roads, A, B, C, D, E. What are all the different ways you can drive from Ounmore to Templebeg?

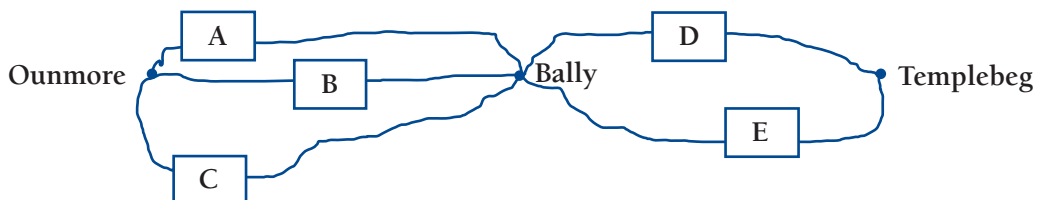

- A CD, BD and AE
- B CD, AD, BD and AE
- C AE, CD, BD, AD, and BE
- D AE, AD, BD, BE, CD, and CE

Answer: D

Similar Item	N	% Correct
D20	1665	35

Sample Item 6

Content strand: Number

Skill category: Applying & Problem Solving

Principal process skill: Solve routine word problem involving use of division facts

Item type: Short-answer

Mum has a box of 36 chocolates. She divides them among 9 children so that each gets the same number of chocolates. How many chocolates does each child get?

Answer: 4

Similar Item	N	% Correct
A05	1669	77

Appendix B: Proficiency Levels - Summary Descriptions

Level 5 Advanced Level of Mathematics Achievement

Implement procedures for estimating sums and quotients
 Connect decimal and fraction notation in measure contexts
 Extend more complex patterns in number
 Hypothesise and test answers for correctness (mixed operations number sentences)
 Apply concepts of ratio and proportion in practical contexts
 Solve non-routine multi-step problems involving fractions and measures

Level 4 High Level of Mathematics Achievement

Recall and use definitions of parallel and perpendicular lines
 Identify angle types in 2-D shapes
 Partition 2-D shapes using fractions
 Add measures of length
 Identify missing information in problems
 Identify a fraction between two fractions
 Make informal deductions about properties of 2-D shapes
 Apply concept of scale to reading maps
 Hypothesise and test answers for correctness in multiplication or division sentences
 Convert fractions to decimals
 Solve routine problems involving calculation of perimeter

Level 3 Moderate Level of Mathematics Achievement

Calculate a fraction of a number
 Divide a decimal by a whole number
 Round four-digit numbers
 Estimate products of whole numbers
 Implement procedure for division of whole numbers
 Order fractions in terms of magnitude
 Identify fractional areas of regular 2-D shapes
 Visualise properties of 3-D shapes from 2-D nets
 Complete number sentences involving associative and distributive properties
 Connect verbal, diagrammatic and symbolic representations of problems
 Hypothesise and test answers for correctness (single operation number sentence)
 Solve non-routine one-step problems involving operations with fractions and measures

Level 2 Basic Level of Mathematics Achievement

Calculate area of regular shapes using a grid
Identify decimal between two decimals
Implement procedures for multi-digit subtraction and long multiplication
Select appropriate units of measure
Connect diagrammatic and verbal representations of problems
Visualise and identify properties of 2-D and 3-D shapes
Extend decimal number patterns
Reason with place value and notation of 4-digit numbers and decimals
Hypothesise answers and test them for correctness (addition number sentences)
Apply Unitary Method in everyday contexts
Make informal deductions about simple graphical data
Analyse tables of data to solve routine and non-routine problems
Solve routine problems involving operations with whole numbers, fractions, and measures
Solve non-routine problem involving operations with whole numbers

Level 1 Minimum Level of Mathematics Achievement

Recall basic multiplication and division facts
Identify place value in 4-digit numbers and in 2-place decimals
Identify properties of 2-D shapes
Implement procedures for multi-digit addition and short multiplication
Order simple events in terms of likelihood of occurrence
Read and interpret bar charts, line graphs, tables, decimal scales, and area diagrams
Identify and extend simple number patterns
Combine and partition 2-D shapes into sets of specified shapes
Solve simple, routine word problems involving multiplication/division facts; calendar; subtraction; chance

Glossary

Statistical Terms Used in This Report

While this report is designed for a general readership, some statistical terms have been used in describing findings.

Correlation Coefficient

A correlation coefficient is a measure of the relationship between two variables. Values can range from -1.00 to +1.00. A negative correlation (e.g., -.45) means that as one variable increases in magnitude, the other decreases; a positive correlation (e.g., .35) means that both either increase or decrease together.

A value of 0 indicates that there is no relationship between variables, while the closer a value is to ± 1 , the stronger the relationship between variables. A strong positive correlation does not mean that one variable is causally related to the other.

Scale Score

When a pupil completes a test, basic calculations are carried out to check how many answers are correct. The resulting raw scores are then converted to scale scores, to give a more regular distribution of scores, and allow comparison across different tests.

In this assessment, test results were placed on the scale used in NAMA 1999. The mean score in 2004 was 251, and the standard deviation 49. This means that 68% of pupils' scores fall between 202 and 300 (i.e., within one standard deviation above or below the average of 251).

Percentile

A percentile rank indicates how the scale score achieved by a pupil or group of pupils compares with the scores of other groups/pupils. If a pupil achieves a percentile rank of 10, it means that his or her scale score on the test is the same as, or better than, 10% of pupils nationally.

Significant Difference

A significant difference in achievement between groups is one that a statistical test has established as unlikely to be due to chance.



ISBN 0-7557-7319-5



9 780755 773190