

ABLIM NJ

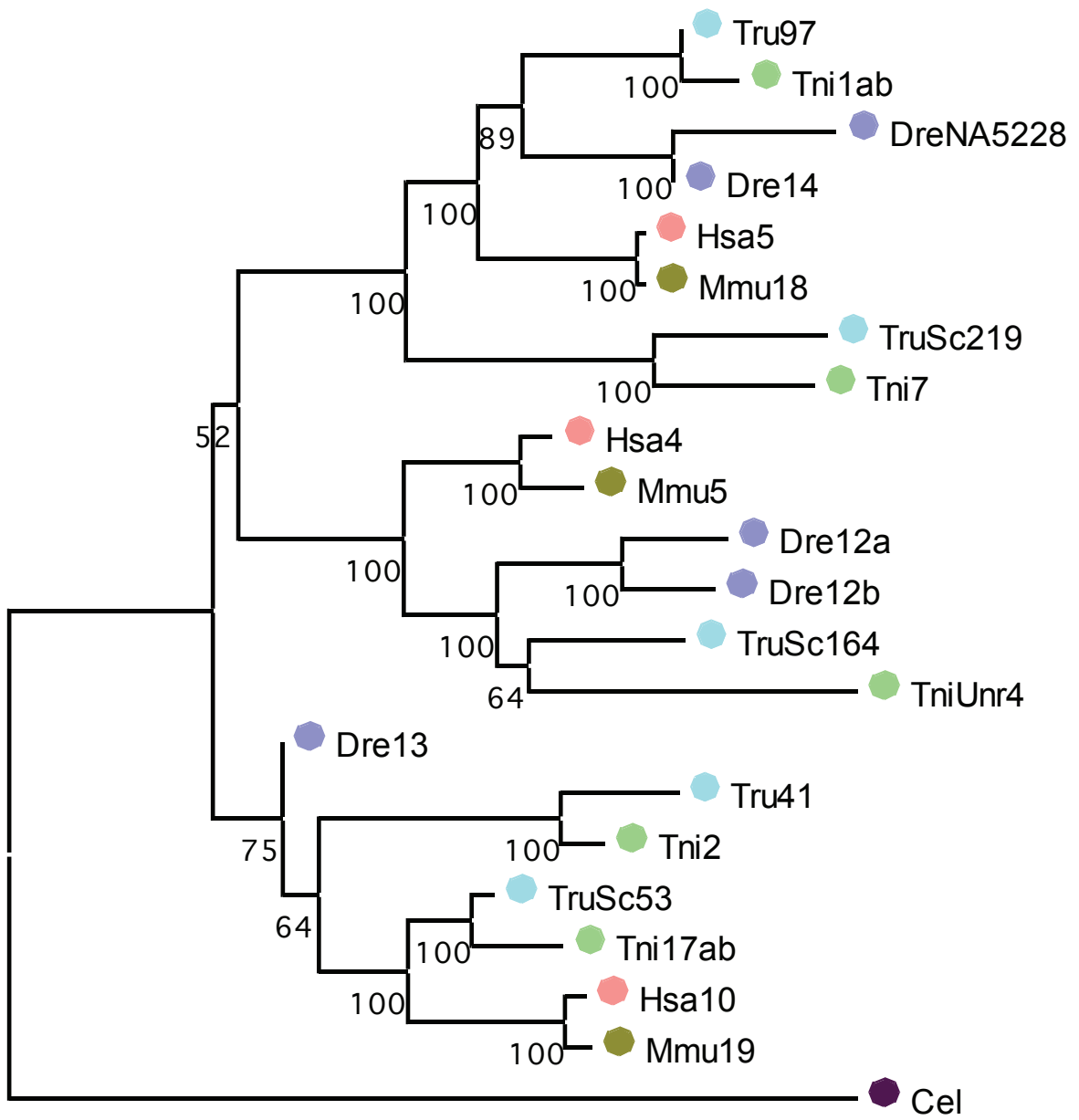

0.1

ADAMTS NJ

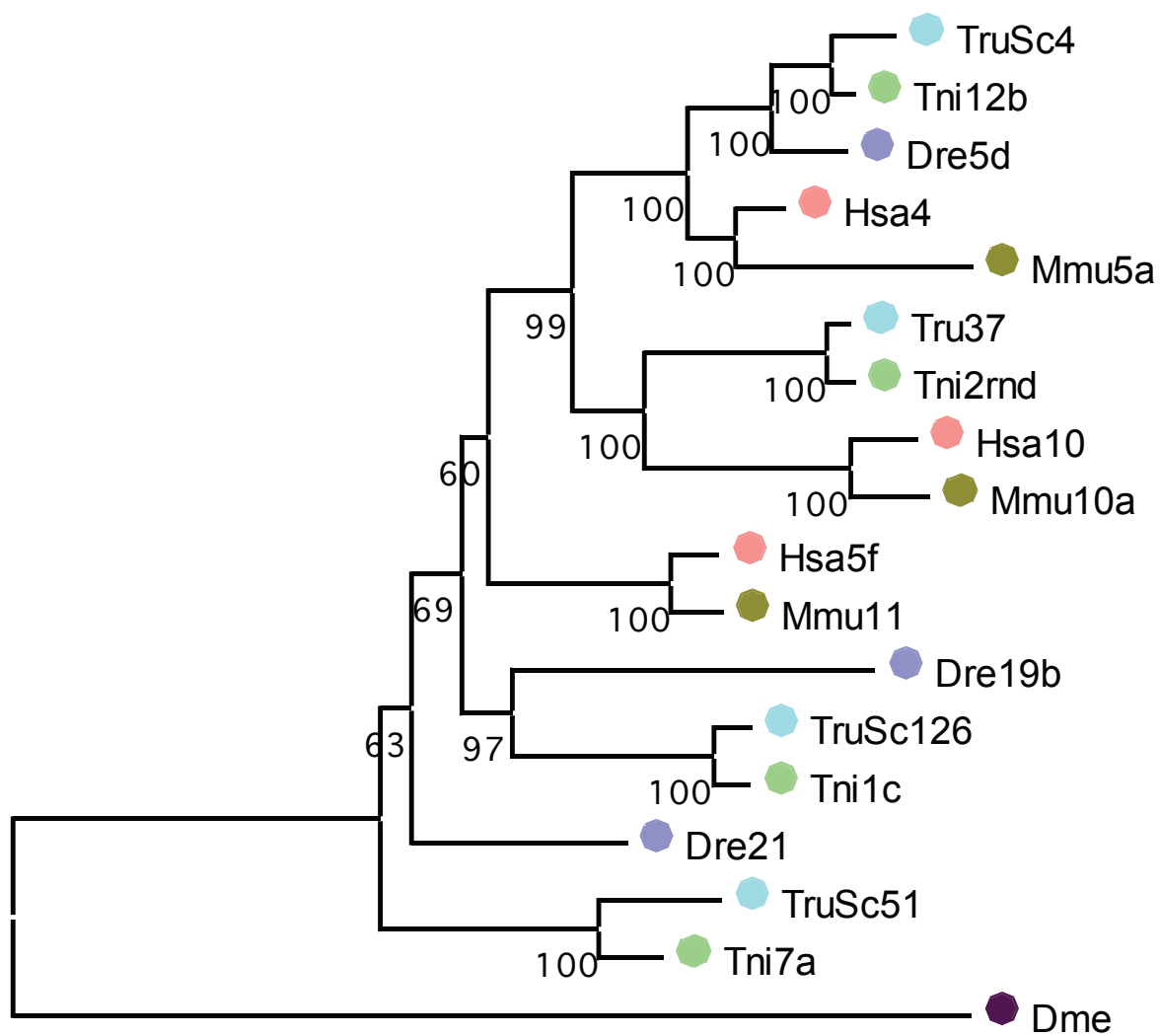

0.1

Ankyrin NJ

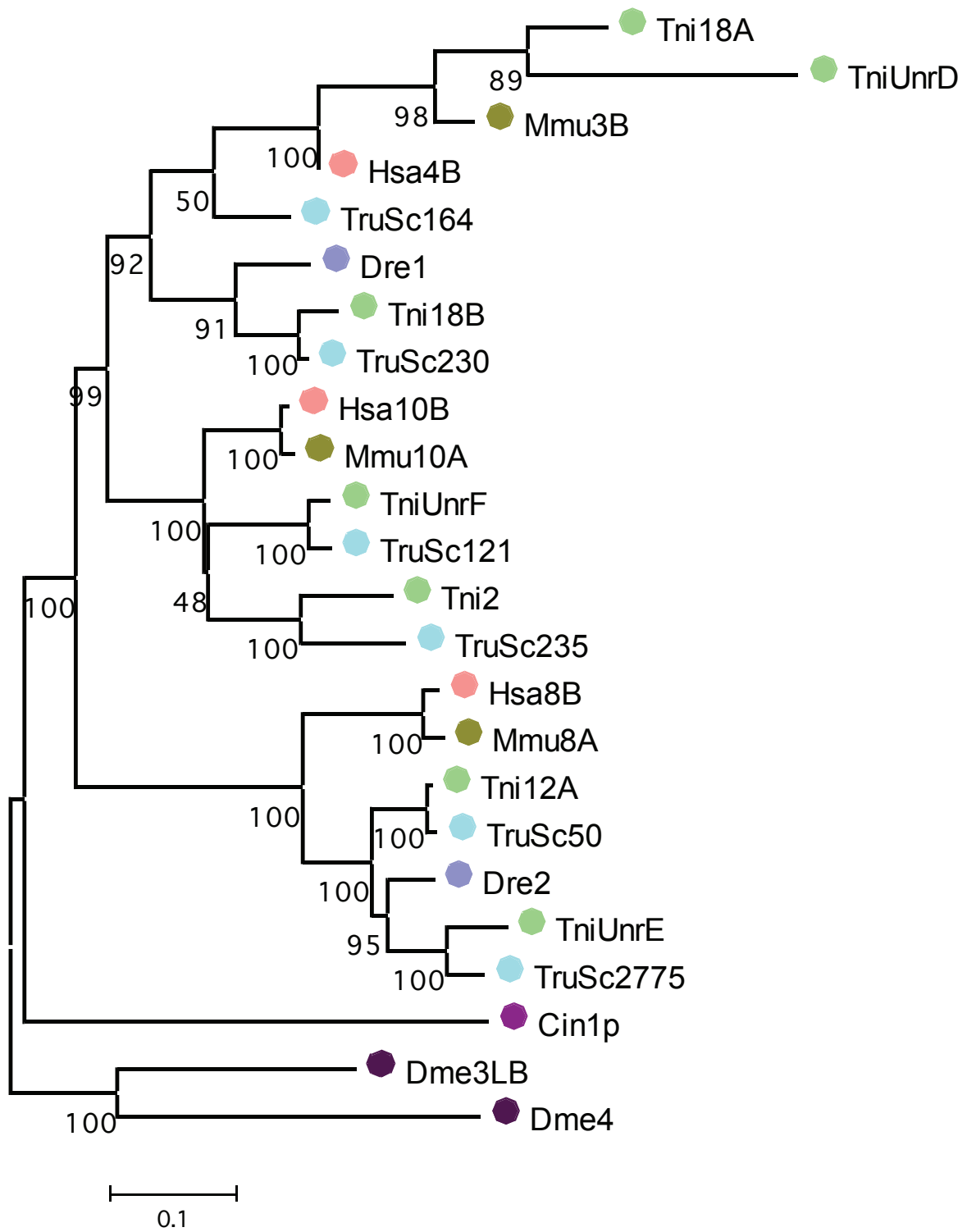

ANX

NJ

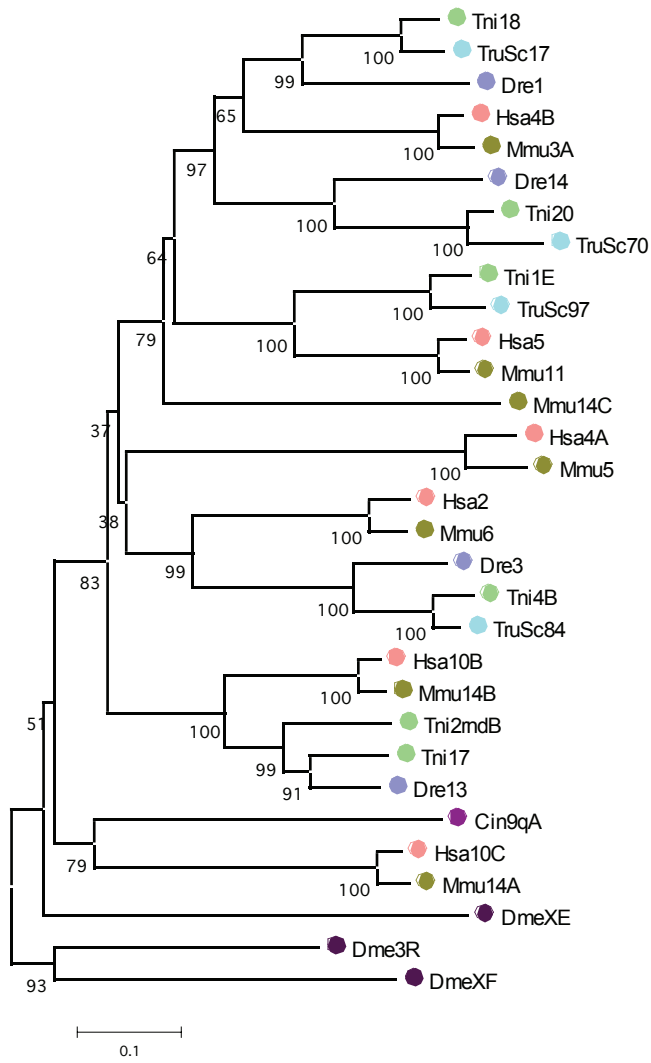

AP3

NJ

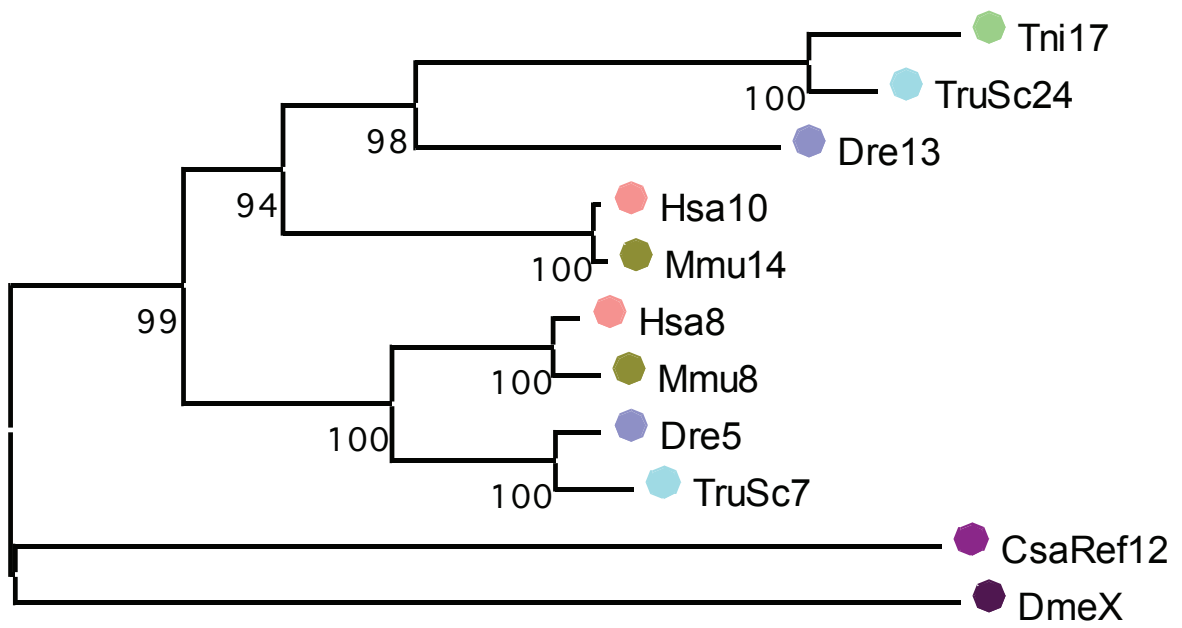

0.1

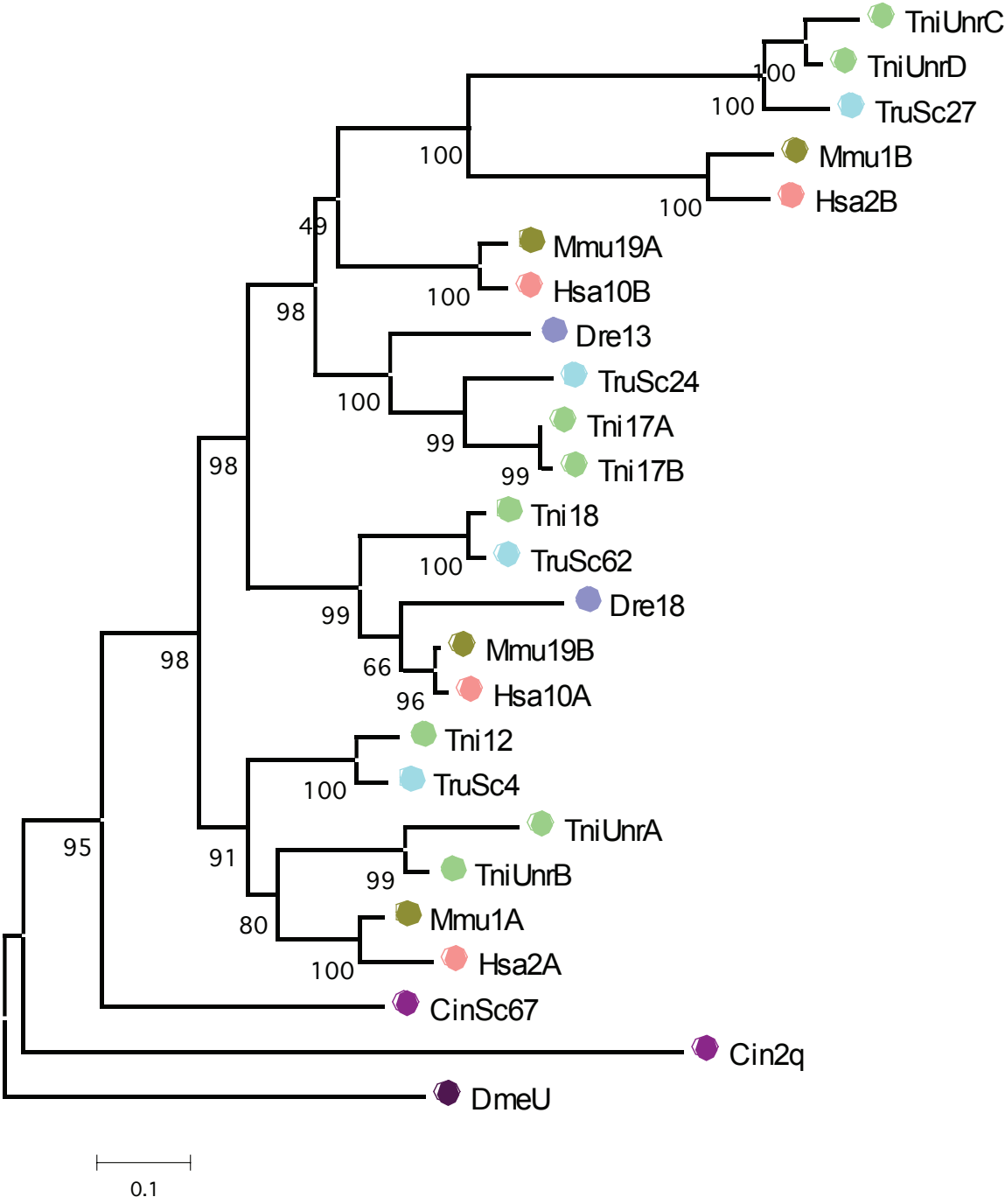

DUSP

NJ

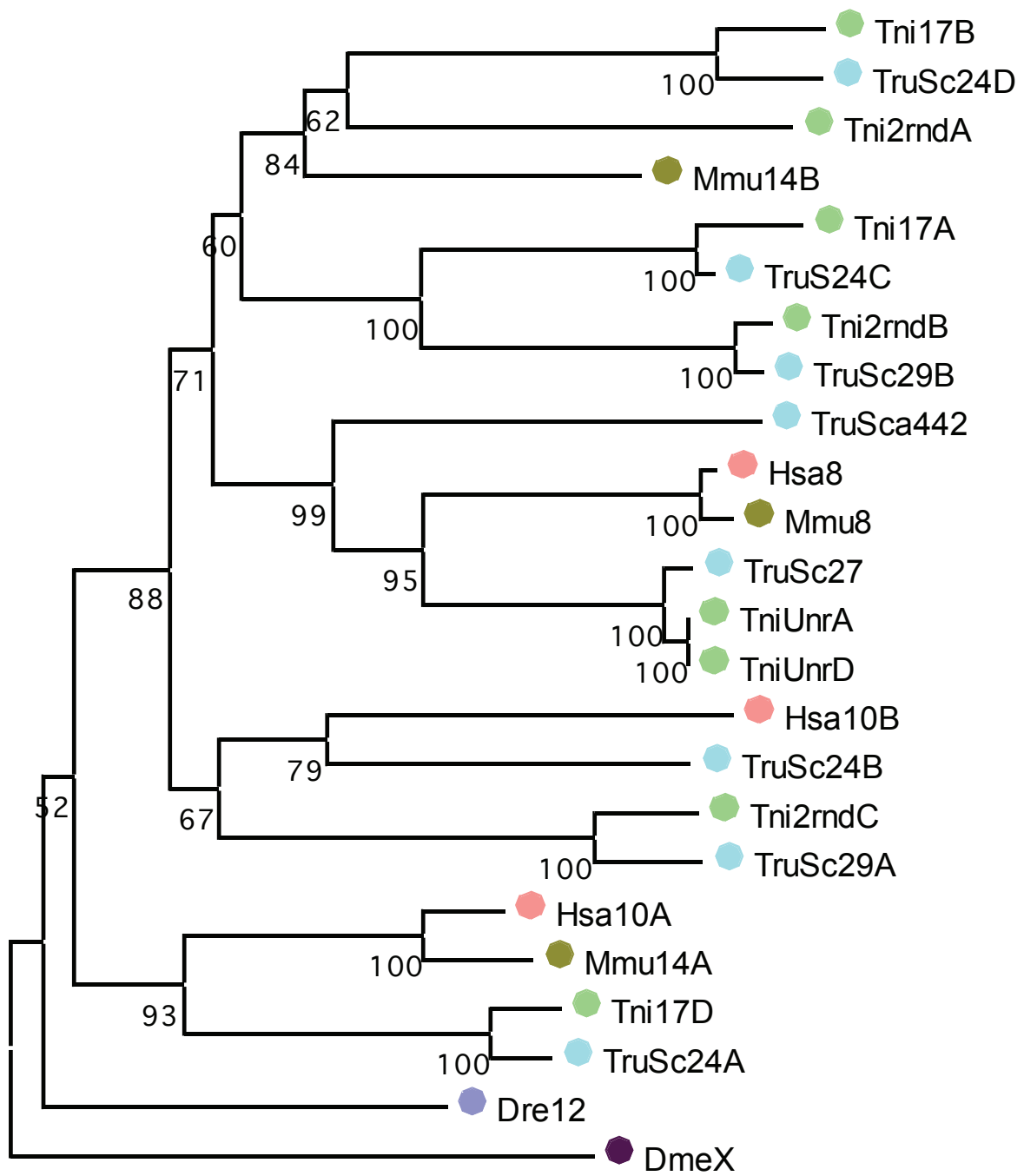

0.1

FGFR

NJ

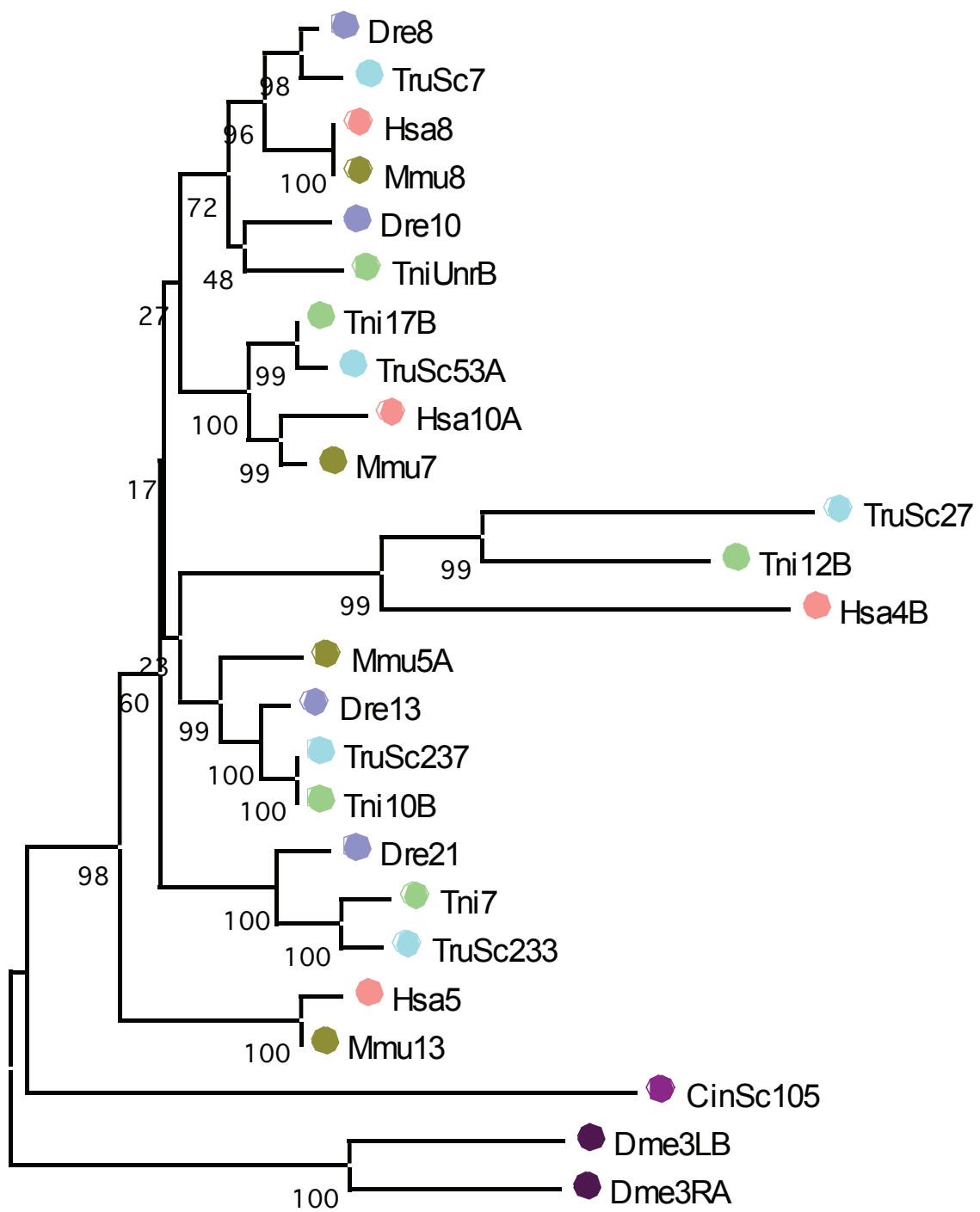

0.1



HNRP NJ

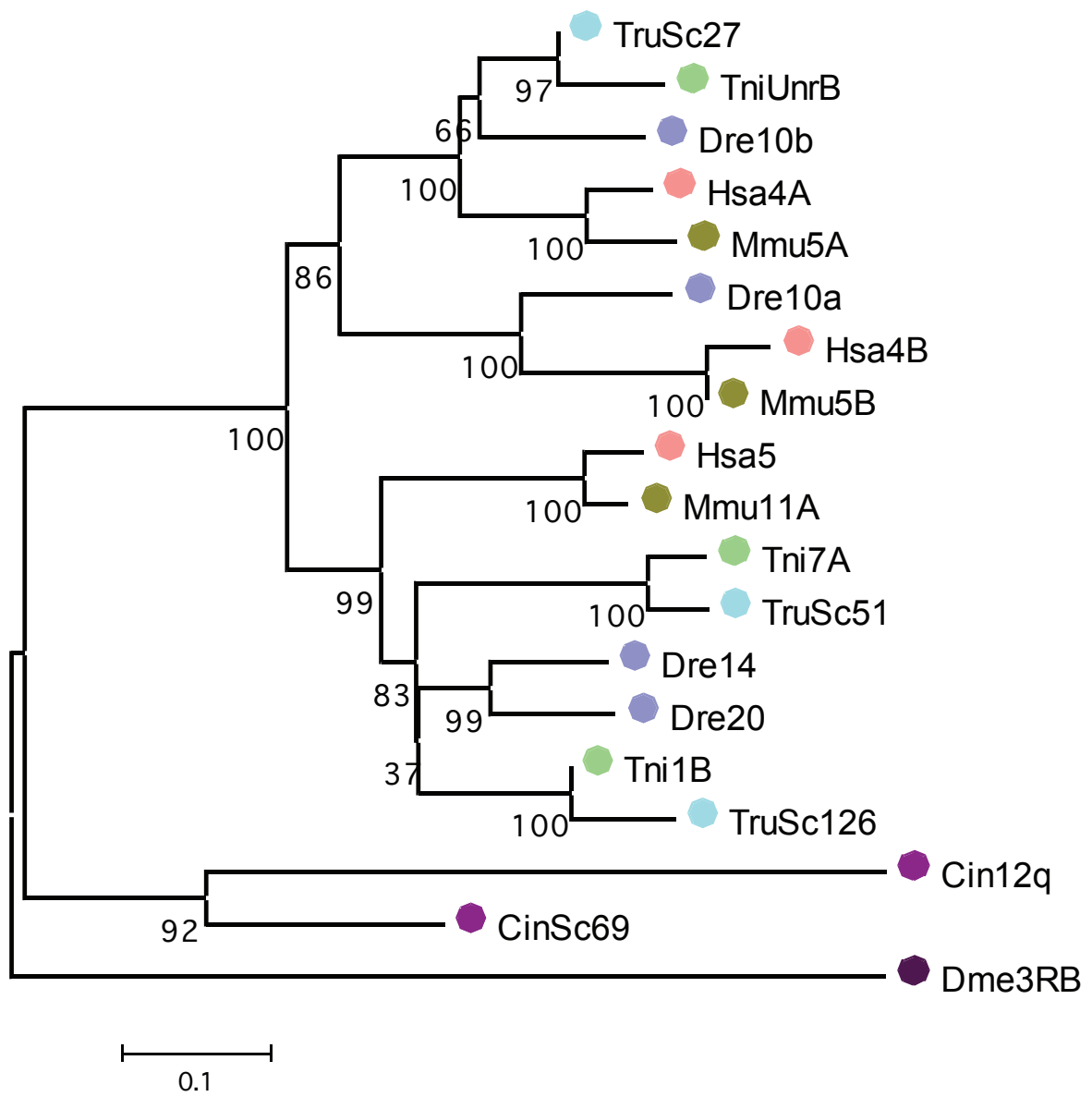

LGI

NJ

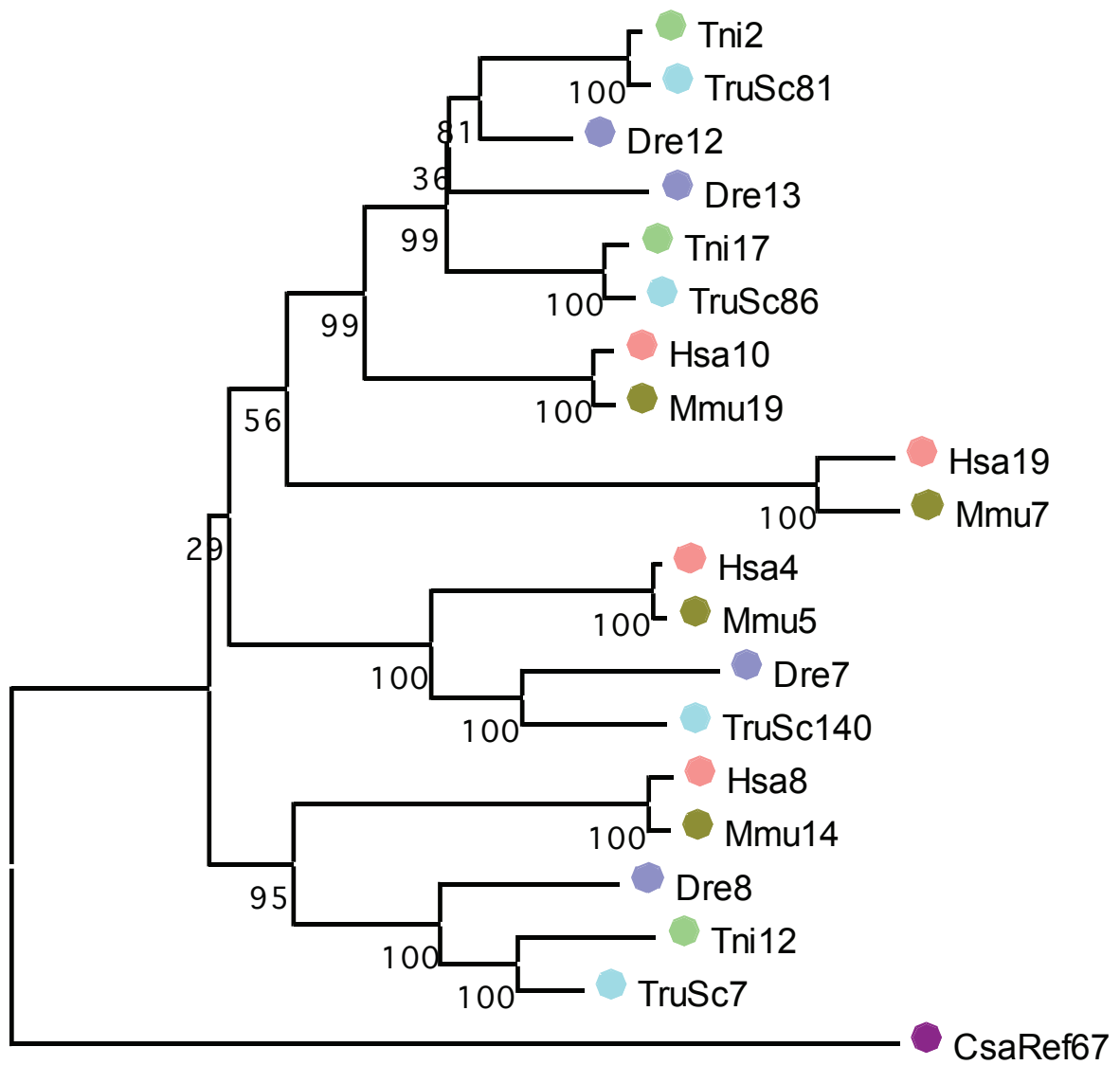

0.1

MAX

NJ

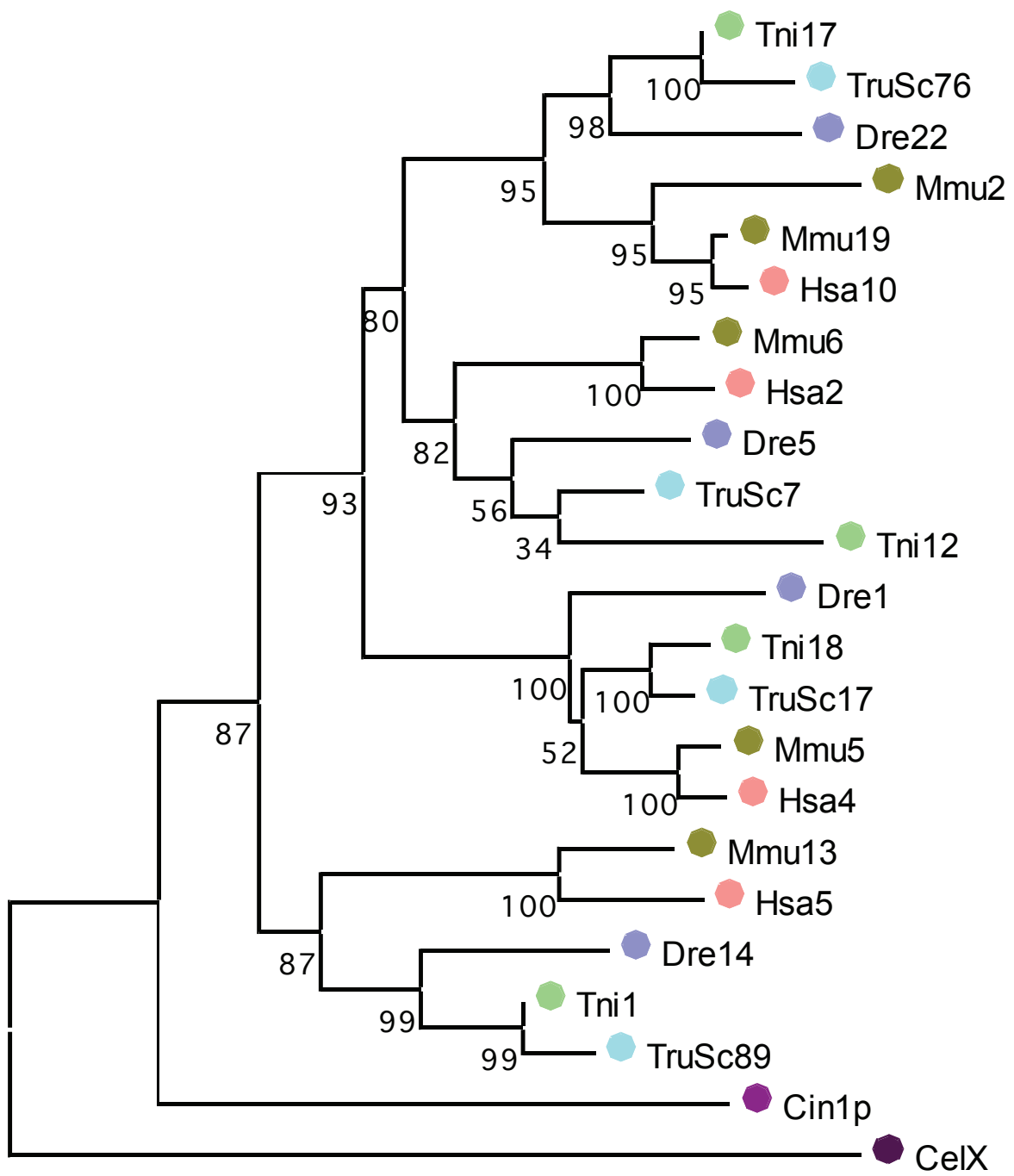

0.1

Mitogen NJ

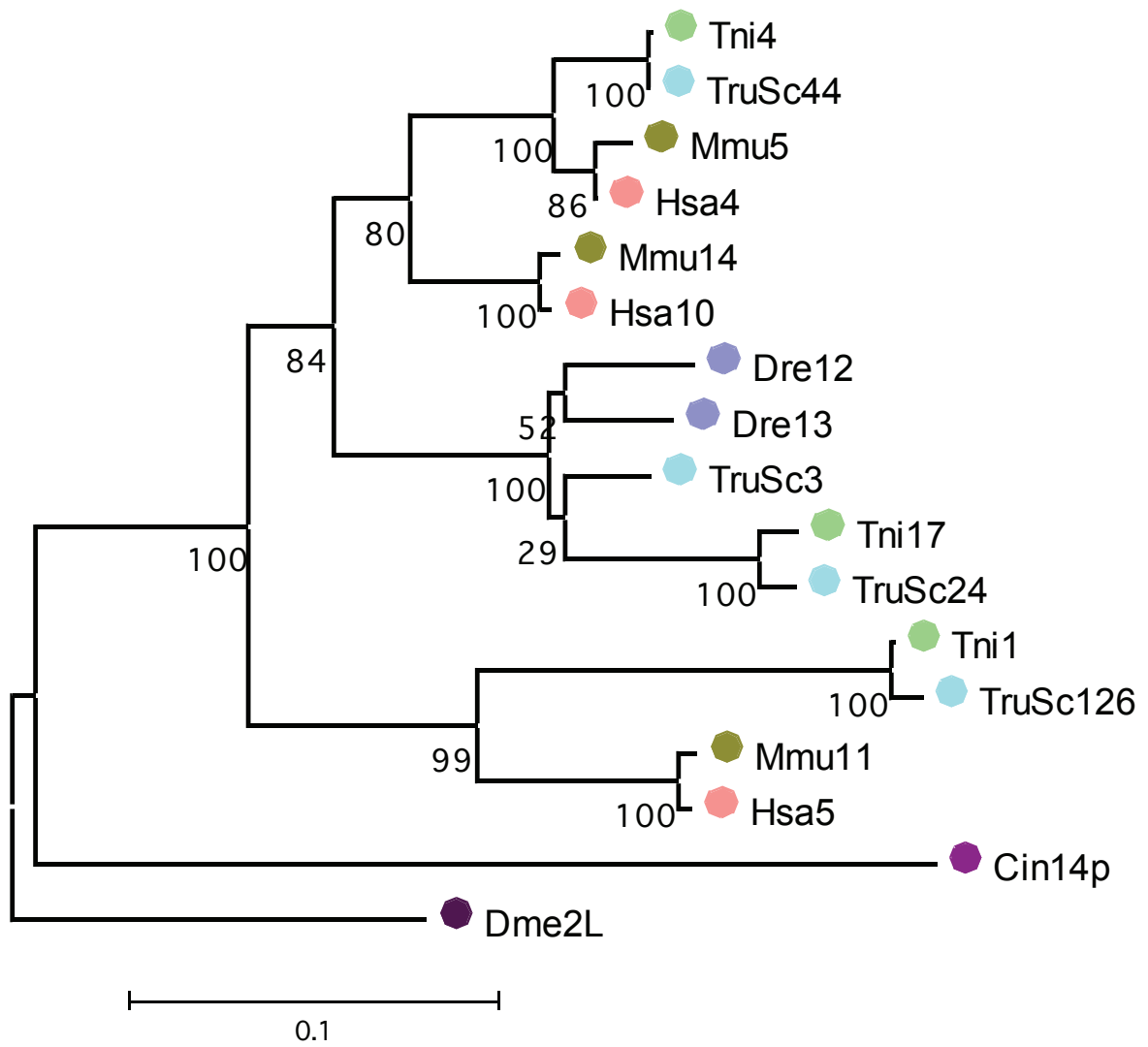

NEF

NJ

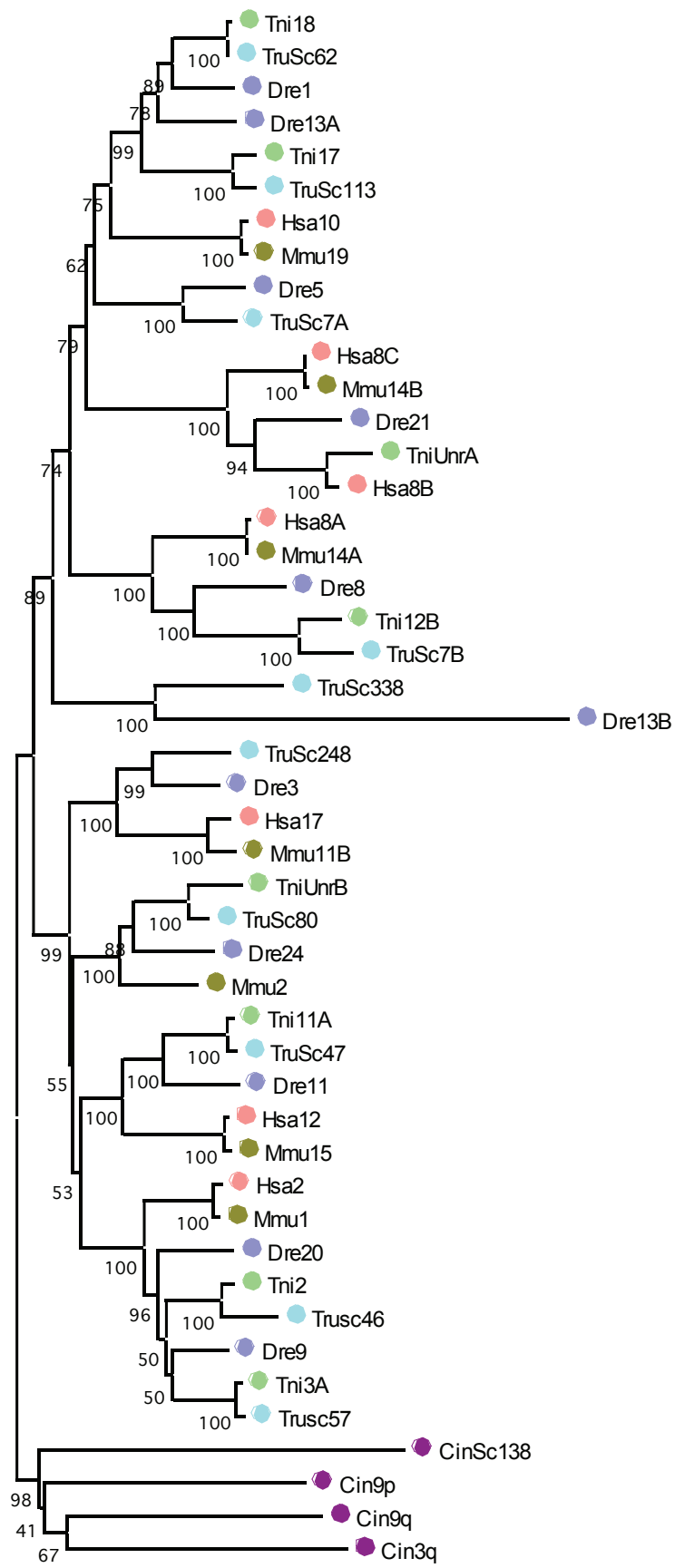

NKR

NJ

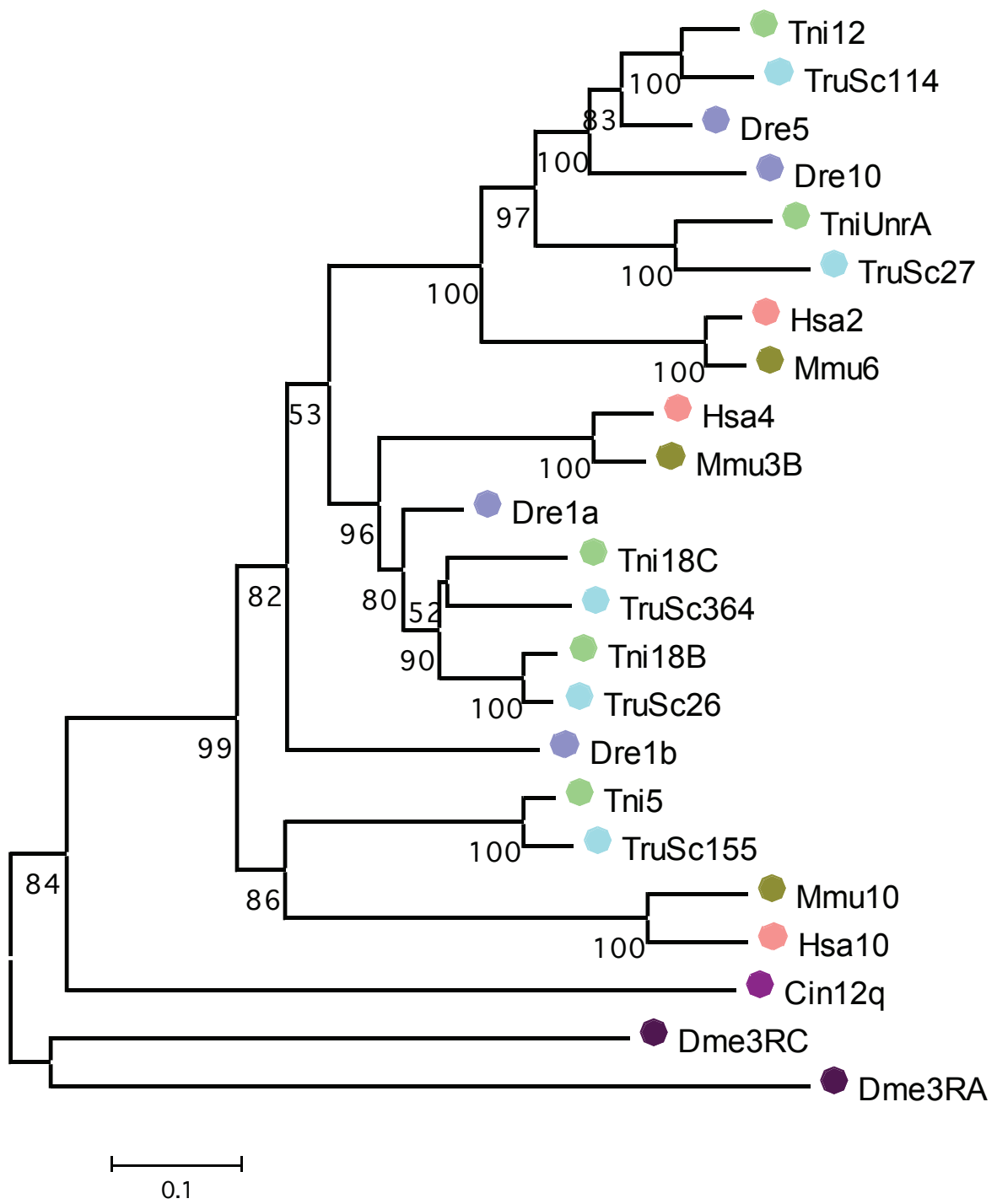

Oxoglut NJ

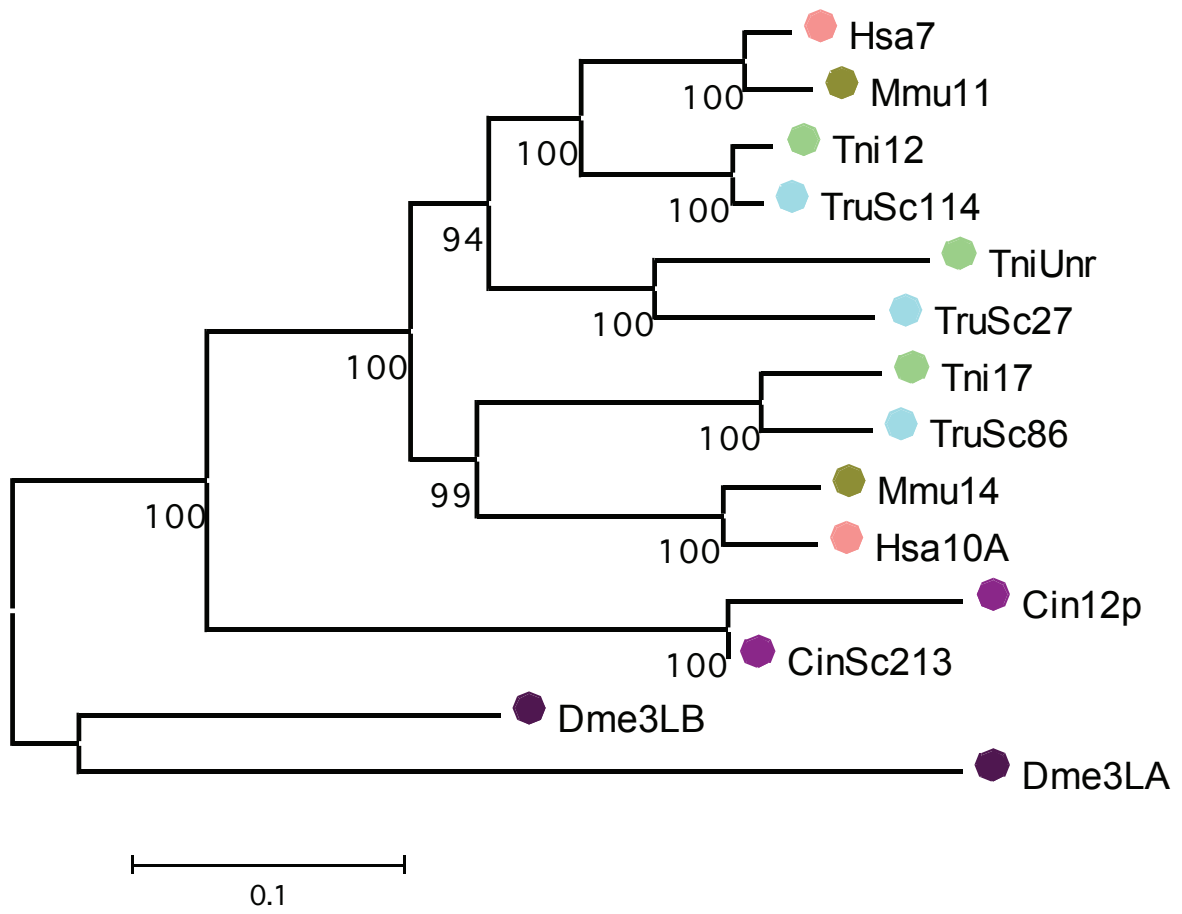

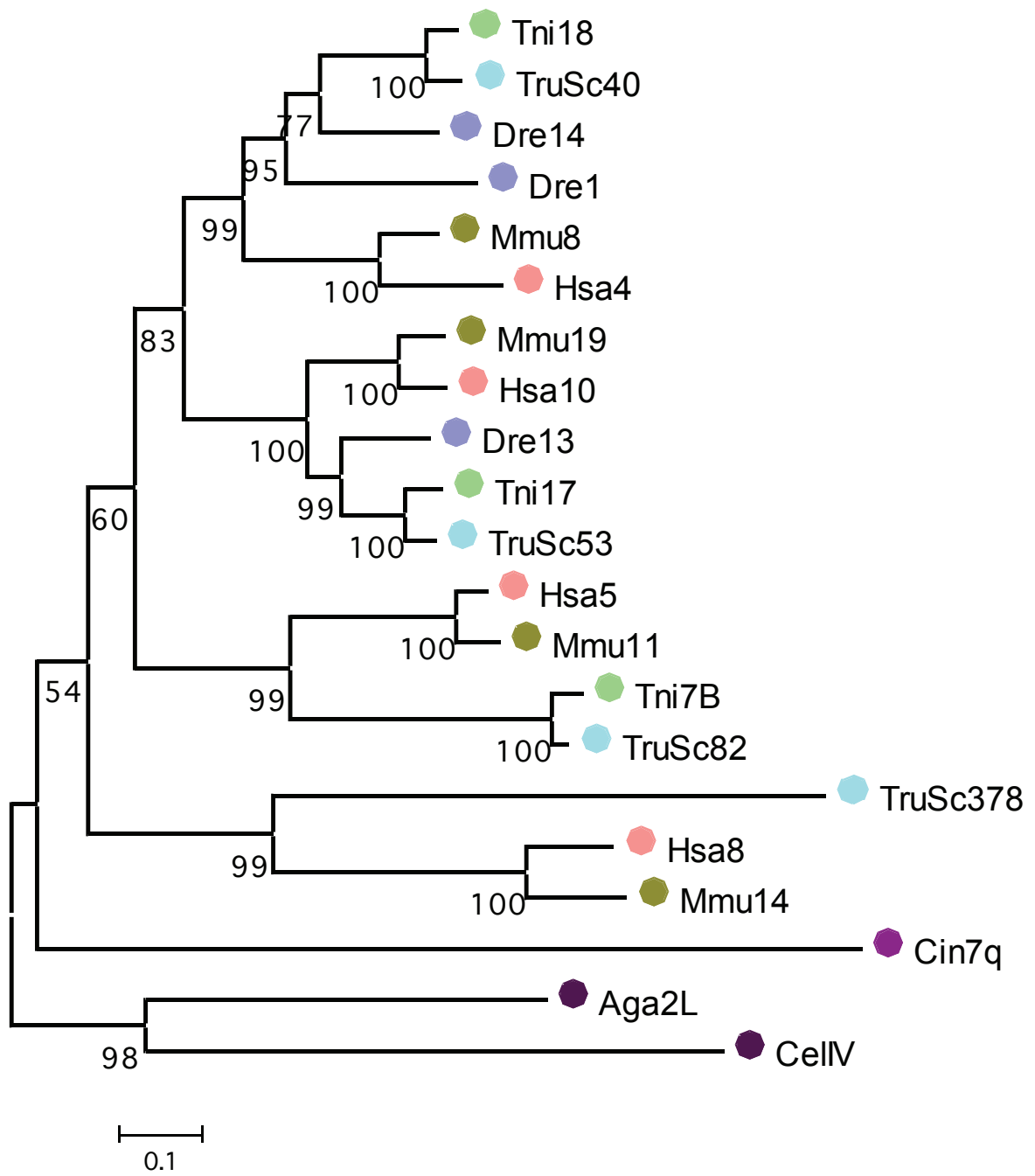



PX19

NJ

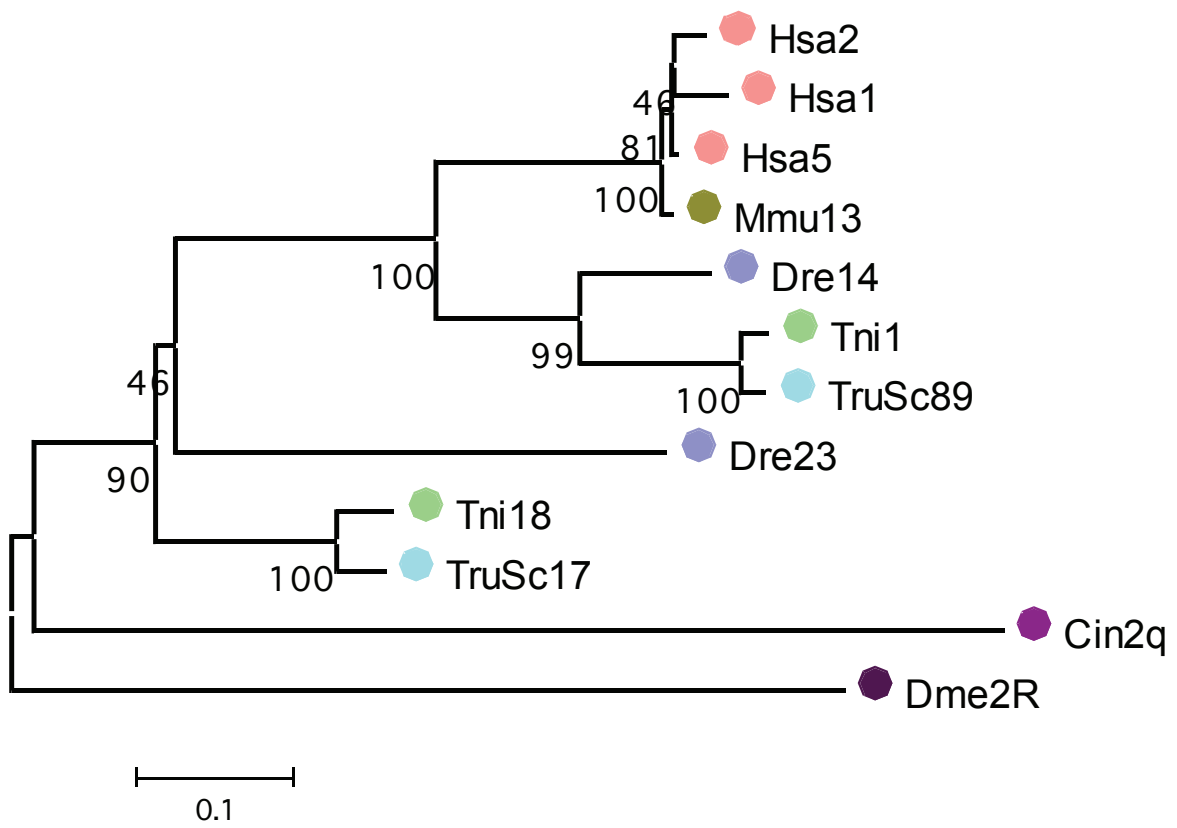

SAMD8 NJ

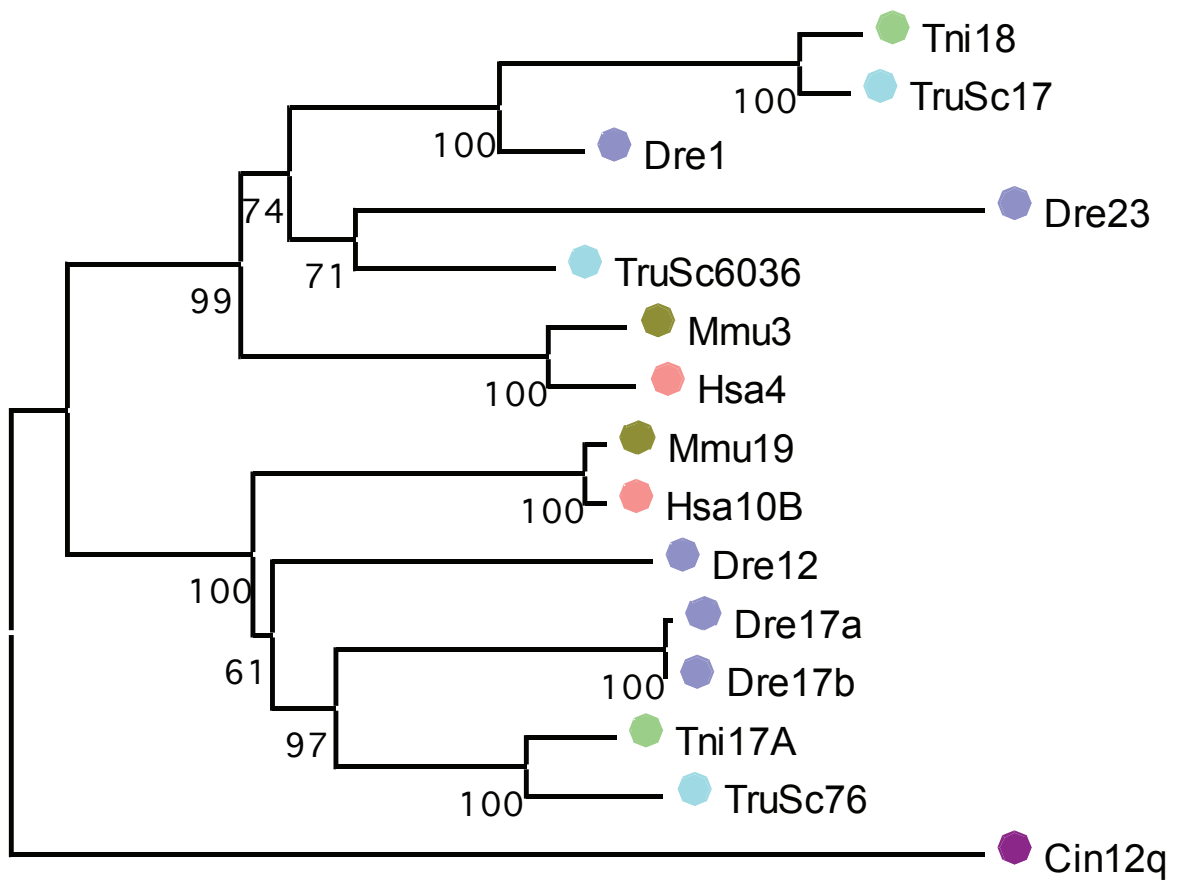

0.1

SAMD8Final2SUB2

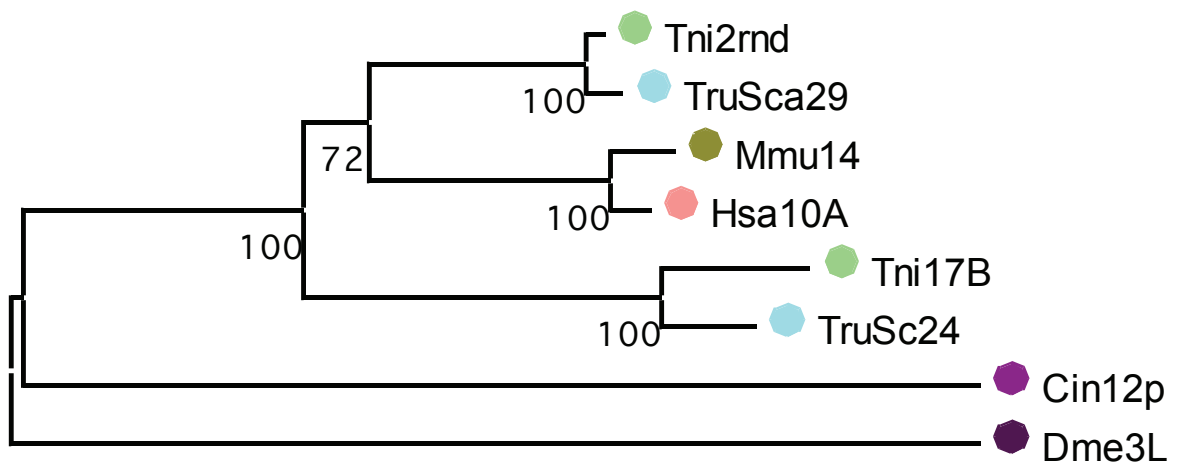

0.1

SFRP

NJ

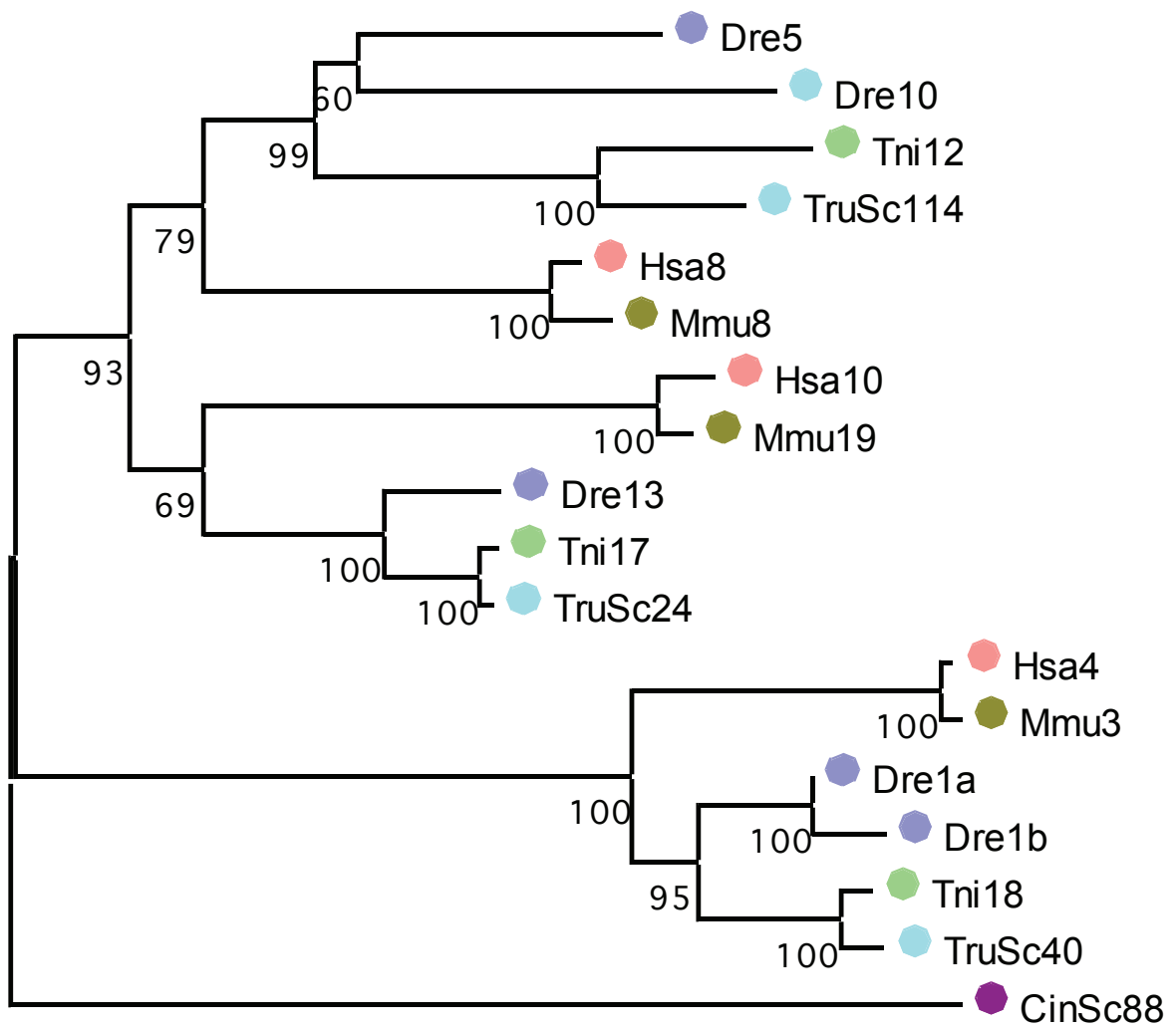

0.1

SORB

NJ

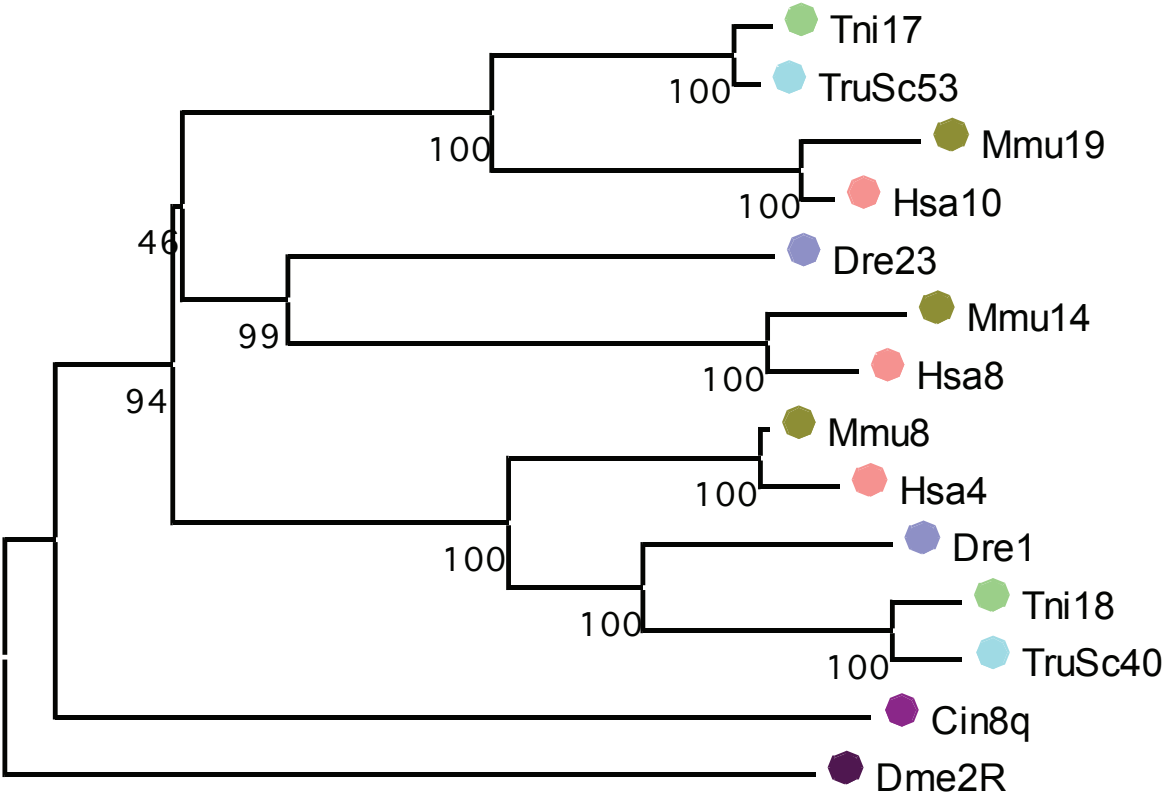

0.1

TIA

NJ

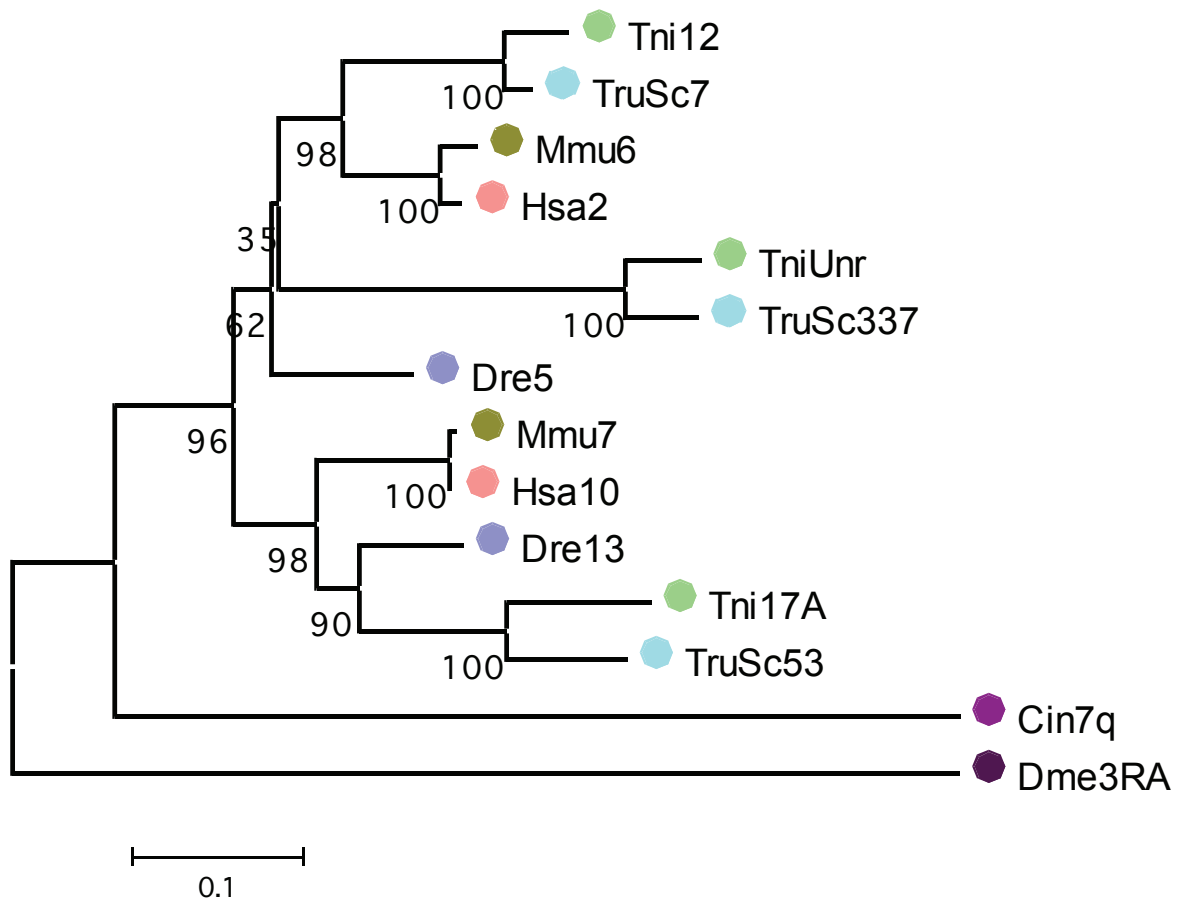

TSPAN NJ

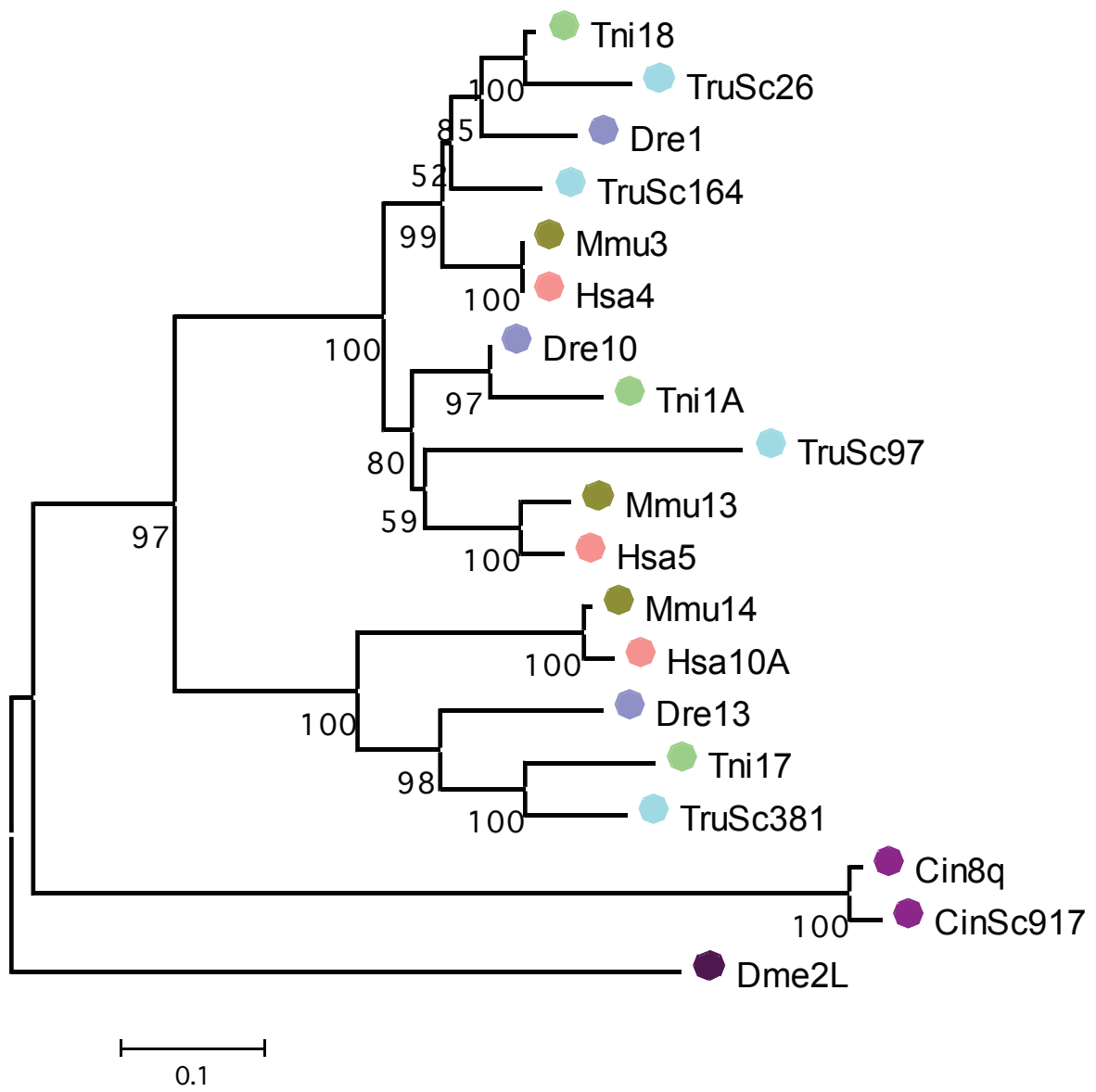

UNC5

NJ

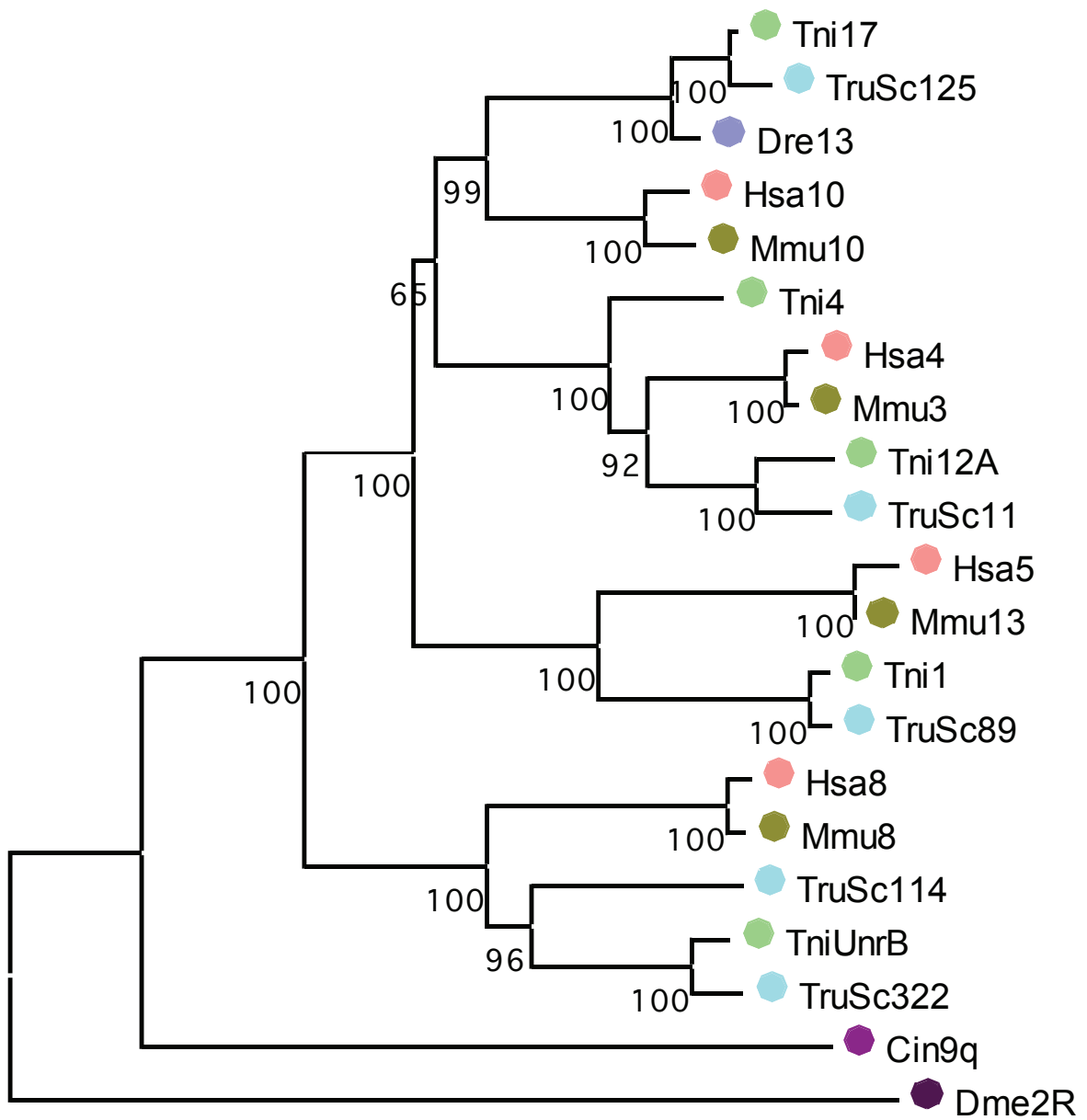

0.1

ZIMP

NJ

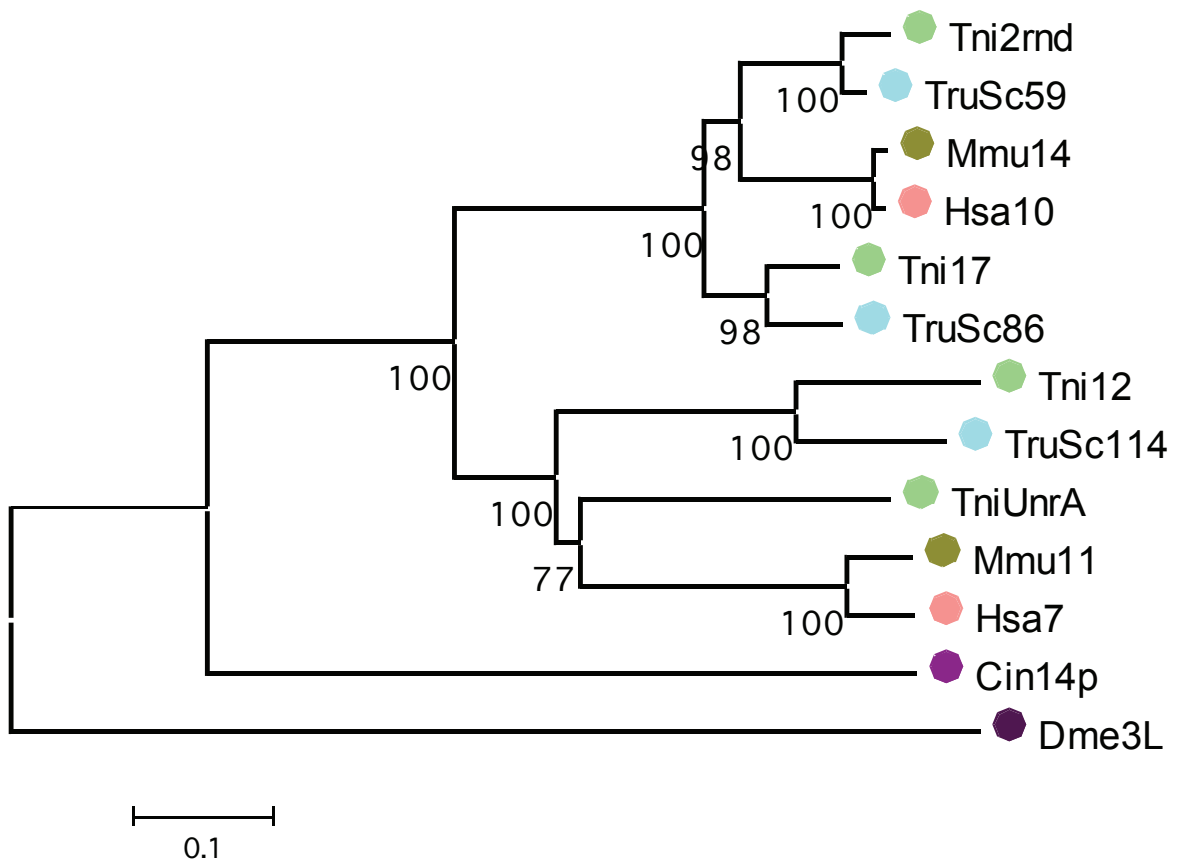



ZINK

NJ

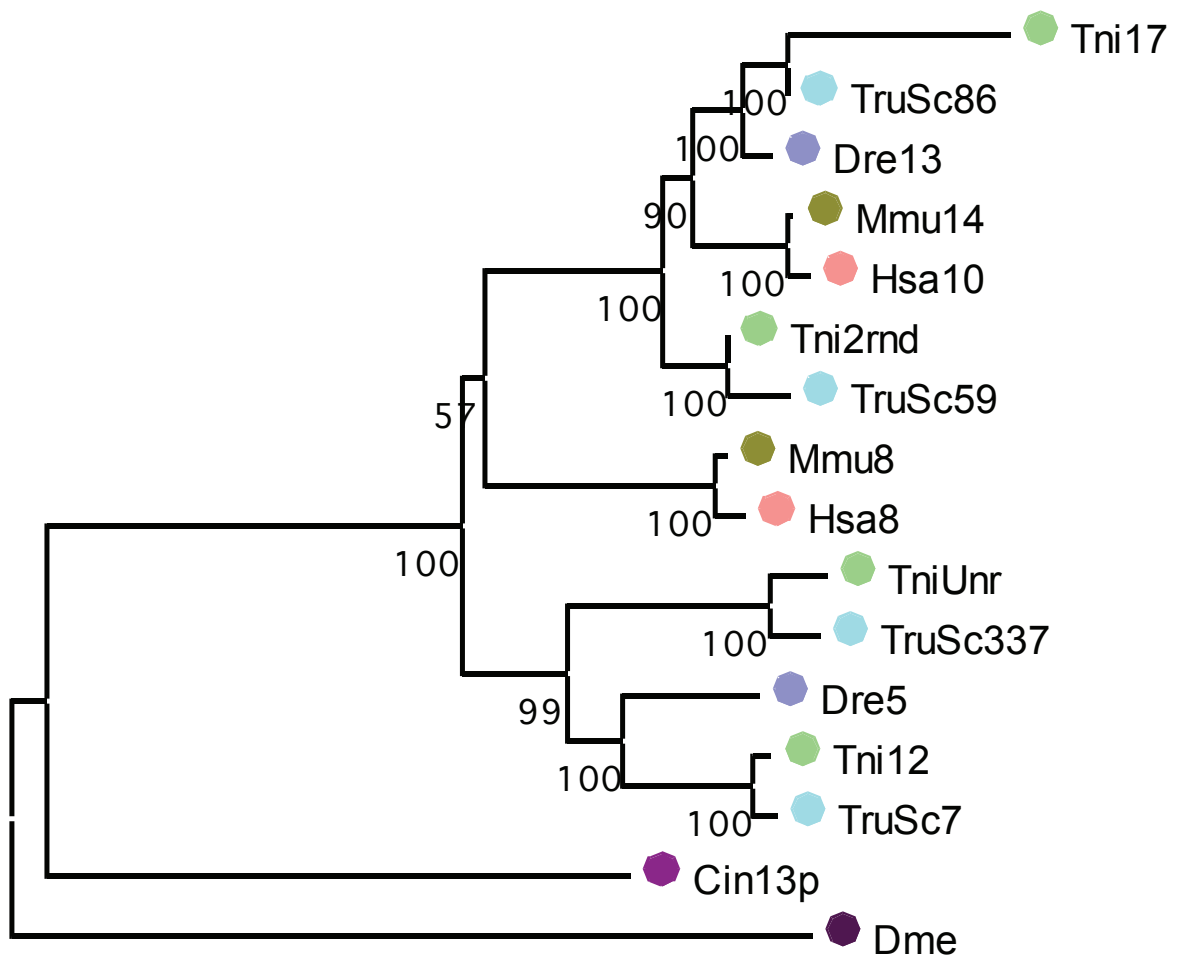

0.1