

# Resolution of the City of Jersey City, N.J.

City Clerk File No. Res. 18-960  
 Agenda No. 10.A  
 Approved: NOV 07 2018  
 TITLE:



## RESOLUTION AUTHORIZING CY 2018 APPROPRIATION TRANSFERS

**COUNCIL**  
 of the following resolution:

offered and moved adoption

**RESOLVED**, by the Municipal Council of the City of Jersey City that the Comptroller is hereby authorized to make the following CY 2018 budgetary appropriation transfers in accordance with N.J.S.A. 40A:4-58, two thirds of the full membership of the Municipal Council concurring:

Description	Account Number	From	To
EMPL GROUP HEALTH INS	01-201-23-220-307	\$70,000	
MATCHING FUNDS FOR GRANTS	01-201-41-899 O/E		\$70,000
<b>TOTAL:</b>		<b>\$70,000</b>	<b>\$70,000</b>

APPROVED: [Signature]  
 APPROVED: [Signature]  
 Business Administrator

APPROVED AS TO LEGAL FORM  
[Signature]  
 Corporation Counsel

Certification Required   
 Not Required  **APPROVED 8-0**

RECORD OF COUNCIL VOTE ON FINAL PASSAGE 11.7.18											
COUNCILPERSON	AYE	NAY	N.V.	COUNCILPERSON	AYE	NAY	N.V.	COUNCILPERSON	AYE	NAY	N.V.
RIDLEY	✓			YUN	✓			RIVERA	✓		
PRINZ-AREY	✓			SOLOMON	✓			WATTERMAN	ABSENT		
BOGGIANO	✓			ROBINSON	✓			LAVARRO, PRES.	✓		

✓ Indicates Vote

N.V.-Not Voting (Abstain)

Adopted at a meeting of the Municipal Council of the City of Jersey City N.J.

[Signature]  
 Rolando R. Lavarro, Jr., President of Council

[Signature]  
 Robert Byrne, City Clerk

**RESOLUTION FACT SHEET – NON-CONTRACTUAL**

This summary sheet is to be attached to the front of any resolution that is submitted for Council consideration. Incomplete or vague fact sheets will be returned with the resolution.

**Full Title of Ordinance/Resolution**

RESOLUTION AUTHORIZING CY 2018 APPROPRIATION TRANSFERS

**Initiator**

Department/Division	ADMINISTRATION	BUDGET
Name/Title	ROZANI	(EC)
Phone/email	201-547-4964	PELCR@JCNJ.ORG

Note: Initiator must be available by phone during agenda meeting (Wednesday prior to council meeting @ 4:00 p.m.)

**Resolution Purpose**

INCREASE MATCHING FUNDS FOR GRANTS ACCOUNTS BY \$70,000.00  
(ACCOUNT 01-201-41-899 FROM \$46,524. TO \$110,524.)

I certify that all the facts presented herein are accurate.

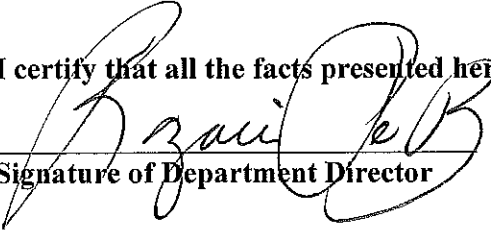
  
Signature of Department Director

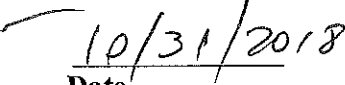
  
Date

# Resolution of the City of Jersey City, N.J.

City Clerk File No. Res. 18-961

Agenda No. 10.B

Approved: NOV 07 2018

TITLE:



**RESOLUTION OF THE CITY OF JERSEY CITY PROVIDING FOR AN ISSUE OF GENERAL IMPROVEMENT BONDS, AUTHORIZING THE SALE OF \$9,447,000 PRINCIPAL AMOUNT OF GENERAL IMPROVEMENT BONDS, SERIES 2018, AUTHORIZING ADVERTISEMENT OF A NOTICE OF SALE; AUTHORIZING THE CHIEF FINANCIAL OFFICER TO SELL AND AWARD THE BONDS; DETERMINING THE FORM AND OTHER DETAILS OF THE BONDS; AND AUTHORIZING OTHER MATTERS RELATING THERETO AND TO CERTAIN NOTES OF THE CITY.**

WHEREAS, the City of Jersey City, in the County of Hudson, New Jersey (the "City") has adopted the bond ordinances listed on the attached Appendix A (collectively, the "Bond Ordinances") authorizing the issuance of obligations of the City for the purpose of financing the general improvements described in the Bond Ordinances; and

WHEREAS, the Municipal Council has determined to finance permanently a portion of the cost of the general improvement projects undertaken pursuant to the Bond Ordinances by the issuance of \$9,447,000 principal amount of general improvement bonds, unless adjusted pursuant to Section 9 hereof, of the City, and

WHEREAS, the Municipal Council has determined to proceed with the public sale of said bonds for the purposes authorized in the Bond Ordinances; and

WHEREAS, the Municipal Council has previously adopted bond ordinances and special emergency ordinances (collectively, the "Note Ordinances") which authorized the issuance of bond anticipation notes and special emergency notes; and

WHEREAS, the City intends to issue its bond anticipation notes and special emergency notes (collectively, the "Notes") under the Note Ordinances for the purpose of (i) paying a portion of the maturing principal of the City's \$9,700,000 Special Emergency Notes, Series 2017C (Federally Taxable) which were issued on December 7, 2017 and are payable on December 7, 2018; (ii) financing the payment of contractually required severance liabilities resulting from the layoff or retirement of City employees; (iii) paying a portion of the maturing principal of the City's \$4,000,000 Special Emergency Notes, Series 2017D which were issued on December 7, 2017 and mature on December 7, 2018; (iv) paying a portion of the maturing principal of the City's \$7,980,000 Bond Anticipation Notes, Series 2017E which were issued on December 7, 2017 and are payable on December 7, 2018; (v) financing a portion of certain costs relating to a redevelopment project of the Jersey City Redevelopment Agency known as the Bayfront Redevelopment Project, including the purchase of real property, the demolition of certain structures located thereon and the construction of certain infrastructure improvements; and (vi) paying a portion of the maturing principal of the City's \$17,734,000 Bond Anticipation Notes, Series 2018A which were issued on January 18, 2018 and are payable on January 18, 2019; and

WHEREAS, all matters pertaining to the sale of the Notes have been delegated by the Note Ordinances to the Chief Financial Officer of the City.

NOW, THEREFORE, BE IT RESOLVED by the Municipal Council of the City of Jersey City, in the County of Hudson, New Jersey, as follows:

**Section 1.** General Improvement Bonds, Series 2018, Authorization of Sale. The principal amount of general improvement bonds authorized to be issued pursuant to the Bond Ordinances described in Appendix A hereto shall be issued as "General Improvement Bonds, Series 2018", in the aggregate principal amount of \$9,447,000 unless adjusted pursuant to

Continuation of Resolution \_\_\_\_\_  
 City Clerk File No. Res. 18-961  
 Agenda No. 10.B NOV 07 2018

## TITLE:

Section 9 hereof (the "Bonds"), and are authorized to be sold in accordance with the terms of this Resolution.

The average period of usefulness for the general improvements financed by the Series A Bonds is 33.35361 years.

**Section 2. Public Sale of Bonds.** The Bonds shall be issued and sold at a public sale upon electronic bids, in accordance with Section 8 hereof and the provisions of the Local Bond Law, constituting Chapter 169 of the Laws of 1960 of the State of New Jersey, as amended and supplemented.

**Section 3. Description of the Bonds.** The Bonds shall be dated the date of delivery, shall be in book-entry only form, shall bear interest at the rate or rates specified by the successful bidder therefor in accordance with the Notice of Sale hereinafter provided for, said interest to be payable on June 1 and December 1, commencing on June 1, 2019 and shall mature on December 1 in the following years and amounts:

## GENERAL IMPROVEMENT BONDS, SERIES 2018

<u>Year</u>	<u>Principal Amount</u>
2019	\$360,000
2020	365,000
2021	370,000
2022	380,000
2023	390,000
2024	400,000
2025	415,000
2026	425,000
2027	440,000
2028	450,000
2029	465,000
2030	480,000
2031	500,000
2032	515,000
2033	530,000
2034	550,000
2035	570,000
2036	590,000
2037	615,000
2038	637,000

The Bonds shall contain such other terms and conditions as are specified in the Notice of Sale, approved in Section 5 hereof (the "Notice of Sale"), and in the form of the Bonds, approved in Section 12 hereof.

**Section 4 Redemption.**

(A) The Bonds maturing prior to December 1, 2026 are not subject to redemption prior to their stated maturity. The Bonds maturing on or after December 1, 2026 are subject to redemption, at the option of the City, prior to their stated maturity and upon notice as hereinafter provided, at any time on or after December 1, 2025, in whole or part from such maturities as the City shall determine and by lot within a single maturity, at the redemption price of 100% of the principal amount to be redeemed together with unpaid interest accrued to the redemption date.

(B) In the event the winning bidder elects to aggregate consecutive principal maturities of the Bonds into one or more term bonds, then each such term bond shall be subject to mandatory sinking fund redemption prior to maturity, in part, on the dates and in the amounts specified in the Notice of Sale for such aggregated consecutive principal maturities (other than the final such maturity), at a redemption price equal to 100% of the principal amount to be redeemed, plus accrued interest thereon to the date fixed for redemption.

## TITLE:

(C) Any Bond subject to redemption as aforesaid may be called in part, provided that the portion not called for redemption shall be in the principal amount of \$1,000 or any integral multiple thereof. If less than all of the Bonds of a particular series and maturity are to be redeemed, Bonds of that series and maturity shall be selected by the Chief Financial Officer (or, if appointed pursuant to Section 15 hereof, the Paying Agent) by lot.

When any Bonds are to be redeemed, the Chief Financial Officer (or, if appointed by Section 15 hereof, the Paying Agent) shall give notice of the redemption of the Bonds by mailing the notice of redemption by first class mail in a sealed envelope postage prepaid, to the registered owners of any Bonds or portions thereof which are to be redeemed, at their respective addresses as they last appear on the registration books of the City. Such mailing shall not be a condition precedent to such redemption, and failure to so mail or to receive any such notice to any of such registered owners shall not affect the validity of the proceedings for the redemption of the Bonds. Notice of redemption having been given as aforesaid, the Bonds, or portions thereof so to be redeemed, shall, on the date fixed for redemption, become due and payable at the redemption price specified therein plus accrued interest to the redemption date and, upon presentation and surrender thereof at the place specified in such notice, such Bonds, or portions thereof, shall be paid at the redemption price, plus accrued interest to the redemption date. On and after the redemption date (unless the City shall default in the payment of the redemption price and accrued interest), such Bonds shall no longer be considered as outstanding.

During any period in which The Depository Trust Company (or any successor thereto) shall act as securities depository for the Bonds of any series, the notices referred to above shall be given only to such depository and not to the beneficial owners of the Bonds of such series. Any failure of such depository to advise any of its participants or any failure of any participant to notify any beneficial owner of any notice of redemption shall not affect the validity of the redemption proceedings.

**Section 5.** Approval of Notice of Sale. The Notice of Sale containing other terms and provisions of the Bonds and setting forth the conditions of the sale thereof, all of which are hereby approved, shall be substantially in the form attached to this Resolution as Appendix B and made a part hereof.

**Section 6.** Approval of Summary Notice of Sale. The Summary Notice of Sale containing other terms and provisions of the Bonds and setting forth the conditions of the sale thereof, all of which are hereby approved, shall be substantially in the form attached to this Resolution as Appendix C made a part hereof.

**Section 7.** Publication of Notice of Sale and Summary Notice of Sale. The Notice of Sale substantially in the form attached to this Resolution shall be published at least once in The Jersey Journal, a newspaper circulating in the City, and the Summary Notice of Sale substantially in the form attached to this Resolution shall be published at least once in The Bond Buyer, and/or such other nationally recognized local government bond marketing publication or electronic information service carrying municipal bond notices and devoted primarily to the subject of state and municipal bonds. The advertisement of said Notice of Sale and Summary Notice of Sale in each such medium shall be published not less than seven (7) days prior to the sale date for the Bonds. The City Clerk, the Chief Financial Officer and such other appropriate officials are hereby authorized and directed to publish the Notice of Sale and Summary Notice of Sale as aforesaid.

**Section 8.** Designation of Chief Financial Officer to Award Bonds. Electronic proposals for the purchase of the Bonds shall be received by the Chief Financial Officer on such date as shall be determined by the Chief Financial Officer and set forth in the Notice of Sale and the Summary Notice of Sale, or such later date as may be established by the Chief Financial Officer in accordance with Section 10 hereof. Electronic proposals will be received through the "PARITY Electronic Bid System" (PARITY) in accordance with the terms and conditions set forth in the Notice of Sale authorized herein. Such proposals shall be received and announced in accordance with the Notice of Sale authorized herein. The Municipal Council hereby designates the Chief Financial Officer to sell and award the Bonds in accordance with this Resolution and the Notice of Sale. The Chief Financial Officer is hereby directed to report, in writing, to the

## TITLE:

City at its first meeting after the sale of the Bonds as to the principal amount, interest rate and maturities of the Bonds sold, the price obtained and the name of the purchaser.

**Section 9. Adjustment to Maturity Schedule.** The City may and expects to, after the receipt and opening of bids, adjust the maturity schedule of the Bonds to adjust the amount of bonds to the amount needed by the City, provided however, that (i) no maturity schedule adjustment shall exceed 10% upward or downward of the principal for any maturity as specified herein, and (ii) the aggregate adjustment to the maturity schedule shall not exceed 10% upward or downward of the aggregate principal amount of bonds as specified herein and as adjusted will not exceed the amount authorized by the Ordinances. The dollar amount bid by the successful bidder shall be adjusted to reflect any adjustments in the aggregate principal amount of bonds to be issued. The adjusted bid price will reflect changes in the dollar amount of the underwriter's discount and the original issue premium or discount, but will not change the per bond underwriter's discount as calculated from the bid and the Initial Public Offering Prices required to be delivered to the City as stated herein. The City shall notify the successful bidder of the final maturity schedule and the resulting adjusted purchase price no later than 5:00 p.m., New Jersey time, on the day of the sale and award of the Bonds. The interest rate or rates specified by the successful bidder for each maturity will not be altered.

**Section 10. Postponement of Sale.** The Chief Financial Officer is hereby delegated the authority (if the Chief Financial Officer deems it to be in the best interests of the City) (i) to postpone from time to time the sale of the Bonds from the date specified in the Notice of Sale (or, in the case of a rescheduled sale, from such rescheduled date), in each case upon not less than 24 hours' notice (to the extent practicable), and (ii) to reschedule such sale upon not less than 48 hours' notice. Notice of any such postponement and rescheduling shall be given in the manner specified in the Notice of Sale. In the event of any such postponement and rescheduling, the Chief Financial Officer may (and shall, if required by the Local Bond Law) cause a revised Notice of Sale and a revised Summary Notice of Sale to be prepared and published.

**Section 11. Authorization for Official Statement.** The distribution by the City and its municipal advisor of the Preliminary Official Statement relating to the Bonds and the Notes (a draft of which is attached hereto as Exhibit A and shall be filed with the records of the City) is hereby approved in substantially such form, with such insertions, deletions and changes therein and any supplements thereto as bond counsel may advise and the City officer executing the same may approve, such approval to be evidenced by such City officer's execution thereof. The Chief Financial Officer is hereby authorized to deem the Preliminary Official Statement "final" within the meaning of Rule 15c2-12 of the Rules of the Securities and Exchange Commission and to execute and deliver a certificate to that effect. The Chief Financial Officer is hereby authorized to approve the contents and terms of the final Official Statement in respect of the Bonds and the Notes in substantially the form of the Preliminary Official Statement. The Chief Financial Officer is hereby authorized to sign such Official Statement on behalf of the City, in substantially such form, with such insertions, deletions and changes therein and any supplements thereto as bond counsel may advise and the City officer executing the same may approve, such approval to be evidenced by such City officer's execution thereof.

**Section 12. Term Bond Option.** As provided in the Notice of Sale, bidders may aggregate consecutive principal maturities of the Bonds for which such bidder bid the same interest rate into one or more term bonds. The Chief Financial Officer is hereby delegated the authority (if the Chief Financial Officer deems it to be in the best interests of the City) to include such option in any revised Notice of Sale prepared pursuant to Section 9 hereof. In the event the winning bidder elects such option, the provisions of Section 4 (B) hereof shall be applicable thereto, and the Paying Agent appointed under Section 15 hereof shall, from time to time and, without further direction by the City, give all notices of mandatory sinking fund redemption as may be required under Section 4 hereof in connection therewith.

**Section 13. Approval of Form of Bonds.** The form of the Bonds, substantially as set forth in Appendix D attached hereto and made a part hereof, is hereby approved. The Bonds shall be executed in the name of the City by the manual or facsimile signature of the Mayor and the Chief Financial Officer and the seal of the City, or a facsimile impression thereof, shall be affixed to the Bonds and attested by the manual signature of the City Clerk.

City Clerk File No. Res. 18-961  
Agenda No. 10.B NOV 07 2018

TITLE:

**Section 14. Appointment of Securities Depository.** The Depository Trust Company ("DTC"), shall act as securities depository for the Bonds. The ownership of one fully registered bond for each maturity of Bonds, each in the aggregate principal amount of such maturity, will be registered in the name of Cede & Co., as nominee for DTC.

Pursuant to the book-entry only system, any person for whom a DTC Participant acquires an interest in the Bonds (the "Beneficial Owner") will not receive certificated Bonds and will not be the registered owner thereof. Ownership interests in the Bonds may be purchased by or through DTC Participants. Each DTC Participant will receive a credit balance in the records of DTC in the amount of such DTC Participant's interest in the Bonds, which will be confirmed in accordance with DTC's standard procedures. Receipt by the Beneficial Owners (through any DTC Participant) of timely payment of principal, premium, if any, and interest on the Bonds, is subject to DTC making such payment to DTC Participants and such DTC Participants making payment to Beneficial Owners. Neither the City nor the Paying Agent will have any direct responsibility or obligation to such DTC Participants or the persons for whom they act as nominees for any failure of DTC to act or make any payment with respect to the Bonds.

The appropriate officers of the City are hereby authorized to execute a Letter of Representation to DTC and such other documents as may be necessary or desirable in connection with DTC's services as securities depository.

DTC may determine to discontinue providing its services with respect to the Bonds at any time by giving notice to the City and discharging its responsibilities with respect thereto under applicable law. Under such circumstances, the City shall designate a successor securities depository or deliver certificates to the beneficial owners of the Bonds.

**Section 15. Appointment of Paying Agent and Bond Registrar.** The Chief Financial Officer is hereby delegated the authority to appoint any bank, trust company or national banking association having the power to accept and administer trusts to serve as Paying Agent and Bond Registrar for the Bonds. The Paying Agent and Bond Registrar shall signify its acceptance of the duties imposed upon it by this Resolution by a written certificate delivered to the City prior to the delivery of the Bonds.

**Section 16. Tax Covenant.** The City hereby covenants with the holders from time to time of the Bonds that it will make no investment or other use of the proceeds of such Bonds or take any further action (or refrain from taking such action) which would cause such Bonds to be "arbitrage bonds" within the meaning of the Internal Revenue Code of 1986, as amended, or under any similar statutory provision or any rule or regulation promulgated thereunder (the "Code"), or would cause interest on such Bonds not to be excludable from gross income for federal income tax purposes, and that it will comply with the requirements of the Code and said regulations throughout the term of such Bonds.

**Section 17. Pledge of City.** The full faith and credit of the City is hereby pledged for the payment of the principal, redemption premium, if any, and interest on the Bonds. The Bonds shall be direct obligations of the City, and the City shall be obligated to levy *ad valorem* taxes upon all the taxable real property within the City for the payment of the principal of and interest on the Bonds without limitation as to rate or amount.

**Section 18. Continuing Disclosure.** The form of the Continuing Disclosure Certificate for the Bonds (the "Bonds CDC") in substantially the form attached hereto as Appendix E-1, and the form of the Continuing Disclosure Certificate for the Notes (the "Notes CDC", and together with the Bonds CDC, the "Continuing Disclosure Certificates"), in substantially the form attached hereto as Appendix E-2, are each hereby approved, and the execution of the Continuing Disclosure Certificates by the Chief Financial Officer of the City is hereby authorized. The City hereby covenants and agrees that it will comply with and carry out all of the provisions of the Continuing Disclosure Certificates executed by the City and dated the date of issuance and delivery of the Bonds and the Notes, respectively, as originally executed and as they may be amended from time to time in accordance with the terms thereof. Notwithstanding any other provision of this Resolution, failure of the City to comply with the Continuing Disclosure

Continuation of Resolution \_\_\_\_\_

City Clerk File No. Res. 18-961

Agenda No. 10.B NOV 07 2018

TITLE:

Certificates shall not be considered a default on the Bonds and/or the Notes; however, any Bondholder or Noteholder may take such actions as may be necessary and appropriate, including seeking specific performance by court order, to cause the City to comply with its obligations under this Section.

**Section 19. Further Action.** The proper officers of the City are hereby authorized and directed to take all such action as may be necessary to affect the issuance and delivery of the Bonds.

**Section 20. Effective Date.** This Resolution shall take effect immediately.

APPROVED: *Donna Hayes, CFO*

APPROVED AS TO LEGAL FORM  
*[Signature]*  
Corporation Counsel

APPROVED: *[Signature]*  
Business Administrator

Certification Required

Not Required

APPROVED 8-0

*JMcK*  
*10/31/18*

RECORD OF COUNCIL VOTE ON FINAL PASSAGE 11 7 18											
COUNCILPERSON	AYE	NAY	N.V.	COUNCILPERSON	AYE	NAY	N.V.	COUNCILPERSON	AYE	NAY	N.V.
RIDLEY	✓			YUN	✓			RIVERA	✓		
PRINZ-AREY	✓			SOLOMON	✓			WATTERMAN	ABSENT		
BOGGIANO	✓			ROBINSON	✓			LAVARRO, PRES	✓		

✓ Indicates Vote

N.V.-Not Voting (Abstain)

Adopted at a meeting of the Municipal Council of the City of Jersey City N.J.

*[Signature]*  
Rolando R. Lavarro, Jr., President of Council

*[Signature]*  
Robert Byrne, City Clerk



APPENDIX A

<u>Ordinance Number</u>	<u>Date Adopted</u>	<u>Amount of Bonds Authorized</u>	<u>Period of Usefulness (Years)</u>	<u>Bonds to be Issued</u>
09-097 and 09- 127	10/24/09 and 12/16/06	\$11,176,000	33.35361	\$9,447,000

**APPENDIX B**

**NOTICE OF SALE OF**

**CITY OF JERSEY CITY, IN THE COUNTY OF HUDSON, NEW JERSEY**

**\$9,447,000\* GENERAL IMPROVEMENT BONDS, SERIES 2018**

**(Book-Entry-Only) (Callable)**

ELECTRONIC PROPOSALS will be received and announced by the Chief Financial Officer of the City of Jersey City, a municipal corporation of the State of New Jersey located in the County of Hudson, New Jersey (the "City" or the "Issuer"), at 280 Grove Street, Jersey City, New Jersey, through the PARITY Electronic Bid System ("PARITY") of IPREO LLC, as described herein, on Tuesday, November 20, 2018 (unless postponed and rescheduled as provided herein) until 11:00 a.m., prevailing local time, in accordance with N.J.S.A. 40A:2-27, for the purchase of the following described bonds:

\$9,447,000\* General Improvement Bonds, Series 2018 maturing on December 1 in the years and in the amounts set forth below (the "Bonds"):

<u>Year</u>	<u>Principal Amount*</u>	<u>Year</u>	<u>Principal Amount*</u>
2019	\$360,000	2029	\$465,000
2020	365,000	2030	480,000
2021	370,000	2031	500,000
2022	380,000	2032	515,000
2023	390,000	2033	530,000
2024	400,000	2034	550,000
2025	415,000	2035	570,000
2026	425,000	2036	590,000
2027	440,000	2037	615,000
2028	450,000	2038	637,000

\*Preliminary, subject to change as described herein.

All Bids (as defined below) must be submitted in their entirety through PARITY until 11:00 a.m., New Jersey time on November 20, 2018 (see "Bidding Details"). To bid, Bidders (as defined below) must submit either (i) a certified, treasurer's or cashier's check or (ii) complete a wire transfer, in either case in the amount of \$188,940 (the check or wire transfer being hereinafter referred to as the "Deposit"), to secure the City from any loss resulting from a failure of the bidder to comply with the terms of its bid. The Deposit must be submitted to the City prior to the time for submission of bids, and if in the form of a certified, treasurer's or cashier's check, at the following address:

**Donna L. Mauer, Chief Financial Officer**  
**City of Jersey City**  
**280 Grove Street**  
**Jersey City, New Jersey 07302**

If a wire transfer is used for the Deposit, it must be sent according to the wire instructions provided by the City's Municipal Advisor, Tim Eismeier or Nick Wilechansky of NW Financial Group, LLC, 2 Hudson Place, Hoboken, New Jersey 07030 telephone number 201-656-0115, email [teismeier@nwfinancial.com](mailto:teismeier@nwfinancial.com) or [nickw@nwfinancial.com](mailto:nickw@nwfinancial.com) (please contact the Municipal Advisor for wire instructions) and if the bid is not accepted, the City shall promptly return the Deposit amount to the unsuccessful bidder. **EACH BIDDER IS REQUESTED TO PROVIDE THEIR RETURN WIRE INSTRUCTIONS.**

**The use of PARITY shall be at the Bidder's risk and expense, and the City shall have no liability with respect thereto.**

Checks of unsuccessful bidders will be returned upon the award of the Bonds. Any bidder that does not have a representative present at the bid announcement is requested to include with its good faith deposit overnight packaging or other return envelope for the return of its Deposit (if not the successful bidder). In the absence of other arrangements, the check of any unsuccessful bidder will be returned by certified first class mail to such name and return address as specified by such bidder when such Deposit was provided. By submitting a proposal for the Bonds, each bidder shall be deemed to have accepted any and all risks of loss associated with the return of its Deposit. Upon return of its Deposit, each such unsuccessful bidder shall acknowledge same by signing and returning a receipt to such effect provided by the City. If a wire transfer is used, such transfer must be completed and confirmed received by the City prior to the opening of the bids.

The Deposit of the winning bidder will be applied to the purchase price of the Bonds. In the event the winning bidder fails to comply with the terms of its accepted bid, the Deposit will be retained by the City as liquidated damages. The winning bidder shall not be entitled to any interest earnings in respect of the City.

The Bonds are to be issued in book-entry form only and all bidders for the Bonds must be participants of the Depository Trust Company ("DTC") or affiliated with its participants. The Bonds will be issued in the form of one certificate for the aggregate principal amount of Bonds maturing in each year and will be payable as to both principal and interest in lawful money of the United States of America. Each certificate will be registered in the name of Cede & Co., as nominee of DTC, which will act as Securities Depository. The certificate will be deposited with DTC which will be responsible for maintaining a book-entry system for recording the interests of its participants and the transfers of the interests among its participants. The participants will be responsible for maintaining records regarding the beneficial ownership interests in the Bonds on behalf of the individual purchasers. Individual purchases may be made in the principal amount of \$5,000 each or more thereof through book entries made on the books and records of DTC and its participants.

The Bonds will be dated the date of delivery, and will bear interest at the rate or rates per annum specified by the successful bidder therefor in accordance herewith, payable semi-annually on June 1 and December 1 in each year commencing June 1, 2019, until maturity, to DTC or its authorized nominee. DTC will credit payments of principal of and interest on the Bonds to the participants of DTC as listed on the records of DTC.

The Bonds maturing prior to December 1, 2026 are not subject to redemption prior to their stated maturity. The Bonds maturing on or after December 1, 2026 are subject to redemption, at the option of the City, prior to their stated maturity and upon notice as hereinafter provided, at any time on or after December 1, 2025, in whole or part from such maturities as the City shall determine and by lot within a single maturity, at the redemption price of 100% of the principal amount to be redeemed together with unpaid interest accrued to the redemption date.

In the event (a) DTC determines not to continue to act as Securities Depository for the Bonds or (b) the City determines that continuation of the book-entry system of evidence and transfer of ownership of the Bonds would adversely affect the interests of the beneficial owners of the Bonds, the City will discontinue the book-entry system with DTC. If the City fails to identify another qualified securities depository to replace DTC, the City will deliver replacement bonds in the form of fully registered certificates.

The Bonds are general obligations of the City and are secured by a pledge of the full faith and credit of the City for the payment of the principal thereof and the interest thereon. The Bonds are payable, if not paid from other sources, from ad valorem taxes to be levied upon all the real property taxable within the City without limitations as to rate or amount.

Each proposal submitted must name the rate or rates of interest per annum to be borne by the Bonds and the rate or rates named must be multiples of one-eighth or one-twentieth of one per centum. Not more than one rate may be named for the Bonds of the same maturity. There is no limitation on the number of rates that may be named. The difference between the lowest and the highest rates named in the proposal shall not exceed two per centum (2%). The Bonds will be awarded to the bidder on whose bid the total loan may be made at the lowest true interest cost ("TIC"). Such TIC cost shall be computed by determining the interest rate, compounded semi-annually, necessary to discount the debt service payments to the date of the bonds and to the price bid, excluding interest accrued to the delivery date. **Each proposal submitted must be for all of the Bonds and the purchase price specified in the proposal must be not less than \$9,447,000 nor more than \$10,391,700 (110%).** Please note the expectation of the City to adjust the amount of bonds to the amount needed by the City, as described below. No proposal shall be considered that offers to pay an amount less than the principal amount of the Bonds offered for sale or under which the total loan is made at a TIC higher than the lowest TIC to the City under any legally acceptable proposal, and if two or more such bidders offer to pay the lowest TIC, then the Bonds will be sold to one of such bidders selected by lot from among all such bidders. The purchaser must also pay an amount equal to the interest (if any) on the Bonds accrued to the date of payment of the purchase price. The right is reserved to reject all bids and to reject any bid not complying with this Notice

It is requested that each proposal be accompanied by a computation of the TIC to the City under the terms of the proposal in accordance with the method of calculation described in the

preceding paragraph (computed to six decimal places), but such computation is not to be considered as part of the proposal for Bonds. Determinations of TIC by the City shall be final.

The Chief Financial Officer of the City may determine to postpone, upon not less than 24 hours' notice, the date and time established for receipt of Bids. **ANY SUCH POSTPONEMENT WILL BE PUBLISHED ON THOMSON MUNICIPAL MARKET MONITOR ("TM3") ([www.tm3.com](http://www.tm3.com)) AND/OR PARITY, BEFORE 4:00 P.M. ON THE DAY BEFORE THE SALE.** If any date fixed for the receipt of Bids and the sale of the Bonds is postponed, an alternative sale date will be announced through TM3 at least forty-eight (48) hours prior to such alternative sale date. On any such alternative sale date, any Bidder may submit a Bid for the purchase of the Bonds in conformity in all respects with the provisions of the Notice of Sale, except for the date of sale and except for the changes announced on TM3 at the time the sale date and time are announced.

Each electronic proposal must be submitted through PARITY. No bidder will see any other bid, nor will any bidder see the status of its bid relative to other bids—i.e., whether its bid is a leading bid. To the extent any instructions or directions set forth on PARITY conflict with this Notice of Sale, the terms of this Notice of Sale shall control. For further information about PARITY, potential bidders may call PARITY at IPREO at (212) 849-5021. The City may, but is not obligated to, acknowledge its acceptance in writing of any bid submitted electronically through PARITY. In the event that a bid for the Bonds is submitted through PARITY, the bidder further agrees that the City may regard the electronic transmission of the bid through PARITY (including information about the purchase price of the Bonds, the interest rate or rates to be borne by the Bonds, the initial public offering price of each maturity of the Bonds and any other information included in such transmission) as though the same information were submitted on the official "Proposal for Bonds" provided by the City and executed by a duly authorized signatory of the bidder. If a bid submitted electronically through PARITY is accepted by the City, the terms of the official "Proposal for Bonds" and this Notice of Sale and the information that is electronically transmitted through PARITY shall form a contract, and the successful bidder shall be bound by the terms of such contract.

The City may and expects to, after the receipt and opening of bids, adjust the maturity schedule of the Bonds to adjust the amount of bonds to the amount needed by the City when considering the bid premium, provided however, that (i) no maturity schedule adjustment shall exceed 10% upward or downward of the principal for any maturity as specified herein, and (ii) the aggregate adjustment to the maturity schedule shall not exceed 10% upward or downward of the aggregate principal amount of bonds as specified herein and as adjusted will not exceed the amount authorized by the Bond Ordinances. The dollar amount bid by the successful bidder shall be adjusted to reflect any adjustments in the aggregate principal amount of bonds to be issued. The adjusted bid price will reflect changes in the dollar amount of the underwriter's discount and the original issue premium or discount, but will not change the per bond underwriter's discount as calculated from the bid and the Initial Public Offering Prices required to be delivered to the City as stated herein. The City shall notify the successful bidder of the final maturity schedule and the resulting adjusted purchase price no later than 5:00 p.m., New Jersey time, on the day of the sale and award of the Bonds. The interest rate or rates specified by the successful bidder for each maturity will not be altered.

PARITY is not an agent of the City, and the City shall have no liability whatsoever based on any bidder's use of PARITY, including but not limited to any failure by PARITY to correctly or timely transmit information provided by the City or information provided by the bidder.

The City may choose to discontinue use of electronic bidding through PARITY by issuing a notification to such effect through TM3, or by other available means, no later than 4:00 p.m., New Jersey Time, on the last business date prior to the bid date.

Once the bids are communicated electronically through PARITY to the City, each bid will constitute an official "Proposal for Bonds" and shall be deemed to be an irrevocable offer to purchase the Bonds on the terms provided in this Notice of Sale. For purposes of submitting all "Proposals for Bonds," whether electronically or sealed, the time as maintained on PARITY shall constitute the official time.

Each bidder shall be solely responsible to make necessary arrangements to access PARITY for purposes of submitting its bid in a timely manner and in compliance with the requirements of this Notice of Sale. Neither the City nor IPREO shall have any duty or obligation to any bidder, or be responsible for the proper operation of, or have any liability for any delays or interruptions of, or any damages caused by PARITY. The City is using PARITY as a communication mechanism, and not as the City's agent, to conduct the electronic bidding for the Bonds. By using PARITY each bidder agrees to hold the City harmless for any harm or damages caused to such bidder in connection with its use of PARITY for bidding on the Bonds.

Bidders should be aware of the following bidding details ("Bidding Details") associated with the sale of the Bonds:

**1. BIDDERS MUST SUBMIT GOOD FAITH CHECK OR WIRE TRANSFER (PLEASE CONTACT THE MUNICIPAL ADVISOR FOR WIRE INSTRUCTIONS) IN THE AMOUNT OF \$188,940 PAYABLE TO THE CITY NO LATER THAN 11:00 A.M. ON THE DAY OF SALE. HOWEVER, BIDDERS ARE ENCOURAGED TO SUBMIT CHECKS AND WIRES ON THE DAY PRIOR TO THE SALE TO ASSURE RECEIPT OF PAYMENT BY THE CITY AT THE FOLLOWING ADDRESS:**

**Donna L. Mauer, Chief Financial Officer  
City of Jersey City  
280 Grove Street  
Jersey City, New Jersey 07302**

**BIDDERS SUBMITTING GOOD FAITH CHECKS SHOULD ALSO ENCLOSE A RETURN ENVELOPE FOR USE BY THE CITY.**

2. All Bids must be submitted through PARITY. No telephone, telefax, telegraph or personal delivery Bids will be accepted.

3. All Bids for the Bonds must be submitted on an "All or None" ("AON") basis.

4 Each proposal submitted must name the rate or rates of interest per annum to be borne by the Bonds and the rate or rates named must be multiples of one-eighth or one-twentieth of one per centum. Not more than one rate may be named for the Bonds of the same maturity. There is no limitation on the number of rates that may be named. The difference between the lowest and the highest rates named in the proposal shall not exceed two per centum (2%). The Bonds will be awarded to the bidder on whose bid the total loan may be made at the lowest true interest cost (as such term is defined herein). **Each proposal submitted must be for all of the Bonds and the purchase price specified in the proposal must be not less than \$9,447,000 nor more than \$10,391,700 (110%).** Please note the expectation of the City to adjust the amount of bonds to the amount needed by the City, as described above. No proposal shall be considered that offers to pay an amount less than the principal amount of the Bonds offered for sale or under which the total loan is made at an interest cost higher than the lowest TIC to the City under any legally acceptable proposal. The purchaser must also pay an amount equal to the interest on the Bonds accrued to the date of payment of the purchase price, if any.

5. Bidders are only permitted to submit Bids for the Bonds during the bidding period.

#### Definitions

“Bid”	any confirmed purchase offer received by PARITY on or before the proposal submission deadline.
“Bidder”	any firm registered and approved for participation in sale.
“Winning Bid”	any purchase offer made by a Bidder and received by PARITY that, at the end of the bidding time period, results in the lowest TIC that is acceptable to the City.
“True Interest Cost” or “TIC”	computed by determining the interest rate, compounded semi-annually, necessary to discount the debt service payments to the date of the Bonds and to the price bid, excluding interest accrued to the delivery. The TIC serves as the basis for awarding bonds to winning Bidders.

The successful bidder may, at its option, refuse to accept the Bonds if prior to their delivery any income tax law of the United States of America shall provide that the interest thereon is includable in gross income for federal income tax purposes, or shall be so includable at a future date. In such case the deposit made by the bidder shall be returned and it will be relieved of its contractual obligations arising from the acceptance of its proposal.

The City reserves the right to reject any and all bids, and any bids not complying with provisions hereof or New Jersey law will be rejected. The City also reserves the right to waive any and all irregularity in any bid, to take any action adjourning or postponing the sale of the Bonds or to take any other action the City may deem to be in the best interest of the City.

## Establishment of Issue Price

(a) The winning bidder shall assist the Issuer in establishing the issue price of the Bonds and shall execute and deliver to the Issuer at Closing an "issue price" or similar certificate setting forth the reasonably expected initial offering price to the Public or the sales price or prices of the Bonds, together with the supporting pricing wires or equivalent communications, substantially in the forms reflected as Exhibits A, B or C, which are incorporated by reference herein and are available from Bond Counsel and shall be posted with the Notice of Sale on Parity, with such modifications as may be appropriate or necessary, in the reasonable judgment of the winning bidder, the Issuer and Bond Counsel. All actions to be taken by the Issuer under this Notice of Sale to establish the issue price of the Bonds may be taken on behalf of the Issuer by the Issuer's municipal advisor identified herein and any notice or report to be provided to the Issuer may be provided to the Issuer's municipal advisor or Bond Counsel.

(b) The Issuer intends that the provisions of Treasury Regulation Section 1.148-1(f)(3)(i) (defining "competitive sale" for purposes of establishing the issue price of the Bonds) will apply to the initial sale of the Bonds (the "competitive sale requirements") because:

(1) the Issuer shall disseminate this Notice of Sale to potential Underwriters in a manner that is reasonably designed to reach potential Underwriters;

(2) all bidders shall have an equal opportunity to bid;

(3) the Issuer may receive bids from at least three Underwriters of municipal bonds who have established industry reputations for underwriting new issuances of municipal bonds; and

(4) the Issuer anticipates awarding the sale of the Bonds to the bidder who submits a firm offer to purchase the Bonds at the highest price (or lowest interest cost), as set forth in this Notice of Sale.

Any bid submitted pursuant to this Notice of Sale shall be considered a firm offer for the purchase of the Bonds, as specified in the bid.

(c) If the successful bidder is purchasing for its own account without a present intention to reoffer the Bonds, it must complete Exhibit A, and the provisions of paragraphs (d)-(i) below shall not apply.

(d) In the event that paragraph (c) does not apply and the Competitive Sale Requirements are satisfied, the winning bidder must complete Exhibit B, and the provisions of paragraphs (e)-(i) below shall not apply.

(e) In the event that paragraph (c) does not apply and the Competitive Sale Requirements are not satisfied, the Issuer shall so advise the winning bidder and the winning bidder must complete Exhibit C. The Issuer may determine to treat (i) the first price at which 10% of a Maturity of the Bonds (the "10% test" is sold to the Public as the issue price of that Maturity and/or (ii) the initial offering price to the Public as of the Sale Date of any Maturity of



the Bonds as the issue price of that Maturity (the “hold-the-offering-price rule”), in each case applied on a Maturity-by-Maturity basis (and if different interest rates apply within a Maturity, to each separate CUSIP number within that Maturity). Immediately following the award of the Bonds, the winning bidder shall advise the Issuer if any Maturity of the Bonds satisfies the 10% test. Any Maturity (and if different interest rates apply within a Maturity, any separate CUSIP number within that Maturity) of the Bonds as to which the winning bidder has not so advised the Issuer that the 10% test has been satisfied shall be subject to the hold-the-offering-price rule. Bids will not be subject to cancellation in the event that the hold-the-offering-price rule applies to any Maturity of the Bonds. Bidders should prepare their bids on the assumption that some or all of the maturities of the Bonds will be subject to the hold-the-offering-price rule in order to establish the issue price of the Bonds.

(f) By submitting a bid, the winning bidder shall (i) confirm that the Underwriters have offered or will offer the Bonds to the Public on or before the date of award at the offering price or prices (the “initial offering price”), or at the corresponding yield or yields, set forth in the bid submitted by the winning bidder and (ii) agree, on behalf of the Underwriters participating in the purchase of the Bonds, that the Underwriters will neither offer nor sell unsold Bonds of any Maturity to which the hold-the-offering-price rule shall apply to any person at a price that is higher than the initial offering price to the Public during the period starting on the Sale Date and ending on the earlier of the following:

- (1) the close of the fifth (5<sup>th</sup>) business day after the Sale Date; or
- (2) the date on which the Underwriters have sold at least 10% of that Maturity of the Bonds to the Public at a price that is no higher than the initial offering price to the Public.

The winning bidder will advise the Issuer promptly after the close of the fifth (5<sup>th</sup>) business day after the Sale Date whether it has sold 10% of that Maturity of the Bonds to the Public at a price that is no higher than the initial offering price to the Public.

(g) If the competitive sale requirements are not satisfied, then until the 10% test has been satisfied as to each Maturity of the Bonds, the winning bidder agrees to promptly report to the Issuer the prices at which the unsold Bonds of that Maturity have been sold to the Public. That reporting obligation shall continue, whether or not the Closing Date has occurred, until either (i) all Bonds of that Maturity have been sold or (ii) the 10% test has been satisfied as to the Bonds of that Maturity; provided that, the winning bidder’s reporting obligation after the Closing Date may be at reasonable periodic intervals or otherwise upon request of the Issuer or Bond Counsel.

(h) The Issuer acknowledges that, in making the representations set forth above, the winning bidder will rely on (i) the agreement of each Underwriter to comply with the requirements for establishing the issue price of the Bonds, including, but not limited to, its agreement to comply with the hold-the-offering-price rule, if applicable to the Bonds, as set forth in an agreement among Underwriters and the related pricing wires, (ii) in the event a selling group has been created in connection with the initial sale of the Bonds to the Public, the agreement of each dealer who is a member of the selling group to comply with the requirements

for establishing the issue price of the Bonds, including, but not limited to, its agreement to comply with the hold-the-offering-price rule, if applicable to the Bonds, as set forth in a selling group agreement and the related pricing wires, and (iii) in the event that an Underwriter or dealer who is a member of the selling group is a party to a third-party distribution agreement that was employed in connection with the initial sale of the Bonds to the Public, the agreement of each broker-dealer that is a party to such agreement to comply with the requirements for establishing the issue price of the Bonds, including, but not limited to, its agreement to comply with the hold-the-offering-price rule, if applicable to the Bonds, as set forth in the third-party distribution agreement and the related pricing wires. The Issuer further acknowledges that each Underwriter shall be solely liable for its failure to comply with its agreement regarding the requirements for establishing the issue price of the Bonds, including, but not limited to, its agreement to comply with the hold-the-offering-price rule, if applicable to the Bonds, and that no Underwriter shall be liable for the failure of any other Underwriter, or of any dealer who is a member of a selling group, or of any broker-dealer that is a party to a third-party distribution agreement to comply with its corresponding agreement regarding the requirements for establishing the issue price of the Bonds, including, but not limited to, its agreement to comply with the hold-the-offering-price rule, if applicable to the Bonds.

(i) By submitting a bid, each bidder confirms that: (i) any agreement among Underwriters, any selling group agreement and each third-party distribution agreement (to which the bidder is a party) relating to the initial sale of the Bonds to the Public, together with the related pricing wires, contains or will contain language obligating each Underwriter, each dealer who is a member of the selling group, and each broker-dealer that is a party to such third-party distribution agreement, as applicable:

(A) (i) to report the prices at which it sells to the Public the unsold Bonds of each Maturity allocated to it, whether or not the Closing Date has occurred, until either all Bonds of that Maturity allocated to it have been sold or it is notified by the winning bidder that either the 10% test has been satisfied as to the Bonds of that Maturity; provided that, the reporting obligation after the Closing Date may be at reasonable periodic intervals upon request of the winning bidder and (ii) to comply with the hold-the-offering-price rule, if applicable, if and for so long as directed by the winning bidder and as set forth in the related pricing wires, (B) to promptly notify the winning bidder of any sales of Bonds, that, to its knowledge are made to a purchaser who is a related party to an Underwriter participating in the initial sale of the Bonds to the Public, and (C) to acknowledge that, unless otherwise advised by the Underwriter, dealer or broker-dealer, the winning bidder shall assume that each order submitted by the Underwriter, dealer or broker-dealer is a sale to the Public.

(ii) any agreement among Underwriters or selling group agreement relating to the initial sale of the Bonds to the Public, together with the related pricing wires, contains or will contain language obligating each Underwriter or dealer that is a party to a third-party distribution agreement to be employed in connection with the initial sale of the Bonds to the Public to require each broker-dealer that is a party to such third-party distribution agreement to (A) report the prices at which it sells to the Public the unsold Bonds of each Maturity allocated to it, whether or not the Closing Date has occurred, until either all Bonds of that Maturity allocated to it have been sold or it is notified by the winning bidder or such Underwriter that either the 10% test has

been satisfied as to the Bonds of that Maturity; provided that the reporting obligation after the Closing Date may be at reasonable periodic intervals upon request of the winning bidder and (B) comply with the hold-the-offering-price rule, if applicable, in each case if and for so long as directed by the winning bidder or such Underwriter and as set forth in the related pricing wires.

(j) Sales of any Bonds to any person that is a related party to an Underwriter participating in the initial sale of the Bonds to the Public shall not constitute sales to the Public for purposes of this Notice of Sale. Further, for purposes of this Notice of Sale:

(i) "Public" means any person other than an Underwriter or a related party,

(ii) "Underwriter" means (A) any person that agrees pursuant to a written contract with the Issuer (or with the lead Underwriter to form an underwriting syndicate) to participate in the initial sale of the Bonds to the Public and (B) any person that agrees pursuant to a written contract directly or indirectly with a person described in clause (A) to participate in the initial sale of the Bonds to the Public (including a member of a selling group or a party to a third-party distribution agreement participating in the initial sale of the Bonds to the Public),

(iii) a purchaser of any of the Bonds is a "related party" to an Underwriter if the Underwriter and the purchaser are subject, directly or indirectly, to (A) more than 50% common ownership of the voting power or the total value of their stock, if both entities are corporations (including direct ownership by one corporation of another), (B) more than 50% common ownership of their capital interests or profits interests, if both entities are partnerships (including direct ownership by one partnership of another), or (C) more than 50% common ownership of the value of the outstanding stock of the corporation or the capital interests or profit interests of the partnership, as applicable, if one entity is a corporation and the other entity is a partnership (including direct ownership of the applicable stock or interests by one entity of the other), and

(iv) "Sale Date" means the date that the Bonds are awarded by the Issuer to the winning bidder.

A Preliminary Official Statement has been prepared and is available for viewing in electronic format on [www.i-dealprospectus.com](http://www.i-dealprospectus.com) and may also be obtained from the City's Municipal Advisor identified in the last paragraph of this Notice. The Preliminary Official Statement is deemed to be a final official statement, as of its date, within the meaning of Rule 15c2-12 of the Securities and Exchange Commission, but is subject to (a) completion with certain pricing and other information to be made available by the successful bidder for the Bonds and (b) amendment. The Preliminary Official Statement, as so revised, will constitute the final "Official Statement". By the submission of a bid for the Bonds, the successful bidder contracts for the receipt, within seven (7) business days of the award of the Bonds, of one hundred (100) copies of the final Official Statement at the expense of the City, with any additional copies of the final Official Statement that the successful bidder shall reasonably request to be provided at the

sole cost and expense of the successful bidder. In order to complete the final Official Statement, the successful bidder must furnish the following information to the City's Municipal Advisor and Bond Counsel by email or facsimile transmission or overnight delivery received by the City's Municipal Advisor and Bond Counsel within twenty-four (24) hours after the award of the Bonds: (a) initial offering prices (expressed as a price, exclusive of accrued interest, or yield per maturity), and (b) any other material information necessary for the final Official Statement but not known to the City (such as the bidder's purchase of credit enhancement). In addition, the successful bidder must, if requested by the City, furnish a written confirmation of its bid.

The City will undertake to provide certain continuing disclosure in accordance with Rule 15c2-12 of the Securities and Exchange Commission. A description of this undertaking is contained in the Preliminary Official Statement under the heading "CONTINUING DISCLOSURE".

Award of the Bonds to the successful bidder or rejection of all bids is expected to be made within two (2) hours after announcement of the bids, but such successful bidder may not withdraw its proposal until after 5:30 p.m. of the day of such bid-opening and then only if such award has not been made prior to the withdrawal. The balance of the purchase price shall be paid in immediately available funds by wire transfer to the City on the delivery date of the Bonds.

If a proposal is accepted but the City shall fail to deliver the Bonds to the successful bidder in accordance with the terms and conditions of its proposal, the Deposit shall be returned to such bidder. If a proposal is accepted but the successful bidder shall default in the performance of any of the terms and conditions of its proposal, the Deposit shall be retained by the City as and for liquidated damages.

The Bonds will be delivered through DTC on or before December 6, 2018, or such other date agreed to by the City and the successful bidder. PAYMENT FOR THE BONDS AT THE TIME OF THE CLOSING SHALL BE IN IMMEDIATELY AVAILABLE FEDERAL FUNDS.

If the Bonds qualify for issuance of any policy of municipal bond insurance, the purchaser of the Bonds may, at its sole option and expense, purchase such insurance. Any failure of the Bonds to be so insured shall not in any way relieve the purchaser of its contractual obligations arising from the acceptance of its proposal for the purchase of the Bonds.

It is anticipated that CUSIP identification numbers will be printed on the Bonds, but neither the failure to print such number on any Bond nor any error with respect thereto shall constitute cause for a failure or refusal by the winning bidder thereof to accept delivery of and pay for the Bonds. The City's Municipal Advisor will request the CUSIPs and will provide CUSIP Global Services with the final details of the sale, including the identity of the winning bidder. The winning bidder will be responsible for the cost of the CUSIPs.

The obligation hereunder to deliver and accept the Bonds shall be conditioned on the availability and the delivery at the time of delivery of the Bonds of: (a) the approving opinion of the law firm of GluckWalrath LLP, Trenton, New Jersey, Bond Counsel, which will be furnished

without cost to the successful bidder, substantially to the effect set forth in the Preliminary Official Statement referred to below; (b) certificates in form satisfactory to said law firms evidencing the proper execution and delivery of the Bonds and receipt of payment therefor, and compliance with the requirements of the Internal Revenue Code of 1986, as amended (the "Code") necessary to preserve the tax exemption as to the Bonds; (c) a certificate, in form and tenor satisfactory to said law firm and dated as of the date of such delivery, to the effect that there is no litigation pending or, to the knowledge of the signer or signers thereof, threatened affecting the validity of the Bonds; and (d) the City's Continuing Disclosure Certificate substantially in the form described in the Preliminary Official Statement.

In order to assist bidders in complying with SEC Rule 15c2-12(b)(5), the City will undertake, pursuant to a Continuing Disclosure Certificate, to provide certain annual information and notices of the occurrence of certain events, if material. A description of this undertaking is set forth in the Preliminary Official Statement and will also be set forth in the final Official Statement.

The successful bidder is advised of its responsibility to file an annual disclosure statement on political contributions with the New Jersey Election Law Enforcement Commission ("ELEC") pursuant to N.J.S.A. 19:44A-20.13 (P.L. 2005, c.271, s.3) if the successful bidder enters into agreements or contracts, such as its agreement to purchase the Bonds, with a public entity, such as the City and receives compensation or fees in excess of \$50,000 in the aggregate from public entities, such as the City, in a calendar year. It is the successful bidder's responsibility to determine if filing is necessary. Failure to do so can result in the imposition of financial penalties by ELEC. Additional information about this requirement is available from ELEC at 888-313-3532 or at [www.elec.state.nj.us](http://www.elec.state.nj.us).

Copies of the Preliminary Official Statement may be obtained from the City's Municipal Advisor, Tim Eismeier or Nick Wilechansky of NW Financial Group, LLC, 2 Hudson Place, Hoboken, New Jersey 07030, telephone number 201-656-0115 or [teismeier@nwfinancial.com](mailto:teismeier@nwfinancial.com) or [nickw@nwfinancial.com](mailto:nickw@nwfinancial.com).

Dated: November 12, 2018

BY: /s/ Donna L. Mauer  
Chief Financial Officer  
City of Jersey City  
County of Hudson, New Jersey

The following Exhibits are incorporated by reference in the Notice of Sale:

**EXHIBIT A**

**CITY OF JERSEY CITY, IN THE COUNTY OF HUDSON, NEW JERSEY**

**§ \_\_\_\_\_ GENERAL IMPROVEMENT BONDS, SERIES 2018**

**CERTIFICATE OF THE PURCHASER  
(NO REOFFERING PURCHASER)**

The undersigned, on behalf of \_\_\_\_\_ (the "Purchaser"), hereby certifies as set forth below with respect to the purchase of the above-captioned obligations (the "Bonds").

1. ***Purchase of the Bonds.*** On the date of this certificate, the Purchaser is purchasing the Bonds for the amount of \_\_\_\_\_. The Purchaser is not acting as an Underwriter with respect to the Bonds. The Purchaser has no present intention to sell, reoffer, or otherwise dispose of the Bonds (or any portion of the Bonds or any interest in the Bonds). The Purchaser has not contracted with any person pursuant to a written agreement to have such person participate in the initial sale of the Bonds and the Purchaser has not agreed with the Issuer pursuant to a written agreement to sell the Bonds to persons other than the Purchaser or a related party to the Purchaser.

2. ***Defined Terms.***

(a) ***Public*** means any person (including an individual, trust, estate, partnership, association, company, or corporation) other than an Underwriter or a related party. The term "related party" for purposes of this certificate generally means any two or more persons who have greater than 50 percent common ownership, directly or indirectly.

(b) ***Underwriter*** means (i) any person that agrees pursuant to a written contract with the Issuer (or with the lead Underwriter to form an underwriting syndicate) to participate in the initial sale of the Bonds to the Public, and (ii) any person that agrees pursuant to a written contract directly or indirectly with a person described in clause (i) of this paragraph to participate in the initial sale of the Bonds to the Public (including a member of a selling group or a party to a third-party distribution agreement participating in the initial sale of the Bonds to the Public).

The representations set forth in this certificate are limited to factual matters only. Nothing in this certificate represents the Purchaser's interpretation of any laws, including specifically Sections 103 and 148 of the Internal Revenue Code of 1986, as amended, and the Treasury Regulations thereunder. The undersigned understands that the foregoing information will be relied upon by the Issuer with respect to certain of the representations set forth in the Tax or Arbitrage Certificate and with respect to compliance with the federal income tax rules affecting the Bonds, and by GluckWalrath LLP, Bond Counsel to the Issuer, in connection with rendering its opinion that the interest on the Bonds is excluded from gross income for federal income tax purposes, the preparation of the Internal Revenue Service Form 8038-G, and other federal income tax advice that it may give to the Issuer from time to time relating to the Bonds.

[PURCHASER]

By: \_\_\_\_\_

Name: \_\_\_\_\_

Title: \_\_\_\_\_

Dated: \_\_\_\_\_

**EXHIBIT B**

**CITY OF JERSEY CITY, IN THE COUNTY OF HUDSON, NEW JERSEY**

**\$ \_\_\_\_ GENERAL IMPROVEMENT BONDS, SERIES 2018**

**ISSUE PRICE CERTIFICATE**

**(Competitive Sale Requirement Satisfied)**

The undersigned (the “Representative”), on behalf of itself and each member of the underwriting group (if any) (collectively, the “Underwriter”) hereby certifies as set forth below with respect to the sale of the above-captioned obligations (the “Bonds”).

**1. *Reasonably Expected Initial Offering Price.***

(a) As of the Sale Date, the reasonably expected initial offering prices and yields of the Bonds to the Public by the Underwriter are the prices and yields listed in Schedule A (the “Expected Offering Prices”). The Expected Offering Prices are the prices for the Maturities of the Bonds used by Underwriter in formulating its bid to purchase the Bonds. Attached as Schedule B is a true and correct copy of the bid provided by the Underwriter to purchase the Bonds.

(b) The Underwriter was not given the opportunity to review other bids prior to submitting its bid.

(c) The bid submitted by the Underwriter constituted a firm offer to purchase the Bonds.

[(d) The Underwriter has obtained a bond insurance policy from \_\_\_\_\_ (“Insurer”) in respect of the Bonds. Based on our experience with bonds similar to the Bonds (i) the bond insurance was an important factor in marketing the Bonds and (ii) the absence of the insurance would have materially affected in an adverse manner the interest rates at which the Bonds could have been sold. The insurance policy will be issued for a premium of \$\_\_\_\_\_, which is net of any credits or rating agency fees. No portion of the premium represents the indirect payment of costs of issuance, including rating agency fees or the provision of additional services by Insurer. The present value of the insurance is less than the present value of the interest reasonably expected to be saved as a result of using the insurance to secure the Bonds, using as a discount rate the yield on the Bonds, calculated with treating the premiums as interest.]

**2. *Defined Terms.***

(a) *Issuer* means the City of Jersey City, in the County of Hudson, New Jersey.

(b) *Maturity* means Bonds with the same credit and payment terms. Bonds with different maturity dates, or Bonds with the same Maturity date but different stated interest rates, are treated as separate maturities.



(c) *Public* means any person (including an individual, trust, estate, partnership, association, company, or corporation) other than an Underwriter or a related party to an Underwriter. The term “related party” for purposes of this certificate generally means any two or more persons who have greater than 50 percent common ownership, directly or indirectly.

(d) *Sale Date* means the first day on which the Bonds are awarded by the Issuer to the winning bidder. The Sale Date of the Bonds is November 20, 2018.

(e) *Underwriter* means (i) any person that agrees pursuant to a written contract with the Issuer (or with the lead Underwriter to form an underwriting syndicate) to participate in the initial sale of the Bonds to the Public, and (ii) any person that agrees pursuant to a written contract directly or indirectly with a person described in clause (i) of this paragraph to participate in the initial sale of the Bonds to the Public (including a member of a selling group or a party to a third-party distribution agreement participating in the initial sale of the Bonds to the Public).

The representations set forth in this certificate are limited to factual matters only. Nothing in this certificate represents the Underwriter’s interpretation of any laws, including specifically Sections 103 and 148 of the Internal Revenue Code of 1986, as amended, and the Treasury Regulations thereunder. The undersigned understands that the foregoing information will be relied upon by the Issuer with respect to certain of the representations set forth in the Issuer’s Tax or Arbitrage Certificate and with respect to compliance with the federal income tax rules affecting the Bonds, and by GluckWalrath LLP, bond counsel to the Issuer, in connection with rendering its opinion that the interest on the Bonds is excluded from gross income for federal income tax purposes, the preparation of the Internal Revenue Service Form 8038-G, and other federal income tax advice that it may give to the Issuer from time to time relating to the Bonds.

[REPRESENTATIVE, on behalf of itself and each member of the underwriting group]

By: \_\_\_\_\_  
Name: \_\_\_\_\_  
Title: \_\_\_\_\_  
Dated: \_\_\_\_\_

**SCHEDULE A**

**EXPECTED OFFERING PRICES AND YIELDS**

**SCHEDULE B**

**COPY OF BID**

EXHIBIT C

CITY OF JERSEY CITY, IN THE COUNTY OF HUDSON, NEW JERSEY

\$ \_\_\_\_\_ GENERAL IMPROVEMENT BONDS, SERIES 2018

ISSUE PRICE CERTIFICATE

(Hold the Price for all or some maturities)

The undersigned (the “Representative”), on behalf of itself and each member of the underwriting group (if any) (collectively, the “Underwriter”), hereby certifies as set forth below with respect to the sale and issuance of the above-captioned obligations (the “Bonds”). Select appropriate provisions below:

1. [Alternative 1<sup>1</sup> – All Maturities Use General Rule: *Sale of the Bonds*. As of the date of this certificate, for each Maturity of the Bonds, the first price at which at least 10% of such Maturity of the Bonds was sold to the Public is the respective price listed in Schedule A.]

[Alternative 2<sup>2</sup> – Select Maturities Use General Rule: *Sale of the General Rule Maturities*. As of the date of this certificate, for each Maturity of the General Rule Maturities, the first price at which at least 10% of such Maturity of the Bonds was sold to the Public is the respective price listed in Schedule A.

2. *Initial Offering Price of the [Bonds][Hold-the-Offering-Price Maturities]*.

(a) [Alternative 1<sup>3</sup> – All Maturities Use Hold-the-Offering-Price Rule: The Underwriter offered the Bonds to the Public for purchase at the respective initial offering prices listed in Schedule A (the “Initial Offering Prices”) on or before the Sale Date. A copy of the pricing wire or equivalent communication for the Bonds is attached to this certificate as Schedule B.]

[Alternative 2<sup>4</sup> – Select Maturities Use Hold-the-Offering-Price Rule: The Underwriter offered the Hold-the-Offering-Price Maturities to the Public for purchase at the respective initial offering prices listed in Schedule A (the “Initial Offering Prices”) on or before the Sale Date. A

<sup>1</sup> If Alternative 1 is used, delete the remainder of paragraph 1 and all of paragraph 2 and renumber paragraphs accordingly.

<sup>2</sup> If Alternative 2 is used, delete Alternative 1 of paragraph 1 and use each Alternative 2 in paragraphs 2(a) and (b).

<sup>3</sup> If Alternative 1 is used, delete all of paragraph 1 and renumber paragraphs accordingly.

<sup>4</sup> Alternative 2(a) of paragraph 2 should be used in conjunction with Alternative 2 in paragraphs 1 and 2(b)

copy of the pricing wire or equivalent communication for the Bonds is attached to this certificate as Schedule C.]

(b) [Alternative 1 – All Maturities use Hold-the-Offering-Price Rule: As set forth in the Notice of Sale and bid award, the Underwriter has agreed in writing that, (i) for each Maturity of the Bonds, it would neither offer nor sell any of the Bonds of such Maturity to any person at a price that is higher than the Initial Offering Price for such Maturity during the Holding Period for such Maturity (the “hold-the-offering-price rule”), and (ii) any selling group agreement shall contain the agreement of each dealer who is a member of the selling group, and any third-party distribution agreement shall contain the agreement of each broker-dealer who is a party to the third-party distribution agreement, to comply with the requirements for establishing the issue price of the Bonds, including, but not limited to, its agreement to comply with the hold-the-offering-price rule, if applicable to the Bonds. Pursuant to such agreement, no Underwriter (as defined below) has offered or sold any Maturity of the Bonds at a price that is higher than the respective Initial Offering Price for that Maturity of the Bonds during the Holding Period.]

[Alternative 2 - Select Maturities Use Hold-the-Offering-Price Rule: As set forth in the Notice of Sale and bid award, the Underwriter has agreed in writing that, (i) for each Maturity of the Hold-the-Offering-Price Maturities, it would neither offer nor sell any of the Bonds of such Maturity to any person at a price that is higher than the Initial Offering Price for such Maturity during the Holding Period for such Maturity (the “hold-the-offering-price rule”), and (ii) any selling group agreement shall contain the agreement of each dealer who is a member of the selling group, and any third-party distribution agreement shall contain the agreement of each broker-dealer who is a party to the third-party distribution agreement, to comply with the requirements for establishing the issue price of the Bonds, including, but not limited to, its agreement to comply with the hold-the-offering-price rule, if applicable to the Bonds. Pursuant to such agreement, no Underwriter (as defined below) has offered or sold any Maturity of the Hold-the-Offering-Price Maturities at a price that is higher than the respective Initial Offering Price for that Maturity of the Bonds during the Holding Period.]

[(c) The Underwriter has obtained a bond insurance policy from \_\_\_\_\_ (“Insurer”) in respect of the Bonds. Based on our experience with bonds similar to the Bonds (i) the bond insurance was an important factor in marketing the Bonds and (ii) the absence of the insurance would have materially affected in an adverse manner the interest rates at which the Bonds could have been sold. The insurance policy will be issued for a premium of \$\_\_\_\_\_, which is net of any credits or rating agency fees. No portion of the premium represents the indirect payment of costs of issuance, including rating agency fees or the provision of additional services by Insurer. The present value of the insurance is less than the present value of the interest reasonably expected to be saved as a result of using the insurance to secure the Bonds, using as a discount rate the yield on the Bonds, calculated with treating the premiums as interest.]

### 3. *Defined Terms.*

(a) *General Rule Maturities* means those Maturities of the Bonds listed in Schedule A hereto as the “General Rule Maturities.”

(b) *Hold-the-Offering-Price Maturities* means those Maturities of the Bonds listed in Schedule B hereto as the “Hold-the-Offering-Price Maturities.”

(c) *Holding Period* means, with respect to a Hold-the-Offering-Price Maturity, the period starting on the Sale Date and ending on the earlier of (i) the close of the fifth business day after the Sale Date (November 28, 2018), or (ii) the date on which the Underwriter has sold at least 10% of such Hold-the-Offering-Price Maturity to the Public at prices that are no higher than the Initial Offering Price for such Hold-the-Offering-Price Maturity.

(d) *Issuer* means the City of Jersey City, in the County of Hudson, New Jersey.

(e) *Maturity* means Bonds with the same credit and payment terms. Bonds with different maturity dates, or Bonds with the same maturity date but different stated interest rates, are treated as separate maturities.

(f) *Public* means any person (including an individual, trust, estate, partnership, association, company, or corporation) other than an Underwriter or a related party to an Underwriter. The term “related party” for purposes of this certificate generally means any two or more persons who have greater than 50 percent common ownership, directly or indirectly.

(g) *Sale Date* means the first day on which there is a binding contract in writing for the sale of a Maturity of the Bonds. The Sale Date of the Bonds is November 20, 2018.

(h) *Underwriter* means (i) any person that agrees pursuant to a written contract with the Issuer (or with the lead Underwriter to form an underwriting syndicate) to participate in the initial sale of the Bonds to the Public, and (ii) any person that agrees pursuant to a written contract directly or indirectly with a person described in clause (i) of this paragraph to participate in the initial sale of the Bonds to the Public (including a member of a selling group or a party to a third-party distribution agreement participating in the initial sale of the Bonds to the Public).

The representations set forth in this certificate are limited to factual matters only.

Nothing in this certificate represents the Underwriter’s interpretation of any laws, including specifically Sections 103 and 148 of the Internal Revenue Code of 1986, as amended, and the Treasury Regulations thereunder.

The undersigned understands that the foregoing information will be relied upon by the Issuer with respect to certain of the representations set forth in the Tax or Arbitrage Certificate and with respect to compliance with the federal income tax rules affecting the Bonds, and by GluckWalrath LLP, bond counsel, in connection with rendering its opinion that the interest on

the Bonds is excluded from gross income for federal income tax purposes, the preparation of Internal Revenue Service Form 8038-G, and other federal income tax advice it may give to the Issuer from time to time relating to the Bonds.

[REPRESENTATIVE, on behalf of itself and each member of the underwriting group]

By: \_\_\_\_\_

Name: \_\_\_\_\_

Title: \_\_\_\_\_

Dated: \_\_\_\_\_

**SCHEDULE A**

**SALE PRICES OF THE GENERAL RULE MATURITIES**  
*(Attached)*

<b>Maturity Date</b>	<b>Par Amount</b>	<b>Rate</b>	<b>Issue Price</b>
<b>Total</b>		-	



**SCHEDULE [B]**

**INITIAL OFFERING PRICES OF THE HOLD-THE-OFFERING-PRICE MATURITIES**  
*(Attached)*

<b>Maturity Date</b>	<b>Par Amount</b>	<b>Rate</b>	<b>Issue Price</b>
<b>Total</b>			

**SCHEDULE [B][C]**

**PRICING WIRE OR EQUIVALENT COMMUNICATION**  
*(Attached)*

**APPENDIX C**  
**CITY OF JERSEY CITY, IN THE COUNTY OF HUDSON, NEW JERSEY**  
**\$9,447,000\* GENERAL IMPROVEMENT BONDS, SERIES 2018**

**SUMMARY NOTICE OF SALE**

(Book-Entry-Only) (Callable)

Dated Date: Date of Delivery

Delivery Date: Expected to be December 6, 2018

Bid Date: ELECTRONIC PROPOSALS will be received through the PARITY Electronic Bid System ("PARITY") of IPREO LLC website on November 20, 2018 prior to 11:00 a.m. Award by 1:00 p.m.

Type of Sale: Competitive bid through PARITY

Interest: Multiple Interest Rates – ascending in multiples of 1/8 or 1/20 of 1%  
The difference between the lowest and the highest rates shall not exceed two per centum (2%).

Maturity Schedule: The Bonds will consist of serial bonds (unless aggregated into term bonds as provided in the Notice of Sale) maturing on December 1 in the years 2019 through 2038, inclusive, as set forth in the following table:

<u>Year</u>	<u>Principal Amount*</u>	<u>Year</u>	<u>Principal Amount*</u>
2019	\$360,000	2029	\$465,000
2020	365,000	2030	480,000
2021	370,000	2031	500,000
2022	380,000	2032	515,000
2023	390,000	2033	530,000
2024	400,000	2034	550,000
2025	415,000	2035	570,000
2026	425,000	2036	590,000
2027	440,000	2037	615,000
2028	450,000	2038	637,000

\*Preliminary, subject to change as described in the Notice of Sale.

Legal Opinion: GluckWalrath LLP, Trenton, NJ

Bid Security: **Good Faith Check or wire transfer must be received by the City prior to bidding in the amount of \$188,940**

**Preliminary Official Statement, a Notice of Sale and other details available at [www.i-dealprospectus.com](http://www.i-dealprospectus.com)**

APPENDIX D

UNITED STATES OF AMERICA  
STATE OF NEW JERSEY  
COUNTY OF HUDSON  
CITY OF JERSEY CITY

GENERAL IMPROVEMENT BOND, SERIES 2018

No. R-1 \$ \_\_\_\_\_  
INTEREST RATE MATURITY DATE DATED DATE CUSIP NUMBER  
\_\_\_\_\_% December 1, 20\_\_ December 6, 2018 \_\_\_\_\_

REGISTERED OWNER: CEDE & CO.

PRINCIPAL SUM: \_\_\_\_\_ Dollars

The City of Jersey City, in the County of Hudson, a public body corporate and politic organized and existing under the laws of the State of New Jersey (the "City"), for value received, hereby acknowledges itself to be indebted and promises to pay to the Registered Owner hereof on the Maturity Date set forth above the Principal Sum set forth above, and to pay interest thereon semi-annually on June 1 and December 1 of each year, commencing June 1, 2019 (each, an "Interest Payment Date"), at the Interest Rate specified above, calculated on the basis of a 360-day year of twelve 30-day months, until the payment of the Principal Sum has been made or duly provided for. As long as The Depository Trust Company ("DTC") or its nominee, Cede & Co., is the registered owner of the Bonds, payments of the principal of and interest on the Bonds will be made by the City, or the hereinafter-defined Paying Agent, directly to DTC or its nominee, Cede & Co., which will credit payments of principal of and interest on the Bonds to the participants of DTC as listed on the records of DTC as of each next preceding May 15 and November 15 (the "Record Dates" for the payment of interest on the Bonds), which participants will in turn credit such payments to the beneficial owners of the Bonds. Both the principal of and the interest on this bond are payable in lawful money of the United States of America.

No transfer of this bond shall be valid unless made on the registration books of the City kept for that purpose by the Chief Financial Officer (or, if a Paying Agent is appointed by the City, at the corporate trust office of the Paying Agent) and by surrender of this bond (together with a written instrument of transfer satisfactory to the Chief Financial Officer or Paying Agent (as appropriate) duly executed by the registered owner or by his or her duly authorized attorney) and the issuance of a new bond or bonds in the same form and tenor as the original bond except for the differences in the name of its registered owner, the denominations and the Date of Authentication. The owner of any bond or bonds may surrender same (together with a written instrument of transfer satisfactory to the Chief Financial Officer or Paying Agent, if any (as

appropriate) duly executed by the registered owner or by his or her duly authorized attorney), in exchange for an equal aggregate principal amount of bonds of any authorized denominations. Notwithstanding the foregoing, as long as the Bonds remain in book-entry form, transfer of ownership interests in the Bonds shall be made by DTC and its participants by book-entries which are made on the records of DTC and its participants.

This Bond is one of a duly authorized issue of General Improvement Bonds, Series 2018 the City in the aggregate principal amount of \$ \_\_\_\_\_ (the "Bonds"), all of like date and tenor, except as to date of maturity and denomination, and all authorized and issued under and pursuant to the Local Bond Law of the State of New Jersey constituting Chapter 169 of the Laws of 1960, effective January 1, 1962, as amended, a Resolution duly adopted by the Municipal Council on \_\_\_\_\_, 2018 and various Bond Ordinances referred to therein, each in all respects duly approved and published as required by law. The Bonds are issued for the purpose of providing funds for and towards the costs of various capital improvements.

The Bonds maturing prior to December 1, 2026 are not subject to redemption prior to their stated maturity. The Bonds maturing on or after December 1, 2026 are subject to redemption, at the option of the City, prior to their stated maturity and upon notice as hereinafter provided, at any time on or after December 1, 2025, in whole or part from such maturities as the City shall determine and by lot within a single maturity, at the redemption price of 100% of the principal amount to be redeemed together with unpaid interest accrued to the redemption date.

[The Bonds maturing on December 1, \_\_\_\_\_, shall be subject to mandatory sinking fund redemption on December 1, in each year and in the amounts set forth in the chart below, at a redemption price equal to one hundred percent (100%) of the principal amount thereof, plus accrued and unpaid interest thereon to the date of redemption:

\$ \_\_\_\_\_ **Term Bonds Due December 1, \_\_\_\_\_**

Year

Amount

\* [Final Maturity.]

Any Bond subject to redemption as aforesaid may be called in part, provided that the portion not called for redemption shall be in the principal amount of \$1,000 or any integral multiple thereof. If less than all of the Bonds of a particular series and maturity are to be redeemed, Bonds of that series and maturity shall be selected by the Chief Financial Officer (or, if appointed by the City, the Paying Agent) by lot.

When any Bonds are to be redeemed, the Chief Financial Officer (or, if appointed by the City, the Paying Agent) shall give notice of the redemption of the Bonds by first class mail in a sealed envelope postage prepaid, to the registered owners of any bonds or portions thereof which

are to be redeemed, at their respective addresses as they last appear on the registration books of the City. Such mailing shall not be a condition precedent to such redemption, and failure to so mail or receive any such notice to any of such registered owners shall not affect the validity of the proceedings for the redemption of the Bonds. Notice of redemption having been given as aforesaid, the Bonds or portions thereof so to be redeemed shall, on the date fixed for redemption, become due and payable at the redemption price specified therein plus accrued interest to the redemption date and, upon presentation and surrender thereof at the place specified in such notice, such Bonds, or portions thereof, shall be paid at the redemption price, plus accrued interest to the redemption date. On and after the redemption date (unless the City shall default in the payment of the redemption price and accrued interest), such Bonds shall no longer be considered as outstanding hereunder. If moneys sufficient to pay the redemption price and accrued interest have not been made available by the City on the redemption date, the Bonds called for redemption shall continue to bear interest until paid at the same rate as they would have borne had they not been called for redemption.

During any period in which DTC (or any successor thereto) shall act as securities depository for the bonds, the notices referred to above shall be given only to such depository and not to the beneficial owners of the Bonds. Any failure of such depository to advise any of its participants or any failure of any participant to notify any beneficial owner of any notice of redemption shall not affect the validity of the redemption.

It is hereby certified that all acts, conditions and things required by the laws of the State of New Jersey to exist, to have happened or to have been performed, precedent to or in the issuance of this Bond or in the creation of the debt of which this Bond is evidence, exist, have happened and have been performed in regular and due form and manner as required by law; and that this Bond, together with all other indebtedness of the City is within every debt and other limit prescribed by the constitution and the statutes of the State of New Jersey.

Whenever the due date for payment of interest on or principal of this Bond shall be a Saturday, a Sunday, or a day on which banking institutions in the State of New Jersey are authorized by law to close (a "Holiday"), then the payment of such interest or principal need not be made on such date, but may be made on the next succeeding day which is not a Holiday, with the same force and effect as if made on the due date for payment of principal or interest.

For the prompt and full payment of the obligations of this Bond, the entire full faith and credit of the City are hereby irrevocably pledged.

IN WITNESS WHEREOF, the City of Jersey City, in the County of Hudson, New Jersey has caused this Bond to be signed in its name by the manual or facsimile signatures of its Mayor and Chief Financial Officer and its corporate seal, or a facsimile thereof, to be hereunto affixed, duly attested by the manual signature of its City Clerk.

(Seal)

**CITY OF JERSEY CITY, IN THE COUNTY  
OF HUDSON, NEW JERSEY**

Attest:

By: \_\_\_\_\_  
Mayor

\_\_\_\_\_  
City Clerk

By: \_\_\_\_\_  
Chief Financial Officer

## APPENDIX E-1

### FORM OF CONTINUING DISCLOSURE CERTIFICATE FOR THE BONDS

This Continuing Disclosure Certificate (the "Disclosure Certificate") is executed and delivered by the City of Jersey City, in the County of Hudson, New Jersey (the "Issuer") in connection with the issuance by the Issuer of \$\_\_\_\_\_ principal amount of its General Improvement Bonds, Series 2018 (the "Bonds"). The Bonds are being issued pursuant to Bond Ordinances (the "Ordinances") duly adopted by the Municipal Council of the Issuer (the "Council"), and a resolution duly adopted by the Municipal Council on November \_\_, 2018 (the "Resolution"). The Bonds are dated December 6, 2018 and shall mature on December 1 in the years 2019 through 2038, inclusive. The Issuer covenants and agrees as follows:

*Section 1. Purpose of the Disclosure Certificate.* This Disclosure Certificate is being executed and delivered by the Issuer for the benefit of the Bondholders and Beneficial Owners of the Bonds and in order to assist the Participating Underwriter in complying with the provisions of Rule 15c2-12(b)(5) promulgated by the Securities and Exchange Commission ("SEC") under the Securities Exchange Act of 1934, as the same may be amended from time to time ("Exchange Act").

*Section 2. Definitions.* In addition to the definitions set forth in the Resolution, which apply to any capitalized term used in this Disclosure Certificate unless otherwise defined in this Section, the following capitalized terms shall have the following meanings:

"Beneficial Owner" shall mean any person which (a) has the power, directly or indirectly, to vote or consent with respect to, or to dispose of ownership of, any Bonds (including persons holding Bonds through nominees, depositories or other intermediaries), or (b) is treated as the owner of any Bonds for federal income tax purposes.

"Bondholder" shall mean any person who is the registered owner of any Bond, including holders of beneficial interests in the Bonds.

"Continuing Disclosure Information" shall mean: (i) any notice required to be filed with the MSRB pursuant to Section 4 hereof; and (ii) any notice of an event required to be filed with the MSRB pursuant to Section 3(c) hereof.

"Dissemination Agent" shall mean the Issuer, or any successor Dissemination Agent designated in writing by the Issuer and which has filed with the Issuer a written acceptance of such designation.

"EMMA" shall mean the Electronic Municipal Market Access System ("EMMA"), an internet based filing system created and maintained by the MSRB in accordance with the SEC Release, pursuant to which issuers of tax-exempt bonds, including the Bonds, and other filers on behalf of the such issuers shall upload Continuing Disclosure Information to assist underwriters in complying with the Rule and to provide the general public with access to such Continuing Disclosure Information.



"Listed Events" shall mean any of the events listed in Section 5(a) of this Disclosure Certificate.

"MSRB" shall mean the Municipal Securities Rulemaking Board established pursuant to Section 15B(b)(1) of the Exchange Act.

"Participating Underwriter" shall mean any of the original underwriters of the Bonds required to comply with the Rule in connection with offering of the Bonds.

"Rule" shall mean Rule 15c2-12(b)(5) adopted by the Securities and Exchange Commission under the Securities Exchange Act of 1934, as the same may be amended from time to time.

"State" shall mean the State of New Jersey.

*Section 3. Provision of Annual Reports.*

(a) The Issuer shall, or shall cause the Dissemination Agent to, not later than nine (9) months after the end of its fiscal year, commencing with the report for the fiscal year ending December 31, 2018, provide to the MSRB an Annual Report which is consistent with the requirements of Section 4 of this Disclosure Certificate. The Annual Report may be submitted as a single document or as separate documents comprising a package, and may cross-reference other information as provided in Section 4 of this Disclosure Certificate; provided that the audited financial statements of the Issuer may be submitted separately from the balance of the Annual Report and later than the date required above for the filing of the Annual Report if they are not available by that date. If the Issuer's fiscal year changes, it shall give notice of such change in the same manner as for a Listed Event under Section 5(c). Any and all items that must be included in the Annual Report may be incorporated by reference from other information that is available to the public on EMMA, or that has been filed with the SEC.

(b) Not later than fifteen (15) Business Days prior to the date specified in subsection (a) for making available or providing the Annual Report, the Issuer shall provide the Annual Report to the Dissemination Agent (if other than the Issuer). If the Issuer is unable to provide to the MSRB an Annual Report by the date required in subsection (a), the Issuer shall send a notice to the MSRB in substantially the form attached as Exhibit A.

(c) The Dissemination Agent shall:

(i) determine each year prior to the date for making available or providing the Annual Report the name and address of each Repository, if any; and

(ii) if applicable, if the Dissemination Agent is other than the Issuer, file a report with the Issuer certifying that the Annual Report has been provided pursuant to this Disclosure Certificate, stating the date it was provided and listing all the Repositories to which it was provided.

*Section 4.*     Content of Annual Reports. The Issuer's Annual Report shall contain or include by reference the following:

1.     The audited financial statements of the Issuer for the prior fiscal year, prepared in accordance with generally accepted accounting standards (GAAS) as from time to time in effect, and as prescribed by the Division of Local Government Services in the Department of Community Affairs of the State pursuant to Chapter 5 of Title 40A of the New Jersey Statutes. If the Issuer's audited financial statements are not available by the time the Annual Report is required to be filed pursuant to Section 3(a), the Annual Report shall contain unaudited financial statements and the audited financial statements shall be filed in the same manner as the Annual Report when they become available.

2.     The financial information and operating data set forth in the Official Statement (including Appendix A thereto) dated November \_\_, 2018, prepared in connection with the sale of the Bonds under the following captions under the heading in the body of the Official Statement: "RECENT FINANCIAL RESULTS AND FINANCIAL OUTLOOK", and in Appendix A thereto under the following headings and captions, "CITY INDEBTEDNESS AND DEBT LIMITS – Debt Statements" (excluding the first four paragraphs thereunder), "CITY INDEBTEDNESS AND DEBT LIMITS – Other City-Related Obligations", "CITY INDEBTEDNESS AND DEBT LIMITS – Municipal Qualified Bond Act" (excluding the first six paragraphs thereunder), "CITY INDEBTEDNESS AND DEBT LIMITS – School Qualified Bond Act" (excluding the first six paragraphs thereunder), "CITY FINANCIAL INFORMATION – Current Fund—Revenues and Expenditures", "CITY REVENUES – Real Estate Tax" (table captioned "Analysis of Tax Rates and Percent Distribution Rate Per \$1,000 Assessed Valuation" only), "CITY REVENUES – Equalization Rate and Tax Collection Rates" (excluding the first paragraph thereof), "CITY REVENUES – Tax-Exempt Properties", "CITY REVENUES – Properties in Tax Abatement" (excluding the first three paragraphs thereunder), "CITY REVENUES – Delinquent Taxes" (excluding the first two paragraphs thereunder), "CITY REVENUES – State Aid Programs" (table captioned "State Aid to Jersey City" only), "CITY EXPENDITURES", "PENSION FINANCING – City Plans" (tables reflecting Annual Recommended Contributions and captioned "City Contributions to Employee Pensions" only), "PENSION FINANCING – Post Employment Benefits" and "LITIGATION – Pending Litigation" (table describing amounts in judgments and settlements only).

*Section 5.*     Reporting of Significant Events.

(a)     Pursuant to the provisions of this Section 5, the Issuer shall give, or cause to be given, notice of the occurrence of any of the following events with respect to the Bonds:

1.     principal and interest payment delinquencies;
2.     non-payment related defaults, if material;

3. unscheduled draws on the debt service reserves reflecting financial difficulties;
4. unscheduled draws on the credit enhancements reflecting financial difficulties;
5. substitution of the credit or liquidity providers or their failure to perform;
6. adverse tax opinions, the issuance by the Internal Revenue Service of proposed or final determinations of taxability, Notices of Proposed Issue (IRS Form 5701-TEB) or other material notices or determinations with respect to the tax status of the Bonds, or other material events affecting the tax-exempt status of the Bonds;
7. modifications to rights of Bondholders, if material;
8. Bond calls, if material, and tender offers;
9. defeasances;
10. release, substitution or sale of property securing repayment of the Bonds, if material;
11. rating changes;
12. bankruptcy, insolvency, receivership or similar events of the Issuer, which shall be considered to occur when any of the following occur: the appointment of a receiver, fiscal agent or similar officer for the Issuer in a proceeding under the U.S. Bankruptcy Code or in any other proceeding under state or federal law in which a court or governmental authority has assumed jurisdiction over substantially all of the assets or business of the Issuer, or if such jurisdiction has been assumed by leaving the existing governing body and officials or officers in possession but subject to the supervision and orders of a court or governmental authority, or the entry of an order confirming a plan of reorganization, arrangement or liquidation by a court or governmental authority having supervision or jurisdiction over substantially all of the assets or business of the Issuer;
13. the consummation of a merger, consolidation, or acquisition involving the Issuer or the sale of all or substantially all of the assets of the Issuer, other than in the ordinary course of business, the entry into a definitive agreement to undertake such an action or the termination of a definitive agreement relating to any such actions, other than pursuant to its terms, if material; and

14. appointment of a successor or additional trustee or the change of name of a trustee, if material.

(b) Whenever the Issuer obtains knowledge of the occurrence of a Listed Event described in subsection (a) for which the disclosure obligation is dependent upon materiality, the Issuer shall as soon as possible determine if such event would be material under applicable federal securities laws.

(c) If disclosure of a Listed Event is required, the Issuer shall in a timely manner not in excess of ten business days after the occurrence of the event, file a notice of such occurrence with the MSRB in an electronic format as prescribed by the MSRB. All documents provided to the MSRB shall be accompanied by identifying information as prescribed by the MSRB.

*Section 6. Termination of Reporting Obligation.* The Issuer's obligations under this Disclosure Certificate shall terminate upon the legal defeasance, prior redemption or payment in full of all of the Bonds. If such termination occurs prior to the final maturity of the Bonds, the Issuer shall give notice of such termination in the same manner as for a Listed Event under Section 5(c).

*Section 7. Dissemination Agent.* The Issuer may, from time to time, appoint or engage a Dissemination Agent to assist it in carrying out its obligations under this Disclosure Certificate, and may discharge any such Dissemination Agent, with or without appointing a successor Dissemination Agent. The Dissemination Agent shall not be responsible in any manner for the content of any notice or report prepared by the Issuer pursuant to this Disclosure Certificate. The initial Dissemination Agent shall be the Issuer.

*Section 8. Amendment; Waiver.* Notwithstanding any other provision of this Disclosure Certificate, the Issuer may amend this Disclosure Certificate, and any provision of this Disclosure Certificate may be waived, provided that the following conditions are satisfied:

(a) If the amendment or waiver relates to the provisions of Section 3, it may only be made in connection with a change in circumstances that arises from a change in legal requirements, change in law, or change in the identity, nature or status of an obligated person with respect to the Bonds, or the type of business conducted;

(b) The undertaking, as amended or taking into account such waiver, would, in the opinion of nationally recognized bond counsel, have complied with the requirements of the Rule at the time of the original issuance of the Bonds, after taking into account any amendments or interpretations of the Rule, as well as any change in circumstances; and

(c) The amendment or waiver does not, in the opinion of nationally recognized bond counsel, materially impair the interests of the Bondholders or Beneficial Owners of the Bonds.

In the event of any amendment or waiver of a provision of this Disclosure Certificate, the Issuer shall describe such amendment in the next Annual Report, and shall include, as applicable, a narrative explanation of the reason for the amendment or waiver and its impact on the type (or

in the case of a change of accounting principles, on the presentation) of financial information or operating data being presented by the Issuer. In addition, if the amendment relates to the accounting principles to be followed in preparing financial statements, (i) notice of such change shall be given in the same manner as for a Listed Event under Section 5(c), and (ii) the Annual Report for the year in which the change is made should present a comparison (in narrative form and also, if feasible, in quantitative form) between the financial statements as prepared on the basis of the new accounting principles and those prepared on the basis of the former accounting principles.

*Section 9.* Additional Information. Nothing in this Disclosure Certificate shall be deemed to prevent the Issuer from disseminating any other information, using the means of dissemination set forth in this Disclosure Certificate or any other means of communication, or including any other information in any notice of occurrence of a Listed Event, in addition to that which is required by this Disclosure Certificate. If the Issuer chooses to include any information in any Annual Report or notice of occurrence of a Listed Event in addition to that which is specifically required by this Disclosure Certificate, the Issuer shall have no obligation under this Disclosure Certificate to update such information or include it in any future Annual Report or notice of occurrence of a Listed Event.

*Section 10.* Default. In the event of a failure of the Issuer to comply with any provision of this Disclosure Certificate any Bondholder or Beneficial Owner of the Bonds may take such actions as may be necessary and appropriate, including seeking mandamus or specific performance by court order, to cause the Issuer to comply with its obligations under this Disclosure Certificate. A default under this Disclosure Certificate shall not be deemed an Event of Default on the Bonds, and the sole remedy under this Disclosure Certificate in the event of any failure of the Issuer to comply with this Disclosure Certificate shall be an action to compel performance.

*Section 11.* Duties, Immunities and Liabilities of Dissemination Agent. The Dissemination Agent shall have only such duties as are specifically set forth in this Disclosure Certificate, and the Issuer agrees to indemnify and save the Dissemination Agent, its officers, directors, employees and agents, harmless against any loss, expense and liabilities which it may incur arising out of or in the exercise or performance of its powers and duties hereunder, including the costs and expenses (including reasonable attorneys' fees) of defending against any claim of liability, but excluding liabilities due to the Dissemination Agent's gross negligence or wilful misconduct. The obligations of the Issuer under this Section 11 shall survive resignation or removal of the Dissemination Agent and payment of the Bonds.

*Section 12.* Beneficiaries. This Disclosure Certificate shall inure solely to the benefit of the Issuer, the Dissemination Agent, the Participating Underwriters and the Bondholders and Beneficial Owners from time to time of the Bonds, and shall create no rights in any other person or entity.

Dated: \_\_\_\_\_, 2018

CITY OF JERSEY CITY, IN THE COUNTY OF  
HUDSON, NEW JERSEY

By: \_\_\_\_\_  
Donna L. Mauer, Chief Financial Officer

**EXHIBIT A**

**NOTICE OF FAILURE TO FILE ANNUAL REPORT**

Name of Issuer: City of Jersey City, in the County of Hudson, New Jersey

Name of Bond Issue: \$ \_\_\_\_\_ General Improvement Bonds, Series 2018

Date of Issuance: \_\_\_\_\_, 2018

NOTICE IS HEREBY GIVEN that the Issuer has not provided an Annual Report with respect to the above-named Bonds as required by Section 3(a) of the Continuing Disclosure Certificate dated \_\_\_\_\_, 2018. The Issuer anticipates that the Annual Report will be filed by \_\_\_\_\_, 20\_\_.

Dated: \_\_\_\_\_, 20\_\_

CITY OF JERSEY CITY, IN THE COUNTY OF HUDSON, NEW JERSEY

By: \_\_\_\_\_

Name:

Title:

## APPENDIX E-2

### FORM OF CONTINUING DISCLOSURE CERTIFICATE FOR THE NOTES

This Continuing Disclosure Certificate (the "Disclosure Certificate") is executed and delivered by the City of Jersey City, in the County of Hudson, New Jersey (the "Issuer") in connection with the issuance by the Issuer of its \$\_\_\_\_\_ Special Emergency Notes, Series 2018E (Federally Taxable) (the "Series 2018E Notes"), its \$\_\_\_\_\_ Special Emergency Notes, Series 2018F (the "Series 2018F Notes"), its \$\_\_\_\_\_ Bond Anticipation Notes, Series 2018G (the "Series 2018G Notes") and its \$\_\_\_\_\_ Redevelopment Bond Anticipation Notes, Series 2018H (the "Series 2018H Notes", and together with the Series 2018E Notes, the Series 2018F Notes and the Series 2018G Notes, the "Notes"). The Notes are being issued pursuant to ordinances and a resolution duly adopted by the Municipal Council. The Issuer covenants and agrees as follows:

**SECTION 1. Purpose of the Disclosure Certificate.** This Disclosure Certificate is being executed and delivered by the Issuer for the benefit of the Noteholders and Beneficial Owners of the Notes and in order to assist the Participating Underwriter in complying with the provisions of Rule 15c2-12(b)(5) promulgated by the Securities and Exchange Commission ("SEC") under the Securities Exchange Act of 1934, as the same may be amended from time to time ("Exchange Act").

**SECTION 2. Definitions.** In addition to the definitions set forth in the Resolution, which apply to any capitalized term used in this Disclosure Certificate unless otherwise defined in this Section, the following capitalized terms shall have the following meanings:

"Beneficial Owner" shall mean any person which (a) has the power, directly or indirectly, to vote or consent with respect to, or to dispose of ownership of, any Notes (including persons holding Notes through nominees, depositories or other intermediaries), or (b) is treated as the owner of any Notes for federal income tax purposes.

"Continuing Disclosure Information" shall mean: (i) any notice required to be filed with the MSRB pursuant to Section 4 hereof; and (ii) any notice of an event required to be filed with the MSRB pursuant to Section 3(c) hereof.

"Dissemination Agent" shall mean the Issuer, or any successor Dissemination Agent designated in writing by the Issuer and which has filed with the Issuer a written acceptance of such designation.

"Listed Events" shall mean any of the events listed in Section 3(a) of this Disclosure Certificate.

"MSRB" shall mean the Municipal Securities Rulemaking Board established pursuant to Section 15B(b)(1) of the Exchange Act.



"Noteholder" shall mean any person who is the registered owner of any Note, including holders of beneficial interests in the Notes.

"Participating Underwriter" shall mean any of the original underwriters of the Notes required to comply with the Rule in connection with offering of the Notes.

"Rule" shall mean Rule 15c2-12(b)(5) adopted by the Securities and Exchange Commission under the Exchange Act.

"State" shall mean the State of New Jersey.

SECTION 3. Reporting of Significant Events.

(a) Pursuant to the provisions of this Section 3, the Issuer shall give, or cause to be given, notice of the occurrence of any of the following events with respect to the Notes:

1. principal and interest payment delinquencies;
2. non-payment related defaults, if material;
3. unscheduled draws on the debt service reserves reflecting financial difficulties;
4. unscheduled draws on the credit enhancements reflecting financial difficulties;
5. substitution of the credit or liquidity providers or their failure to perform;
6. adverse tax opinions, the issuance by the Internal Revenue Service of proposed or final determinations of taxability, Notices of Proposed Issue (IRS Form 5701-TEB) or other material notices or determinations with respect to the tax status of the Notes, or other material events affecting the tax-exempt status of the Notes;
7. modifications to rights of Noteholders, if material;
8. Note calls, if material, and tender offers;
9. defeasances;
10. release, substitution or sale of property securing repayment of the Notes, if material;
11. rating changes;

12. bankruptcy, insolvency, receivership or similar events of the Issuer, which shall be considered to occur when any of the following occur: the appointment of a receiver, fiscal agent or similar officer for the Issuer in a proceeding under the U.S. Bankruptcy Code or in any other proceeding under state or federal law in which a court or governmental authority has assumed jurisdiction over substantially all of the assets or business of the Issuer, or if such jurisdiction has been assumed by leaving the existing governing body and officials or officers in possession but subject to the supervision and orders of a court or governmental authority, or the entry of an order confirming a plan of reorganization, arrangement or liquidation by a court or governmental authority having supervision or jurisdiction over substantially all of the assets or business of the Issuer;
13. the consummation of a merger, consolidation, or acquisition involving the Issuer or the sale of all or substantially all of the assets of the Issuer, other than in the ordinary course of business, the entry into a definitive agreement to undertake such an action or the termination of a definitive agreement relating to any such actions, other than pursuant to its terms, if material; and
14. appointment of a successor or additional trustee or the change of name of a trustee, if material.

(b) Whenever the Issuer obtains knowledge of the occurrence of a Listed Event described in subsection (a) for which the disclosure obligation is dependent upon materiality, the Issuer shall as soon as possible determine if such event would be material under applicable federal securities laws.

(c) If disclosure of a Listed Event is required, the Issuer shall in a timely manner not in excess of ten business days after the occurrence of the event, file a notice of such occurrence with the MSRB in an electronic format as prescribed by the MSRB. All documents provided to the MSRB shall be accompanied by identifying information as prescribed by the MSRB.

SECTION 4. Termination of Reporting Obligation. The Issuer's obligations under this Disclosure Certificate shall terminate upon the legal defeasance, prior redemption or payment in full of all of the Notes. If such termination occurs prior to the final maturity of the Notes, the Issuer shall give notice of such termination in the same manner as for a Listed Event under Section 3(c).

SECTION 5. Dissemination Agent. The Issuer may, from time to time, appoint or engage a Dissemination Agent to assist it in carrying out its obligations under this Disclosure Certificate, and may discharge any such Dissemination Agent, with or without appointing a successor Dissemination Agent. The Dissemination Agent shall not be responsible in any

manner for the content of any notice or report prepared by the Issuer pursuant to this Disclosure Certificate. The initial Dissemination Agent shall be the Issuer.

SECTION 6. Amendment; Waiver. Notwithstanding any other provision of this Disclosure Certificate, the Issuer may amend this Disclosure Certificate, and any provision of this Disclosure Certificate may be waived, provided that the following conditions are satisfied:

(a) If the amendment or waiver relates to the provisions of Section 3, it may only be made in connection with a change in circumstances that arises from a change in legal requirements, change in law, or change in the identity, nature or status of an obligated person with respect to the Notes, or the type of business conducted;

(b) The undertaking, as amended or taking into account such waiver, would, in the opinion of nationally recognized bond counsel, have complied with the requirements of the Rule at the time of the original issuance of the Notes, after taking into account any amendments or interpretations of the Rule, as well as any change in circumstances; and

(c) The amendment or waiver does not, in the opinion of nationally recognized bond counsel, materially impair the interests of the Noteholders or Beneficial Owners of the Notes.

In the event of any amendment or waiver of a provision of this Disclosure Certificate, the Issuer shall describe such amendment in the same manner as for a Listed Event under Section 3(a), and shall include a narrative explanation of the reason for the amendment or waiver.

SECTION 7. Additional Information. Nothing in this Disclosure Certificate shall be deemed to prevent the Issuer from disseminating any other information, using the means of dissemination set forth in this Disclosure Certificate or any other means of communication, or including any other notice of occurrence of a Listed Event, in addition to that which is required by this Disclosure Certificate. If the Issuer chooses to include any information in any notice of occurrence of a Listed Event in addition to that which is specifically required by this Disclosure Certificate, the Issuer shall have no obligation under this Certificate to update such information or include it in any future notice of occurrence of a Listed Event.

SECTION 8. Default. In the event of a failure of the Issuer to comply with any provision of this Disclosure Certificate, any Noteholder or Beneficial Owner of the Notes may take such actions as may be necessary and appropriate, including seeking mandamus or specific performance by court order, to cause the Issuer to comply with its obligations under this Disclosure Certificate. A default under this Disclosure Certificate shall not be deemed an Event of Default on the Notes, and the sole remedy under this Disclosure Certificate in the event of any failure of the Issuer to comply with this Disclosure Certificate shall be an action to compel performance.

SECTION 9. Duties, Immunities and Liabilities of Dissemination Agent. The Dissemination Agent shall have only such duties as are specifically set forth in this Disclosure Certificate, and the Issuer agrees to indemnify and save the Dissemination Agent, its officers,

directors, employees and agents, harmless against any loss, expense and liabilities which it may incur arising out of or in the exercise or performance of its powers and duties hereunder, including the costs and expenses (including attorneys fees) of defending against any claim of liability, but excluding liabilities due to the Dissemination Agent's gross negligence or willful misconduct. The obligations of the Issuer under this Section shall survive resignation or removal of the Dissemination Agent and payment of the Notes.

SECTION 10. Beneficiaries. This Disclosure Certificate shall inure solely to the benefit of the Issuer, the Dissemination Agent, the Participating Underwriter and the Noteholders and Beneficial Owners from time to time of the Notes, and shall create no rights in any other person or entity.

Date: \_\_\_\_\_, 2018

CITY OF JERSEY CITY, IN THE COUNTY OF  
HUDSON, NEW JERSEY

By: \_\_\_\_\_  
Donna L. Mauer, Chief Financial Officer

**APPENDIX C**  
**FORMS OF BOND COUNSEL OPINIONS**

**APPENDIX D**  
**FORMS OF CONTINUING DISCLOSURE CERTIFICATES**

**EXHIBIT A**

This is a Preliminary Official Statement and the information contained herein is subject to completion, amendment or other change without notice. The securities described herein may not be sold nor may offers to buy be accepted prior to the time the Official Statement is delivered in final form. Under no circumstances shall this Preliminary Official Statement constitute an offer to sell or the solicitation of an offer to buy nor shall there be any sale of these securities in any jurisdiction in which such offer, solicitation or sale would be unlawful prior to registration or qualification under the applicable securities laws of any such jurisdiction.

PRELIMINARY OFFICIAL STATEMENT DATED \_\_\_\_\_, 2018

This cover page contains certain information for quick reference only. It is not a summary of this issue. Investors must read the entire Official Statement to obtain information essential to the making of an informed investment decision.

**NEW ISSUE**

**RATINGS: See "RATINGS" herein**

*In the opinion of Bond Counsel, assuming continuing compliance with the provisions of the Internal Revenue Code of 1986, as amended (the "Code") applicable to the Bonds and the Tax-Exempt Notes and subject to certain provisions of the Code which are described herein, under laws, regulations, rulings and judicial decisions existing on the date of the original delivery of the Bonds and the Tax-Exempt Notes, interest on the Bonds and the Tax-Exempt Notes is excluded from gross income of the owners thereof for federal income tax purposes under Section 103 of the Code. In the further opinion of Bond Counsel, interest on the Bonds and the Tax-Exempt Notes is not treated as a preference item for purposes of the alternative minimum tax imposed by the Code on individuals or corporations; however, for taxable years that began before January 1, 2018, interest on the Bonds and the Tax-Exempt Notes will be included in "adjusted current earnings" in computing alternative minimum taxable income for purposes of the alternative minimum tax imposed by the Code on certain corporations. The corporate alternative minimum tax has been repealed for taxable years beginning on or after January 1, 2018. Interest on the Taxable Notes is not excluded from gross income of the owners thereof for federal income tax purposes. Under the laws of the State of New Jersey, as enacted and construed on the date of the original delivery of the Bonds and the Notes, interest on the Bonds and the Notes and gain from the sale thereof are excludable from gross income under the New Jersey Gross Income Tax Act. See "TAX MATTERS" herein.*

**CITY OF JERSEY CITY  
in the County of Hudson, New Jersey**

**\$9,447,000\* GENERAL IMPROVEMENT BONDS, SERIES 2018  
and  
\$51,223,983 NOTES**

- Consisting of:**  
**\$19,200,000 SPECIAL EMERGENCY NOTES, SERIES 2018E (FEDERALLY TAXABLE),**  
**\$3,000,000 SPECIAL EMERGENCY NOTES, SERIES 2018F,**  
**\$14,023,983 BOND ANTICIPATION NOTES, SERIES 2018G**  
**and**  
**\$15,000,000 REDEVELOPMENT BOND ANTICIPATION NOTES, SERIES 2018H**

**Dated: Date of Delivery**

**Due: Bonds: December 1, as shown on inside front cover  
Notes: December 6, 2019, as shown below**

The \$9,447,000\* General Improvement Bonds, Series 2018 (the "Bonds"), the \$19,200,000 Special Emergency Notes, Series 2018E (Federally Taxable) (the "Taxable Notes" or the "Series 2018E Notes"), the \$3,000,000 Special Emergency Notes, Series 2018F (the "Series 2018F Notes"), the \$14,023,983 Bond Anticipation Notes, Series 2018G (the "Series 2018G Notes") and the \$15,000,000 Redevelopment Bond Anticipation Notes, Series 2018H (the "Series 2018H Notes", and together with the Series 2018F Notes, the "Tax-Exempt Notes"), will be issued by the City of Jersey City, in the County of Hudson, New Jersey (the "City"). The Taxable Notes and the Tax-Exempt Notes are hereinafter referred to as the "Notes".

The Bonds will be issued as fully registered Bonds and, when issued, will be registered in the name of and held by Cede & Co., as nominee for The Depository Trust Company, New York, New York ("DTC"). Purchases of the Bonds will be made in book-entry-only form (without certificates) in denominations of \$5,000 or more. So long as DTC, or its nominee Cede & Co., is the registered owner of the Bonds, payments of the principal of and interest on the Bonds of such series are to be made directly to Cede & Co., which is to remit such payments to DTC participants, which in turn is to remit such payments to the beneficial owners of the Bonds (see "DESCRIPTION OF THE BONDS AND THE NOTES – Book-Entry Only System" herein). Interest on the Bonds is payable semiannually on June 1 and December 1 in each year until maturity or prior redemption, as applicable, commencing June 1, 2019.

The Bonds are subject to redemption prior to their stated maturities as more fully described herein. See "DESCRIPTION OF THE BONDS AND THE NOTES – Redemption of the Bonds and Notes" herein.

\* Preliminary, subject to change.



The Bonds constitute general obligations of the City and the full faith and credit and unlimited taxing power of the City are pledged to the payment of the principal of, applicable premium, if any, and interest on the Bonds. The City shall be required to levy *ad valorem* taxes upon all taxable property within the City for the payment of the principal of and interest on the Bonds without limitation as to rate or amount. The Bonds are not a debt or obligation, legal, moral, or otherwise, of the State of New Jersey, or any county, municipality or political subdivision thereof, other than the City.

The Notes will be issued as fully registered Notes in the form of one certificate for the aggregate principal amount of each series of Notes and, when issued, will be registered in the name of and held by Cede & Co., as nominee for DTC. Purchases of the Notes of each series will be made in book-entry-only form (without certificates) in denominations of \$5,000 or more. So long as DTC, or its nominee Cede & Co., is the registered owner of the Notes, payments of the principal of and interest on the Notes are to be made directly to Cede & Co., which is to remit such payments to DTC participants, which in turn is to remit such payments to be beneficial owners of the Notes (see "DESCRIPTION OF THE BONDS AND NOTES – Book Entry Only System" herein). Interest on the Notes is payable at maturity. The Notes are not subject to redemption prior to their maturity.

\$19,200,000 \_\_\_\_\_%, Special Emergency Notes, Series 2018E (Federally Taxable), Due December 6, 2019– Price \_\_\_\_\_%  
\$3,000,000 \_\_\_\_\_%, Special Emergency Notes, Series 2018F, Due December 6, 2019– Price \_\_\_\_\_%  
\$14,023,983 \_\_\_\_\_%, Bond Anticipation Notes, Series 2018G, Due December 6, 2019– Price \_\_\_\_\_%  
\$15,000,000 \_\_\_\_\_%, Redevelopment Bond Anticipation Notes, Series 2018H, Due December 6, 2019– Price \_\_\_\_\_%

The Notes constitute general obligations of the City, and the full faith and credit and unlimited taxing power of the City are pledged to the payment of the principal of, applicable premium, if any, and interest on the Notes. The City shall be required to levy *ad valorem* taxes upon all taxable real property within the City for the payment of the principal of and interest on the Notes without limitation as to rate or amount. The Notes are not a debt or obligation, legal, moral, or otherwise, of the State of New Jersey, or any county, municipality or political subdivision thereof, other than the City.

The Bonds and Notes are offered when, as and if issued by the City and delivered to the respective purchasers, subject to the approval of legality by GluckWalrath LLP, Trenton, New Jersey, Bond Counsel, and other conditions described herein. NW Financial Group, LLC, Hoboken, New Jersey, has served as financial advisor in connection with the issuance of the Bonds and Notes. It is expected that the Bonds and the Notes will be available for delivery on or about December 6, 2018. The Bonds and the Notes are to be delivered through the facilities of DTC in Jersey City, New Jersey.

**ELECTRONIC AND FAXED PROPOSALS WILL BE RECEIVED FOR THE BONDS AND NOTES ON NOVEMBER 20, 2018 UNTIL 11:00 AM FOR THE BONDS, UNTIL 11:30 AM FOR THE TAX-EXEMPT NOTES AND UNTIL 11:45 AM FOR THE TAXABLE NOTES. FOR MORE INFORMATION ON HOW TO BID, PLEASE REFER TO THE ENCLOSED NOTICES OF SALE.**

**MATURITIES, PAR AMOUNTS\*, INTEREST RATES, YIELDS  
AND CUSIP NUMBERS\*\***

**\$9,447,000\* General Improvement Bonds, Series 2018**

<u>December 1</u>	<u>Bonds*</u>	<u>Interest Rate</u>	<u>Yield</u>	<u>CUSIP Number**</u>
		%	%	
2019	\$360,000			476576__
2020	365,000			476576__
2021	370,000			476576__
2022	380,000			476576__
2023	390,000			476576__
2024	400,000			476576__
2025	415,000			476576__
2026	425,000			476576__
2027	440,000			476576__
2028	450,000			476576__
2029	465,000			476576__
2030	480,000			476576__
2031	500,000			476576__
2032	515,000			476576__
2033	530,000			476576__
2034	550,000			476576__
2035	570,000			476576__
2036	590,000			476576__
2037	615,000			476576__
2038	637,000			476576__

\*Preliminary, subject to change.

\*\* CUSIP is a registered trademark of the American Bankers Association. CUSIP numbers are provided by Standard & Poor's CUSIP Service Bureau, a division of The McGraw-Hill Companies, Inc. The CUSIP Numbers listed above are being provided solely for the convenience of Bondholders only at the time of issuance of the Bonds and the City does not make any representations with respect to such numbers or undertake any responsibility for their accuracy now or at any time in the future. The CUSIP number for a specified maturity is subject to being changed after the issuance of the Bonds as a result of various subsequent actions including, but not limited to, a refunding in whole or in part of such maturity or as a result of the procurement of secondary market portfolio insurance or other similar enhancement by investors that is applicable to all or a portion of certain maturities of the Bonds.

**CITY OF JERSEY CITY,  
IN THE COUNTY OF HUDSON, STATE OF NEW JERSEY**

**MAYOR**

**Steven M. Fulop**

**CITY COUNCIL**

Rolando R. Lavarro	Council President
Daniel Rivera	Councilman-at-Large
Joyce Waterman	Councilwoman-at-Large
Denise Ridley	Ward A Councilwoman
Mira Prinz-Avery	Ward B Councilwoman
Richard Boggiano	Ward C Councilman
Michael Yun	Ward D Councilman
James Solomon	Ward E Councilman
Jermaine Robinson	Ward F Councilwoman

**CITY OFFICIALS**

Brian Platt, Business Administrator  
Peter J. Baker, Corporation Counsel  
Annisia R. Ciallone, Director of Housing, Economic Development and Commerce  
Donna L. Mauer, Chief Financial Officer  
Robert Byrne, City Clerk

**BOND COUNSEL**

GluckWalrath LLP  
Trenton, New Jersey

**MUNICIPAL ADVISOR**

NW Financial Group, LLC  
Hoboken, New Jersey

**INDEPENDENT AUDITORS**

Donohue, Gironda, Doria & Tomkins, LLC  
Bayonne, New Jersey

No broker, dealer, salesperson or other person has been authorized by the City or the Underwriters to give any information or to make any representations with respect to the Bonds and the Notes other than those contained in this Official Statement, and, if given or made, such other information or representations must not be relied upon as having been authorized by the City or the Underwriters. The information contained herein has been obtained from the City, DTC and other sources which are believed to be reliable; however, such information is not guaranteed as to accuracy or completeness, and is not to be construed as a representation or warranty of the City or the Underwriters. The information and expressions of opinion herein are subject to change without notice and neither the delivery of this Official Statement nor any sale made hereunder shall, under any circumstances, create any implication that there has been no change in any of the information herein since the date hereof, or the date as of which such information is given, if earlier.

References in this Official Statement to laws, rules, regulations, ordinances, resolutions, agreements, reports and documents do not purport to be comprehensive or definitive. All references to such documents are qualified in their entirety by reference to the particular document, the full text of which may contain qualifications of and exceptions to statements made herein, and copies of which may be inspected at the offices of the City during normal business hours. References to website addresses presented herein are for informational purposes only and may be in the form of a hyperlink solely for the reader's convenience. Unless specified otherwise, such websites and the information or links contained therein are not incorporated into, and are not part of, this Official Statement.

The order and placement of materials in this Official Statement, including the Appendices, are not deemed to be a determination of relevance, materiality or importance, and this Official Statement, including the Appendices, must be considered in its entirety.

In order to facilitate the distribution of the Bonds and the Notes, the Underwriters may engage in transactions intended to stabilize the price of the Bonds and the Notes at a level above that which might otherwise prevail in the open market. Such stabilizing, if commenced, may be discontinued at any time. The prices at which the Bonds and the Notes are offered to the public by the Underwriters and the yields resulting therefrom may vary from the initial public offering prices or yields shown on the cover and the inside front cover page hereof. In addition, the Underwriters may allow concessions or discounts from such initial public offering prices or yields to dealers and others.

This Official Statement does not constitute an offer to sell or the solicitation of an offer to buy, nor shall there be any sale of the Bonds and the Notes in any jurisdiction in which it is unlawful for any person to make such an offer, solicitation or sale.

The Underwriters have reviewed the information in this Official Statement in accordance with and as part of its responsibilities to investors under the Federal securities laws as applied to the facts and circumstances of this transaction, but the Underwriters do not guaranty the accuracy or completeness of such information.

Table of Contents

	<u>Page #</u>
INTRODUCTION.....	1
DESCRIPTION OF THE BONDS AND THE NOTES .....	2
General Description of the Bonds and the Notes .....	2
Book-Entry Only System .....	2
Discontinuation of Book-Entry Only System .....	4
Redemption of the Bonds and the Notes.....	4
AUTHORIZATION OF THE BONDS AND THE NOTES .....	5
PURPOSE OF THE BONDS AND APPLICATION OF PROCEEDS .....	6
PURPOSE OF THE NOTES AND APPLICATION OF PROCEEDS .....	6
SECURITY AND SOURCE OF PAYMENT .....	7
NO DEFAULT .....	7
MARKET PROTECTION.....	7
THE NJCU REDEVELOPMENT PROJECTS .....	7
THE BAYFRONT REDEVELOPMENT PROJECT .....	8
CITY OF JERSEY CITY.....	8
RECENT FINANCIAL RESULTS AND FINANCIAL OUTLOOK .....	9
Financial Overview .....	9
Financial Results .....	9
CERTAIN STATUTORY PROVISIONS FOR THE PROTECTION.....	9
OF GENERAL OBLIGATION DEBT .....	9
Local Bond Law (N.J.S.A. 40A:2-1 et seq.) .....	9
The Local Fiscal Affairs Law (N.J.S.A. 40A:5-1 et seq.).....	10
Debt Limits (N.J.S.A. 40A:2-6).....	10
Exceptions to Debt Limits - Extensions of Credit (N.J.S.A. 40A:2-7).....	10
Short-Term Financing .....	10
MUNICIPAL BUDGET .....	11
The Local Budget Law (N.J.S.A. 40A:4-1 et seq.).....	11
Real Estate Taxes.....	11
Miscellaneous Revenues .....	12
Limitations on Expenditures (“Cap Law”) and Property Tax Levy Cap .....	12
Deferral of Current Expenses.....	12
Budget Transfers .....	13
Fiscal Year .....	13
Budget Process .....	13
TAX INFORMATION ON THE CITY .....	13
Tax Appeals .....	14
DEBT INFORMATION ON THE CITY.....	14
Debt Statements .....	14
TAX MATTERS.....	15
Federal Income Taxes .....	15
Original Issue Premium .....	15
Original Issue Discount.....	15
Certain Federal Tax Considerations.....	16
Backup Withholding .....	16

Changes in Law and Post-Issuance Events .....	16
Taxable Notes .....	17
State Taxes .....	17
LITIGATION .....	18
APPROVAL OF LEGAL PROCEEDINGS .....	18
MUNICIPAL BANKRUPTCY .....	18
CONTINUING DISCLOSURE .....	19
LEGALITY FOR INVESTMENT .....	19
MUNICIPAL ADVISOR .....	19
UNDERWRITING .....	20
RATINGS .....	20
CLOSING CERTIFICATES .....	20
PREPARATION OF OFFICIAL STATEMENT .....	21
FINANCIAL STATEMENTS .....	21
ADDITIONAL INFORMATION .....	21
MISCELLANEOUS .....	21

APPENDIX A – CERTAIN INFORMATION REGARDING THE CITY OF JERSEY CITY
APPENDIX B – INDEPENDENT AUDITORS' REPORT AND AUDITED FINANCIAL STATEMENTS
APPENDIX C – FORMS OF BOND COUNSEL OPINIONS
APPENDIX D – FORMS OF CONTINUING DISCLOSURE CERTIFICATES

**OFFICIAL STATEMENT  
of the  
CITY OF JERSEY CITY,  
IN THE COUNTY OF HUDSON, STATE OF NEW JERSEY**

**\$9,447,000\* GENERAL IMPROVEMENT BONDS, SERIES 2018  
and  
\$51,223,983 NOTES**

**Consisting of:  
\$19,200,000 SPECIAL EMERGENCY NOTES, SERIES 2018E (FEDERALLY  
TAXABLE),  
\$3,000,000 SPECIAL EMERGENCY NOTES, SERIES 2018F,  
\$14,023,983 BOND ANTICIPATION NOTES, SERIES 2018G  
and  
\$15,000,000 REDEVELOPMENT BOND ANTICIPATION NOTES, SERIES 2018H**

**INTRODUCTION**

The purpose of this Official Statement is to provide certain information regarding the financial and economic condition of the City of Jersey City (the "City"), in the County of Hudson (the "County"), State of New Jersey (the "State" or "New Jersey") in connection with the sale and issuance by the City of its \$9,447,000\* General Improvement Bonds, Series 2018 (the "Bonds"), \$19,200,000 Special Emergency Notes, Series 2018E (Federally Taxable) (the "Taxable Notes" or the "Series 2018E Notes"), \$3,000,000 Special Emergency Notes, Series 2018F (the "Series 2018F Notes"), \$14,023,983 Bond Anticipation Notes, Series 2018G (the "Series 2018G Notes") and \$15,000,000 Redevelopment Bond Anticipation Notes, Series 2018H (the "Series 2018H Notes", and together with the Series 2018F Notes and the Series 2018G Notes, the "Tax-Exempt Notes"). The Taxable Notes and the Tax-Exempt Notes are hereinafter collectively referred to as the "Notes". This Official Statement (the "Official Statement") which includes the cover page, the inside front cover pages and the Appendices attached hereto, has been authorized by the Mayor and City Council to be distributed in connection with the sale of the Bonds and the Notes and has been executed by and on behalf of the City by the Business Administrator and the Chief Financial Officer.

This Official Statement contains specific information relating to the Bonds and the Notes including their general description, certain matters affecting the financing, certain legal matters, historical financial information and other information pertinent to the sale, issuance and delivery of the Bonds and the Notes. This Official Statement should be read in its entirety.

All financial and other information presented herein has been provided by the City from its records, except for information expressly attributed to other sources. The presentation of information is intended to show recent historical information and, but only to the extent specifically provided herein, certain projections of the immediate future, and is not necessarily indicative of future or continuing trends in the financial position or other affairs of the City.

This Official Statement is "deemed final", as of its date, within the meaning of Rule 15c2-12 promulgated by the Securities and Exchange Commission (the "Rule").

---

\* Preliminary, subject to change  
(00094872;v4/ 01-380/120)

## DESCRIPTION OF THE BONDS AND THE NOTES

### General Description of the Bonds and the Notes

The Bonds shall be dated the date of delivery and shall mature on December 1 in each of the years and in the principal amounts as set forth on the inside front cover page hereof. The Bonds shall bear interest from the date of delivery and shall be payable on December 1 and June 1 in each year until maturity or prior redemption, as applicable, commencing June 1, 2019, at the rates shown on the inside front cover page hereof. The Bonds will be issued as fully registered book-entry only bonds in the form of one certificate for each year of maturity of the Bonds in the aggregate principal amount of such maturity. The Bonds may be purchased in book-entry only form in the amount of \$5,000 each or more, through book-entries made on the books and records of The Depository Trust Company, New York, New York ("DTC") and its participants. So long as DTC or its nominee, Cede & Co., or any successor or assign, is the registered owner of the Bonds, payments of the principal of and interest on the Bonds will be made by the City or the Paying Agent (as defined herein) directly to Cede & Co. or any successor or assign, as nominee for DTC. Interest on the Bonds is calculated on the basis of twelve (12) thirty (30) day months in a three hundred sixty (360) day year and will be credited to the participants of DTC as listed on the records of DTC as of the close of business on each May 15 and November 15 preceding an interest payment date.

The Notes of each series shall be dated the date of delivery and mature on December 6, 2019. Interest on the Notes will be computed on the basis of a 360-day year of twelve 30-day months. Principal of and interest on the Notes will be paid when due and at maturity at the office of the Chief Financial Officer of the City (unless a Paying Agent is appointed by the City). So long as DTC or its nominee is the registered owner of the Notes, payments of the principal of and interest on the Notes are to be made directly to Cede & Co., as nominee for DTC; disbursements of such payments to the DTC Participants is the responsibility of DTC, and disbursements of such payments to the beneficial owners of the Notes is the responsibility of the DTC Participants. The Notes will be issued in fully registered form in the denomination of \$5,000 or more, and, under certain circumstances, are exchangeable for one or more fully registered Notes of like principal amount, series and maturity in the denomination of \$5,000 or more.

### Book-Entry Only System

The description which follows of the procedures and recordkeeping with respect to beneficial ownership interest in the Bonds and the Notes of each series, payment of principal and interest and other payments on the Bonds and the Notes to Direct and Indirect Participants (defined below) or Beneficial Owners (defined below), confirmation and transfer of beneficial ownership interests in the Bonds and the Notes and other related transactions by and between DTC, Direct and Indirect Participants and Beneficial Owners, is based on certain information furnished by DTC to the City. Accordingly, the City does not make any representations as to the completeness or accuracy of such information.

DTC will act as securities depository for the Bonds and the Notes. The Bonds and Notes will be issued as fully-registered bonds and notes registered in the name of Cede & Co. (DTC's partnership nominee) or such other name as may be requested by an authorized representative of DTC. Fully-registered Bond and Note certificates will be issued in the aggregate principal amounts of the Bonds and Notes of each series and maturity, and will be deposited with DTC.

DTC, the world's largest securities depository, is a limited-purpose trust company organized under the New York Banking Law, a "banking organization" within the meaning of the New York Banking Law, a member of the Federal Reserve System, a "clearing corporation" within the meaning of the New York Uniform Commercial Code, and a "clearing agency" registered pursuant to the provisions of Section 17A of the Securities Exchange Act of 1934. DTC holds and provides asset servicing for over 3.5 million issues of U.S. and non-U.S. equity issues, corporate and municipal debt issues, and money market instruments (from over 100 countries) that DTC's participants ("Direct Participants") deposit with DTC. DTC also facilitates the post-trade settlement among Direct Participants of sales and other securities transactions in deposited securities, through electronic



computerized book-entry transfers and pledges between Direct Participants' accounts. This eliminates the need for physical movement of securities certificates. Direct Participants include both U.S. and non-U.S. securities brokers and dealers, banks, trust companies, clearing corporations, and certain other organizations. DTC is a wholly-owned subsidiary of The Depository Trust & Clearing Corporation ("DTCC"). DTCC is the holding company for DTC, National Securities Clearing Corporation and Fixed Income Clearing Corporation, all of which are registered clearing agencies. DTCC is owned by the users of its regulated subsidiaries. Access to the DTC system is also available to others such as both U.S. and non-U.S. securities brokers and dealers, banks, trust companies, and clearing corporations that clear through or maintain a custodial relationship with a Direct Participant, either directly or indirectly ("Indirect Participants"). DTC has a Standard & Poor's rating of AA+. The DTC Rules applicable to its Participants are on file with the Securities and Exchange Commission. More information about DTC can be found at [www.dtcc.com](http://www.dtcc.com).

Purchases of the Bonds and the Notes under the DTC system must be made by or through Direct Participants, which will receive a credit for the Bonds and the Notes on DTC's records. The ownership interest of each actual purchaser of each Bond or Note ("Beneficial Owner") is in turn to be recorded on the Direct and Indirect Participants' records. Beneficial Owners will not receive written confirmation from DTC of their purchase. Beneficial Owners are, however, expected to receive written confirmations providing details of the transaction, as well as periodic statements of their holdings, from the Direct or Indirect Participant through which the Beneficial Owner entered into the transaction. Transfers of ownership interests in the Bonds and the Notes are to be accomplished by entries made on the books of Direct and Indirect Participants acting on behalf of Beneficial Owners. Beneficial Owners will not receive certificates representing their ownership interests in the Bonds and the Notes, except in the event that use of the book-entry system for the Bonds and the Notes is discontinued.

To facilitate subsequent transfers, all Bonds and Notes deposited by Direct Participants with DTC are registered in the name of DTC's partnership nominee, Cede & Co., or such other name as may be requested by an authorized representative of DTC. The deposit of the Bonds and the Notes with DTC and their registration in the name of Cede & Co. or such other nominee do not effect any change in beneficial ownership. DTC has no knowledge of the actual Beneficial Owners of the Bonds and the Notes; DTC's records reflect only the identity of the Direct Participants to whose accounts such Bonds and Notes are credited, which may or may not be the Beneficial Owners. The Direct and Indirect Participants will remain responsible for keeping account of their holdings on behalf of their customers.

Conveyance of notices and other communications by DTC to Direct Participants, by Direct Participants to Indirect Participants, and by Direct Participants and Indirect Participants to Beneficial Owners will be governed by arrangements among them, subject to any statutory or regulatory requirements as may be in effect from time to time.

Neither DTC nor Cede & Co. (nor such other DTC nominee) will consent or vote with respect to the Bonds and the Notes unless authorized by a Direct Participant in accordance with DTC's MMI Procedures. Under its usual procedures, DTC mails an Omnibus Proxy (the "Omnibus Proxy") to the City as soon as possible after the record date. The Omnibus Proxy assigns Cede & Co.'s consenting or voting rights to those Direct Participants to whose accounts the Bonds and the Notes are credited on the record date (identified in a listing attached to the Omnibus Proxy).

Redemption proceeds and principal and interest payments on the Bonds and Notes will be made to Cede & Co., or such other nominee as may be requested by an authorized representative of DTC. DTC's practice is to credit Direct Participants' accounts upon DTC's receipt of funds and corresponding detail information from the City or Paying Agent, on payable date in accordance with their respective holdings shown on DTC's records. Payments by Participants to Beneficial Owners will be governed by standing instructions and customary practices, as is the case with securities held for the accounts of customers in bearer form or registered in "street name," and will be the responsibility of such Participant and not of DTC nor its nominee, the Paying Agent or the City, subject to any statutory or regulatory requirements as may be in effect from time to time. Payment of redemption

proceeds, distributions, and dividend payments to Cede & Co. (or such other nominee as may be requested by an authorized representative of DTC) is the responsibility of the City or the Paying Agent, disbursement of such payments to Direct Participants will be the responsibility of DTC, and disbursement of such payments to the Beneficial Owners will be the responsibility of Direct and Indirect Participants.

DTC may discontinue providing its services as depository with respect to the Bonds and or the Notes at any time by giving reasonable notice to the City or the Paying Agent. Under such circumstances, in the event that a successor depository is not obtained, Bond and/or Note certificates are required to be printed and delivered.

The City may decide to discontinue use of the system of book-entry transfers through DTC (or a successor securities depository). In that event, Bond and/or Note certificates will be printed and delivered.

The information in this section concerning DTC and DTC's book-entry system has been obtained from sources that the City believes to be reliable, but the City takes no responsibility for the accuracy thereof.

NEITHER THE CITY NOR THE PAYING AGENT WILL HAVE ANY RESPONSIBILITY OR OBLIGATION TO SUCH DTC PARTICIPANTS OR THE PERSONS FOR WHOM THEY ACT AS NOMINEES WITH RESPECT TO THE PAYMENTS TO OR PROVIDING OF NOTICE FOR THE DTC PARTICIPANTS, THE INDIRECT PARTICIPANTS, OR BENEFICIAL OWNERS.

SO LONG AS CEDE & CO. IS THE REGISTERED OWNER OF THE BONDS AND THE NOTES, AS NOMINEE OF DTC, REFERENCES HEREIN TO THE BONDHOLDERS, NOTEHOLDERS OR REGISTERED OWNERS OF THE BONDS AND THE NOTES (OTHER THAN UNDER THE CAPTION "TAX MATTERS") SHALL MEAN CEDE & CO. AND SHALL NOT MEAN THE BENEFICIAL OWNERS OF THE BONDS.

#### **Discontinuation of Book-Entry Only System**

If the City, in its sole discretion, determines that DTC is not capable of discharging its duties, or if DTC discontinues providing its services with respect to the Bonds and the Notes at any time, the City will attempt to locate another qualified Securities Depository. If the City fails to find such Securities Depository, or if the City determines, in its sole discretion, that it is in the best interest of the City or that the interest of the Beneficial Owners might be adversely affected if the book-entry only system of transfer is continued (the City undertakes no obligation to make an investigation to determine the occurrence of any events that would permit it to make such determination), the City shall notify DTC of the termination of the book-entry only system.

#### **Redemption of the Bonds and the Notes**

The Bonds maturing prior to December 1, 2026 are not subject to redemption prior to maturity. The Bonds maturing on or after December 1, 2026 are subject to redemption, at the option of the City prior to maturity and upon notice as hereinafter provided, at any time on or after December 1, 2025, in whole or in part from such maturities as the City shall determine and by lot within a single maturity, at the respective redemption price of 100% of the principal amount to be redeemed together with unpaid interest accrued to the redemption date.

In the event the winning bidder elects to aggregate consecutive principal maturities of the Bonds into one or more term Bonds, then each such term Bond shall be subject to mandatory sinking fund redemption prior to maturity, in part, on the dates and in the amounts to be set forth in the final Official Statement, at a redemption price equal to 100% of the principal amount to be redeemed, plus accrued interest thereon to the date fixed for redemption.

The Notes are not subject to redemption prior to maturity.

Notice of redemption ("Notice of Redemption") shall be given by mailing such notice at least thirty (30)

days but not more than sixty (60) days before the date fixed for redemption by first class mail in a sealed envelope with postage prepaid to the registered owners of such Bonds at their respective addresses as they last appear on the registration books kept for that purpose by the City or a duly appointed Bond Registrar. So long as DTC (or any successor thereto) acts as Securities Depository for the Bonds, Notice of Redemption shall be sent to such Securities Depository and shall not be sent to the beneficial owners of the Bonds. Any failure of the Securities Depository to advise any of its participants or any failure of any participant to notify any beneficial owner of any Notice of Redemption shall not affect the validity of the redemption proceedings. If the City determines to redeem a portion of the Bonds prior to maturity, such Bonds shall be selected by the City; the Bonds to be redeemed having the same maturity shall be selected by the Securities Depository in accordance with its regulations.

If Notice of Redemption has been given as provided herein, the Bonds or the portion thereof called for redemption shall be due and payable on the date fixed for redemption at the Redemption Price, together with accrued interest to the date fixed for redemption. Interest shall cease to accrue on the Bonds after the date fixed for redemption.

### **AUTHORIZATION OF THE BONDS AND THE NOTES**

The Bonds are authorized by and are issued pursuant to: (i) the provisions of the Local Bond Law, N.J.S.A. 40A:2-1 *et seq.*, as amended and supplemented (the "Local Bond Law"), (ii) a bond ordinance numbered 09-097 and a bond ordinance numbered 09-127 (collectively, the "2009 Bond Ordinances") duly adopted by the Municipal Council on October 24, 2009 and December 16, 2009, and approved and published as required by law, and (iii) a resolution duly adopted by the Municipal Council on November 7, 2018.

The Series 2018E Notes and the Series 2018F Notes have been authorized and are to be issued pursuant to the Local Budget Law, Chapter 169 of the Laws of 1960 of the State of New Jersey, effective January 1, 1962, and the acts amendatory thereof and supplemental thereto (the "Local Budget Law"), specifically N.J.S.A. 40A:4-53, and: (A) with respect to the Series 2018E Notes, (i) an ordinance of the City numbered 14.132 duly adopted by the Municipal Council of the City on October 22, 2014 and a resolution of the City adopted by the Municipal Council of the City on October 22, 2014, (ii) an ordinance of the City numbered 15.149 duly adopted by the Municipal Council of the City on November 10, 2015 and a resolution of the City adopted by the Municipal Council of the City on November 10, 2015; and (iii) an ordinance of the City numbered 18-114 duly adopted by the Municipal Council of the City on October 10, 2018, and a resolution of the City adopted by the Municipal Council of the City on October 10, 2018, and (B) with respect to the Series 2018F Notes, an ordinance of the City numbered 16.130 duly adopted by the Municipal Council of the City on September 14, 2016, and a resolution of the City adopted by the Municipal Council of the City on September 14, 2016. Pursuant to the Local Budget Law, the special emergency notes may be renewed from time to time, provided that at least 1/5 of all such special emergency notes, and the renewals thereof, mature and are paid in each year so that all the special emergency notes and renewals are paid no later than the last day of the fifth year following the date of the resolution authorizing such special emergency notes.

The Series 2018G Notes and the Series 2018H Notes have been authorized and are to be issued pursuant to the Local Bond Law and (A) with respect to the Series 2018G Notes, a bond ordinance numbered 13.031 duly adopted by the Municipal Council of the City on April 10, 2013 (the "2013 Bond Ordinance") and a bond ordinance numbered 16.106 duly adopted by the Municipal Council of the City on July 13, 2016 (the "2016 Bond Ordinance"), and (B) with respect to the Series 2018H Notes, a bond ordinance numbered 18-113 duly adopted by the Municipal Council of the City on October 10, 2018 (the "2018 Bond Ordinance", and together with the 2009 Bond Ordinances, the 2013 Bond Ordinance and the 2016 Bond Ordinance, the "Bond Ordinances").

By resolution adopted on April 10, 2013, the New Jersey Local Finance Board approved certain matters in connection with the 2013 Bond Ordinance. The Local Finance Board is authorized to establish certain conditions and requirements that the City must meet before approval for issuance is given.

The Bond Ordinances have been published in full after final adoption along with the statement that the twenty (20) day period of limitation, within which a suit, action or proceeding questioning the validity of the Bond Ordinances could be commenced, began to run from the date of the first publication of such statement. The Local Bond Law provides, that after issuance, all obligations shall be conclusively presumed to be fully authorized and issued by all laws of the State, and all persons shall be estopped from questioning their sale, execution or delivery by the City.

#### **PURPOSE OF THE BONDS AND APPLICATION OF PROCEEDS**

The City will apply the proceeds from the sale of the Bonds to pay a portion of the maturing principal of the City's \$17,734,000 Bond Anticipation Notes, Series 2018A (the "Series 2018A Notes") which were issued on January 18, 2018 and are payable on January 18, 2019. The portion of the Series 2018A Notes to be refunded by the Bonds were issued to refinance certain capital improvements.. The remaining \$8,010,000 of the principal of the Series 2018A Notes will be paid from the proceeds of the sale of the Series 2018G Notes as described below.

#### **PURPOSE OF THE NOTES AND APPLICATION OF PROCEEDS**

The City will apply the proceeds from the sale of the Series 2018E Notes to (i) pay a portion of the maturing principal of the City's \$9,700,000 Special Emergency Notes, Series 2017C (Federally Taxable) (the "Series 2017C Notes") which were issued on December 7, 2017 and are payable on December 7, 2018; (ii) finance the payment of contractually required severance liabilities resulting from the layoff or retirement of City employees; and (iii) pay a portion of the costs of issuing the Series 2018E Notes. Such Series 2017C Notes were issued to pay a portion of the maturing principal of certain prior notes relating to the payment of contractually required severance liabilities resulting from the layoff or retirement of City employees. The remaining \$5,000,000 of the principal of the Series 2017C Notes will be retired from funds appropriated from the City's fiscal year 2018 budget appropriations.

The City will apply the proceeds from the sale of the Series 2018F Notes to (i) pay a portion of the maturing principal of the City's \$4,000,000 Special Emergency Notes, Series 2017D (the "Series 2017D Notes") which were issued on December 7, 2017 and are payable on December 7, 2018; and (ii) pay a portion of the costs of issuing the Series 2018F Notes. Such Series 2017D Notes were issued to pay a portion of the maturing principal of certain prior notes relating to the preparation and execution of a complete program of revaluation of real property. The remaining \$1,000,000 of the principal of the Series 2017D Notes will be retired from funds appropriated from the City's fiscal year 2018 budget appropriations.

The City will apply the proceeds from the sale of the Series 2018G Notes to (i) pay a portion of the maturing principal of the City's \$7,980,000 Bond Anticipation Notes, Series 2017E (the "Series 2017E Notes") which were issued on December 7, 2017 and are payable on December 7, 2018; (ii) pay a portion of the maturing principal of the City's Series 2018A Notes; and (iii) pay a portion of the costs of issuing the Series 2018G Notes. Such Series 2017E Notes, and the portion of the Series 2018A Notes to be refunded by the Series 2018G Notes, were issued to pay a portion of the maturing principal of certain prior notes relating to various capital improvements and to finance and refinance the construction of certain infrastructure improvements relating to certain redevelopment projects of the Jersey City Redevelopment Agency (the "JCRA") to be undertaken by New Jersey City University. See "THE NJCU REDEVELOPMENT PROJECTS" herein. The remaining \$1,966,017 of the principal of the Series 2017E Notes will be retired from funds appropriated from the City's fiscal year 2018 budget appropriations and insurance proceeds.

The City will apply the proceeds from the sale of the Series 2018H Notes to (i) finance a portion of certain costs relating to a redevelopment project of the JCRA known as the Bayfront Redevelopment Project, including the purchase of real property, the demolition of certain structures located thereon and the construction of certain infrastructure improvements (the "Bayfront Redevelopment Project"); and (ii) pay a portion of the costs of issuing the Series 2018H Notes. See "THE BAYFRONT REDEVELOPMENT PROJECT" herein.

## SECURITY AND SOURCE OF PAYMENT

The Bonds are valid and legally binding general obligations of the City, and the City has pledged its full faith and credit for the payment of the principal of and interest on the Bonds. The Bonds are direct obligations of the City and, unless paid from other sources, the City is required by law to levy *ad valorem* taxes upon all the taxable property within the City for the payment of the principal of and interest on the Bonds without limitation as to rate or amount.

The Bonds are not a debt or obligation, legal, moral or otherwise, of the State, or any county, municipality or any political subdivision thereof, other than the City.

The Notes constitute general obligations of the City and the full faith and credit and unlimited taxing power of the City are pledged to the payment of principal of, and interest on the Notes. The City is authorized and required by law to levy *ad valorem* taxes on all real property taxable by the City for the payment of the principal of and the interest on the Notes without limitation as to rate or amount. Payment of such principal and interest is not limited, however, to any particular fund or source of revenue of the City. The City is required to include in its annual municipal budget the total amount of interest and principal charges on all of its general obligation indebtedness for the current year.

The Notes are not a debt or obligation, legal, moral or otherwise, of the State of New Jersey, or any county, municipality or political subdivision thereof, other than the City.

*The Bonds and the Notes are not entitled to the benefits of the Municipal Qualified Bond Act, Title 40A of the New Jersey Statutes, Section 40A:3-1, et seq., as amended, the School Qualified Bond Act, Title 18A of the New Jersey Statutes, Section 18A:24-85 et seq., as amended, or the New Jersey School Bond Reserve Act, P.L. 1980 (N.J.S.A. 18A:56-17 et seq.).*

## NO DEFAULT

The City has never defaulted in the payment of principal of, redemption premium, if any, and interest on any bonds or notes or other obligations of the City, nor are any payments of principal of or interest on the City's indebtedness past due.

## MARKET PROTECTION

Other than the Bonds and the Notes, the City does not anticipate issuing any additional series of notes and bonds in 2018.

The City intends to issue approximately \$85,000,000 in bond anticipation notes in January 2019 to finance additional costs relating to the Bayfront Redevelopment Project. See "THE BAYFRONT REDEVELOPMENT PROJECT" herein.

## THE NJCU REDEVELOPMENT PROJECTS

On April 18, 2017, the JCRA and New Jersey City University ("NJCU") entered into a Redevelopment Agreement contemplating the redevelopment of certain property owned by NJCU and located in an "area in need of redevelopment", through public-private partnerships with four designated private redevelopers. Each private redeveloper has also entered into a separate redevelopment agreement with the JCRA for the construction of its redevelopment project, each on separate premises to be ground leased by NJCU. Pursuant to an Infrastructure Agreement with the City, NJCU agreed to undertake certain infrastructure improvements in furtherance of these redevelopment projects, and the City agreed to reimburse such costs up to a total of \$16 million, less an allowance for the City's interest expense and costs of issuance. A portion of the Series 2018G Notes in the amount of \$12,145,000 represents amounts borrowed by the City for such purpose. The Series 2018G Notes are not secured

by any payments from NJCU or any private redeveloper.

### **THE BAYFRONT REDEVELOPMENT PROJECT**

In 2008, the City designated a portion of the west side of the City as the Bayfront I Redevelopment Area, and adopted a redevelopment plan to govern its redevelopment. By resolution adopted on June 27, 2018, the City determined to be the Master Redeveloper for the Bayfront I Redevelopment Area, and to acquire from a private entity substantially all of the property located within the Bayfront I Redevelopment Area that is not already owned by City or one of its related entities. On October 10, 2018, the City adopted a bond ordinance authorizing the execution of a purchase and sale agreement with the principal property owner (the "Purchase Agreement"), and further authorizing the issuance of up to \$170 million in bonds or notes to finance the costs of the purchase of such real property (collectively, the "Development Parcels"), the demolition of certain structures located thereon and the construction of certain infrastructure improvements (collectively, the "Bayfront Redevelopment Project").

Under the Purchase Agreement, the purchase price for the Development Parcels is \$96 million, of which \$6 million is allocated to the cost of demolition. The Series 2018H Notes are being issued to finance payment of the \$9 million purchase price deposit and \$6 million demolition costs. The City expects to issue an additional series of bond anticipation notes in January 2019 in the amount of approximately \$85 million (the "January 2019 Notes") to finance payment of the balance of the purchase price (\$81 million), and certain additional expenses of the Bayfront Redevelopment Project.

As Master Redeveloper, the City expects to enter into redevelopment agreements from time to time with private redevelopers for the redevelopment of the Development Parcels. In connection with such redevelopment agreements, the City expects to sell the Development Parcels to such redevelopers, and the City expects to apply the sale proceeds to the retirement of the City's bond anticipation notes that financed the related property acquisition or to infrastructure improvements in lieu of issuing additional debt for same. Except to the extent of any sale proceeds received, the City expects that the maturing principal and interest due on the Series 2018H Notes and the January 2019 Notes will be provided from the proceeds of bond anticipation notes to be issued by the City in December 2019 and January 2020, respectively. However, the Series 2018H Notes are not secured by any payments that may be received from any private redeveloper.

### **CITY OF JERSEY CITY**

The City is New Jersey's second largest municipality with a population of 247,597 according to the United States Department of Commerce's 2010 Census. The City is located on the west side of the Hudson River, directly across from lower Manhattan in New York City, and is part of the major business and industrial concentration spanning the New York - Northern New Jersey metropolitan area.

The City's land area is 15.8 square miles, including a five mile long stretch of Hudson River waterfront that has experienced considerable high rise office tower, residential and multi-family development over the past ten years. The City is connected to New York City by the Holland Tunnel and the PATH railroad tubes and is within ten miles of Newark International Airport and the container and cargo facilities of Port Newark-Elizabeth. The City is located in the County of Hudson. The City's size and current development activity cause it to dominate the economy of Hudson County (the Jersey City Labor Area). The City also serves as the seat of the County government. Of the approximately 275,000 persons employed in the County, approximately 43% are employed in Jersey City. For additional information regarding the City and its finances, see "APPENDIX A - Certain Information Regarding the City of Jersey City".

## RECENT FINANCIAL RESULTS AND FINANCIAL OUTLOOK

### Financial Overview

Appendix A contains information relative to the financial operations of the City. Over the last few years, the City's financial position has improved due to structurally balanced operations and strong prospects for continued tax base growth. The City has benefited from successful efforts to raise additional recurring revenues while reducing personnel related expenditures.

The calendar year that ended December 31, 2017 resulted in an excess of \$17,379,481 in operations and the City's audited fund balance was \$56,339,410. The calendar year that ended December 31, 2016 resulted in an excess of \$43,960,220 in operations and the City's audited fund balance was \$78,920,179. The calendar year that ended December 31, 2015 resulted in an excess of \$20,295,394 in operations and the City's audited fund balance was \$50,705,610. The calendar year that ended December 31, 2014 resulted in an excess of \$33,812,449 in operations and the City's audited fund balance was \$56,132,966.

The City restructured its debt on March 30, 2006, providing Fiscal Year 2006 debt service relief of \$18 million and another approximately \$69 million in Fiscal Years 2007-2011 combined, and was intended to produce approximately level debt service through Fiscal Year 2022.

### Financial Results

**2018 Budget.** The City's budget for the 2018 Calendar year was introduced on March 14, 2018 and adopted on July 18, 2018. The Municipal Tax Levy increased to \$236,746,746. The City's 2018 budget anticipated \$66,358,882 in State Aid.

**2017 Budget.** The City's budget for the 2017 Calendar year was introduced on March 22, 2017 and adopted on July 10, 2017. The Municipal Tax levy increased to \$228,298,260. The City's 2017 budget realized \$67,050,310 in State Aid.

**2016 Budget.** The City's budget for the 2016 Calendar year was introduced on February 24, 2016 and adopted on July 20, 2016. The Municipal Tax levy increased to \$226,747,422. The City's 2016 budget realized \$69,465,660 in State Aid.

**2015 Results.** The City's budget for the 2015 Calendar year was introduced on March 11, 2015 and adopted on July 28, 2015. The Municipal Tax levy increased to \$219,785,389. The City's 2015 budget realized \$68,430,369 in State Aid.

**2014 Results.** The City's budget for the 2014 Calendar year was introduced on March 12, 2014 and adopted on September 23, 2014. The Municipal Tax levy decreased to \$217,414,170. The City's 2014 budget realized \$68,569,897 in State Aid.

## CERTAIN STATUTORY PROVISIONS FOR THE PROTECTION OF GENERAL OBLIGATION DEBT

### Local Bond Law (N.J.S.A. 40A:2-1 et seq.)

The Local Bond Law governs the issuance of bonds and notes to finance certain municipal capital expenditures. Among its provisions are requirements that bonds must mature within the statutory period of usefulness of the projects bonded and that bonds be retired in serial or sinking fund installments. A five percent (5%) cash down payment is generally required to be appropriated for the financing of expenditures for municipal purposes for which bonds are authorized.

**The Local Fiscal Affairs Law (N.J.S.A. 40A:5-1 et seq.)**

This law regulates the non-budgetary financial activities of local governments. An annual, independent audit of the local unit's accounts for the previous year must be performed by a licensed Registered Municipal Accountant. The audit, conforming to the Division of Local Government Services' "Requirements of Audit," includes recommendations for improvement of the local unit's financial procedures and must be filed with the Director (as defined herein) within six (6) months after the close of the fiscal year. A synopsis of the audit report, together with all recommendations made, must be published in a local newspaper within thirty (30) days of its completion.

The chief financial officer of every local unit must file annually with the Director a verified statement of financial condition of the local unit and all constituent boards, agencies and commissions.

The annual audit report is filed with the City Clerk and is available for review during business hours.

**Debt Limits (N.J.S.A. 40A:2-6)**

The authorized bonded indebtedness of a municipality in the State is limited by statute, subject to the exceptions noted below, to an amount equal to 3.50% of its equalized valuation basis. The equalized valuation basis of a municipality is set by statute as the average for the last three years of the equalized value of all taxable real property and improvements and certain class II railroad property within its boundaries as annually determined by the State Board of Taxation.

Certain categories of debt are permitted by statute to be deducted for purposes of computing the statutory debt limit.

On December 31, 2017, the City's percentage of statutory net debt was 1.655% and was comprised of the following:

	<u>Gross Debt</u>	<u>Deductions</u>	<u>Net Debt</u>
Municipal Purposes	\$627,913,930	\$210,106,522	\$417,807,408
School Purposes	\$22,417,258	\$22,417,258	\$0

**Exceptions to Debt Limits - Extensions of Credit (N.J.S.A. 40A:2-7)**

The debt limit of the City may be exceeded with the approval of the Local Finance Board, a State regulatory agency. If all or any part of a proposed debt authorization would exceed its debt limit, the City must apply to the Local Finance Board for an extension of credit. If the Local Finance Board determines that a proposed debt authorization would not materially impair the ability of the City to meet its obligations or to provide essential services, or makes other statutory determinations, approval may be granted. In addition to the aforesaid, debt in excess of the debt limit may be issued without the approval of the Local Finance Board to fund certain bonds for self-liquidating purposes and, in each fiscal year, in an amount not exceeding two-thirds of the amount budgeted in such fiscal year for the retirement of outstanding obligations (exclusive of obligations issued for utility or assessment purposes).

**Short-Term Financing**

The City may issue short term "bond anticipation notes" to temporarily finance a capital improvement or project in anticipation of the issuance of bonds if the bond ordinance or a subsequent resolution so provides. Bond anticipation notes, which are general obligations of the City, may be issued for a period not exceeding one (1) year. Generally, bond anticipation notes may not be outstanding for longer than ten (10) years. An additional



period may be available following the tenth anniversary date equal to the period from the notes' maturity to the end of the tenth fiscal year in which the notes mature plus four (4) months in the next following fiscal year from the date of original issuance. Beginning in the third year, the amount of outstanding notes that may be renewed is decreased by the minimum amount required for the first year's principal payment of bonds in anticipation of which such notes are issued.

## **MUNICIPAL BUDGET**

Pursuant to the Local Budget Law, N.J.S.A. 40A:4-1 et seq., as amended and supplemented (the "Local Budget Law"), the City is required to have a balanced budget in which debt service is included in full for each fiscal year.

### **The Local Budget Law (N.J.S.A. 40A:4-1 et seq.)**

The foundation of the New Jersey local finance system is the annual cash basis budget. The City must adopt an operating budget in the form required by the Division of Local Government Services, Department of Community Affairs, State of New Jersey (the "Division"). Items of revenue and appropriation are regulated by law and must be certified by the Director prior to final adoption of the budget. The Local Budget Law requires each local unit to appropriate sufficient funds for payment of current debt service and the Director of the Division (the "Director") is required to review the adequacy of such appropriations, among others, for certification.

The Director has no authority over individual operating appropriations, unless a specific amount is required by law, but the review functions focusing on anticipated revenues serve to protect the solvency of all local units. Local budgets, by law and regulation, must be in balance on a "cash basis". No budget or amendment thereof shall be adopted unless the Director shall have previously certified his approval thereof (N.J.S.A. 40A:4-10).

The principal sources of City revenues are real estate taxes, State Aid, Federal Aid and miscellaneous revenues.

In any year, the municipality may authorize, by resolution, the issuance of tax anticipation notes which may be issued in anticipation of the collection of taxes for such year. Tax anticipation notes are limited in amount by law and must be paid off in full by a municipality within one hundred twenty (120) days after the close of the fiscal year.

### **Real Estate Taxes**

The general principle that revenue cannot be anticipated in a budget in excess of that realized in the preceding year applies to property taxes. N.J.S.A. 40A:4-29 delineates anticipation of delinquent tax collections: "The maximum which may be anticipated is the sum produced by the multiplication of the amount of delinquent taxes unpaid and owing to the local unit on the first day of the current fiscal year by the percentage of collection of delinquent taxes for the year immediately preceding the current fiscal year."

Section 41 of the Local Budget Law provides with regard to current taxes that: "Receipts from the collection of taxes levied or to be levied in the municipality, or in the case of a county for general county purposes and payable in the fiscal year, shall be anticipated in an amount which is not in excess of the percentage of taxes levied and payable during the next preceding fiscal year which was received in cash by the last day of such preceding fiscal year."

The provision requires that an additional amount (the "reserve for uncollected taxes") be added to the tax levy required to balance the budget so that when the percentage of the prior year's tax collection is applied to the combined total, the product will at least be equal to the tax levy required to balance the budget. The reserve requirement is calculated as follows:

Cash Required from Taxes to Support Local Municipal Budget and Other Taxes = Amount to be  
Prior Year's Percentage of Current Tax Collection (or Lesser %) Raised by Taxation

### Miscellaneous Revenues

Section 26 of the Local Budget Law provides: "no miscellaneous revenues from any source shall be included as an anticipated revenue in the budget in an amount in excess of the amount actually realized in cash from the same source during the preceding fiscal year, unless the Director shall determine upon application by the governing body that the facts clearly warrant the expectation that such excess amount will actually be realized in cash during the fiscal year and shall certify such determination, in writing, to the local unit." No budget or amendment thereof shall be adopted unless the Director shall have previously certified his approval thereof (N.J.S.A. 40A:4-10). The exception to this is the inclusion of categorical grants-in-aid contracts for their face amount with an offsetting appropriation. The fiscal years for such grants rarely coincide with the municipality's calendar fiscal year.

### Limitations on Expenditures ("Cap Law") and Property Tax Levy Cap

N.J.S.A. 40A:4-45.3 places limits on municipal tax levies and expenditures. This law is commonly known as the "Cap Law" (the "Cap Law"). The Cap Law was amended and became effective on July 7, 2004. The Cap Law provides that the City shall limit any increase in its budget to 2.5% or the Cost-Of-Living Adjustment, whichever is less, of the previous year's final appropriations, subject to certain exceptions. The Cost-Of-Living Adjustment is defined as the rate of annual percentage increase, rounded to nearest half percent, in the Implicit Price Deflator for State and Local Government Purchases of Goods and Services produced by the United States Department of Commerce for the year preceding the current year as announced by the Director. However, in each year in which the Cost-Of-Living Adjustment is equal to or less than 2.5%, the City may, by ordinance approved by a majority vote of the full membership of the governing body, provide that the final appropriations of the City for such year be increased by a percentage rate that is greater than the Cost-Of-Living Adjustment, but not more than 3.5% over the previous year's final appropriations. See N.J.S.A. 40A:4-45.14. In addition, N.J.S.A. 40A:4-45.15b restored "CAP" banking to the Local Budget Law. Municipalities are permitted to appropriate available "CAP Bank" in either of the next two (2) succeeding years' final appropriations. Along with the permitted increases for total general appropriations there are certain items that are allowed to increase outside the "CAP".

Additionally, P.L. 2010, c.44, effective July 13, 2010, imposes a two percent (2%) cap on the tax levy of a municipality, county, fire district or solid waste collection district, with certain exceptions and subject to a number of adjustments. The exclusions from the limit include increases required to be raised for capital expenditures, including debt service, increases in pension contributions in excess of two percent (2%), certain increases in health care costs in excess of two percent (2%), and extraordinary costs incurred by a local unit directly related to a declared emergency. The governing body of a local unit may request approval, through a public question submitted to the legal voters residing in its territory, to increase the amount to be raised by taxation, and voters may approve increases above two percent (2%) not otherwise permitted under the law by an affirmative vote in excess of fifty percent (50%).

The Division has advised that counties and municipalities must comply with both the budget Cap Law and the tax levy limitation. Neither the tax levy limitation nor the Cap Law, however, limits the obligation of the City to levy *ad valorem* taxes upon all taxable property within the boundaries of the City to pay debt service on bonds and notes.

### Deferral of Current Expenses

Supplemental appropriations made after the adoption of the budget and determination of the tax rate may be authorized by the governing body of a local unit, including the City, but only to meet unforeseen circumstances, to protect or promote public health, safety, morals or welfare, or to provide temporary housing or public assistance prior to the next succeeding fiscal year. However, with certain exceptions described below, such appropriations must be

included in full as a deferred charge in the following year's budget. Any emergency appropriation must be declared by resolution according to the definition provided in N.J.S.A. 40A:4-48, and approved by at least two-thirds of the full membership of the governing body and shall be filed with the Director. If such emergency appropriations exceed three percent (3%) of the adopted operating budget, consent of the Director is required. N.J.S.A. 40A:4-49.

The exceptions are certain enumerated quasi-capital projects ("special emergencies") such as (i) the repair and reconstruction of streets, roads or bridges damaged by snow, ice, frost, or floods, which may be amortized over three (3) years, and (ii) the repair and reconstruction of streets, roads, bridges or other public property damaged by flood or hurricane, where such expense was unforeseen at the time of budget adoption, the repair and reconstruction of private property damaged by flood or hurricane, tax map preparation, reevaluation programs, revision and codification of ordinances, master plan preparations, drainage map preparation for flood control purposes, studies and planning associated with the construction and installation of sanitary sewers, authorized expenses of a consolidated commission, contractually required severance liabilities resulting from the layoff or retirement of employees and the preparation of sanitary and storm system maps, all of which projects set forth in this section (ii) may be amortized over five (5) years. N.J.S.A. 40A:4-53, -54, -55, -55.1. Emergency appropriations for capital projects may be financed through the adoption of a bond ordinance and amortized over the useful life of the project as described above.

### **Budget Transfers**

Budget transfers provide a degree of flexibility and afford a control mechanism. Pursuant to N.J.S.A. 40A:4-58, transfers between major appropriation accounts are prohibited until the last two (2) months of the municipality's fiscal year. Appropriation reserves may be transferred during the first three (3) months of the current fiscal year to the previous fiscal year's budget. N.J.S.A. 40A:4-59. Both types of transfers require a two-thirds vote of the full membership of the governing body. Although sub-accounts within an appropriation are not subject to the same year-end transfer restriction, they are subject to internal review and approval. Generally, transfers cannot be made from the down payment account, the capital improvement fund, contingent expenses or from other sources as provided in the statute.

### **Fiscal Year**

In 2010, the City changed its fiscal year from a June 30<sup>th</sup> year end to a December 31<sup>st</sup> year end. The City adopted a transition year budget for the period July 1, 2010 through December 31, 2010 and introduced a full calendar year budget for the period commencing January 1, 2011 and in each calendar year thereafter.

### **Budget Process**

Primary responsibility for the City's budget process lies with the City Council. As prescribed by the Local Budget Law, adoption should occur by the end of March; however, extensions may be granted by the Division to any local governmental unit. In the first quarter in which the budget formulation is taking place, the City operates under a temporary budget which may not exceed 26.25% of the previous fiscal year's adopted budget. In addition to the temporary budget, the City may approve emergency temporary appropriations for any purpose for which appropriations may lawfully be made.

## **TAX INFORMATION ON THE CITY**

Property valuations (assessments) are determined on true values as arrived at by the cost approach, market data approach and capitalization of net income (where applicable). Current assessments are the result of maintaining new assessments on a "like" basis with established comparable properties for newly assessed or purchased properties resulting in a decline of the assessment ratio to true value to its present level. This method assures equitable treatment to like property owners. Because of the escalation of property resale values, annual adjustments could not keep pace with the rising values.

Upon the filing of certified adopted budgets by the City, the school district and the County, the tax rate is struck by the County Board of Taxation based on the certified amounts in each of the taxing districts for collection to fund the budgets. The statutory provisions for the assessment of property, levying of taxes and the collection thereof are set forth in N.J.S.A. 54:4-1 *et seq.* Special taxing districts are permitted in New Jersey for various special services rendered to the properties located within the special district.

For calendar year municipalities, tax bills are generally sent in June of the current fiscal year. Taxes are payable in four quarterly installments on February 1, May 1, August 1 and November 1. The August and November tax bills are determined as the full tax levied for municipal, school district or county purposes for the current municipal fiscal year, less the amount charged as the February and May installments for municipal, school district or county purposes in the current fiscal year. The amounts due for the February and May installments are determined as by the municipal governing body as either one-quarter or one-half of the full tax levied for municipal, school district or county purposes for the preceding fiscal year.

Tax installments not paid on or before the due date are subject to interest penalties of eight percent (8%) on the first \$1,500 of the delinquency and, then eighteen percent (18%) per annum on any amount in excess of \$1,500. A penalty of up to six percent (6%) of the delinquency in excess of \$10,000 may be imposed on a taxpayer who fails to pay that delinquency prior to the end of the tax year in which the taxes become delinquent. Delinquent taxes open for one year or more are annually included in a tax sale in accordance with State Statutes. Tax title liens are periodically assigned to the Corporation Counsel (as defined herein) for in rem foreclosures in order to acquire title to these properties.

The provisions of Chapter 99 of the Laws of New Jersey of 1997 allow a municipality to sell its total property tax levy to the highest bidder either by public sale with sealed bids or by public auction. The purchaser shall pay the total property tax levy bid amount in quarterly installments or in one annual installment. Property taxes will continue to be collected by the municipal tax collector and the purchaser will receive as a credit against his payment obligation the amount of taxes paid to the tax collector. The purchaser is required to secure his payment obligation to the municipality by an irrevocable letter of credit or surety bond. The purchaser is entitled to receive, all delinquent taxes and other municipal charges owing, due and payable upon collection by the tax collector. The statute sets forth bidding procedures, minimum bidding terms and requires the review and approval of the sale by the Division.

### **Tax Appeals**

New Jersey Statutes provide a taxpayer with remedial procedures for appealing an assessed valuation that the taxpayer deems excessive. The taxpayer has a right to file a petition on or before the 1<sup>st</sup> day of April (1<sup>st</sup> day of May in a revaluation year) of the current tax year for its review. The County Board of Taxation and the Tax Court of New Jersey have the authority after a hearing to increase, decrease or reject the appeal petition. Adjustments by the County Board of Taxation are usually concluded within the current tax year and reductions are shown as cancelled or remitted taxes for that year. If the taxpayer believes the decision of the County Board of Taxation to be incorrect, appeal of the decision may be made to the Tax Court of New Jersey. State tax court appeals tend to take several years to conclude by settlement or trial and any losses in tax collection from prior years, after an unsuccessful trial or by settlement, are charged directly to operations.

## **DEBT INFORMATION ON THE CITY**

### **Debt Statements**

The City must report all new authorizations of debt or changes in previously authorized debt to the Division. The Supplemental Debt Statement, as this report is known, must be submitted to the Division before final passage of any debt authorization. Before January 31 of each year, the City must file an Annual Debt Statement with the Division. This report is made under oath and states the authorized, issued and unissued debt of

the City as of the previous December 31. Through the Annual and Supplemental Debt Statements, the Division monitors all local borrowing.

## **TAX MATTERS**

### **Federal Income Taxes**

The Internal Revenue Code of 1986, as amended (the "Code") imposes certain requirements that must be met at and subsequent to the issuance and delivery of the Bonds and the Tax-Exempt Notes for interest thereon to be and remain excluded from gross income of the owners thereof for federal income tax purposes. Noncompliance with such requirements could cause the interest on the Bonds and the Tax-Exempt Notes to be included in gross income for federal income tax purposes retroactive to the date of issuance of the Bonds and the Notes. The City has covenanted to comply with the provisions of the Code applicable to the Bonds and the Tax-Exempt Notes, and has covenanted not to take any action or permit any action that would cause the interest on the Bonds and the Tax-Exempt Notes to be included in gross income under Section 103 of the Code or cause interest on the Bonds and the Tax-Exempt Notes to be treated as an item of tax preference for purposes of the alternative minimum tax imposed by the Code. Bond Counsel will not independently verify the accuracy of those certifications and representations.

Assuming the City observes its covenants with respect to compliance with the Code, GluckWalrath LLP, Bond Counsel to the City, is of the opinion that, under laws, regulations, rulings and judicial decisions existing on the date of the original delivery of the Bonds and the Tax-Exempt Notes, interest on the Bonds and the Tax-Exempt Notes is excluded from gross income of the owners thereof for federal income tax purposes under Section 103 of the Code. Bond Counsel is further of the opinion that interest on the Bonds and the Tax-Exempt Notes is not treated as a preference item for purposes of the alternative minimum tax imposed by the Code on individuals or corporations but that for taxable years that began before January 1, 2018, interest on the Bonds and the Tax-Exempt Notes will be included in "adjusted current earnings" in computing alternative minimum taxable income for purposes of the alternative minimum tax imposed by the Code on certain corporations. The corporate alternative minimum tax has been repealed for taxable years beginning on or after January 1, 2018. See "Certain Federal Tax Considerations" below.

### **Original Issue Premium**

The initial public offering price of certain Bonds may be greater than the stated redemption price thereof at maturity (each a "Premium Bond"). The difference between the initial public offering price for any such Premium Bond and the stated redemption price at maturity is "original issue premium." For federal income tax purposes original issue premium is amortizable periodically over the term of a Premium Bond through reductions in the holder's tax basis for the Premium Bond for determining gain or loss from sale or redemption prior to maturity. Amortizable premium is accounted for as reducing the tax-exempt interest on the Premium Bond rather than creating a deductible expense or loss. Purchasers of the Bonds should consult their tax advisors for an explanation of the accrual rules for original issue premium and any other federal, state or local tax consequences of the purchase of any Premium Bonds.

### **Original Issue Discount**

The initial public offering price of certain Bonds may be less than the stated redemption price thereof at maturity (each a "Discount Bond"). The difference between the initial public offering price for any such Discount Bond and the stated redemption price at maturity is "original issue discount." For federal income tax purposes, original issue discount on a Discount Bond accrues to the original holder of the Discount Bond over the period of its maturity based on the constant yield method compounded annually as interest with the same tax exemption and alternative minimum tax status (if applicable) as regular interest. The accrual of original issue discount increases the holder's tax basis in the Discount Bond for determining taxable gain or loss on the maturity, redemption, prior sale or other disposition of a Discount Bond. Purchasers of the Bonds should consult their tax advisors for an explanation of the accrual rules for original issue discount and any other federal, state or local tax consequences of

the purchase of Bonds with original issue discount.

### **Certain Federal Tax Considerations**

Ownership of the Bonds and the Tax-Exempt Notes may result in collateral federal tax consequences to certain taxpayers, including, without limitation, financial institutions, S corporations with excess net passive income, property and casualty companies, individual recipients of social security or railroad retirement benefits, individuals otherwise eligible for the earned income tax credit, foreign corporations that may be subject to the foreign branch profits tax, and taxpayers who may be deemed to have incurred indebtedness to purchase or carry the Bonds and the Tax-Exempt Notes. Bond Counsel will express no opinion with respect to these or any other collateral tax consequences of the ownership of the Bonds and the Tax-Exempt Notes. The nature and extent of the tax benefit to a taxpayer of ownership of the Bonds and the Tax-Exempt Notes will generally depend upon the particular nature of such taxpayer or such taxpayer's own particular circumstances, including other items of income or deduction. Accordingly, prospective purchasers of the Bonds and the Tax-Exempt Notes should consult their own tax advisors with respect to these and other collateral federal tax consequences resulting from ownership of the Bonds and the Tax-Exempt Notes.

Bond Counsel is not rendering any opinion on any federal tax matters other than those described under the caption "TAX MATTERS." Prospective investors, particularly those who may be subject to special rules described above, are advised to consult their own tax advisors regarding the federal tax consequences of owning and disposing of the Bonds and the Tax-Exempt Notes, as well as any tax consequences arising under the laws of any state or other taxing jurisdiction.

### **Backup Withholding**

Commencing with interest paid in 2006, interest paid on tax-exempt obligations such as the Bonds and the Tax-Exempt Notes is subject to information reporting to the IRS in a manner similar to interest paid on taxable obligations. In addition, interest on the Bonds and the Tax-Exempt Notes may be subject to backup withholding if such interest is paid to a registered owner that (a) fails to provide certain identifying information (such as the registered owner's taxpayer identification number) in the manner required by the IRS, or (b) has been identified by the IRS as being subject to backup withholding.

### **Changes in Law and Post-Issuance Events**

Legislative or administrative actions and court decisions, at either the federal or state level, could have an adverse impact on the potential benefits of the exclusion from gross income of the interest on the Bonds and the Tax-Exempt Notes for federal or state income tax purposes, and thus on the value or marketability of the Bonds and the Tax-Exempt Notes. This impact could result from changes to federal or state income tax rates, changes in the structure of federal or state income taxes (including replacement with another type of tax), repeal of the exclusion of interest on the Bonds and the Tax-Exempt Notes from gross income of the owners thereof for federal or state income tax purposes, or otherwise. It is not possible to predict whether any legislative or administrative actions or court decisions having an adverse impact on the federal or state income tax treatment of holders of the Bonds and the Tax-Exempt Notes may occur. Prospective purchasers of the Bonds and the Tax-Exempt Notes should consult their own tax advisors regarding such matters.

Bond Counsel has not undertaken to advise in the future whether any events after the date of issuance and delivery of the Bonds and the Tax-Exempt Notes may affect the tax status of interest on the Bonds and the Tax-Exempt Notes. Bond Counsel expresses no opinion as to any federal, state or local tax law consequences with respect to the Bonds and the Tax-Exempt Notes, or the interest thereon, if any action is taken with respect to the Bonds and the Tax-Exempt Notes or the proceeds thereof upon the advice or approval of counsel other than Bond Counsel.

## **Taxable Notes**

The following is a general discussion of certain of the anticipated federal tax consequences of the purchase, ownership and disposition of the Taxable Notes by the original purchasers of the Taxable Notes. Investors should consult their own tax advisors in determining the federal, state, local or other tax consequences to them of purchase, ownership and disposition of the Taxable Notes. This discussion is based upon the Code, regulations, rulings and decisions now in effect, all of which are subject to change at any time, possibly with retroactive effect, and does not purport to deal with federal income tax consequences applicable to all categories of investors, some of which will be subject to special rules. This discussion assumes that Taxable Notes will be held as "capital assets" under the Code and that the Taxable Notes are owned by U.S. Holders (as defined below). Investors should consult their own tax advisors in determining the federal, state, local or other tax consequences to them of purchase, ownership and disposition of the Taxable Notes.

As used herein, the term "U.S. Holder" means a beneficial owner of a bond that is for United States federal income tax purposes (i) a citizen or resident of the United States, (ii) a corporation, partnership or other entity created or organized in or under the laws of the United States or any State or any political subdivision thereof, (iii) an estate the income of which is subject to United States federal income taxation regardless of its source or (iv) a trust whose administration is subject to the primary jurisdiction of a court within the United States and which has one or more United States fiduciaries who have the authority to control all substantial decisions of the trust.

**INTEREST ON THE TAXABLE NOTES IS NOT EXCLUDED FROM GROSS INCOME FOR FEDERAL INCOME OF THE OWNERS THEREOF FOR FEDERAL INCOME TAX PURPOSES.** The City will report annually (or more frequently if required) to owners of record and to the IRS in respect of interest paid on the Taxable Notes.

Under the Code, payments on the Taxable Notes may under certain circumstances, be subject to "backup withholding" at a rate equal to the fourth lowest rate of tax applicable under Section 1(c) of the Code. This withholding generally applies if the owner (i) fails to furnish such owner's social security number or other taxpayer identification number ("TIN"), (ii) furnishes an incorrect TIN, (iii) fails to properly report interest, dividends or other "reportable payments" as defined in the Code, or (iv) under certain circumstances, fails to provide such owner's securities broker with a certified statement, signed under penalties of perjury, that the TIN is correct and that such Noteholder is not subject to backup withholding. Owners of the Taxable Notes should consult their own tax advisors as to their qualification for exemption for backup withholding and the procedures for obtaining the exemption.

Generally, upon the sale, exchange, redemption, or other disposition (which would include a legal defeasance) of a taxable bond or a taxable note, a holder generally will recognize taxable gain or loss in an amount equal to the difference between the amount realized (other than amounts attributable to accrued interest not previously includable in income) and such holder's adjusted tax basis in the Taxable Notes.

The City may cause the deposit of moneys or securities in escrow in such amount and manner as to cause the Taxable Notes to be deemed to be no longer outstanding under the Resolution (a "defeasance"). For Federal income tax purposes, such defeasance could result in a deemed exchange under Section 1001 of the Code and a recognition by such owner of taxable income or loss, without any corresponding receipt of moneys. In addition, the character and timing of receipt of payments on the Taxable Notes subsequent to any such defeasance could also be affected.

## **State Taxes**

In the opinion of Bond Counsel, under the laws of the State of New Jersey, as enacted and construed on the date of original delivery of the Bonds and the Notes, interest on the Bonds and the Notes and gain from the sale thereof are excludable from gross income under the New Jersey Gross Income Tax Act.

**ALL POTENTIAL PURCHASERS OF THE BONDS AND THE NOTES SHOULD CONSULT WITH THEIR TAX ADVISORS IN ORDER TO UNDERSTAND THE IMPLICATIONS OF THE CODE.**

### **LITIGATION**

To the knowledge of the City's Corporation Counsel, Peter J. Baker, Esq. (the "Corporation Counsel"), there is no litigation of any nature now pending or threatened, restraining or enjoining the issuance or the delivery of the Bonds and the Notes, or the levy or the collection of taxes to pay the principal of or the interest on the Bonds and the Notes, or in any manner questioning the authority or the proceedings for the issuance of the Bonds and the Notes or for the levy or the collection of taxes to pay the principal of or the interest on the Bonds and the Notes, or contesting the corporate existence or the boundaries of the City or the title of any of the present officers. Moreover, to the knowledge of the Corporation Counsel, except as set forth in Appendix A under the section entitled "Pending Litigation", no litigation is presently pending or threatened that, in the opinion of the Corporation Counsel, would have a material adverse impact on the financial condition of the City if adversely decided. A certificate or opinion to such effect will be executed by the Corporation Counsel and delivered to the Underwriters at the closing.

### **APPROVAL OF LEGAL PROCEEDINGS**

All legal matters incident to the authorization, the issuance, the sale and the delivery of the Bonds and the Notes are subject to the approval of GluckWalrath LLP, Trenton, New Jersey, Bond Counsel to the City, whose approving legal opinions will be delivered with the Bonds and the Notes substantially in the forms set forth in Appendix C hereto. Certain legal matters will be passed on for the City by its Corporation Counsel.

### **MUNICIPAL BANKRUPTCY**

The undertakings of the City should be considered with reference to 11 U.S.C. § 101 et seq., as amended and supplemented (the "Bankruptcy Code"), and other bankruptcy laws affecting creditors' rights and municipalities in general. The Bankruptcy Code permits the State or any political subdivision, public agency, or instrumentality that is insolvent or unable to meet its debts to commence a voluntary bankruptcy case by filing a petition with a bankruptcy court for the purpose of effecting a plan to adjust its debts; directs such a petitioner to file with the court a list of petitioner's creditors; provides that a petition filed under this chapter shall operate as a stay of the commencement or continuation of any judicial or other proceeding against the petitioner; grants priority to certain debts owed; and provides that the plan must be accepted in writing by or on behalf of creditors holding at least two-thirds in amount and more than one half in number of the allowed claims of at least one (1) impaired class. The Bankruptcy Code specifically does not limit or impair the power of a state to control by legislation or otherwise, the procedures that a municipality must follow in order to take advantage of the provisions of the Bankruptcy Code.

The Bankruptcy Code provides that special revenue acquired by the debtor after the commencement of the case shall remain subject to any lien resulting from any security agreement entered into by such debtor before the commencement of such bankruptcy case. However, special revenues acquired by the debtor after commencement of the case shall continue to be available to pay debt service secured by those revenues. Furthermore, the Bankruptcy Code provides that a transfer of property of a debtor to or for the benefit of any holder of a bond or note, on account of such bond or note, may not be avoided pursuant to certain preferential transfer provisions set forth in such code.

Reference should also be made to N.J.S.A. 52:27-40 et seq., which provides that a local unit, including the City, has the power to file a petition in bankruptcy with any United States court or court in bankruptcy under the provisions of the Bankruptcy Code, for the purpose of effecting a plan of readjustment of its debts or for the composition of its debts; provided, however, the approval of the Local Finance Board, as successor to the Municipal Finance Commission, must be obtained.



**The City has not authorized the filing of a bankruptcy petition. This reference to the Bankruptcy Code or the State statute should not create any implication that the City expects to utilize the benefits of their provisions, or that if utilized, such action would be approved by the Local Finance Board, or that any proposed plan would include a dilution of the source of payment of and security for the Notes, or that the Bankruptcy Code could not be amended after the date hereof.**

### **CONTINUING DISCLOSURE**

The City has covenanted for the benefit of bondholders and noteholders to provide certain financial information and operating data on the City and to comply with the provisions of Rule 15c2-12 (the "Rule") promulgated by the Securities and Exchange Commission pursuant to the Securities Exchange Act of 1934, as amended and supplemented, and as detailed in Continuing Disclosure Certificates (the "Certificates") to be executed on behalf of the City by its Chief Financial Officer, in the forms appearing in Appendix D hereto, such Certificates to be delivered concurrently with the delivery of the Bonds and the Notes. These covenants are being made by the City to assist the purchasers of the Bonds and the Notes in complying with the Rule.

The City has previously failed to file, in a timely manner, its Annual Reports in accordance with the Rule for the calendar year ended December 31, 2013. Generally, the City had previously filed, in a timely manner, the required audited financial statements, but did not timely file all required operating data for the periods referenced above. Additionally, the City had failed to file, in a timely manner, certain material event notices relating to rating changes of the City, the Municipal Qualified Bond Act, the School Qualified Bond Act, the School Bond Reserve Act and various bond insurance companies. Such notices were filed on November 13, 2014. Further, the City recently determined that it inadvertently failed to comply with prior undertakings to provide its Annual Report for the calendar years ended December 31, 2013 and December 31, 2014 with respect to bonds issued by the Jersey City Municipal Utilities Authority (the "JCMUA Undertaking"). However, portions of such Annual Reports were filed with the Municipal Securities Rulemaking Board (the "MSRB") with respect to the City's bonds. The City has since corrected this oversight by linking the required Annual Reports to the JCMUA Undertaking. The City has implemented certain procedures to file its Annual Reports on a more consistent and timely basis in future years. The City's implementation of procedures to file its Annual Reports also includes the continued utilization of Digital Assurance Certification, LLC (DAC) to assist with the City's disclosure requirements.

### **LEGALITY FOR INVESTMENT**

The State and all public officers, municipalities, counties, political subdivisions and public bodies, and agencies thereof, all banks, bankers, trust companies, savings and loan associations, savings banks and institutions, building and loan associations, investment companies, and other persons carrying on banking business, all insurance companies, and all executors, administrators, guardians, trustees, and other fiduciaries may legally invest any sinking funds, moneys or other funds belonging to them or within their control in any bonds or notes of the City, including the Notes, and such Notes are authorized security for any and all public deposits.

### **MUNICIPAL ADVISOR**

NW Financial Group, LLC, Hoboken, New Jersey has served as Municipal Advisor to the City with respect to the issuance of the Notes (the "Municipal Advisor"). The Municipal Advisor is not obligated to undertake, and has not undertaken, either to make an independent verification of, or to assume responsibility for the accuracy, completeness, or fairness of the information contained in the Official Statement and the Appendices hereto. The Municipal Advisor is an independent firm and is not engaged in the business of underwriting, trading or distributing municipal securities or other public securities.

## UNDERWRITING

The Bonds are being purchased by \_\_\_\_\_ (the "Bonds Underwriter") at an aggregate price of \$ \_\_\_\_\_. The Bonds are being reoffered to the public at a price of \$ \_\_\_\_\_. The Bonds Underwriter is obligated to purchase all of the Bonds if any Bonds are purchased.

The Tax-Exempt Notes are being purchased by \_\_\_\_\_ (the "Tax-Exempt Notes Underwriter") at an aggregate price of \$ \_\_\_\_\_. The Tax-Exempt Notes are being reoffered to the public at a price of \$ \_\_\_\_\_. The Tax-Exempt Notes Underwriter is obligated to purchase all of the Tax-Exempt Notes if any Tax-Exempt Notes are purchased.

The Taxable Notes are being purchased by \_\_\_\_\_ (the "Taxable Notes Underwriter", and together with the Bonds Underwriter and the Tax-Exempt Underwriter, the "Underwriters"), at an aggregate price of \$ \_\_\_\_\_. The Taxable Notes are being reoffered to the public at a price of \$ \_\_\_\_\_. The Taxable Notes Underwriter is obligated to purchase all of the Taxable Notes if any Taxable Notes are purchased.

The initial public offering yields of the Bonds and the Notes set forth on the cover and the inside cover page may be changed without notice by the Underwriters. The Underwriters may offer and sell the Bonds and the Notes to certain dealers (including dealers depositing the Bonds and the Notes into investment trusts, certain of which may be sponsored or managed by the Underwriters) and others at yields higher than the offering yields set forth on the inside cover page hereof.

## RATINGS

The City has requested that the Bonds and the Notes be rated by and has furnished information to Moody's Investors Service, Inc. ("Moody's") including information that may not be included in this Official Statement. Moody's has assigned a rating of "\_\_\_\_" to the Bonds and "\_\_\_\_" to the Notes.

An explanation of the significance of such ratings may be obtained only from Moody's. The ratings reflect only the views of Moody's. Generally, rating agencies base their ratings upon information and materials provided to them and upon investigations, studies and assumptions by the particular rating agency. There can be no assurance that the rating will be maintained for any given period of time or that the rating may not be lowered or withdrawn entirely, if in the judgment of Moody's, circumstances so warrant. Such action, any downward change in, or withdrawal of such rating, may have an adverse effect on the market price of the Notes. The City has not undertaken any responsibility after the issuance of the Bonds and the Notes to assure maintenance of the rating or to oppose any such revision or withdrawal.

## CLOSING CERTIFICATES

Upon the delivery of the Bonds and the Notes, the Underwriters will be furnished with the following items: (i) Certificates executed by the Business Administrator and the Chief Financial Officer of the City (or officers otherwise titled serving in equivalent capacities) to the effect that as of the date of this Official Statement and at all times subsequent thereto, up to and including the time of the delivery of the Bonds and the Notes, as applicable, this Official Statement did not and does not contain any untrue statement of a material fact or omit to state a material fact necessary to make the statements herein, in the light of the circumstances under which they were made, not misleading, and further stating that there has been no adverse material change in the financial condition of the City since the date of this Official Statement to the date of issuance of the Bonds and the Notes, as appropriate, and having attached thereto a copy of this Official Statement, (ii) Certificates signed by an officer of the City evidencing payment for the Bonds and the Notes, (iii) Certificates signed by the Mayor, Business Administrator, Chief Financial Officer and City Clerk evidencing the due execution of the Bonds and the Notes, including statements that (a) no litigation of any nature is pending or, to the knowledge of the signers, threatened, restraining or enjoining the issuance and delivery of the Bonds and the Notes, or the levy and collection of taxes to

pay the principal of and interest thereon, nor in any manner questioning the proceedings and authority under which the Bonds and the Notes were authorized or affecting the validity of the Bonds and the Notes thereunder, (b) neither the corporate existence or boundaries of the City nor the title of the signers to their respective offices is being contested, and (c) no authority or proceedings for the issuance of the Bonds and the Notes have been repealed, revoked or rescinded, and (iv) the Continuing Disclosure Certificate executed by the Chief Financial Officer.

### **PREPARATION OF OFFICIAL STATEMENT**

The firm of Donohue, Gironda, Doria & Tomkins, LLC, Bayonne, New Jersey, Certified Public Accountants and Registered Municipal Accountants, assisted in the preparation of information contained in this Official Statement, and takes responsibility for the financial statements to the extent specified in the Independent Auditors' Report.

All information has been obtained from sources which Donohue, Gironda, Doria & Tomkins, LLC, considers to be reliable but it makes no warranty, guarantee or other representation with respect to the accuracy and completeness of such information.

NW Financial Group, LLC has not participated in the preparation of the financial or statistical information in this Official Statement, nor has it verified the accuracy, completeness or fairness thereof and, accordingly, expresses no opinion with respect thereto.

GluckWalrath LLP has not participated in the preparation of the financial or statistical information in this Official Statement, nor has it verified the accuracy, completeness or fairness thereof and, accordingly, expresses no opinion with respect thereto.

### **FINANCIAL STATEMENTS**

The comparative balance sheets – regulatory basis of the various funds of the City as of and for the years ended December 31, 2017 and 2016, and the related comparative statement of operations and changes in fund balance – regulatory basis, statement of revenues – regulatory basis and statement of appropriations – regulatory basis, of the Current Fund, and the related statement of changes in Fund Balance – regulatory basis, of the General Capital Fund, for the years then ended, together with the related Notes to the Financial Statements for the years then ended, are presented in Appendix B to the Official Statement. The financial statements referred to above have been audited by Donohue, Gironda, Doria & Tomkins, LLC, Bayonne, New Jersey, independent auditor, as stated in its report appearing in Appendix B.

### **ADDITIONAL INFORMATION**

Inquiries regarding this Official Statement, including requests for information additional to that contained herein, may be directed to Donna L. Mauer, CMFO, Chief Financial Officer, City of Jersey City, 280 Grove Street, Jersey City, New Jersey 07302, (201) 547-5042.

### **MISCELLANEOUS**

This Official Statement is not to be construed as a contract or agreement between the City and the purchasers or holders of any of the Bonds and the Notes. Any statements made in this Official Statement involving matters of opinion, whether or not expressly so stated, are intended merely as opinions and not as representations of fact. The information and expressions of opinion herein are subject to change without notice and neither the delivery of this Official Statement nor any sale made hereunder shall, under any circumstances, create any implication that there have been no changes in the affairs in the City since the date thereof. The information contained in this Official Statement is not guaranteed as to accuracy or completeness.

This Official Statement has been duly approved, executed and delivered by the City.

**THE CITY OF JERSEY CITY**

By: /s/ \_\_\_\_\_  
Brian Platt, Business Administrator

By: /s/ \_\_\_\_\_  
Donna L. Mauer, Chief Financial Officer

Dated: \_\_\_\_\_, 2018

**APPENDIX A**  
**CERTAIN INFORMATION REGARDING THE CITY OF JERSEY CITY**

## THE CITY OF JERSEY CITY

The legislative power of the City of Jersey City (the "City") is vested in the Municipal Council (the "Council"), which is composed of nine members, six of whom are elected from the City's six wards and three of whom are elected at large. The Council meets regularly and operates in accordance with the Optional Municipal Form of Government, Section 40:69A-1 *et seq.*, of the New Jersey statutes. The Council members serve four-year terms beginning on the first day of January following their election. Their current term commenced on January 1, 2018. The members of the Council, their titles and the date they first took (or will take) office are shown on the following table:

MUNICIPAL COUNCIL		
<u>Name</u>	<u>Title</u>	<u>Date First In Office</u>
Rolando R. Lavarro	Council President	November 14, 2011
Daniel Rivera	Councilman-at-Large	July 1, 2013
Joyce Waterman	Councilwoman-at-Large	July 1, 2013
Denise Ridley	Ward A Councilwoman	January 1, 2018
Mira Prinz-Avery	Ward B Councilwoman	January 1, 2018
Richard Boggiano	Ward C Councilman	July 1, 2013
Michael Yun	Ward D Councilman	July 1, 2013
James Solomon	Ward E Councilman	January 1, 2018
Jermaine Robinson	Ward F Councilwoman	January 21, 2017

The executive power of the City is exercised by the Mayor, who is responsible for administering the charter and ordinances and general laws of the City. The Mayor is responsible for preparing and administering the City's annual expense and capital budgets. The Mayor supervises all of the departments in the City and reports annually to the Council and the public the results of the previous year's operations. The Mayor has the power to approve ordinances adopted by the Council or to return them to the Council with a statement of his objections. A vote by two-thirds of the members of the Council may override the Mayor's veto. The Mayor may attend meetings of the Council and may take part in discussions. The Mayor has no vote in the proceedings of the Council except to fill a vacancy in the Council, in which case he may cast the deciding vote. The Mayor appoints the Business Administrator and the Directors of nine City departments with the advice and consent of the Council. In the event that the Mayor is unable to fulfill his responsibilities under the applicable provisions of the New Jersey Statutes and the Jersey City Charter, the Council is required to appoint a Mayor to serve until the next election. There are no term limits for the office of Mayor or for any Council member.

### Administration

Following are biographical sketches of the City officials with responsibility for financial management:

#### STEVEN M. FULOP, Mayor

Steven Michael Fulop, a democrat, is the 49th and current Mayor of Jersey City, New Jersey. He is the youngest mayor in the country of a city with a population larger than 250,000. Mayor Fulop was elected Mayor on May 14, 2013, defeating a three term incumbent mayor and the political establishment. Prior to serving as Mayor, Steven Fulop served as the Ward E Councilman of the City for eight years. Mayor Fulop was re-elected for a second four-year term on November 7, 2017.

A first generation American, Mayor Fulop grew up in an immigrant family in Edison, New Jersey. His father owned a delicatessen in Newark, where Mayor Fulop often worked. His mother, the daughter of Holocaust survivors, worked in an immigration services office helping others gain citizenship.

Mayor Fulop graduated from Binghamton University in 1999, and in 2006 completed both his Masters in Business Administration at the New York University Stern School of Business and his Masters in Public Administration at Columbia University School of International and Public Affairs (SIPA). While attending Binghamton University, he spent time abroad studying at Oxford University in England.

Upon graduating from college, Mayor Fulop joined Goldman Sachs. After working in financial services for several years and seeing first hand the effects of the September 11 attacks, he decided to put his career at Goldman Sachs on hold and join the United States Marine Corps. Shortly after completion of Marine Corps boot camp on January 14, 2003, Mayor Fulop was deployed to Iraq, where he served as part of the 6th Engineer Support Battalion. He and his unit were recipients of numerous awards and recognition for service including the Overseas Service Ribbon, Meritorious Masts, and the Presidential Unit Citation.

Currently, Mayor Fulop is a trustee of the Liberty Science Center, and previously served on the Board of Directors for the Columbia University Alumni Association and the board for the Learning Community Charter School. He is an avid tri-athlete completing the 2012 NY Ironman Championship in less than 12 hours.

**BRIAN PLATT, Business Administrator**

Brian Platt was appointed Business Administrator on March 30, 2018. Prior to assuming this role, Brian was Jersey City's Chief Innovation Officer and helped form the City's first Office of Innovation in 2015. The office uses a data driven, collaborative approach to solve the City's most complex challenges.

Brian previously worked as an analyst for McKinsey & Company and as a kindergarten teacher with Teach For America. He completed his Masters in Public Administration at Columbia University in 2016 and was included on the 2017 "Traeger List" as one of the top 100 local government leaders in the United States.

**PETER J. BAKER, ESQ., Corporation Counsel**

Peter J. Baker was formally appointed Corporation Counsel for the City of Jersey City on April 16, 2018. Mr. Baker heads the Department of Law, which represents the City in all legal matters and advises the Mayor and City Council on policy initiatives.

Mr. Baker is a 2000 graduate of Franklin & Marshall College, where he received a Bachelor of Arts degree in English. He received his Juris Doctor degree from Temple University's Beasley School of Law in Philadelphia in 2006. While attending Temple Law, Mr. Baker received the Law Faculty Scholarship, worked as an instructor and teaching assistant in the school's Trial Advocacy program.

Upon graduating law school, Mr. Baker served as law clerk to the Honorable Lois Lipton, J.S.C., in the Superior Court of New Jersey, Bergen Vicinage, Criminal Division. After completing his clerkship, he joined the law firm of Sisselman & Schwartz, LLC, in Roseland, New Jersey, where he worked as a civil litigator. In 2013, he joined the Hudson County Prosecutor's Office as an Assistant Prosecutor until 2016, when he joined New Jersey's Office of the Attorney General, Division of Criminal Justice, as a Deputy Attorney General in the Public Corruption Bureau.

**ANNISIA CIALONE, Director of Housing, Economic Development and Commerce**

Annisia R. Cialone, PP, AICP, LEED AP, joined the City administration in February of 2017 as the Director of City Planning. She currently represents the City as a member of the New Jersey State League of Municipalities' Land Use Sub-Committee. Prior to joining public service, Annisia practiced urban design and planning with an expertise in the management and design of large-scale urban design and strategic master planning projects for both public and private clients. She holds a Bachelor of Architecture (B. Arch) from The Cooper Union for the Advancement of Science and Art and a Master of Architecture in Urban Design (MAUD) from Harvard University's Graduate School of Design. Ms. Cialone was appointed Director of Housing, Economic Development, and Commerce on August 10, 2018.

**DONNA L. MAUER, Chief Financial Officer**

Donna Mauer holds a B.S. in Business Administration from New Jersey City University and a Masters of Public Administration from Fairleigh Dickinson University. She started employment with the Department of

Finance of the City in 1987. Since that time, she held various positions, including Assistant Budget Officer. On December 14, 2005, Ms. Mauer was appointed Chief Financial Officer and reappointed on December 17, 2008 and acquired tenure in the position on January 1, 2009.

**City Employees**

As of December 31, 2017, the City had 3,021 employees. The following table shows a breakdown of the City's employees over the past five years:

**CITY EMPLOYEES**

	<u>Permanent</u>	<u>Temporary</u>	<u>Grants/ Enterprise Fund</u>	<u>Water Utility</u>	<u>Total<sup>(1)</sup></u>
December 31, 2017	2,835	71	109	6	3,021
December 31, 2016	2,793	90	36	4	2,923
December 31, 2015	2,581	76	67	5	2,729
December 31, 2014	2,392	70	34	6	2,502
December 31, 2013	2,381	68	55	6	2,510

<sup>(1)</sup> Total does not include Seasonal Employees

Approximately 2,256 of the City's employees are represented by one of 9 different bargaining units. The New Jersey Public Employee Relations Act, as amended, specifies a negotiation and advisory fact finding process (civilian unions) or interest arbitration (uniformed service unions) in the event of a negotiations impasse. The major public employee unions of the City are set forth below with a description of each:

**LOCAL 1064** represent approximately one hundred fifty six (156) fire officers in the rank of Captain, Battalion Chief and Deputy Chief. A new four (4) year collective bargaining agreement was reached for the period January 1, 2017 to December 31, 2020. The basic financial terms were as follows: January 1, 2017 – 1.5%, January 1, 2018 – 1.5%, January 1, 2019, 1.5%, January 1, 2020 – 1.95%.

**LOCAL 1066** represent approximately four hundred and two (402) fire fighters. A new collective bargaining agreement was reached. The basic financial terms were January 1, 2016 – 1.95%, January 1, 2017 – 1.5%, April 1, 2018 – 1.5%; June 1, 2019 – 1.5%..

**THE POLICE SUPERIOR OFFICERS' ASSOCIATION** represents approximately one hundred forty seven (147) Superior Officers in the rank of Sergeant, Lieutenant, Captain and Inspector. A new four (4) year collective bargaining agreement was reached for the period January 1, 2017 to December 31, 2020. The basic financial terms were as follows: January 2017 – 1.5%, January 2018 – 1.5%; January 2019 - 1.5%, January 2020 – 1.1%.

**THE POLICE OFFICERS' BENEVOLENT ASSOCIATION** represents approximately seven hundred and forty-one (741) Police Officers and Detectives below the rank of Sergeant. A new four (4) year collective bargaining agreement was awarded based on an Interest Arbitration award for the period of January 1, 2017 to December 31, 2020. The basic financial terms were as follows (There were no across the board salary increases provided, except as noted herein): January 2017 – all eligible step and longevity increases to be paid; January 2018 – no salary step movement or longevity increases. Officers at top step receive a \$750 increase as added to the top step; January 2019 – all officers eligible for step increases move one step on the salary schedule and all longevity increases shall be paid; January 2020 – No salary step movement or longevity increases. Officers at top step receive a \$850 as added to the top step. The contract also included flat amounts for longevity pay (in lieu of percentage of salary) for new hires for 1/1/17. There were also significant reductions in benefit/comp time and sick leave for additional cost savings. Although the full board of PERC affirmed the arbitrator's decision in this matter, the POBA has appealed this matter to the Appellate Division, where it is still currently pending.



**JERSEY CITY SCHOOL TRAFFIC GUARDS ASSOCIATION** represented all regularly employed non-supervisory school traffic guards. The members of this bargaining unit are now represented by Jersey City Public Employees, Local 245 as per a PERC decision dated 7/30/18.

**JERSEY CITY SUPERVISORS' ASSOCIATION** represents approximately eighty-five (85) civilian Supervisors holding titles above the rank of "foreman", but below the level of Division Head. A four year contract was ratified by the City Council in 2015. The agreement calls for the following salary increases: effective January 2015 - \$1125, January 2016 - \$1400, January 2017 - \$1800, January 2018 - \$1850.

**JERSEY CITY PUBLIC EMPLOYEES, LOCAL 245**, represents approximately one hundred thirty seven (137) foremen and their subordinates, in the Department of Public Works and the Department of Recreation. Also, approximately two hundred (200) non-supervisory school traffic guards. A four year contract was ratified by the City Council in 2015. The agreement calls for the following salary increases: effective January 2015 - \$1125, January 2016 - \$1125, January 2017 - \$1400 and January 2018 - \$1500.

**LOCAL 641 (TEAMSTERS)**, this union joined the City on April 1, 2016, under a prior agreement with the Jersey City Incinerator Authority ("JCIA"). They represent employees under designated titles within the Department of Public Works. Currently, they represent 68 active employees. Their most recent contract 4/1/2016 to 12/31/2018 yields 2016 (.50 increase on hourly rate negotiated by former JCIA); 2017 \$0.00; 2018 \$0.00.

**JERSEY CITY PUBLIC EMPLOYEES, LOCAL 246**, represents approximately four hundred eighty (480) employees who are subordinate to Supervisors in the Mayor's Office, the Department of Administration, the Department of Human Resources, the Department of Law, the Department of Health and Human Services, and the Department of Housing, Economic Development and Commerce, the Office of the City Clerk, the Office of the Tax Assessor, and the Department of Public Safety (non-uniformed). A four year deal has been agreed to as follows: January 2015 - \$1125, January 2016 - \$1125, January 2017 - \$1400 and January 2018 - \$1500.

**INTERNATIONAL UNION OF OPERATING ENGINEERS LOCAL 68-68A-68B, AFL-CIO** represents four (4) employees holding titles of boiler operators or chief engineer. A new four year contract was ratified by the City Council in May 2018. The agreement calls for the following salary increases: effective January 1, 2016 - \$1,450; January 1, 2017 - \$1,450; January 1, 2018 - \$1,800; January 1, 2019 - \$1,850. Several changes were also made to health benefits to align with other union contract changes which will result in further cost savings to the City.

### **The Jersey City Public Schools**

The public school system of the City, the second largest school district in the State, served a total enrollment of approximately 27,330 students for school fiscal year 2017-18. The system employs professional and non-professional personnel, including teacher's aides. The student population is provided with a comprehensive school program including college preparatory programs, vocational training and special education classes housed in regular elementary and secondary schools. In school fiscal year 2017-18, the school district has 4,583 full-time employees. The school system currently includes 25 elementary schools, four middle schools, eight high schools, one regional day, one adult education school and 40 childcare sites.

Since October 1989, the school system has been operated by the State of New Jersey pursuant to the New Jersey Public School Education Act of 1975, as amended, N.J.S.A. 18A:7A-1 *et seq.* The Commissioner of Education appointed a State Superintendent to manage the district.

The State-operated school district enabling legislation, N.J.S.A. 18A:7A-34 *et seq.*, makes provision for the City to provide moneys to the State-operated school district for the payment of operating expenditures. Chapter 139 of the Pamphlet Laws of 1991 provided a mechanism similar to the pre-existing one for the authorization and issuance of school promissory notes and school serial bonds by the City secured by the power and authority of the City to levy ad valorem real property taxes. The Capital Project Control Board of the City's Public Schools has the authority to review and recommend the necessity for capital projects proposed by the Superintendent. Following the adoption of a resolution by the Capital Project Control Board, the Municipal Council of the City shall consider a School bond ordinance. The State, by the takeover of the school system in the City, has not affected, modified or

impaired the authority or the obligation of the City for the levy and collection of sufficient real property taxes to pay the interest and principal on outstanding school debt.

### **Related Authorities and Functions**

Sewer services are provided to the City through the Jersey City Municipal Utilities Authority (the "JCMUA") and solid waste disposal is provided by the JCIA. On December 10, 1997, the Jersey City Sewerage Authority was reorganized to form the JCMUA. On January 15, 1998, the City and the JCMUA executed a Franchise and Service Agreement pursuant to which the JCMUA assumed operation of the City's Water Utility until January 31, 2008. In May 2003, the City and the JCMUA executed an amended and restated franchise and service agreement pursuant to which the JCMUA's obligations to operate the City's Water Utility was extended through March 31, 2028. See "Jersey City Municipal Utilities Authority" and "The Jersey City Incinerator Authority" under "CITY INDEBTEDNESS AND DEBT LIMITS –Other City-Related Obligations" herein.

### **City Budget Requirements - General**

State law imposes specific budgetary procedures upon local government units such as the City. Pursuant to the Local Budget Law, the City is required to have an operating budget, which provides for sufficient cash collections to pay all debt service and operating costs during the fiscal year and, in addition, provide for any statutory and mandatory payments, such as pension and insurance costs, required to be made during the fiscal year.

The City's operating budget must be in the form required by the Division of Local Government Services in the Department of Community Affairs, State of New Jersey (the "Division"). Items of revenue and appropriation are statutorily regulated and must be certified by the Director of the Division (the "Director") prior to final adoption of the budget by the Council. The Director is required to review the adequacy of such appropriations for certification. The Director has no authority over individual operating appropriations, unless a specific amount is required by law, but the review, which focuses on anticipated revenues, is intended to insure revenues are sufficient to pay expenses.

The Business Administrator and Budget Director prepare the Municipal Budget of the City for the Mayor. During the month of November, all department heads are required to submit requests for appropriations for the next budget year and appear before the Business Administrator, the Budget Director and the Council at public hearings to explain their departmental requests. The Mayor then submits his recommended budget to the Council. The Council may reduce any item or items in the budget by a majority vote but may increase any item or items only upon an affirmative vote of two-thirds of the members of the Council. After the budget is introduced, it may be approved on first reading by majority vote of the Council. After the Council approves the budget, it is submitted to the Director for approval and advertised. A public hearing is held. Upon completion of the public hearing, the budget is adopted by the Council and submitted to the Division for certification.

The City has transitioned from a State fiscal year to a calendar fiscal year. Under State law, the City is required to have a budget adopted by March 20, although the Director, with the approval of the Local Finance Board, may extend this date and the Municipal Council may adopt the budget within ten days after the Director shall have certified his approval thereof pursuant to N.J.S.A. 40A:4-5.1. For Calendar Year 2015, the budget was introduced on March 11, 2015 and adopted on July 28, 2015. For Calendar Year 2016, the budget was introduced on February 24, 2016 and adopted on July 20, 2016. For Calendar Year 2017, the budget was introduced on March 22, 2017 and adopted on July 10, 2017. For Calendar Year 2018, the budget was introduced on March 14, 2018 and adopted on July 18, 2018.

Prior to formal budget adoption, the City uses a temporary operating budget to guide expenditures. Temporary appropriations may be made pursuant to N.J.S.A. 40A:4-19.1 and, in addition, emergency temporary appropriations may be made pursuant to N.J.S.A. 40A:4-20. The City's budget for the first quarter of its calendar year (January 1 through March 31) is equal to one-fourth of the annual budget for the preceding calendar year. If a budget for a calendar year is not adopted by March 31, the City establishes periodic temporary budgets.

The monitoring of the budget is a continuous process, and encompasses financial controls in the areas of encumbrance of obligations and public contracts law. Under State law, expenditures cannot be made unless there is a certification as to availability of funds from the operating or capital budget. The budget is utilized throughout the operating year as a management tool and policy instrument representing the City's plan of action for the provision of

services. Expenditures are monitored throughout the year and, two months before the end of the fiscal year, the budget may be amended to transfer expenditures from one line item to another. Emergency appropriations may be made to the extent revenues are insufficient to pay expenditures, with the amounts so appropriated raised in the succeeding fiscal year.

No local unit in New Jersey is permitted to issue long-term bonds for the payment of current expenses or to pay outstanding obligations (except for the refunding or repayment of successful real property tax appeals and certain statutorily authorized non-recurring expenses, which requires the approval of the Local Finance Board). Like other New Jersey municipalities, the City makes a major portion of its expenditures early in each year while receipts are heaviest late in the year. The City has managed this cash flow imbalance through temporary transfers from its capital and grant accounts, and restoring these funds by year end with the tax and State aid revenues received. A local unit may issue tax anticipation notes for the payment of current expenses under the Local Budget Law. The City has not issued tax anticipation notes since April 1991.

### **Public School Budgeting Process**

Under the provisions of the New Jersey Public Education Act of 1975, as amended, the Superintendent of a State-operated school district, after preparation of and hearing on a proposed budget, is required to fix and determine the amount of money necessary to be appropriated for the school year and is required to certify the amounts to be raised by taxes. The City may appeal to the Commissioner of Education the amount determined necessary. The Commissioner, upon receipt of such appeal and completion of the hearing process, shall determine the amount necessary for the district to provide a thorough and efficient educational program including the implementation of the plan to correct deficiencies. The City may apply to the Director of the Division for a determination that the local share of revenues needed to support the district's budget results in an unreasonable tax burden. Based upon this review, the Director certifies the amount of revenues, which can be raised locally to support the budget of the State-operated district. Any difference between the amount which the Director certifies and the total amount of local revenues required by the budget approved by the Commissioner is paid by the State in the fiscal year in which the expenditures are made, subject to the availability of appropriations. The State supplemented the City's school tax revenues with \$20,000,000 for the Fiscal Year 1999. Since Fiscal Year 2000, the State has not supplemented the City's school tax revenues.

### **Limitation on Expenditures**

Section 40A:4-45.3 of the Local Budget Law, commonly known as the "Cap Law," as enacted provided that a municipality shall limit any increase in its operating budget to five percent or the calculated Index Rate, whichever is less, over the previous year's final appropriations, subject to certain exceptions. The Local Finance Board has the authority, under Section 40A:4-45.3 of the Local Budget Law, to grant additional exceptions to the Cap Law under certain circumstances. The Index Rate is defined as the annual percentage increase in the Implicit Price Deflator for State and Local Government Purchasers of Goods and Services produced by the United States Department of Commerce as announced by the Director. Municipalities may elect, upon adoption of an ordinance, to approve an increase in appropriations that is greater than the Index Rate, not to exceed five percent, when the Index Rate is less than five percent. Major exceptions not subject to the spending limitation include: capital expenditures and debt service; State and Federal appropriations; expenditures mandated as a consequence of certain public emergencies; certain expenditures mandated by law; cash deficits of the preceding year approved by the Local Finance Board; amounts required to be paid pursuant to any contract with respect to use, services or provision of any project, facility or public improvement for water, sewer, solid waste, parking, senior citizen housing or similar purpose, or payments on account of debt service therefor or lease payments as made with respect to a facility owned by a county improvement authority where such lease payments are a necessity to amortize debt of the authority; amounts expended to meet the standards established by the New Jersey Public Employees' Occupational Safety and Health Act; amounts appropriated for expenditures resulting from impact of a hazardous waste facility; any expenditure mandated as a result of a natural disaster, civil disturbance or other emergency that is specifically authorized pursuant to a declaration of an emergency by the President of the United States or by the Governor; expenditures for the cost of services mandated by any order of court, statute or administrative rule issued by a State agency which has identified such cost as mandated expenditures on certification to the Local Finance Board by the State agency; and amounts reserved for uncollected taxes. The "Cap Law" does not limit the obligation of the City to levy ad valorem taxes upon all taxable real property within the City to pay debt service.

On June 21, 2004, the Legislature enacted amendments to the "Cap Law", under which municipalities are required to limit any increase in its operating budget to 2.5% or the "cost-of-living adjustment" (formerly known as the "Index Rate"), whichever is less, over the previous year's final appropriations, subject to certain exceptions. Municipalities are permitted to elect, upon adoption of an ordinance, to approve an increase in appropriations that is greater than the cost-of-living adjustment, not to exceed 3.5%, when the cost-of-living adjustment is less than or equal to 2.5%. However, the amendment eliminates the existing option to exceed the current 5% increase, but not to exceed the Index Rate, when the Index Rate is greater than 5%. The amendment also eliminates certain of the exceptions to the spending limitation, including: amounts expended to meet the standards established by the New Jersey Public Employees' Occupational Safety and Health Act; amounts appropriated for expenditures resulting from the impact of a hazardous waste facility; amounts appropriated for the cost of administering a joint insurance fund; amounts appropriated for the cost of implementing an estimated tax billing system and the issuance of tax bills thereunder; and amounts expended to pay the salaries of police officers hired under the federal "Community Oriented Policing Services" program. The amendment also requires Local Finance Board approval to utilize existing exceptions for: expenditures of amounts actually realized in the local budget year from the sale of municipal assets; and expenditures related to the cost of conducting and implementing a total property tax levy sale. The exception for amounts expended for the staffing and operation of the municipal court was replaced with an exception for newly authorized operating appropriations for the municipal court or violations bureau when approved by the vicinage Presiding Judge of the Municipal Court after consultation with the mayor and governing body of the municipality.

The "Cap Law" is subject to frequent amendment by the Legislature. See "CITY REVENUES - Property Tax Reform" below.

Additionally, legislation constituting P.L. 2010, c. 44, effective July 13, 2010, imposes a two percent (2%) cap on the tax levy of a municipality, county, fire district or solid waste collection district, with certain exceptions and subject to a number of adjustments. The exclusions from the limit include increases required for capital expenditures, including debt service, increases in pension contributions in excess of 2%, certain increases in health care over 2%, and extraordinary costs incurred by a local unit directly related to a declared emergency. The governing body of a local unit may request approval, through a public question submitted to the legal voters residing in its territory, to increase the amount to be raised by taxation, and voters may approve increases above 2% not otherwise permitted under the law by an affirmative vote in excess of 50%.

The Division has advised that counties and municipalities must comply with both budget "CAP" and the tax levy limitation. Neither the tax levy limitation nor the "CAP" law, however, limits the obligation of the City to levy ad valorem taxes upon all taxable property within the boundaries of the City to pay debt service on bonds and notes.

In accordance with the Local Budget Law, each local unit must adopt and may from time to time amend rules and regulations for capital budgets, which rules and regulations must require a statement of capital undertakings underway or projected for a period not greater than over the next ensuing six years as a general improvement program. The capital budget, when adopted, does not constitute the approval or appropriation of funds, but sets forth a plan of the possible capital expenditures, which the local unit may contemplate over the next six years. Expenditures for capital purposes may be made either by ordinances adopted by the governing body setting forth the items and the method of financing or from the annual operating budget if the terms were detailed.

### **Anticipation of Real Estate Taxes**

With regard to current taxes, Section 40A:4-41 of the Local Budget Law provides that "receipts from the collection of taxes levied or to be levied in the municipality, or in the case of a county for general county purposes and payable in the fiscal year shall be anticipated in an amount which is not in excess of the percentage of taxes levied and payable during the next preceding fiscal year which was received in cash by the last day of the preceding fiscal year."

This provision requires that the City establish a non-spending appropriation reserve for uncollected taxes in the current year as a percentage of the current levy equal to the percent uncollected of the prior year's levy. This additional amount must be added to the tax levy required in order to balance the budget.

Section 40A:4-29 of the Local Budget Law sets limits on the anticipation of delinquent tax collections: "The maximum which may be anticipated is the sum produced by the multiplication of the amount of delinquent taxes unpaid and owing to the local unit on the first day of the current fiscal year by the percentage of collection of delinquent taxes for the year immediately preceding the current fiscal year."

The City school district and the County receive 100% of their tax levies, which are collected and paid to them by the City. As a result of the structure of the State's system of taxation, the City, along with other similarly situated municipalities, bears the full burden of the uncollected taxes.

### **Anticipation of Miscellaneous Revenues**

Section 40A:4-26 of the Local Budget Law provides: "No miscellaneous revenues from any source shall be included as an anticipated revenue in the budget in an amount in excess of the amount actually realized in cash from the same source during the next preceding fiscal year, unless the Director shall determine upon application by the governing body that the facts clearly warrant the expectation that such excess amount will actually be realized in cash during the fiscal year and shall certify such determination, in writing, to the local unit."

### **Deferral of Current Expenses**

Supplemental emergency appropriations may be authorized by the governing body of the City after the adoption of the budget and determination of the tax rate. However, with minor exceptions, such appropriations must be included in full in the following year's budget. Under Sections 40A:4-48 and 40A:4-49 of the Local Budget Law, any emergency appropriation must be declared by resolution according to the definition provided in Section 40A:4-46 of the Local Budget Law, approved by at least two-thirds of the governing body and must also be approved by the Director if all emergency appropriations made during the year exceeds 3% of the total current and utility operating appropriations in the budget for that year.

### **Protection of Municipal Funds and Investment Policy**

The City complies with the State statutory and regulatory requirements for the deposit and investment of public monies. The City on a daily basis deposits cash receipts in institutions located in New Jersey which are approved by the State and are insured by the Federal Deposit Insurance Corporation or by other agencies of the United States (although the amount of the City's deposit may exceed the insurance coverage limits) or in the State of New Jersey Cash Management Fund. The Cash Management Fund, which was established in 1977, is a short-term investment pool for the State and its cities, towns and school districts. The investments held by the Cash Management Fund must have average maturities not exceeding one year. The types of investments are regulated by the State Investment Council. The regulations allow investment in repurchase agreements with the purchased securities held by a custodian. The regulations also permit reverse repurchase agreements; however, the proceeds are invested in the Cash Management Fund.

In addition to making deposits with the above described financial institutions, pursuant to N.J.S.A.40A:5-15.1, the City is permitted to purchase the following types of securities as investments:

- 1) Bonds or other obligations of the United States of America or obligations guaranteed by the United States of America (Treasury Bills, notes and bonds).

- 2) U.S. Government money market funds.
- 3) Any obligation that a Federal agency or a Federal instrumentality has issued in accordance with an Act of Congress, which security has a maturity date not greater than 397 days from the date of purchase, provided that such obligation bears a fixed rate of interest not dependable on any index or other external factor.
- 4) Bonds or other obligations of the local unit or bonds or other obligations of school districts of which the local unit is a part or within which the school district is located.
- 5) Bonds or other obligations, having a maturity date not more than 397 days from the date of purchase, approved by The Department of Treasury, Division of Investments.
- 6) Local government investment pools, such as New Jersey Class, and the New Jersey Arbitrage Rebate Management Program.
- 7) Deposits with the State of New Jersey Cash Management Fund.
- 8) Repurchase agreements of fully collateralized securities, if:
  - a) The underlying securities are permitted investments pursuant to N.J.S.A. 40A: 5-15.1;
  - b) The custody of the collateral is transferred to a third party;
  - c) The maturity of the agreement is not more than 30 days;
  - d) The underlying securities are purchased through banks approved by the Department of Banking and Insurance under the Government Unit Depository Projection Act. ("GUDPA").
  - e) A master repurchase agreement providing for the custody and security of the collateral is executed.

Compliance with the State statutes may not assure that the City's investments will have the liquidity, security or adequate deposit insurance to protect the City against all losses. For example, the relevant deposit statute, N.J.S.A.17:9-44, only requires public depository banks to maintain collateral for deposits of public funds exceeding insurance limits (\$100,000) generally equal to five percent of the average daily balance of public funds. Additionally, the State has the power to require that all banks holding public funds contribute amounts sufficient to reimburse an eligible municipality if any bank holding public funds becomes insolvent. However, it is unclear how quickly other state-qualified depositories could act to reimburse an exposed municipality through the State supervised program which may result in limited liquidity and a shortage of cash for the City and other municipalities in the State. Furthermore, it is currently unclear whether the State of New Jersey Cash Management Fund could maintain sufficient liquidity during a period of economic stress if many municipalities including the City sought the immediate return of cash.

### **CITY INDEBTEDNESS AND DEBT LIMITS**

State law regulates the issuance of debt by local government units. No local unit is permitted to issue bonds for the payment of current expenses or to pay outstanding obligations, except for, among certain other limited purposes, refunding purposes with the approval of the Local Finance Board. Like other New Jersey municipalities, the City makes a major portion of expenditures early in each year while receipts are heaviest late in the year. Historically, the City has managed this cash flow imbalance through temporary transfers from its capital and grant accounts and restores these funds with the tax and State aid revenues received by year-end. The City also has options, which it may exercise to reduce, defer or fund appropriations remaining at the end of a fiscal year for which insufficient cash is available. The Local Budget Law empowers the City to issue, but limits the amount of, tax anticipation notes ("TANs") that may be issued and requires the repayment of such notes within four months of the end of the fiscal year in which issued. The City has not issued TANs since April 1, 1991.

#### **Debt Limits**

State statutes set forth debt limits for counties and municipalities. The City's net debt is limited by the Local Bond Law to an amount equal to 3.50% of its average equalized valuation basis. The average equalized valuation basis of the City is set by statute as the average for the last three preceding years of the sum total of (a) the

aggregate equalized valuation of real property together with improvements and (b) the assessed valuation of Class II railroad property within its boundaries as annually determined by the State Board of Taxation. See "CITY REVENUES – Equalization Rate and Tax Collection Rates" herein for a discussion of the City's assessed valuations. The debt limit pursuant to Title 18A of the New Jersey Statutes for the City school district, a Type I district of the first class, is 8% of such average valuation basis. Certain categories of debt are permitted by statute to be deducted for purposes of computing the statutory debt limit. Pursuant to law, the City has deducted the amount of authorized school debt.

#### **Exception to Debt Limit - Extensions of Credit**

The debt limit of the City may be exceeded only with the approval of the Local Finance Board. If all or any part of a proposed debt authorization would exceed its debt limit, the City must apply to the Local Finance Board for an extension of credit. An extension of credit may be granted based on a formula tied to the annual retirement of principal or need to protect the health, welfare or safety of the residents in a municipality. The Local Finance Board considers the request, concentrating its review on the effect of the proposed authorization on outstanding obligations. If the Local Finance Board determines pursuant to statute and regulation that a proposed debt authorization would materially impair the ability of the City to meet its obligations or to provide essential services, approval is denied.

In calendar years ending December 31, 2014, December 31, 2015, December 31, 2016 and December 31, 2017, total debt as a percentage of the equalized value of the City was 2.59%, 2.26%, 2.04% and 1.655%, respectively.

State law permits the City school district acting through the Municipal Council to authorize debt in excess of its individual debt limit. It does so by using the borrowing capacity of the City for school purposes after the school debt margin has been exhausted. The Local Finance Board is involved only if the proposed debt authorization exceeds the debt limit of both the City and the City school district.

#### **Exception to Debt Limit - Real Property Tax Appeal Refunding Notes**

The City revalued the real property located in the City in 1988. See "CITY REVENUES -- Equalization Rate and Tax Collection Rates". After the revaluation, the number of tax appeals increased substantially. In order to file a tax appeal, a property owner must first pay the taxes that are owed. If the appeal is successful, the taxes are then refunded to the owner. The refund may occur in a fiscal year subsequent to the fiscal year in which the owner paid the taxes. Because of the magnitude of the tax appeals and the amount that was required to be refunded, the Local Finance Board and the Municipal Council have allowed the City to issue tax refunding obligations to finance the tax refunds. The tax refunding obligations issued to date are one-year notes, renewable annually for five to seven years after their date of issuance, with the amortization schedule approved by the Local Finance Board. As of December 31, 2015, \$2,738,740 principal amount of real property tax appeal refunding notes were outstanding. As of December 31, 2016 principal amount was fully paid and none were outstanding.

#### **Debt Statements**

The City must report all new authorizations of debt or changes in previously authorized debt to the Division through the filing of Supplemental and Annual Debt Statements. The Supplemental Debt Statement must be submitted to the Division before final passage of any debt authorization. Before the end of the first month of each fiscal year, the City must file an Annual Debt Statement as of the last day of the preceding fiscal year with the Division. Through the Annual and Supplemental Debt Statements, the Division monitors all local borrowing.

In calculating the debt limit, the City is allowed to deduct certain types of debt. Deductions from gross debt are allowed for school purposes of an amount equal to 8% of average equalized valuations and for any additional State School Building Aid Bonds authorized (P.L. 1968, c. 177, as amended P.L. 1971, c. 10, as amended and P.L. 1978, c. 74). The deduction from municipal gross debt includes bonds issued and bonds authorized but not issued to meet cash grants-in-aid for a housing authority, redevelopment agency or municipality acting as its local redevelopment entity (Section 40A:12A-37(d) of the Local Redevelopment and Housing Law) and funds in hand (including proceeds of bonds held to pay other bonds).

The following table sets forth the amount of debt that the City has outstanding, authorized but not yet issued as well as deductions for each purpose (school, municipal and water) and the amount of debt that the City has authorized for each purpose but has not yet incurred. In addition, the table sets forth the amount of debt that has been issued by public bodies but that the City is or may be responsible for paying. See "Other City-Related Indebtedness". The table then sets forth the amount of the debt that, pursuant to State law, is excluded from the calculation of the debt limitations imposed on the City. Such deductions include debt for school purposes (a portion of which are subject to their own debt limitation), debt for the water utility because it operates on a self-liquidating basis, refunding debt, debt issued in anticipation of grants and bonds issued by public entities (even though the City may be responsible for all or a portion of the debt service on such debt). As shown in the table, although the City's gross debt as of December 31, 2017 was \$650,331,188, only \$417,807,408 of that debt is included for purposes of calculating the debt limitation on the City.

The table also shows the statutory net debt as a percentage of the average equalized value of property in the City (the average calculated for the past three years). See "CITY REVENUES - Real Estate Tax" herein. In addition to the debt detailed on this table, since 1990 the City has issued real property tax appeal refunding notes in each year. Prior to February 3, 2003, such real property tax appeal refunding notes were not included in the City's debt statements. After that date, newly authorized real property tax appeal refunding notes are included in gross debt, but are deducted in calculating net debt. See "Exception to Debt Limit – Real Property Tax Appeal Refunding Notes" herein.



**Annual Debt Statement  
As of December 31, 2017**

Gross Debt:		
School Purposes:		
Issued and Outstanding:		
Bonds .....	\$20,830,000	
Authorized But Not Issued .....	1,587,258	
Total School .....		\$22,417,258
Municipal Purposes:		
Issued and Outstanding:		
Bonds .....	422,066,000	
Notes .....	24,901,000	
Green Trust Loan .....	950,779	
Authorized But Not Issued .....	27,749,629	
Total Municipal .....		475,667,408
Issued by Public Bodies Guaranteed by the Municipality:		
Jersey City Municipal Utilities Authority .....		<u>152,246,522</u>
Total Gross Debt .....		\$650,331,188
Statutory Deductions:		
For School Purposes - Statutory 8% .....	22,417,258	
For Jersey City Municipal Utilities Authority - Water .....	21,150,000	
For ERI Pension Refunding .....	36,710,000	
For Bonds Issued by Public Bodies Guaranteed by the Municipality .....	152,246,522	
Total Statutory Deductions .....		<u>232,523,780</u>
Statutory Net Debt .....		<u>\$417,807,408</u>
Statutory Net Debt Percentage .....		1.655%

Source: Derived from the Annual Debt Statement of the City for Calendar Year. 2017

The following table summarizes the information included in the preceding table, and shows, among other things, the gross debt outstanding for each purpose, the amount of such debt allowed under State law to be excluded from the calculation of the debt limitation and the statutory net debt.

**Statutory Debt as of December 31, 2017**

	<u>Gross Debt</u>	<u>Deductions</u>	<u>Net Debt</u>
School Purposes	\$22,417,258	\$22,417,258	\$ -0-
Municipal Purposes	475,667,408	57,860,000	417,807,408
Other Public Bodies Guaranteed by City	<u>152,246,522</u>	<u>152,246,522</u>	<u>-0-</u>
<b>Total</b>	<b><u>\$650,331,188</u></b>	<b><u>\$232,523,780</u></b>	<b><u>\$417,807,408</u></b>
Average Equalized Valuation of Real Property (Yrs. 2015-2017)			\$25,242,322,640
Statutory Net Debt			1.655%
Debt Limitation Per N.J.S.A. 40A:2-6 (Municipalities – 3.50% of Three Year Average Equalized Valuation)			883,481,292
Total Net Debt			<u>417,807,408</u>
Remaining Net Debt Capacity			<u>\$465,673,884</u>

Source: Derived from the Annual Debt Statement of the City for Calendar Year 2017

The table below outlines the total debt of the City and sets forth the amount that the debt represents per capita for the last five years.

	<u>December 31, 2017</u>	<u>December 31, 2016</u>	<u>December 31, 2015</u>	<u>December 31, 2014</u>	<u>December 31, 2013</u>
Gross Debt <sup>(1)</sup>	\$650,331,188	\$749,388,145	\$775,072,007	\$844,917,507	\$852,306,655
Net Debt Statutory <sup>(2)</sup>	417,870,408	455,704,061	450,883,637	482,163,575	475,739,968
Population <sup>(3)</sup>	247,597	247,597	247,597	247,597	247,597
Gross Debt per Capita	2,628	3,027	3,130	3,412	3,442
Net Debt per Capita	1,688	1,841	1,821	1,947	1,921
Net Debt - Statutory Percentages	1.655%	2.04%	2.26%	2.59%	2.60%

<sup>(1)(2)</sup> The figures representing Gross Debt and Net Debt Statutory are derived from the Annual Debt Statements of the City.

<sup>(3)</sup> Source: U.S. Department of Commerce, Bureau of the Census.

The following table lists the total bonded debt of the City for the last five years.

	<u>December 31, 2017</u>	<u>December 31, 2016</u>	<u>December 31, 2015</u>	<u>December 31, 2014</u>	<u>December 31, 2013</u>
Bonds:					
General	\$400,916,000	\$440,203,000	\$437,405,950	\$ 468,125,950	\$ 460,262,950
School	20,830,000	27,155,000	39,510,000	47,130,000	55,220,000
Water	21,150,000	25,590,000	28,645,000	31,130,000	34,450,000
Other	<u>152,246,522</u>	<u>199,455,227</u>	<u>199,163,381</u>	<u>208,862,507</u>	<u>206,156,132</u>
Total Outstanding Bonds	595,142,522	692,403,227	704,724,331	755,298,457	756,089,082
Notes:					
General	24,901,000	26,898,194	40,602,842	33,297,813	39,436,000
School	-0-	-0-	-0-	-0-	-0-
Water	-0-	-0-	-0-	-0-	-0-
Other (Loan)	<u>950,779</u>	<u>1,056,008</u>	<u>1,159,954</u>	<u>1,622,571</u>	<u>2,083,185</u>
Total Outstanding Notes	<u>25,851,779</u>	<u>27,954,202</u>	<u>41,762,796</u>	<u>34,920,384</u>	<u>41,519,185</u>
Total Bonds and Notes Issued and Outstanding	620,994,301	720,357,429	746,487,127	790,218,841	797,608,269
Bonds and Notes Authorized but Not Issued					
General	27,749,629	25,911,859	14,228,631	27,015,111	27,014,831
School	1,587,258	1,587,258	4,265,245	6,216,026	6,216,027
Water	0	1,531,599	10,091,004	21,467,528	21,467,528
Other	<u>-0-</u>	<u>-0-</u>	<u>-0-</u>	<u>-0-</u>	<u>-0-</u>
Total Bonds and Notes Authorized But Not Issued	29,336,887	29,030,716	28,584,880	54,698,665	54,698,386
Total Issued and Outstanding, and Authorized But Not Issued	<u>\$650,331,188</u>	<u>\$749,388,145</u>	<u>\$775,072,007</u>	<u>\$844,917,506</u>	<u>\$852,306,655</u>

Source: Derived from the Annual Debt Statements of the City.

Included in the debt shown on this table are tax appeal refunding notes of the City outstanding for the 5 year period. The following table sets forth the amount of tax appeal refunding notes that were issued and outstanding in each of the four years preceding such date.

**Real Property Tax Appeal Refunding Notes Outstanding**

<u>Year</u>	<u>Amount Issued<sup>(1)</sup></u>	<u>Balance end of year</u>
December 31, 2017	-0-	-0-
December 31, 2016	-0-	-0-
December 31, 2015	-0-	2,738,740
December 31, 2014	-0-	6,917,870
December 31, 2013	-0-	11,097,000

Source: Derived from the Calendar Year 2011-2016 Audited Financial Statements of the City and unaudited Calendar Year 2017 Annual Financial Statement.

<sup>(1)</sup> These amounts do not include tax appeal refunding notes issued to refund prior issues of tax refunding notes.

The table below sets forth the total overlapping debt of the City for the last five years. The County of Hudson (the "County") debt overlap was 35.55% in 2017, 34.28% in 2016, 33.84% in 2015, 32.42% in 2014, and 31.54% in 2013. The overlap for all other debt was 100%. The City's percentage of overlap for County debt is determined by the State based on (i) the assessed value of Class II Railroad Property in the City and (ii) the true value of real property in the City. The sum of these two figures is used to calculate a percentage of the sum of the assessed value of Class II Railroad Property in the County, plus the true value of real property in the County. Overlapping debt is debt for which the City is not required to levy taxes.

**Schedule of Overlapping Debt<sup>(1)</sup>**

	<u>December 31, 2017</u>	<u>December 31, 2016</u>	<u>December 31, 2015</u>	<u>December 31, 2014</u>	<u>December 31, 2013</u>
Jersey City Municipal Utilities Authority <sup>(2)</sup>	\$ 152,246,522	\$ 199,455,227	\$ 199,163,381	\$ 208,862,507	\$ 206,156,132
Hudson County <sup>(3)</sup>	<u>309,294,655<sup>(4)</sup></u>	<u>337,512,996<sup>(5)</sup></u>	<u>420,990,123<sup>(6)</sup></u>	<u>352,730,118<sup>(7)</sup></u>	<u>346,822,019<sup>(8)</sup></u>
<b>TOTAL</b>	<u>\$ 461,541,177</u>	<u>\$ 536,968,223</u>	<u>\$ 620,153,504</u>	<u>\$ 561,592,625</u>	<u>\$ 552,978,151</u>

Source: Derived from the Annual Debt Statements of the County and City.

<sup>(1)</sup> The outstanding debt of the Hudson County Utilities Authority, the Rockaway Valley Regional Sewerage Authority and the Hudson County Improvement Authority are not included (see further discussion herein).

<sup>(2)</sup> The Jersey City Sewerage Authority was reorganized as the Jersey City Municipal Utilities Authority on January 15, 1998.

<sup>(3)</sup> Hudson County reports on a calendar year ending December 31.

<sup>(4)</sup> This figure represents 35.55% of the total County Gross Debt of \$ 869,929,296.

<sup>(5)</sup> This figure represents 34.28% of the total County Gross Debt of \$ 984,703,577.

<sup>(6)</sup> This figure represents 33.84% of the total County Gross Debt of \$1,244,155,190.

<sup>(7)</sup> This figure represents 32.42% of the total County Gross Debt of \$1,088,024,659.

<sup>(8)</sup> This figure represents 31.54% of the total County Gross Debt of \$1,099,534,929.

The table below lists the principal and interest repayment schedule on all outstanding bonds of the City from 2018 through 2040.

**Combined Principal and Interest Repayment Schedule  
Outstanding Bonds of the City  
As of December 31, 2017**

<u>CALENDAR YEAR</u>	<u>COMBINED TOTAL</u>	<u>GENERAL</u>	<u>PENSION</u>	<u>WATER</u>	<u>SCHOOL</u>
2018	73,296,840	53,668,057	7,233,435	5,250,243	5,561,763
2019	73,157,100	58,544,985	3,880,375	3,880,940	5,256,763
2020	76,782,940	64,349,812	4,021,257	3,953,011	2,869,646
2021	71,347,663	60,964,114	4,166,738	3,427,963	2,788,848
2022	45,427,173	37,898,854	4,354,641	1,985,527	1,188,150
2023	37,420,749	30,806,135	4,630,161	794,903	1,189,550
2024	30,164,117	24,103,464	4,077,966	798,238	1,184,450
2025	25,011,663	21,863,200	1,498,789	467,249	1,182,425
2026	22,979,672	19,723,453	1,608,334	465,085	1,182,800
2027	22,980,619	19,611,790	1,728,871	462,559	1,177,400
2028	16,456,429	14,132,877	1,859,306	464,245	-
2029	16,453,639	13,985,472	1,993,685	474,482	-
2030	11,040,859	8,435,170	2,136,052	469,638	-
2031	11,085,113	8,325,381	2,285,315	474,418	-
2032	11,106,145	8,192,454	2,445,246	468,446	-
2033	11,152,524	8,065,946	2,614,479	472,099	-
2034	7,580,449	7,580,449	-	-	-
2035	7,443,599	7,443,599	-	-	-
2036	7,222,680	7,222,680	-	-	-
2037	6,557,338	6,557,338	-	-	-
2038	6,423,825	6,423,825	-	-	-
2039	6,288,563	6,288,563	-	-	-
2040	6,130,500	6,130,500	-	-	-
<b>TOTAL</b>	<b><u>\$ 603,510,198</u></b>	<b><u>\$ 500,318,117</u></b>	<b><u>\$ 50,534,647</u></b>	<b><u>\$ 24,309,045</u></b>	<b><u>\$ 23,581,795</u></b>

In addition to the debt service requirements on outstanding bonds, the City also pays debt service on notes. Notes generally mature within one year from their date of issuance. Notes, other than tax appeal refunding notes, may be renewed three times without principal payments and must then be amortized over a ten-year period (unless refunded by bonds). The debt service payable on notes depends on the interest rate established upon the renewal of the notes. For Calendar Year 2013 the amount was \$5,543,710, for Calendar Year 2014 the amount was \$5,634,563, for Calendar Year 2015 the amount was \$5,108,063 and for Calendar Year 2016 the amount was \$6,928,999. For Calendar Year 2017, the City budgeted \$2,619,270 for debt service on the notes and for Calendar year 2018 the City Budgeted \$1,997,200.

**Other City-Related Obligations**

**Rockaway Valley Regional Sewerage Authority.** In compliance with a court decree, the City entered into an agreement, dated July 30, 1971, with the Rockaway Valley Regional Sewerage Authority (“RVRSA”), whereby the City agreed to share in the operating costs of the RVRSA which provides sewerage treatment services in the vicinity of the City's watershed properties. In 2013, 2014 and 2015, the JCMUA contributed \$2,730,857. In 2016 and 2017, the JCMUA contributed \$3,429,757 and \$2,858,130, respectively.

Under the same agreement, the City is also required to pay a share of the capital and operating cost of construction of an advanced treatment sewerage facility, which the RVRSA has designed. Under the current plans, the cost of construction is estimated to be \$60,000,000, less any federal funds, the amount of which is presently

uncertain. Based upon the design capacity, the City will be responsible for 37 1/2% of the excess cost of financing construction over available federal funds. The amount of the City's contribution for the new facility is a portion of the City's share of the operating costs outlined in the immediately preceding paragraph. The RVRSA has permanently financed substantially all of the non-grant share of project costs with the sale of long-term tax-exempt bonds.

**Jersey City Incinerator Authority.** On October 14, 2015, the City adopted an ordinance dissolving the JCIA and assigning its powers to City departments. The JCIA was officially dissolved April 1, 2016. The City has merged all of the responsibilities of the JCIA, included but not limited to the collection and disposal of all residential and municipal solid waste for the City, mechanical and manual street sweeping, cleaning of City owned lots, roll-off container service, recycling, demolition, snow plowing, salting and snow removal into the City Department of Public Works without interruption of services. As the JCIA annual budget was approximately 95% funded by City appropriations, the dissolution has not had any material impact on the financial strength of the City.

**Jersey City Municipal Utilities Authority.** The JCMUA, formerly the Jersey City Sewerage Authority, is responsible for the construction and operation of two pumping stations, at which sewage collected from the City and portions of the City of Union City is pumped to the secondary sewage treatment plant of the Passaic Valley Sewerage Commissioners ("PVSC") at Newark, New Jersey. The JCMUA formerly operated primary sewage treatment plants at the sites of the pumping stations. The Passaic Valley Connection Project, consisting of the pumping stations and connecting sewer lines, was commenced in 1985 and completed in 1989, using certain federal and state grants and funds of the JCMUA, for which the JCMUA issued its bonds. The City of Bayonne and the Town of Kearny each, separately, sought and obtained permission to hook up their own sewage transmission lines to a portion of the JCMUA 's lines, and have agreed to share the costs of the common portions used by them.

The indebtedness of the JCMUA as of December 31, 2017 was \$152,246,522. The JCMUA imposes user charges on all sewer users in its service area, at the rate of \$5.64 per 100 cubic feet of water consumption. The JCMUA imposes user charges on all water users in its service area, at the rate of \$4.14 per 100 cubic feet of water consumption. From its user charge revenues, the JCMUA is required to pay its debt service costs and operating costs of the pumping stations and collector system. The JCMUA also pays, from user charges, operating charges of PVSC which are the obligation of the City.

Pursuant to a Sewer Service Contract between the City and the JCMUA, dated as of December 1, 1985 (the "Sewer Service Agreement"), the City is obligated to pay to the JCMUA any amounts by which the JCMUA's sewer operating expenses and amounts required to be paid or set aside under the JCMUA's bond resolution for its sewer bonds exceed the JCMUA's revenues from user charges. The JCMUA is obligated to increase user charges in future years to make up any such deficiency, and to pay back sums advanced by the City under the Service Contract. No payments by the City have been required since the execution of the Sewer Service Contract.

The Municipal Council adopted an ordinance on December 10, 1997 to reorganize the Sewerage Authority as the JCMUA. The JCMUA and the City initially entered into a water services franchise and service agreement on April 1, 1998 (the "Initial Water Franchise Agreement") pursuant to which a) the JCMUA obtained a franchise from the City to operate the City's Water System for a ten year period which was to terminate on March 31, 2008 and b) the City agreed to provide security for the holders of the obligations of the JCMUA related to the Water System.

The JCMUA and the City agreed in the Amended and Restated Water Services Franchise and Service Agreement dated as of May 1, 2003 (the "2003 Amended Water Franchise Agreement") to: a) provide for the acquisition by the JCMUA from the City of an extension of the franchise granted under the Initial Water Franchise Agreement, in order to operate the Water System through March 31, 2028 (the "2003 Project") and b) provide for the City to continue to provide security to the holders of obligations of the JCMUA which are issued for or with respect to the Water System for the extended franchise period.

In September 2005, the City and the JCMUA entered into the 2005 Amended and Restated Water Services Franchise and Service Agreement (the "2005 Amended Agreement" and together with the Initial Franchise Agreement and the 2003 Amended Water Franchise Agreement, the "Water Franchise Agreement") to reflect a payment schedule for the cost of acquiring the City's water franchise that more accurately reflects the projected availability of revenues to the JCMUA. Pursuant to the Water Franchise Agreement, the JCMUA has agreed to pay the City certain amounts annually from January 1, 2005 to December 31, 2027 for the rights to such franchise, and the City has agreed to convey such franchise rights to the JCMUA and to provide for the payment annually, if

necessary, of any deficiencies in Water Revenues of the JCMUA in connection with the Water System. As required by the Water Franchise Agreement, the City, by ordinance adopted on September 14, 2005, consented to the JCMUA's issuance of \$17,000,000 Water Revenue Refunding Bonds on December 13, 2005, which are secured by the provisions of the Water Franchise Agreement and the Sewer Service Contract.

The Water Franchise Agreement is subject to the existing private management operating agreement in effect between the City and United Water Resources executed in 1996.

Under the Water Franchise Agreement, the City will continue to authorize indebtedness for necessary water capital improvements and the JCMUA will continue to be responsible to reimburse the City for debt service on this indebtedness. The City will also continue its obligation to make payments of any necessary annual charges or deficiency payments in the event the JCMUA does not collect sufficient revenues in any year to provide for the expenses of operation of the Water System, to maintain required reserves, and to pay annual water related debt service when due. Since 1998, the City has not been required to make any annual payment to the JCMUA under the Water Franchise Agreement. The JCMUA has taken a number of financial measures to assure that it can meet all of its operations, maintenance and debt service obligations, including required payments to the City pursuant to the Water Franchise Agreement. These measures include (i) the provision of necessary improvements from time to time to the water and sewer system, (ii) the amendment of the Water Franchise Agreement in order to reschedule the annual payments to the City to more accurately match the revenues projected to be generated by the JCMUA during the life of the Water Franchise Agreement, which runs through December 31, 2027, (iii) a rate increase of 15% effective July 1, 2005, (iv) the approval by the JCMUA of annual CPI rate increases, and (v) the restructuring of certain outstanding water and sewer system debt of the Authority based upon the projected revenues once the rate increases are in effect and the financial measures implemented.

**Jersey City Medical Center.** The Jersey City Medical Center is a voluntary not-for-profit hospital independent of the City. Previously, the Medical Center had been a public hospital.

The City contributed \$12 million for the construction cost of a new hospital facility in the Liberty Harbor North Redevelopment Area to replace the old Medical Center's buildings. The new building started operation on May 15, 2004.

### **The County of Hudson**

The City is located in the County and, in accordance with the regulations governing financial reporting for New Jersey Municipalities, a pro rata share of certain direct debt of the County is treated as "Overlapping Debt" of the City for financial reporting purposes. See "Schedule of Overlapping Debt" herein.

The County issues its bonds and notes for the financing of capital projects of the County, including County roads, buildings, parks and educational facilities. Major facilities of the County that were financed in recent years include a golf course and administration building. In addition, the County guarantees certain of the debt of the Hudson County Improvement Authority.

The gross debt of the County as of December 31, 2017 was \$869,929,296 and its net statutory debt was \$495,001,619.

### **Municipal Qualified Bond Act**

In addition to being secured by the pledge of the City's full faith and credit, certain bonds of the City are entitled to the benefits of the Municipal Qualified Bond Act, Title 40A of the New Jersey Statutes, Section 40A:3-1, et seq., as amended (the "Municipal Qualified Bond Act"). Pursuant to the Municipal Qualified Bond Act, a portion of certain State aid allocated to the City, in amounts sufficient to pay debt service on such bonds, is to be withheld by the State Treasurer and forwarded to the paying agent on or before the principal and interest payment dates for such bonds for deposit into accounts established for the purpose of paying debt service on such bonds.

Pursuant to the provisions of the Municipal Qualified Bond Act, the City shall certify to the State Treasurer the name and address of the paying agent, maturity schedule, interest rate or rates and dates of payment of debt service on any Qualified Bonds within ten days after the issuance thereof. After receipt of such certificate, the State Treasurer is required to withhold with respect to such bonds from the amount of business personal property tax

replacement revenues, gross receipts tax revenues (now known as “energy receipts” tax revenues), municipal purposes tax assistance fund distributions and certain other funds appropriated as State aid payable to the City and not dedicated to a specific purpose by the State (the “municipal qualified revenues”) an amount which will be sufficient to pay debt service on such bonds as it becomes due. Municipal qualified revenues do not include Aid to Distressed Cities.

The Municipal Qualified Bond Act provides that the municipal qualified revenues so withheld and paid or to be paid to and held by the paying agent are deemed to be held in trust and exempt from being levied upon, taken, sequestered or applied toward paying the debts of the City other than the payment of debt service on any such Qualified Bonds of the City issued for municipal purposes (including fiscal year adjustment or pension obligation purposes) or water utility purposes and entitled to the benefits of the Municipal Qualified Bond Act.

The Municipal Qualified Bond Act does not relieve the City of its obligation to include in its annual budget amounts necessary to pay, in each year, the principal of and interest becoming due on any such Qualified Bonds. However, such budgeted amounts may be applied to the payment of operating expenses of the City for the then current year to the extent that appropriated amounts have been withheld from the municipal qualified revenues payable to the City and have been forwarded to the paying agent. Such budgeted amounts must be used to pay debt service becoming due on any such Qualified Bonds of the City issued for municipal purposes (including fiscal year adjustment or pension obligation purposes) or water utility purposes and entitled to the benefits of the Municipal Qualified Bond Act in any year in which sufficient municipal qualified revenues are not appropriated.

The State has covenanted in the Municipal Qualified Bond Act with the holders of bonds entitled to the benefits of such act, that it will not repeal, revoke, rescind, modify or amend the provisions of such act providing for the withholding of municipal qualified revenues and payment of such revenues to the paying agent for such bonds so as to create any lien or charge on or pledge, assignment, diversion, withholding payment or other use of or deduction from such revenues which is prior in time or superior in right to the payment of debt service on such bonds.

*The Municipal Qualified Bond Act does not contain a pledge or guarantee that any amounts payable to the Paying Agent will, in fact, be made or continued. Each such annual amount is subject to appropriation by the State Legislature. Moreover, the State is not required to continue to make appropriations of such amounts, nor is the State limited or prohibited from repealing or amending any law heretofore or hereafter enacted for the payment or apportionment of such amounts or in the manner, time or amount thereof. Further, the amount payable to the Paying Agent does not constitute an additional source of revenues available to the City.*

The table below shows the qualified revenues, debt service on bonds subject to the Municipal Qualified Bond Act, and coverage ratios for the last five years. State aid is distributed by the State to the City on a “phased aid” schedule.



	<u>December 31, 2017</u>	<u>December 31, 2016</u>	<u>December 31, 2015</u>	<u>December 31, 2014</u>	<u>December 31, 2013</u>
<b>Qualified Revenues:</b>					
Energy Receipt Tax:	\$53,436,478	\$53,091,740	\$53,091,740	\$ 52,031,160	\$ 51,682,679
Consolidated Municipal Property Tax Relief Act:	<u>10,408,207</u>	<u>10,431,997</u>	<u>10,752,945</u>	<u>11,813,525</u>	<u>12,162,006</u>
<b>Total Qualified Revenues:</b>	<u>\$63,844,685</u>	<u>\$63,523,737</u>	<u>\$63,844,685</u>	<u>63,844,685</u>	<u>63,844,685</u>
<b>Debt Service:</b>					
General Improvement Bonds:	42,057,299	35,197,742	42,287,805	43,533,669	43,127,075
Water Bonds:	<u>5,189,955</u>	<u>3,895,054</u>	<u>3,493,569</u>	<u>4,361,300</u>	<u>5,254,995</u>
<b>Total Debt Service:</b>	<u>\$47,247,254</u>	<u>\$39,092,796</u>	<u>\$45,781,374</u>	<u>\$ 46,894,969</u>	<u>\$ 48,427,070</u>
<b>Coverage Ratio:</b>	1.387	1.598	1.39	1.36	1.32

Source: Derived from the Calendar Year 2013-2017 Audited Financial Statements of the City

The City has outstanding bonds, notes and loans for municipal purposes which are not entitled to the benefits of the Municipal Qualified Bond Act. The debt service for the calendar year ending December 31, 2017 was \$17,009,143 for such bonds, \$2,619,270 for notes and \$126,238 for such loans. The debt service for the calendar year ending December 31, 2016 was \$20,515,134 for such bonds, \$6,929,000 for notes and \$126,233 for such loans. The debt service for the calendar year ending December 31, 2015 was \$6,934,388 for such bonds, \$5,108,103 for such notes and \$531,945 for such loans. The debt service for the calendar year ending December 31, 2014 was \$5,507,931 for such bonds, \$5,108,063 for such notes and \$531,945 for such loans. The debt service for the calendar year ending December 31, 2013 was \$4,781,723 for such bonds, \$5,543,710 for such notes, and \$527,833 for such loans. The City may also be responsible for the payment of debt service on the bonds issued by certain independent authorities. See "CITY INDEBTEDNESS AND DEBT LIMITS -- Other City-Related Obligations" herein.

Certain outstanding issues of General Improvement Bonds, Pension Obligation Bonds, Water Bonds and FYABs of the City are entitled to the benefits of the Municipal Qualified Bond Act and certain School Bonds of the City are entitled to the benefits of the School Qualified Bond Act, Title 18A of the New Jersey Statutes, Section 18A:24-85 *et seq.*

#### School Qualified Bond Act

In addition to being secured by the pledge of the City's full faith and credit, certain bonds of the City are entitled to the benefits of The School Qualified Bond Act, Title 18A of the New Jersey Statutes, Section 18A:24-85 *et seq.*, as amended (the "School Qualified Bond Act"). Pursuant to the School Qualified Bond Act, a portion of the amount of State school aid payable to the school district, in amounts sufficient to pay debt service on such bonds, is to be withheld by the State Treasurer and forwarded directly to the paying agent on or before the principal and interest payment dates for such bonds. Those funds are further deposited into accounts established for the purpose of paying debt service on such bonds.

Pursuant to the provisions of The School Qualified Bond Act, the City shall certify to the State Treasurer the name and address of the paying agent, maturity schedule, interest rate or rates and dates of payment of debt service on such bonds within ten days after the issuance thereof. After receipt of such certificate, the State Treasurer is required to withhold with respect to such bonds from the amount of State school aid payable to the school district an amount which will be sufficient to pay debt service on such bonds as it becomes due. For purposes of The School Qualified Bond Act, "State school aid" means funds made available to local school districts pursuant to the Quality Education Act of 1990, N.J.S.A. 18A:7D-4.

The School Qualified Bond Act provides that the State school aid so withheld and paid or to be paid to and held by the paying agent are deemed to be held in trust and exempt from being levied upon, taken, sequestered or applied toward paying the debts of the City other than the payment of debt service on such bonds and other bonds of the City issued for school purposes and entitled to the benefits of the School Qualified Bond Act.

The School Qualified Bond Act does not relieve the City of its obligation to include in its annual budget amounts necessary to pay, in each year, the principal of and interest becoming due on such bonds. However, such budgeted amounts will be forwarded by the City to the school district, to the extent that appropriated amounts have been withheld from the State school aid payable to the school district and have been forwarded to the paying agent. Such budgeted amounts must be used to pay debt service becoming due on such bonds and other bonds of the City issued for school purposes and entitled to the benefits of the School Qualified Bond Act in any year in which sufficient State school aid is not appropriated.

The State has covenanted in The School Qualified Bond Act with the holders of bonds entitled to the benefits of such act, that it will not repeal, revoke, rescind, modify or amend the provisions of such act providing for the withholding of State school aid and payment of such monies to the paying agent for such bonds so as to create any lien or charge on or pledge, assignment, diversion, withholding payment or other use of or deduction from such monies which is prior in time or superior in right to the payment of debt service on such bonds.

*The School Qualified Bond Act does not contain a pledge or guarantee that any amounts payable to the Paying Agent will, in fact, be made or continued. Each such annual amount is subject to appropriation by the State Legislature. Moreover, the State is not required to continue to make appropriations of such amounts, nor is the State limited or prohibited from repealing or amending any law heretofore or hereafter enacted for the payment of such amounts or in the manner, time or amount thereof. Further, the amount payable to the paying agent does not constitute an additional source of revenues available to the City.*

The table below shows the qualified revenues, debt service on bonds subject to the School Qualified Bond Act, and coverage ratios for the last five years.

	<u>December 31, 2017</u>	<u>December 31, 2016</u>	<u>December 31, 2015</u>	<u>December 31, 2014</u>	<u>December 31, 2013</u>
Qualified School Revenues:	\$475,807,171	\$422,092,541	\$417,805,515	\$ 417,859,150	\$ 419,644,829
Total School Debt Service:	7,105,819	13,361,441	9,999,304	10,483,807	12,190,025
Coverage Ratio:	66.96	31.59	41.78	39.86	34.43

#### **New Jersey School Bond Reserve Act**

All school bonds issued are also entitled to the benefits of the provisions of the New Jersey School Bond Reserve Act, P.L. 1980 (N.J.S.A. 18A:56-17 et seq.) (the "School Bond Reserve Act").

In accordance with the School Bond Reserve Act, there is established within the State Fund for the Support of Free Public Schools (the "Fund") a school bond reserve (the "Reserve"), which is pledged by law to secure payments of principal and interest due on such bonds in the event of the inability of any issuer thereof to make payments. The school bond reserve consists of two accounts, the old school bond reserve account and the new school bond reserve account. The old school bond reserve account is to be funded in an amount equal to 1.5% of the aggregate of such issued and outstanding bonded indebtedness for all counties, municipalities and school districts in the State for school purposes for all such indebtedness issued prior to July 1, 2003. The new school bond reserve account is to be funded in an amount equal to 1% of the aggregate of such issued and outstanding bonded indebtedness for all such indebtedness issued on or after July 1, 2003.

The Fund was established in 1817. The present State Constitution, adopted in 1947, provides that "the Legislature shall only appropriate Fund moneys for Public School purposes." A Constitutional Amendment ratified

in 1958 provides that “the Legislature may also appropriate Fund moneys for the payment of principal or interest on any school related Bonds of counties, municipalities or school districts of the State.”

Trustees of the Fund are charged with making an annual determination of the amount of school bonds outstanding and with adjusting the level of the Reserve accordingly, to the extent that moneys are available in the Fund. The State may, but is not required to, appropriate amounts to be deposited in the Fund. The School Bond Reserve Act provides that moneys received from the sale of lands belonging to the State as of 1980 or formerly lying under water are dedicated to the support of public schools and shall constitute a part of the Fund. In the event that proceeds from the sale of State riparian interests are, in the future, made payable by law to purposes other than the Fund, they may not be applied to such purposes so long as there is a deficit in the Reserve.

The State Constitution also provides that the Fund be “securely invested and perpetual in nature.” The School Bond Reserve Act requires that the Reserve be made up entirely of obligations of, or guaranteed by, the United States Government, at least one third of which must mature within one year of issuance or purchase. Investments in the Fund may include stocks, bonds and other investments prescribed by the State Investment Council Regulations.

Under the School Bond Reserve Act, the old school bond reserve account and the new school bond reserve account respectively, are pledged as security for the prompt payment of principal of and interest on bonds issued by counties, municipalities or school districts for school purposes prior to July 1, 2003 (in the case of the old school bond reserve account) or on or after July 1, 2003 (in the case of the new school bond reserve account), in the event any issuer thereof is unable to make payment. Any issuer which anticipates that it will be unable to make such payment is instructed to certify its inability to the Commissioner of Education and the Director of the Division of Local Finance at least 10 days prior to the date payment is due. If the Commissioner and the Director approve the certification, they then certify the same to the Fund Trustees. On receipt of the certification or other notice, the Trustees are required, within the limits of the Reserve, to purchase such bonds at the face amount or pay such interest when due. The amount which may be applied to any one issuer's bonds is not limited. The amount of any such payment of interest or purchase price shall be deducted from the appropriation or apportionment of State aid payable to the issuer and shall not obligate the State to make, nor entitle the issuer to receive, any additional appropriation or apportionment. There have not been any required withdrawals from the Reserve since its establishment.

The School Bond Reserve Act does not contain a covenant by the State to refrain from repealing, revoking, rescinding, modifying or amending the provisions of that act.

## **CITY FINANCIAL INFORMATION**

### **Audit Requirement**

State law requires every municipality to have an annual audit of its books and accounts to be completed within six months after the close of its fiscal year. The audit must be conducted by a registered municipal accountant and the audit report must be filed with the municipal clerk and with the Director.

Copies of the Annual Financial Statements are available for inspection during normal business hours at the office of the City Clerk and a copy of the City's Audited Financial Statements for the Calendar Year ended December 31, 2017.

## **Accounting Principles and Fund Structure**

### **Accounting Principles.**

The City does not prepare its financial statements in accordance with generally accepted accounting principles ("GAAP"). The City prepares its financial statements in accordance with the accounting policies prescribed by the Division, which differ from those prescribed under GAAP. The accounting policies prescribed by the Division are designed primarily for determining compliance with legal provisions and budgetary restrictions and as a means of reporting on the stewardship of public officials with respect to public funds. See "FINANCIAL STATEMENTS OF THE CITY OF JERSEY CITY" in APPENDIX B for a more complete discussion of the City's accounting policies.

### **Fund Structure.**

Under the method of accounting prescribed by the Division, the City accounts for its financial transactions through separate funds which differ from the fund structure required by GAAP. See "FINANCIAL STATEMENTS OF THE CITY OF JERSEY CITY" in APPENDIX B herein for a detailed description of the fund structure utilized by the City.

### **Basic Financial Statements.**

The City presents the financial statements which are required by the Division and which differ from the financial statements required by GAAP. In addition, the Division requires the financial statements to be referenced to the supplementary schedules. This practice differs from GAAP.

### **Reporting Entity.**

The Division requires the financial statements of component units of the City to be reported separately unlike GAAP pursuant to which there are criteria to be used to determine which component units should be included in the financial statements of the oversight entity. Inasmuch as their activities are administered by separate boards, the financial statements of the Jersey City Board of Education, Jersey City Public Library, Jersey City Municipal Utilities Authority, Jersey City Municipal Port Authority and Jersey City Redevelopment Agency are reported separately.

## **Uniform Chart of Accounts**

In an attempt to instill uniformity in financial reporting among the numerous municipal and county entities in New Jersey, the Division of Local Government Services has required the implementation of a Flexible Chart of Accounts ("FCOA") and Other Comprehensive Basis of Accounting — Comprehensive Annual Financial Report ("OCBOA-CAFR") by all New Jersey local and governmental entities. Procedures as to implementation dates are still pending by the State.

An important goal of the FCOA is to enable a comparison of local unit expenditures and revenues. Because municipalities and counties have different approaches to budgeting, common budget activity categories have been developed to facilitate comparison. These categories are necessary to prepare the Comprehensive Annual Financial Report and comply with budget regulations.

In order for each municipality and county to maintain the same minimum number of financial records and classify financial transactions in similar account classification structure, a uniform, flexible chart of accounts is already in place. This standardized chart of accounts, ("FCOA"), facilitates the electronic filing of budgets and other financial documents. The City converted its existing account numbers to that of FCOA and OCBOA-CAFR.

## **Current Fund – Revenues and Expenditures**

The Current Fund is used to account for the revenues and expenditures for governmental operations of a general nature, including debt service on general improvement and school bonds, and tax appeal refunding notes. The fund balance in the Current Fund at the end of each fiscal year is comprised of cash, investments and certain receivables. Under State law, only the amount of Current Fund balance held in cash or quick assets may be included as anticipated surplus in the succeeding fiscal year's budget, unless the Director gives written consent to an exception.

The information presented in the following tables has been derived from the City's Audited Financial Statements for fiscal years ending December 31, 2013, December 31, 2014, December 31, 2015, December 31, 2016 and December 31, 2017. The fund balance does not reflect a cash surplus and the balance consists primarily of receivables. The amount of the fund balance that may be used in the succeeding year's budget consists of receivables which have a high probability of being realized in the succeeding fiscal year and which are permitted by the Director to be included in the succeeding year's budget. The fund balances as of 2013 through 2017, and the amounts included in the budget for each succeeding year are shown below:

<b>Fiscal Year Ending</b>	<b>Current Fund Fund Balance</b>	<b>Used in Succeeding Year Budget</b>
December 31, 2017	\$56,339,410	\$26,557,200
December 31, 2016	78,920,179	39,954,250
December 31, 2015	50,705,610	20,745,651
December 31, 2014	56,132,966	25,722,750
December 31, 2013	38,733,517	16,413,000

---

Source: Derived from the Calendar Year 2013-2017 Audited Financial Statements of the City

The following table summarizes the Current Fund revenues for the last five years with a comparison of budgeted revenues and expenses to actual amounts. The tables on the succeeding pages set forth the City's appropriations for the last five years and show the operations and changes in the Current Fund over the past five years.

	Revenues In Thousands									
	December 31, 2017		December 31, 2016		December 31, 2015		December 31, 2014		December 31, 2013	
	<u>Budgeted<sup>(1)</sup></u>	<u>Realized</u>	<u>Budgeted<sup>(1)</sup></u>	<u>Realized</u>	<u>Budgeted<sup>(1)</sup></u>	<u>Realized</u>	<u>Budgeted<sup>(1)</sup></u>	<u>Realized</u>	<u>Budgeted<sup>(1)</sup></u>	<u>Realized</u>
Fund Balance Utilized.....	\$ 39,960	\$ 39,960	\$ 20,746	\$ 20,746	\$ 25,723	\$ 25,723	\$ 16,413	\$ 16,413	\$ 16,707	\$ 16,707
Municipal Levy.....	228,298	228,890	223,276	225,570	219,785	222,266	217,414	232,324	217,731	222,768
Addition to School Tax Levy.....	3,916	3,916	7,702	7,702	5,429	5,429	5,774	5,774	6,714	6,714
Minimum Library Tax .....	8,566	8,566	7,220	7,220	6,575	6,575	6,190	6,190	5,902	5,902
Delinquent Taxes.....	812	2,263	1,160	559	2,100	1,461	851	957	342	1,028
<b>Miscellaneous Revenue Anticipated:</b>										
Building Aid Allowance for Schools .....	3,190	3,190	5,659	5,926	4,569	4,569	4,709	4,709	5,476	5,476
Consolidated Municipal Property Tax Relief Aid .....	10,408	10,408	10,432	10,432	10,753	10,753	11,814	11,814	12,162	12,162
Miscellaneous .....	219,291	244,254	243,536	270,611	206,920	218,345	199,379	210,750	186,206	208,191
Energy Receipt Tax .....	53,436	53,436	53,092	53,092	53,092	53,092	52,031	52,031	51,683	51,683
Municipal Utilities Authority Franchise .....	21,000	21,000	20,000	20,000	19,000	19,000	14,500	14,500	13,000	13,000
<b>Total Miscellaneous Revenue Anticipated.....</b>	<b><u>307,325</u></b>	<b><u>332,288</u></b>	<b><u>332,719</u></b>	<b><u>360,111</u></b>	<b><u>294,334</u></b>	<b><u>305,759</u></b>	<b><u>282,433</u></b>	<b><u>293,804</u></b>	<b><u>268,527</u></b>	<b><u>290,512</u></b>
<b>Unanticipated Revenues (Non Budget)</b>	<b>-</b>	<b><u>5,883</u></b>	<b>-</b>	<b><u>2,760</u></b>	<b>-</b>	<b><u>1,185</u></b>	<b>-</b>	<b><u>2,013</u></b>	<b>-</b>	<b><u>1,699</u></b>
<b>Total Revenues .....</b>	<b><u>\$588,878</u></b>	<b><u>\$621,766</u></b>	<b><u>\$570,918</u></b>	<b><u>\$603,364</u></b>	<b><u>\$553,940</u></b>	<b><u>\$568,398</u></b>	<b><u>\$529,075</u></b>	<b><u>\$545,512</u></b>	<b><u>\$515,923</u></b>	<b><u>\$545,329</u></b>

Source: Derived from the Calendar Year 2013-2017 Audited Financial Statements of the City  
<sup>(1)</sup> Includes amendments to the budget subsequent to adoption, such as grant awards.

	<b>Appropriations In Thousands</b>				
	<b>December 31, 2017</b>	<b>December 31, 2016</b>	<b>December 31, 2015</b>	<b>December 31, 2014</b>	<b>December 31, 2013</b>
<b>Operating Expenses</b>					
Salaries and Wages .....	\$ 234,314	\$ 228,897	\$ 216,605	\$ 213,570	\$ 198,098
Pensions .....	64,622	56,519	51,059	48,948	51,184
Health Benefits .....	94,752	94,500	78,578	75,556	75,014
Deferred Charges .....	6,748	8,427	8,983	8,074	22,609
Other Expenses .....	122,737	116,896	131,090	116,251	113,279
Reserve for Uncollected Taxes	<u>4,881</u>	<u>3,847</u>	<u>3,500</u>	<u>1,847</u>	<u>1,528</u>
Total .....	533,054	509,086	489,815	464,246	461,712
Capital Debt Service .....	65,419	62,034	50,321	45,431	51,691
School Debt Service .....	7,106	13,361	9,999	10,484	12,190
Tax Refunds and Operational Debt Service <sup>(1)</sup>	<u>1,583</u>	<u>4,629</u>	<u>11,528</u>	<u>14,295</u>	<u>7,013</u>
<b>Total .....</b>	<b><u>\$ 607,162</u></b>	<b><u>\$ 589,110</u></b>	<b><u>\$ 561,663</u></b>	<b><u>\$ 534,456</u></b>	<b><u>\$ 532,605</u></b>

Source: Derived from the Calendar Year 2013-2017 Audited Financial Statements of the City.

<sup>(1)</sup> Represents payments for bonds issued by prior administrations to finance operating deficits and refunds of past property tax over-charges.

**Statement of Operations and Changes in Fund Balance In Thousands**

	December 31, 2017	December 31, 2016	December 31, 2015	December 31, 2014	December 31, 2013
<b>Revenue and Other Income Realized:</b>					
Fund Balance Utilized .....	\$ 39,960	\$ 20,746	\$ 25,723	\$ 16,413	\$ 16,707
Miscellaneous Revenue Anticipated .....	332,288	338,806	305,759	293,804	290,512
Current Year Taxes .....	492,469	472,570	452,048	446,147	440,629
Delinquent Taxes .....	2,263	559	1,461	957	1,028
Non-Budget Revenue .....	5,883	2,760	1,185	2,013	1,699
Other Credits to Income:					
JCMUA Franchise Extension Fees .....		14,000			4,674
Unexpended Balance of Appropriations Reserves .....	18,989	13,999	7,569	8,105	4,674
Cancellation of Reserves .....	-0-	-0-	468	4,616	1,477
Cancellation of Contracts Payable & Checks .....	1,231	1,392	1,711	591	1,032
Miscellaneous .....	2,593	2,396	5,80	104	691
Interfunds Liquidated .....	45	311	246	5,392	214
<b>Total Revenue and Other Income Realized .....</b>	<b>895,721</b>	<b>867,539</b>	<b>796,750</b>	<b>778,142</b>	<b>758,661</b>
<b>Expenditures:</b>					
<b>Budget and Emergency Appropriations:</b>					
<b>Appropriations Within "CAP" Operations:</b>					
Salaries and Wages .....	239,314	228,897	216,603	213,570	198,098
Other Expenses .....	180,209	165,850	179,688	153,234	159,532
Deferred Charges and Statutory Expenditures .....	64,622	56,519	51,059	48,948	51,184
<b>Appropriations Excluded from "CAP" Operations:</b>					
Salaries and Wages .....				-	-
Other Expenses .....	36,796	44,344	29,949	37,573	35,782
Capital Improvements .....	300	1,200	314	1,000	600
Municipal Debt Service .....	67,002	66,663	61,809	59,726	58,705
Deferred Charges -- Municipal .....	6,933	8,427	8,983	8,074	14,988
Local School District Purposes .....	7,106	13,361	9,756	10,484	12,190
Reserve for Uncollected Taxes .....	4,881	3,847	3,500	1,847	1,528
School Taxes .....	115,548	113,283	111,062	109,149	107,392
County Taxes .....	130,445	117,725	105,866	102,513	97,853
Amount Due County on Added & Omitted Taxes .....		1,071	851	2,160	-
Miscellaneous .....	13,337	2,348	4,702	3,911	8,304
Interfunds Created .....	11,849	45	311	246	96
<b>Total Expenditures .....</b>	<b>878,342</b>	<b>823,579</b>	<b>784,455</b>	<b>752,435</b>	<b>746,251</b>
Excess (Deficit) in Revenue .....	17,379	43,960	12,295	25,707	12,410
<b>Adjustments to Income before Fund Balance:</b>					
Special Emergency Authorization Storm Sandy Over expenditure of Appropriations .....				-	-
Expenditures included above which are by Statute .....				606	-
Deferred Charges to Budget of Succeeding Year:					
Special Emergency Appropriations .....		5,000	8,000	-	-
Revaluation of Properties .....				7,500	9,500
Contractual Severance Liabilities .....				-	21,910
<b>Excess in Operations After Adjustment .....</b>	<b>17,379</b>	<b>48,960</b>	<b>20,295</b>	<b>33,813</b>	<b>21,910</b>
<b>Fund Balance Beginning of Year .....</b>	<b>78,920</b>	<b>50,706</b>	<b>56,133</b>	<b>38,734</b>	<b>33,531</b>
96,299	96,299	99,666	76,428	72,547	55,441
39,960	39,960	20,746	25,723	16,413	16,707
<b>Fund Balance, End of Year .....</b>	<b>856,339</b>	<b>878,920</b>	<b>850,705</b>	<b>856,134</b>	<b>838,734</b>

Source: Derived from the Calendar Year 2013-2017 Audited Financial Statements of the City



## CITY REVENUES

### Overview

The City derives its revenues from a variety of local taxes, user charges and miscellaneous revenues, as well as from Federal and State unrestricted and categorical grants. Local revenues provided approximately 8% of total revenues in Calendar Year 2017 while Federal and State aid, including unrestricted aid and categorical grants, provided 10.8%. A discussion of the City's principal revenue sources follows.

### Cash Flow Management

While State law requires the City to adopt and operate under a balanced budget and the City has not had a cash deficit at the end of any of the last ten fiscal years, the City's historic experience in the timing of the receipt of its various revenues has shown significant variance. The management of matching receipts and expenditures for operating purposes has required the use of significant amounts of temporary interfund transfers between operating and capital accounts. The City has undertaken an initiative to analyze and report cash flows (receipts and expenditures) on a monthly cycle to enable better matching of receipts with expenditures during each fiscal year. However, as long as the receipt of substantial appropriated revenues is dependent upon State, Federal and special program sources, there is no certainty that additional temporary interfund transfers or other short-term funding mechanisms will not be required should temporary cash flow imbalances persist.

### Real Estate Tax

The real estate tax, the single largest source of the City's local revenues, is the primary source of funds for the City's Current Fund. The City derived approximately 38.82% of its total revenues for Calendar Year 2017 from the City's portion of the real estate tax.

The amount of real property taxes payable by a property owner is based on the assessed value of the property taxed and the combined tax rate for the City, the County and the School District. The assessed value of property is determined by the City's Tax Assessor. Although property may be reassessed at any time, the Tax Assessor generally reassesses property upon a revaluation and upon a resale. The last revaluation took place in 1988. The City's tax rate is determined by the City after adopting the final budget. The City's tax rate is determined based on the amount of budgeted expenditures, the amount of other available revenues and the aggregate assessed value of all taxable property in the City. The tax rates allocable to the County and School District are determined based on their respective budgets. The City must submit its tax rate to the County which certifies the aggregate rate to be levied.

**Analysis of Tax Rates and Percent Distribution Rate Per \$1,000 Assessed Valuation**

<u>Year</u>	<u>Total</u>	<u>Municipal<sup>(1)</sup></u>	<u>Percent of Total</u>	<u>County</u>	<u>Percent of Total</u>	<u>County Open Space Tax</u>	<u>Percent of Total</u>	<u>School</u>	<u>Percent of Total</u>
2017	\$78.00	\$38.11	48.88%	20.28	26.00%	\$0.43	0.55%	\$19.18	24.59%
2016	77.01	\$37.83	49.12%	18.96	24.62%	0.36	0.47%	19.86	25.79%
2015	74.82	37.73	50.43%	17.49	23.38%	0.17	0.23%	19.43	25.97%
2014	74.34	37.68	50.69%	17.12	23.03%	0.17	0.23%	19.37	26.06%
2013	74.66	38.45	51.50%	16.51	22.11%	0.07	0.09%	19.63	26.29%

<sup>(1)</sup> Includes library tax

Source: Derived from the County Board of Taxation Certification

**Tax Collection Procedure.** Taxes are payable quarterly on February 1, May 1, August 1 and November 1. Tax bills are sent out twice during the year, generally in June and December. The bill for taxes payable in February and May is based on the assessed value of the property as of January of the preceding year. The bill for taxes payable in August and November reflects adjustments made so that the taxes paid for the calendar year reflect the assessed value of the property as of January of the current year.

The City is required to send out tax bills at least 45 days before the taxes are due; however, if the budget has not been adopted by that time, the City may delay sending out the bills to a date at least 25 days before the taxes are payable. If the budget has not been adopted by that time, the bill is based on an estimated rate and the second bill will be adjusted to compensate for any difference between the actual rate and the estimated rate. Taxpayers are allowed a 10-day grace period for paying their taxes. Interest is charged on any late payments of taxes from the date the taxes were due until they are paid at a rate of 8% per annum for the first \$1,500 of delinquent taxes and 18% on any delinquent amount in excess of \$1,500. All unpaid taxes for the previous year are annually placed in a tax sale prior to putting a lien on the property, in accordance with the New Jersey Statutes. If the tax lien is sold, depending upon the amount of the lien sold, there is an additional penalty of 2%, 4% or 6%. *In rem* tax foreclosure proceedings may be instituted to enforce the tax collection or acquisition of title to the property by the City.

The City collects taxes for itself and for the County and the School District. The City pays to the County and the School District 100% of the amount of taxes billed by those entities, regardless of the number of taxpayers that are delinquent. The City pays the County its share of real property taxes quarterly (on February 15, May 15, July 15 and November 15) and pays the School District its share monthly.

### Equalization Rate and Tax Collection Rates

The State determines, based on market data, the relationship between the assessed value of property and the “true value” or market value of the property. The State then calculates the equalization rate, which is the assessed value divided by the true value, expressed as a percentage. The assessed value divided by the equalization rate provides the equalized value, which is the value used to calculate the City's debt limit. See “CITY INDEBTEDNESS AND DEBT LIMITS - Debt Limits” herein. The following table sets forth the assessed valuation, equalization rate and equalized value of property in the City of the last 7 calendar years.

Assessed Valuations

Year	Land	Improvements	Land and Improvements <sup>(1)</sup>	Personal Property	Net Valuation Taxable <sup>(2)</sup>	Equalization Ratio	Equalized Valuation of Taxable Real Property
2018	\$14,976,429,800	\$19,640,972,814	\$34,617,402,614	\$64,373,216	\$34,360,843,026	101.02	\$34,014,551,210
2017	1,647,040,070	4,636,825,818	6,283,865,888	15,291,070	6,229,997,658	23.66	\$26,609,970,848
2016	1,655,155,703	4,493,719,645	6,148,875,348	17,185,090	6,093,045,338	27.63	22,375,519,222
2015	1,578,755,314	4,401,341,030	5,980,096,344	17,672,253	5,997,768,597	30.02	20,246,400,032
2014	1,548,586,503	4,430,998,768	5,916,171,471	16,605,073	5,932,776,544	30.02	19,707,433,281
2013	1,503,278,191	4,362,050,129	5,795,484,581	19,086,697	5,814,571,278	31.24	18,570,573,832

Source: The City of Jersey City, Office of the Tax Assessor

<sup>(1)</sup> Includes partial exemptions and abatements.

<sup>(2)</sup> Excludes properties exempt from real property taxes.

Taxpayers are required to pay taxes based on the assessed value of their property and then are permitted to appeal. If the taxpayers are successful on appeal, they will receive a refund. Appeals by property owners required the City to make refunds of tax payments in the amounts of approximately \$7.4 million in 2013, \$5.4 million in 2014, \$5.2 million in 2015, \$6.7 million in 2016 and \$7.1 million in 2017. The City is authorized to issue bonds to reimburse itself for payments made pursuant to successful tax appeals. The City has not authorized the issuance of bonds to fund tax appeals since 2012. See “CITY INDEBTEDNESS AND DEBT LIMITS – Exception to Debt Limit - Real Property Tax Appeal Refunding Notes” herein.

On September 14, 2016, the City adopted a special emergency appropriation of \$5 million for the preparation and execution of a complete program of revaluation of real property for the use of the local assessor.

The following table sets forth the amount of taxes levied in each year and the amount and percentage of such levy collected or canceled. In addition, the table sets forth the amount and percentage of delinquent taxes from all prior years collected in a particular year, the amount transferred to tax lien, the tax lien balance, and the value of foreclosed property acquired by the City. The tax collection rate in the Calendar Year ending December 31, 2017 was 98.29%.

**Analysis of Real Estate Tax Billings and Collections**

<u>Tax Billings</u>	<u>December 31, 2017</u>	<u>December 31, 2016</u>	<u>December 31, 2015</u>	<u>December 31, 2014</u>	<u>December 31, 2013</u>
Municipal <sup>(1)</sup>	\$246,146,642	\$233,967,802	\$229,124,333	\$230,850,029	\$230,843,162
School	119,464,435	120,985,223	116,490,978	114,923,807	114,105,988
County	<u>130,445,002</u>	<u>118,795,203</u>	<u>106,716,687</u>	<u>104,672,969</u>	<u>97,852,919</u>
Total Billings	<u>\$496,056,079</u>	<u>\$473,748,228</u>	<u>\$452,331,998</u>	<u>\$450,446,805</u>	<u>\$442,802,069</u>
Taxes Collected	487,588,681	468,722,869	448,547,898	444,300,251	439,100,320
Percent Collected	98.29%	98.94%	99.16%	98.64%	99.16%
Taxes Canceled or Remitted	1,713,905	3,966,143	3,316,205	6,720,278	2,606,875
Delinquent Taxes Collected, Including Liens	1,828,745	559,368	1,461,339	912,146	1,027,576
Total Current and Delinquent Collected	489,417,426	469,282,237	451,864,103	445,212,397	440,127,896
Percent Collected <sup>(2)</sup>	98.66%	99.06%	99.89%	98.84%	99.40%
Delinquent Tax Balance Current Year	7,604,448	1,504,721	467,897	715,416	201,344
Prior Year's Tax Balance	2,648,205	2,760,607	3,660,742	2,768,273	2,566,929
Taxes Receivable Balance Transferred to Tax Title Liens	10,252,653	4,265,328	3,125,278	3,660,742	2,632,909
Current Year	-0-	-0-	265,880	39,202	65,980
Tax Title Lien Balance	37,154	37,154	659,482	422,969	326,028
Foreclosed Property Balance	1,455,500	1,455,500	1,680,900	1,455,500	1,591,500

Source: Derived from the Calendar Year 2013-2017 Audited Financial Statements of the City.

(1) Includes Minimum Library Tax of \$8,565,681 for 2017, \$7,220,380 for 2016, \$6,574,673 for 2015, \$6,190,185 for 2014, and \$5,901,949 for 2013

(2) includes receipts and balances of current taxes, delinquent taxes and tax title liens.

The ten entities that paid the most real property taxes in 2017 do not, in the aggregate, exceed 10.5% of the total levy. Listed below are the taxpayers whose property has the greatest assessed valuations in the City.

**Ten Largest Assessed Valuations in the City**

<u>Name</u>	<u>Type of Business</u>	<u>2016 Assessed Valuations</u>
NC Housing Associates	Office	\$ 132,666,800
Cali Harborside Associates	Office	120,092,000
101 Hudson St. Associates	Office	90,855,800
Newport Centre, LLC (Indianapolis)	Shopping	58,088,000
MEPT Newport Tower	Office	45,000,000
John Hancock Life Insurance	Office	43,490,400
70 Columbus Urban Renewal, LLC	Office	42,775,100
Newport Center (Rego Park)	Mixed – Retail, Office, Hotel	39,253,400
WELLS REIT	Office	35,625,000
Grove Pointe, U.R.	Mixed – Retail, Office, Residential	34,512,100

**Tax-Exempt Properties**

As of January 30, 2017, approximately 18.75% of the total assessed value of the City's real property was exempt from real property taxation. However, this number does not include certain service charges for PILOTS.

**Tax-Exempt Properties in the City**

	<u>2016 Assessed Valuation</u>
Public Schools	\$ 299,279,600
Schools Other Than Public	76,767,400
Public Property	1,343,810,700
Church and Charities	249,823,050
Cemeteries	35,220,800
Other Exempt Properties	<u>2,608,098,850</u>
	<u>\$ 4,612,800,400</u>

Source: The City of Jersey City, Office of the Tax Assessor.

**Properties in Tax Abatement**

Under the provisions of State law, the City may abate the taxes payable on newly constructed commercial and residential properties. The owners of such properties generally pay taxes on the value of the land on which the property is located but, pursuant to agreements with the City, pay payments-in-lieu-of-taxes ("PILOTS") on the value of the improvements on the property instead of taxes. Such abatements are used as an incentive to encourage development in areas within the City. State law provides different abatement programs for commercial and residential development. The law allows a 15-year abatement period during which the taxes on the improvements on property could be abated and PILOTS charged instead. The PILOTS for commercial properties were based on the construction cost of the property (initially 2% of the costs) or on the revenues received from leasing of the property. The law also allows for a 5-year short-term abatement period in which PILOTS are based on a percentage of what the tax bill otherwise would have been. Residential property is eligible for a 30-year abatement period and the PILOTS for residential property are based either on the sale price of the property (if condominiums are involved) or

the rent roll (for a rental property). In April 1992, the law was amended to allow an abatement period of up to 30 years for commercial property, also during which PILOT payments are the higher of an amount based on construction costs and a percentage of the taxes that would have been payable. However, the City has made it a policy to only grant 30 year abatements for affordable housing projects.

In addition to the difference between the amount of a PILOT and the amount of taxes, PILOTs differ from taxes in two other ways. First, PILOTs are paid to the City and no portion of the PILOT is payable to the County or the School District. Second, there is no incentive for a property owner to appeal the assessed value of the property while it is subject to abatement. Therefore, it is not clear whether the assessed value determined during the abatement period will be appealed when the property is no longer subject to abatement. When the abatement period ends, the property becomes subject to taxation on both the land and improvements. See "CITY ECONOMIC AND DEMOGRAPHIC INFORMATION" and "ECONOMIC DEVELOPMENT" herein.

The City's authority to enforce payments in lieu of taxes and the remedies available to it for delinquent payments are the same as those for real property taxes, including sale of liens and foreclosures. In addition, the City may revoke the taxpayers' ability to make payments in lieu of taxes. Further, the City has engaged the services of several independent accounting firms to review the records of properties in abatement to ensure the accurate reporting of development costs upon which payments in lieu of taxes are calculated.

**Municipal Revenues From Payments In Lieu Of Taxes (PILOT)  
On Properties In Tax Abatement**

<u>Year Ending</u>	<u>PILOT Revenue</u>
December 31, 2017	\$141,808,933
December 31, 2016	137,388,598
December 31, 2015	130,861,698
December 31, 2014	121,966,019
December 31, 2013	122,615,865

Source: Derived from the Calendar Year 2012-2016 Audited Financial Statements of the City and 2017 unaudited Annual Financial Statements

The estimated development cost of the 35 major commercial properties currently covered by abatements exceeds \$3 billion.

Listed below are the five entities which were responsible for the highest PILOT payments in Calendar Year 2016:

**Five Largest PILOT Payers**

<u>Name</u>	<u>Calendar Year 2016 Payment Amount</u>
K. Hovanian@77 Hudson Street	\$5,127,958.88
Vector 1	4,487,422.52
GSJC 30 Hudson Street UR	4,432,741.21
Port Liberte II	4,009,345.30
Cali Harbor Plaza	<u>3,731,479.14</u>
<b>TOTAL</b>	<u>\$21,788,947.05</u>

Source: Derived from the City's Tax Abatement Office.

## Delinquent Taxes

Delinquent taxes can be anticipated only to the extent of the last preceding year's delinquent tax collection percentage.

The following chart shows the amount and percentage of delinquent taxes budgeted for collection by the City and the amount and percentage of delinquent taxes which were actually collected in such fiscal year, for the last five years. The amount of delinquent taxes represents an aggregate amount of unpaid taxes for all prior years.

### Delinquent Taxes and Tax Title Liens

<u>Year Ending</u>	<u>Balance of Delinquent Taxes at Start of Year</u>	<u>Budgeted Amount of Delinquent Taxes to Be Collected</u>	<u>Percent of Delinquent Taxes Budgeted to be Collected</u>	<u>Amount of Delinquent Taxes Collected</u>	<u>Percent of Delinquent Taxes Collected</u>
December 31, 2017	\$4,265,328	\$812,309	19.04%	\$1,828,745	42.87%
December 31, 2016	3,784,760	1,160,785	30.67%	559,368	14.78%
December 31, 2015	3,125,278	2,100,000	0.67%	1,461,339	0.47%
December 31, 2014	2,768,273	851,494	0.31%	912,146	0.33%
December 31, 2013	2,649,577	342,386	0.13%	1,027,577	0.39%

Source: Derived from the Calendar Year 2016 Audited Financial Statement of the City and 2017 unaudited Annual Financial Statements

The City currently reviews the status of real property with outstanding delinquent taxes to institute a more rapid disposition of property through foreclosure and sale. The City usually sells tax liens annually at auction and retains unsold liens. In 2014, 2015 and 2016 the City sold an aggregate of \$14,805,574, \$23,996,324 and \$14,584,637 of tax title lien certificates, respectively.

## Property Tax Reform

In recent years, the New Jersey Legislature has considered various proposals to lessen the dependence of local governments on property taxes and to find alternative means to fund vital governmental services.

On July 13, 2010, the Governor approved legislation which, in addition to the "Cap Law" described under "THE CITY OF JERSEY CITY - Limitation on Expenditures" above, amends the property tax levy cap that was initially enacted in 2007. This law puts a limitation of 2% on the property tax levy set in the annual budget. The law allows for exclusions for capital expenditures, debt service, increases in pension contributions and accrued liability for pension contributions in excess of 2%, and increases in health care costs in excess of 2%. This limitation may be exceeded by approval of an affirmative vote in excess of 50% of the people voting at a special referendum held for such purpose.

The tax levy limitation does not limit the obligation of the City to levy ad valorem taxes upon all taxable real property within the City to pay debt service on the Notes.

Any legislation or constitutional amendments which alter the existing system of real property taxation in New Jersey may adversely affect the security and/or market value of bonds, notes and other obligations of counties and municipalities (such as the City).

## State Aid Programs

The State of New Jersey provides financial support to local governments and school systems through various programs aimed at reducing reliance on the local property tax base. As described below, the City received

or receives (i) urban enterprise aid, (ii) aid on distributed tax and (iii) aid on State reimbursement for certain categories of taxpayers. The State maintains a variety of smaller programs of grants-in-aid to municipalities in such fields as housing, neighborhood preservation, health, and social services, and has assumed funding of other programs previously financed by the City, thereby relieving the City from funding such costly programs. The City is allowed a credit for certain administrative charges under Federal programs.

**Urban Enterprise Zone Funds.** Under the State's Urban Enterprise Zone program which is administered by the State Department of Commerce and Economic Development, Division of New Jersey Urban Enterprise Zones, three percent (3%) of the sales tax levied by the State on certain specified goods and services paid by certified businesses operating within specially-created urban enterprise zones is paid into a segregated account within the State's Zone Assistance Fund for the benefit of the municipality in which the zone is located. To encourage businesses to locate in urban enterprise zones, the State exempts certified urban enterprise zone businesses from State sales taxes on equipment and supplies utilized in daily operations, as well as building materials. Monies held for the account of a municipality within the Zone Assistance Fund may be used to pay for capital projects or municipal services, following the filing of an application by the municipality and approval of the application by the members of the State Urban Enterprise Zone Authority.

One-third of the City's total acreage qualifies as a State-approved "urban enterprise zone". The City's urban enterprise zone incorporates the major retail corridors located within the City, as well as its primary commercial and industrial areas. In the past, the City utilized the funds it has received under the State Urban Enterprise Zone Program for capital improvements, economic development, redevelopment, special improvement districts and business improvement districts. However, the City has not received any funds since 2009 due to State budgetary constraints.

**Distributed Taxes.** The State collects various taxes for distribution to local governments. Of these, Energy Receipt Tax (formerly known as Public Utilities Franchise and Gross Receipts Taxes) and Consolidated Municipal Property Tax Relief Aid are the two largest programs of State Aid in New Jersey and the major sources of state aid to the City. The energy receipt tax represents taxes received by the State on properties and right-of-ways owned by public utilities. These funds are disbursed to municipalities based on a formula reflecting such property located within each municipality. The consolidated municipal property tax relief aid, created in fiscal year 1996, consolidated 14 separate state programs (i.e., urban aid, business personal property tax replacement aid and municipal revitalization aid) into a single aid program. Building Aid Allowance for School represents state aid to support the public educational programs in the City including aid on facilities construction and improvements.

The chart below provides the amount of State aid received by the City in the last five fiscal years. Certain State aid is required to be withheld by the State Treasurer and paid to the paying agents for certain bonds of the City in an amount sufficient to pay debt service on such bonds. See "CITY INDEBTEDNESS AND DEBT LIMITS — Municipal Qualified Bond Act" and "— School Qualified Bond Act" herein.

**State Aid to Jersey City**

	<u>December 31, 2017</u>	<u>December 31, 2016</u>	<u>December 31, 2015</u>	<u>December 31, 2014</u>	<u>December 31, 2013</u>
Urban Enterprise Zone Funds	\$ -	\$ -	\$ -	\$ -	\$ 501,725
Energy Receipt Tax	53,436,478	53,091,740	53,091,740	52,031,160	51,682,679
Building Aid Allowance for School <sup>(2)</sup>	3,189,788	5,926,086	4,569,847	4,709,375	5,475,816
Consolidated Municipal Property Tax Relief Act	<u>10,408,207</u>	<u>10,431,997</u>	<u>10,752,945</u>	<u>11,813,525</u>	<u>12,162,006</u>
<b>TOTALS:</b>	<u>\$67,034,473</u>	<u>\$69,465,660</u>	<u>\$68,430,369</u>	<u>\$ 68,554,060</u>	<u>\$ 69,822,226</u>

Source: Derived from the Calendar Year 2013-2017 Audited Financial Statements of the City

<sup>(1)</sup> Supplemental School Tax Relief allows state-operated schools to reduce the tax levy for school purposes.

**Tax Exemption Reimbursement.** The State reimburses municipalities for the full cost of mandated property tax deductions and exemptions for certain categories of taxpayers. The State reimbursed the City for seniors/veterans/disabled citizens for the calendar years ending December 31, 2013, December 31, 2014, December 31, 2015, December 31, 2016, and December 31, 2017, \$653,544, \$408,960, \$516,989, \$401,802 and \$424,580 respectively.

### **Summary of State/Federal Aid to School Districts**

In 1973, the Supreme Court of the State ruled in Robinson v. Cahill that the existing method of financing, school costs principally through property taxation was unconstitutional. Pursuant to the Supreme Court's ruling, the State Legislature enacted the Public School Education Act of 1975 (P.L. 1975, Ch. 212) which required funding of the State's School Aid through the New Jersey Gross Income Tax Act (P.L. 1975, Ch. 47) enacted for the purpose of providing property tax relief.

On June 5, 1990, the Supreme Court ruled in Abbott v. Burke, that the school aid formula enacted under the Public School Education Act was unconstitutional as applied. The Court found that poorer urban districts were significantly disadvantaged under that school funding formula because school revenues were derived primarily from property taxes. The Court found that wealthy districts were able to spend more, yet tax less for educational purposes.

### **The Quality Education Act of 1990**

The Legislative response to Abbott v. Burke was the passage of the QEA (P.L. 1990, C. 52), which was signed into law on July 3, 1990. This law established a new formula for the distribution of State aid for public education commencing with the 1991-92 fiscal year. The law provided a formula that took into account property value and personal income to determine a district's capacity to raise money for public education. A budgetary limitation or "CAP" on expenditures was also provided in the law. The "CAP" was intended to control the growth in local property taxes. The QEA was amended and revised by Chapter 62 of the Pamphlet Laws of 1991 of New Jersey, effective March 14, 1991 and further amended by Chapter 7 of the Pamphlet Laws of 1993 effective December 14, 1993.

On July 12, 1994, the Supreme Court of New Jersey declared the school aid formula under the QEA, as amended, unconstitutional on several grounds as it is applied to the 30 special needs districts designated by the State in ongoing litigation commonly known as Abbott v. Burke II. The City's school district is a special needs district. No specific remediation was ordered, but the Supreme Court ultimately held that the Legislature and the Governor were required to have a new funding formula in effect by December 31, 1996, so that the new formula would be implemented in the 1997-98 fiscal year.

### **Comprehensive Educational Improvement and Financing Act of 1996**

In keeping with the Supreme Court's deadline, Governor Christine Todd Whitman signed into law on December 20, 1996, the *Comprehensive Educational Improvement and Financing Act of 1996* ("CEIFA"). CEIFA affects how public schools are funded by the State, beginning in the 1997-98 fiscal year.

CEIFA departs from other funding formulas adopted in New Jersey by defining what constitutes a "thorough and efficient" education, which is what the New Jersey Constitution requires every public school student to receive. CEIFA further establishes the costs to provide each student with an education that is "thorough and efficient."

In defining what constitutes a "thorough" education, the New Jersey State Board of Education adopted a set of Core Curriculum Content Standards. The purpose of these standards is to provide all students with the knowledge and skills that will enable them to be productive citizens when they graduate from any New Jersey high school, regardless of the school's location or socioeconomic condition. CEIFA provides State aid assistance in the form of Core Curriculum Standards Aid based on a school district's financial ability to raise sufficient tax revenue for its students to achieve the Core Curriculum Content Standards.



The definition of an "efficient" education under CEIFA determines the cost to provide each student with an education that fulfills the requirements for the Core Curriculum Content Standards. The efficiency standard defines such things as optimal class size, administrators/teachers per student, schools per district, and the types and amount of classroom supplies, services, and materials. CEIFA establishes an approximate amount per student to educate each student at various grade levels in the Core Curriculum Content Standards. This amount will be adjusted biennially for inflation by the consumer price index.

In determining how much Core Curriculum Standards Aid a school district will receive, CEIFA considers each school district's financial ability to fund such a level of education. This component of CEIFA is referred to as the local share requirement, namely, the amount of taxes that a school district can raise relative to other school districts based on property wealth and income levels. The purpose of the Core Curriculum Standards Aid is to provide school districts with adequate State assistance that is proportionate to their ability to pay. The purpose of this type of aid is to ensure that all school districts have the economic ability to provide their students with the ability to achieve the Core Curriculum Content Standards. In addition to the Core Curriculum Standards Aid, CEIFA also provides per pupil assistance from the State for special education, early childhood programs, demonstrably effective programs, instructional supplement, bilingual education, county vocational schools, and distance learning network. For Fiscal Year 2015-2016, the school district received Equalization Aid (formerly known as Core Curriculum Standards Aid) in the amount of \$270,661,365.

Another form of aid that is provided by CEIFA is school facilities aid. During the 1997-1998 fiscal period, this type of aid was provided to those school districts that qualified for aid under the QEA. The amount of school facilities aid that the State provided during the 1997-98 fiscal year was determined by the amount budgeted in the approved State budget.

Beginning in the 1998-99 fiscal year, State aid for school facilities was supposed to consist of a ratio that divides (i) the amount of debt service or the amount of facilities rent for lease terms that exceed five years required to be budgeted for a fiscal period into (ii) the costs that are approved by the New Jersey Department of Education for a proposed building or renovation project. The approved facility costs under CEIFA have not yet been determined. CEIFA required the governor to submit to the legislature 60 days prior to the 1998 budget address, criteria for determining approved facilities costs, State support levels, and maintenance incentives applicable to the 1998-99 fiscal period. The Legislature enacted and the Governor signed into law the Educational Facilities Construction and Financing Act ("EFCFA"), constituting Chapter 72 of the Pamphlet Laws of 2000, effective July 18, 2000. That law provides full funding for qualified costs of facilities required for Abbott Districts and funding for qualified costs of facilities for all other districts in an amount equal to the ratio between their core curriculum facilities aid and their T&E budget times 115% or 40% of the qualified costs, whichever is greater. In lieu of debt service aid, school districts may receive grants for the State share of the project and authorize bonds only for the local share of the project. School districts may receive debt service aid under that formula for certain projects begun prior to the effective date of the law. On December 28, 2000, a Complaint was filed in the Superior Court of New Jersey challenging the authority of the Economic Development Authority under the State Constitution's Debt Limitation clause to issue bonds secured by a contract with the State Treasurer, the funding of which is subject to annual appropriation, and requesting that the Court grant an injunction restraining the State and the New Jersey Economic Development Authority from issuing bonds to fund the State's financial obligation under the Educational Facilities Construction and Financing Act. On January 24, 2001, the Superior Court of New Jersey granted the State's motion to dismiss the case as a matter of law. The Plaintiff filed a notice of appeal on February 5, 2001.

CEIFA also limits the amount school districts can increase their annual current expenses and capital outlay budgets. Generally, these budgets can increase by either 3% or the consumer price index, whichever is greater. Budgets can also increase because of certain adjustments for enrollment increases, certain capital outlay expenditures, pupil transportation costs, and special education costs that exceed \$40,000 per pupil. Waivers are available from the Commissioner based on increasing enrollments and other fairly narrow grounds or by approval of the voters at the annual school election.

Under CEIFA, rent payments made pursuant to a facilities lease purchase agreement for a term that exceeds five years are treated as debt service. Such rent payments are not included in the spending limits and receive aid at

the same level as debt service. Rent payments under a facilities lease with a term of five years or less are budgeted in the general fund and are subject to a school district's spending growth limitation amounts under CEIFA.

On May 14, 1997, the New Jersey Supreme Court held that CEIFA is unconstitutional as applied to the 28 special needs districts because (1) its funding provisions fail to assure that students in such districts will receive a thorough and efficient education and (2) supplemental programs to increase student performance in such districts have neither been adequately identified nor funded. The Court recognized the Core Curriculum Standards as a valid means of identifying what is a "thorough and efficient" education under the State Constitution, but found that the State did not adequately determine or provide the adequate funding level to allow those standards to be met in the special needs districts. CEIFA was not held unconstitutional as applied to the non-special needs districts. The School District is not a special needs district.

The Court ordered the State (1) to increase State aid to the special needs districts for the 1997-98 school year to a level such that the per-pupil expenditure in such districts is equivalent to the average per-pupil expenditure in wealthy suburban districts, (2) through the Commissioner, to manage the additional spending to assure that it will be used to allow the students to meet the educational content standards and (3) under the supervision of the Superior Court, Chancery Division, to determine a plan to provide supplemental educational and facilities programs in the special needs districts.

Provisions for the additional amounts of money were appropriated in the 1997-98 State budget. The Court has ruled that the Commissioner and the State Department of Education will be responsible for maintaining the educational system in accordance with the orders of the Court.

In response to the Court's order and in an attempt to remedy inadequacies that exist in the safety, the quality and the utility of state-wide school facilities, the New Jersey Legislature enacted the EFCFA. See "Summary of Educational Facilities Construction and Financing Act" herein. The EFCFA provides certain levels of funding for facilities' improvements for both special needs and non-special needs districts. Under EFCFA, special needs districts will receive State funding of 100% of the eligible costs of a school facilities project. The State will provide non-special needs districts with facilities aid of at least 40% of the eligible costs of a school facilities project. A non-special needs district must elect to receive its level of facilities aid in either the form of a grant or ongoing annual debt service aid.

On June 27, 2001, the Superior Court of New Jersey, Appellate Division, affirmed the trial court's decision that no public referendum is required for the State's bonds under the EFCFA. By a 2-to-1 majority, the Appellate Division held that the Debt Limitation Clause of the State Constitution is not violated by the EFCFA. On appeal, the New Jersey Supreme Court held that the EFCFA and its provisions authorizing the EDA's issuance of bonds do not violate the Debt Limitation Clause of the State Constitution.

On June 24, 2004, the Legislature enacted amendments to CEIFA, which amendments impose strict limits on annual increases in their operating budgets. Commencing with the 2005-06 school year, boards of education will be required to submit proposed budgets in which the advertised per pupil administrative costs do not exceed the lower of (i) the prior year per pupil administrative costs for the district's region inflated by the greater of 2.5% or the "cost of living" (defined as the average annual increase in the consumer price index for the New York City and Philadelphia areas) and (ii) the district's per pupil administrative costs, increased (by up to the greater of 2.5% or the cost of living) by such additional costs as may be approved by the Commissioner of Education due to increases in enrollment, administrative positions necessary as a result of mandated programs, administrative vacancies, nondiscretionary fixed costs, and such other items as may be permitted by regulation (provided, that for the 2005-06 school year the amount in clause (ii) shall instead be the per pupil administrative cost limits for the district's region as determined by the Commissioner of Education). Various existing limitations on budget increases were amended from the greater of 3% or the consumer price index to the greater of the cost of living or 2.5%. Under this amendment, proposals to exceed these limits cannot (i) include any new programs and services necessary for students to achieve the thoroughness standards established pursuant to CEIFA, (ii) include any programs or services that were included in the prior year's budget unless approved by the Commissioner, and (iii) be submitted to the voters or the board of school estimate if the county superintendent of schools determines that the district has not implemented all potential efficiencies in the administrative operations of the district. This bill also reduces the

amount of surplus that may be maintained by a school district from 6% to 2% (2% for the 2005-06 school year) of the general fund balance.

### **Summary of Federal Aid to School Districts**

Federal funds are available for certain programs approved by the federal government with allocation decided by the State, which assigns a proportion to each local school district. The Elementary and Secondary Education Act, as amended by the Improving America's Act of 1994 is a federal assistance program for which a school district qualifies to receive aid. A remedial enrichment program for children of low income families is available under Title I Aid. Federal aid is generally received in the form of block grants.

### **Welfare**

The State pays the entire nonfederal share of Medicaid. As of July 1, 1991, the State also assumed one hundred percent of the costs of the nonfederal share of federal welfare programs managed by County governments and one hundred percent of the costs of General Assistance, the program of financial aid to needy people who are not otherwise provided for under New Jersey Laws that is managed by municipalities. Thus, New Jersey municipalities have no financial obligation for these programs.

As of January 1, 1999, the City consolidated the General Assistance Program into the County's Welfare Program, as permitted by State Law, and has retained its case records per State mandate.

### **Transit**

The subsidization of public mass transit is the responsibility of the State. Municipalities are not required to make financial contributions.

### **Higher Education**

The State subsidizes the system of State colleges and universities, with no municipal financial obligation. County colleges are supported by county governments with State assistance. Municipalities have no financial responsibility for the county college system.

### **Medical Care Services**

The Jersey City Medical Center, which is an established New Jersey not-for-profit medical and health care corporation, provides certain hospital and medical care services for persons residing in the City and in the adjacent communities. For many years, the City provided direct and indirect financial assistance to the Jersey City Medical Center. The several agreements and programs have generally been consolidated. The City assisted the Jersey City Medical Center in the development and construction of a new hospital and medical care facility located at Grand and Jersey Avenues in the City. The City made a capital contribution of \$12,000,000 for the acquisition of the real property for the new hospital and for certain preliminary development expenses. This contribution was funded through the issuance of serial bonds. The new medical center has an obligation to provide hospital and certain medical care services for all persons residing in the City regardless of their ability to pay. The operating and debt service expenses for the new facility are being met through Federal and State health care payments and third-party reimbursements.

## **CITY EXPENDITURES**

The City has historically spent the largest percentage of its operating budget on public safety and statutory expenditures. For Calendar Year 2016, appropriations for public safety personnel equaled 31.65% of the budget and statutory expenditures were 10% of the budget as adopted. The remaining 58.35% of the municipal budget was appropriated for the legal, financial and administrative management of the City, and the provision of public works, human resources, recreation and housing and development services and programs.

## CAPITAL IMPROVEMENT PROGRAM

The City maintains and continuously reviews a six-year program for capital improvements. Priority within the program is given to the maintenance of the existing infrastructure, to completion of projects under construction and to projects deemed necessary to the economic strength of the City. For the calendar years 2018 to 2023, inclusive, the City expects to appropriate approximately \$35 to \$45 million annually for capital projects for the City. The City anticipates the funding of these projects to be provided through the future sale of notes or bonds and grant programs.

Major projects of the general capital program of the City for the calendar years 2018 to 2023, inclusive, are: acquisition of new fire apparatus and public works equipment and machinery; continued development of recreation facilities building reconstruction; acquisition and installation of new computer systems; street resurfacing and widening; construction of a new police precinct building; construction of a new fire house and improvements to public libraries. The City estimates that its funding needs to meet general capital improvement program objectives for the six-year period will be \$209 million. The City is also making major infrastructure improvements, including the construction of new roads in connection with major development projects in the City. See "CITY ECONOMIC AND DEMOGRAPHIC INFORMATION" and "ECONOMIC DEVELOPMENT" herein. Many of these projects will be financed primarily through direct developer contributions or local improvement assessments.

## THE WATER SYSTEM

### Background

Prior to the reorganization of the Municipal Utilities Authority, the City operated the Water System as a self-liquidating utility within the City's budget. The City determined that it was in the best interest of the users of the Water System to reorganize the Jersey City Sewerage Authority as the Jersey City Municipal Utilities Authority to operate both the Sewerage System and the Water System, creating economies for both systems. On January 15, 1998, the Municipal Utilities Authority assumed the operation, maintenance and management of the Water System, subject to the short-term private operating agreement then in existence between the City and United Water. The agreement with the MUA was subsequently amended and extended to run through December 31, 2027 in order to better plan for long term improvements and operations. The City will continue to be responsible for the financing of all extensions and improvements to the Water System, but the Authority has assumed the responsibility for the payment of debt service on any future bonds issued by the City for such purposes as well as the responsibility for payment of debt service on the outstanding bonds of the City issued to finance the Water System. Debt service on the First Lien City Water Obligations has previously been paid from revenues collected by the City in connection with the use of the Water System.

### General Description

The Water System consists of five major components, impoundment, water treatment facilities, water transmission facilities, water distribution facilities and land. Much of the Water System is located outside City limits. All of the water for the City is supplied by the Boonton Reservoir which is located in the Town of Boonton and the Township of Parsippany-Troy Hills, Morris County, New Jersey. The Splitrock Reservoir, located in the Township of Rockaway, Morris County, New Jersey is an emergency source of water. A water treatment plant, located next to the Boonton Reservoir was completed in 1978. The water treatment plant capacity is 80 million gallons per day ("MGD"). Its current peak usage is 60 MGD while its average usage is 45 MGD and its safe yield is 56.8 MGD. Water is conveyed from the Boonton Reservoir by an extensive gravity piping and tunnel system, approximately 23 miles in length, to the City's Reservoir Tank at the end of Troy Street in the City. The distribution system consists basically of the Troy Street Pump Station and adjacent Reservoir Tank and the piping network that supplies water throughout the City. Each residence or apartment unit and business concern in the City must be connected to the Water System. The City owns over 2,500 acres of land related to the Water System.

United Water is responsible for the full operation of the Water System under a contract with the MUA expiring March 31, 2018, and currently bills all of the users of the Water System. The City has estimated that economic benefits will be derived from the privatization of the operation of the Water System over the term of the

contract with United Water (which ends in 2018) due to the sale of excess water to United Water, anticipated savings in costs of operations, anticipated increases in revenues from the Water System due to repairs of leaking pipes, and improvements in billing and collection. Upon expiration of the current contract with United Water, it is expected that the Authority will use its resources and personnel to operate the Water System or enter into a similar short-term private operating agreement. The Authority does not expect that, after the expiration of the operating contract with United Water, the cost to the Authority of either operating the Water System or entering into a similar short-term operating agreement will be significantly greater than the annual service fee currently paid by the MUA to United Water.

### **Water Rate Covenant**

Under the terms of the Water System Service Contract, the Authority has covenanted to make, impose, charge and collect Water Service Charges in each fiscal year in accordance with the provisions of the Act so that Water Revenues for each fiscal year will be at least sufficient to pay (a) Water Operating Expenses in such fiscal year, (b) all interest on and principal of all Water Bonds and the City Water Bonds (as defined in the Water System Service Contract) as the same shall become due and payable without recourse to or withdrawal from the Water Bond Reserve Fund, (c) payments to the City required under the Water System Service Contract, and (d) all other amounts that are required to be paid pursuant to the Water System Service Contract. Water Revenues include any excess sewer revenues anticipated to be available for deposit in the Water Revenue Fund established by the Water System Service Contract.

## **PENSION FINANCING**

Substantially all City employees who are eligible for pension coverage are enrolled in either a State or City administered retirement plan.

### **State Plans**

The three State-administered plans are the Public Employees' Retirement System, the Consolidated Police and Firemen's Pension Fund and the Police and Firemen's Retirement System. The Public Employees' Retirement System includes all non-uniformed City employees who are not eligible for enrollment in the City's Municipal Employees' Pension Fund. The Consolidated Police and Firemen's Pension Fund includes uniformed employees who were employees before 1944, while the Police and Firemen's Retirement System enrolls all uniformed employees who began employment after 1944.

The Division of Pensions in the State Department of Treasury administers the plans and charges municipalities annually for their respective contributions. The charges are based on actuarial valuations. The City pays such charges on a monthly basis.

### **City Plans**

All permanent City employees who are age 39 or younger when commencing employment with the City are required to enroll in the Employees' Retirement System of the City as of date of hire. All temporary employees who are age 39 or younger when commencing employment with the City are required to work one year before they are enrolled in the Employees' Retirement System of the City which is administered by a Pension Commission consisting of the Mayor, Chief Financial Officer, two elected employee representatives, and one appointed citizen member. Buck Consultants an ACS Company, serves as consulting actuary ("Actuary") for the system. In its latest report dated January 1, 2016, the Actuary reported:

GASB Statement No. 27 only requires valuation be performed every two years. The Annual Recommended Contributions payable for calendar years 2016 and 2017 are as follows:

	<b>December 31, 2016</b>	<b>December 31, 2017</b>
Normal Contribution <sup>(1)</sup>	\$ 1,667,756	\$ 1,734,467
Accrued Liability contribution	<u>7,173,577</u>	<u>7,459,249</u>
Total contribution	<u>\$ 8,841,333</u>	<u>\$ 9,193,716</u>

<sup>(1)</sup>The Normal Contribution amounts are 4.99% of estimated salaries of \$33,421,968 and \$34,758,847 for the 2016 and 2017 calendar years respectively. The actual normal contribution to the trust should be 4.99% of Actual salaries for each year.

Three other City pension plans are not maintained on an actuarial basis, but the City appropriates funds annually as required to provide benefit payments for the year. The plans are Employees' Non-Contributory Pension, Pensioned Employees and Payments to Widows and Dependents – Members of Police and Fire Departments.

In December 1996, the City received a bill from the Police and Firemen's Retirement System (PFRS) for approximately \$18,500,000 to pay for accrued pension liability due to an early retirement incentive program established in 1994. Legislation (P.L. 2002, c.42) was enacted that permitted the City to sell refunding bonds pursuant to the Local Bond Law to retire the present value of the unfunded accrued liability to PFRS. With an approval from the Local Finance Board, the City financed said liability through the issuance of \$23,595,000 Pension Obligation Refunding Bonds Series 2003A dated January 15, 2003 (Federally Taxable) and \$17,456,000 Pension Obligation Refunding Bonds Series 2003B dated March 15, 2003 (Federally Taxable). The following table shows the City's contributions to the respective pension systems for the last five years.

#### City Contributions to Employee Pensions

	<b>December 31, 2017</b>	<b>December 31, 2016</b>	<b>December 31, 2015</b>	<b>December 31, 2014</b>	<b>December 31, 2013</b>
<b>State of New Jersey</b>					
Public Employees' Retirement System	\$4,070,903	\$3,796,490	\$2,767,829	\$2,157,151	\$2,483,300
Consolidated Police and Firemen's Pension Fund	58,994	58,994	46,592	46,544	167,303
Police and Firemen's Retirement System of New Jersey	38,879,673	38,097,772	34,790,479	33,941,159	34,982,452
<b>City of Jersey City</b>					
Municipal Employees' Pension Fund	9,054,000	8,841,332	7,782,323	7,500,558	8,413,998
Employees Non-Contributory Pension (R.S. 43:8 B-1)	230,000	260,000	246,020	220,800	225,000
Pensioned Employees (R.S. 43:4-1)	64,740	59,735	65,000	69,600	72,000
Payments to Widows & Dependents- Members of Police & Fire Depts.	<u>779</u>	<u>779</u>	<u>780</u>	<u>720</u>	<u>720</u>
<b>TOTAL</b>	<u>\$52,359,089</u>	<u>\$51,115,102</u>	<u>\$45,699,023</u>	<u>\$43,936,532</u>	<u>\$ 6,344,773</u>

Source: Derived from the Calendar Year 2013-2017 Audited Financial Statements of the City

## Post-Employment Benefits

The City provides eligible retirees with medical, prescription drug and life insurance benefits. Based on an assumed discount rate of 4.50%, as of June 30, 2015 the Unfunded Actuarial Accrued Liability for such post-employment benefits was \$976,949,569, and the Annual Required Contribution was as follows:

Normal Cost	\$35,135,265
Annual Amount Toward Unfunded Actuarial Accrued Liability	<u>57,393,724</u>
Annual Required Contribution	\$92,528,989
Less: Actuarial Determined City Contribution (Estimated)	<u>26,167,422</u>
Net Increase	\$66,361,567

## INSURANCE

### Insurance Fund Commission

The Jersey City Insurance Fund Commission was established in 1984 pursuant to N.J.S.A. 40A:10-1, *et seq.* The members of the Commission are the City's Business Administrator (who serves as Chairperson) and two members of the Municipal Council. All insurance upon property owned or controlled by the City or any of its departments, boards, agencies or commissions, is required to be placed and effected by the Commission. The powers of the Commission are statutory and include the power to invest the funds and all additions and accretions thereto in such securities as they shall deem best suited for the purposes of the statute; keep on hand at all times sufficient money, or have the same invested in such securities as can be immediately sold for cash, for the payment of losses to any buildings or property of the City, or liability resulting from the operation of publicly owned motor vehicles, equipment or apparatus; and fix reasonable rates of premium for all insurance carried by the insurance fund, and shall effect all insurance in the insurance fund or with any insurance company or companies authorized to do business in this State.

## LITIGATION

### General

The City, its officers and employees are defendants in a number of lawsuits including, but not limited to, lawsuits arising out of alleged torts, alleged breaches of contract and alleged violations of civil rights. The City is also engaged in activities, such as police protection and public works construction, which could result in future litigation with a possible significant monetary exposure to the City.

Based upon the information available to date, it does not appear that any individual lawsuit or the cumulative effect of these lawsuits will impair the City's ability to pay any judgments or settlements in an orderly manner, since the likelihood is that the amount of any judgments and eventual settlements will be much less than the amount claimed, and payments can be spread over two or more fiscal years. Because many lawsuits are still in the discovery stage, the Corporation Counsel is unable to determine the probability of a successful defense to them at this time.

The City self-insures against tort claims, which include general liability, automobile liability, employment practices, public officials and police professional and workers compensation lawsuits. The self-insured retention depends upon the date of incident and which of two excess policies provides coverage.

### Pending Litigation

The following information has been compiled as of October 2018. The cases listed below have a potential monetary exposure in excess of \$500,000.00.

Valerie Montone v. Jersey City Police Department et al.

This federal lawsuit involves allegations by a retired police sergeant that the defendants (former Mayor Healy and former Chief of Police Troy) did not promote her because of her political affiliation and gender. This matter has been litigated in state and federal court. After discovery, summary judgment was granted to the Jersey City defendants on both the state and federal causes of action; however, the plaintiff appealed the matter to the Third Circuit Court of Appeals. The Third Circuit reversed the district courts holding and remanded the matter to the lower court. On April 16, 2017, this matter was tried. The jury awarded plaintiff approximately \$280,000 in loss wage damages. The City intends on filing an appeal.

Astriab et al v. City of Jersey City.

This lawsuit is the companion case to Montone matter. In this case, eight other sergeants allege that because Montone was wrongfully not promoted to Lieutenant, they could not be promoted since they were behind her on the promotion list. With regard to damages, they claim they are entitled to the difference in pay and benefits between what they would have received if they had been promoted and what they actually have received, including pay, benefits and pension contributions/value. These claimed damages continue to accrue as the case proceeds. This matter has the same procedural history as Montone case. After the trial in this matter, the jury awarded the plaintiff's approximately \$2,000,000 in damages. The City intends on filing an appeal.

212 Marin Blvd. v. City of Jersey City (Sixth Street Embankment cases).

Various lawsuits brought by several entities regarding the property known as the Sixth Street Embankment. The alleged owners contend that the City has interfered with their development rights and violated their constitutional rights. These matters have been pending for several years despite numerous attempts to achieve a settlement. The City continues to defend against all claims.

Bruno v. City of Jersey City.

This matter involves claims for wrongful death and personal injury. Plaintiffs allege in their complaints that on July 27, 2012, co-defendant Frederico Bruno illegally entered their apartment located at 110-112 Rutgers Avenue, Jersey City. Mr. Bruno waited for Ms. Figueroa, Ms. Calderon and infant Damien Rose Bruno to arrive. Upon their arrival, Mr. Bruno violently attacked plaintiffs resulting in the death of Damien Rose Bruno, and bodily injuries to Ms. Figueroa and Ms. Calderon. Plaintiffs allege that the day before incident, Bruno appeared at a Jersey City police station to inquire about any open arrest warrants. Plaintiffs allege that Bruno had open warrants at the time, but was not detained. Plaintiffs allege that the Police Department failed to enforce the restraining order or act on the outstanding warrant. Trial started on August 7, 2017. At the conclusion of plaintiffs' case, the City was granted a directed verdict on all claims. Plaintiffs have filed an appeal that is still pending. If plaintiffs are successful on appeal and a re-trial, exposure could surpass \$1,000,000.

Mays v City of Jersey City.

Plaintiff, the City's Deputy Tax Assessor, has brought a claim in federal court for race discrimination and retaliation. She also alleges a whistleblower claim under CEPA. Discovery is ongoing. Written discovery is complete, plaintiff has been deposed, and plaintiff's counsel has deposed approximately ten defense witnesses. If plaintiff is able to prove her claims at trial, she could obtain an award between \$200,000 - \$300,000 for her severe emotional distress, as well as an attorneys' fees award between \$250,000 - \$300,000.

MEPT v. City of Jersey City, et al.

In 2009, the City of Jersey City entered into financial agreements with MEPT Journal Square, LLC, MEPT Journal Square Tower North Urban Renewal, LLC, and MEPT Journal Square Tower South Urban Renewal, LLC (collectively the "Plaintiffs") for long term tax abatements (30 years) for the development of certain real property. The agreements were entered into pursuant to the appropriate ordinance and resolution. Plaintiffs agreed to and



made a contribution to the City's Affordable Housing Trust Fund (\$710,769). Plaintiffs also entered into a Prepayment and Contribution Agreement under which the Plaintiffs agreed to and did prepay a certain amount of money (\$2 million) that was to be credited against the service charges to be collected over the first four years following completion of construction of their projects. Approximately six years after the financial agreements were executed, Plaintiffs abandoned this project and sold the property. Indeed, the Plaintiffs failed to develop the property as originally intended. In 2015, Plaintiffs filed this declaratory action seeking the refund of the prepayment and the Affordable Housing Trust Fund payment for a total sum of \$2,710,769. On December 4, 2015, Plaintiffs moved for a summary proceeding for a declaratory judgment under N.J.S.A. 2A:16-50 in order to have all monies refunded to them. On October 4, 2016, the court entered an order of judgment in favor of the Plaintiffs directing the City to pay \$2,710,769 to Plaintiffs. Shortly thereafter, the City moved for reconsideration of the court's order and this motion was denied. The City filed a notice of appeal. The appellate division partially reversed the trial court, and lowered the amount owed to approximately \$2,000,000. We have filed a petition for certification to the Supreme Court.

#### Estate of Gonzalez v Jersey City

On August 8, 2014, officers Tucker and Hashmi were dispatched to assist Hiram Gonzalez whose vehicle was disabled. Thereafter, the officers arranged for the car to be towed and begged Mr. Gonzalez to allow them to drive Gonzalez to a safer area with less traffic but Gonzalez refused. Dispatch then ordered the officers to resume patrol. Approximately 1 hour later, Gonzalez was hit by a vehicle driven by one of the co-defendants and died. Plaintiff alleges Gonzalez was drunk at the time Officers Hashmi and Tucker assisted him and the officers' failure to drive Gonzalez to a safe area resulted in Gonzalez's death. The court granted summary judgment in favor of the City. Plaintiff has appealed and the appeal is pending. Because this is a wrongful death action, the city's exposure could well exceed \$500,000.

#### Estate of Lavon King v. City of Jersey City, et al.

In this matter, a Jersey City police officer fatally shot decedent after he tried to disarm the officer. Plaintiffs contend that the officer unnecessarily used excessive force in violation of the decedent's constitutional rights. The City contends that the officer used reasonable force. If plaintiff succeeds, exposure could surpass \$500,000.

#### Oliver/D'Onofrio v Jersey City, et al

While crossing the street on October 23, 2015, decedent Ralph D'Onofrio was hit by a vehicle driven by one of the co-defendants (Musa). D'Onofrio was transported to Jersey City Medical Center and died approximately 3 days later. Plaintiff alleges that the street lights were not working at the time of the accident and caused the driver to hit Mr. D'Onofrio. Because this is a wrongful death matter, the city's exposure may exceed \$500,000.

#### O'Donnell v NJ Turnpike

On February 22, 2016, decedents were driving in the City of Jersey City and were hit by another vehicle operated by defendant Scott Hahn who at the time had not slept for 26 hours and was under the influence of Adderall. A witness allegedly saw Mr. Hahn stop at a gas station and confer with a Jersey City police officer moments before the accident. Plaintiff alleges that the police officer had a duty to stop Hahn from driving and that the breach of this duty resulted in the fatal accident. Because there are two dead victims, exposure in the case could well exceed \$500,000.

#### Feliz-Rodriguez v. City of Jersey City, et al.

On June 4, 2017, members of the JCPD were involved in a motor vehicle pursuit. During the pursuit, the vehicle being pursued crashed into plaintiff's vehicle causing both vehicles to engulf in flames. Plaintiff sustained severe burns to his body. In addition, plaintiff claims that as he exited his vehicle, he was attacked by members of the JCPD. Plaintiff has brought suit against the City and numerous police officers for an assortment of negligence and civil rights claims. Because of the alleged injuries, the city's exposure may exceed \$500,000.

During the calendar years 2013 through 2017, the City paid the following amounts in judgments and settlements:

<u>Year</u>	<u>Amount Paid*</u>
CY 2017	\$482,769
CY 2016	2,348,280
CY 2015	1,181,928
CY 2014	1,460,362
CY 2013	494,286

\*Source: Jersey City Insurance Fund Commission

### **Environmental Issues**

There are many privately and governmentally owned parcels of real estate in the City containing various levels of environmental contaminants. With respect to privately owned real estate, the City, State and Federal health and safety officers have undertaken and continue to compel compliance by the owners with the existing regulations. The City aggressively uses its building inspectors and health officers to monitor and compel abatement of harmful environmental hazards. With respect to environmental contamination which does not pose an immediate or substantial public safety or health issue, the City is increasingly using local business incentives to stimulate previously dormant property for conversion to useful economic initiatives including the removal of environmental contaminants. The City itself monitors its own real estate and has undertaken and is currently performing building and facility improvement programs to remove all violations of Federal, State and City environmental regulations.

### **CITY ECONOMIC AND DEMOGRAPHIC INFORMATION**

The City is New Jersey's second largest municipality with a population of 247,597 according to the United States Department of Commerce's 2010 Census. The City is located on the west side of the Hudson River, directly across from lower Manhattan in New York City, and is part of the major business and industrial concentration spanning the New York – Northern New Jersey metropolitan area.

The City's land area is 15.8 square miles, including a five mile long stretch of Hudson River waterfront that has experienced considerable high rise office tower, residential and multi-family development over the past ten years. The City is connected to New York City by the Holland Tunnel and the PATH railroad tubes and is within ten miles of Newark International Airport and the container and cargo facilities of Port Newark-Elizabeth. The City's size and current development activity cause it to dominate the economy of the County (the Jersey City Labor Area). The City also serves as the seat of the County government. Of the approximately 275,000 persons employed in the County, approximately 43% are employed in the City.

### **Population**

The City had experienced a population decline from 1970 through 1980, however due to increased residential housing developments, the population has shown a trend toward increasing.

<u>Year</u>	<u>Population Trend (Calendar Year)</u>		
	<u>City</u>	<u>County</u>	<u>State</u>
2010	247,597	634,266	8,791,894
2000	240,055	608,975	8,414,350
1990	228,537	553,099	7,730,188
1980	223,532	556,972	7,364,823
1970	260,545	609,065	7,192,805

Source: U.S. Bureau of the Census: Censuses of Population and Housing.

**School Enrollment**

<u>Fiscal Year</u>	<u>Average Daily Enrollment</u>	
	<u>Student Enrollment</u>	<u>Percent Change</u>
2017-2018	27,330	-1.25%
2016-2017	27,672	-.44%
2015-2016	27,794	-2.75%
2014-2015	28,562	-4.50
2013-2014	29,909	4.50
2012-2013	28,621	2.65

Source: Jersey City Public Schools: www.jcboe.org

**Residential Dwelling Units**

Most of the housing stock in the City was constructed in the first half of the twentieth century, primarily for renter-occupied use.

**Housing Characteristics**

Owner Occupied	28,888
Total Units .....	110,140

Source: U.S. Bureau of the Census: American Community Survey 2014

**Employment**

**Labor Force - The City of Jersey City**

<u>Year</u>	<u>Total Labor Force</u>	<u>Employed</u>	<u>Percent (%) Unemployed</u>
2017	141,438	134,950	4.4%
2016	140,500	133,800	4.8%
2015	140,658	133,184	5.3%
2014	139,551	130,539	6.5%
2013	138,427	127,195	8.1%
2012	139,531	127,018	9.0%

Source: New Jersey Department of Labor, Office of Labor Planning and Analysis--2012-2017.

**Overview of Jersey City**

Founded in 1630 and incorporated in 1820, Jersey City once served as a shipping, manufacturing, and rail transportation hub. Home to Ellis Island, Jersey City has served as the gateway to the United States for millions of immigrants.

Today Jersey City is a vibrant and thriving city, where rail yards, factories, and warehouses have been transformed into parks, restaurants, shops, and modern skyscrapers. Seven of the ten tallest buildings in the state are found in Jersey City, with construction recently starting on what will soon be the tallest building in the State and the tallest residential building in the western hemisphere outside of New York City. Jersey City residents and visitors enjoy spectacular views of the New York City skyline with miles of Hudson River waterfront. Jersey City's robust transportation infrastructure allows for easy access to New York City using the PATH train subway system, NY

Waterway Ferries, or the Holland Tunnel. An expansive above-ground light rail system that opened in April of 2000 connects Jersey City to neighboring municipalities.

The 2010 Census population of Jersey City is currently 247,597 and the 2016 Community Survey estimates 264,152. From 2010 to 2016 the population of Jersey City increased by 10%. The vacancy rate for rental units in Jersey City decreased by 30.6% from 2000 to 2016. It has been growing steadily at a rate of 3-6 % since a low of 223,532 in 1980. According to estimates based on the United States Census Bureau American Community Survey, Jersey City will be the largest city in New Jersey by the end of 2016. At the present time, Jersey City has established itself as a leader in urban development within the State of New Jersey:

Downtown – 11,587 units approved  
4,534 units under construction, and 20,409 completed within the last 15 years

Journal Square – 8,927 units approved  
1,260 units under construction

Bergen Lafayette – 1,611 units approved  
856 under construction

West Side Avenue – 583 units under construction

In 2016 a total of 3,174 housing units were authorized by building permits according to the Department of Community Affairs.

### Employment

From January to December of 2017 Jersey City's unemployment dropped from 4.4% to 4.2%. The significant unemployment rate decrease is due to several large firms either relocating to Jersey City or expanding current operations within existing Jersey City facilities. JPMorgan Chase, RBC, Forbes, Imperial Bag, Nautica, and Ahold are some of the largest companies relocating or expanding Jersey City operations. Jersey City has also seen an increase in construction jobs with more than 4,000 jobs recently started or planned as part of approved upcoming projects.

Source: New Jersey Department of Labor and Workforce Development

### Largest Private Employers in Jersey City\*

<u>Employer Name</u>	<u>Total Full Time and Part Time Employees</u>
Goldman Sachs & Co. Inc.	3,782
Pershing LLC/Mellon Bank	2,000
ICAP Services North America LLC	1,796
JP Morgan Chase Bank	1,592
Citigroup	1,500
Computershare Investor Services, LLC	1,348
Deutsche Bank Trust Co. NJ Ltd.	1,200
Broadridge Information Service, Inc.	1,000
Insurance Service Office, Inc.	1,000
Fidelity Investments	1,000
Equitable Life Insurance Co.	816
Bank of Tokyo Mitsubishi Trust	800
IPC Acquisition Corp.	750
Lord, Abbet & Company	715
Brown Bros Harriman & Co.	700

Home Depot USA, Inc.	548
Ritter Sysco Food Service	529
Prebon Yamane (USA) Inc.	520
Daily News	500
Langer Transport Corp.	475

\*As reported to the State of New Jersey, January 2017. Does not include public employers, i.e. hospitals, schools, or other government agencies  
Source: Hudson County Economic Development Corporation, Jersey City.

## Tourism

Tourism is a growing industry for Jersey City with three new hotels (700 new hotel rooms) under construction. While Liberty State Park, Liberty National Golf Course, Ellis Island, and the Statue of Liberty attract millions of visitors each year, in 2014, Jersey City proudly hosted the Seattle Seahawks and Denver Broncos, their families, and many of their fans for the week leading up to the Super Bowl. Jersey City is also home to one of the largest 4<sup>th</sup> of July fireworks displays in the country.

## Higher Education

Jersey City is home to St. Peter's University, with an enrollment of approximately 3,400 students in 2015, and New Jersey City University, with an estimated enrollment of 8,200 students, both of which offer full and part-time undergraduate studies in liberal arts, business and the natural and social sciences. In addition, St. Peter's has graduate programs in education, nursing, accounting, and business administration and New Jersey City University offers a wide variety of graduate programs. Jersey City is also the home to Hudson County Community College, which offers entry-level occupational and career certificates and associate degrees to prepare students for employment and to upgrade existing skills. The Community College has an estimated enrollment of over 10,000.

Sources: Saint Peter's University Website: [www.saintpeters.edu](http://www.saintpeters.edu);  
New Jersey City University Website: [www.njcu.edu](http://www.njcu.edu);  
Hudson County Community College Website: [www.hccc.edu](http://www.hccc.edu).

## Healthcare

The Jersey City Medical Center, a voluntary not-for-profit hospital, moved to a new hospital facility in 2004 at a site on Grand Street and Jersey Avenue to replace the Medical Center complex built in the 1930s. The facility is currently operated by Liberty Health and is the region's "state designated trauma center" and the only hospital in Hudson County approved for open heart surgery. A new 5-story Medical Office Building was completed in 2010 and is fully leased, including the Cristie Kerr Women's Health Center. See "CITY INDEBTEDNESS AND DEBT LIMITS – Other City-Related Obligations" herein.

## Economic Incentives

Jersey City's Urban Enterprise Zone (UEZ) is one of the top performing zones in the state. It is comprised of approximately 1/3 of the city's total land acreage. Revenue from the UEZ Program has funded many development initiatives throughout the City, such as national and international marketing campaigns, special events, preservation, city beautification projects, CCTV program, job training, tourism ([www.destinationjerseycity.com](http://www.destinationjerseycity.com)), and business improvement and relocation grants. In the past, the City received approximately \$16.2 million annually to be used for various programs. However, the City has not received any funds since 2009 due to State budgetary constraints.

The Jersey City Economic Development Corporation manages and maintains business and employment support systems. Some of the benefits available to Jersey City UEZ-certified businesses are listed below:

- Reduced sales tax for certified retail businesses
- Employee tax credits for each UEZ municipality resident hired
- Jersey City Employment & Training Program
- City Beautification Program
- Closed Circuit TV Neighborhood Watch Program
- Customer Service Skills Center

Additionally, the JCEDC has expanded opportunities for local small business owners to access capital, through partnerships with private and non-profit lenders. The Jersey City Fund is a \$10 million dollar loan program targeting small businesses with small lending needs; the EDC also has a microloan program based on geographic location, meant to support businesses opening in the city's traditionally underserved neighborhoods.

### **The Hudson River Waterfront**

Recently dominated by the financial services industry, as more new skyscrapers with class A office space are constructed a more diverse workforce has developed.

Since the early 1980's, more than 18 million square feet of office space, and over 18,000 new residential units, and five hotels providing nearly 1,500 rooms have been completed. Redevelopment of the waterfront and nearby neighborhoods has been brisk, accelerating with the construction and opening of the Hudson Bergen Light Rail system. Plans for the redevelopment of formerly industrial land along Jersey City's waterfront currently include as much as 30 million square feet of office space and more than 35,000 new residential units.

The number of new residences authorized by building permits city wide, from 1995 through 2007, totals over 17,000 residences while and non-residential office space authorized by building permits exceeded 7 million square feet. The Newport Neighborhood is the largest single development on the Hudson River Waterfront. Built on 300 acres of abandoned rail yards at the edge of the river, this area now is home to 4,000 residential units and 14 residential towers, a park with a man made beach overlooking the river, the Newport Centre Mall, and a variety of office buildings.

Currently under construction but recently topped off, by 2019 completion of 99 Hudson is expected to become a permanent fixture in the Jersey City skyline. It will be the tallest building in Jersey City at 900 feet with 781 units.

### **The Hackensack River Waterfront**

The Hackensack River Waterfront is another powerful City resource whose value has only recently been re-discovered. The improved environmental quality of the Hackensack River and the return of water-related recreation to the river have helped to reinforce its value. The first signs of its rebirth include: the fully sold out Society Hill and Droyer's Point development, a 1,400 Dwelling unit condominium community; the establishment of Meadows Path which is a planned pedestrian walkway along the Hackensack River stretching from Bergen County to Bayonne; commitment by the County of Hudson to establish an extension to the county park system; the completion of the 9 hole Golf course within the Hackensack River Edge Redevelopment Area; implementation of the City homes at Westside Station loft style residential project within the Water Street Redevelopment Plan area; transformation of a 32-acre former federal superfund site into the "Marion Greenway" - Phase I involves the remediation and capping of the site for passive recreation and Phase II includes a 2000 foot waterfront walkway, soccer fields, jogging paths and an Environmental Center; implementation of the remediation plan and environmental clean-up of the 100 acre former Honeywell site for the creation of a mixed use new-urbanist neighborhood within the Bayfront I Redevelopment Plan Area. This development will include the creation of over 15 acres of parkland in the form of a bikeway, central greenway, new pedestrian-friendly streets and infrastructure, approximately 4,200 to 8,100 new dwelling units, 700,000 to 1 Million sq. ft. of office floor area, and 200,000 to 600,000 sq. ft. of retail space.

All this development is part of a larger plan for the Jersey City western waterfront known as the Bayfront Redevelopment Area. The study establishes the ground work for the creation of new-urbanist neighborhoods and new streets to connect into the existing neighborhoods of Greenville. The Bayfront Redevelopment Plan anticipates

the redevelopment of land both east and west of Route 440, the re-design of Route 440 through federal funding appropriated to Jersey City, and ultimately leading to the extension of the Hudson-Bergen Light Rail System roughly ¼ of a mile to the west in order to access the Bayfront 1/Honeywell Project and the Hackensack River.

The old Department of Public Works facility along the Hackensack River (Bayfront 1/Honeywell Project) will soon begin redevelopment into hundreds of residential units as well as retail shops and entertainment and dining options.

New Jersey City University has been in the process of a \$350 million expansion that includes 4 private residential buildings totaling 600 units, a new Shop-Rite, a new Center for the Arts, and a new 424 bed dormitory all on the 21 acre lot the University owns between Route 440 and West Side Avenue. It also includes the construction of 2 new streets, providing more efficient connection along West Side Avenue.

### **Journal Square**

Functioning as a major regional transportation hub, Journal Square encompasses the neighborhood surrounding the Journal Square PATH station and bus terminal, which provides access to New York City, Newark, Hoboken, and Harrison via the PATH subway train system and bus service throughout the region via 7 different bus lines. The first significant construction in Journal Square in decades is nearly complete with the first of three towers in the "Journal Squared" development project. Upon completion, this development will consist of a 54 story tower, a 60 story tower, and a 70 story tower. As of February 2016, there are 5,284 dwelling units, 195,055 square feet of office and 432,787 square feet of retail space approved for development in the Journal Square area. Under construction there are currently, 1,334 dwelling units, 70,070 square feet of office and 13,267 square feet of retail space to come on line within the next eighteen months.

The Loew's Jersey Theatre, a 3,000 seat "movie palace" originally opened in 1929, is a priority restoration project for Jersey City. The facility will soon undergo an extensive multi-million dollar renovation to restore the energy, glory, and full functionality to the theatre and to the neighborhood as a whole. AEG Live, the second largest event promotion company in the world, is planned to manage programming (along with partnerships with NJCU, Mana Contemporary, and a variety of community groups) and ACE Theatrical Group, the premiere theatre restoration company in the country, is planned to manage the construction and renovation of the facility.

The Jersey City Redevelopment Agency purchased the Pathside Building located at 25 Sip Avenue in Journal Square which is in the process of being transformed into the home of a new Jersey City Museum and Community Center.

On the periphery of the square is the adaptive re-use of the old American Can Factory. The CANCOloft project entails the creation of over 1,300 new loft style residential units and associated retail services. The new CANCOPark, completed in 2010, features an "orchard" of trees that is lit up at night by ground lighting, park benches, and a terraced layout. The park's perimeter is lined with bamboo shoots in raised planters. Manna Contemporary Fine Arts is truly a diamond in the rough with art exhibits almost every weekend. Several other smaller projects, like 25 Senate Place or the Kennedy Lofts at 100 Newkirk Street, continue to make this the new hip artist community in the New York Metropolitan region.

### **Transportation Improvements and Funding**

The City received federal high priority project funding for transportation access in the amount of approximately \$26 Million and the creation of an urban boulevard along Routes 440/1&9 Truck in the amount of \$1.8 Million.

North Jersey Transportation Planning Authority, (NJTPA) Area metropolitan Planning Organization awarded Jersey City the following grants:

- FY 2008-2009 Subregional Study Program grant for Update to the Circulation Element of the Jersey City Master Plan in the amount of \$250,000;

- FY 2010 – 2011 Subregional Study Program Grant co-sponsored with Hudson County for a Study to improve transportation connections between the Cities of Hoboken and Jersey City in the amount of \$300,000;
- FY 2012-2013 Subregional Study Program grant for the Liberty State Park Circulator Cost-Benefit Analysis in the amount of \$220,000;
- FY 2012-2013 Subregional Study Program grant for the Morris Canal Greenway Plan in the amount of \$220,000; and
- FY 2012-2013 Subregional Study Program grant co-sponsored with Hudson County for The Jersey City/Journal Square/Bayonne Bus Rapid Transit Study in the amount of \$250,000.
- FY 2019-2020 Subregional Study Program grant for Parking Management Plan in the amount of \$300,000.
- FY 2019-2020 Subregional Study Program grant for Parking Management Plan in the amount of \$300,000.
- Over \$1 million in FY 2012 Local Safety Program grants for pedestrian improvements along Summit Avenue.
- \$885,838 in FY 2016 Local Safety Program grants for safety improvements along Marin Boulevard.
- \$288,524 in FY 2016 Local Safety Program grants for intersection improvements at St. Pauls Avenue and Oakland Avenue.
- \$3.8 million in FY 2017 Local Safety Program grants for pedestrian safety improvements along West Side Avenue.
- \$2.6 million in FY 2017 Local Safety Program grants for pedestrian safety improvements along Sip Avenue.

NJ Transit has completed the Hudson-Bergen Light Rail 440 Extension Alternatives Analysis, which identified the extension of the HBLR from its current terminus at West Side Avenue station across Route 440 to a new station at the northern boundary of the Bayfront Redevelopment Plan area as a locally-preferred alternative.

#### **Miscellaneous Infrastructure Improvements and Public Amenities**

- The Exchange Place PATH station was renovated in 1990 at a cost of \$65,000,000. The PATH provides a 3-minute ride from Exchange Place to the World Trade Center Station. The Port Authority's \$1.3 billion project to replace PATH's entire 340 car fleet and to overhaul the PATH signal system thereby enabling a significant increase in the number of train movements while improving on-time performance and efficiency is underway, with the entire rolling stock upgraded between 2008 and 2012 and signal system enhancements still underway.
- The \$1 billion Hudson Bergen Light Rail Transit System (HBLR) launched operation on April 15, 2000. Since then ridership has steadily grown as the system expands further north and south. It now connects with Hoboken's Lackawanna Station, which is adjacent to Jersey City and is a hub for regional commuter train service. It also now connects to a new Park & Ride station on Tonnelle Avenue in North Bergen that attracts commuters from Bergen County and other North Jersey locations, and which has been highly successful. Direct service is provided between the Park & Ride and the Jersey City waterfront employment center. A new extension to 8<sup>th</sup> Street in Bayonne opened in January 2011. Hudson County and Bergen County municipalities have urged NJTransit to expand the HBLR into Bergen County, with all municipalities with current or potential HBLR infrastructure passing resolutions in favor of this plan.



- Ferry service connects the Exchange Place/Paulus Hook, Hudson Exchange, Port Liberté and Liberty Harbor North areas to lower Manhattan, and also connects Exchange Place/Paulus Hook to 39<sup>th</sup> Street in Manhattan.
- The City has completed its renovations of the Owen Grundy Pier Park at the foot of Exchange Place. This is one of several significant public spaces that exist along the Jersey City Waterfront.
- The Hudson River Waterfront Walkway is advancing toward completion along the waterfront as development of properties adjacent to the waterfront continues. It is now possible to walk from the Goldman-Sachs tower at the south eastern corner of Paulus Hook and Downtown to the Newport area and into Hoboken. The Newport Walkway now connects to Hoboken at the Hoboken Train Station and Newport Associates Development Co. has completed “Newport Green” a Waterfront park at Fourteenth Street. The development of Veterans Park will include the critical portion of the waterfront walkway at the park’s edges along the Hudson River and the Morris Canal.
- New Jersey Department of Transportation is in the process of the reconstruction of the 12<sup>th</sup> and 14<sup>th</sup> Street viaducts from Route 139 to Jersey Avenue. The next phase will be the reconstruction of Route 139. NJ DOT is planning to construct a new Wittpenn Bridge over the Hackensack River and a new St. Pauls Avenue Viaduct that will link the bridge to Route 139, Tonnelle Avenue, Route 1&9 Truck, and a proposed new road parallel to Tonnelle Avenue. NJDOT is also planning to build a bridge on Jersey Avenue across the Morris Canal to allow easier travel from downtown Jersey City into Liberty State Park, Bergen Lafayette, and other parts of the city. Currently only a small foot bridge exists.
- Capital Improvement, Federal Grant, and UEZ Funding have been pooled to finance the re-surfacing and beautification of Christopher Columbus Drive. This is the main and most visible travel route from the NJ Turnpike to downtown neighborhoods and the waterfront.
- Jersey City launched the CitiBike bike-share system in September 2015. Because CitiBike is the same system used in New York City, residents can now seamlessly integrate into the broader regional bike-share network across the Hudson River. As of March 2016, only six months after the programs launch, 75,000 rides had already been taken.

### Key districts and development areas within Jersey City

**Hackensack River Edge Redevelopment Area.** The City Council adopted a redevelopment plan that encompasses a number of properties on the City’s western waterfront, the redevelopment of which will include the remediation of the PJP landfill. An Urban Transit Hub tax credit package of \$34.6 million over ten years has been approved by the Board of the New Jersey Economic Development Authority which allowed Peapod and Ahold to utilize 344,000 square feet of the Pulaski Distribution Center, an 878,564 square foot warehouse recently completed along Route 1 & 9 by Prologis.

**Claremont Industrial Center.** West of Caven Point, the Claremont Industrial Center was developed on a 30-acre site by the New Jersey Economic Development Authority. Hartz Mountain Industries built and leased a 175,000 square foot warehouse for Walong Marketing, a food distributor and importer in the summer of 2002. Demand for warehouse space here dropped as the recession hit and the City responded by amending the Zoning to allow entertainment venues. In January 2011, “Pole Position Raceway” opened an 80,000 square foot facility featuring two quarter-mile tracks. The high-performing all electric karts can reach speeds of 45 miles per hour. The facility features a Tailgate Café, video and arcade games, meeting and party rooms, and an impressive display or racing memorabilia.

**Liberty Industrial Park.** In January 1996 construction was completed by the New York Daily News of a new 410,000 square feet printing plant. The Daily News has moved both their Brooklyn and Kearny operations to this new facility. The project represents a \$180 million investment by the Daily News. Sysco Food Services of Metro New York has renovated the former Allied/Sterns building into 345,000 square feet of freezer/warehouse

space. This project provides over 500 jobs. The total project cost was \$25 million, \$ 8 million of which was provided through the City and HUD by a Section 108 Loan.

**Port Jersey/Greenville Yards.** On the southernmost portion of the waterfront, the Port Jersey Corporation has developed 3,000,000 square feet for industrial distribution buildings since assuming control of the urban renewal project in 1969. The Corporation has invested \$150 million to date. The Port Authority of New York and New Jersey has constructed an imported automobile facility on its 80-acre portion of Port Jersey and on 65 acres of the Greenville Yards. Iron Mountain Information Management has leased 123,000 square feet at 100 Harbor Drive, providing more than 100 full time jobs. In addition, Summit Import Corp. and Preferred Freezer Services have recently opened warehouse facilities in Greenville Yards. Preferred Freezer is also undertaking building a second new facility freezer. Keystone Properties constructed two warehouse facilities consisting of over 500,000 square feet of available warehouse space.

**Jersey Eagle Sales Co.** A 100% minority owned business exclusively distributing for Anheuser-Busch in Hudson County has completed construction of a 70,000 square foot, \$4.5 million chilled warehouse and distribution facility, providing nearly 100 full-time jobs.

**Montgomery Industrial Center.** The 32-acre industrial park adjacent to **The Beacon** was developed by the New Jersey Economic Development Authority, which also makes development bond financing available to potential tenants. The firms in the Montgomery Industrial Center have created more than 300 construction jobs and 600 permanent jobs. Rajbhog Foods, makers of Indian bread, constructed a new plant with assistance from the New Jersey Business Employment Incentive Program and the New Jersey Local Development Finance Fund, and a \$50,000 relocation grant from the Jersey City Urban Enterprise Zone. Other food related services attracted to this location are Wei Chuan USA and Woolco Foods. DeBragga & Spittler relocated to 55-77 Amity Street from the Meatpacking District in Manhattan. They are leasing an existing warehouse and purchasing the adjacent vacant land for parking and eventual expansion. They certified into the UEZ Program and took advantage of Jersey City's \$50,000 relocation grant.

**Newport Redevelopment Area Project** The Newport Center project is a 300-acre, master-planned mixed use community consisting of retail, residential, office, leisure, and entertainment facilities. In December 1982, Jersey City received approval of a \$40 million Urban Development Action Grant (UDAG), the largest ever awarded in the history of that Federal program, that effectively jump started the Newport development. The first building constructed was the Newport Centre Mall. It is a premier shopping center with 130 individual stores, anchored by 4 major department stores, a multiplex movie theater, and a food court. Since that time, development has continued in earnest, extending roadways, transportation choices and other community amenities. The Newport Associates Development Co. has just completed "Newport Green", a new 5-acre playground and park connecting Washington Boulevard to the Waterfront Walkway at Fourteenth Street. It includes the first urban beach in New Jersey, a recreational field, an outdoor ping pong table, and several landscaped gardens.

"The Ellipse," the most recent tower to complete construction, is a 41 story, 381 apartment rental building. It is the tallest building in the Newport area and is directly along the waterfront walkway. The building's exterior elliptical shape was designed by the world-renowned architecture firm Arquitectonia

Over \$2 billion has been invested and more than 11 million square feet has been constructed at Newport. When completed, the \$10 billion investment into the Newport community will provide housing for approximately 30,000 residents in 9,000 apartments and have a 1.5 mile section of the Hudson River Waterfront Walkway., 7 million sq. ft. of prestigious office space and two million square feet of retail and shopping opportunities. The Newport Redevelopment Area has developed into another new thriving neighborhood of the city. In addition to the mall, area residents and visitors can take advantage of 14 acres of green space, educational facilities, health and wellness facilities, and even a yacht club.

**Powerhouse Arts District Redevelopment Area.** The Powerhouse Arts District Redevelopment Plan area includes a collection of historic warehouses that have been re-used for residential, art, and entertainment uses. The district is unique and lends itself to conversion to a funky, trendy, retail and entertainment center. This district is 2-4 blocks west of the waterfront and is anchored by the Powerhouse building, an historic structure formerly the power

station for the Hudson and Manhattan Railroad. The 100-year-old castle-like building near the waterfront is owned by the City of Jersey City. The Cordish Company in conjunction with the NY/NJ Port Authority and the Jersey City Redevelopment Agency have entered into a memorandum of agreement to stabilize and rehabilitate the former powerhouse into an entertainment destination for the waterfront. The Cordish Company plans to breathe life into the deteriorating power plant just as it has successfully done in the Baltimore Inner Harbor.

Toll Brothers City Living recently completed the Provost Square development, a 3 acre site in downtown Jersey City just a block from the Grove Street PATH station. The development includes 3 high-rise towers, 38, 33, and 28 stories, totaling 927 units, 960 parking spaces, 45,000 square feet of retail, and a state of the art 24,000 square foot theater as well as 17,000 square feet of art related space. In between the buildings is a half acre public plaza.

**Liberty Harbor North.** This highly successful project does not look like a project at all. It is designed to be an extension of the existing neighborhoods that surround it. This project has two marinas, several miles of waterfront walkway, direct connections to Liberty State Park, ferry service to NYC, two Light Rail Stations and enjoys sweeping views of Liberty State Park, Lower Manhattan and the NY Harbor. It was designed and master planned by the Congress for New Urbanism co-founders Andres Duany and Elizabeth Plater-Zybek. Phase one is complete with 600 residential units. New retail establishments have opened, including the immensely popular Zeppelin Hall Beer Garden, Surf City Beach Bar, Tilted Kilt Pub, and Brew Shot Coffee Shop. Several mixed use projects by a number of different developers have also followed on the coattails of this project, including Gulls Cove, a 320 Condominium building, completed in 2007, “225 Grand”, completed in the summer of 2010 with 348 unit rental building by Ironstate Development, Inc. and the KRE Group, and “18Park”, completed in the spring of 2014 with over 400 units. The 11 story 18Park facility also includes space for the Boys and Girls Club of Hudson County.

The planning board has also approved a mixed use building that includes a full service flagship Marriott hotel and 475 residences. As many as eleven (11) other buildings are already approved for the area, including a new waterfront park, central park and civic plaza.

**Harborside Financial Center.** The Harborside Financial Center began with a successful warehouse conversion from a refrigerated rail warehouse to Class A office space, which was followed by the construction of new office towers. It is an office and commercial holding of Mack-Cali Realty located on the Hudson River Waterfront. The complex includes restaurants, a retail promenade, two tiered waterfront walkway with outdoor dining and additional service amenities. The Harborside Financial Center currently consists of six office buildings, an indoor and outdoor garden/plaza, and a HBLRT Station. It is all just minutes away from downtown Manhattan via PATH train or ferry. The complex also contains luxury rental apartments on the North Pier and a full service hotel on the South Pier. The Hyatt Regency Jersey City was the first full-service hotel on the Jersey City waterfront. It features 350 guest rooms, over 19,000 square feet of meeting and facility space, a 165-seat restaurant, and a 75-seat lounge and incredible views of Manhattan and the New York Harbor. The current Master Plan for Harborside envisions one more office tower for Plaza 4 and six residential towers on Plazas 6, 7, 8 & 9, new roadway extensions and a widening of the pedestrian plaza adjacent to the light rail station.

Existing Commercial/office building of Harborside are as follows:

Harborside Plaza 1	400,000 Sq. ft.	Re-Use
Harborside Plaza 2	761,200 Sq. ft.	Re-Use
Harborside Plaza 3	725,600 Sq. ft.	Re-Use
Harborside Plaza 4a	207,670 Sq. ft.	New Construction
Harborside Plaza 5	977,225 Sq. ft.	New Construction
Harborside Plaza 10	577,575 Sq. ft.	New Construction

There are approximately 13,600 employees in the existing office towers.

2017 saw the completion of the Jersey City Urby building, a partnership with Ironstate and Roseland Residential, a 69 story, 713 foot tower with 762 apartments. The acclaimed Dutch design firm, Concrete, designed the iconic tower known for its Jenga-like architecture. This building is the first of 3 that will bring a total of 2,358 units upon completion.

In June 2017 the Planning Board gave approval for a new ferry terminal for New York Waterway connecting residents in that area to Battery Park City.

**Hamilton Square.** The Hamilton Square project accomplishes adaptive re-use of the former St. Francis Hospital complex. The old hospital formed an artificial barrier, separating Hamilton Park, a 2 acre Victorian Square, from the east side of the neighborhood. The first phase of this development is complete. The new retail includes a restaurant (GP's), an ice cream parlor that has received significant press and very positive reviews (Milk Sugar Love), wine store, pet store, and vintage department store. It brings the neighborhood together once again by re-establishing the cobblestone street leading to the park, rehabilitating some building, and replacing others. The blocks in the Hamilton Park historic district neighborhood are filled with classic row houses and lush, tree-lined streets.

**Colgate.** Colgate Redevelopment Area is a 24 acre, 10 block site of Jersey City waterfront south of Exchange Place. It was formerly the location of the manufacturing facility for the Colgate Palmolive Company. This area has experienced rapid growth over the past five years and is approaching its planned build-out of six million square feet of office space and close to 2,000 residential units. The first major project in the Colgate Redevelopment Area was 101 Hudson Street with 1.2 million square feet of office space in a well designed Art Deco Revival style skyscraper. Next, developed by Hartz Mountain Industries were 70 and 90 Hudson Street, two office towers on the riverfront with 358, 000 and 372,000 square feet. SJP Properties' renovation of 95 Greene Street, 280,000 square feet of office space in the former Colgate Perfume Building, has been completely leased by Merrill-Lynch. Goldman Sachs' now controls three site within the redevelopment plan area and treats this facility and the Sussex Street pier that they renovated as a public campus with ferry and helicopter access to their sister campus on the Manhattan side of the River. Goldman Sachs has completed their owner occupied office building, a 42 story, 793 feet tall tower with 1.5 million square feet of space, 1,000 underground car garage, ground floor pedestrian and retail amenities.

**Tidewater Basin Redevelopment Area.** The Tidewater Basin Redevelopment Area links new waterfront development with the existing Paulus Hook Historic District. The charm of this area is especially enhanced by watching cars share the path of the light rail trolley along the historic cobblestone street. The 324-unit Windsor at Liberty House was completed in September 2000. Other projects include the Pier House (106 condo units) and Hudson Point (181 rental units), two projects at the foot of Warren Street, Liberty Pointe, a 32 unit condo project just up Warren Street from those previously described, Fulton's Landing with 105 condominium units, and K. Hovnanian at Paulus Hook with 71 condominiums units are all occupied and complete. 198 Van Vorst Street, a 131 unit, 7-story residential project with 4,426 square feet of retail, is completed and occupied.

**Harsimus Cove Station Redevelopment Area.** Several residential projects have been completed and leased. Among the completed projects are the following condominium and rental units: Avalon Cove, Mandalay Bay on the Hudson, Portofino, Marbella, and the 'A'. These residential building encompass over 2,000 market rate units. Metro Plaza shopping center contains four retail buildings totaling 255,000 square feet. The Doubletree Hotel contains 200 rooms. The most recent project to be completed in the area is the Monaco, a residential development of 524 rental units in two 39 story towers atop a 10 story 558 space parking garage and 6,100 square feet of ground floor retail on what is was the Doubletree Hotel's parking lot. The Redevelopment Plan calls for a residential-commercial mixed-use district where certain lands are dedicated to the City of Jersey City for streets and parks. Projects recently completed include 110 First Street and Maribella phase II.

**Port Liberté, Liberty National Golf Course and Country Club, and the Residences at Liberty.** Redevelopment of this scenic area adjacent to Liberty State Park began in 1985 with the development of docks, jetties, and canals for luxury residential apartments and town homes, some with private boat slips at their front door. Later phases replaced new canal construction with an 18-hole professional Majors golf course and private club. Liberty National Golf Course hosted its first international PGA TOUR event, the Barclays, in August of 2009 and

again in August 2013. In 2017 it will host the President's Cup. More than 1600 condominium units are completed with another 1500 planned for the Port Liberté development area.

The Residences at Liberté is the residential development associated with the golf course. Construction has begun on 60 low-rise luxury units along the waterfront walkway and adjacent to the golf club house. When completed, the Residences at Liberté will produce over 1,000 new condominium units located within three towers on the northern slope of the golf course.

**Liberty State Park and Ellis Island.** Over 2,000,000 persons visit Liberty State Park annually, making it the most popular of all state parks in New Jersey. It is the largest urban park in the state, at approximately 1,200 acres. It currently houses, two Marinas, a boat launch, the Liberty House (a 15,000 square foot restaurant and banquet facility), the recently expanded Liberty Science Center, the restored historic Central Railroad of New Jersey Terminal, and an award-winning Interpretive Center. Maritime Parc Restaurant & Catering opened in October 2010 with a 30,000 square foot event space.

The restoration of Ellis Island is ongoing and the result of a partnership between the National Parks Service and Save Ellis Island, Inc. The South Side of the island contains valuable historic resources such as the hospital facility, laundry and luggage building, open space and recreation area, nursing residence and other various support building, totaling 30 in all, built at the turn of the century to welcome immigrants to our land. It is the intent of the National Park Service to renovate these buildings and keep them in public use. The American Family Immigration History Center was unveiled in 2001. Given its national and international stature, the Ellis Island Institute is proposed to be a unique cultural, educational and conferencing facility that will use the power of place to create a venue for international cultural events and meetings. It will be involve reuse of the 29 existing buildings on the island and new construction of a hotel, museum and educational facilities. At completion, it will employ 275 full-time and 350 part-time workers.

Ferries to the Statue of Liberty and Ellis Island leave from Jersey City, Liberty State Park throughout the day. The park, a state and regional amenity that attracts visitors from a wide area, is frequently the site of State wide events, including concerts, festivals, and tournaments.

The Division of Planning has conducted a Liberty State Park Circulator Cost-Benefit Analysis. This study is an important first step in restoring transit service to destinations within Liberty State Park. A circulator would build on the City's public transportation network that currently serves the edge of the park. This potential service would make the park more accessible to the 40% of Jersey City households that do not have access to a vehicle..

**The Beacon.** This central City project is the rehabilitation of a monumental Art Deco New Deal Governmental/Hospital Complex. It consists of the adaptive re-use and renovation of ten (10) high rise structures, interior and exterior historic renovation of significant Art Deco and WP Project artifacts, including two theaters, meeting rooms, and lobby space, and new construction of a multi level garage, health spa, pool, museum, and various types of amenity space. Completion of this project, which is the largest historic restoration project in the nation, is expected to create approximately 1,200 market rate residential units. This project represents a significant private investment that is outside of the City's downtown waterfront financial center. Shuttle and full concierge services are provide to various mass transit choices throughout the city.

**Grove Plaza.** As recently as 2000, the Grove Plaza area was considered to be too far from the waterfront to be desirable for high end market rate units. Today, Grove Plaza is considered the heart of downtown. The newly renovated and re-designed Grove Street PATH Station Plaza has served as a festival site and farmers market adding to the vitality of the shopping destination. 2 new 60-story residential towers, 70 and 90 Columbus, connected by the Marriot Hotel in a 150 foot base. This project also provides a newly constructed entrance to the Grove Street Path. New residential construction is moving west along Newark Avenue, including 8 new restaurants along a pedestrian walkway has been completed.

**Martin Luther King Drive.** The redevelopment of Martin Luther King Drive began as a grassroots community based initiative with far-reaching support. Since the adoption of the MLK Drive Redevelopment Plan by the City Council in December 1993, the development of the MLK HUB Shopping Plaza has been accomplished.

A 55,000 square foot supermarket and ancillary stores are in place. The HUB development is now under new ownership. Through a partnership of the Jersey City Redevelopment Agency, Universal Companies of Philadelphia, and Brandywine Corp., MLK Drive will be receiving approximately 205 units of work force housing to be built on City land in and around the HUB. Goldman-Sachs has sponsored a 20 unit housing development just north of the HUB Plaza and light rail station, which has been completed and sold as affordable condominiums.

The Fred W. Martin Apartments offer 39 affordable units in a 4-story building with 12,000 square feet of retail space along the Drive. Many other mixed-use and residential projects are underway along the Drive.

In 2015, The Jersey City Employment and Training Program (JCETP) relocated to the HUB, with Speaker of the House of Representatives Nancy Pelosi, New Jersey Governor Chris Christie, Senator Robert Menendez, NAACP President Cornell Brooks, Congressman Donald Payne Jr., Congressman Albio Sires, and former New Jersey Governors Brendan Byrne and Thomas Keane all attending the ribbon cutting ceremony. JCETP includes the prisoner re-entry program that provides addiction treatment, housing, and employment services as well as standard employment programs for youth, seniors, veterans, and welfare recipients. Former Governor James McGreevey is the director of the JCETP.

In 2017, the City completed the City Hall Annex, a 45,000 square foot building that houses the City's Health, Planning, Zoning, Tenant Landlord relations, and Economic Development. This was a \$20 million investment into an area that the City hopes to bring more economic development and success into.

**Monticello Avenue.** The Monticello Redevelopment Plan covers Monticello Avenue between Communipaw Avenue and Montgomery Street. It encompasses 19 blocks geographically located at the center of Jersey City. The goal is to establish a historically preserved and revitalized neighborhood - a shopping district with a mix of retail, restaurant and service businesses, as well as arts-related venues and activities that reflect the diversity and strong sense of community that prevail in the area. The 12 unit "Rock Garden Plaza" and the 6 unit "120-122 Monticello Avenue" with approximately 7,000 square feet of childcare space on the ground floor, have been completed.

**Berry Lane Park.** Berry Lane Park is a 17.5 acre park was recently completed on a former brownfield site in the Communipaw-Lafayette Section of Jersey City, New Jersey. Construction of the park began in 2012 and opened in the summer of 2016. The park is located between Garfield Avenue and Woodward Street near the Garfield Avenue Hudson Bergen Light Rail station. Directly south of Berry Lane Park is Canal Crossing, an adjacent brownfield site slated for a future residential development.

Berry Lane Park is the largest municipal park in Jersey City. The site includes two basketball courts, two tennis courts, a baseball field, a soccer field, a playground, a rain garden, 600 new trees, and a splash pad water park. New park features coexist with older existing structures that will be preserved or modified: for example, the large concrete silos from a former rail yard will be renovated to contain water features.

**Holland Tunnel and Jersey Avenue Redevelopment Area.** The expanse of land bounded by the entry/exit of the Holland Tunnel, the base of the Palisade Cliffs and neighboring the City of Hoboken, had remained unnoticed for many years. Its newly discovered attractiveness has accelerated an effort to re-connect existing streets, create more building lots and street frontages. There are current NJ Transit approvals for the creation of a new HBLRT Station at Jersey Avenue and Eighteenth Street. Residential re-development of the 10<sup>th</sup> Street corridor is almost complete; with the latest addition of the 58 condominium unit Schroeder Loft project adding to the LeFrak-developed apartments that presently line the corridor. In November 2007, The Home Depot opened a 105,121 square foot multi-level store, which employs 177 people and generating \$50 million in annual sales. Other recently completed residential additions include The Cliffs, 700 Grove Street, Cast Iron Lofts, and Zephyr Lofts.

Proposed plans include the Hoboken Redevelopment Plan area and the New York Avenue Redevelopment Plan area. The 7 acre Van Leer Chocolate Factory site, already under construction with a 2019 completion date, is slated to have up to 90-percent energy savings compared to traditional buildings through the use of geothermal and solar energy, as well as other green technologies and has been recognized in the 11th annual Governor's Environmental Excellence Awards in December 2010.

**Majestic Theater and the Majestic II Projects.** The adaptive re-use of the historic Majestic Theater across from City Hall including the three adjacent historic revival mixed use properties that were vacant and dilapidated, and development of a new adjoining 45 unit residential building. All of the constructed residential units have been sold or rented, and all of the highly desirable commercial spaces have been filled. Majestic II, which is a new mixed use classic mid-rise building with ground floor retail, will complete the third corner of the Montgomery Street & Grove Street intersection, connecting the eclectic buildings of the Van Vorst Historic District to the new City Hall neighborhood redevelopment. Across the street from the Majestic Projects and City Hall is an additional 99 unit 7 story building with ground floor retail space, which opened in early 2016.

**New Jersey City Medical Center and Grand Jersey Redevelopment Plan Area.** The Jersey City Medical Center opened its 325 bed medical facility at Grand and Jersey Avenues in 2004. This \$180 million facility was financed by the FHA. Liberty Health has just completed a 5-story Medical Arts Building adjacent to the Medical Center. There are also plans to triple the capacity of the Emergency Department.

The Grand Jersey Redevelopment Plan was amended at the end of 2017 to allow for a multi-phased residential and retail project that would create 2,000 new units and 50,000 square feet of new retail space. The plans require the clean-up of the Mill Creek Outfall through the construction of a 5 million gallon storm tank to be built with a new public city park on top. For decades the areas surrounding this site have been revitalized while these tracts remained barren. This will provide not only an opportunity for redevelopment, but also for one of the State's largest combined sewer outfall remediation and resiliency project.

**APPENDIX B**

**CITY OF JERSEY CITY,  
IN THE COUNTY OF HUDSON, STATE OF NEW JERSEY  
INDEPENDENT AUDITORS' REPORT AND AUDITED FINANCIAL STATEMENTS**



CITY OF JERSEY CITY  
NEW JERSEY

REPORT OF AUDIT

FOR THE YEARS ENDED  
DECEMBER 31, 2017 AND 2016

DRAFT



**DONOHUE, GIRONDA,  
DORIA & TOMKINS, LLC**

CERTIFIED PUBLIC ACCOUNTANTS  
REGISTERED MUNICIPAL ACCOUNTANTS

CITY OF JERSEY CITY  
 AUDIT OF FINANCIAL STATEMENTS  
 TABLE OF CONTENTS  
DECEMBER 31, 2017

	<u>EXHIBIT</u>	<u>PAGE</u>
Independent Auditor's Report .....		1
Current Fund		
Comparative Balance Sheet - Regulatory Basis .....	A	5
Comparative Statement of Operations and		
Changes in Fund Balance - Regulatory Basis .....	A-1	7
Statement of Revenues - Regulatory Basis .....	A-2	9
Analysis of Budget Revenues .....	A-2a	13
Analysis of Non-Budget Revenues .....	A-2b	14
Statement of Appropriations - Regulatory Basis .....	A-3	16
Trust Funds		
Comparative Balance Sheet - Regulatory Basis .....	B	23
General Capital Fund		
Comparative Balance Sheet - Regulatory Basis .....	C	25
Comparative Statement of Changes in Fund Balance - Regulatory Basis .....	C-1	26
General Fixed Assets		
Comparative Balance Sheet - Regulatory Basis .....	D	27
Notes to Financial Statements .....		28

DRAFT

# DONOHUE, GIRONDA, DORIA & TOMKINS, LLC

Certified Public Accountants

Robert A. Gironda, CPA  
Robert G. Doria, CPA (N.J. & N.Y.)  
Frederick J. Tomkins, CPA, RMA  
Matthew A. Donohue, CPA

310 Broadway  
Bayonne, NJ 07002  
(201) 437-9000  
Fax: (201) 437-1432  
E-Mail: [dgd@dgdcpas.com](mailto:dgd@dgdcpas.com)

Linda P. Kish, CPA, RMA  
Mark W. Bednarz, CPA, RMA  
Jason R. Gironda, CPA

## INDEPENDENT AUDITOR'S REPORT

The Honorable Mayor and Members  
of the City Council  
City of Jersey City, New Jersey

### **Report on the Financial Statements**

We have audited the accompanying financial statements – regulatory basis of the City of Jersey City, New Jersey (the “City”), which comprise the comparative balance sheet – regulatory basis, of each fund and General Fixed Assets as of December 31, 2017 and 2016, and the related comparative statement of operations and changes in fund balance – regulatory basis, statement of revenues – regulatory basis and statement of appropriations – regulatory basis, of the Current Fund, and the related statement of changes in Fund Balance – regulatory basis, of the General Capital Fund, for the years then ended, and the related notes to the financial statements.

### ***Management's Responsibility for the Financial Statements***

Management is responsible for the preparation and fair presentation of these financial statements in accordance with the financial reporting provisions of the Division of Local Government Services, Department of Community Affairs, State of New Jersey (the “Division”). Management is also responsible for the design, implementation, and maintenance of internal control relevant to the preparation and fair presentation of financial statements that are free from material misstatement, whether due to fraud or error.

### ***Auditor's Responsibility***

Our responsibility is to express opinions on these financial statements based on our audit. We conducted our audit in accordance with auditing standards generally accepted in the United States of America, audit requirements prescribed by the Division and the standards applicable to the financial audits contained in *Government Auditing Standards* issued by the Comptroller General of the United States. Those standards require that we plan and perform the audit to obtain reasonable assurance about whether the financial statements are free of material misstatement.

An audit involves performing procedures to obtain audit evidence about the amounts and disclosures in the financial statements. The procedures selected depend on the auditor's judgment, including the assessment of the risks of material misstatement of the financial statements, whether due to fraud or error. In making those risk assessments, the auditor considers internal control relevant to the City's preparation and fair presentation of the financial statements in order to design audit procedures that are appropriate in the circumstances, but not for the purpose of expressing an opinion on the effectiveness of the City's internal control. Accordingly, we express no such opinion. An audit also includes evaluating the appropriateness of accounting policies used and the reasonableness of significant accounting estimates made by management, as well as evaluating the overall presentation of the financial statements.

We believe that the audit evidence we have obtained is sufficient and appropriate to provide a basis for our audit opinions.

***Basis for Adverse Opinion on U.S. Generally Accepted Accounting Principles***

As described in Note A, the financial statements are prepared by the City on the basis of the financial reporting provisions of the Division, which is a basis of accounting other than accounting principles generally accepted in the United States of America, to meet the requirements of the Division.

The effects on the financial statements of the variances between the regulatory basis of accounting described in Note A and accounting principles generally accepted in the United States of America, although not reasonably determinable, are presumed to be material.

***Adverse Opinion on U.S. Generally Accepted Accounting Principles***

In our opinion, because of the significance of the matter discussed in the "Basis for Adverse Opinion on U.S. Generally Accepted Accounting Principles" paragraph, the financial statements referred to above do not present fairly, in accordance with accounting principles generally accepted in the United States of America, the financial position of the City as of December 31, 2017 and 2016, and the changes in its financial position for the years then ended.

***Unmodified Opinion on Regulatory Basis Accounting***

In our opinion, the financial statements referred to above present fairly, in all material respects, the comparative financial position – regulatory basis, of each fund and General Fixed Assets of the City as of December 31, 2017 and 2016, the Current Fund's respective operations and changes in fund balance – regulatory basis, revenues – regulatory basis and appropriations – regulatory basis, the General Capital Fund's changes in fund balance – regulatory basis, for the years then ended, in accordance with the financial reporting provisions of the Division as described in Note A.

## *Other Matters*

### *Management Discussion and Analysis*

Management has omitted the management discussion and analysis that accounting principles generally accepted in the United States of America require to be presented to supplement the basic financial statements. Such missing information, although not a part of the basic financial statements, is required by the Governmental Accounting Standards Board who considers it to be an essential part of financial reporting for placing the basic financial statements in an appropriate operational, economic, or historical context, but is not required by the financial reporting provisions of the Division. Our opinion on the basic financial statements is not affected by the missing information.

### *Other Information*

Our audit was conducted for the purpose of forming opinions on the financial statements that collectively comprise the City's basic financial statements. The statistical section and schedule of expenditures of other financial assistance are presented for purposes of additional analysis and are not a required part of the basic financial statements. The accompanying supplementary data section, general comments and comments and recommendations are presented for purposes of additional analysis as required by the Division. The schedule of expenditures of federal awards and the schedule of expenditures of state financial assistance are presented for purposes of additional analysis as required by the Title 2 U.S. Code of Federal Regulations (CFR) Part 200, *Uniform Administrative Requirements, Cost Principles, and Audit Requirements for Federal Awards* and N.J. Office of Management and Budget Circular 15-08, *Single Audit Policy for Recipients of Federal Grants, State Grants and State Aid*, respectively. The supplementary data section, general comments, comments and recommendations, schedule of expenditures of federal awards and schedule of expenditures of state financial assistance are also presented for purposes of additional analysis and are not required parts of the basic financial statements.

The supplementary data section, general comments, comments and recommendations, schedule of expenditures of federal awards and the schedule of expenditures of state financial assistance are the responsibility of management and were derived from and relate directly to the underlying accounting and other records used to prepare the basic financial statements. Such information has been subjected to the auditing procedures applied in the audit of the basic financial statements and certain additional procedures, including comparing and reconciling such information directly to the underlying accounting and other records used to prepare the basic financial statements or to the basic financial statements themselves, and other additional procedures in accordance with auditing standards generally accepted in the United States of America. In our opinion, the supplementary data section, general comments, comments and recommendations, schedule of expenditures of federal awards and the schedule of expenditures of state financial assistance are fairly stated, in all material respects, in relation to the basic financial statements as a whole.

The statistical section and schedule of expenditures of other financial assistance have not been subjected to the auditing procedures as applied in the audit of the basic financial statements and, accordingly, we do not express an opinion or provide any assurance on them.

**Other Reporting Required by *Government Auditing Standards***

In accordance with *Government Auditing Standards*, we have also issued our report dated October 26, 2018, on our consideration of the City's internal control over financial reporting and our tests of its compliance with certain provisions of laws, regulations, contracts and grant agreements and other matters. The purpose of that report is to describe the scope of our testing of internal control over financial reporting and compliance and the results of that testing, and not to provide an opinion on the internal control over financial reporting or on compliance. That report is an integral part of an audit performed in accordance with *Government Auditing Standards* in considering the City's internal control over financial reporting and compliance.

D R A F T  
DONOHUE, GIRONDA,  
DORIA & TOMKINS, LLC  
*Certified Public Accountants*

D R A F T  
MARK W. BEDNARZ  
RMA No. 547

Bayonne, New Jersey  
October 26, 2018

D R A F T

CITY OF JERSEY CITY  
CURRENT FUND  
AS OF DECEMBER 31, 2017 AND 2016

COMPARATIVE BALANCE SHEET - REGULATORY BASIS

		<u>2017</u>	<u>2016</u>
<u>Assets</u>			
Current Fund:			
Cash and Cash Equivalents	A-4	\$ 113,968,803	\$ 114,656,230
Petty Cash	A-5	200	-
Change Fund	A-6	<u>1,710</u>	<u>1,710</u>
		<u>113,970,713</u>	<u>114,657,940</u>
Intergovernmental Receivables:			
Due from Jersey City Municipal Utilities Authority - Overpayment of Tax Sale Receipts	A-12	1,604,940	-
Due from State of NJ - Sr. Citizens and Veterans Deductions	A-8	20,300	23,048
Prepaid Debt Service - Qualified Bonds	A-15	<u>11,725,890</u>	<u>12,562,462</u>
		<u>13,351,130</u>	<u>12,585,510</u>
Receivables and Other Assets with Full Reserves:			
Delinquent Property Taxes Receivable	A-7	10,252,653	4,265,328
Tax Title Liens Receivable	A-9	37,154	37,154
Property Acquired for Taxes at Assessed Valuation	A-10	1,455,500	1,455,500
Revenue Accounts Receivable	A-11	1,360,335	1,115,339
Lot Cleaning Charges Receivable	A-13	2,937	-
Sales Contracts Receivable - Property Acquired for Taxes	A-14	285,550	285,550
Interfunds Receivable	A-17	<u>11,848,594</u>	<u>44,519</u>
		<u>25,242,723</u>	<u>7,203,390</u>
Deferred Charges Special Emergency Authorizations	A-16	<u>13,700,000</u>	<u>27,371,474</u>
Total Current Fund Assets		<u>166,264,566</u>	<u>161,818,314</u>
Federal and State Grant Fund:			
Cash and Cash Equivalents	A-4	10,738,056	10,000,324
Federal and State Grants Receivable	A-36	31,633,023	32,617,186
Interfunds Receivable	A-37	<u>-</u>	<u>147,426</u>
Total Federal and State Grant Fund Assets		<u>42,371,079</u>	<u>42,764,936</u>
Total Assets		<u>\$ 208,635,645</u>	<u>\$ 204,583,250</u>

CITY OF JERSEY CITY  
CURRENT FUND  
AS OF DECEMBER 31, 2017 AND 2016

COMPARATIVE BALANCE SHEET - REGULATORY BASIS

		<u>2017</u>	<u>2016</u>
<u>Liabilities and Reserves</u>			
Current Fund:			
Appropriation Reserves	A-3, A-18	\$ 19,058,629	\$ 18,800,526
Reserve for Encumbrances	A-19	28,067,794	19,449,110
Contracts Payable	A-20	701,777	1,803,622
Prepaid Taxes	A-21	14,023,865	2,953,483
Tax Overpayments	A-22	2,176,043	2,377,608
Interfunds Payable	A-17	414,665	150,013
Prepaid Revenues	A-23	1,445,095	377,938
County Taxes Payable	A-25	1,490,205	1,070,539
PILOT Fees Due to County	A-26	903,246	654,210
Due to Special Improvement Districts	A-27	137,326	208,752
Due to State of New Jersey:			
Marriage Licenses	A-28	8,830	25,330
Burial Permits	A-28	635	570
Reserve for Deposits on Sale of Property			
Acquired for Taxes	A-29	20,303	20,303
Reserves - Other	A-30	1,348,305	2,148,670
Emergency Notes Payable	A-31	13,700,000	20,597,496
Reserve for Superstorm Sandy Expenditures	A-32	-	44,211
Other Payables	A-33	12,364	12,364
Reserve for Revaluation	A-34	604,642	5,000,000
Undistributed Revenues	A-35	568,709	-
		<u>84,682,433</u>	<u>75,694,745</u>
Reserve for Receivables and Other Assets		25,242,723	7,203,390
Fund Balance	A-1	<u>56,339,410</u>	<u>78,920,179</u>
Total Current Fund Liabilities, Reserves and Fund Balance		<u>166,264,566</u>	<u>161,818,314</u>
Federal and State Grant Fund:			
Reserve for Encumbrances	A-38	7,041,726	12,426,499
Reserve for Other	A-40	1,443,991	1,173,397
Reserve for State and Federal Grants:			
Appropriated	A-39	29,683,949	29,061,223
Unappropriated	A-41	3,946,275	-
Interfunds Payable	A-37	255,138	103,817
		<u>42,371,079</u>	<u>42,764,936</u>
Total Federal and State Grant Fund Liabilities and Reserves		<u>42,371,079</u>	<u>42,764,936</u>
Total Liabilities, Reserves and Fund Balance		<u>\$ 208,635,645</u>	<u>\$ 204,583,250</u>

See Accompanying Notes to Financial Statements



**CITY OF JERSEY CITY  
CURRENT FUND  
FOR THE YEARS ENDED DECEMBER 31, 2017 AND 2016**

**COMPARATIVE STATEMENT OF OPERATIONS AND CHANGES IN FUND BALANCE -  
REGULATORY BASIS**

		2017	2016
<u>Revenue and Other Income Realized:</u>			
Fund Balance Utilized	A-2a	\$ 39,960,250	\$ 20,745,651
Miscellaneous Revenue Anticipated	A-2a	332,288,181	338,805,935
Receipts from Delinquent Taxes	A-2a	2,262,775	559,368
Receipts from Current Taxes	A-2a	492,469,451	472,570,361
Non-Budget Revenues	A-2b	5,882,618	2,760,372
<u>Other Credits to Income:</u>			
Unexpended Appropriation Reserves	A-18	18,989,297	13,999,157
Grant Costs Charged to Current Fund in Prior Years	A-17	1,433,559	-
Cancellation of Contracts Payable	A-20	1,231,030	10,831
Revenue Accounts Receivable	A-11	1,115,339	1,917,585
Premium on Special Emergency Notes	A-4	44,550	47,628
Prior Year Interfunds Returned	A-17	44,519	311,385
JCMUA Franchise Extension Fees		-	14,000,000
Cancellation of Contracts Encumbered		-	831,780
Cancelled Checks		-	549,786
Reimbursement for Prior Years Grant Adjustment		-	278,200
Other Credits and Adjustments		-	151,655
		895,721,569	867,539,694
<u>Expenditures</u>			
<u>Budgetary and Emergency Appropriations:</u>			
<u>Appropriations within "CAPS"</u>			
Operations			
Salaries and Wages		239,314,446	228,896,529
Other Expenses		180,208,924	165,849,919
Deferred Charges and Statutory Expenditures		64,622,370	56,519,425
<u>Appropriations Excluded from "CAPS"</u>			
Operations			
Other Expenses		36,795,572	44,344,064
Capital Improvements		300,000	1,200,000
Debt Service		67,001,905	66,663,158
Deferred Charges		6,932,496	8,427,496
Judgments			
Type 1 School District Debt		7,105,819	13,361,440
Reserve for Uncollected Taxes		4,880,770	3,847,492
	A-3	607,162,302	589,109,523

See Accompanying Notes to Financial Statements

**CITY OF JERSEY CITY  
CURRENT FUND  
FOR THE YEARS ENDED DECEMBER 31, 2017 AND 2016**

**COMPARATIVE STATEMENT OF OPERATIONS AND CHANGES IN FUND BALANCE -  
REGULATORY BASIS**

		2017	2016
<u>Expenditures (continued)</u>			
Local District School Tax	A-24	\$ 115,548,404	\$ 113,282,750
County Taxes	A-25	130,445,002	118,795,203
Special District Taxes	A-27	4,481,331	-
Municipal Open Space Tax	A-17	623,000	-
Interfunds Advanced Originating in Current Year	A-17	11,848,594	44,519
Tax Appeals	A-21	6,729,583	1,206,040
Refund of Prior Year Revenues	A-4	143,537	26,100
Revenue Accounts Receivable	A-11	1,360,335	1,115,339
		<u>878,342,088</u>	<u>823,579,474</u>
Excess in Revenue		17,379,481	43,960,220
Adjustments to Income before Fund Balance:			
Expenditures Included Above Which are by Statute			
Deferred Charges to Budget of Succeeding Year			
Special Emergency Appropriations:			
Revaluation		-	5,000,000
Statutory Excess to Fund Balance		17,379,481	48,960,220
Fund Balance, Beginning of Year	A	<u>78,920,179</u>	<u>50,705,610</u>
		96,299,660	99,665,830
Decreased by:			
Utilized as Anticipated Revenue	A-2a	39,960,250	20,745,651
Fund Balance, December 31	A	<u>\$ 56,339,410</u>	<u>\$ 78,920,179</u>

CITY OF JERSEY CITY  
CURRENT FUND  
FOR THE YEAR ENDED DECEMBER 31, 2017

STATEMENT OF REVENUES - REGULATORY BASIS

	Anticipated		Realized	Excess or (Deficit)
	Budget as Adopted	N.J.S.A 40A:4-87		
<b>SURPLUS:</b>				
Surplus Anticipated	\$ 39,954,250	\$ -	\$ 39,954,250	\$ -
Surplus Anticipated with Prior Written Consent of Director	6,000	-	6,000	-
Total Surplus	39,960,250	-	39,960,250	-
<b>MISCELLANEOUS REVENUES:</b>				
<b>LOCAL REVENUES</b>				
Licenses:				
Alcoholic Beverages	630,547	-	832,354	201,807
Other Licenses:				
Marriage Licenses	5,751	-	6,755	1,004
Cable TV Franchise Fees	2,476,917	-	2,485,392	8,475
Hackensack Meadowlands Adjustment	605,487	-	1,072,851	467,364
Local School Aid	1,953,117	-	1,953,117	-
Advertising Ordinance Fees	304,747	-	334,618	29,871
Search Fees	255	-	174	(81)
Lot Cleaning Charges	80,889	-	12,056	(68,833)
Tax Collector's Fees	30,352	-	35,483	5,131
Hotel Occupancy Tax	7,687,845	-	8,375,237	687,392
Landlord Registration	271,911	-	317,183	45,272
Fees and Permits:				
Interest and Costs on Taxes	1,325,488	-	767,013	(558,475)
Interest on Investments and Deposits	389,004	-	1,015,478	626,474
Assessor's Application Fees	26,620	-	3,537	(23,083)
Sewer and Street Opening Permits	245,809	-	232,258	(13,551)
Swimming Pool Fees	152,220	-	145,471	(6,749)
Skating Rink Fees	55,007	-	123,192	68,185
Laundry Licenses	53,250	-	91,100	37,850
Vending Machine Licenses	46,337	-	23,665	(22,672)
Food Establishment Licenses	672,934	-	794,175	121,241
Hotel/Motel Licenses	82,335	-	79,840	(2,495)
Dine and Dance Permits	27,000	-	28,000	1,000
Police Reports ID Bureau Fees	134,001	-	135,063	1,062
Taxicab/Omnibus Licenses	125,840	-	112,415	(13,425)
Elevator Inspection Fees	592,614	-	600,249	7,635
Site Plan Review Fees	910,546	-	1,010,013	99,467
Bingo and Raffle Licenses	15,820	-	11,500	(4,320)
Mechanical Amusement Devices	18,000	-	9,625	(8,375)
Parking Lot Licenses	264,341	-	579,227	314,886
Used Motor Vehicle Dealer Licenses	75,817	-	30,000	(45,817)
Parking Lot Tax	8,021,883	-	8,092,843	70,960
Parking Enforcement:				
Lease Fees	373,773	-	327,504	(46,269)
Meter Fees	1,332,186	-	1,454,765	122,579
Miscellaneous Fees	1,815,364	-	1,763,676	(51,688)

CITY OF JERSEY CITY  
CURRENT FUND  
FOR THE YEAR ENDED DECEMBER 31, 2017

STATEMENT OF REVENUES - REGULATORY BASIS

	Anticipated		Realized	Excess or (Deficit)
	Budget as Adopted	N.J.S.A 40A:4-87		
<u>MISCELLANEOUS REVENUES: (continued)</u>				
LOCAL REVENUES (continued)				
Municipal Court Fines and Costs	\$ 13,592,007	\$ -	\$ 16,459,799	\$ 2,867,792
Passaic Valley Sewerage Comm. Incentive	168,250	-	168,250	-
Interstate Waste	546,868	-	454,588	(92,280)
Dumpster Fee	66,745	-	91,187	24,442
Certified Copies of Marriage Licenses	39,625	-	41,285	1,660
Zoning Permits and Ordinance Copies	260,065	-	264,858	4,793
Settlements	650,000	-	-	(650,000)
Death Certificates	74,925	-	66,745	(8,180)
Vacant Property Registration	223,865	-	138,605	(85,260)
	<u>46,426,357</u>	<u>-</u>	<u>50,541,146</u>	<u>4,114,789</u>
STATE AID WITHOUT OFFSETTING APPROPRIATIONS				
Consolidated Municipal Property Tax Relief	10,408,207	-	10,408,207	-
Energy Receipts Tax	53,436,478	-	53,436,478	-
GSPT In Lieu of Tax Payment	15,837	-	15,837	-
Building Aid Allowances for School Aid	3,189,788	-	3,189,788	-
	<u>67,050,310</u>	<u>-</u>	<u>67,050,310</u>	<u>-</u>
DEDICATED UNIFORM CONSTRUCTION CODE FEES OFFSET WITH APPROPRIATIONS				
Uniform Construction Code Fees	7,889,787	-	6,543,764	\$ (1,346,023)
PUBLIC AND PRIVATE REVENUES OFFSET WITH APPROPRIATIONS				
Distracted Driving Grant	5,500	-	5,500	-
Health Corner Store Initiative	5,000	-	5,000	-
Highlands TDR Feasibility	40,000	-	40,000	-
Innovation Team Grant	676,394	-	676,394	-
Recreational Opportunities for Individuals with Disabilities (ROID Grant)	20,000	-	20,000	-
Municipal Drug Alliance	-	213,903	213,903	-
NJDOT - Journal Square Pedestrian Safety	-	220,000	220,000	-
Hudson Regional Health Commission	-	-	-	-
OLPHW -STD	-	47,791	47,791	-
Drunk Driver Enforcement Fund	14,625	-	14,625	-
Urban Area Security Initiative (UASI)	-	1,710,000	1,710,000	-
Recycling Tonnage Grant	298,152	-	298,152	-
Community Service Block Grant (CSBG)	529,955	395,326	925,281	-
AARP - Tree Planting	-	3,000	3,000	-
NJDOH - Woman, Infants & Children (WIC)	-	1,802,583	1,802,583	-
Summer Food Program	626,915	-	626,915	-
Senior Nutrition	1,225,438	-	1,225,438	-
Food Insecurity Nutrition	8,425	-	8,425	-
YMCA State Alliance Healthy NJ Contest	-	500	500	-
Tarentino Community Policing Grant	-	10,000	10,000	-

See Accompanying Notes to Financial Statements

CITY OF JERSEY CITY  
CURRENT FUND  
FOR THE YEAR ENDED DECEMBER 31, 2017

STATEMENT OF REVENUES - REGULATORY BASIS

	Anticipated		Realized	Excess or (Deficit)
	Budget as Adopted	N.J.S.A 40A:4-87		
<u>MISCELLANEOUS REVENUES: (continued)</u>				
PUBLIC AND PRIVATE REVENUES OFFSET WITH APPROPRIATIONS (continued)				
Healthy Community	\$ 1,033	\$ -	\$ 1,033	\$ -
HUD - CDBG	-	5,034,144	5,034,144	-
HUD - HOME	-	1,354,363	1,354,363	-
HUD - HOPWA	-	2,420,486	2,420,486	-
HUD - Emergency Solutions	-	457,848	457,848	-
Sub-Regional Transportation	-	99,328	99,328	-
JTPA	-	2,965,248	2,965,248	-
Port Security Fire	225,000	-	225,000	-
Port Security Police	163,431	-	163,431	-
Cities of Service - Vista	25,000	-	25,000	-
Green Acres - Berry Lane	1,100,000	-	1,100,000	-
Body Worn Cameras Program	-	100,000	100,000	-
Body Armor Replacement	-	71,364	71,364	-
STD Education	122,183	-	122,183	-
STD Screening - High Risk	-	45,000	45,000	-
Municipal Aid - Various Streets	1,038,402	-	1,038,402	-
Local Safety Program - MLK Drive	-	399,714	399,714	-
Local Safety Program - Communipaw Ave.	-	736,383	736,383	-
Clean Communities Program	387,918	-	387,918	-
Summer Works Initiative	190,000	-	190,000	-
Comprehensive Traffic Safety	26,700	-	26,700	-
Make-A-Splash	-	3,380	3,380	-
CLPP (Porsche)	-	194,025	194,025	-
	<u>6,730,071</u>	<u>18,284,386</u>	<u>25,014,457</u>	<u>-</u>
OTHER SPECIAL ITEMS				
Payments in Lieu of Taxes	138,018,625	-	141,808,933	3,790,308
Sale of Municipal Property - Land Sales	10,000,000	-	10,102,827	102,827
United Water Reimbursement - Operations	325,444	-	346,105	20,661
MUA Franchise Concession Payment	21,000,000	-	21,000,000	-
MUA Water Debt Service Payment	5,189,956	-	5,189,955	(1)
Uniform Fire Safety Act	250,000	-	250,000	-
Build America Bonds Federal Credit	1,772,239	-	1,768,300	(3,939)
Recovery Zone Bonds Federal Credit	196,715	-	196,503	(212)
Stop the Drop	140,000	-	140,000	-
Reserve Summer Youth Program	1,000,000	-	1,000,000	-
Reserve Youth Court Program	125,000	-	125,000	-
City Government Summer Seasonal Program	75,000	-	75,000	-
MLK Community Center	206,405	-	206,405	-
Reserve Parking Authority	229,476	-	229,476	-
MUA Stormwater Catch Basins	700,000	-	700,000	-
	<u>179,228,860</u>	<u>-</u>	<u>183,138,504</u>	<u>3,909,644</u>
Total Miscellaneous Revenues	<u>307,325,385</u>	<u>18,284,386</u>	<u>332,288,181</u>	<u>6,678,410</u>

See Accompanying Notes to Financial Statements

CITY OF JERSEY CITY  
CURRENT FUND  
FOR THE YEAR ENDED DECEMBER 31, 2017

STATEMENT OF REVENUES - REGULATORY BASIS

	Anticipated		Realized	Excess or (Deficit)
	Budget as Adopted	N.J.S.A 40A:4-87		
<u>RECEIPTS FROM DELINQUENT TAXES:</u>	\$ 812,309	\$ -	\$ 2,262,775	\$ 1,450,466
Subtotal - General Revenues	348,097,944	18,284,386	374,511,206	8,128,876
<u>AMOUNT TO BE RAISED BY TAXES FOR SUPPORT OF MUNICIPAL BUDGET:</u>				
Local Tax Including Reserve for Uncollected Taxes	228,298,260	-	228,890,002	591,742
Addition to Local District School Tax	3,916,031	-	3,916,031	-
Minimum Library Tax	8,565,681	-	8,565,681	-
Total Amount to be Raised by Taxes	240,779,972	-	241,371,714	591,742
Total Budget Revenues	588,877,916	18,284,386	615,882,920	8,720,618
Non-Budget Revenues	-	-	5,882,618	5,882,618
Total General Revenues	<u>\$ 588,877,916</u>	<u>\$ 18,284,386</u>	<u>\$ 621,765,538</u>	<u>\$ 14,603,236</u>
Ref.	A-3	A-3		
Budgeted		A-2a	\$ 615,882,920	
Non-budgeted		A-2b	5,882,618	
			<u>\$ 621,765,538</u>	

DRAFT

**CITY OF JERSEY CITY  
CURRENT FUND  
FOR THE YEAR ENDED DECEMBER 31, 2017**

**STATEMENT OF REVENUES - REGULATORY BASIS  
ANALYSIS OF BUDGET REVENUES**

Allocation of Current Tax Collections:

Collected in Current Year, including Homestead Benefit	A-4	\$ 486,389,391	
Less: Overpayments Payable	A-22	<u>2,176,043</u>	
Current Year Taxes Collected in Current Year	A-7	484,213,348	
Current Year Taxes Collected in Prior Year	A-7, A-21	2,953,483	
State Share of Sr. Citizens & Veterans Deductions	A-7, A-8	<u>421,850</u>	
Current Taxes Realized in Cash			\$ 487,588,681
Add: Appropriation for "Reserve for Uncollected Taxes"	A-3		<u>4,880,770</u>
	A-1		492,469,451
Allocated to:			
School Taxes	A-24	115,548,404	
County Taxes	A-25	130,445,002	
Special District Taxes	A-27	4,481,331	
Municipal Open Space Tax	A-17	<u>623,000</u>	
Total Allocated to School and County Taxes			<u>251,097,737</u>
Amount for Support of Municipal Budget Appropriations	A-2		<u>\$ 241,371,714</u>
<u>Receipts from Delinquent Taxes:</u>			
Delinquent Taxes Collected	A-4, A-7		\$ 1,828,745
State Share of Prior Year Senior Citizen Deductions	A-7, A-8		250
Tax Title Liens Collected	A-9		258,837
Adjustment to Prior Year SID Reserves	A-27		<u>174,943</u>
Total Receipts from Delinquent Taxes	A-1, A-2		<u>\$ 2,262,775</u>
<u>Miscellaneous Revenues Anticipated:</u>			
Accrual per Revenue Accounts Receivable	A-11		\$ 240,223,414
State Aid Allocation Anticipated	A-15		67,050,310
State and Federal Grants	A-17		<u>25,014,457</u>
Total Miscellaneous Revenues Anticipated	A-1, A-2		<u>\$ 332,288,181</u>
<u>Fund Balance</u>	A-1, A-2		<u>\$ 39,960,250</u>
Total Realized Budget Revenues	A-2		<u>\$ 615,882,920</u>

See Accompanying Notes to Financial Statements

CITY OF JERSEY CITY  
 CURRENT FUND  
 FOR THE YEAR ENDED DECEMBER 31, 2017

STATEMENT OF REVENUES - REGULATORY BASIS  
 ANALYSIS OF NON-BUDGET REVENUES

Increased by Cash Received from:

Express Scripts Claim	\$ 1,319,031
Liberty Harbor North III	1,050,737
LHN Owner 33 Park	649,990
Protested Checks Collected	623,928
3 Jsq	259,254
Columbus Hotel UR	183,485
United Water (Suez)	178,515
Abatement Transfer Fee	163,251
Container Rentals - DPW	159,717
234 Suydam UR	137,155
Library Reimbursement	126,637
Other Recreation Fees	121,362
Unidentified Reconciling Items	92,674
FEMA Reimb: Severe Winter/Snow Storm 1/22/16	85,350
Chosen Condominiums	76,502
Police Department ABC	71,640
Horizon Refund	52,470
Used Motor Vehicle License	49,200
Laidlaw Properties UR	47,558
Filming Permits	41,033
Miscellaneous- City Clerk	34,825
Miscellaneous Health Inspections	33,700
Auto Repair Licenses	31,400
Childcare Cert. License	27,200
Shade Tree	21,708
Initial Lic. Insp/Rev Plan	16,350
HEDC-Sidewalk Cafe License	16,100
Trizechahn Newport Towers	16,049
Scrap Metals	15,324
Summit Urban Urban Renewal	12,684
Carnival Fee	10,900
102 York Street	10,761
Rental City Owned Property	9,928
Tax Lien Deposits	9,900
Devi Ma Newkirk UR	9,549
Citywide Festivals - DPW	9,168
Burglar Alarm System	9,060
MLK Drive Urban Renewal	9,038
Miscellaneous Other	8,540
Junk Shop Licenses	8,000

See Accompanying Notes to Financial Statements



CITY OF JERSEY CITY  
 CURRENT FUND  
 FOR THE YEAR ENDED DECEMBER 31, 2017

STATEMENT OF REVENUES - REGULATORY BASIS  
 ANALYSIS OF NON-BUDGET REVENUES

Increased by Cash Received from:		
Food Handlers Course	\$	7,805
Discovery Fees		7,485
Miscellaneous		7,041
Police Training Fees		6,946
Special Privileges		6,325
Exhibition Licenses		6,300
Special Beverage Permit		5,975
Bail Forfeiture		5,142
Mechanical Amusement Devices		3,825
Other Revenues		3,105
Retail Florist License		2,900
Loading Zones		2,100
372 Pacific		2,028
Tire Permits		1,950
Trade Licenses		1,544
Driveway Permits		835
Pigeon Keeping		700
Pet Shop Licenses		340
Spray Paint, Markers		225
Rental Of Polling Places		100
Pay Telephone Lic.		100
Reimburse Damaged Property		75
Search Fees		51
Recycling Recéptacles		48
	A-1; A-2; A-4	<u>\$ 5,882,618</u>

CITY OF JERSEY CITY  
CURRENT FUND  
FOR THE YEAR ENDED DECEMBER 31, 2017

STATEMENT OF APPROPRIATIONS - REGULATORY BASIS

	Appropriations		Paid or Charged	Expended		Unexpended Balance Canceled
	Adopted Budget	Budget After Modification		Encumbered	Reserved	
<b>(A) Operations - Within "CAPS"</b>						
<b>OFFICE OF THE MAYOR</b>						
Mayor's Office						
Salaries and Wages	\$ 1,141,499	\$ 1,141,499	\$ 1,051,411	\$ -	\$ 90,088	\$ -
Other Expenses	35,700	35,700	14,042	1,608	20,050	-
Resident Response Center						
Salaries and Wages	819,497	834,497	826,992	-	7,505	-
Other Expenses	133,773	133,773	24,389	32,254	77,130	-
Cultural Affairs						
Salaries and Wages	540,651	540,651	518,448	-	22,203	-
Other Expenses	146,500	146,500	127,601	14,976	3,923	-
<b>CITY CLERK AND MUNICIPAL COUNCIL</b>						
Office of the City Clerk						
Salaries and Wages	865,351	880,351	865,081	-	15,270	-
Other Expenses	96,530	96,530	76,503	7,162	12,865	-
General and Primary Election	100,000	100,000	96,874	-	3,126	-
Municipal Election	250,000	300,000	19,840	91,302	188,858	-
Municipal Council						
Salaries and Wages	589,485	599,485	597,321	-	2,164	-
Other Expenses	101,350	101,350	89,974	7,280	4,096	-
Annual Audit - Other Expenses	299,000	299,000	299,000	-	-	-
<b>HUMAN RESOURCES</b>						
Director's Office						
Salaries and Wages	191,715	199,715	194,539	-	5,176	-
Other Expenses	2,200	2,200	1,489	300	411	-
Workforce Management						
Salaries and Wages	688,625	688,625	664,352	-	24,273	-
Other Expenses	282,950	282,950	177,116	85,089	20,745	-
Health Benefits						
Salaries and Wages	172,993	172,993	167,488	-	5,505	-
Other Expenses	3,300	3,300	2,967	138	195	-
Pension						
Salaries and Wages	260,946	268,946	263,265	-	5,681	-
Other Expenses	5,500	5,500	3,213	256	2,031	-
Payroll						
Salaries and Wages	497,341	502,341	495,154	-	7,187	-
Other Expenses	6,800	6,800	2,357	1,509	2,934	-
<b>DEPARTMENT OF ADMINISTRATION</b>						
Administrator's Office						
Salaries and Wages	1,493,205	1,493,205	1,459,025	-	34,180	-
Other Expenses	56,400	56,400	19,230	20,410	16,760	-
Management and Budget						
Salaries and Wages	473,653	478,653	473,213	-	5,440	-
Other Expenses	215,090	215,090	157,609	23,311	34,170	-
Purchasing and Central Services						
Salaries and Wages	679,516	679,516	604,365	-	75,151	-
Other Expenses	75,315	75,315	51,192	23,017	1,106	-
Real Estate						
Salaries and Wages	134,423	134,423	116,634	-	17,789	-
Other Expenses	14,400	14,400	3,800	2,773	7,827	-
Communications						
Salaries and Wages	517,517	525,517	513,222	-	12,295	-
Other Expenses	16,600	16,600	685	8,963	6,952	-
Utility Management						
Salaries and Wages	325,444	380,444	355,052	-	25,392	-
Risk Management						
Salaries and Wages	159,991	174,991	168,400	-	6,591	-
Other Expenses	1,250	1,250	519	197	534	-
Information Technology						
Salaries and Wages	938,093	948,093	943,822	-	4,271	-
Other Expenses	1,175,400	1,175,400	671,976	173,107	330,317	-
Municipal Court						
Salaries and Wages	3,939,021	3,839,021	3,831,402	-	7,619	-
Other Expenses	178,700	178,700	104,023	31,494	43,183	-

CITY OF JERSEY CITY  
CURRENT FUND  
FOR THE YEAR ENDED DECEMBER 31, 2017

STATEMENT OF APPROPRIATIONS - REGULATORY BASIS

	Appropriations		Paid or Charged	Expended		Unexpended Balance Canceled
	Adopted Budget	Budget After Modification		Encumbered	Reserved	
<b>DEPARTMENT OF ADMINISTRATION (continued)</b>						
Public Defender						
Salaries and Wages	\$ 90,660	\$ 98,660	\$ 93,129	\$ -	\$ 5,531	\$ -
Other Expenses	301,000	301,000	133,850	45,898	121,252	-
Collections						
Salaries and Wages	783,099	783,099	739,854	-	43,245	-
Other Expenses	145,000	155,000	84,249	14,611	56,140	-
Architecture						
Salaries and Wages	768,096	768,096	670,898	-	97,198	-
Other Expenses	30,750	30,750	16,579	4,185	9,986	-
Engineering						
Salaries and Wages	1,939,632	1,839,632	1,644,961	-	194,671	-
Other Expenses	1,719,829	1,719,829	1,135,208	226,650	357,971	-
Accounts and Control						
Salaries and Wages	555,339	555,339	542,137	-	13,202	-
Other Expenses	11,290	11,290	8,536	344	2,410	-
Treasury and Debt Management						
Salaries and Wages	238,976	253,976	242,915	-	11,061	-
Other Expenses	5,220	5,220	3,887	840	493	-
<b>OFFICE OF THE TAX ASSESSOR</b>						
Tax Assessor						
Salaries and Wages	991,018	916,018	860,311	-	55,707	-
Other Expenses	277,820	277,820	217,083	36,510	24,227	-
<b>DEPARTMENT OF LAW</b>						
Law Department						
Salaries and Wages	3,265,021	3,265,021	3,205,190	-	59,831	-
Other Expenses	803,830	888,830	583,060	166,589	139,181	-
<b>DEPARTMENT OF PUBLIC WORKS</b>						
Director's Office						
Salaries and Wages	1,920,339	2,050,339	2,050,333	-	6	-
Other Expenses	20,376,000	20,376,000	16,597,635	3,526,865	251,500	-
Parks Maintenance						
Salaries and Wages	2,482,534	2,357,534	2,263,149	-	94,385	-
Other Expenses	728,100	728,100	480,586	58,479	189,035	-
Building and Street Maintenance						
Salaries and Wages	3,029,221	3,129,221	3,129,114	-	107	-
Other Expenses	2,383,500	2,633,500	2,295,609	251,053	86,838	-
Automotive Services						
Salaries and Wages	1,790,774	1,950,774	1,949,787	-	987	-
Other Expenses	4,855,500	5,155,500	4,338,328	711,248	105,924	-
Sanitation						
Salaries and Wages	4,616,905	4,926,905	4,905,068	-	21,837	-
Other Expenses	3,365,000	2,815,000	932,610	748,786	1,133,604	-
Neighborhood Improvement						
Salaries and Wages	1,352,100	1,352,100	1,259,763	-	92,337	-
Other Expenses	49,000	49,000	25,388	11,075	12,537	-
<b>DEPARTMENT OF RECREATION</b>						
Director's Office						
Salaries and Wages	4,016,311	4,016,311	3,752,091	-	264,220	-
Other Expenses	578,615	593,615	443,426	102,788	47,401	-
<b>DEPARTMENT OF HEALTH AND HUMAN SERVICES</b>						
Director's Office						
Salaries and Wages	800,495	805,495	786,980	-	18,515	-
Other Expenses	397,250	397,250	145,346	185,764	66,140	-
Health						
Salaries and Wages	1,074,280	1,412,280	1,373,360	-	38,920	-
Other Expenses	60,350	60,350	33,748	4,379	22,223	-
Disease Prevention						
Salaries and Wages	678,630	678,630	600,454	-	78,176	-
Other Expenses	81,955	81,955	44,395	21,562	15,998	-
Community Health						
Salaries and Wages	297,498	297,498	282,386	-	15,112	-
Other Expenses	23,500	23,500	13,289	3,504	6,707	-

CITY OF JERSEY CITY  
CURRENT FUND  
FOR THE YEAR ENDED DECEMBER 31, 2017

STATEMENT OF APPROPRIATIONS - REGULATORY BASIS

	Appropriations		Paid or Charged	Expended		Unexpended Balance Canceled
	Adopted Budget	Budget After Modification		Encumbered	Reserved	
<u>DEPARTMENT OF HEALTH AND HUMAN SERVICES (continued)</u>						
Senior Citizen Affairs						
Salaries and Wages	\$ 397,976	\$ 397,976	\$ 383,946	\$ -	\$ 14,030	\$ -
Other Expenses	65,900	65,900	46,158	10,476	9,266	-
Animal Care and Control						
Salaries and Wages	265,513	40,513	24,642	-	15,871	-
Other Expenses	479,286	879,286	441,540	340,993	96,753	-
Food and Nutrition						
Salaries and Wages	83,000	33,000	16,886	-	16,114	-
Other Expenses	54,759	54,759	20,273	3,331	31,155	-
<u>DEPARTMENT OF PUBLIC SAFETY</u>						
O.S.H.A.						
Fire - Other Expenses	450,000	450,000	449,294	706	-	-
Uniform Fire Safety Act						
Salaries and Wages	250,000	250,000	250,000	-	-	-
Communications and Technology						
Salaries and Wages	6,203,385	6,203,385	6,081,871	-	121,514	-
Other Expenses	3,624,546	3,624,546	3,254,424	225,258	144,864	-
Parking Enforcement						
Salaries and Wages	3,339,409	3,339,409	3,222,622	-	116,787	-
Other Expenses	266,200	266,200	110,483	80,907	74,810	-
Director's Office						
Salaries and Wages	1,044,008	1,044,008	1,031,535	-	12,473	-
Other Expenses	6,300	6,300	1,606	3,804	890	-
Fire						
Salaries and Wages	66,587,948	66,087,948	64,695,745	-	1,392,203	-
Other Expenses	1,077,020	1,077,020	654,083	305,709	117,228	-
Police						
Salaries and Wages	107,890,900	107,415,900	106,212,024	-	1,203,876	-
Other Expenses	1,154,758	1,154,758	529,908	439,975	184,875	-
<u>HOUSING, ECONOMIC DEVELOPMENT AND COMMERCE</u>						
Director's Office						
Salaries and Wages	432,618	452,618	447,777	-	4,841	-
Other Expenses	12,950	12,950	8,436	2,160	2,354	-
Construction Code Official						
Salaries and Wages	2,537,674	2,462,674	2,391,865	-	70,809	-
Other Expenses	101,679	101,679	60,844	21,891	18,944	-
Tenant/Landlord Relations						
Salaries and Wages	312,207	312,207	278,326	-	33,881	-
Other Expenses	6,600	6,600	6,501	1	98	-
Community Development						
Other Expenses	1,500	1,500	870	-	630	-
Commerce						
Salaries and Wages	577,945	577,945	552,636	-	25,309	-
Other Expenses	17,655	17,655	11,840	659	5,156	-
Economic Development						
Salaries and Wages	191,728	191,728	180,797	-	10,931	-
Other Expenses	2,300	2,300	982	738	580	-
City Planning						
Salaries and Wages	998,721	923,721	844,664	-	79,057	-
Other Expenses	12,800	12,800	6,303	2,793	3,704	-
Housing Code Enforcement						
Salaries and Wages	722,695	782,695	732,320	-	50,375	-
Other Expenses	40,500	40,500	29,876	3,421	7,203	-
Planning Board						
Other Expenses	83,500	83,500	66,647	14,825	2,028	-
Board of Adjustment						
Other Expenses	82,500	82,500	70,562	10,246	1,692	-
Historic District Commission						
Other Expenses	1,000	1,000	293	-	707	-
Zoning Officer						
Salaries and Wages	353,825	358,825	355,603	-	3,222	-
Other Expenses	8,038	8,038	7,000	762	276	-

CITY OF JERSEY CITY  
CURRENT FUND  
FOR THE YEAR ENDED DECEMBER 31, 2017

STATEMENT OF APPROPRIATIONS - REGULATORY BASIS

	Appropriations		Expended			Unexpended Balance Canceled
	Adopted Budget	Budget After Modification	Paid or Charged	Encumbered	Reserved	
<b>INSURANCE</b>						
Insurance - All Departments	\$ 12,696,854	\$ 12,696,854	\$ 10,684,496	\$ 1,020,446	\$ 991,912	\$ -
Employee Group Health Insurance	93,101,688	93,101,688	74,578,329	15,823,801	2,699,558	-
Health Benefit Waiver	1,650,000	1,650,000	1,617,442	-	32,558	-
<b>UNCLASSIFIED</b>						
Municipal Publicity	30,000	30,000	7,932	2,500	19,568	-
Other Municipal Advertising	25,000	25,000	-	-	25,000	-
Celebration of Public Events	350,000	350,000	340,640	8,749	611	-
Professional Affiliations	21,000	21,000	8,784	-	12,216	-
Ethical Standards Board	20,000	20,000	4,500	13,500	2,000	-
Electricity	3,000,000	3,000,000	1,634,881	386,119	979,000	-
Street Lighting	3,400,000	3,400,000	3,066,984	133,014	200,002	-
Municipal Rent	2,911,049	2,911,049	2,605,005	58,634	247,410	-
Gasoline	1,500,000	1,500,000	858,326	186,666	455,008	-
Communications	1,096,000	1,096,000	602,877	425,847	67,276	-
Office Services	2,863,286	2,796,253	1,843,544	480,713	471,996	-
Salary Adjustment	4,000,000	2,500,000	290	-	2,499,710	-
Accumulated Absence Reserve	8,561,022	10,061,022	10,061,022	-	-	-
(B) Contingent	50,000	50,000	-	-	50,000	-
Total Operations Including Contingent within "CAPS"	419,525,403	419,523,370	375,334,511	26,654,920	17,533,939	-
Detail:						
Salaries and Wages	241,309,446	239,314,446	232,164,615	-	7,149,831	-
Other Expenses	178,215,957	180,208,924	143,169,896	26,654,920	10,384,108	-
<b>(E) Deferred Charges and Statutory Expenditures within "CAPS"</b>						
<b>(1) DEFERRED CHARGES</b>						
Expenditure without Appropriation	6,738,978	6,738,978	6,738,978	-	-	-
Prior Years' Bills	7,270	9,303	9,303	-	-	-
<b>(2) STATUTORY EXPENDITURES</b>						
Contribution to:						
Social Security System (O.A.S.I.)	5,400,000	5,400,000	5,400,000	-	-	-
Consolidated Police and Fire Fund	58,994	58,994	-	-	58,994	-
Police/Fire Retirement System (PFRS)	38,879,673	38,879,673	38,869,751	-	9,922	-
Municipal Employees Pension Fund	9,054,000	9,054,000	9,054,000	-	-	-
Employees Non-Contributory Pension	230,000	230,000	164,927	-	65,073	-
Pensioned Employees	64,740	64,740	59,522	-	5,218	-
Payments to Widows and Dependents of Deceased Public Safety Members	779	779	719	-	60	-
<b>(E) Deferred Charges and Statutory Expenditures within "CAPS"</b>						
<b>(2) STATUTORY EXPENDITURES (continued)</b>						
Contribution to:						
Unemployment Compensation Insurance	50,000	50,000	50,000	-	-	-
Public Employees Retirement (PERS)	4,070,903	4,070,903	4,048,980	-	21,923	-
Defined Benefit Contribution Plan	65,000	65,000	42,458	-	22,542	-
	64,620,337	64,622,370	64,438,638	-	183,732	-
<b>(H-1) TOTAL GENERAL APPROPRIATIONS FOR MUNICIPAL PURPOSES WITHIN "CAPS"</b>						
	484,145,740	484,145,740	439,773,149	26,654,920	17,717,671	-
<b>(A) Operations - Excluded From "CAPS"</b>						
<b>GENERAL GOVERNMENT:</b>						
Maintenance of Free Public Library	\$ 8,966,755	\$ 8,966,755	\$ 8,865,420	\$ -	\$ 101,335	\$ -
Reserve for Tax Appeals	400,000	400,000	14,683	-	385,317	-
Tax Overpayments	2,000,000	2,000,000	1,173,586	-	826,414	-
	11,366,755	11,366,755	10,053,689	-	1,313,066	-

CITY OF JERSEY CITY  
CURRENT FUND  
FOR THE YEAR ENDED DECEMBER 31, 2017

STATEMENT OF APPROPRIATIONS - REGULATORY BASIS

	Appropriations		Expended			Unexpended Balance Canceled
	Adopted Budget	Budget After Modification	Paid or Charged	Encumbered	Reserved	
<b>PUBLIC AND PRIVATE APPROPRIATIONS</b>						
<b>OFFSET BY REVENUES</b>						
Federal and State Grants Fund						
Distracted Driving Grant	\$ 5,500	\$ 5,500	\$ 5,500	\$ -	\$ -	\$ -
Health Corner Store Initiative	5,000	5,000	5,000	-	-	-
Highlands TDR Feasibility	40,000	40,000	40,000	-	-	-
Innovation Team Grant	676,394	676,394	676,394	-	-	-
Recreational Opportunities for Individuals with Disabilities (ROID Grant)	24,000	24,000	24,000	-	-	-
Municipal Drug Alliance						
Grant Funds	-	213,903	213,903	-	-	-
City Match	-	53,476	53,476	-	-	-
NJDOT - Journal Square Pedestrian Safety	-	220,000	220,000	-	-	-
Hudson Regional Health Commission						
OLPHW -STD	-	47,791	47,791	-	-	-
Drunk Driver Enforcement Fund	14,625	14,625	14,625	-	-	-
Urban Area Security Initiative (UASI)	-	1,710,000	1,710,000	-	-	-
Recycling Tonnage Grant	298,152	298,152	298,152	-	-	-
Community Service Block Grant (CSBG)	529,955	925,281	925,281	-	-	-
AARP - Tree Planting	-	3,000	3,000	-	-	-
NJDOH - Woman, Infants & Children (WIC)	-	1,802,583	1,802,583	-	-	-
Summer Food Program	626,915	626,915	626,915	-	-	-
Senior Nutrition						
Grant Funds	1,531,798	1,531,798	1,531,798	-	-	-
Food Insecurity Nutrition	8,425	8,425	8,425	-	-	-
YMCA State Alliance Healthy NJ Contest	-	500	500	-	-	-
Tarentino Community Policing Grant	-	10,000	10,000	-	-	-
Healthy Community	1,033	1,033	1,033	-	-	-
Sub-Regional Transportation						
Grant Funds	-	99,328	99,328	-	-	-
City Match	-	22,632	22,632	-	-	-
JTPA	-	2,965,248	2,965,248	-	-	-
Port Security Fire	225,000	225,000	225,000	-	-	-
Port Security Police	163,431	163,431	163,431	-	-	-
Cities of Service - Vista	25,000	25,000	25,000	-	-	-
Green Acres - Berry Lane	1,100,000	1,100,000	1,100,000	-	-	-
Body Worn Cameras Program	-	100,000	100,000	-	-	-
Body Armor Replacement	-	71,364	71,364	-	-	-
STD Education	122,183	122,183	122,183	-	-	-
STD Screening - High Risk	-	45,000	45,000	-	-	-
Municipal Aid - Various Streets	1,038,402	1,038,402	1,038,402	-	-	-
Local Safety Program - MLK Drive	-	399,714	399,714	-	-	-
Local Safety Program - Communipaw Ave.	-	736,383	736,383	-	-	-
Clean Communities Program	387,918	387,918	387,918	-	-	-
Summer Works Initiative	190,000	190,000	190,000	-	-	-
Comprehensive Traffic Safety	26,700	26,700	26,700	-	-	-
Make-A-Splash	-	3,380	3,380	-	-	-
CLPP (Porsche)	-	194,025	194,025	-	-	-
Trust Fund (Housing and Urban Development Grants):						
Community Development Block Grant	-	5,034,144	5,034,144	-	-	-
Home Investment Partnerships	-	1,354,363	1,354,363	-	-	-
Housing Opportunities for Persons with Aids	-	2,420,486	2,420,486	-	-	-
Emergency Solutions Grant	-	457,848	457,848	-	-	-
Matching Funds for Grants	104,000	27,892	-	-	27,892	-
	7,144,431	25,428,817	25,400,925	-	27,892	-
Total Operations - Excluded from "CAPS"	18,511,186	36,795,572	35,454,614	-	1,340,958	-
Detail:						
Other Expenses	18,511,186	36,795,572	35,454,614	-	1,340,958	-

CITY OF JERSEY CITY  
CURRENT FUND  
FOR THE YEAR ENDED DECEMBER 31, 2017

STATEMENT OF APPROPRIATIONS - REGULATORY BASIS

	Appropriations		Paid or Charged	Expended		Unexpended Balance Canceled
	Adopted Budget	Budget After Modification		Encumbered	Reserved	
(C) Capital Improvements - Excluded from "CAPS"						
Capital Improvement Fund	\$ 300,000	\$ 300,000	\$ 300,000	\$ -	\$ -	\$ -
	<u>300,000</u>	<u>300,000</u>	<u>300,000</u>	<u>-</u>	<u>-</u>	<u>-</u>
(D) Municipal Debt Service						
General Debt Service:						
Serial Bonds - General Qualified	5,162,000	5,162,000	5,162,000	-	-	-
Serial Bonds - General Refunding	24,895,000	24,895,000	24,895,000	-	-	-
Serial Bonds - General Principal	4,235,000	4,235,000	4,235,000	-	-	-
Serial Bonds - General Interest	4,053,588	4,053,588	4,053,588	-	-	-
Fire Pension Refunding Bonds - Interest	916,226	916,226	916,226	-	-	-
Police Pension Refunding Bonds - Interest	1,140,485	1,140,485	1,140,485	-	-	-
Interest on Bonds - General Qualified	1,148,937	1,148,937	1,148,937	-	-	-
Interest on Bonds - General Refunding	7,226,196	7,226,196	7,226,196	-	-	-
Interest on Notes - General and Refunding	622,104	622,104	622,104	-	-	-
Bond Anticipation Notes - Principal	1,997,166	1,997,166	1,997,166	-	-	-
Green Trust Loan Repayments for Principal and Interest						
Montgomery Gateway	3,111	3,111	3,111	-	-	-
Multi Parks	38,243	38,243	38,243	-	-	-
Wayne Street Park	9,022	9,022	9,022	-	-	-
Apple Tree House	14,670	14,670	14,670	-	-	-
Roberto Clemente Park	17,662	17,662	17,662	-	-	-
Sgt. Anthony Park	9,018	9,018	9,018	-	-	-
Marion Pavonia Pool	26,428	26,428	26,428	-	-	-
Berry Lane	8,084	8,084	8,084	-	-	-
Build America Bonds - Principal	1,690,000	1,690,000	1,690,000	-	-	-
Build America Bonds - Interest	5,895,767	5,895,767	5,895,767	-	-	-
Police/Fire Pension Refunding Bonds-Prin.	1,655,000	1,655,000	1,655,000	-	-	-
Assessment Bonds - Principal	595,000	595,000	595,000	-	-	-
Assessment Bonds - Interest	453,243	453,243	453,243	-	-	-
Water Debt Service:						
Serial Bonds - General Qualified	3,415,000	3,415,000	3,415,000	-	-	-
Serial Bonds - Refunding	1,025,000	1,025,000	1,025,000	-	-	-
Interest on Bonds - Refunding	460,431	460,431	460,431	-	-	-
Interest on Bonds - Qualified	289,524	289,524	289,524	-	-	-
	<u>67,001,905</u>	<u>67,001,905</u>	<u>67,001,905</u>	<u>-</u>	<u>-</u>	<u>-</u>
(E) Deferred Charges - Municipal - Excluded from "CAPS"						
Emergency Authorizations (N.J.S.40A:4-55)	6,897,496	6,897,496	6,897,496	-	-	-
Emergency Authorizations - H. Sandy	35,000	35,000	35,000	-	-	-
	<u>6,932,496</u>	<u>6,932,496</u>	<u>6,932,496</u>	<u>-</u>	<u>-</u>	<u>-</u>
(H-2)TOTAL GENERAL APPROPRIATIONS FOR MUNICIPAL PURPOSES - EXCLUDED FROM "CAPS"	<u>92,745,587</u>	<u>111,029,973</u>	<u>109,689,015</u>	<u>-</u>	<u>1,340,958</u>	<u>-</u>

CITY OF JERSEY CITY  
CURRENT FUND  
FOR THE YEAR ENDED DECEMBER 31, 2017

STATEMENT OF APPROPRIATIONS - REGULATORY BASIS

	Appropriations		Paid or Charged	Expended		Unexpended Balance Canceled
	Adopted Budget	Budget After Modification		Encumbered	Reserved	
(K) Local District School Purposes - Excluded from "CAPS"						
<u>TYPE 1 DISTRICT SCHOOL DEBT</u>						
Serial Bonds - School Qualified	\$ 6,325,000	\$ 6,325,000	\$ 6,325,000	\$ -	\$ -	\$ -
Interest on Bonds - School Qualified	780,819	780,819	780,819	-	-	-
	<u>7,105,819</u>	<u>7,105,819</u>	<u>7,105,819</u>	<u>-</u>	<u>-</u>	<u>-</u>
(O) TOTAL GENERAL APPROPRIATIONS - EXCLUDED FROM "CAPS"	99,851,406	118,135,792	116,794,834	-	1,340,958	-
(L) Subtotal General Appropriations	583,997,146	602,281,532	556,567,983	26,654,920	19,058,629	-
(M) Reserve for Uncollected Taxes	4,880,770	4,880,770	4,880,770	-	-	-
TOTAL GENERAL APPROPRIATIONS	<u>\$ 588,877,916</u>	<u>\$ 607,162,302</u>	<u>\$ 561,448,753</u>	<u>\$ 26,654,920</u>	<u>\$ 19,058,629</u>	<u>\$ -</u>
	Ref.			A-19	A	
Budget As Adopted	A-2	\$ 588,877,916	\$ 4,880,770	A-2a	Reserve for Uncollected Taxes	
Added by N.J.S.A. 40A:4-87	A-2	18,284,386	174,657,393	A-4	Cash Disbursements	
Added by N.J.S.A. 40A:4-53, Special Emergency	A-16	-	46,019,272	A-15	Qualified Bonds Paid by State	
		<u>607,162,302</u>	6,773,978	A-16	Deferred Charges	
Less: Appropriations Canceled		-	(16,578,089)	A-17	Reimbursements - Interfunds	
	A-1	<u>\$ 607,162,302</u>	300,000	A-17	Capital Improvement Fund	
			319,994,504	A-17	Payroll Clearing	
			25,400,925	A-17	State and Federal Grants	
			<u>\$ 561,448,753</u>			

DRAFT



CITY OF JERSEY CITY  
TRUST FUND  
AS OF DECEMBER 31, 2017 AND 2016

COMPARATIVE BALANCE SHEET - REGULATORY BASIS

	Ref.	2017	2016
<u>Assets:</u>			
Animal Control Fund:			
Cash and Cash Equivalents	B-1	\$ 59,073	\$ 47,394
Other Funds:			
Cash and Cash Equivalents:			
Other Trust		34,070,443	34,789,030
Insurance Trust		815,641	209,610
Unemployment Insurance Trust		1,583,380	1,487,828
Law Enforcement Trust		2,119,528	2,181,799
Community Development Block Grant		1,951,142	1,974,836
Home Investments Partnership Program		893,862	734,234
HOPWA Grant		54,242	54,242
Martin Luther King (MLK)		93,534	99,444
Total Cash and Cash Equivalents	B-1	41,581,772	41,531,023
Federal Grants Receivable	B-7	36,488,560	37,397,181
Deferred Charges	B-8	153,900	-
Interfunds Receivable	B-9	689,154	106,404
		<u>78,913,386</u>	<u>79,034,608</u>
Payroll Clearing Fund:			
Cash and Cash Equivalents	B-1	12,994,428	2,171,384
Interfunds Receivable	B-18	72,567	97,938
		<u>13,066,995</u>	<u>2,269,322</u>
Open Space, Recreation and Historic Preservation Trust Fund			
Interfunds Receivable	B-21	623,000	-
Total Trust Fund Assets		<u>\$ 92,662,454</u>	<u>\$ 81,351,324</u>

CITY OF JERSEY CITY  
TRUST FUND  
AS OF DECEMBER 31, 2017 AND 2016

COMPARATIVE BALANCE SHEET - REGULATORY BASIS

	Ref.	2017	2016
<u>Liabilities and Reserves</u>			
Animal Control Fund:			
Interfunds Payable	B-2	\$ 96	\$ 13
Due to State of New Jersey	B-3	197	172
Reserve for Encumbrances	B-4	3,344	8,131
Reserve for Expenditures	B-5	41,499	25,068
Prepaid Licenses	B-6	13,937	14,010
		<u>59,073</u>	<u>47,394</u>
Other Funds:			
Interfunds Payable	B-9	923,295	109,756
Intergovernmental Payables	B-10	654,248	265,929
Reserve for Encumbrances	B-11	17,456,304	23,387,753
Reserve for:			
Dedicated Revenues and Special Deposits	B-12	27,795,185	25,729,642
Insurance Expenditures	B-16	815,641	210,095
Unemployment Expenditures	B-14	1,199,934	1,476,191
Federal Forfeitures	B-15	1,087,612	916,785
State Forfeitures	B-15	1,591,462	1,195,875
Federal Grant Expenditures	B-13	27,389,705	25,742,582
		<u>78,913,386</u>	<u>79,034,608</u>
Payroll Clearing Fund:			
Interfunds Payable	B-18	11,469,449	71
Due to Library	B-19	79,270	63,538
Reserve for Payroll Deductions	B-20	1,518,276	2,205,713
		<u>13,066,995</u>	<u>2,269,322</u>
Open Space, Recreation and Historic Preservation Trust Fund			
Reserve for Expenditures	B-22	623,000	-
Total Trust Fund Liabilities and Reserves		<u>\$ 92,662,454</u>	<u>\$ 81,351,324</u>

**CITY OF JERSEY CITY  
GENERAL CAPITAL FUND  
AS OF DECEMBER 31, 2017 AND 2016**

**COMPARATIVE BALANCE SHEET - REGULATORY BASIS**

	Ref.	2017	2016
<u>Assets</u>			
Cash and Cash Equivalents	C-2; C-3	\$ 56,313,000	\$ 69,544,114
Deferred Charges to Future Taxation:			
Funded	C-4	422,696,779	468,414,405
Unfunded	C-5	54,237,887	55,145,081
Deferred Charges to Future Water Rents - Unfunded	C-6	-	1,461,658
Interfund Receivable	C-8	329,337	-
Due from Municipal Utilities Authority	C-7	21,150,000	25,590,000
		<u>\$ 554,727,003</u>	<u>\$ 620,155,258</u>
<u>Liabilities and Reserves</u>			
Interfund Payable	C-8	\$ 500,009	\$ 32,617
Reserve for Encumbrances	C-17	14,466,259	16,023,817
Improvement Authorizations:			
Funded	C-9	34,333,334	47,065,617
Unfunded	C-9	28,343,765	29,430,993
School Serial Bonds Payable	C-12	20,830,000	27,155,000
General Serial and Term Bonds Payable	C-13	352,980,000	390,017,000
Pension Refunding Bonds	C-14	36,710,000	38,365,000
Water Serial Bonds Payable	C-15	21,150,000	25,590,000
Local Improvement Bonds	C-16	11,226,000	11,821,000
Green Trust Loans Payable	C-11	950,779	1,056,405
Bond Anticipation Notes	C-10	24,901,000	26,898,194
Capital Improvement Fund	C-20	377,066	77,066
Reserve for Retirement of Debt	C-19	3,528,302	-
Other Reserves	C-18	3,002,382	5,316,308
		<u>553,298,896</u>	<u>618,849,017</u>
Fund Balance	C-1	1,428,110	1,306,241
Total Liabilities, Reserves, and Fund Balance		<u>\$ 554,727,006</u>	<u>\$ 620,155,258</u>
Bonds and Notes Authorized But Not Issued	C-21	<u>\$ 29,336,887</u>	<u>\$ 29,708,545</u>

See Accompanying Notes to Financial Statements

**CITY OF JERSEY CITY  
GENERAL CAPITAL FUND  
FOR THE YEARS ENDED DECEMBER 31, 2017 and 2016**

**COMPARATIVE STATEMENT OF CHANGES IN FUND BALANCE - REGULATORY BASIS**

	<u>Ref.</u>	<u>2017</u>	<u>2016</u>
<u>Receipts</u>			
Premiums on Bonds and Notes, Net of Closing Costs	C-8	\$ 166,444	\$ 15,517
Other Reserves Cancelled	C-18	-	301,218
		<u>166,444</u>	<u>316,735</u>
<u>Expenditures</u>			
Fund Ord. No. 12-042 from Prior Year Premium Balance of Ordinance Paid from Bond Proceeds	C-2; C-10	-	1,941,950
Ordinance No. 16.159 to Fully Fund the Acquisition of Roll Off Trucks		28	159
Current Fund Share of Premiums	C-2	-	499,632
		<u>44,550</u>	<u>-</u>
		<u>44,578</u>	<u>2,441,741</u>
Change in Fund Balance		121,866	(2,125,006)
Fund Balance, January 1	C	<u>1,306,241</u>	<u>3,431,247</u>
Fund Balance, December 31	C	<u>\$ 1,428,107</u>	<u>\$ 1,306,241</u>

DRAFT

**CITY OF JERSEY CITY  
GENERAL FIXED ASSETS  
AS OF DECEMBER 31, 2017 AND 2016**

**COMPARATIVE BALANCE SHEET - REGULATORY BASIS**

	<u>Ref.</u>	<u>2017</u>	<u>2016</u>
<u>Assets</u>			
Land	D-1	\$ 127,760,200	\$ 138,916,522
Improvements	D-1	231,648,416	130,980,911
Machinery and Equipment	D-1	<u>54,923,714</u>	<u>79,395,979</u>
Total Assets		<u>\$ 414,332,330</u>	<u>\$ 349,293,412</u>
 <u>Investment in Fixed Assets:</u>			
Investment in Fixed Assets	D-2	<u>\$ 414,332,330</u>	<u>\$ 349,293,412</u>

DRAFT

**CITY OF JERSEY CITY  
NOTES TO FINANCIAL STATEMENTS**

**DECEMBER 31, 2017 AND 2016**

**NOTE A. SUMMARY OF SIGNIFICANT ACCOUNTING POLICIES**

**REPORTING ENTITY**

The City of Jersey City (the "City") is organized as a Mayor – Council municipality under the provisions of N.J.S.A. 40:69A. The City is governed by an elected Mayor and Council, and by such other officers and employees as may be duly appointed. The Council consists of nine members, six of whom are elected from the City's six wards and three of whom are elected at-large by voters of the City. The Mayor is also elected directly by the voters of the City. The Mayor and each Council member serve a term of four years beginning on the first day of July next following their election.

The financial statements of the City include every board, body, officer or commission supported and maintained wholly or in part by funds appropriated by the City, as required by N.J.S.A. 40A:5-5. The Governmental Accounting Standards Board (herein referred to as "GASB") establishes criteria to be used to determine which component units should be included in the financial statements of the primary government (the City). The State of New Jersey, Department of Community Affairs, Division of Local Government Services (the "Division") requires the financial statements of the City to be reported separately from its component units. If the provisions of GASB had been complied with, the financial statements of the following component units would have been discretely presented with the financial statements of the City:

Jersey City Incinerator Authority (1)	Jersey City Free Public Library
Exchange Place Alliance SID	Jersey City Employment & Training Program, Inc.
Jersey City Central Ave SID	Jersey City Economic Development Corp
Jackson Hill Main Street SID	Jersey City Municipal Utilities Authority
Journal Square SID	Jersey City Employees' Retirement System
McGinley Square SID	Jersey City Housing Authority
Historic Downtown SID	Jersey City Redevelopment Agency

(1) The City dissolved and assumed control of the Jersey City Incinerator Authority on April 1, 2016.

Audit reports of the component units are available at the offices of each of the respective component units.

The Jersey City Board of Education became a Type II School District effective November 4, 2008, rendering the entity no longer a component unit of the City. However, material outstanding bonds remain on the City's books which were originally issued prior to this date when the City operated as a Type I School District, at which time it met the criteria for inclusion as a component unit. See also "Note O. Related Party Transactions".

**CITY OF JERSEY CITY  
NOTES TO FINANCIAL STATEMENTS**

**DECEMBER 31, 2017 AND 2016**

**NOTE A. SUMMARY OF SIGNIFICANT ACCOUNTING POLICIES (continued)**

**BASIS OF PRESENTATION**

The Governmental Accounting Standards Board (GASB) is the accepted standard-setting body for establishing governmental accounting and financial reporting principles. GASB codification establishes three fund categories to be used by general purpose governmental units when reporting financial position and results of operations in accordance with accounting principles generally accepted in the United States of America (GAAP).

The financial statements of the City have been prepared in conformity with accounting principles and practices prescribed by the Division, which differ from GAAP. The principles and practices prescribed by the Division are designed primarily for determining compliance with legal provisions and budgetary restrictions and as a means of reporting on the stewardship of public officials with respect to public funds. Under this method of accounting, the City accounts for its financial transactions through the following separate funds and account group, which differ from the fund structure required by GAAP.

**DESCRIPTION OF FUNDS**

**Current Fund** - is used to account for all resources and expenditures for governmental operations of a general nature.

**Federal and State Grants Fund** - is used to account for receivables due from grantor agencies and the balance of grant awards available for spending, after first having been formally adopted by Current Fund budget or subsequent insertion in the budget in accordance with N.J.S.A. 40A:4-87. This fund is presented within the City's Current Fund statements and schedules.

**General Capital Fund** - is used to account for the receipt and disbursement of funds for the acquisition of general capital facilities, other than those acquired in the Current Fund or other funds. Also included in this fund are bonds and notes payable offset by deferred charges to future taxation and deferred charges to future water rents.

**General Fixed Assets** - is not a separate fund type, but is an account group used to account for all fixed assets of the City.

**CITY OF JERSEY CITY  
NOTES TO FINANCIAL STATEMENTS**

**DECEMBER 31, 2017 AND 2016**

**NOTE A. SUMMARY OF SIGNIFICANT ACCOUNTING POLICIES (continued)**

DESCRIPTION OF FUNDS (continued)

**Trust Funds** - are used to account for receipts, custodianship and disbursement of dedicated revenues in accordance with the purpose for which each reserve was created, subject to available cash in each individual trust fund reserve established pursuant to applicable state statutes or as an agent for individuals and other governmental agencies. The City has the following Trust Funds:

Animal Control Trust Fund – is used to account for fees collected from dog and cat licenses and expenditures which are regulated by N.J.S.A 4:19-15,11.

Trust Fund – Other Funds – is used to account for the assets and resources held by the City in a trustee or agent capacity. Included in this fund are monies collected and disbursed for the purposes of: employee and employer contributions and obligations resulting from the administration of unemployment benefits, Council on Affordable Housing and NJHMFA fees, tax sale redemption and premiums, restitution, dedicated penalties, bid deposits, developer and other escrow accounts, the parking offenses adjudication act, public defender fees, self-insurance reserves, federal and state forfeitures, federal community block grant programs, miscellaneous other items and donations of various sorts and the outside employment of off-duty police officers whereas fees are charged contractors for the use of police officers and vehicles and police officer overtime is then paid from these contractor's fees.

Payroll Clearing Fund – is an agency fund established to account for assets transferred by the City from its other funds for the payment of employee payrolls and as agent of federal and state governments in the collection and remittance of employee withholding taxes, retirement contributions, social security taxes and other required remittances.

Municipal Open Space, Recreation and Historic Preservation Fund - is used to account for the receipt of funds raised through a dedicated tax and corresponding expenditures as allowable under N.J.S.A. 40A:12-15.7 and as authorized by referendum. This fund was established in 2017.



**CITY OF JERSEY CITY  
NOTES TO FINANCIAL STATEMENTS**

**DECEMBER 31, 2017 AND 2016**

**NOTE A. SUMMARY OF SIGNIFICANT ACCOUNTING POLICIES (continued)**

The accounts of the City are maintained in accordance with the Division's principles of fund accounting to ensure observance of limitations and restrictions on resources available. The Division's principles of fund accounting require that resources be classified for accounting and reporting purposes into funds in accordance with activities or objectives specified for the resources. The operations of each fund are accounted for with a separate set of self-balancing accounts that comprise its assets, liabilities, fund balance (equity), revenues and expenditures. Resources are allocated to and accounted for in individual funds based upon the purposes for which they are to be spent and the means by which spending activities are controlled. General Fixed Assets, on the other hand, is a financial reporting device designed to provide accountability for certain fixed assets and the investment in those fixed assets that are not recorded in the funds because they do not directly affect net expendable available financial resources.

**BASIS OF ACCOUNTING**

The City prepares its financial statements on a basis of accounting prescribed by the Division that demonstrates compliance with a modified accrual basis and the budget laws of the State of New Jersey, which is a special purpose framework of accounting other than accounting principles generally accepted in the United States of America. The current financial resources focus and modified accrual basis of accounting is generally followed with significant exceptions which are explained as follows:

**Revenues** – Revenues are realized when received in cash except for certain amounts which are due from other governmental units. Receipts from Federal revenue sharing funds and other Federal and State grants are realized as revenue when anticipated in the budget. Receivables for property taxes and other amounts that are due to the City are recorded with offsetting reserves on the balance sheet of the Current Fund. Such amounts are not recorded as revenue until collected. Accordingly, no provision has been made to estimate that portion of receivables that are uncollectible. Taxes and payments in lieu of taxes collected in advance are recorded as cash liabilities in the financial statements. GAAP requires revenues to be recognized in the accounting period when they become measurable and available and in certain instances reduced by an allowance for doubtful accounts.

**Reserve for Uncollected Taxes** – Reserve for Uncollected Taxes is required to provide assurance that cash collected for taxes in the current year will provide sufficient cash flow to meet expected obligations. The minimum amount of Reserve for Uncollected Taxes is determined on the percentage of collections experienced in the immediate preceding year, unless allowable alternative methods are utilized. A Reserve for Uncollected Taxes is not established under GAAP.

**CITY OF JERSEY CITY  
NOTES TO FINANCIAL STATEMENTS**

**DECEMBER 31, 2017 AND 2016**

**NOTE A. SUMMARY OF SIGNIFICANT ACCOUNTING POLICIES (continued)**

**Expenditures** – Expenditures are recorded on the “budgetary” basis of accounting. Generally, expenditures are recorded when an amount is encumbered for goods or services through the issuance of a purchase order in conjunction with the encumbrance accounting system. Appropriation reserves covering unexpended appropriation balances are automatically created at the end of each year and recorded as liabilities, except for amounts which may be canceled by the governing body. Appropriations for principal and interest payments on general capital indebtedness are provided on the cash basis. GAAP requires expenditures in the current (or general) fund, to be recognized in the accounting period in which the fund liability is incurred, if measurable, except for un-matured interest on general long-term debt, which should be recognized when due.

**Encumbrances** – Encumbrances are contractual orders outstanding at year end reported as expenditures through the establishment of an encumbrance payable. Outstanding encumbrances at year end are reported as a cash liability in the financial statements. Encumbrances do not constitute expenditures under GAAP.

**Appropriation Reserves** – Appropriations are available until lapsed at the close of the succeeding year to meet specific claims, commitments or contracts incurred during the preceding fiscal year. Transfers are allowed between certain line items during the first three months of the fiscal year. Lapsed appropriation reserves are recorded as other credits to income. Appropriation Reserves do not exist under GAAP.

**Interfunds** - Advances from the current fund are reported as interfunds receivable with offsetting reserves which are created by charges to operations. Income is recognized in the year the receivables are liquidated. Interfunds receivable in the other funds are not offset by reserves. GAAP does not require the establishment of an offsetting reserve.

**Inventories of Supplies** - The costs of inventories of supplies for all funds are recorded as expenditures at the time the individual items are purchased. The costs of inventories are not included on the various balance sheets. GAAP requires the cost of inventories to be reported as a current asset and equally offset by a fund balance reserve.

**Property Acquired for Taxes** – Property Acquired for Taxes is recorded in the current fund at the assessed valuation when the property was acquired and is subsequently updated for revaluations. The value of the property is fully reserved. GAAP requires such property to be recorded as a fixed asset at market value on the date of acquisition.

**CITY OF JERSEY CITY  
NOTES TO FINANCIAL STATEMENTS**

**DECEMBER 31, 2017 AND 2016**

**NOTE A. SUMMARY OF SIGNIFICANT ACCOUNTING POLICIES (continued)**

**Deferred Charges to Future Taxation (Funded and Unfunded)** - Upon the authorization of general capital projects, the City establishes deferred charges for the costs of the capital projects to be raised by future taxation. Funded deferred charges relate to permanent debt issued, whereas unfunded deferred charges relate to temporary or non-funding of the authorized costs of capital projects. The City may levy taxes on all taxable property within the City to repay the debt. Annually, the City raises the debt requirements for that particular year in the current budget. As the funds are raised by taxation, the deferred charges are reduced. GAAP does not require the establishment of deferred charges to future taxation.

**Deferred Charges to Future Water Rents** - Upon the authorization of water capital projects, the City establishes deferred charges for the costs of the capital projects to be raised by future water rents. Funded deferred water rents relate to permanent debt issued. The City may impose water rents on all water users within the City to repay the debt. GAAP does not require the establishment of deferred charges to future water rents.

**Improvement Authorizations** - Improvement Authorizations in the general capital fund represent the unexpended balance of an ordinance appropriation and is similar to the unexpended portion of the budget in the current fund. GAAP does not recognize these amounts as liabilities.

**Long-Term Obligations** - General long-term debt is recognized as a liability of the General Capital Fund for the full principal amount.

**Compensated Absences and Post-Employment Benefits** - Compensated absences for vacation, sick leave and other compensated absences are recorded and provided for in the annual budget in the year in which they are paid, on a pay-as-you-go basis. Likewise, no accrual is made for post-employment benefits, if any, which are also funded on a pay-as-you-go basis. GAAP requires that the amount that would normally be liquidated with expendable financial resources to be recorded as an expenditure in the operating funds and the remaining obligations be recorded as long-term obligations.

**Net Pension Liabilities** - Had generally accepted accounting principles been followed, the City's share of its actuarially determined net pension liabilities for the Public Employees Retirement System ("PERS") and Police and Fire Retirement System ("PFRS") would be required to be accrued on the City's balance sheet. Accounting practices prescribed by the Division of Local Government Services only require note disclosure of these liabilities and related actuarial information. The City appropriates annually the amounts required to be paid in any fiscal year in that year's budget its share of PERS and PFRS obligations.

**CITY OF JERSEY CITY  
NOTES TO FINANCIAL STATEMENTS**

**DECEMBER 31, 2017 AND 2016**

**NOTE A. SUMMARY OF SIGNIFICANT ACCOUNTING POLICIES (continued)**

**General Fixed Assets** - Accounting for Governmental Fixed Assets as promulgated by the Division differs in certain respects from GAAP, and requires the inclusion of a statement of general fixed assets as part of the City's basic financial statements.

Fixed assets used in governmental operations (general fixed assets) are accounted for in an account group identified as "General Fixed Assets" and are not included within the records of any fund types. Purchases from these funds for fixed assets are recorded as expenditures within the fund. Public domain (infrastructure) general fixed assets consisting of certain improvements, other than improvements to buildings, such as improvements to roads, bridges, curbs and gutters, streets and sidewalks and drainage systems, are not capitalized.

All fixed assets, except land, are valued at historical cost or estimated historical cost if actual historical cost is not available. Expenditures for construction in progress are recorded in the Capital Fund against authorizations under which the project was approved until such time as the construction is completed and put into operation.

The City is required to maintain a subsidiary ledger of detailed records of fixed assets and to provide property management standards to control fixed assets. General fixed assets are defined as non-expendable personal property having a physical existence, a useful life of more than five years and an acquisition cost of \$5,000 or more per unit.

The City has developed a fixed assets accounting and reporting system based on an inspection and appraisal prepared by an independent appraisal firm.

Fixed assets acquired through grants in aid or contributed capital have not been accounted for separately.

No depreciation has been provided in the financial statements.

GAAP requires the recording of infrastructure assets and requires capital assets be depreciated over their estimated useful life unless they are either inexhaustible or are infrastructure assets reported using the modified approach.

**CITY OF JERSEY CITY  
NOTES TO FINANCIAL STATEMENTS**

**DECEMBER 31, 2017 AND 2016**

**NOTE A. SUMMARY OF SIGNIFICANT ACCOUNTING POLICIES (continued)**

**Reserves (Other than Reserve for Receivables)** - Reserves, other than reserve for receivables, are considered liabilities, and not as a reservation of fund balance.

**Reserves for Receivables** – Receivables of the City, with the exception of certain intergovernmental receivables, are offset on the balance sheet with a credit that is created to preserve the revenue recognition basis required by the Division’s accounting policies. The reserve delays the recognition of these revenues until they are received in cash.

**Sale of Municipal Assets** - The proceeds of the sale of municipal assets can be held until made available through a future budget appropriation. GAAP requires such proceeds to be recorded as revenue in the year of sale.

**Use of Estimates** - The preparation of financial statements requires management to make estimates and assumptions that affect: the reported amounts of assets and liabilities, disclosure of contingent assets and liabilities at the date of the financial statements and the reported amounts of revenues and expenses during the reporting period. Actual results could differ from these estimates.

**Advertising Costs** - Advertising costs are charged against the appropriate budget line as they occur. The City does not engage in direct-response advertising.

**Fund Balance** - Fund equity represented on the financial statements consists solely of Fund Balance, which is not further categorized with respect to reservations (portions of fund equity not available for appropriation for expenditure or legally segregated for a specific future use) or designations (plans for future use of financial resources).

**Budgets and Budgetary Accounting** – The City is required to adopt an annual budget and integrate it into the accounting system to provide budgetary control over revenues and expenditures. Budget amounts presented in the accompanying financial statements represent amounts adopted by the City and approved by the Division in accordance with the Local Budget Law. Budgets are adopted on the same basis of accounting utilized for the preparation of the City’s financial statements. The budgetary requirements herein outlined are applicable to only the Current Fund, and not the Trust Fund, Capital Fund or General Fixed Assets.

Statutes further require the City to annually adopt a six-year capital plan. This plan allows the governing body to expend or incur obligations for capital purposes only. Such projects under the plan must be adopted through capital ordinance.

**CITY OF JERSEY CITY  
NOTES TO FINANCIAL STATEMENTS**

**DECEMBER 31, 2017 AND 2016**

**NOTE A. SUMMARY OF SIGNIFICANT ACCOUNTING POLICIES (continued)**

BASIS OF ACCOUNTING (continued)

**Budgets and Budgetary Accounting – continued**

The City must adhere to procedures for adoption of its annual budget as established by the Division. These procedures include statutory deadlines of: February 10 for introduction and approval and March 20 for adoption. These dates are subject to extension by the Division by approval of the Local Finance Board. Appropriations within the adopted budget cannot be modified until the final two months of the year at which time transfers between certain line items are allowed. Transfers from appropriations excluded from “CAPS” are prohibited unless they are between debt service appropriations. Under certain circumstances emergency authorizations and insertions of items of revenue and appropriation are allowed by authorization of the governing body, subject to approval of the Division.

The City must prepare its budgets in compliance with applicable laws capping the amounts by which both the budgeted appropriations and the tax levy can be increased. A description of both “CAPS” follows:

1977 Appropriation "CAP": The 1977 Appropriation Cap is calculated using the formulas and provisions of N.J.S.A. 40A:4-45.1 through 4-45.43a. The law was originally adopted in 1976 and was most recently amended in 2003. Under this law, the City is permitted to increase its overall appropriations (with certain exceptions) by 2.5% or the “cost of living adjustment” (COLA), whichever is less. The COLA is calculated based on the traditional Federal government inflation calculation. The City can, when the COLA is less than or equal to 2.5%, increase its allowable inside-the-cap spending to 3.5%, upon passage of a COLA Rate Ordinance.

2010 Levy "CAP": The 2010 Levy Cap is calculated using the formulas and provisions of N.J.S.A. 40A:4-45.44 through 45.47. It establishes limits on the increase in the total City amount to be raised by taxation (tax levy). The core of the levy cap formula is a 2% increase to the previous year’s amount to be raised by taxation, net of any applicable cap base adjustments and emergency or special emergency appropriations.

**CITY OF JERSEY CITY  
NOTES TO FINANCIAL STATEMENTS**

**DECEMBER 31, 2017 AND 2016**

**NOTE A. SUMMARY OF SIGNIFICANT ACCOUNTING POLICIES (continued)**

**Cash and Investments** - New Jersey governmental units are required to deposit public funds in a public depository. Public depositories are defined by statutes as any state or federally chartered bank, savings bank or an association located in New Jersey or a state or federally chartered bank, savings bank or an association located in another state with a branch office in New Jersey, the deposits of which are insured by the Federal Deposit Insurance Corporation ("FDIC") and which receives or holds public funds on deposit, but does not include deposits held by the State of New Jersey Cash Management Fund. N.J.S.A. 40A:5-15.1 provides a list of securities which may be purchased by New Jersey municipal units.

The City is also required to annually adopt a cash management plan and to deposit or invest its funds pursuant to the cash management plan. The cash management plan adopted by the City requires it to deposit funds as permitted in N.J.S.A 40:5-15.1, so long as the funds are deposited in public depositories protected from loss under the provisions of the Governmental Unit Deposit Protection Act (GUDPA). GUDPA was enacted in 1970 to protect governmental units from a loss of funds on deposit with a failed banking institution in New Jersey and requires all public depositories pledge collateral, having a market value of five percent of the average daily balance of collected public funds, to secure the deposits of governmental units. If a public depository fails, the collateral it has pledged, plus the collateral of all other public depositories in the collateral pool, is available to pay the full amount of their deposits to the governmental units.

In 2009, legislation revised GUDPA to provide higher levels of security and oversight. The revised GUDPA ensures a common level of deposit risk for each bank choosing to accept local government deposits. It requires banks to fully collateralize deposits over \$200 million, implements enforcement protocol which allows the Department of Banking and Insurance to institute risk-based collateral requirements promptly when a bank shows signs of stress, provides enhanced oversight by the Department of Banking and Insurance and permits GUDPA certificates to be provided through an online system.

Cash Equivalents include certificate of deposits with a maturity date of three (3) month or less.

Also see Note B - Cash and Cash Equivalents.

**CITY OF JERSEY CITY  
NOTES TO FINANCIAL STATEMENTS**

**DECEMBER 31, 2017 AND 2016**

**NOTE A. SUMMARY OF SIGNIFICANT ACCOUNTING POLICIES (continued)**

**BASIC FINANCIAL STATEMENTS**

The GASB Codification also requires the financial statements of a governmental unit presented in the general purpose financial statements to be in accordance with GAAP. The City presents financial statements which are required by the Division and which differ from the financial statements required by GAAP. These financial statements are listed in the table of contents.

**Comparative Data** - Comparative data for the prior year has been presented in the accompanying balance sheets and statements of operations in order to provide an understanding of changes in the City's financial position and operations. Comparative data is not presented in all statements because their inclusion would make certain statements unduly complex and difficult to understand.

**Reclassifications** - Certain reclassifications have been made to the prior year financial statement presentation to correspond to the current year's format. These reclassifications had no effect on fund balance and changes in fund balance.

**Reconciliation of Accounting Basis** - As described throughout Note A, substantial differences exist between GAAP and the budgetary basis prescribed by the Division. Reconciliation between the two would not be meaningful or informative and therefore is not provided herein.

**NOTE B. CASH AND CASH EQUIVALENTS**

**DEPOSITS**

The City's cash and cash equivalents on deposit are partially insured by the FDIC up to \$250,000 for each depository. Deposits in excess of FDIC limits, as noted below, are insured or collateralized by a collateral pool maintained by public depositories as required by GUDPA (see Note A - Cash and Investments) or are on deposit with the New Jersey Cash Management Fund or Municipal Investors Service Corporation.

**Custodial Credit Risk** - Custodial credit risk is the risk that, in the event of a bank failure, the City will not be able to recover deposits or collateral securities that are in the possession of an outside party. The City does not have a deposit policy for custodial credit risk.



**CITY OF JERSEY CITY  
NOTES TO FINANCIAL STATEMENTS**

**DECEMBER 31, 2017 AND 2016**

**NOTE B. CASH AND CASH EQUIVALENTS (continued)**

Deposits are exposed to custodial credit risk if they are not covered by depository insurance and the deposits are:

- a. Uncollateralized.
- b. Collateralized with securities held by the pledging financial institution.
- c. Collateralized with securities held by the pledging financial institution's trust department or agent but not in the City's name.

The City's cash and cash equivalents on deposit at December 31, 2017 and 2016 are summarized in the following table. As of December 31, 2017, 70% of the City's deposits were with one financial institution and the remaining 30% of deposits were distributed among seven financial institutions. As of December 31, 2016, 53% of the City's deposits were with one financial institution, 20% with another and 18% with a third. The remaining 9% of deposits were distributed among five financial institutions.

	At December 31,	
	2017	2016
FDIC Insured	\$ 1,541,460	\$ 1,893,799
GUDPA Insured	238,554,562	241,326,094
New Jersey Cash Management Fund	114,697	113,730
	\$ 240,210,719	\$ 243,333,623

**Foreign Currency Risk** - Foreign currency risk is the risk that changes in exchange rates will adversely affect deposits. None of the City's deposits as of December 31, 2017 and 2016 are known to be held in foreign currency.

**INVESTMENTS**

**Custodial Credit Risk** - In the case of investments, custodial credit risk is the risk that, in the event of failure of the counterparty, the City will not be able to recover the value of its investments or collateral securities in the possession of an outside party. Investments are exposed to custodial credit risk if they are uninsured, are not registered in the City's name and are held by either the counterparty or its trust department or agent, but not in the City's name.

**CITY OF JERSEY CITY  
NOTES TO FINANCIAL STATEMENTS**

**DECEMBER 31, 2017 AND 2016**

**NOTE B. CASH AND CASH EQUIVALENTS (continued)**

INVESTMENTS (continued)

New Jersey statutes permit the City to purchase the following types of securities when authorized by the cash management plan (described in note A):

- ◆ Bonds or other obligations of the United States of America or obligations guaranteed by the United States of America.
- ◆ Government money market mutual funds.
- ◆ Any obligation that a federal agency or a federal instrumentality has issued in accordance with an act of Congress, which security has a maturity date not greater than 397 days from the date of purchase, provided that such obligation bears a fixed rate of interest not dependent on any index or other external factor.
- ◆ Bonds or other obligations of the local unit or bonds or other obligations of school districts of which the local unit is a part or within which the school district is located.
- ◆ Bonds or other obligations having a maturity date not more than 397 days from the date of purchase, approved by the Division of Investment of the Department of the Treasury for investment by local units.
  - Local Finance Notice 2017-24 further authorizes local governments, such as the City, to invest in notes issued by New Jersey municipalities, counties, fire districts and boards of education without prior Division approval, so long as such investments are incorporated into a cash management plan.
  - Debt obligations from the following local government entities are statutorily authorized to be incorporated into a cash management plan without being subject to a 397-day maturity limit: Parking Authorities, Sewerage and Utilities Authorities, County Improvement Authorities, Pollution control Financing Authority, certain Water Commissions, Municipal Port Authorities, Municipal Shared Service Energy Authority as well as bonds issued pursuant to the Local Redevelopment and Housing Law by authorities, redevelopment agencies, municipalities and counties.
- ◆ Local government investment pools.
- ◆ Deposits with the State of New Jersey Cash Management Fund.
- ◆ Agreements for the repurchase of fully collateralized securities if (a) the underlying securities are permitted investments pursuant to the first and third bullets of this section, (b) the custody of collateral is transferred to a third party, (c) the maturity of the agreement is not more than 30 days, (d) the underlying securities are purchased through a public depository and (e) a master repurchase agreement providing for the custody and security of collateral is executed.

**CITY OF JERSEY CITY  
NOTES TO FINANCIAL STATEMENTS**

**DECEMBER 31, 2017 AND 2016**

**NOTE B. CASH AND CASH EQUIVALENTS (continued)**

**Foreign Currency Risk** - Investments are also exposed to the same foreign currency risk as deposits. It is the risk that changes in exchange rates will adversely affect investments. The City does not have any investments denominated in foreign currency as of December 31, 2017 and 2016.

**Interest Rate Risk** – Interest rate risk is the risk that changes in interest rates will adversely affect the fair value of an investment. The City does not have a formal investment policy that limits investment maturities as a means of managing its exposure to fair value losses arising from increasing interest rates.

**Credit Risk** – Credit risk is the risk that an issuer or other counterparty to an investment will not fulfill its obligations. The City does not have an investment policy regarding the management of credit risk.

**Concentration of Credit Risk** - The City places no formal limit on the amount it may invest in any one issuer. New Jersey Statutes limit municipal investments to those specified and summarily identified in the first paragraph of the “Investments” section of this Note. Currently, the City’s only investments consist of deposits in the New Jersey Cash Management Fund and MBIA Municipal Investors Service Corporation, which are both classified as Government Investment Pools.

The City’s investments at December 31, 2017 and 2016 are presented as follows:

Investment Type	Fair Value*	Investment Maturities (in Years)			
		< 1	1 - 5	6 - 10	> 10
At December 31, 2017:					
Government Investment Pools	\$ 114,697	\$ 114,697	\$ -	\$ -	\$ -
At December 31, 2016:					
Government Investment Pools	\$ 113,730	\$ 113,730	\$ -	\$ -	\$ -

\* Short-term investments are carried at cost, which approximates fair value.

Government Investment Pools consists of investments in the New Jersey Cash Management Fund and MBIA Municipal Investors Service Corporation. Because of their liquidity, these investments are classified as cash and cash equivalents on the financial statements of the City. These investments are described in more detail as follows

**CITY OF JERSEY CITY  
NOTES TO FINANCIAL STATEMENTS**

**DECEMBER 31, 2017 AND 2016**

**NOTE B. CASH AND CASH EQUIVALENTS (continued)**

**New Jersey Cash Management Fund** - All investments in the New Jersey Cash Management Fund are governed by the regulations of the State Investment Council, which prescribe specific standards designed to insure the quality of investments and to minimize the risks related to investments. In addition to the Investment Council regulations, the Division of Investment sets further standards for specific investments and monitors the credit of all eligible securities issues on a regular basis. In all the years of the Division of Investment's existence, it has never suffered a default of principal or interest on any short-term security held by it due to the bankruptcy of a securities issuer; nevertheless, the possibility always exists, and for this reason a reserve is being accumulated in the New Jersey Cash Management Fund as additional protection for the other-than-State participants, which includes the City. The City does not own specific identifiable securities, but instead has a net realizable interest in the joint value of the fund. There is no available credit rating for the New Jersey Cash Management Fund. As of December 31, 2017 and 2016, the City had a balance of \$114,697 and \$113,730, respectively, in the New Jersey Cash Management Fund.

**NOTE C. PROPERTY TAXES**

PROPERTY TAX CALENDAR

Property tax revenues are collected in quarterly installments due February 1, May 1, August 1 and November 1. The City annually holds an accelerated tax sale which includes unpaid taxes, as well as assessments and other municipal charges, as of November 11 of the current year.

The amount of tax levied includes not only the amount required in support of the City's annual budget, but also the amounts required in support of the budget of the following entities:

**County Taxes** - The City is responsible for levying, collecting and remitting county taxes for the County of Hudson. Operations is charged for the amount due the County for the year, based upon the ratables required to be certified to the County Board of Taxation by January 10 of the current year. Monies are forwarded to the County quarterly. In addition, operations is charged for the County share of Added and Omitted Taxes certified to the County Board of Taxation by October 10 of the current year, and due to be paid to the County by February 15 of the following year. As of December 31, 2017 and 2016, the City had County taxes payable of \$1,490,205 and \$1,070,539, respectively.

**CITY OF JERSEY CITY  
NOTES TO FINANCIAL STATEMENTS**

**DECEMBER 31, 2017 AND 2016**

**NOTE C. PROPERTY TAXES (continued)**

**School Taxes** - The City is responsible for levying, collecting and remitting school taxes for the local school district. Monies are forwarded to the school district monthly. Operations is charged for the full amount due to operate the local school district, and is based upon the annual County certification of apportionment of levies. As of December 31, 2017 and 2016, the City had no school taxes payable.

**Special Improvement District** - The City is responsible for levying, collecting and remitting Special Improvement District (SID) taxes for the Central Ave SID, Journal Square Restoration Corp. SID, Historic Downtown / Newark Ave SID, McGinley Square Partnership SID and the Jackson Hill Main Street SID. The SID taxes are derived from assessments made upon the members within the SID. Monies are forwarded to the SIDs monthly. As of December 31, 2016 and 2015, the City had on reserve for SIDs \$137,326 and \$208,752, respectively.

**Municipal Open Space Taxes** – In 2017, voters of the City approved a referendum for the collection of an additional \$0.01 per 100 dollars of assessed valuation to be added to the tax levy and dedicated to provide funding for approved open space purposes. Operations is charged for the amount due to the Open Space Trust Fund, based upon the annual County certification of apportionment of levies. The municipal open space tax levied during the years ended December 31, 2017 and 2016 was \$623,000 and \$0-, respectively.

**PROPERTY TAXES RECEIVABLE**

**Reserve for Uncollected Taxes** - Reserve for Uncollected Taxes is a non-spending item of appropriation required by statute to be included in the City's annual budget. This appropriation protects the City from taxes not paid currently by providing assurance that cash collected in the current year will provide sufficient cash flow to meet obligations as they become due. The minimum amount required to be appropriated in the budget is determined on the percentage of collections experiences in the immediate preceding year, unless the three-year average option is chosen. For the years ended December 31, 2017 and 2016, the budgeted reserve for uncollected taxes was \$4,880,770 and \$3,847,492, respectively.

**Delinquent Taxes and Tax Title Liens** - As described in Note A, taxes receivable and tax title liens are realized as revenue when collected. Uncollected receivables are fully reserved, so no provision is made for the uncollectible portions of these taxes. As of December 31, 2017 and 2016, property taxes receivable were \$10,252,653 and \$4,265,328, respectively, and tax title liens receivable were \$37,154, each year.

**CITY OF JERSEY CITY  
NOTES TO FINANCIAL STATEMENTS**

**DECEMBER 31, 2017 AND 2016**

**NOTE C. PROPERTY TAXES (continued)**

**Prepaid Taxes** - Taxes collected in advance are recorded as cash liabilities in the financial statements. Prepaid taxes as of December 31, 2017 and 2016 were \$14,023,865 and \$2,953,483, respectively.

**Tax Overpayments** - Overpaid taxes collected during the year and due to taxpayers either as a refund or tax credit are recorded as cash liabilities in the financial statements. Tax overpayments as of December 31, 2017 and 2016 were \$2,176,043 and \$2,377,608, respectively.

**Property Acquired by Tax Title Lien Liquidation** - The City held its annual accelerated tax sale on December 19, 2017. The value of properties acquired by tax title liens at December 31, 2017 and 2016 were \$1,455,500, each year.

When such property is sold in the manner provided by statute and sales contracts are entered into in lieu of cash sales, a separate account must be maintained for "Sales Contracts Receivable - Property Acquired for Taxes". The value of such receivables at December 31, 2017 and 2016 were \$285,550, each year.

**NOTE D. MUNICIPAL DEBT**

**SUMMARY OF MUNICIPAL DEBT**

The Local Bond Law governs the issuance of bonds to finance general municipal and utility capital expenditures. Most bonds are retired in serial installments within the statutory period of usefulness. Other bonds may be term bonds with sinking fund requirements. Bonds issued by the City are general obligation bonds, backed by the full faith and credit of the City. Bond Anticipation Notes, which are issued to temporarily finance capital projects, must be paid off within ten years or retired by the issuance of bonds.

**Qualified Bonds** - Certain bonds of the City are issued pursuant to the Municipal Qualified Bond Act. Under this act, portions of State Aid revenues are withheld by the State of New Jersey and forwarded directly to paying agents for principal and interest payments of such bonds. The City is responsible to certify maturity schedules of the qualified bonds to the State. Qualified bonds are identified within each of bond schedules that follow. During the years ended December 31, 2017 and 2016, the State of New Jersey paid \$46,019,272 and \$48,039,760, respectively, of qualified bond interest and principal maturities on behalf of the City in lieu of direct State Aid payments to the City.

**CITY OF JERSEY CITY  
NOTES TO FINANCIAL STATEMENTS**

**DECEMBER 31, 2017 AND 2016**

**NOTE D. MUNICIPAL DEBT (continued)**

**School Debt (Included as Obligations of the City)** – In the general election of November 4, 2008, the Jersey City Board of Education was voted to become a Type II School District. As such, statutes require bonds and notes issued and authorized by the Board of Education to be included in the City’s statutory gross debt, but are not obligations of the City. Only the amount of school district debt exceeding the school district’s debt limit, if any, is included in the net debt of the City.

However, prior to the general election of November 4, 2008, including its time as a State-Operated School District from October 4, 1989 through April 17, 2008, the Jersey City Board of Education operated as a Type I school district. Therefore any bonds and notes issued and authorized by the Board of Education prior to November 4, 2008, and still outstanding as of December 31, 2017 and 2016, remain general obligations of the City.

**Statutory Debt** - At December 31, 2017 and 2016, the City’s statutory debt as defined by the Local Bond Law is summarized as follows:

**Statutory Debt Pursuant to Local Bond Law**

	Dec. 31, 2017			Dec. 31, 2016
	Issued and Outstanding	Authorized but Note Issued	Total	Total
<b>Issued:</b>				
<b>General:</b>				
General Improvement Bonds	\$ 352,980,000	\$ 27,749,629	\$ 380,729,629	\$ 416,676,629
Green Trust Loans	950,779	-	950,779	1,056,405
Bond Anticipation Notes	24,901,000	-	24,901,000	26,898,194
Local Improvement Bonds	11,226,000	-	11,226,000	11,821,000
Water Improvement Bonds	21,150,000	-	21,150,000	27,051,658
School Improvement Bonds	20,830,000	1,587,258	22,417,258	28,742,258
Pension Refunding Bonds	36,710,000	-	36,710,000	38,365,000
Total Gross Statutory Debt Issued	468,747,779	29,336,887	498,084,666	550,611,144
Debt of JCMUA Guaranteed by City	150,221,941	-	150,221,941	199,455,227
	618,969,720	29,336,887	648,306,607	750,066,371
<b>Less Statutory Deductions to Debt Limit:</b>				
Debt of JCMUA Guaranteed by City	150,221,941	-	150,221,941	199,455,227
Due from JCMUA for Issued Water Debt	21,150,000	-	21,150,000	27,051,658
Bonds and Notes for School Purposes	20,830,000	1,587,258	22,417,258	28,742,258
NJSA 40A:2-52 Refunding Bonds:				
Pension Refunding	36,710,000	-	36,710,000	38,365,000
<b>Net Statutory Bonds and Notes Issued and Authorized but not Issued</b>	<b>\$ 390,057,779</b>	<b>\$ 27,749,629</b>	<b>\$ 417,807,408</b>	<b>\$ 456,452,228</b>

**CITY OF JERSEY CITY  
NOTES TO FINANCIAL STATEMENTS**

**DECEMBER 31, 2017 AND 2016**

**NOTE D. MUNICIPAL DEBT (continued)**

In addition to the general capital debt shown in the preceding schedule, the City had additional debt which, in accordance with statutes, is not included as part of the City's statutory debt position. All such debt is recorded in the Current Fund and is as follows:

<b>Current Fund Debt</b>	<u>Dec. 31, 2017</u>	<u>Dec. 31, 2016</u>
<u>Issued:</u>		
Emergency Notes (40A:4-55):		
Severance Liabilities	\$ 9,700,000	\$ 14,700,000
Revaluation of Properties	4,000,000	5,000,000
Superstorm Sandy	-	897,496
	<u>\$ 13,700,000</u>	<u>\$ 20,597,496</u>

**Summary of Long-Term Debt** - The following is a summary of changes in long-term debt for the year ended December 31, 2017:

	<u>Balance</u> <u>Dec. 31, 2016</u>	<u>(1)</u> <u>New Issues</u>	<u>(1)</u> <u>Retirements</u>	<u>Balance</u> <u>Dec. 31, 2017</u>	<u>Due by</u> <u>Dec. 31, 2018</u>
School Serial Bonds	\$ 27,155,000	\$ -	\$ 6,325,000	\$ 20,830,000	\$ 4,900,000
General Serial and Term Bonds	390,017,000	-	37,037,000	352,980,000	35,842,000
Pension Refunding Bonds	38,365,000	-	1,655,000	36,710,000	5,275,000
Water Serial Bonds	25,590,000	-	4,440,000	21,150,000	4,600,000
Local Improvement Bond	11,821,000	-	595,000	11,226,000	595,000
Green Trust Loans	1,056,405	-	105,626	950,779	103,239
	<u>\$ 494,004,405</u>	<u>\$ -</u>	<u>\$ 50,157,626</u>	<u>\$ 443,846,779</u>	<u>\$ 51,315,239</u>

The following is a summary of changes in long-term debt for the year ended December 31, 2016:

	<u>Balance</u> <u>Dec. 31, 2015</u>	<u>(1)</u> <u>New Issues</u>	<u>(1)</u> <u>Retirements</u>	<u>Balance</u> <u>Dec. 31, 2016</u>	<u>Due by</u> <u>Dec. 31, 2017</u>
School Serial Bonds	\$ 39,510,000	\$ -	\$ 12,355,000	\$ 27,155,000	\$ 6,325,000
General Serial and Term Bonds	397,630,950	26,777,000	34,390,950	390,017,000	35,982,000
Pension Refunding Bonds	39,775,000	-	1,410,000	38,365,000	1,655,000
Water Serial Bonds	28,645,000	190,000	3,245,000	25,590,000	4,440,000
Local Improvement Bond	-	11,821,000	-	11,821,000	595,000
Green Trust Loans	1,159,951	-	103,546	1,056,405	105,626
	<u>\$ 506,720,901</u>	<u>\$ 38,788,000</u>	<u>\$ 51,504,496</u>	<u>\$ 494,004,405</u>	<u>\$ 49,102,626</u>
Scheduled Amortization			\$ 49,705,546		
Additional Principal Paid on Refunding			<u>1,798,950</u>		
			<u>\$ 51,504,496</u>		

(1) New issues and retirements are shown net of amounts refunded, which are described more fully as follows.



**CITY OF JERSEY CITY  
NOTES TO FINANCIAL STATEMENTS**

**DECEMBER 31, 2017 AND 2016**

**NOTE D. MUNICIPAL DEBT (continued)**

**Debt Refunding** – On July 13, 2017, the City issued General Improvement Refunding Bonds, Taxable Series 2017A, in the amount of \$70,915,000, the proceeds of which, together with premiums of \$1,055,000 refunded \$71,970,000 of the General Improvement ‘Build America’ Bonds, Taxable Series 2010B issued on November 3, 2010 in the original amount of \$84,495,000. Proceeds were also used to pay certain costs associated with the issuance of the bonds.

On May 13, 2016, the City issued General Obligation Refunding Bonds, Series 2016, in the amount of \$32,335,000, consisting of:

- ◆ \$26,000,000 General Improvement Refunding Bonds, Series 2016A, the proceeds of which refunded \$24,418,000 of the callable Qualified General Improvement Bonds, Series 2009 issued on February 10, 2009 in the original amount of \$39,928,000, and \$2,705,950 of the callable Qualified General Improvement Bonds, Series 2009A issued on December 30, 2009 in the original amount of \$3,380,950.
- ◆ \$6,335,000 Water Improvement Refunding Bonds, Series 2016B, the proceeds of which refunded \$6,580,000 of callable Qualified Water Refunding Bonds, Series 2006D issued on March 30, 2006 in the original amount of \$6,660,000.
- ◆ Proceeds were also used to pay certain costs associated with the issuance of the bonds.

On November 2, 2016, the City issued Refunding Bonds consisting of:

- ◆ \$18,635,000 General Improvement Refunding Bonds, Taxable Series 2016A, the proceeds of which refunded \$17,725,000 of the Qualified General Improvement Bonds, Series 2007A issued on April 25, 2007 in the original amount of \$27,680,000.
- ◆ \$3,945,000 Water Refunding Bonds, Taxable Series 2016B, the proceeds of which refunded \$3,755,000 of Qualified Water Refunding Bonds, Series 2007B issued on April 25, 2007 in the original amount of \$10,930,000.
- ◆ Proceeds were also used to pay certain costs associated with the issuance of the bonds.

On November 17, 2016, the City issued \$11,821,000 of Local Improvement Bonds, Series 2016A for the purposes of funding Ordinance No. 01-057 adopted on June 15, 2001 authorizing the Greene Street Local Improvement Project.

The City also renewed or refunded Bond Anticipation Notes in the amount of \$24,901,000. Proceeds of the renewed or refunded notes were used to pay the principal of the maturing notes less statutory minimum payments appropriated through the Current Fund budget. Bond Anticipation Notes are more fully discussed herein.

**CITY OF JERSEY CITY  
NOTES TO FINANCIAL STATEMENTS**

**DECEMBER 31, 2017 AND 2016**

**NOTE D. MUNICIPAL DEBT (continued)**

**BONDS PAYABLE**

**General Serial and Term Bonds Payable** - The City has outstanding at December 31, 2017 and 2016 various general serial and term bonds. The following table, which includes fiscal year adjustment bonds in addition to the general improvement bonds, is a summary of the activity for such debt during the year ended December 31, 2017 and the short term liability for each bond outstanding at year end:

Description	2017 Summary of General Serial Bonds Activity			Balance	Due by
	Balance Dec. 31, 2016	Increase	Decrease	Dec. 31, 2017	Dec. 31, 2018
Qualified Fiscal Year Adjustment Refunding Bonds, Taxable Series 2004D Issued 10/15/2004 for \$5,515,000 Maturing annually from 2004 to 2020 Bearing interest rates of 4.306-5.246%	\$ 1,775,000	\$ -	\$ 410,000	\$ 1,365,000	\$ 430,000
Qualified Fiscal Year Adjustment Refunding Bonds, Taxable Series 2004D Issued 10/15/2004 for \$5,330,000 Maturing annually from 2004 to 2020 Bearing interest rates of 4.306-5.246%	1,710,000	-	395,000	1,315,000	415,000
Qualified Fiscal Year Adjustment Refunding Bonds, Taxable Series 2004D Issued 10/15/2004 for \$6,570,000 Maturing annually from 2004 to 2020 Bearing interest rates of 4.306-5.246%	2,120,000	-	490,000	1,630,000	515,000
Qualified Public Improvement Refunding Bonds, Taxable Series 2006B Issued 3/30/2006 for \$72,595,000 Maturing in one lump sum in 2021 Bearing an interest rate of 5.49%	72,595,000	-	10,425,000	62,170,000	10,280,000
Qualified General Improvement Refunding Bonds, Series 2007A Issued 4/25/2007 for \$27,680,000 Maturing annually from 2014 to 2023 Bearing interest rates of 4-5.55%	4,935,000	-	4,935,000	-	-
Qualified General Improvement Refunding Bonds, Series 2007A Issued 12/7/2007 for \$26,242,000 For funding of Ordinance No. 07-162 Maturing annually on August 1 from 2010 to 2024 Bearing interest rates of 4-4.25%	1,585,000	-	1,585,000	-	-
Qualified General Improvement Bonds Series 2009 Issued 12/29/2009 for \$39,928,000 For funding of Ordinance No. 08-148 Maturing annually on January 15 from 2011 to 2029 Bearing an interest rate of 5%	5,415,000	-	1,725,000	3,690,000	1,805,000

**CITY OF JERSEY CITY  
NOTES TO FINANCIAL STATEMENTS**

**DECEMBER 31, 2017 AND 2016**

**NOTE D. MUNICIPAL DEBT (continued)**

2017 Summary of General Serial Bonds Activity - continued					
Description	Balance Dec. 31, 2016	Increase	Decrease	Balance Dec. 31, 2017	Due by Dec. 31, 2018
Qualified General Improvement HCIA Bonds Series 2009 Issued 12/17/2009 for \$2,000,000 Maturing annually on August 1 from 2010 to 2019 Bearing an interest rate of 8%	\$ 695,000	\$ -	\$ 222,000	\$ 473,000	\$ 232,000
Qualified General Improvement Bonds JCPA Tax Exempt, Series 2009A Issued 12/17/2009 for \$3,380,950 For funding of Ordinance No. 09-109 Maturing annually on July 15 from 2010 to 2029 Bearing interest rates of 4-5%	295,000	-	90,000	205,000	100,000
Qualified General Improvement Bonds JCPA Taxable, Series 2009A For funding of Ordinance No. 09-109 Issued 12/17/2009 for \$1,000,000 Maturing annually on July 15 from 2010 to 2019 Bearing interest rates of 4.75-6.00%	300,000	-	100,000	200,000	100,000
General Improvement Bonds Taxable Series 2010B, Build America Bonds For funding of Ordinance No. 09-068 and 10-081 Issued 11/3/2010 for \$84,495,000 Maturing annually on Nov. 1, 2011-2027 and 2031, 2036, 2040 Bearing interest rates of 3.25-7.25%	80,490,000	-	73,660,000	6,830,000	2,180,000
General Improvement Bonds, Taxable Series 2010C Recovery Zone Economic Development Bonds For funding of Ordinance No. 09-068 and 10-081 Issued 11/3/2010 for \$6,420,000 Maturing annually on Nov. 1, 2021-2025 and 2030, 2035, 2040 Bearing interest rates of 3.25-7.25%	6,420,000	-	-	6,420,000	-
Qualified General Improvement Refunding Bonds, Series 2011A Issued 12/30/2011 for \$11,253,000 To refund Qualified General Improvement Bonds dated 9/1/2003 Maturing annually on Sept. 1, 2012-2019 and 2022 semiannually 2014 Bearing interest rates of 1.75-4.00%	6,775,000	-	50,000	6,725,000	50,000
Qualified General Improvement Bonds, Series 2012 Issued 8/21/2012 for \$24,875,000 For partial funding of Ordinance No. 12-042 Maturing annually on March 1, 2013-2027 Bearing interest rates of 3.00-5.00%	19,555,000	-	1,440,000	18,115,000	1,490,000
Qualified General Improvement Refunding Bonds, Series 2012A Issued 9/6/2012 for \$16,405,000 To refund Qualified General Improvement Bonds dated 5/15/2005 Maturing annually on Sept. 1, 2013-2025 Bearing interest rates of 2.75-4.00%	14,510,000	-	1,425,000	13,085,000	1,480,000

**CITY OF JERSEY CITY  
NOTES TO FINANCIAL STATEMENTS**

**DECEMBER 31, 2017 AND 2016**

**NOTE D. MUNICIPAL DEBT (continued)**

2017 Summary of General Serial Bonds Activity - continued					
Description	Balance Dec. 31, 2016	Increase	Decrease	Balance Dec. 31, 2017	Due by Dec. 31, 2018
Qualified General Improvement Refunding Bonds, Taxable Series 2012C Issued 9/6/2012 for \$4,690,000 Maturing annually on Sept. 1, 2013-2022 and 2033	\$ 4,025,000	\$ -	\$ 170,000	\$ 3,855,000	\$ 170,000
Qualified Public Improvement Refunding Bonds, Taxable Series 2013A Issued 3/20/2013 for \$24,670,000 Maturing annually on Sept. 1, 2014-2020 Bearing interest rates of 0.942-2.723%	10,580,000	-	4,185,000	6,395,000	3,110,000
General Improvement Bonds, Series 2014 Issued 12/11/2014 for \$31,820,000 To Fund Ordinance No. 14.131 Maturing annually on Dec. 1, 2015-2027 Bearing interest rates of 3-5%	27,715,000	-	2,085,000	25,630,000	2,145,000
Qualified General Improvement Refunding Bonds Tax-Exempt Series 2014A Issued 11/20/2014 for \$16,590,000 To refund Qualified General Improvement Bonds dated 11/2/2006 Maturing annually on August 1, 2015-2023 Bearing interest rates of 2-5%	16,410,000	-	2,070,000	14,340,000	2,150,000
Qualified Public Improvement Refunding Bonds, Taxable Series 2014 Issued 11/20/2014 for \$29,945,000 To refund Qualified Public Improvement Refunding Bonds dated 3/30/2006 Maturing annually on Sept. 1, 2015-2022 Bearing interest rates of 0.659-3.286%	29,015,000	-	340,000	28,675,000	350,000
General Improvement Refunding Bonds, Series 2015A Issued 11/25/2015 for \$13,060,000 To refund Qualified Public Improvement Refunding Bonds dated 12/07/2007 Maturing on Feb. 15, 2016 and annually thereafter from 2018-2024 Bearing interest rates of 2.0%-4.0%	12,975,000	-	-	12,975,000	1,630,000
General Improvement Refunding Bonds, Series 2016A Issued 5/13/2016 for \$26,000,000 To refund Qualified General Improvement Bonds dated 2/10/2009 And to refund Qualified General Improvement bonds dated 12/30/2009 Maturing on July 15, 2016 and annually on Jan. 15 from 2020 through 2029 Bearing interest rates of 3.25%-5%	25,620,000	-	-	25,620,000	-
General Improvement Bonds, Series 2016 Issued 6/29/2016 for \$25,867,000 To fund Ordinance No. 16.083 Providing for Various Capital Improvements Maturing annually on July 15 from 2017 through 2029 Bearing interest rates of 2%-4%	25,867,000	-	1,750,000	24,117,000	1,800,000

**CITY OF JERSEY CITY  
NOTES TO FINANCIAL STATEMENTS**

**DECEMBER 31, 2017 AND 2016**

**NOTE D. MUNICIPAL DEBT (continued)**

2017 Summary of General Serial Bonds Activity - continued					
Description	Balance Dec. 31, 2016	Increase	Decrease	Balance Dec. 31, 2017	Due by Dec. 31, 2018
General Improvement Refunding Bonds, Taxable Series 2016A Issued 11/2/2016 for \$18,635,000 To refund Qualified General Improvement Bonds dated 4/25/2007 Maturing annually on Sept.1 from 2017 through 2021 and 2023. Bearing interest rates of 1.137%-2.573%	\$ 18,635,000	\$ -	\$ 400,000	\$ 18,235,000	\$ 5,410,000
General Improvement Refunding Bonds, Taxable Series 2017A (Refunding \$71,970,000 of Build America Bonds, Series 2010B, Issued 11/03/2010 for \$84,495,000 Refunding Ordinance No. 16.133)	-	70,915,000	-	70,915,000	-
	<u>\$ 390,017,000</u>	<u>\$ 70,915,000</u>	<u>\$ 107,952,000</u>	<u>\$ 352,980,000</u>	<u>\$ 35,842,000</u>
Refunded		(70,915,000)	(70,915,000)		
New Debt/ Retired on Refunding		-	(1,055,000)		
Increase and Decrease Net of Refunding		<u>\$ -</u>	<u>\$ 35,982,000</u>		

The following table is a summary of the activity for general serial and term bonds payable during the year ended December 31, 2016 and the short term liability for each bond outstanding at year end:

2016 Summary of General Serial Bonds Activity					
Description	Balance Dec. 31, 2015	Increase	Decrease	Balance Dec. 31, 2016	Due by Dec. 31, 2017
General Qualified Refunding Bonds Issued 12/01/2002 for \$38,020,000 Maturing annually from 2002 to 2016 Bearing interest rates of 5-5.25%	\$ 2,865,000	\$ -	\$ 2,865,000	\$ -	\$ -
Qualified Fiscal Year Adjustment Refunding Bonds, Taxable Series 2004D Issued 10/15/2004 for \$5,515,000 Maturing annually from 2004 to 2020 Bearing interest rates of 4.306-5.246%	2,165,000	-	390,000	1,775,000	410,000
Qualified Fiscal Year Adjustment Refunding Bonds, Taxable Series 2004D Issued 10/15/2004 for \$5,330,000 Maturing annually from 2004 to 2020 Bearing interest rates of 4.306-5.246%	2,085,000	-	375,000	1,710,000	395,000
Qualified Fiscal Year Adjustment Refunding Bonds, Taxable Series 2004D Issued 10/15/2004 for \$6,570,000 Maturing annually from 2004 to 2020 Bearing interest rates of 4.306-5.246%	2,585,000	-	465,000	2,120,000	490,000

**CITY OF JERSEY CITY  
NOTES TO FINANCIAL STATEMENTS**

**DECEMBER 31, 2017 AND 2016**

**NOTE D. MUNICIPAL DEBT (continued)**

2016 Summary of General Serial Bonds Activity - continued					
Description	Balance Dec. 31, 2015	Increase	Decrease	Balance Dec. 31, 2016	Due by Dec. 31, 2017
Qualified Public Improvement Refunding Bonds, Taxable Series 2006B Issued 3/30/2006 for \$72,595,000 Maturing in one lump sum in 2021 Bearing an interest rate of 5.49%	\$ 72,595,000	\$ -	\$ -	\$ 72,595,000	\$ 10,425,000
Qualified Fiscal Year Adjustment Refunding Bonds, Taxable Series 2006E Issued 3/30/2006 for \$27,305,000 Maturing in one lump sum in 2016 Bearing an interest rate of 5.38%	5,190,000	-	5,190,000	-	-
Qualified General Improvement Bonds Series 2006A Issued 11/2/2006 for \$32,163,000 Maturing annually from 2006 to 2023 Bearing interest rates of 4.125-4.25%	2,050,000	-	2,050,000	-	-
Qualified General Improvement Refunding Bonds, Series 2007A Issued 4/25/2007 for \$27,680,000 Maturing annually from 2014 to 2023 Bearing interest rates of 4-5.55%	27,410,000	-	22,475,000	4,935,000	4,935,000
Qualified General Improvement Refunding Bonds, Series 2007A Issued 12/7/2007 for \$26,242,000 For funding of Ordinance No. 07-162 Maturing annually on August 1 from 2010 to 2024 Bearing interest rates of 4-4.25%	3,105,000	-	1,520,000	1,585,000	1,585,000
Qualified General Improvement Bonds Series 2009 Issued 12/29/2009 for \$39,928,000 For funding of Ordinance No. 08-148 Maturing annually on January 15 from 2011 to 2029 Bearing an interest rate of 5%	31,478,000	-	26,063,000	5,415,000	1,725,000
Qualified General Improvement HCLA Bonds Series 2009 Issued 12/17/2009 for \$2,000,000 Maturing annually on August 1 from 2010 to 2019 Bearing an interest rate of 8%	907,000	-	212,000	695,000	222,000
Qualified General Improvement Bonds JCPA Tax Exempt, Series 2009A Issued 12/17/2009 for \$3,380,950 For funding of Ordinance No. 09-109 Maturing annually on July 15 from 2010 to 2029 Bearing interest rates of 4-5%	3,080,950	-	2,785,950	295,000	90,000

**CITY OF JERSEY CITY  
NOTES TO FINANCIAL STATEMENTS**

**DECEMBER 31, 2017 AND 2016**

**NOTE D. MUNICIPAL DEBT (continued)**

2016 Summary of General Serial Bonds Activity - continued					
Description	Balance Dec. 31, 2015	Increase	Decrease	Balance Dec. 31, 2016	Due by Dec. 31, 2017
Qualified General Improvement Bonds JCPA Taxable, Series 2009A For funding of Ordinance No. 09-109 Issued 12/17/2009 for \$1,000,000 Maturing annually on July 15 from 2010 to 2019 Bearing interest rates of 4.75-6.00%	\$ 400,000	\$ -	\$ 100,000	\$ 300,000	\$ 100,000
General Improvement Bonds Taxable Series 2010B, Build America Bonds For funding of Ordinance No. 09-068 and 10-081 Issued 11/3/2010 for \$84,495,000 Maturing annually on Nov. 1, 2011-2027 and 2031, 2036, 2040 Bearing interest rates of 3.25-7.25%	81,730,000	-	1,240,000	80,490,000	1,690,000
General Improvement Bonds, Taxable Series 2010C Recovery Zone Economic Development Bonds For funding of Ordinance No. 09-068 and 10-081 Issued 11/3/2010 for \$6,420,000 Maturing annually on Nov. 1, 2021-2025 and 2030, 2035, 2040 Bearing interest rates of 3.25-7.25%	6,420,000	-	-	6,420,000	-
Qualified General Improvement Refunding Bonds, Series 2011A Issued 12/30/2011 for \$11,253,000 To refund Qualified General Improvement Bonds dated 9/1/2003 Maturing annually on Sept. 1, 2012-2019 and 2022 semiannually 2014 Bearing interest rates of 1.75-4.00%	6,820,000	-	45,000	6,775,000	50,000
Qualified General Improvement Bonds, Series 2012 Issued 8/21/2012 for \$24,875,000 For partial funding of Ordinance No. 12-042 Maturing annually on March 1, 2013-2027 Bearing interest rates of 3.00-5.00%	20,945,000	-	1,390,000	19,555,000	1,440,000
Qualified General Improvement Refunding Bonds, Series 2012A Issued 9/6/2012 for \$16,405,000 To refund Qualified General Improvement Bonds dated 5/15/2005 Maturing annually on Sept. 1, 2013-2025 Bearing interest rates of 2.75-4.00%	15,885,000	-	1,375,000	14,510,000	1,425,000
Qualified General Improvement Refunding Bonds, Taxable Series 2012C Issued 9/6/2012 for \$4,690,000 Maturing annually on Sept. 1, 2013-2022 and 2033	4,190,000	-	165,000	4,025,000	170,000
Qualified Public Improvement Refunding Bonds, Taxable Series 2013A Issued 3/20/2013 for \$24,670,000 Maturing annually on Sept. 1, 2014-2020 Bearing interest rates of 0.942-2.723%	17,145,000	-	6,565,000	10,580,000	4,185,000

**CITY OF JERSEY CITY  
NOTES TO FINANCIAL STATEMENTS**

**DECEMBER 31, 2017 AND 2016**

**NOTE D. MUNICIPAL DEBT (continued)**

2016 Summary of General Serial Bonds Activity - continued					
Description	Balance Dec. 31, 2015	Increase	Decrease	Balance Dec. 31, 2016	Due by Dec. 31, 2017
General Improvement Bonds, Series 2014 Issued 12/11/2014 for \$31,820,000 To Fund Ordinance No. 14.131 Maturing annually on Dec. 1, 2015-2027 Bearing interest rates of 3-5%	\$ 29,755,000	\$ -	\$ 2,040,000	\$ 27,715,000	\$ 2,085,000
Qualified General Improvement Refunding Bonds Tax-Exempt Series 2014A Issued 11/20/2014 for \$16,590,000 To refund Qualified General Improvement Bonds dated 11/2/2006 Maturing annually on August 1, 2015-2023 Bearing interest rates of 2-5%	16,410,000	-		16,410,000	2,070,000
Qualified Public Improvement Refunding Bonds, Taxable Series 2014 Issued 11/20/2014 for \$29,945,000 To refund Qualified Public Improvement Refunding Bonds dated 3/30/2006 Maturing annually on Sept. 1, 2015-2022 Bearing interest rates of 0.659-3.286%	29,355,000	-	340,000	29,015,000	340,000
General Improvement Refunding Bonds, Series 2015A Issued 11/25/2015 for \$13,060,000 To refund Qualified Public Improvement Refunding Bonds dated 12/07/2007 Maturing on Feb. 15, 2016 and annually thereafter from 2018-2024 Bearing interest rates of 2.0%-4.0%	13,060,000	-	85,000	12,975,000	-
General Improvement Refunding Bonds, Series 2016A Issued 5/13/2016 for \$26,000,000 To refund Qualified General Improvement Bonds dated 2/10/2009 And to refund Qualified General Improvement bonds dated 12/30/2009 Maturing on July 15, 2016 and annually on Jan. 15 from 2020 through 2029 Bearing interest rates of 3.25%-5%	-	26,000,000	380,000	25,620,000	-
General Improvement Bonds, Series 2016 Issued 6/29/2016 for \$25,867,000 To fund Ordinance No. 16.083 Providing for Various Capital Improvements Maturing annually on July 15 from 2017 through 2029 Bearing interest rates of 2%-4%	-	25,867,000	-	25,867,000	1,750,000
General Improvement Refunding Bonds, Taxable Series 2016A Issued 11/2/2016 for \$18,635,000 To refund Qualified General Improvement Bonds dated 4/25/2007 Maturing annually on Sept. 1 from 2017 through 2021 and 2023. Bearing interest rates of 1.137%-2.573%	-	18,635,000	-	18,635,000	400,000
	<u>\$ 397,630,950</u>	<u>\$ 70,502,000</u>	<u>\$ 78,115,950</u>	<u>\$ 390,017,000</u>	<u>\$ 35,982,000</u>
Refunded		(43,725,000)	(43,725,000)		
New Debt/ Retired on Refunding		(910,000)	(1,503,950)		
Increase and Decrease Net of Refunding		<u>\$ 25,867,000</u>	<u>\$ 32,887,000</u>		



**CITY OF JERSEY CITY  
NOTES TO FINANCIAL STATEMENTS**

**DECEMBER 31, 2017 AND 2016**

**NOTE D. MUNICIPAL DEBT (continued)**

General Serial and Term Bonds – Sinking Fund Redemption

The General Improvement Bonds dated November 3, 2010 (Series 2010B and 2010C), the Qualified General Improvement Refunding Bonds dated September 6, 2012 (Taxable Series 2012C) and the Taxable Refunding Bonds dated November 2, 2016 (Series 2016A and 2016B) consist partially of term bonds in addition to serial payments. These term bonds are subject to mandatory sinking fund redemption prior to maturity at a redemption price equal to 100% of the principal amount to be redeemed, plus accrued interest thereon to the date fixed for redemption. Following is the sinking fund schedule for each of the term bond payments required for these bonds:

SCHEDULE OF MANDATORY SINKING FUND PAYMENTS

	Series 2010C Term Bonds Maturing			Series 2012C Term Bonds Maturing	Series 2016A-B Term Bonds Maturing	Series 2016B Term Bonds Maturing	TOTAL
	Nov. 1, 2030	Nov. 1, 2035	Nov. 1, 2040	Sept. 1, 2033	Sept. 1, 2023	Sept. 1, 2033	
2022	\$ -	\$ -	\$ -	\$ -	\$ 290,000	\$ -	\$ 290,000
2023	-	-	-	205,000	3,980,000	-	4,185,000
2024	-	-	-	215,000	-	15,000	230,000
2025	-	-	-	225,000	-	15,000	240,000
2026	255,000	-	-	240,000	-	15,000	510,000
2027	265,000	-	-	250,000	-	15,000	530,000
2028	275,000	-	-	265,000	-	15,000	555,000
2029	295,000	-	-	275,000	-	395,000	965,000
2030	305,000	-	-	290,000	-	405,000	1,000,000
2031	-	315,000	-	310,000	-	425,000	1,050,000
2032	-	335,000	-	320,000	-	435,000	1,090,000
2033	-	345,000	-	335,000	-	455,000	1,135,000
2034	-	355,000	-	-	-	-	355,000
2035	-	375,000	-	-	-	-	375,000
2036	-	-	395,000	-	-	-	395,000
2037	-	-	405,000	-	-	-	405,000
2038	-	-	435,000	-	-	-	435,000
2039	-	-	450,000	-	-	-	450,000
2040	-	-	465,000	-	-	-	465,000
Due at Maturity	<u>\$ 1,395,000</u>	<u>\$ 1,725,000</u>	<u>\$ 2,150,000</u>	<u>\$ 2,930,000</u>	<u>\$ 4,270,000</u>	<u>\$ 2,190,000</u>	<u>\$ 14,660,000</u>
				Series 2016A	\$ 3,685,000		
				Series 2016B	585,000		
					<u>\$ 4,270,000</u>		

Term Bond Maturities of Series 2010B 'Build America' Bonds were refunded by 2017A Bonds.

**CITY OF JERSEY CITY  
NOTES TO FINANCIAL STATEMENTS**

**DECEMBER 31, 2017 AND 2016**

**NOTE D. MUNICIPAL DEBT (continued)**

**Build America and Recovery Zone Bonds** - The City has outstanding at December 31, 2017 and 2016 Build America Bonds and Recovery Zone Economic Development Bonds. As part of the American Recovery and Reinvestment Act (ARRA), the City is to receive Federal subsidy payments equal to 35% of the interest payments on Build America Bonds and 45% of the interest payments on Recovery Zone Bonds.

	Outstanding at December 31,		Federal Government Subsidies	
	2017	2016	2017	2016
Build America Bonds	\$ 6,830,000	\$ 80,490,000	\$ 1,768,300	\$ 1,785,824
Recovery Zone Economic Development Bonds	6,420,000	6,420,000	196,503	196,715
	<u>\$ 13,250,000</u>	<u>\$ 86,910,000</u>	<u>\$ 1,964,803</u>	<u>\$ 1,982,539</u>

Original Serial Maturities Dated November 1 of 2021 through 2027 Refunded by 2017A Bonds.

**School Serial Bonds Payable** - The City has outstanding at December 31, 2017 and 2016 various school serial bond debt issues. The following table is a summary of the activity for such debt during the year ended December 31, 2017 and the short term liability for each bond outstanding at year end:

2017 Summary of School Serial Bonds Activity					
Description	Balance Dec. 31, 2016	Increase	Decrease	Balance Dec. 31, 2017	Due by Dec. 31, 2018
Qualified School Bonds, Series 2007A Issued 2/23/2007 for \$17,050,000 Maturing annually on Feb. 15 from 2008 to 2027 Bearing interest rates of 4.425%	\$ 815,000	\$ -	\$ 815,000	\$ -	\$ -
Qualified School Refunding Bonds Taxable Series, 2014B Issued 11/20/2014 for \$22,610,000 To Refund Qualified School Refunding Bonds dated 6/16/2005 Maturing annually on Sept. 1 from 2015 to 2021 Bearing interest rates of 0.659-3.139%	16,590,000	-	5,510,000	11,080,000	4,080,000
School Refunding Bonds, Series 2015B Issued 11/25/2015 for \$9,830,000 To Refund Qualified School Bonds dated 2/23/2007 Maturing on Feb. 15, 2016 and annually thereafter from 2018-2027 Bearing interest rates of 2.0%-4.0%	9,750,000	-	-	9,750,000	820,000
	<u>\$ 27,155,000</u>	<u>\$ -</u>	<u>\$ 6,325,000</u>	<u>\$ 20,830,000</u>	<u>\$ 4,900,000</u>

**CITY OF JERSEY CITY  
NOTES TO FINANCIAL STATEMENTS**

**DECEMBER 31, 2017 AND 2016**

**NOTE D. MUNICIPAL DEBT (continued)**

The following table is a summary of the activity for such debt during the year ended December 31, 2016 and the short term liability for each bond outstanding at year end:

Description	2016 Summary of School Serial Bonds Activity			Balance	Due by
	Balance Dec. 31, 2015	Increase	Decrease	Dec. 31, 2016	Dec. 31, 2017
School Refunding Bonds Issued 12/01/2002 for \$38,505,000 Maturing annually from 2003 to 2016 Bearing interest rates of 5-5.25%	\$ 2,905,000	\$ -	\$ 2,905,000	\$ -	\$ -
Qualified School Refunding Bonds, Series 2007C Issued 4/25/2007 for \$12,645,000 Maturing annually from 2013 to 2016 Bearing an interest rate of 5%	3,130,000		3,130,000	-	-
Qualified School Bonds, Series 2007A Issued 2/23/2007 for \$17,050,000 Maturing annually on Feb. 15 from 2008 to 2027 Bearing interest rates of 4-4.25%	1,600,000	-	785,000	815,000	815,000
Qualified School Refunding Bonds Taxable Series, 2014B Issued 11/20/2014 for \$22,610,000 To Refund Qualified School Refunding Bonds dated 6/16/2005 Maturing annually on Sept. 1 from 2015 to 2021 Bearing interest rates of 0.659-3.139%	22,045,000	-	5,455,000	16,590,000	5,510,000
School Refunding Bonds Series 2015B Issued 11/25/2015 for \$9,830,000 To Refund Qualified School Bonds dated 2/23/2007 Maturing on Feb. 15, 2016 and annually thereafter from 2018-2027 Bearing interest rates of 2.0%-4.0%	9,830,000	-	80,000	9,750,000	-
	<u>\$ 39,510,000</u>	<u>\$ -</u>	<u>\$ 12,355,000</u>	<u>\$ 27,155,000</u>	<u>\$ 6,325,000</u>

**Water Serial Bonds Payable** - The City has outstanding at December 31, 2017 and 2016 various water serial bond debt issues.

The following table is a summary of the activity for such debt during the year ended December 31, 2017 and the short term liability for each bond outstanding at year end:

**CITY OF JERSEY CITY  
NOTES TO FINANCIAL STATEMENTS**

**DECEMBER 31, 2017 AND 2016**

**NOTE D. MUNICIPAL DEBT (continued)**

Description	2017 Summary of Water Serial Bonds Activity			Balance Dec. 31, 2017	Due by Dec. 31, 2018
	Balance Dec. 31, 2016	Increase	Decrease		
Qualified Water Refunding Bonds, Series 2007B Issued 4/25/2007 for \$10,930,000 Maturing annually from 2010 to 2023 and 2033 Bearing interest rates of 4-5%	\$ 235,000	\$ -	\$ 235,000	\$ -	\$ -
Qualified Water Improvement Refunding Bonds, Series 2011B Issued 12/30/2011 for \$1,987,000 Maturing annually: 2012-2019, 2022, 2024-2028; semiannually 2014 Bearing interest rates of 1.75-4.00%	1,690,000	-	10,000	1,680,000	10,000
Qualified Water Improvement Refunding Bonds, Series 2012B Issued 9/6/12 for \$4,265,000 To refund Water Capital Improvement Bonds dated 3/1/2003 and Qualified Water Improvement Bonds dated 5/15/2005 Maturing annually: 2013-2024 Bearing interest rates of 2.75-4.00%	4,170,000	-	625,000	3,545,000	710,000
Qualified Water Improvement Refunding Bonds, Series 2013B Issued 3/20/2013 for \$12,050,000 To refund Qualified Water Refunding Bonds dated 10/15/2005 Maturing annually: 2014-2021 Bearing interest rates of 0.942-3.055%	7,300,000	-	2,180,000	5,120,000	2,225,000
Qualified Water Improvement Refunding Bonds, Series 2014A Issued 11/20/14 for \$1,990,000 To Refund Qualified Water Improvement Bonds dated 11/2/2006 Maturing annually on Aug. 1 from 2015 to 2021 Bearing interests of 2-4%	1,965,000	-	365,000	1,600,000	380,000
Water Improvement Refunding Bonds, Series 2016B Issued 5/13/16 for \$6,335,000 To Refund Qualified Water Refunding Bonds dated 3/30/2006 Maturing annually on Jan. 15 from 2017 to 2022 Bearing interests of 2-5%	6,285,000	-	965,000	5,320,000	1,000,000
Water Refunding Bonds, Taxable Series 2016B Issued 11/2/16 for \$3,945,000 To Refund Qualified Water Refunding Bonds dated 4/25/2007 Maturing annually on Sept. 1 from 2017 to 2021 and 2023. Bearing interests of 1.137-3.758%	3,945,000	-	60,000	3,885,000	275,000
	\$ 25,590,000	\$ -	\$ 4,440,000	\$ 21,150,000	\$ 4,600,000

**CITY OF JERSEY CITY  
NOTES TO FINANCIAL STATEMENTS**

**DECEMBER 31, 2017 AND 2016**

**NOTE D. MUNICIPAL DEBT (continued)**

The following table is a summary of the activity for such debt during the year ended December 31, 2016 and the short term liability for each bond outstanding at year end:

Description	2016 Summary of Water Serial Bonds Activity			Balance Dec. 31, 2016	Due by Dec. 31, 2017
	Balance Dec. 31, 2015	Increase	Decrease		
Qualified Water Refunding Bonds, Series 2006D Issued 9/1/2005 for \$6,660,000 Maturing annually from 2016 to 2022 Bearing interest rates of 4.1-4.125%	\$ 6,660,000	\$ -	\$ 6,660,000	\$ -	\$ -
Qualified Water Improvement Bonds, Series 2006B Issued 11/2/2006 for \$5,000,000 Maturing annually from 2007 to 2021 Bearing interest rates of 4.125-4.25%	355,000	-	355,000	-	-
Qualified Water Refunding Bonds, Series 2007B Issued 4/25/2007 for \$10,930,000 Maturing annually from 2010 to 2023 and 2033 Bearing interest rates of 4-5%	4,010,000	-	3,775,000	235,000	235,000
Qualified Water Improvement Refunding Bonds, Series 2011B Issued 12/30/2011 for \$1,987,000 Maturing annually: 2012-2019, 2022, 2024-2028; semiannually 2014 Bearing interest rates of 1.75-4.00%	1,910,000	-	220,000	1,690,000	10,000
Qualified Water Improvement Refunding Bonds, Series 2012B Issued 9/6/12 for \$4,265,000 To refund Water Capital Improvement Bonds dated 3/1/2003 and Qualified Water Improvement Bonds dated 5/15/2005 Maturing annually: 2013-2024 Bearing interest rates of 2.75-4.00%	4,195,000	-	25,000	4,170,000	625,000
Qualified Water Improvement Refunding Bonds, Series 2013B Issued 3/20/2013 for \$12,050,000 To refund Qualified Water Refunding Bonds dated 10/15/2005 Maturing annually: 2014-2021 Bearing interest rates of 0.942-3.055%	9,550,000	-	2,250,000	7,300,000	2,180,000
Qualified Water Improvement Refunding Bonds, Series 2014A Issued 11/20/14 for \$1,990,000 To Refund Qualified Water Improvement Bonds dated 11/2/2006 Maturing annually on Aug. 1 from 2015 to 2021 Bearing interests of 2-4%	1,965,000	-	-	1,965,000	365,000

**CITY OF JERSEY CITY  
NOTES TO FINANCIAL STATEMENTS**

**DECEMBER 31, 2017 AND 2016**

**NOTE D. MUNICIPAL DEBT (continued)**

2016 Summary of Water Serial Bonds Activity - continued

Description	Balance Dec. 31, 2015	Increase	Decrease	Balance Dec. 31, 2016	Due by Dec. 31, 2017
Water Improvement Refunding Bonds, Series 2016B Issued 5/13/16 for \$6,335,000 To Refund Qualified Water Refunding Bonds dated 3/30/2006 Maturing annually on Jan. 15 from 2017 to 2022 Bearing interests of 2-5%	-	6,335,000	50,000	6,285,000	965,000
Water Refunding Bonds, Taxable Series 2016B Issued 11/2/16 for \$3,945,000 To Refund Qualified Water Refunding Bonds dated 4/25/2007 Maturing annually on Sept. 1 from 2017 to 2021 and 2023. Bearing interests of 1.137-3.758%	-	3,945,000	-	3,945,000	60,000
	<u>\$ 28,645,000</u>	<u>\$ 10,280,000</u>	<u>\$ 13,335,000</u>	<u>\$ 25,590,000</u>	<u>\$ 4,440,000</u>
Refunded		(10,090,000)	(10,090,000)		
New Debt/ Retired on Refunding		(190,000)	(295,000)		
Increase and Decrease Net of Refunding		<u>\$ -</u>	<u>\$ 2,950,000</u>		

**Local Improvement Bonds Payable** - The City has outstanding at December 31, 2017 and 2016 a bond issued for the Greene Street Local Improvement Project. The following table is a summary of the activity for such debt during the year ended December 31, 2017 and the short term liability outstanding at year end:

2017 Summary of Local Improvement Bonds Activity

Description	Balance Dec. 31, 2016	Increase	Decrease	Balance Dec. 31, 2017	Due by Dec. 31, 2018
Local Improvement Bonds, Taxable Series 2016A (Funding of Ordinance No. 01-057) Maturing annually from 2018 to 2036 Bearing interests of 3.00-4.25%	\$ 11,821,000	\$ -	\$ 595,000	\$ 11,226,000	\$ 595,000
	<u>\$ 11,821,000</u>	<u>\$ -</u>	<u>\$ 595,000</u>	<u>\$ 11,226,000</u>	<u>\$ 595,000</u>

The following table is a summary of the activity for such debt during the year ended December 31, 2016 and the short term liability outstanding at year end:

2016 Summary of Local Improvement Bonds Activity

Description	Balance Dec. 31, 2015	Increase	Decrease	Balance Dec. 31, 2016	Due by Dec. 31, 2017
Pension Obligation Refunding Bonds Series 2003A, Taxable Issued 1/15/2003 for \$23,595,000 Maturing annually from 2012 to 2024 Bearing interest rates of 4.8-5.5%	\$ -	\$ 11,821,000	\$ -	\$ 11,821,000	\$ 595,000
	<u>\$ -</u>	<u>\$ 11,821,000</u>	<u>\$ -</u>	<u>\$ 11,821,000</u>	<u>\$ 595,000</u>

**CITY OF JERSEY CITY  
NOTES TO FINANCIAL STATEMENTS**

**DECEMBER 31, 2017 AND 2016**

**NOTE D. MUNICIPAL DEBT (continued)**

**Pension Refunding Bonds Payable** - The City has outstanding at December 31, 2017 and 2016 various pension refunding bond debt issues. The following table summarizes the activity of such debt during the year ended December 31, 2017 and the short term liability for each bond outstanding at year end:

2017 Summary of Pension Refunding Bonds Activity					
Description	Balance			Balance	
	Dec. 31, 2016	Increase	Decrease	Dec. 31, 2017	Due by Dec. 31, 2018
Pension Obligation Refunding Bonds Series 2003A, Taxable Issued 1/15/2003 for \$23,595,000 Maturing annually from 2012 to 2024 Bearing interest rates of 4.8-5.5%	\$ 18,100,000	\$ -	\$ 1,430,000	\$ 16,670,000	\$ 1,655,000
Pension Obligation Refunding Bonds Series 2003A, Taxable Issued 3/15/2003 for \$17,465,000 Maturing annually from 2012 to 2033 Bearing interest rates of 4.58-5.46%	16,920,000	-	225,000	16,695,000	275,000
Pension Obligation Refunding Bonds Series 2006, Taxable Issued 3/22/2006 for \$3,345,000 Maturing in one lump sum in 2018 Bearing an interest rate of 5.51%	3,345,000	-	-	3,345,000	3,345,000
	<u>\$ 38,365,000</u>	<u>\$ -</u>	<u>\$ 1,655,000</u>	<u>\$ 36,710,000</u>	<u>\$ 5,275,000</u>

The following table is a summary of the activity for such debt during the year ended December 31, 2016 and the short term liability for each bond outstanding at year end:

2016 Summary of Pension Refunding Bonds Activity					
Description	Balance			Balance	
	Dec. 31, 2015	Increase	Decrease	Dec. 31, 2016	Due by Dec. 31, 2017
Pension Obligation Refunding Bonds Series 2003A, Taxable Issued 1/15/2003 for \$23,595,000 Maturing annually from 2012 to 2024 Bearing interest rates of 4.8-5.5%	\$ 19,325,000	\$ -	\$ 1,225,000	\$ 18,100,000	\$ 1,430,000
Pension Obligation Refunding Bonds Series 2003A, Taxable Issued 3/15/2003 for \$17,465,000 Maturing annually from 2012 to 2033 Bearing interest rates of 4.58-5.46%	17,105,000	-	185,000	16,920,000	225,000
Pension Obligation Refunding Bonds Series 2006, Taxable Issued 3/22/2006 for \$3,345,000 Maturing in one lump sum in 2018 Bearing an interest rate of 5.51%	3,345,000	-	-	3,345,000	-
	<u>\$ 39,775,000</u>	<u>\$ -</u>	<u>\$ 1,410,000</u>	<u>\$ 38,365,000</u>	<u>\$ 1,655,000</u>

**CITY OF JERSEY CITY  
NOTES TO FINANCIAL STATEMENTS**

**DECEMBER 31, 2017 AND 2016**

**NOTE D. MUNICIPAL DEBT (continued)**

**LOANS PAYABLE**

**Green Trust Loans** - The City has outstanding at December 31, 2017 and 2016 various Green Trust Loans. The following table summarizes such loan activity for the year ended December 31, 2017 and the short term liability for each loan outstanding at year end:

Description	2017 Summary of Green Trust Loans Activity			Balance Dec. 31, 2017	Due by Dec. 31, 2018
	Balance Dec. 31, 2016	Increase	Decrease		
Wayne Street Park Loan Received 7/29/1998 - \$142,000 Due semi-annually until 2018 Bearing an interest rate of 2%	\$ 13,263	\$ -	\$ 8,798	\$ 4,465	\$ 4,465
Apple Tree House Loan Received 7/07/2004 - \$235,894 Due semi-annually until 2024 Bearing an interest rate of 2%	101,691	-	12,698	88,993	12,953
Sgt. Anthony's Park Project Loan Received 7/08/2005 - \$145,000 Due semi-annually until 2025 Bearing an interest rate of 2%	70,158	-	7,652	62,506	7,805
Roberto Clemente Park Project Loan Received 7/08/2005 - \$284,000 Due semi-annually until 2025 Bearing an interest rate of 2%	137,414	-	14,986	122,428	15,288
Marion Pavonia Pool Project Loan Received 7/08/2005 - \$425,000 Due semi-annually until 2025 Bearing an interest rate of 2%	205,637	-	22,427	183,210	22,878
Multi-Park Loan Received 6/30/2009 - \$615,000 Due semi-annually until 2028 Bearing an interest rate of 2%	406,203	-	30,269	375,934	30,878
Montgomery Gateway Loan Received 6/30/2009 - \$50,000 Due semi-annually until 2028 Bearing an interest rate of 2%	33,025	-	2,461	30,564	2,510
Berry Lane Park Loan Received 6/30/2010 - \$130,000 Due semi-annually until 2029 Bearing an interest rate of 2%	89,014	-	6,335	82,679	6,462
	-	-	-	-	-
	<u>\$ 1,056,405</u>	<u>\$ -</u>	<u>\$ 105,626</u>	<u>\$ 950,779</u>	<u>\$ 103,239</u>



**CITY OF JERSEY CITY  
NOTES TO FINANCIAL STATEMENTS**

**DECEMBER 31, 2017 AND 2016**

**NOTE D. MUNICIPAL DEBT (continued)**

The following table summarizes such loan activity for the year ended December 31, 2016 and the short term liability for each loan outstanding at year end:

Description	2016 Summary of Green Trust Loans Activity			Balance	Due by
	Balance Dec. 31, 2015	Increase	Decrease	Dec. 31, 2016	Dec. 31, 2017
Wayne Street Park Loan Received 7/29/1998 - \$142,000 Due semi-annually until 2018 Bearing an interest rate of 2%	\$ 21,888	\$ -	\$ 8,625	\$ 13,263	\$ 8,798
Apple Tree House Loan Received 7/07/2004 - \$235,894 Due semi-annually until 2024 Bearing an interest rate of 2%	114,139	-	12,448	101,691	12,698
Sgt. Anthony's Park Project Loan Received 7/08/2005 - \$145,000 Due semi-annually until 2025 Bearing an interest rate of 2%	77,659	-	7,501	70,158	7,652
Roberto Clemente Park Project Loan Received 7/08/2005 - \$284,000 Due semi-annually until 2025 Bearing an interest rate of 2%	152,105	-	14,691	137,414	14,986
Marion Pavonia Pool Project Loan Received 7/08/2005 - \$425,000 Due semi-annually until 2025 Bearing an interest rate of 2%	227,622	-	21,985	205,637	22,427
Multi-Park Loan Received 6/30/2009 - \$615,000 Due semi-annually until 2028 Bearing an interest rate of 2%	435,876	-	29,673	406,203	30,269
Montgomery Gateway Loan Received 6/30/2009 - \$50,000 Due semi-annually until 2028 Bearing an interest rate of 2%	35,437	-	2,412	33,025	2,461
Berry Lane Park Loan Received 6/30/2010 - \$130,000 Due semi-annually until 2029 Bearing an interest rate of 2%	95,225	-	6,211	89,014	6,335
	\$ 1,159,951	\$ -	\$ 103,546	\$ 1,056,405	\$ 105,626

**CITY OF JERSEY CITY  
NOTES TO FINANCIAL STATEMENTS**

**DECEMBER 31, 2017 AND 2016**

**NOTE D. MUNICIPAL DEBT (continued)**

**DEBT SERVICE REQUIREMENTS TO MATURITY**

The repayment schedule of annual debt service principal and interest for the next five years, and five-year increments there-after, for bonds and loans issued and outstanding is as follows:

Schedule of Debt Service Requirements to Maturity - Combined Principal and Interest as of December 31, 2017

Year	Loans	Bonds Issued and Outstanding				
	Issued and Outstanding	Total Bonds	Local Imp. & General Bonds	Pension Refunding	School Serial Bonds	Water Serial Bonds
2018	\$ 121,719	\$ 71,713,498	\$ 53,668,057	\$ 7,233,435	\$ 5,561,763	\$ 5,250,243
2019	117,209	71,563,063	58,544,985	3,880,375	5,256,763	3,880,940
2020	117,209	75,193,726	64,349,812	4,021,257	2,869,646	3,953,011
2021	117,209	71,347,663	60,964,114	4,166,738	2,788,848	3,427,963
2022	117,209	45,427,172	37,898,854	4,354,641	1,188,150	1,985,527
2023-2027	401,943	138,556,822	116,108,042	13,544,121	5,916,625	2,988,034
2028-2032	53,478	66,142,187	53,071,354	10,719,604	-	2,351,229
2033-2037	-	39,956,590	36,870,012	2,614,479	-	472,099
2038-2040	-	18,842,888	18,842,888	-	-	-
	<u>\$ 1,045,976</u>	<u>\$ 598,743,609</u>	<u>\$ 500,318,118</u>	<u>\$ 50,534,650</u>	<u>\$ 23,581,795</u>	<u>\$ 24,309,046</u>
Principal	\$ 950,779	\$ 442,896,000	\$ 364,206,000	\$ 36,710,000	\$ 20,830,000	\$ 21,150,000
Interest	95,197	155,847,609	136,112,118	13,824,650	2,751,795	3,159,046
	<u>\$ 1,045,976</u>	<u>\$ 598,743,609</u>	<u>\$ 500,318,118</u>	<u>\$ 50,534,650</u>	<u>\$ 23,581,795</u>	<u>\$ 24,309,046</u>

**NOTES PAYABLE**

**Bond Anticipation Notes** - The City issues bond anticipation notes to temporarily fund various capital projects prior to the issuance of serial bonds. The term of the notes cannot exceed one year, but the notes may be renewed from time to time for a period not exceeding one year. Generally, such notes may be paid no later than the close of the tenth fiscal year next following the date of the original notes.

The Division also prescribes that notes cannot be renewed past the third anniversary date of the original note unless an amount equal to at least the first legally required installment is paid prior to each anniversary date.

**CITY OF JERSEY CITY  
NOTES TO FINANCIAL STATEMENTS**

**DECEMBER 31, 2017 AND 2016**

**NOTE D. MUNICIPAL DEBT (continued)**

The following is a schedule of bond anticipation note activity for the year ended December 31, 2017.

Ordinance Number	Original Issue:		Interest Rate %	Date of Maturity	Balance Dec. 31, 2016	Notes Issued	Notes Refunded	Budget Appropriation	Balance Dec. 31, 2017
	Date	Amount							
<b>PJP Landfill Acquisition</b>									
09-097	01/20/10	\$ 8,700,000	2.250%	01/19/18	\$ -	\$ -	\$ 8,142,948	\$ -	\$ 8,142,948
09-097	01/20/10	8,700,000	1.500%	01/20/17	8,253,948	-	(8,142,948)	111,000	-
<b>Newark Avenue Streetscape</b>									
09-127	01/20/10	2,476,000	2.250%	01/19/18	-	-	1,823,052	-	1,823,052
09-127	01/20/10	2,476,000	1.500%	01/20/17	1,954,052	-	(1,823,052)	131,000	-
<b>Sixth Street Embankment</b>									
10-085	08/31/10	7,500,000	1.875%	06/22/18	-	-	6,955,000	-	6,955,000
10-085	08/31/10	7,500,000	1.500%	06/23/17	7,085,000	-	(6,955,000)	130,000	-
<b>W. Campus Redevelopment</b>									
16.106	12/08/16	4,135,000	2.500%	12/07/18	-	-	4,135,000	-	4,135,000
16.106	12/08/16	4,135,000	1.150%	12/08/17	4,135,000	-	(4,135,000)	-	-
<b>Hurricane Sandy Recovery</b>									
13.031	12/12/13	8,717,417	2.500%	12/07/18	-	-	3,845,000	-	3,845,000
13.031	12/12/13	8,717,417	1.150%	12/08/17	5,470,194	-	(3,845,000)	1,625,194	-
					<b>\$ 26,898,194</b>	<b>\$ -</b>	<b>\$ -</b>	<b>\$ 1,997,194</b>	<b>\$ 24,901,000</b>

The following is a schedule of bond anticipation note activity for the year ended December 31, 2016.

Ordinance Number	Original Issue:		Interest Rate %	Date of Maturity	Balance Dec. 31, 2015	Notes Issued	Notes Refunded	Budget Appropriation	Bonds Issued	Balance Dec. 31, 2016
	Date	Amount								
<b>PJP Landfill Acquisition</b>										
09-097	01/20/10	\$ 8,700,000	1.75%	12/11/16	\$ 8,364,948	\$ -	\$ (8,253,948)	\$ 111,000	\$ -	\$ -
09-097	01/20/10	8,700,000	1.50%	01/20/17	-	-	8,253,948	-	-	8,253,948
<b>Newark Avenue Streetscape</b>										
09-127	01/20/10	2,476,000	1.75%	12/11/16	2,085,052	-	(1,954,052)	131,000	-	-
09-127	01/20/10	2,476,000	1.50%	01/20/17	-	-	1,954,052	-	-	1,954,052
<b>Sixth Street Embankment</b>										
10-085	08/31/10	7,500,000	1.15%	07/06/16	7,215,000	-	(7,085,000)	130,000	-	-
10-085	08/31/10	7,500,000	1.50%	06/23/17	-	-	7,085,000	-	-	7,085,000
<b>Greene Street</b>										
01-057A	12/11/15	11,821,160	1.50%	12/09/16	11,821,159	-	-	159	11,821,000	-
<b>W. Campus Redevelopment</b>										
16.106	12/08/16	4,135,000	1.15%	12/08/17	-	4,135,000	-	-	-	4,135,000
<b>Hurricane Sandy Recovery</b>										
13.031	12/12/13	1,282,583	1.50%	12/09/16	1,282,583	-	-	1,282,583	-	-
13.031	12/12/13	8,717,417	1.00%	12/09/16	7,095,360	-	(5,470,194)	1,625,166	-	-
13.031	12/12/13	8,717,417	1.15%	12/08/17	-	-	5,470,194	-	-	5,470,194
					<b>\$ 37,864,102</b>	<b>\$ 4,135,000</b>	<b>\$ -</b>	<b>\$ 3,279,908</b>	<b>\$ 11,821,000</b>	<b>\$ 26,898,194</b>

**CITY OF JERSEY CITY  
NOTES TO FINANCIAL STATEMENTS**

**DECEMBER 31, 2017 AND 2016**

**NOTE D. MUNICIPAL DEBT (continued)**

**Landfill and Streetscape** – On January 20, 2010, the City issued Bond Anticipation Notes in the amount of \$11,176,000 to fund two separate authorizations: the acquisition of the PJP Landfill for \$8,700,000 and the Newark Ave Streetscape for \$2,476,000, as authorized by Ordinance No. 09-127.

**Sixth Street Embankment** – On August 31, 2010, the City issued Bond Anticipation Notes in the amount of \$7,500,000 to fund costs to obtain the property known as the Sixth Street in accordance with a legal settlement of January, 2010, as authorized by Ordinance No. 10-085.

**Hurricane Sandy Recovery** – On December 12, 2013, the City issued Bond Anticipation Notes in the amount of \$10,000,000 to fund costs associated with efforts to recover, repair or replace streets, roads and other public property lost or damaged in Hurricane Sandy, as authorized by Ordinance No. 13.031.

**Greene Street Improvements** – On December 11, 2015, the City issued Bond Anticipation Notes in the amount of \$11,821,159 to fund costs associated with the undertaking of various public improvements to Greene Street as authorized by Ordinance No. 01-057.

**Tax Refunding Notes** - The City issues tax refunding notes in order to finance tax refunds arising from successful appeals by property owners. Taxpayers are obligated to pay taxes owed to the City as they become due, or have their property subject to tax sale. However, taxpayers may appeal their property assessments and, if successful, be granted a refund, often in a year subsequent to when the taxes were paid. The Division has allowed the City to issue notes to finance such refunds. The tax refunding notes are one year notes, renewable annually for five to seven years.

The City had no tax refunding notes outstanding as of December 31, 2017. The following is a schedule of tax refunding note activity for the year ended December 31, 2016.

Ordinance Number	Original Issue:		Interest Rate %	Date of Maturity	Balance Dec. 31, 2015	Budget Appropriation	Balance Dec. 31, 2016
	Date	Amount					
Refunding Notes (Real Property Tax Appeal)							
09-028	06/25/09	\$ 11,471,819	1.00%	04/14/16	\$ 1,638,740	\$ 1,638,740	\$ -
11-116	12/14/11	5,500,000	1.50%	12/09/16	1,100,000	1,100,000	-
					<u>\$ 2,738,740</u>	<u>\$ 2,738,740</u>	<u>\$ -</u>

**CITY OF JERSEY CITY  
NOTES TO FINANCIAL STATEMENTS**

**DECEMBER 31, 2017 AND 2016**

**NOTE D. MUNICIPAL DEBT (continued)**

**Special Emergency Notes** - Statutes allow the City to adopt ordinances authorizing special emergency appropriations for the carrying out of certain specific purposes, including the revaluation of real property and contractually required severance liabilities resulting from the layoff or retirement of employees. Statutes further provide for the borrowing of money and the issuance of Special Emergency Notes to finance such special emergency appropriations, which may be renewed from time to time, but at least 1/5 of all such notes, and the renewals thereof, shall mature and be paid in each year, so that all notes and renewals shall have matured and have been paid not later than the last day of the fifth year following the date of the emergency resolution.

The following is a schedule of special emergency note activity for the year ended December 31, 2017.

Ordinance Number	Original Issue:		Interest Rate %	Date of Maturity	Balance Dec. 31, 2016	Notes Refunded	Budget Appropriation	Balance Dec. 31, 2017
	Date	Amount						
<b>Contractual Severance Payments</b>								
13-118	12/12/13	9,500,000	2.35%	12/07/18	-	1,900,000	-	1,900,000
13-118	12/12/13	9,500,000	1.25%	12/08/17	3,800,000	(1,900,000)	1,900,000	-
14-132	12/12/14	7,500,000	2.35%	12/07/18	-	3,000,000	-	3,000,000
14-132	12/12/14	7,500,000	1.25%	12/08/17	4,500,000	(3,000,000)	1,500,000	-
15.149	12/11/15	8,000,000	2.35%	12/07/18	-	4,800,000	-	4,800,000
15.149	12/11/15	8,000,000	1.25%	12/08/17	6,400,000	(4,800,000)	1,600,000	-
<b>Revaluation of Properties</b>								
16.031	12/08/16	5,000,000	2.50%	12/07/18	-	4,000,000	-	4,000,000
16.031	12/08/16	5,000,000	1.15%	12/08/17	5,000,000	(4,000,000)	1,000,000	-
<b>Hurricane Sandy Recovery</b>								
12-841	12/28/12	5,965,000	1.15%	12/08/17	897,496	-	897,496	-
					<b>\$ 20,597,496</b>	<b>\$ -</b>	<b>\$ 6,897,496</b>	<b>\$ 13,700,000</b>

**CITY OF JERSEY CITY  
NOTES TO FINANCIAL STATEMENTS**

**DECEMBER 31, 2017 AND 2016**

**NOTE D. MUNICIPAL DEBT (continued)**

The following is a schedule of special emergency note activity for the year ended December 31, 2016.

Ordinance Number	Original Issue:		Interest Rate %	Date of Maturity	Balance Dec. 31, 2015	Notes Issued	Notes Refunded	Budget Appropriation	Balance Dec. 31, 2016
	Date	Amount							
<b>Contractual Severance Payments</b>									
11-124	12/14/11	\$ 9,500,000	1.50%	12/09/16	\$ 1,900,000	\$ -	\$ -	\$ 1,900,000	\$ -
13-118	12/12/13	9,500,000	1.50%	12/09/16	5,700,000	-	(3,800,000)	1,900,000	-
13-118	12/12/13	9,500,000	1.25%	12/08/17	-	-	3,800,000	-	3,800,000
14-132	12/12/14	7,500,000	1.50%	12/09/16	6,000,000	-	(4,500,000)	1,500,000	-
14-132	12/12/14	7,500,000	1.25%	12/08/17	-	-	4,500,000	-	4,500,000
15.149	12/11/15	8,000,000	1.50%	12/09/16	8,000,000	-	(6,400,000)	1,600,000	-
15.149	12/11/15	8,000,000	1.25%	12/08/17	-	-	6,400,000	-	6,400,000
<b>Revaluation of Properties</b>									
11-043	06/23/11	3,150,000	1.00%	04/14/16	630,000	-	-	630,000	-
16.031	12/08/16	5,000,000	1.15%	12/08/17	-	5,000,000	-	-	5,000,000
<b>Hurricane Sandy Recovery</b>									
12-841	12/28/12	5,965,000	1.00%	12/09/16	1,794,992	-	(897,496)	897,496	-
12-841	12/28/12	5,965,000	1.15%	12/08/17	-	-	897,496	-	897,496
					<b>\$ 24,024,992</b>	<b>\$ 5,000,000</b>	<b>\$ -</b>	<b>\$ 8,427,496</b>	<b>\$ 20,597,496</b>

**Contractual Severance Liabilities** – The City has passed various special emergency appropriations for the purposes of funding contractually required severance liabilities resulting from the retirement of City employees as allowed by N.J.S.A. 40A:4-53h.

**Revaluation of Properties** – The City passed Ordinance No. 11-043 to provide for the preparation and execution of a complete program of revaluation of real property for the use of the local assessor. This special emergency appropriation is authorized by N.J.S.A. 40A:4-53b.

**Sandy (Natural Disaster)** – The City passed Resolution No. 12-842 to provide for the funding of various costs associated with damages sustained from Superstorm Sandy. This special emergency appropriation is authorized as an extraordinary expense by N.J.S.A. 40A:4-54.

**CITY OF JERSEY CITY  
NOTES TO FINANCIAL STATEMENTS**

**DECEMBER 31, 2017 AND 2016**

**NOTE D. MUNICIPAL DEBT (continued)**

**BONDS AND NOTES AUTHORIZED BUT NOT ISSUED**

At December 31, 2017 and 2016, the City has authorized but not issued bonds and notes of \$29,336,887 and \$29,708,545, respectively, in the General Capital Fund. The following activity relates to bonds and notes authorized but not issued that occurred during the years ended December 31, 2017:

	<u>Total</u>	<u>General / Local</u>	<u>School</u>	<u>Water</u>
Balance: December 31, 2015	\$ 29,708,545	\$ 26,659,629	\$ 1,587,258	\$ 1,461,658
Add:				
Authorizations	2,600,000	2,600,000	-	-
Notes Matured	26,898,194	26,898,194	-	-
Subtotal	59,206,739	56,157,823	1,587,258	1,461,658
Less:				
Notes Issued	24,901,000	24,901,000	-	-
Cash Receipts	1,461,658	-	-	1,461,658
Cancelled	1,510,000	1,510,000	-	-
Fund Balance	28	28	-	-
Budget Appropriations	1,997,166	1,997,166	-	-
Balance: December 31, 2015	<u>\$ 29,336,887</u>	<u>\$ 27,749,629</u>	<u>\$ 1,587,258</u>	<u>\$ -</u>

The following activity relates to bonds and notes authorized but not issued that occurred during the years ended December 31, 2016:

	<u>Total</u>	<u>General / Local</u>	<u>School</u>	<u>Water</u>
Balance: December 31, 2015	\$ 28,402,689	\$ 14,046,442	\$ 4,265,245	\$ 10,091,002
Add:				
Authorizations	197,096,905	185,936,905	-	11,160,000
Receivables Cancelled	-	-	-	-
Notes Matured	40,602,842	40,602,842	-	-
Subtotal	266,102,436	240,586,189	4,265,245	21,251,002
Less:				
Bonds Issued	38,788,000	38,598,000	-	190,000
Notes Issued	26,898,194	26,898,194	-	-
Cash Receipts	4,511,438	4,511,438	-	-
Authorized for Refunding	141,848,950	131,758,950	-	10,090,000
Cancelled	18,328,661	6,141,330	2,677,987	9,509,344
Budget Appropriations	6,018,648	6,018,648	-	-
Balance: December 31, 2016	<u>\$ 29,708,545</u>	<u>\$ 26,659,629</u>	<u>\$ 1,587,258</u>	<u>\$ 1,461,658</u>

**CITY OF JERSEY CITY  
NOTES TO FINANCIAL STATEMENTS**

**DECEMBER 31, 2017 AND 2016**

**NOTE D. MUNICIPAL DEBT (continued)**

SUMMARY OF STATUTORY DEBT CONDITION - ANNUAL DEBT STATEMENT

The summarized statement of debt condition which follows is prepared in accordance with the required method of setting up the Annual Debt Statement.

At December 31, 2017: Net Debt of \$417,807,408 divided by Equalized Valuation Basis per N.J.S.A. 40A:2-2 as amended, \$25,242,322,640 = 1.66%.

	Gross Debt	Deductions	Net Debt
Local School District Debt	\$ 22,417,258	\$ 22,417,258	\$ -
General Debt	625,889,349	208,081,941	417,807,408
	\$ 648,306,607	\$ 230,499,199	\$ 417,807,408

At December 31, 2016: Net Debt of \$456,452,228 divided by Equalized Valuation Basis per N.J.S.A. 40A:2-2 as amended, \$22,343,602,064 = 2.04%.

	Gross Debt	Deductions	Net Debt
Local School District Debt	\$ 28,742,258	\$ 28,742,258	\$ -
General Debt	721,324,113	264,871,885	456,452,228
	\$ 750,066,371	\$ 293,614,143	\$ 456,452,228

Equalized valuation basis is the average of the equalized valuations of real estate, including improvements, and the assessed valuation of class II Railroad Property of the County for the last 3 preceding years.

BORROWING POWER UNDER N.J.S.A. 40A:2-6 AS AMENDED

	At December 31,	
	2017	2016
Three-Year Average Equalized Valuation	\$ 25,242,322,640	\$ 22,343,602,064
3 1/2 % of Equalized Valuation Basis	883,481,292	782,026,072
Net Debt	417,807,408	456,452,228
Excess Borrowing Power	\$ 465,673,884	\$ 325,573,844



**CITY OF JERSEY CITY  
NOTES TO FINANCIAL STATEMENTS**

**DECEMBER 31, 2017 AND 2016**

**NOTE D. MUNICIPAL DEBT (continued)**

CITY-GUARANTEE OF OTHER PUBLIC BODY DEBT

The City has adopted various ordinances over the years guaranteeing the payment of principal and interest on debt issues of the Jersey City Municipal Utilities Authority (MUA), for the purpose of providing additional security therefor. The amount of debt guaranteed by the City on behalf of the MUA as of December 31, 2017 and 2016 was \$150,221,941 and \$199,455,227, respectively.

**NOTE E. FUND BALANCES APPROPRIATED**

Fund balance of the City consists of cash surplus and non-cash surplus. The City can anticipate fund balance to support its budget of the succeeding year, however, the use of non-cash surplus is subject to the prior written consent of the Division. Fund balances at December 31, 2017 and 2016 which were appropriated and included as anticipated revenue in the current fund budget of the succeeding year were as follows:

	Fund Balance Dec. 31, 2016	Utilized in 2017 Budget	Fund Balance Dec. 31, 2017	Utilized in 2018 Budget
Current Fund	\$ 78,920,179	\$ 39,960,250	\$ 56,339,410	\$ 26,423,048
Capital Fund	1,306,241	-	1,428,110	-

**NOTE F. RETIREMENT SYSTEMS AND DEFERRED COMPENSATION**

Substantially all City employees participate in the Consolidated Police and Fireman's Pension Fund (CPFPPF), Public Employees Retirement System (PERS), Police and Fireman's Retirement System of New Jersey (PFRS) or the Defined Contribution Retirement Program (DCRP), all of which are multiple employer plans sponsored and administered by the State of New Jersey, with the exception of the CPFPPF, which is a single employer plan. The CPFPPF, PERS and PFRS are cost sharing contributory defined benefit public employee retirement systems. The DCRP is a defined contribution plan.

In addition, certain employees participate in the Employees' Retirement System of the City of Jersey City (JCERS) and the City's Deferred Compensation Plan.

**CITY OF JERSEY CITY  
NOTES TO FINANCIAL STATEMENTS**

**DECEMBER 31, 2017 AND 2016**

**NOTE F. RETIREMENT SYSTEMS AND DEFERRED COMPENSATION (continued)**

**STATE-MANAGED PENSION PLANS – CPFPPF**

The Consolidated Police and Fireman's Pension Fund (CPFPPF) is a single employer contributory defined benefit plan which was established on January 1, 1952, under the provisions of N.J.S.A. 43:16 to provide retirement, death and disability benefits to county and municipal police and firemen who were appointed prior to July 1, 1944. The fund is a closed system with no active member and therefore no base payroll. The City currently only makes contributions for its retirees who are enrolled in this pension fund. During the years ended December 31, 2017, 2016 and 2015, the City contributed \$-0-, \$-0- and \$46,592, respectively.

**STATE-MANAGED PENSION PLANS – PERS**

**Plan Description and Eligibility**

The PERS was established in January, 1955 under provisions of N.J.S.A. 43:15A and provides retirement, death, disability and post-retirement medical benefits to certain qualifying Plan members and beneficiaries. Membership is mandatory to substantially all full time employees and vesting occurs after 8 to 10 years of service for pension benefits. Significant modifications to enrollment, benefits and eligibility for benefits under the plan were made in 2007, 2008, 2010 and 2011. These changes resulted in various "tiers" which distinguish period of eligibility for enrollment. The delineation of these tiers is as follows:

- Tier 1: Employees enrolled before July 1, 2007.
- Tier 2: Employees eligible for enrollment after June 30, 2007 but before November 2, 2008.
- Tier 3: Employees eligible for enrollment after November 1, 2008 but before May 22, 2010.
- Tier 4: Employees eligible for enrollment after May 21, 2010 but before June 28, 2011.
- Tier 5: Employees eligible for enrollment after June 27, 2011.

**CITY OF JERSEY CITY  
NOTES TO FINANCIAL STATEMENTS**

**DECEMBER 31, 2017 AND 2016**

**NOTE F. RETIREMENT SYSTEMS AND DEFERRED COMPENSATION (continued)**

Tier 1 and 2 employees must earn a base salary of \$1,500 or more to enroll in the plan. Pensionable salaries are limited to the IRS maximum salary compensation limits for Tier 1 employees and social security maximum wage for Tier 2 employees. Tier 2 employees earning over the social security maximum wage are eligible to participate in DCRP for the excess amount. Tier 3 employees must earn a base salary that is annually adjusted. For the fiscal year ended December 31, 2017 and 2016 this base salary amount was \$8,300, each year. Employees earning between \$5,000 and the Tier 3 minimum base salary are eligible for participation in DCRP. Pensionable salaries are limited to the social security maximum wage. Employees earning over the social security maximum wage are eligible to participate in DCRP for the excess amount. Tier 4 and 5 employees do not have a minimum salary requirement to enroll, but must work a minimum of 32 hours per week. Employees not meeting the minimum hour requirement but that make over \$5,000 are eligible to enroll in DCRP. Pensionable salaries are limited to the social security maximum wage. Employees earning over the social security maximum wage are eligible to participate in DCRP for the excess amount.

**Plan Benefits**

Service retirement benefits of 1/55th of final average salary for each year of service credit is available to tiers 1 and 2 members upon reaching age 60 and to tier 3 members upon reaching age 62. Service retirement benefits of 1/60th of final average salary for each year of service credit is available to tier 4 members upon reaching age 62 and tier 5 members upon reaching age 64. Early retirement benefits are available to tiers 1 and 2 members before reaching age 60, tiers 3 and 4 before age 62 and tier 5 with 30 or more years of service credit before age 65. Benefits are reduced by a fraction of a percent for each month that a member retires prior to the retirement age of their respective tier. Deferred retirement is available to members who have at least 10 years of service credit and have not reached the service retirement age for the respective tier.

Each of the 5 Tiers have eligibility requirements and benefit calculations which vary for deferred retirements, early retirements, veteran retirements, ordinary disability retirements and accidental disability retirements. There is no minimum service requirement to receive these pension benefits. State-paid insurance coverage may be obtained after 25 years of service for employees in Tiers 1 through 4 and 30 years of service for Tier 5 employees.

**CITY OF JERSEY CITY  
NOTES TO FINANCIAL STATEMENTS**

**DECEMBER 31, 2017 AND 2016**

**NOTE F. RETIREMENT SYSTEMS AND DEFERRED COMPENSATION (continued)**

**Contributions and Liability**

The contribution policy for PERS is set by N.J.S.A. 43:15A and requires contributions by active members and their employers. Such contributions may be amended by State legislation. Employers' contribution amounts are based on an actuarially determined rate. The annual employer contributions include funding for basic retirement allowances and non-contributory death benefits. The employee contributions include funding for basic retirement allowances and contributory death benefits. Contributions made by the City and its employees for the previous three years are as follows:

Year Ended December 31,	City Contribution		Base Wages Subject to Contributions	Employee Contributions	
	Amount Paid or Charged	As a Percentage of Base Wages		As a Percentage of Base Wages	Amount Contributed
2017	\$ 4,048,980	15.0%	\$ 26,957,096	7.34% (1)	\$ 1,959,697
2016	3,796,490	15.9%	23,906,845	7.20% (1)	1,705,719
2015	2,767,056	14.6%	19,018,935	7.06% (1)	1,330,083

(1) The rate noted took effect on July 1.

At June 30, 2017 and 2016, the City's net pension liability for PERS, including the City's proportionate share, was as follows:

Year Ended June 30,	Proportionate Share		Net Pension Liability
	Rate	Change	
2017	0.38824%	0.00004%	\$ 90,376,243
2016	0.38820%	0.14823%	114,973,627

**Sensitivity of the City's Proportionate Share of the Net Pension Liability to Changes in the Discount Rate**

The following presents the City's proportionate share of the net pension liability of the as of June 30, 2017 and 2016, calculated using the discount rate as disclosed in the table and paragraphs that follow as well as what the collective net pension liability would be if it was calculated using a discount rate that is 1% lower or 1% higher than the current rate:

At:	2017		2016	
	Rate	Amount	Rate	Amount
1% Decrease	4.00%	\$ 112,117,863	2.98%	\$ 140,886,760
Current Discount Rate	5.00%	90,376,243	3.98%	114,973,627
1% Increase	6.00%	72,262,779	4.98%	93,580,089

**CITY OF JERSEY CITY  
NOTES TO FINANCIAL STATEMENTS**

**DECEMBER 31, 2017 AND 2016**

**NOTE F. RETIREMENT SYSTEMS AND DEFERRED COMPENSATION (continued)**

**Actuarial Assumptions**

The total pension liability for the June 30, 2017 and June 30, 2016 measurement dates were determined by actuarial valuations as of July 1, 2016 and 2015, respectively, which were rolled forward to June 30, 2017 and 2016, respectively. These actuarial valuations used the following actuarial assumptions, applied to all periods in the measurement:

Measurement Date of	Inflation Rate	Age-Based Salary Increases		Investment Rate of Return
		Through 2026	Thereafter	
June 30, 2017	2.25%	1.65-4.15%	2.65-5.15%	7.00%
June 30, 2016	3.08%	1.65-4.15%	2.65-5.15%	7.65%

*Mortality* – For both the June 30, 2017 and 2016 Measurement Dates, preretirement mortality rates were based on the RP-2000 Employee Preretirement Mortality Table for male and female active participants (set back two years for males and seven years for females). In addition, the tables provided for future improvements in mortality from the base year of 2013 using a generational approach based on the plan actuary’s modified MP-2014 projection scale. Post-retirement mortality rates were based on the RP-2000 Combined Healthy Male and Female Mortality Tables (set back one year for males and females) for service retirements and beneficiaries of former members and a one-year static projection based on mortality improvement Scale AA. In addition, the tables for service retirements and beneficiaries of former members provide for future improvements in mortality from the base year of 2013 using a generational approach based on the plan actuary’s modified MP-2014 projection scale. Disability retirement rates used to value disabled retirees were based on the RP-2000 Disabled Mortality Table (set back three years for males and set forward one year for females).

The actuarial assumptions used in both the July 1, 2016 and 2015 valuations were based on the results of an actuarial experience study for the period July 1, 2011 to June 30, 2014. It is likely that future experience will not exactly conform to these assumptions. To the extent that actual experience deviates from these assumptions, the emerging liabilities may be higher or lower than anticipated. The more the experience deviates, the larger the impact on future financial statements will be.

**CITY OF JERSEY CITY  
NOTES TO FINANCIAL STATEMENTS**

**DECEMBER 31, 2017 AND 2016**

**NOTE F. RETIREMENT SYSTEMS AND DEFERRED COMPENSATION (continued)**

*Long-Term Expected Rate of Return* - In accordance with State statute, the long-term expected rate of return on plan investments (7.00% at June 30, 2017 and 7.65% at June 30, 2016) is determined by the State Treasurer, after consultation with the Directors of the Division of Investments and Division of Pensions and Benefits, the board of trustees and the actuaries. The long-term expected rate of return was determined using a building block method in which best-estimate ranges of expected future real rates of return (expected returns, net of pension plan investment expense and inflation) are developed for each major asset class. These ranges are combined to produce the long-term expected rate of return by weighting the expected future real rates of return by the target asset allocation percentage and by adding expected inflation. Best estimates of arithmetic rates of return for each major asset class included in PERS target asset allocations as of June 30, 2017 and 2016 are summarized in the following table:

June 30, 2017			June 30, 2016		
Asset Class	Target Allocation	Long-Term Expected Real Rate of Return	Asset Class	Target Allocation	Long-Term Expected Real Rate of Return
Absolute Return / Risk Mitigation	5.00%	5.51%	Cash & Equivalents	5.00%	0.87%
Cash & Equivalents	5.50%	1.00%	U.S. Treasuries	1.50%	1.74%
U.S. Treasuries	3.00%	1.87%	Investment Grade Credit	8.00%	1.79%
Investment Grade Credit	10.00%	3.78%	Mortgages	2.00%	1.67%
Public High Yield	2.50%	6.82%	High Yield Bonds	2.00%	4.56%
Global Diversified Credit	5.00%	7.10%	Inflation-Indexed Bonds	1.50%	3.44%
Credit Oriented Hedge Funds	1.00%	6.60%	Broad U.S. Equities	26.00%	8.53%
Debt Related Private Equity	2.00%	10.63%	Developed Foreign Equities	13.25%	6.83%
Debt Related Real Estate	1.00%	6.61%	Emerging Market Equities	6.50%	9.95%
Private Real Asset	2.50%	11.83%	Private Equity	9.00%	12.40%
Equity Related Real Estate	6.25%	9.23%	Hedge Funds / Absolute Return	12.50%	4.68%
U.S. Equity	30.00%	8.19%	Real Estate (Property)	2.00%	6.91%
Non-U.S. Developed Markets Equity	11.50%	9.00%	Commodities	0.50%	5.45%
Emerging Market Equities	6.50%	11.64%	Global Debt ex U.S.	5.00%	-2.50%
Buyouts / Venture Capital	8.25%	13.08%	REIT	5.25%	5.63%

**CITY OF JERSEY CITY  
NOTES TO FINANCIAL STATEMENTS**

**DECEMBER 31, 2017 AND 2016**

**NOTE F. RETIREMENT SYSTEMS AND DEFERRED COMPENSATION (continued)**

*Discount Rate* - The discount rate used to measure the total pension liability was 5.00% and 3.98% as of June 30, 2017 and 2016, respectively. This single blended discount rate was based on the long-term expected rate of return on pension plan investments of 7.00% and 7.65% as of June 30, 2017 and 2016, respectively, and a municipal bond rate of 3.58% and 2.85% as of June 30, 2017 and 2016, respectively, based on the Bond Buyer Go 20-Bond Municipal Bond Index which includes tax-exempt general obligation municipal bonds with an average rating of AA/Aa or higher. The projection of cash flows used to determine the discount rate assumed that contributions from plan members will be made at the current member contribution rates and that contributions from employers will be made based on the contribution rate in the most recent fiscal year for each of the June 30, 2017 and June 30, 2016 measurement dates. Local employers contributed 100% of their actuarially determined contributions.

Based on those assumptions, the plan's fiduciary net position was projected to be available to make projected future benefit payments of current plan members through 2040 and 2034 as of June 30, 2017 and 2016, respectively. Therefore, the long-term expected rate of return on plan investments was applied to projected benefit payments through 2040 and 2034 as of June 30, 2017 and 2016, respectively, and the municipal bond rate was applied to projected benefit payments after those dates in determining the total pension liability.

**Deferred Outflows and Inflows of Resources**

The following presents a summary of changes in the collective deferred outflows of resources and deferred inflows of resources for the years ended June 30, 2017 and 2016:

	June 30, 2017			June 30, 2016		
	Deferred Outflows of Resources	Deferred Inflows of Resources	Net Deferred Outflow / (Inflow)	Deferred Outflows of Resources	Deferred Inflows of Resources	Net Deferred Outflow / (Inflow)
Changes of Assumptions	\$ 18,207,698	\$ (18,140,945)	\$ 66,753	\$ 23,816,395	\$ -	\$ 23,816,395
Difference Between Expected and Actual Experience	2,128,049	-	2,128,049	2,138,161	-	2,138,161
Net Difference Between Projected and Actual Earnings on Pension Plan Investments	615,401	-	615,401	4,384,049	-	4,384,049
Changes in Proportion	24,435,346	(23,713,963)	721,383	10,684,502	(9,913,856)	770,646
	<u>\$ 45,386,494</u>	<u>\$ (41,854,908)</u>	<u>\$ 3,531,586</u>	<u>\$ 41,023,107</u>	<u>\$ (9,913,856)</u>	<u>\$ 31,109,251</u>

**CITY OF JERSEY CITY  
NOTES TO FINANCIAL STATEMENTS**

**DECEMBER 31, 2017 AND 2016**

**NOTE F. RETIREMENT SYSTEMS AND DEFERRED COMPENSATION (continued)**

STATE-MANAGED PENSION PLANS – PERS (continued)

**Deferred Outflows and Inflows of Resources**

Amounts reported as deferred outflows of resources and deferred inflows of resources related to pensions will be recognized in pension expense as follows:

Year Ended June 30,	
2018	\$ 2,365,158
2019	3,030,476
2020	2,156,544
2021	(2,133,513)
2022	(1,887,080)
	<u>\$ 3,531,586</u>

STATE-MANAGED PENSION PLANS – PFRS

**Plan Description and Eligibility**

The PFRS was established in July, 1944, under the provisions of N.J.S.A. 43:16A to provide coverage to substantially all full time county and municipal police or firefighters and state police appointed after June 30, 1944. Membership is mandatory for such employees with vesting occurring after 10 years of membership. Significant modifications to enrollment, benefits and eligibility for benefits under the plan were made in 2010 and 2011. These changes resulted in various “tiers” which distinguish period of eligibility for enrollment. The delineation of these tiers is noted as follows:

- Tier 1: Employees enrolled before May 22, 2010.
- Tier 2: Employees enrolled after May 21, 2010 but before June 29, 2011.
- Tier 3: Employees enrolled after June 28, 2011.

There is no minimum salary requirement to enroll, regardless of tier. Pensionable salaries are limited to the social security maximum wage for Tier 2 and 3 employees and federal pensionable maximum for Tier 1 employees. Employees earning over the social security maximum wage are eligible to participate in DCRP for the excess amount.



**CITY OF JERSEY CITY  
NOTES TO FINANCIAL STATEMENTS**

**DECEMBER 31, 2017 AND 2016**

**NOTE F. RETIREMENT SYSTEMS AND DEFERRED COMPENSATION (continued)**

**Plan Benefits**

Service retirement benefits are available at age 55 and are generally determined to be 2% of final compensation for each year of creditable service, as defined, up to 30 years plus 1% for each year of service in excess of 30 years. Members may seek special retirement after achieving 25 years of creditable service, in which benefits would equal 65% (tiers 1 and 2 members) and 60% (tier 3 members) of final compensation plus 1% for each year of creditable service over 25 years but not to exceed 30 years. Members may elect deferred retirement benefits after achieving ten years of service, in which case benefits would begin at age 55 equal to 2% of final compensation for each year of service.

**Contributions and Liability**

The contribution policy for PFRS is set by N.J.S.A. 43:16A and requires contributions by active members and their employers. Such contributions may be amended by State legislation. Employers' contribution amounts are based on an actuarially determined rate which includes the normal cost and unfunded accrued liability. The annual employer contributions include funding for basic retirement allowances and non-contributory death benefits. The employee contributions include funding for basic retirement allowances and contributory death benefits. Contributions made by the City and its employees for the previous three years are as follows:

Year Ended December 31,	City Contribution		Base Wages Subject to Contributions	Employee Contributions	
	Amount Paid or Charged	As a Percentage of Base Wages		As a Percentage of Base Wages	Amount Contributed
2017	\$ 38,869,751	0.0%	\$ 144,810,473	10.00%	\$ 14,481,047
2016	38,097,772	26.1%	145,992,133	10.00%	14,599,213
2015	34,790,479	24.4%	142,418,958	10.00%	14,241,896

Under N.J.S.A. 43:16A-15, local participating employers are responsible for their own contributions based on actuarially determined amounts, except where legislation was passed which legally obligated the State if certain circumstances occurred. The legislation which legally obligates the State is as follows: Chapter 8, P.L. 2000, Chapter 318, P.L. 2001, Chapter 86, P.L. 2001, Chapter 511, P.L. 1991, Chapter 109, P.L. 1979, Chapter 247, P.L. 1993 and Chapter 201, P.L. 2001.

**CITY OF JERSEY CITY  
NOTES TO FINANCIAL STATEMENTS**

**DECEMBER 31, 2017 AND 2016**

**NOTE F. RETIREMENT SYSTEMS AND DEFERRED COMPENSATION (continued)**

STATE-MANAGED PENSION PLANS – PFRS (continued)

The amounts contributed on behalf of the City under this legislation are considered to be a special funding situation. As such, the State is treated as a non-employer contributing entity. Since the City does not contribute under this legislation directly to the plan (except for employer specified financed amounts), there is no net pension liability to report in the financial statements of the City related to this legislation. However, the notes to the financial statements of the City must disclose the portion of the State's total proportionate share of the collective net pension liability that is associated with the City.

At June 30, 2017 and 2016, the City's net pension liability for PFRS, including the special funding situation described above and changes in the City's proportionate share, was as follows:

Year Ended June 30,	Unit	City (employer)		Net Pension Liability	State of N.J. (nonemployer)	Total
		Proportionate Share Rate	Change		On-Behalf of City	
2017	Police	2.62429%	0.05679%	\$ 405,139,869	\$ 45,379,078	\$ 450,518,947
2017	Fire	1.90286%	-0.02017%	293,764,059	32,904,049	326,668,108
2017	Total	*	*	<u>\$ 698,903,928</u>	<u>\$ 78,283,127</u>	<u>\$ 777,187,055</u>
2016	Police	2.56750%	0.02666%	\$ 490,457,948	\$ 41,186,303	\$ 531,644,251
2016	Fire	1.92303%	0.04428%	367,347,939	30,848,116	398,196,055
2016	Total	*	*	<u>\$ 857,805,887</u>	<u>\$ 72,034,419</u>	<u>\$ 929,840,306</u>

**Sensitivity of the City's Proportionate Share of the Net Pension Liability to Changes in the Discount Rate**

The following presents the City's proportionate share of the net pension liability of the as of June 30, 2017 and 2016, calculated using the discount rate as disclosed above as well as what the collective net pension liability would be if it was calculated using a discount rate that is 1% lower or 1% higher than the current rate:

At:	2017		2016	
	Rate	Amount	Rate	Amount
1% Decrease	5.14%	\$ 920,863,482	4.55%	\$ 1,106,077,793
Current Discount Rate	6.14%	698,903,928	5.55%	857,805,887
1% Increase	7.14%	516,538,916	6.55%	381,323,823

**CITY OF JERSEY CITY  
NOTES TO FINANCIAL STATEMENTS**

**DECEMBER 31, 2017 AND 2016**

**NOTE F. RETIREMENT SYSTEMS AND DEFERRED COMPENSATION (continued)**

**Actuarial Assumptions**

The total pension liability for the June 30, 2017 and June 30, 2016 measurement dates were determined by actuarial valuations as of July 1, 2016 and 2015, respectively, which were rolled forward to June 30, 2017 and 2016, respectively. These actuarial valuations used the following actuarial assumptions:

Measurement Date of	Inflation Rate	Age-Based Salary Increases		Investment Rate of Return
		Through 2026	Thereafter	
June 30, 2017	2.25%	2.10-8.98%	3.10-9.98%	7.00%
June 30, 2016	3.08%	2.10-8.98%	3.10-9.98%	7.65%

*Mortality* – For the June 30, 2017 and 2016 Measurement Dates, preretirement mortality rates were based on the RP-2000 Preretirement Mortality Tables projected 13 years using Projection Scale BB and then projected on a generational basis using the plan actuary’s modified 2014 projection scales. Postretirement mortality rates for male service retirements and beneficiaries are based on the RP-2000 Combined Health Mortality Tables projected one year using Projection Scale AA and then three years for June 30, 2017 and two years for June 30, 2016 using the plan actuary’s modified 2014 projection scales and further projected on a generational basis using the plan actuary’s modified 2014 projection scales. Post-retirement mortality rates for female service retirements and beneficiaries were based on the RP-2000 Combined Healthy Mortality Tables projected 13 years using Projection Scale BB and then three years for June 30, 2017 and two years for June 30, 2016 using the plan actuary’s modified 2014 projection scales and further projected on a generational basis using the plan actuary’s modified 2014 projection scales. Disability mortality rates were based on special mortality tables used for the period after disability retirement. The actuarial assumptions used in the July 1, 2016 and 2015 valuations were based on the results of an actuarial experience study for the period July 1, 2010 to June 30, 2013.

**CITY OF JERSEY CITY  
NOTES TO FINANCIAL STATEMENTS**

**DECEMBER 31, 2017 AND 2016**

**NOTE F. RETIREMENT SYSTEMS AND DEFERRED COMPENSATION (continued)**

*Long-Term Expected Rate of Return* - In accordance with State statute, the long-term expected rate of return on plan investments (7.00% at June 30, 2017 and 7.65% at June 30, 2016) is determined by the State Treasurer, after consultation with the Directors of the Division of Investments and Division of Pensions and Benefits, the board of trustees and the actuaries. The long-term expected rate of return was determined using a building block method in which best-estimate ranges of expected future real rates of return (expected returns, net of pension plan investment expense and inflation) are developed for each major asset class. These ranges are combined to produce the long-term expected rate of return by weighting the expected future real rates of return by the target asset allocation percentage and by adding expected inflation. Best estimates of arithmetic rates of return for each major asset class included in PFRS target asset allocations as of June 30, 2017 and 2016 are summarized in the following table:

June 30, 2017			June 30, 2016		
Asset Class	Target Allocation	Long-Term Expected Real Rate of Return	Asset Class	Target Allocation	Long-Term Expected Real Rate of Return
Absolute Return / Risk Mitigation	5.00%	5.51%	Cash & Equivalents	5.00%	0.87%
Cash & Equivalents	5.50%	1.00%	U.S. Treasuries	1.50%	1.74%
U.S. Treasuries	3.00%	1.87%	Investment Grade Credit	8.00%	1.79%
Investment Grade Credit	10.00%	3.78%	Mortgages	2.00%	1.67%
Public High Yield	2.50%	6.82%	High Yield Bonds	2.00%	4.56%
Global Diversified Credit	5.00%	7.10%	Inflation-Indexed Bonds	1.50%	3.44%
Credit Oriented Hedge Funds	1.00%	6.60%	Broad U.S. Equities	26.00%	8.53%
Debt Related Private Equity	2.00%	10.63%	Developed Foreign Equities	13.25%	6.83%
Debt Related Real Estate	1.00%	6.61%	Emerging Market Equities	6.50%	9.95%
Private Real Asset	2.50%	11.83%	Private Equity	9.00%	12.40%
Equity Related Real Estate	6.25%	9.23%	Hedge Funds / Absolute Return	12.50%	4.68%
U.S. Equity	30.00%	8.19%	Real Estate (Property)	2.00%	6.91%
Non-U.S. Developed Markets Equity	11.50%	9.00%	Commodities	0.50%	5.45%
Emerging Market Equities	6.50%	11.64%	Global Debt ex U.S.	5.00%	-2.50%
Buyouts / Venture Capital	8.25%	13.08%	REIT	5.25%	5.63%

**CITY OF JERSEY CITY  
NOTES TO FINANCIAL STATEMENTS**

**DECEMBER 31, 2017 AND 2016**

**NOTE F. RETIREMENT SYSTEMS AND DEFERRED COMPENSATION (continued)**

STATE-MANAGED PENSION PLANS – PFRS (continued)

*Discount Rate* - The discount rate used to measure the total pension liability was 6.14% and 5.55% as of June 30, 2017 and 2016, respectively. This single blend discount rate was based on the long-term expected rate of return on pension plan investments of 7.00% and 7.65% as of June 30, 2017 and 2016, respectively, and a municipal bond rate of 3.58% and 2.85% as of June 30, 2017 and 2016, respectively, based on the Bond Buyer Go 20-Bond Municipal Bond Index which includes tax-exempt general obligation municipal bonds with an average rating of AA/Aa or higher. The projection of cash flows used to determine the discount rate assumed that contributions from plan members will be made at the current member contribution rates and that contributions from employers and the nonemployer contributing entity will be made based on the contribution rate in most recent fiscal year. Based on those assumptions, the plan's fiduciary net position was projected to be available to make projected future benefit payments of current plan members through 2057 and 2050 as of June 30, 2017 and 2016, respectively. Therefore, the long-term expected rate of return on plan investments was applied to projected benefit payments through 2057 and 2050 as of June 30, 2017 and 2016, respectively, and the municipal bond rate was applied to projected benefit payments after that date in determining the total pension liability.

**Deferred Outflows and Inflows of Resources**

The following presents a summary of changes in the collective deferred outflows of resources and deferred inflows of resources (excluding employer specific amounts) for the years ended June 30, 2017 and 2016:

	June 30, 2017			June 30, 2016		
	Deferred Outflows of Resources	Deferred Inflows of Resources	Net Deferred Outflow / (Inflow)	Deferred Outflows of Resources	Deferred Inflows of Resources	Net Deferred Outflow / (Inflow)
Changes of Assumptions	\$ 86,182,640	\$ (114,460,028)	\$ (28,277,388)	\$ 118,813,164	\$ -	\$ 118,813,164
Difference Between Expected and Actual Experience	4,534,077	(4,101,985)	432,092	-	(5,623,044)	(5,623,044)
Net Difference Between Projected and Actual Earnings on Pension Plan Investments	13,336,725	-	13,336,725	60,104,732	-	60,104,732
Changes in Proportion	23,664,481	(7,045,944)	16,618,537	22,360,402	(6,604,048)	15,756,354
	<u>\$ 127,717,923</u>	<u>\$ (125,607,957)</u>	<u>\$ 2,109,966</u>	<u>\$ 201,278,298</u>	<u>\$ (12,227,092)</u>	<u>\$ 189,051,206</u>

**CITY OF JERSEY CITY  
NOTES TO FINANCIAL STATEMENTS**

**DECEMBER 31, 2017 AND 2016**

**NOTE F. RETIREMENT SYSTEMS AND DEFERRED COMPENSATION (continued)**

**STATE-MANAGED PENSION PLANS – PFRS (continued)**

Amounts reported as deferred outflows of resources and deferred inflows of resources related to pensions will be recognized in pension expense as follows:

Year Ended June 30,	
2018	\$ 12,757,270
2019	26,407,182
2020	5,126,348
2021	(28,652,657)
2022	<u>(13,528,178)</u>
	<u>\$ 2,109,966</u>

**STATE-MANAGED PENSION PLANS - GENERAL**

The State established and administers a Supplemental Annuity Collective Trust Fund (SACT) which is available to active members of several State-administered retirement systems to purchase annuities to supplement the guaranteed benefits provided by their retirement system. The State or local government employers do not appropriate funds to SACT.

The State also administers the Pension Adjustment Fund (PAF) which provides cost of living increases, equal to 60 percent of the change in the average consumer price index, to eligible retirees in all State-sponsored pension systems except SACT. The cost of living increases for PFRS and PERS are funded directly by each of the respective systems and are considered in the annual actuarial calculation of the required State contribution for that system.

According to state statutes, all obligations of PERS and PFRS will be assumed by the State of New Jersey should the PERS and PFRS be terminated.

**PERS and PFRS Fiduciary Net Position**

The State of New Jersey issues publicly available financial reports that include the financial statements, required supplementary information and detailed information about the fiduciary net position of the PERS and PFRS. These financial statements were prepared in accordance with accounting principles generally accepted in the United States. This report may be obtained by writing to the State of New Jersey, Department of the Treasury, Division of Pensions and Benefits, P.O. Box 295, Trenton, New Jersey 08625-0295 or accessed at [www.state.nj.us/treasury/pensions](http://www.state.nj.us/treasury/pensions).

**CITY OF JERSEY CITY  
NOTES TO FINANCIAL STATEMENTS**

**DECEMBER 31, 2017 AND 2016**

**NOTE F. RETIREMENT SYSTEMS AND DEFERRED COMPENSATION (continued)**

STATE-MANAGED PENSION PLANS – PENSION DEFERRAL

Legislation, known as Chapter 19 of the Public Laws of 2009 (P.L. 2009, c. 19), was enacted and effective on March 17, 2009 allowing for an adjustment in the contributions that local employers, such as the City, must make to the PERS and PFRS during the year ended June 30, 2009. Under this legislation, local governments were given the option to defer exactly 50% of their required pension contribution as certified by the State of New Jersey, Department of the Treasury, Division of Pensions and Benefits or pay the full amount of the required contribution for the year ended June 30, 2009.

The City elected the 50% deferral, totaling \$14,826,590, consisting of \$14,129,001 for PFRS and \$697,589 for PERS. Under the terms of the pension deferral, the City is obligated to repay the entire deferral in 15 amortized annual installments starting April 1, 2012 and ending April 1, 2026. These payments will be added to the regular pension bills. In 2016, the City dissolved the Jersey City Incinerator Authority, and therefore assumed its share of pension deferral obligations. The amount of the deferral paid during the years ended December 31, 2017 and 2016, as well as the short term liability of the deferral, are as follows:

	Combined Interest and Principal		
	Paid During Year Ended Dec. 31,		Due April 1,
	2016	2017	2018
PERS	\$ 107,071	\$ 148,612	\$ 150,500
PFRS	2,127,246	2,147,947	2,169,712
Total	\$ 2,234,317	\$ 2,296,559	\$ 2,320,212

DEFINED CONTRIBUTION RETIREMENT PROGRAM

The DCRP provides eligible members with a tax-sheltered, defined contribution retirement benefit, along with life insurance and disability coverage. Individuals eligible for membership in the DCRP include (a) state or local officials elected or appointed to new office on or after July 1, 2007, (b) employees enrolled in PERS on or after July 1, 2007 or PFRS after May 21, 2010 who earn salary in excess of established maximum compensation limit and (c) employees otherwise eligible for PERS on or after November 2, 2008 or PFRS after May 21, 2010 that earn below the minimum PERS or PFRS salary but more than \$5,000 annually.

**CITY OF JERSEY CITY  
NOTES TO FINANCIAL STATEMENTS**

**DECEMBER 31, 2017 AND 2016**

**NOTE F. RETIREMENT SYSTEMS AND DEFERRED COMPENSATION (continued)**

Vesting occurs upon commencement of the third year of membership. Should the vesting period not be reached, contributions will be refunded to the appropriate contributing parties. Employer matching contributions and earnings are only available after the age of 55. Distributions render the member retired and ineligible for future participation in any State-administered plans. Otherwise, distributions are available at any time as lump sum, fixed term or life annuity.

Members are covered by employer-paid life insurance in the amount of 1½ times the annual base salary on which DCRP contributions were based. Members are also eligible for employer-paid long-term disability coverage after one year of participation. Eligibility occurs after six consecutive months of total disability. Members would receive a regular monthly income benefit up to 60% of the base salary on which DCRP contributions were based during the 12 months preceding the onset of the disability, offset by any other periodic benefit the member may be receiving. Benefits will be paid until the age of 70 so long as the member remains disabled and has not begun receiving retirement annuity payments. The following table represents the City and employee contributions during the previous three years:

Year Ended Dec. 31,	Employee Contributions		City Contributions	
	Estimated Amount	As a Percentage of Base Payroll	Amount	As a Percentage of Base Payroll
2017	\$ 77,840	5.50%	\$ 42,458	3.00%
2016	71,977	5.50%	39,260	3.00%
2015	72,582	5.50%	39,590	3.00%

**EMPLOYEES' RETIREMENT SYSTEM OF JERSEY CITY**

The Employees' Retirement System of Jersey City (JCERS) became effective February 22, 1965, under N.J.S.A. 43:13-22.50, et seq. Legislation was approved amending the JCERS on May 9, 1990, effective June 1, 1990 and August 19, 1996 to revise the retirement and survivorship benefits payable to retirees and beneficiaries. Legislation in 2003 (Chapter 167, P.L. 2003) increased retirement allowances to 100% of CPI increases, replacing the previous 60%. Finally, Chapter 247, P.L. 2005 decreased the early retirement factor from 2/12 of 1% to 1/12 of 1% per month for retirees prior to the age of 60. The following plan description reflects these amendments. Under Chapter 282, P.L. 2013, legislation amends Section 43:13-22.73 to decrease retirants' Cost of Living Adjustments from 100% to 50% of the percentum of change in the Department of Labor's Consumer Price Index, which is assumed to increase at 3% per year.



**CITY OF JERSEY CITY  
NOTES TO FINANCIAL STATEMENTS**

**DECEMBER 31, 2017 AND 2016**

**NOTE F. RETIREMENT SYSTEMS AND DEFERRED COMPENSATION (continued)**

**Plan Members** - The number of plan members at January 1, 2016 was as follows:

Retired Members and Eligibles Survivors	349
Inactive Members Entitled to But Not Yet Receiving Benefits	19
Active Members	<u>818</u>
	<u>1,186</u>

**Plan Description** - The Plan is a single employer defined benefit pension plan covering certain employees of the City. Employees who were members of the former pension system (other than police, fire and Board of Education employees) hired after February 22, 1965, and under age 40 at the date of employment must become members of the Plan. In addition, temporary employees hired after October 7, 1984, with one year's continuous service, and under age 40 at the date of employment, must also become members of the Plan. Employees of the City who are not eligible to become members of the Plan are covered under the Public Employees' Retirement System which is managed by the State of New Jersey.

The activities of the JCERS are administered by a Pension Commission, which consists of the Mayor, Chief Financial Officer, two elected employee representatives, and one appointed citizen member. UBS and Trust Company of the West are designated custodians of the Plan's investments.

The JCERS has an actuarial valuation performed bi-annually as required by GASB. The most recent actuarial position of the JCERS was conducted as of December 31, 2017. Such valuations provide a basis for determining the contributions payable by the City.

The JCERS issues publicly available financial reports that include the financial statements and required supplementary information of the system. The financial report may be obtained by writing to the City Clerk, City of Jersey City, 280 Grove Street, Jersey City, NJ 07302.

**Funding Policy** - The JCERS is supported by joint contributions of its members and of the City.

Each member, on the effective date of the system, is required to contribute 6% to 8.5% of gross payroll. The contribution percentage varies with the member's age at the time of appointment. Each active member, who became a member after the effective date of the Plan, is required to contribute from 6.2% to 10.15% of their salary. The contribution percentage varies with the member's age on the date of entry to the Plan.

**CITY OF JERSEY CITY  
NOTES TO FINANCIAL STATEMENTS**

**DECEMBER 31, 2017 AND 2016**

**NOTE F. RETIREMENT SYSTEMS AND DEFERRED COMPENSATION (continued)**

Although it has not expressed any intention to do so, the City has the right to discontinue its contributions to the JCERS at any time and to terminate the JCERS subject to legislation. The City's contribution to the JCERS for the years ended December 31, 2017 and 2016 was \$9,054,000 and \$8,841,332, respectively.

**Pension Benefits** - For the purpose of this section "final salary" for benefit purposes is to be defined as the average annual salary during the member's final 3 years of service or for any 3 fiscal years of membership providing the largest possible benefit to the member or beneficiary. Final Salary for employees hired after January 17, 2014 is changed to be the average annual compensation for any five fiscal years of membership providing the largest benefit.

Pension benefits partially vest after 10 years of credited service. If a member has completed 10 years of credited service, and is separated from service either voluntarily or involuntarily, prior to age 60 (65 for employees hired after January 17, 2014), the member may elect to receive a lump-sum distribution of their own contributions, or to receive a deferred pension commencing at age 60 (65 for employees hired after January 17, 2014). The deferred pension is equal to 50% of the member's final salary multiplied by the ratio of years of credited service to years of credited service which would have been attained had the member continued to age 60 (65 for employees hired after January 17, 2014). The minimum annual pension is \$3,600.

On August 19, 1996, the Plan was amended. Participants are eligible to receive normal retirement benefits upon completion of 20 years (25 years for employees hired after January 17, 2014) of service and attainment of age 60 (age 65 for employees hired after January 17, 2014). Benefits under the Plan are calculated on the basis of 55% of final salary, plus 1% of the final salary for each year in excess of 20 (25 years for employees hired after January 17, 2014) years.

Participants are eligible for retirement benefits upon attaining age 60 (65 for employees hired after January 17, 2014) with less than 20 (25 years for employees hired after January 17, 2014) years of service. Benefits under the Plan are calculated on the basis of 2% of the retirant's final salary for each year of creditable service.

For members electing early retirement, prior to age 60 (65 for employees hired after January 17, 2014), with 25 (30 years for employees hired after January 17, 2014) years of credited service, benefits under the Plan equal 55% of final salary reduced by 1/12 of 1% for each month that the member is less than age 60 (3/12 of 1% for each month that the member is less than age 65 for employees hired after January 17, 2014).

**CITY OF JERSEY CITY  
NOTES TO FINANCIAL STATEMENTS**

**DECEMBER 31, 2017 AND 2016**

**NOTE F. RETIREMENT SYSTEMS AND DEFERRED COMPENSATION (continued)**

**Disability and Death Benefits** - Any member who has 5 or more years of creditable service and has become permanently disabled may retire on a disability pension computed on the basis of 50% of their final salary plus 1% for each year of creditable service in excess of 20 years. Any member who becomes permanently disabled as a result of the performance of their regular duties during employment may retire on a disability pension. The pension is equal to two-thirds of final salary.

In the event of the member's death, there is a survivorship benefit to the member's surviving spouse of 50% of the member's final salary provided the member was employed by the City for a period of five years. In the case of no surviving spouse, other dependents receive a benefit to a lesser extent. Death of a retirant will result in the surviving spouse, minor children or dependent parents, receiving a survivorship benefit equal to 50% of the retirant's pension at retirement, not less than \$3,600.

**Net Pension Liability** - The components of the net pension liability as of December 31, 2017 and 2016 are as follows:

	As of December 31,	
	2017	2016
Total Pension Liability	\$ 220,191,604	\$ 212,425,996
Plan Fiduciary Net Position	118,867,748	104,203,727
City's Net Pension Liability	\$ 101,323,856	\$ 108,222,269
Plan's Fiduciary Net Position as a Percentage of the Total Pension Liability	54.0%	49.1%

Covered employee payroll as of the January 1, 2016 actuarial valuation is \$33,421,968. The net pension liability as a percentage of covered employee payroll is 303.17%.

**Sensitivity of the Net Pension Liability to Changes in the Discount Rate** - The following presents the net pension liability, calculated using the discount rate of 8.25%, as well as what the City's net pension liability would be if it were calculated using a discount rate that is 1-percentage-point lower (7.25%) or 1- percentage-point higher (9.25%) than the current rate:

	1% Decrease to 7.25%	Current Discount Rate 8.25%	1% Increase to 9.25%
Net Pension Liability	\$ 127,620,597	\$ 101,323,856	\$ 86,853,297

**CITY OF JERSEY CITY  
NOTES TO FINANCIAL STATEMENTS**

**DECEMBER 31, 2017 AND 2016**

**NOTE F. RETIREMENT SYSTEMS AND DEFERRED COMPENSATION (continued)**

**Actuarial Assumptions** - The total pension liability as of December 31, 2016 were determined by use of update procedures to roll forward the plan's total pension liability as of December 31, 2015 to December 31, 2016 using the following actuarial assumptions, applied to all periods included in the measurement:

Actuarial cost method: Entry Age Normal, Level Percentage of Pay

Inflation: 3.00% per annum

Salary increases: Salaries are assumed to increase as follows:

<u>Age</u>	<u>Annual Rate of Salary Increase</u>	<u>Age</u>	<u>Annual Rate of Salary Increase</u>
20	4.91%	50	3.57%
25	5.00	55	3.09
30	4.86	60	2.74
35	4.50	62	2.57
40	4.23	65	2.30
45	3.85	69	1.86

Investment rate of return: 8.25%, net of pension plan investment expenses. This is based on an average inflation rate of 3.00% and a real rate of return of 5.25%.

Mortality rates among healthy annuitants were based on the RP-2000 Combined Healthy Male and Female Mortality Tables (setback 1 year for males and females) with a one year static projection based on mortality improvement scale AA and further projected from the base year of 2013 using a generational approach based on the Conduent Modified 2015 projection scale. Mortality rates among disabled annuitants were based on the RP-2000 Disabled Mortality Tables (set back 3 years for males and set forward 1 year for females) and further projected from the base year of 2013 using a generational approach based on the Conduent Modified 2015 projection scale.

The long-term expected rate of return on pension plan investments was determined using a building-block method in which best-estimate ranges of expected future real rates of return (expected returns, net of pension plan investment expense and inflation) are developed for each major asset class. These ranges are combined to produce the long-term expected rate of return by weighting the expected future real rates of return by the target asset allocation percentage and by adding expected inflation.

**CITY OF JERSEY CITY  
NOTES TO FINANCIAL STATEMENTS**

**DECEMBER 31, 2017 AND 2016**

**NOTE F. RETIREMENT SYSTEMS AND DEFERRED COMPENSATION (continued)**

Best estimates of arithmetic rates of return for each major asset class included in the pension plan's target asset allocation are summarized in the following table (note that the rates shown below include the inflation component).

The long-term expected rate of return on pension plan investments was determined using a building-block method in which best-estimate ranges of expected future real rates of return (expected returns, net of pension plan investment expense and inflation) are developed for each major asset class. These ranges are combined to produce the long-term expected rate of return by weighting the expected future real rates of return by the target asset allocation percentage and by adding expected inflation. Best estimates of arithmetic rates of return for each major asset class included in the pension plan's target asset allocation are summarized in the following table (note that the rates shown below include the inflation component):

Asset Class	Long-Term Expected Rate of Return at December 31,	
	2017	2016
Domestic Equity	8.30%	7.50%
International Equity	8.45%	8.50%
Fixed Income	3.05%	3.50%
Real Estate	6.90%	8.50%
Cash	2.25%	2.50%

**Discount Rate** - The discount rate used to measure the total pension liability was 8.25%. The projection of cash flows used to determine the discount rate assumed that Jersey City contributions will continue to follow the current funding policy. Based on those assumptions, the pension plan's fiduciary net position was projected to be available to make all projected future benefit payments of current plan members. In the event for benefit payments that are not covered by the pension plan's fiduciary net position, a municipal bond rate of 3.71% and 3.20% as of December 31, 2016 and 2015, respectively, are to be used to discount the benefit payments not covered by the pension plan's fiduciary net position. The rates are based on the S&P Municipal Bond 20 Year High Grade Rate Index. However, since the pension plan's fiduciary net position was projected to be available to make all projected future benefit payments of current plan members, the long-term expected rate of return on pension plan investments was applied to all periods of projected benefit payments to determine the total pension liability. The long-term expected rate of return of 8.25% per annum was used to reflect the expected asset allocation.

**CITY OF JERSEY CITY  
NOTES TO FINANCIAL STATEMENTS**

**DECEMBER 31, 2017 AND 2016**

**NOTE F. RETIREMENT SYSTEMS AND DEFERRED COMPENSATION (continued)**

**DEFERRED COMPENSATION PLAN (unaudited)**

The City has established a deferred compensation program for its employees under Section 457 of the Internal Revenue Code. The deferred compensation program is a Public Employees' Deferred Compensation Plan, covering employees and elected officials who perform services for the City. The plan is underwritten by Prudential Insurance Company.

The Plan is a tax-deferred supplemental retirement program that allows City employees to contribute a portion of their salaries, before federal taxes, to a retirement account. Contributions, or deferrals, are made through payroll deductions. Individuals are 100% vested. Distributions are not available to employees until termination, retirement, death, or unforeseeable emergency. All amounts of compensation deferred under the plan, all property and rights purchased with those amounts, and all income attributable to those amounts, property or rights are solely the property and rights of the individual contributors and are not subject to the claims of the City's general creditors.

Assets of the plans are invested in various mutual funds at the discretion of the participants.

**NOTE G. POST-EMPLOYMENT BENEFITS**

**Plan Description**

The City provides eligible retirees with medical, prescription drug, and life insurance benefits. Retirees who do not meet eligibility requirements for 100% City paid coverage but meet the eligibility requirements for 100% employee paid coverage can continue coverage by paying premiums established by the City.

Two medical plans are offered to eligible retirees and their dependents: a Traditional plan and a Direct Access plan. These plans are self-insured through Horizon Blue Cross. Future retirees are only eligible for the Direct Access plan.

Medical benefits coordinate with Medicare and retirees and their dependents are required to participate in Medicare A and B upon eligibility for these programs. Retirees, dependents, and surviving spouses are reimbursed the Part B premium by the City.

Prescription drug benefits are provided to eligible retirees and their dependents at varying co-pays.

**CITY OF JERSEY CITY  
NOTES TO FINANCIAL STATEMENTS**

**DECEMBER 31, 2017 AND 2016**

**NOTE G. POST-EMPLOYMENT BENEFITS (continued)**

**Plan Description – continued**

Dental and Vision benefits are available to eligible retirees and their dependents, however, retirees are required to pay 100% of the cost of these plans.

Retirees of the Jersey City Police Officers Benevolent Association, Jersey City Police Superior Officers Association, Uniformed Fire Fighters Association of Jersey City and Jersey City Uniformed Fire Officers Associations receive life insurance or death benefits ranging from \$1,500 to \$2,500 dependent on retirement date. Employees other than Police and Firemen have no postemployment death benefits paid by Jersey City.

Eligible dependents of retirees are provided medical and prescription drug benefits for their lifetime.

In March 2010, the Patient Protection and Affordable Care Act (PPACA) was signed into law. The high cost excise tax (“Cadillac tax”) provisions of the Act are applicable. Additionally, on June 28, 2011 P.L. 2011 c. 78 (Chapter 78) was enacted. Chapter 78 contained many changes to the retirement and healthcare plans offered to employees and retirees of New Jersey State and Local government..

The number of retirees receiving benefits as of December 31, 2016, the effective date of the, valuation is 2,397; 1,048 of whom receive single benefit coverage. Active employees number 2,514 as of the same valuation date. The average age of active employees is 46 with an average accrued years of service of 12 years.

**Eligibility**

The above benefits are available for employees who retire under the following conditions:

- After twenty-five years of service in PFRS or PERS
- Upon disability retirement from PFRS, service requirements of four years for ordinary disability and none for accidental disability
- Upon disability retirement from PERS, service requirements of ten years for ordinary disability and none for accidental disability
- Upon disability from JCERS, service requirements of five years for ordinary disability and none for accidental disability

**CITY OF JERSEY CITY  
NOTES TO FINANCIAL STATEMENTS**

**DECEMBER 31, 2017 AND 2016**

**NOTE G. POST-EMPLOYMENT BENEFITS (continued)**

**Funding Policy**

Current retirees, dependents and survivors are not required to contribute toward the cost of the postretirement medical and prescription drug coverage. All costs are paid 100% by the City. Any employee who retires after satisfying the eligibility requirements who had less than 20 years of PERS or PFRS as of June 28, 2011, shall be required to contribute toward the cost of postretirement healthcare benefits. The retiree contributions are based on a percentage of the postretirement healthcare cost. The contribution percentages, which are phased-in over a four-year period, vary based on healthcare coverage tier and amount of PERS or PFRS pension amounts. Retired Police and Firefighters are not required to contribute toward the cost of post retirement life insurance benefits.

The City currently accounts for these post retirement benefits on a pay-as-you-go basis. During the years ended December 31, 2017 and 2016, the City paid \$23,854,172 and \$20,518,187, respectively, for post-employment benefits. The City receives additional funding from the Early Retirement Reinsurance Program (ERRP) which is budgeted as a reduction to retiree health insurance costs.

**Actuarial Valuation Results**

Under GASB criteria, the City would recognize the cost of other post-employment benefits in the year when the employee services are received, report the accumulated liability from prior years, and provide information useful in assessing potential demands on the City's future cash flows. However, since the City is using the modified accrual basis of accounting as prescribed by the Division, the City is not required to show any accrued liability on the face of its financial statements, only to the notes to those financial statements.

The actuary has assumed the Annual Required Contribution will be amortized over 30 years, the maximum funding period. The OPEB's benefit obligations, currently, are in two parts: (1) the present value of the benefits yet to be paid for those who are currently covered as retirees and (2) the present value of the benefits to be paid for those active participants once they become eligible for retiree benefits.

Included in each present value is a cost for administering the retiree claims. The determination of the benefit obligation for those who are retired and covered involves estimating the survival and future claims for them and then discounting those future claims for the present time. With regard to the active group, a further estimate must be made regarding who will actually survive, in active employment, to retire and be covered after employment.



**CITY OF JERSEY CITY  
NOTES TO FINANCIAL STATEMENTS**

**DECEMBER 31, 2017 AND 2016**

**NOTE G. POST-EMPLOYMENT BENEFITS (continued)**

**Actuarial Valuation Results – continued**

The Actuarial Accrued Liability is as follows:

Summary of Valuation Results - December 31, 2016	
Actuarial Accrued Liability	
Retirees	\$ 561,855,273
Active or Terminated Vested Participants Not Yet Retired	74,847,202
Other Active Participants	399,343,585
Unfunded Actuarial Accrued Liability	\$ 1,036,046,060
Discount Rate	4.50%
Normal Cost	\$ 39,125,035
Annual Amount Toward Unfunded Actuarial Accrued Liability	60,865,518
Annual Required Contribution	99,990,553
Less: Actuarial Determined City Contribution (estimated)	28,476,360
Net Increase	\$ 71,514,193

**Actuarial Assumptions and Methods**

*Turnover* – The actuary assumed that terminations of employment other than for death or retirement will occur in the future in accordance with twice the rate of the US Office of Personnel Management regarding the experience of the employee group covered by the Federal Employees Retirement System some excerpts from which are:

<u>Age</u>	<u>Termination Percent</u>
20	35.2%
40	8.0%
50	0.0%

Furthermore, the actuary assumed no terminations of employment other than for death or retirement once an employee accrued ten years of service.

**CITY OF JERSEY CITY  
NOTES TO FINANCIAL STATEMENTS**

**DECEMBER 31, 2017 AND 2016**

**NOTE G. POST-EMPLOYMENT BENEFITS (continued)**

**Actuarial Assumptions – continued**

The remaining actuarial assumptions used to value the City’s post-employment benefits are as follows:

- Mortality:* The mortality table employed is the 1994 sex distinct Group Annuity Mortality Table.
- Disability:* No terminations of employment due to disability. Retirees resulting from a disability were factored into the actuary’s determination of age at retirement.
- Age at Retirement:* Police and Fire active employees, on average, will receive their benefits when eligible but no earlier than age 45. For those eligible to retire at such age, a 10% load in the actuarial liabilities was included. Civilian active employees, on average, will receive their benefits when eligible but no earlier than age 55.
- Spousal Coverage:* Married employees will remain married.
- Prior Service:* No prior service for active employees.
- Health Care Cost of Inflation:* Health care gross costs will increase at an annual rate of 7.0% for both Pre-Medicare and Post-Medicare benefits.
- Administration Expenses:* The annual cost to administer the retiree claims, approximately 2%, is included in the annual health care costs.
- Final Average Salary:* The actuary assumed that the final average salary for retirees age 55 and over is \$78,000.
- Current Per Capita Claims Costs:* An annual average gross claims costs of \$11,880 per covered retiree was used based on review of claims data for the 24 month period July 1, 2015 through December 31, 2016.

**Methods**

*Actuarial Cost Method* - There are several acceptable actuarial methods listed in the GASB standard. The actuarial cost method used to determine the plan’s costs is the “unit credit” cost method in establishing the annual required contribution and actuarial accrued liability for the participants.

*Asset Valuation Method* - The plan is currently unfunded.

*Amortization Method and Period* - The unfunded actuarial accrued liability is amortized as a level dollar amount using an open period of 30 years.

**CITY OF JERSEY CITY  
NOTES TO FINANCIAL STATEMENTS**

**DECEMBER 31, 2017 AND 2016**

**NOTE H. COMPENSATED ABSENCES**

Under the existing contracts and policies of the City, certain employees are allowed to accumulate certain levels of vacation and sick pay over the duration of their employment. As of December 31, 2017 and 2016, the total accumulated absence liability was \$108,439,233 and \$116,308,347, respectively. As of December 31, 2017 and 2016, the City had no reserves available to fund such obligations.

During the year ended December 31, 2017, the City appropriated in its budget and expended \$10,061,022 for compensated absences. During the year ended December 31, 2016, the City expended \$8,373,405 for compensated absences, \$1,634,427 from its accumulated absence reserve and the remaining \$6,738,978 was expended without appropriation, and which was funded in the 2017 budget, as required by statute.

As described more fully in Note D, total Special Emergency Notes issued for contractual severance payments and outstanding as of December 31, 2017 and 2016 were \$9,700,000 and \$14,700,000, respectively. No additional emergency appropriations were passed since 2015.

**NOTE I. RISK MANAGEMENT**

Disaster Recovery

The City has entered into contracts with various vendors in an effort to protect its financial processes and data in the event unforeseen disaster should occur. Included in these contracts are offsite storage of financial data tapes and payroll data offsite backup. The latter also provides the City the ability to run such process offsite if needed.

Insurance Coverage

The City established a self-insurance program in 1982 in accordance with New Jersey Statute Chapter 40:10-6. The Chapter enables the governing body of any local unit to create a fund to provide insurance coverage for its exposure to a wide variety of property casualty risks, including property damage caused to any of the unit's property, motor vehicles, equipment or apparatus; liability resulting from the use or operation of such motor vehicles, equipment or apparatus; liability for the unit's negligence, including that of its officers, employees and servants and workers' compensation obligations.

**CITY OF JERSEY CITY  
NOTES TO FINANCIAL STATEMENTS**

**DECEMBER 31, 2017 AND 2016**

**NOTE I. RISK MANAGEMENT (continued)**

Insurance Coverage - continued

The City self insures against tort claims (including claims arising from the use of motor vehicles), claims arising from police activities, unemployment compensation and workers' compensation lawsuits.

The City has also obtained the following coverage:

- ◆ Public officials' liability insurance with limits of \$1,000,000 for employee theft, \$1,500,000 for premises theft, \$500,000 for computer fraud and \$500,000 for forgery.
- ◆ Directors and Officers liability policy with limits of \$2,000,000.
- ◆ General liability excess coverage of \$2,500,000 per occurrence, \$10,000,000 aggregate, per occurrence limit of \$2,000,000 for workers' compensation claims.
- ◆ Building coverage ranging from \$33,600 to \$25,154,150, depending on the location insured.
- ◆ Business personal property coverage ranging from \$20,808 to \$25,154,150, depending on the location insured.
- ◆ Total property coverage of \$246,825,449.
- ◆ Commercial watercraft insurance providing hull coverage for \$1,671,422 and protection and indemnity coverage in the amount of \$1,000,000 per incident.
- ◆ Recreation Department liability policy with limits of \$1,000,000.
- ◆ Flood insurance for various buildings totaling \$630,000.
- ◆ Site pollution incident legal liability select (spills) coverage in the amount of \$25,000,000.

**NOTE J. CLEARING ACCOUNT**

The City maintains a clearing account in the Current Fund General Ledger so that cash received for revenues may be deposited promptly and distributed to proper accounts at a later date. The City also maintains a claims account, or a cash clearing bank account, from which bills are paid for the Current, Trust and Capital Funds.

**CITY OF JERSEY CITY  
NOTES TO FINANCIAL STATEMENTS**

**DECEMBER 31, 2017 AND 2016**

**NOTE K. PREPAID DEBT SERVICE – QUALIFIED BONDS**

The City reverted its fiscal year from one ending June 30, annually, to one ending December 31, annually. This resulted in a six month transition year as follows:

12 months ended June 30, 2010.....	Final “June 30” Year End
July 1, 2010 through December 31, 2010.....	Six Month Transition Year
January 1, 2011 through December 31, 2011.....	First “December 31” Year End

The Division requires municipalities reverting to a calendar year to anticipate a full year of State Aid during the six month Transition Year. Whereas the City receives State Aid in two forms; (1) direct cash receipts from the State, and (2) debt payments made by the State on behalf of the City (Qualified Bonds), the City realized State Aid during the Transition Year as follows:

<u>Six Month Transition Year Ended December 31, 2010</u>		
State Aid Anticipated		\$ 66,933,632
Less:		
State Aid Received in Cash	\$ 28,599,305	
Qualified Bond Program Payments	21,329,093	
Subtotal: Aid Received		49,928,398
Prepaid Debt Service (To Realize State Aid in Full)		\$ 17,005,234

As a result, the City recognized State Aid revenues in the amount of \$17,005,234 for debt service payments of the succeeding year, resulting in prepaid debt service at year end.

The following schedule summarizes the State Aid received, qualified bond payments applied and the prepaid amounts as of December 31, 2017 and 2016.

	2017	2016
Balance, Beginning of Year	\$ 12,562,462	\$ 17,029,830
Add: State Aid	67,050,310	69,465,660
	79,612,772	86,495,490
Less: Received in Cash	21,867,610	25,893,268
Qualified Bond Payments	46,019,272	48,039,760
Balance, End of Year	\$ 11,725,890	\$ 12,562,462

**CITY OF JERSEY CITY  
NOTES TO FINANCIAL STATEMENTS**

**DECEMBER 31, 2017 AND 2016**

**NOTE L. FIXED ASSETS**

In accordance with accounting practices prescribed by the Division, and as further detailed in Note A, no depreciation has been provided for and fixed assets acquired through grants in aid or contributed capital have not been accounted for separately. The City had the following investment balance and activity in general fixed assets as of and for the year ended December 31, 2017:

	Balance,	Activity During Current Year		Balance,
	Dec. 31, 2016	Additions	Dispositions	Dec. 31, 2017
Land	\$ 138,916,522	\$ -	\$ 11,156,322	\$ 127,760,200
Improvements	130,980,911	100,667,505	-	231,648,416
Machinery and Equipment	79,395,979	-	24,472,265	54,923,714
	<u>\$ 349,293,412</u>	<u>\$ 100,667,505</u>	<u>\$ 35,628,587</u>	<u>\$ 414,332,330</u>

The City had the following investment balance and activity in general fixed assets as of and for the year ended December 31, 2016:

	Balance,	Activity During Current Year		Balance,
	Dec. 31, 2015	Additions	Dispositions	Dec. 31, 2016
Land	\$ 135,599,800	\$ 3,316,722	\$ -	\$ 138,916,522
Improvements	125,658,997	5,321,914	-	130,980,911
Machinery and Equipment	62,024,548	17,371,431	-	79,395,979
	<u>\$ 323,283,345</u>	<u>\$ 26,010,067</u>	<u>\$ -</u>	<u>\$ 349,293,412</u>

**NOTE M. PREPAYMENTS OF PILOT REVENUES**

The City has entered into certain financial agreements under the Long Term Tax Exemption Law, which allows developers to pay Annual Service Charges in Lieu of Taxes (PILOTs) upon completion of such construction projects. The City further structured many PILOT agreements prior to 2009 whereas (a) entities would prepay to the City, upon execution of the agreement and well in advance of project completion, the first year's estimated Annual Service Charge and (b) the City would be required to refund or credit this prepayment to the entity once the project is completed, typically over a period of four years.

The City realized these prepayments as revenues in the period received. In each of the first four years after project completion, the City reduces the amount of revenues from the calculated Annual Service Charges by crediting 25% of the prepaid amount each year. As of December 31, 2017 and 2016, the balance of City revenues collected in prior years which will be applied as refunds and credits on Annual Services Charges was \$10,725,000 (estimated) and \$12,725,940, each year.

**CITY OF JERSEY CITY  
NOTES TO FINANCIAL STATEMENTS**

**DECEMBER 31, 2017 AND 2016**

**NOTE N. DEFERRED CHARGES TO BE RAISED IN SUCCEEDING BUDGETS**

Certain expenditures are required to be deferred to budgets of succeeding years. At December 31, 2017, the following deferred charges are shown on the balance sheets of the various funds. The appropriations in the 2018 budget are not less than that required by statute.

	Balance, Dec. 31, 2016	Add: Results of Current Year	Less: 2017 Budget Appropriation	Balance, Dec. 31, 2017	2018 Budget Appropriation	Balance to Succeeding Budgets
<b>Current Fund:</b>						
Special Emergency Authorizations (40A:4-53.b) Revaluation of Properties-2016	\$ 5,000,000	\$ -	\$ 1,000,000	\$ 4,000,000	\$ 1,000,000	\$ 3,000,000
Special Emergency Authorizations (40A:4-53.b) Contractual Severance Payments-2013	3,800,000	-	1,900,000	1,900,000	1,900,000	-
Contractual Severance Payments-2014	4,500,000	-	1,500,000	3,000,000	1,500,000	1,500,000
Contractual Severance Payments-2015	6,400,000	-	1,600,000	4,800,000	1,600,000	3,200,000
Special Emergency Authorizations (40A:4-54) Superstorm Sandy	932,496	-	932,496	-	-	-
Expenditure without an Appropriation Contractual Severance Payments-2016	6,738,978	-	6,738,978	-	-	-
<b>Trust Fund:</b>						
Overexpenditure of Private Duty Reserve	-	153,900	-	153,900	153,900	-
	<u>\$ 27,371,474</u>	<u>\$ 153,900</u>	<u>\$ 13,671,474</u>	<u>\$ 13,853,900</u>	<u>\$ 6,153,900</u>	<u>\$ 7,700,000</u>

Further descriptions of the above deferred charges follow.

**Contractual Severance Liabilities** - A significant number of employees either retired or otherwise had their employment with the City terminated. The City passed special emergency appropriations to provide for payment of the resulting severance liabilities in 2015, 2014, 2013 and for \$8,000,000, \$7,500,000, \$9,500,000, and \$9,500,000, respectively. The current balance to be raised is noted in the preceding table. The special emergency appropriations were financed with special emergency notes, discussed further in Note D.

**Superstorm Sandy** - During the year ended December 31, 2012, the City suffered extensive damages from the effects of Superstorm Sandy and subsequent flooding. The City passed Resolution No. 12-842 which consisted of two emergencies related to this storm. The first is a \$580,000 emergency appropriation and the second is a \$15,420,000 special emergency appropriation. On March 28, 2013, the City adopted Ordinance No. 13-031 which re-appropriated \$10,000,000 of this emergency as a capital ordinance for items as allowable under State statutes. The current balance to be raised in future current fund budgets is noted in the preceding table.

**CITY OF JERSEY CITY  
NOTES TO FINANCIAL STATEMENTS**

**DECEMBER 31, 2017 AND 2016**

**NOTE N. DEFERRED CHARGES TO BE RAISED IN SUCCEEDING BUDGETS (continued)**

**Revaluation of Properties** - During the year ended December 31, 2016, the City passed a Special Emergency Appropriation in the amount of \$5,000,000 for the preparation and execution of a complete program of revaluation of real property for the use of the local assessor. The current balance to be raised is noted in the preceding table.

**Expenditure without Appropriation** - During the year ended December 31, 2016, the City expended \$6,738,978 for contractual severance liabilities for which there was no legal appropriation. In accordance with N.J.S.A. 40A:4-57, such expenditure without appropriation is required to be raised in full in the budget of the succeeding year.

**Overexpenditure of Trust Fund Reserve** - During the year ended December 31, 2016, the City expended \$153,900 in excess of funds collected for Private Duty fees. This deferred charge was established in 2017 and is raised in full in the budget of 2018.

**NOTE O. RELATED PARTY TRANSACTIONS**

**JERSEY CITY MUNICIPAL UTILITIES AUTHORITY**

On February 1, 1998, the City transferred its water operating functions to the Jersey City Municipal Utilities Authority (JCMUA). Pursuant to the franchise and service agreement, the City and the JCMUA agreed that the JCMUA will, in addition to paying the City an up-front franchise fee and annual franchise concession fees, (a) assume the responsibility for and the payment of the principal and interest on the City's water bonds; (b) pay the City for the oversight of the operations of the water system and (c) provide water and sewer service to the City free of charge for all governmental public facilities as identified by the City.

As noted above, the JCMUA is responsible to reimburse the City for payments of principal and interest on water bonds. The amount of Water Serial Bonds payable, and therefore the corresponding amount receivable from the JCMUA to the City's Capital Fund, at December 31, 2017 and 2016 was \$21,150,000 and \$25,590,000, respectively.

During the year ended June 30, 2003, the City and the JCMUA agreed to extend the franchise agreement through March 31, 2028 for the price of \$42,000,000. The City received \$28,000,000 for the franchise extension in 2003 and 2004 combined, while the final payment of \$14,000,000 was deferred and collected in 2016, rendering the balance due collected in full.



**CITY OF JERSEY CITY  
NOTES TO FINANCIAL STATEMENTS**

**DECEMBER 31, 2017 AND 2016**

**NOTE O. RELATED PARTY TRANSACTIONS (continued)**

**JERSEY CITY BOARD OF EDUCATION**

As described in Note D, although the Jersey City Board of Education (JCBOE) is a Type II School District effective November 4, 2008, prior to that date the Board of Education operated as a Type I School District, therefore, bonds and notes authorized by the Board of Education prior to November 4, 2008 are general obligations of the City, are reported on the balance sheet of the City's General Capital Fund and are accordingly included in the summary of municipal debt. The City budgets the principal and interest payments of the Board of Education's obligations as they become due. These obligations are funded by the City through an amount to be raised by taxation called "addition to local district school tax", less any regular school debt service aid received from the State of New Jersey.

For the years ended December 31, 2017 and 2016, the City's budget included the following debt service requirements of the Board of Education and corresponding anticipated revenues:

	Dec. 31, 2017	Dec. 31, 2016
Debt Service Requirements of the Board of Education:		
Maturing Serial Bonds - School Qualified	\$ 6,325,000	\$ 12,355,000
Interest on Bonds - School Qualified	780,819	1,006,441
	7,105,819	13,361,441
Less: Applicable Revenues Anticipated		
Building Aid Allowance for School Aid*	3,189,788	5,658,968
Balance for Support of Board of Education:		
Addition to Local District School Tax	\$ 3,916,031	\$ 7,702,473

**NOTE P. INTERFUND BALANCES**

The City has various transactions by and between its individual funds. Certain accounts of the Trust and Capital Funds earn interest which is required to be recorded as revenue in the Current Fund budget. Other transactions include budget appropriations in the Current Fund which are required to be turned over to the Federal and State Grant, Trust and Capital Funds. All these transfers are routine and are consistent with the activities of the funds making the transfers.

**CITY OF JERSEY CITY  
NOTES TO FINANCIAL STATEMENTS**

**DECEMBER 31, 2017 AND 2016**

**NOTE O. RELATED PARTY TRANSACTIONS (continued)**

During the year ended December 31, 2017, the City overpaid \$1,604,940 to the JCMUA for sewer and water fees collected as a result of its annual accelerated tax sale. This amount appears as a receivable on the City's Current Fund balance sheet as of December 31, 2017.

A summary of the amounts due from the JCMUA at December 31, 2017 is as follows:

	<u>Balance Dec. 31, 2016</u>	<u>Increased</u>	<u>Payments Received</u>	<u>Balance Dec. 31, 2017</u>
Current Fund:				
Overpayment of Tax Sale Fees	\$ -	\$ 1,604,940	\$ -	\$ 1,604,940
Capital Fund:				
Water Bond Principal	<u>25,590,000</u>	<u>-</u>	<u>2,535,000</u>	<u>23,055,000</u>
	<u>\$ 25,590,000</u>	<u>\$ 1,604,940</u>	<u>\$ 2,535,000</u>	<u>\$ 24,659,940</u>

A summary of the amounts due from the JCMUA at December 31, 2016 is as follows:

	<u>Balance Dec. 31, 2015</u>	<u>Additional Debt Issued</u>	<u>Payments Received</u>	<u>Balance Dec. 31, 2016</u>
Current Fund:				
Franchise Extension Agreement	\$ 14,000,000	\$ -	\$ 14,000,000	\$ -
Capital Fund:				
Water Bond Principal	<u>28,645,000</u>	<u>190,000</u>	<u>3,245,000</u>	<u>25,590,000</u>
	<u>\$ 42,645,000</u>	<u>\$ 190,000</u>	<u>\$ 17,245,000</u>	<u>\$ 25,590,000</u>

During the year ended December 31, 2017 and 2016, the City also received the following payments from the JCMUA:

- ◆ Franchise Concession Payments of \$21,000,000 and \$20,000,001, respectively.
- ◆ Franchise Extension Fees of \$-0- and \$14,000,000, respectively (as described in the preceding paragraphs)
- ◆ Water Debt Service Payments of \$5,189,955 (for principal of \$4,440,000 and interest of \$749,955) and \$3,837,778 (for principal of \$2,950,000 and interest of \$887,778), respectively.
- ◆ Deferred Charges to Future Water Rents of \$1,461,658 and \$-0-, respectively, for the purpose of funding fully expended improvement authorizations that were not funded by notes or bonds.

**CITY OF JERSEY CITY  
NOTES TO FINANCIAL STATEMENTS**

**DECEMBER 31, 2017 AND 2016**

**NOTE P. INTERFUND BALANCES (continued)**

Transfers by and between the City's funds during the years ended December 31, 2017 and 2016 consisted of the following:

	December 31, 2017		December 31, 2016	
	Transfers In	Transfers Out	Transfers In	Transfers Out
Current Fund	\$ 437,602,709	\$ 449,142,132	\$ 287,336,721	\$ 287,174,745
Federal & State Grants Fund	28,787,813	28,489,066	24,784,423	23,667,351
General Capital Fund	65,749,520	65,611,465	1,398,353	2,517,139
Animal Control Fund	324	241		17
Trust Fund - Other Funds	27,996,403	27,765,614	11,043,625	11,170,841
Open Space Trust Fund	623,000	1,246,000	-	-
Payroll Clearing Fund	335,736,542	324,241,793	252,945,712	252,978,741
	<u>\$ 896,496,311</u>	<u>\$ 896,496,311</u>	<u>\$ 577,508,834</u>	<u>\$ 577,508,834</u>

Current Fund interfunds receivable are fully reserved and recognized as credits to operations in the year the interfunds are received in cash. Interfunds receivable in the Trust Funds and General Capital Fund are not reserved. The City expects to fully repay all balances in the subsequent year.

As of December 31, 2017, the City had the following interfunds on its balance sheets:

Amount	Due From Fund	Due To Fund	Purpose
\$ 103,817	Grants	Trust - Other	Off Duty Police from Prior Year
500,009	General Capital	Trust - Other	Charged Incorrect Fund for Equip.
85,328	Current	Trust - Other	Anticipated Revenues
236,814	Trust - Other	Current	Various Trust Sub-Accounts
623,000	Trust - Other	Open Space	Levy Transferred to Incorrect Fund
63,481	Trust - Other	Payroll Clearing	Federal Grant Payrolls
96	Animal Control	Current	Miscellaneous
11,469,449	Payroll Clearing	Current	Erroneous Payroll Transfers
9,086	Grants	Payroll Clearing	Grant Share of Payroll Costs
329,337	Current	General Capital	Budget Appropriation and Interest
142,235	Grants	Current	Reserves Cancelled / Chargebacks

As of December 31, 2016, the City had the following interfunds on its balance sheets:

Amount	Due From Fund	Due To Fund	Purpose
\$ 147,426	Current	Grants	Grant Cancelled in Prior Year
2,587	Current	Trust - Other	Miscellaneous
32,617	General Capital	Current	Interest Earned
13	Animal Control	Current	Miscellaneous
71	Payroll Clearing	Current	Miscellaneous
11,818	Trust - Other	Current	Anticipated Revenues
103,817	Trust - Other	Grants	Off Duty Police
97,938	Payroll Clearing	Trust - Other	Federal Grant Charges

**CITY OF JERSEY CITY  
NOTES TO FINANCIAL STATEMENTS**

**DECEMBER 31, 2017 AND 2016**

**NOTE Q. REVENUE ACCOUNTS RECEIVABLE**

Revenue accounts receivable include various receivables due from entities for revenues anticipated in support of the City's budget. These receivables are fully reserved.

The following table illustrates the activity of the revenue accounts receivable balances for the year ended December, 2017:

	Balance Dec. 31, 2016	Current Year Accruals	Collections	Balance Dec. 31, 2017
Municipal Court Fines and Costs	\$ 1,115,339	\$ 16,459,799	\$ 16,329,597	\$ 1,245,541
Parking Enforcement Fees	-	1,763,676	1,648,882	114,794
Total of Revenue Accounts Not Accruing Receivables	-	221,999,939	221,999,939	-
Total Revenue Accounts Receivable	<u>\$ 1,115,339</u>	<u>\$ 240,223,414</u>	<u>\$ 239,978,418</u>	<u>\$ 1,360,335</u>

The following table illustrates the activity of the revenue accounts receivable balances for the year ended December, 2016:

	Balance Dec. 31, 2015	Current Year Accruals	Collections	Balance Dec. 31, 2016
Hackensack Meadowlands Adjustment	\$ 44,615	\$ 605,487	\$ 650,102	\$ -
Municipal Court Fines and Costs	1,026,824	13,680,522	13,592,007	1,115,339
Due from FEMA (Hurricane Sandy)	846,146	773,724	1,619,870	-
Total of Revenue Accounts Not Accruing Receivables	-	224,771,063	224,771,063	-
Total Revenue Accounts Receivable	<u>\$ 1,917,585</u>	<u>\$ 239,830,796</u>	<u>\$ 240,633,042</u>	<u>\$ 1,115,339</u>

**NOTE R. ECONOMIC DEPENDENCY**

State Aid

The City is a recipient of State Aid. During the years ended December 31, 2017 and 2016, State Aid accounted for 11% and 12%, respectively, of the City's realized revenues. Significant changes in State Aid policy, if they were to occur, in conjunction with legislation capping increases to the tax levy, could have a material impact on the City's operations, if any such policy modifications were to occur.

**CITY OF JERSEY CITY  
NOTES TO FINANCIAL STATEMENTS**

**DECEMBER 31, 2017 AND 2016**

**NOTE R. ECONOMIC DEPENDENCY (continued)**

Major Taxpayers

The City does not have significant economic dependence on any one taxpayer. However, the ten largest taxpayers of the City as listed in the table on the following page comprise 8.7% and 10.5%, respectively, of the City's total tax levies for the years ended December 31, 2017 and 2016.

**2017 Top 10 Taxpayers**

Name	Type	Assessed Value
1. Mack Cali Plaza II & III.....	Office.....	\$ 102,942,500
2. 101 Hudson Realty, LLC.....	Office.....	90,855,800
	Mixed - Retail,	
3. Newport Centre (Rego Park).....	Office, Hotel...	70,111,500
4. Newport Centre, LLC.....	Shopping.....	58,088,000
5. MEPT Newport Tower.....	Office.....	45,000,000
6. John Hancock Life Insurance.....	Office.....	43,215,400
7. Wells REIT II - Int'l Financial Tower.....	Office.....	35,625,000
8. Grove Pointe Urban Renewal.....	Development..	34,512,100
9. RREEF America REIT II.....	Warehousing..	30,406,200
10. Tower East, U.R. ....	Development..	30,194,000
		<u>\$ 540,950,500</u>
	Net Valuation Taxable	\$ 6,229,997,658
Top 10 Taxpayers as a Percentage of Assessments		8.7%

**2016 Top 10 Taxpayers**

Name	Type	Assessed Value
1. NC Housing Associates.....	Office.....	\$ 132,666,800
2. Cali Harborside Associates.....	Office.....	120,092,000
3. 101 Hudson St. Associates.....	Office.....	90,855,800
4. Newport Centre, LLC (Indianapolis).....	Shopping.....	58,088,000
5. MEPT Newport Tower.....	Office.....	45,000,000
6. John Hancock Life Insurance.....	Office.....	43,490,400
7. 70 Columbus Urban Renewal, LLC.....	Office.....	42,775,100
	Mixed - Retail,	
8. Newport Center (Rego Park).....	Office, Hotel...	39,253,400
9. Wells REIT.....	Office.....	35,625,000
	Mixed - Residential,	
10. Grove Pointe, Urban Renewal.....	Office, Retail...	34,512,000
		<u>\$ 642,358,500</u>
	Net Valuation Taxable	\$ 6,093,045,338
Top 10 Taxpayers as a Percentage of Assessments		10.5%

**CITY OF JERSEY CITY  
NOTES TO FINANCIAL STATEMENTS**

**DECEMBER 31, 2017 AND 2016**

**NOTE R. ECONOMIC DEPENDENCY (continued)**

Major Payers in Lieu of Taxes

Below are listed the ten largest PILOT agreements in terms of realized revenues for the years ended December 31, 2017 and 2016. These PILOT agreements comprise 28% and 27.7%, respectively, of the PILOT revenues collected and 6.4% and 6.3%, respectively, of total Current Fund revenues.

2016 Top 10 PILOTs		2017 Top 10 PILOTs	
Name	Payment	Name	Payment
K. Hovnanian at 77 Hudson St., Urban Renewal Co., LLC .....	\$ 5,127,959	K. Hovnanian at 77 Hudson St., Urban Renewal Co., LLC .....	\$ 5,461,594
Vector UR Assoc. I (Harborspire I) ....	4,487,423	Cali Harbor Plaza V .....	5,004,793
30 Hudson Street .....	4,432,741	Vector UR Assoc. I (Harborspire I) ....	4,649,159
Port Liberte II .....	4,029,645	GSJC 30 Hudson Street .....	4,420,115
Cali Harbor Plaza V .....	3,731,479	James Monroe .....	3,769,187
James Monroe .....	3,642,976	Libert Towers Urban Renewal Essex Waterfront .....	3,711,896
Libert Towers Urban Renewal Essex Waterfront .....	3,580,777	Liberty Harbor North, Urban Renewal (Metro Homes) - Gulls Cove .....	3,227,499
90 Hudson Urban Renewal .....	3,140,919	90 Hudson Urban Renewal .....	3,180,776
EQR at 77 Hudson Street .....	3,016,749	Newport Office Center IV .....	3,168,588
Newport Office Center VII .....	2,920,031	Portofino Towers .....	3,162,570
	<u>\$ 38,110,699</u>		<u>\$ 39,756,177</u>
Total PILOT Revenues	\$ 137,532,843	Total PILOT Revenues	\$ 141,808,933
Top 10 PILOT Revenues as a Percentage of:		Top 10 PILOT Revenues as a Percentage of:	
PILOT Revenues	27.7%	PILOT Revenues	28.0%
Total Revenues	6.3%	Total Revenues	6.4%

**NOTE S. LEASE COMMITMENTS**

The City has various operating and capital lease commitments at December 31, 2017 and 2016 for office space, employee parking, police vehicles and fire apparatus.

Descriptions of the capital leases follow:

**Fire Apparatus** – In 2014 the City acquired two fire apparatus for a total original cost of \$1,761,871. The terms of these leases are 7 and 8 years with total annual payments of \$232,769 through 2021 and a payment of \$132,488 in 2022.

**CITY OF JERSEY CITY  
NOTES TO FINANCIAL STATEMENTS**

**DECEMBER 31, 2017 AND 2016**

**NOTE S. LEASE COMMITMENTS (continued)**

**Police Vehicles** – In 2016, the City entered into two leases for the acquisition of a total of 29 police interceptor vehicles and 3 SUVs. The first lease is for 24 police interceptor with total annual payments of \$241,920 from December 15, 2016 through December 15, 2020. The second lease is for five police interceptor vehicles and three SUVs with total annual payments of \$83,700 from December 15, 2016 through December 15, 2020. Both leases contained a bargain purchase option of \$1 for each vehicle.

**MLK HUB** - A \$1 bargain purchase option for the “MLK HUB” located at the intersection of Kearney Avenue and Martin Luther King Drive as authorized by Ordinance No. 15.020 adopted on March 11, 2015. The basic term of this lease agreement is 25 year bondable triple net lease with base rent payments commencing on the date of substantial completion of the building, but not later than February 1, 2017. Annual rent will range from a minimum of \$963,000 in the first five years of the lease to a minimum payment of \$1,944,708 in year 25. Total minimum payments under the lease would be \$35,889,174.

The minimum future operating and capital lease payments are as follows:

Year Ended December 31,	Total	Operating	Capital
2018	\$ 2,618,379	\$ 1,004,739	\$ 1,613,640
2019	1,874,968	261,328	1,613,640
2020	1,809,811	213,226	1,596,585
2021	1,504,444	216,424	1,288,020
2022	1,639,752	219,671	1,420,081
2023-2027	8,098,189	1,096,242	7,001,947
2028-2032	8,518,583	1,118,398	7,400,185
2033-2037	9,098,713	726,163	8,372,550
2038-2042	7,645,653	-	7,645,653
	<u>\$ 42,808,492</u>	<u>\$ 4,856,191</u>	<u>\$ 37,952,301</u>

**CITY OF JERSEY CITY  
NOTES TO FINANCIAL STATEMENTS**

**DECEMBER 31, 2017 AND 2016**

**NOTE T. AGGREGATION OF ENCUMBRANCES**

Other significant commitments include encumbrances outstanding for the Current, Trust and General Capital Funds.

Below are the aggregated outstanding encumbrances as of December 31, 2017.

	<u>Current Fund</u>	<u>Federal and State Grants Fund</u>	<u>Trust Funds</u>	<u>General Capital Fund</u>	<u>Total Encumbrances</u>
Budget Year 2017	\$ 26,654,920	\$ -	\$ -	\$ -	\$ 26,654,920
Other Reserves	1,412,144	-	-	71,589	1,483,733
H. Sandy Expenditures	730	-	-	-	730
Animal Control Fund	-	-	3,344	-	3,344
Other Trust Fund	-	-	17,456,304	-	17,456,304
Grant Reserves	-	7,041,726	-	-	7,041,726
Improvement Authorizations	-	-	-	14,394,670	14,394,670
	<u>\$ 28,067,794</u>	<u>\$ 7,041,726</u>	<u>\$ 17,459,648</u>	<u>\$ 14,466,259</u>	<u>\$ 67,035,427</u>

Below are the aggregated outstanding encumbrances as of December 31, 2016.

	<u>Current Fund</u>	<u>Federal and State Grants Fund</u>	<u>Trust Funds</u>	<u>General Capital Fund</u>	<u>Total Encumbrances</u>
Budget Year 2016	\$ 18,262,345	\$ -	\$ -	\$ -	\$ 18,262,345
Other Reserves	16,035	-	-	131,286	147,321
Revaluation	1,170,000	-	-	-	1,170,000
H. Sandy Expenditures	730	-	-	-	730
Animal Control Fund	-	-	8,131	-	8,131
Other Trust Fund	-	-	23,387,753	-	23,387,753
Grant Reserves	-	12,426,499	-	-	12,426,499
Improvement Authorizations	-	-	-	15,892,531	15,892,531
	<u>\$ 19,449,110</u>	<u>\$ 12,426,499</u>	<u>\$ 23,395,884</u>	<u>\$ 16,023,817</u>	<u>\$ 71,295,310</u>

All encumbrances noted above are included on the balance sheets of the City.



**CITY OF JERSEY CITY  
NOTES TO FINANCIAL STATEMENTS**

**DECEMBER 31, 2017 AND 2016**

**NOTE U. TAX ABATEMENTS**

The City negotiates property tax abatement agreements on an individual basis. The City has tax abatement agreements with approximately 180 entities as of December 31, 2017:

Purpose of Agreements	Taxing Government	Taxes if Billed	Received for	Payments	Taxes Abated		Aggregate Reduction of Government Revenue
		at Full 2017 Tax Rate	Payments in Lieu of Taxes & Land Tax	to Other Governments	Amount	(%)	
Construction of Commercial and Residential Redevelopment Projects, Low and Moderate Income Housing Projects and Relocation Projects	School	\$ 51,950,931	\$ -	\$ -	\$ 51,950,931	100%	\$ -
	County	56,095,988	-	2,822,041	53,273,047	95%	-
	City	103,224,713	144,360,683	(2,822,041)	(38,313,929)	-37%	-
	<b>Total</b>	<b>\$ 211,270,732</b>	<b>\$ 144,360,683</b>	<b>\$ -</b>	<b>\$ 66,910,049</b>	<b>32%</b>	<b>\$ -</b>
	Budget Revenues		\$ 141,808,933				
	Non-Budget Revenues		2,551,750				
			<b>\$ 144,360,683</b>				

The full amount to be raised by taxes for support of each Government's budget is levied on properties not subject to such agreements, therefore there is no aggregate reduction of tax revenue to the Governments as a result of the abatement.

These agreements were negotiated under the Long Term Tax Exemption Law, N.J.S.A. 40A:20-1 et seq. (the Law), which authorizes municipalities to enter into financial agreements with Urban Renewal Entities. An Urban Renewal Entity is a limited-dividend entity or a nonprofit entity which undertakes redevelopment projects (both commercial and residential), relocation projects for residents displaced by the redevelopment area, and low and moderate income housing projects in return for tax exemptions, or payments in lieu of taxes referred to as "annual service charges".

The Law allows annual service charges to be calculated as a percentage of either gross revenue from each unit of the project or from total project cost, if the project is not undertaken in units. In the case of low and moderate income housing projects, the annual service charge shall not exceed 15% of annual gross revenue or 2% of total project cost. For all other projects, the annual service charge shall not be less than 10% of annual gross revenue or 2% of total project cost. The City's abatements are across in multiple categories. There are a total of five stages in the abatement period. The final four phases require the Urban Renewal Entity to remit the greater of the agreed upon annual service charge or 20%, 40%, 60% and 80%, respectively, of the amount of taxes otherwise due on the value of the land and improvements.

**CITY OF JERSEY CITY  
NOTES TO FINANCIAL STATEMENTS**

**DECEMBER 31, 2017 AND 2016**

**NOTE U. TAX ABATEMENTS (continued)**

The Law only allows for taxes on improvements to be abated. Taxes on land are billed quarterly to the Urban Renewal Entity and are credited against the annual service charges due. To administer the billing, the land value and improvement value of the abated property are separate line items in the tax assessment and collection records. The land value is billed quarterly at the total property tax rate. The improvement value is classified as exempt property (Class 15F), generating no bill.

Under the Law, abatements may provide for an exemption period of less than 30 years from the completion of the entire project or less than 35 years from the execution of the financial agreement. Further, Urban Renewal Entity profits are restricted and any excess profits are payable to the municipality as an additional annual service charge.

The Law does not provide for the recapture of abated taxes in the event an abatement recipient does not fulfill the commitment it makes in return for the tax abatement. However, in the event of default, the City has the right to proceed against the property pursuant to the In Rem Tax Foreclosure Act, N.J.S.A. 54:5-1 and/or may terminate the agreement. The City has not made any commitments as part of the agreements other than to reduce taxes. The City is not subject to any tax abatement agreements entered into by other governmental entities.

**NOTE V. CONTINGENCIES**

Non-Recourse Debt

On November 13, 2013, the City adopted Ordinances 13.122 through 13.124 approving the execution of financial agreements with Journal Square I Urban Renewal, LLC, Journal Square II Urban Renewal, LLC and Journal Square III Urban Renewal, LLC related to the authorization and issuance by the Jersey City Redevelopment Agency of not to exceed \$10,000,000 for each agreement (\$30,000,000 total) of Redevelopment Area Bonds.

On February 8, 2017, Ordinance 16.194 was adopted approving the execution of a financial agreement with Paulus Hook Urban Renewal, LLC related to the authorization and issuance by the Jersey City Redevelopment Agency of not to exceed \$1,000,000 of Redevelopment Area Bonds

Under N.J.S.A. 40A:12A-67, these bonds are issued as non-recourse obligations to the full faith and credit of the City and are not considered to be direct and general obligations of the City. The City is not obligated to levy and collect tax sufficient in an amount to pay the principal and interest on the bonds when they become due and payable. Further, these bonds are not considered gross debt of the City on any debt statement filed in accordance with the Local Bond Law, N.J.S.A. 40A:2-1 et sq.

**CITY OF JERSEY CITY  
NOTES TO FINANCIAL STATEMENTS**

**DECEMBER 31, 2017 AND 2016**

**NOTE V. CONTINGENCIES (continued)**

Arbitrage Rebate

The City is subject Section 148 of Internal Revenue Code, which was enacted to minimize the arbitrage benefits from investing gross proceeds of tax-exempt bonds in higher yielding investments and to remove the arbitrage incentives to issue more bonds, to issue bonds earlier, or to leave bonds outstanding longer than is otherwise reasonably necessary to accomplish the governmental purposes for which the bonds were issued. During the year ended December 31, 2017 and 2016, the City was not obligated to remit any funds for arbitrage rebate, yield reduction and interest payments.

Grant Programs

The City participates in several federal and state financial assistance grant programs. Entitlement to the funds is generally conditional upon compliance with terms and conditions of the grant agreements and applicable regulations, including the expenditures of funds for eligible purposes. The state and federal grants received and expended in the years ended December 31, 2016 and 2015 were subject to the Uniform Guidance and NJ OMB Circular 15-08, which mandate that grant revenues and expenditures be audited in conjunction with the City's annual audit. In addition, these programs are also subject to compliance and financial audits by the grantors or their representatives.

In a report dated March 30, 2016, the City was notified by the Office of Inspector General (OIG) that, among other concerns, the City should reimburse \$11,532,769 million in program income to the City's CDBG bank account, for program income the OIG claims the City generated on the disposition of real property. The City continues to appeal these findings. It is the opinion of Counsel that the City should be able to defend its CDBG expenditures and develop the documentation needed to avoid repayment of funds.

The State of New Jersey is transitioning from the Urban Enterprise Zone Program (UEZ) and will no longer provide additional UEZ grant funding to municipalities containing such zones, which includes the City. The City has received significant UEZ grant funding in previous years. All unspent First and Second Generation Zone Funds will be available to complete existing projects and fund new projects until the funds are exhausted. The City will continue to draw down on Second Generation UEZ Funds until such funds are exhausted.

**CITY OF JERSEY CITY  
NOTES TO FINANCIAL STATEMENTS**

**DECEMBER 31, 2017 AND 2016**

**NOTE V. CONTINGENCIES (continued)**

Tax Appeals

The City is a defendant in various tax appeals, the extent of which is not unusual for a municipality of its size. In the past, the City has utilized both the Reserve for Tax Appeals account, which is funded through budget appropriations, and has issued refunding notes to pay for the appeals. During the years ended December 31, 2017 and 2016 the City appropriated a total of \$2,400,000, each year, respectively, to fund tax appeal interest and overpayments. During the years ended December 31, 2017 and 2016, the City further funded tax appeal payments through a charge to operations of \$6,729,583 and \$1,206,040, respectively.

Litigation

The City of Jersey City, its officers and employees are defendants in a number of lawsuits including, but not limited to, lawsuits arising out of alleged torts, alleged breaches of contract and alleged violations of civil rights, none of which is unusual for a municipality of its size. The City is also engaged in activities, such as police protection and public works construction, which could result in future litigation with a possible significant monetary exposure to the City.

Based upon the information available to date, it does not appear that any individual lawsuit or the cumulative effect of these lawsuits will impair the City's ability to pay any judgments or settlements in an orderly manner, since the likelihood is that the amount of any judgments and eventual settlements will be much less than the amount claimed, and payments can be spread over two or more fiscal years. Because many lawsuits are still in the discovery stage, the Corporation Counsel is unable to determine the probability of a successful defense to them at this time.

The City self-insures against tort claims, which include general liability, automobile liability, employment practices, public officials and police professional and workers compensation lawsuits. The City also carries excess insurance for all lines of coverage which provides \$2 million coverage with a self-insured retention in the amount of \$1 million for each covered event. The cases listed below have a potential monetary exposure in excess of \$500,000.

**CITY OF JERSEY CITY  
NOTES TO FINANCIAL STATEMENTS**

**DECEMBER 31, 2017 AND 2016**

**NOTE V. CONTINGENCIES (continued)**

*212 Marin Blvd. et. al. v City of Jersey City (Sixth Street Embankment)* – This case involves various complex lawsuits involving the original plaintiffs, counter suits and notices of intent to file by outside parties. It was originally brought by several commonly owned/controlled LLC (“the LLCs”) entities owning property known as the Sixth Street Embankment, alleging that the City has interfered with their development rights and violated constitutional rights. These matters have been pending in Superior Court for several years despite numerous attempts to achieve a settlement. The main case is now before the Surface Transportation Board (STB) in Washington DC, where the City has so far been successful. The state court cases have been “stayed” pending resolution of the matter in Washington. The LLCs have filed a State lawsuit contesting the City’s authority to invoke the OFA remedy. On January 13, 2016, the City was authorized to file an Offer of Financial Assistance (OFA) (a federal eminent domain remedy) to acquire this property. During 2016, a third party sought to file an OFA in competition with the City but on behalf of a developer. A series of motions, sanctions and appeals related to the involvement of this third party may continue to delay the issuance of any “OFA” schedule by the STB. Further, on July 14, 2017, the New Jersey State Historic Preservation Office found the entire branch eligible for listing on the State and National registers and entirely protected by Section 106. The STB, under Section 106, is required to assess whether the license required for the abandonment of the railroad branches within the Sixth Street Embankment will have an adverse impact on (potential) historic assets. The local historic landmarking of the Embankment has been upheld against the LLCs challenge. The LLCs are also appealing the denial of demolition permits by the Zoning Board of Adjustment. Such appeal has been stayed. The City’s claim to set aside Conrail deeds to the LLCs, as well as the LLCs related damage claims alleging deprivation of property rights and alleged tortious interference and similar tort claims, have been stayed pending the outcome of federal litigation. The property has an appraised value in excess of \$6,000,000. The developer’s last demands may have been in the range of \$30 million to \$100 million. The City continues to vigorously pursue its efforts to keep a transportation corridor on the Harsimus Bank intact for both rail and trail purposes, and for compatible park and historic preservation purposes, both through STB litigation and now in settlement negotiations. Counsel has noted these matters have been pending for several years despite numerous attempts to achieve a settlement and that the City continues to defend against all claims.

**CITY OF JERSEY CITY  
NOTES TO FINANCIAL STATEMENTS**

**DECEMBER 31, 2017 AND 2016**

**NOTE V. CONTINGENCIES (continued)**

*MEPT v City of Jersey City* - In 2009, the City entered into financial agreements with plaintiffs concerning tax abatements for property in the city. Under the terms of the financial agreements, plaintiffs paid \$710,769 to affordable housing trust fund contribution and also made a prepayment of \$2 million to the city. Approximately 6 years after the financial agreements were signed, plaintiffs sold the property and commenced this declaratory judgment action seeking to recover the monies which they previously paid. On October 4, 2016, the court entered an order in favor of plaintiffs and awarded them the sum of \$2,710,769. Shortly thereafter, the City moved for reconsideration of the court's order and this motion was denied. The City filed a notice of appeal. The appellate division partially reversed the trial court, and lowered the amount owed to approximately \$2,000,000. The City has filed a petition for certification to the Supreme Court.

*B. v City of Jersey City* - Wrongful death and personal injury case. Third person invaded apartment of plaintiff, killed infant and injured occupant. Plaintiff alleges JCPD failed to enforce restraining order or act on outstanding warrant. The trial started on August 7, 2017. At the conclusion of the plaintiff's case, the City was granted a directed verdict all claims. On October 17, 2017, plaintiffs filed a notice of appeal. If plaintiffs are successful on appeal and re-trial granted, exposure could surpass \$1,000,000.

*V.M. v City of Jersey City* - This federal lawsuit involves allegations by a retired police sergeant that the defendants did not promote her because of her political affiliation and gender. This matter has been litigated in state and federal court. After discovery, summary judgment was granted to the Jersey City defendants on both the state and federal causes of action; however, the plaintiff appealed the matter to the Third Circuit Court of Appeals. The Third Circuit reversed the district courts holding and remanded the matter to the lower court. On April 16, 2017, this matter was tried. The jury awarded plaintiff approximately \$280,000 in loss wage damages. The City contends that the court made numerous evidentiary errors and intends on filing an appeal.

*A. v City of Jersey City* - This lawsuit is the companion case to the V.M. matter noted in the previous paragraph. In this case, eight other sergeants allege that because V.M. was wrongfully not promoted to Lieutenant, they could not be promoted since they were behind her on the promotion list. With regard to damages, they claim they are entitled to the difference in pay and benefits between what they would have received if they had been promoted and what they actually have received, including pay, benefits and pension contributions/value. These claimed damages continue to accrue as the case proceeds. This matter has the same procedural history as V.M. case. After the trial in this matter, the jury awarded the plaintiff's approximately \$2,000,000 in damages. The City contends that the court made numerous evidentiary errors and intends on filing an appeal.

**CITY OF JERSEY CITY  
NOTES TO FINANCIAL STATEMENTS**

**DECEMBER 31, 2017 AND 2016**

**NOTE V. CONTINGENCIES (continued)**

*O/D'O. v City of Jersey City* – While crossing the street on October 23, 2015, decedent was hit by a vehicle driven by one of the co-defendants. The victim was transported to Jersey City Medical Center and died approximately 3 days later. Plaintiff alleges that the street lights were not working at the time of the accident and caused the driver to hit the decedent. The City intends on filing a motion for summary judgment at the conclusion of the discovery period. Because this is a wrongful death matter, the city's exposure may exceed \$700,000.

*O'D. v City of Jersey City* – On February 22, 2016, two decedents, while driving, were struck by another vehicle. A witness allegedly saw a police officer seen conferring with the driver of the vehicle which struck the defendants moments before the accident. Plaintiff alleges the police officer breached his duty by not stopping the driver from continuing on the road, and this resulted in the fatal accident. Counsel suggests because there are two dead victims, exposure in the case could well exceed \$700,000.

*M. v. City of Jersey City* - Plaintiff, the City's Deputy Tax Assessor, has brought a claim in federal court for race discrimination and retaliation. She also alleges a whistleblower claim under CEPA. Discovery is ongoing. Written discovery is complete, plaintiff has been deposed, and plaintiff's counsel has deposed approximately ten defense witnesses. If plaintiff is able to prove her claims at trial, she could obtain an award between \$200,000 and \$300,000 for her severe emotional distress, as well as an attorneys' fees award between \$250,000 and \$300,000.

*M. O'N. v. City of Jersey City* - This is claim, which is not currently in litigation, that involves three (3) Jersey City Police Officers that were acquitted of criminal charges that related to conduct that allegedly occurred while performing duties as a police officer. These officers were suspended without pay between being indicted and their acquittals, which was a period of approximately 2 ½ years. Pursuant to two (2) New Jersey statutes, these officers are seeking: (a) back pay and benefits as well as other emoluments of their employment during the time of the suspension without pay and (b) legal fees incurred as a result of hiring criminal defense attorneys to defend against the charges. The combined value of all claims of these 3 officers could exceed \$700,000.

**CITY OF JERSEY CITY  
NOTES TO FINANCIAL STATEMENTS**

**DECEMBER 31, 2017 AND 2016**

**NOTE V. CONTINGENCIES (continued)**

*C. et al v. city of Jersey City* - This case involves employment-related causes of action (discrimination, retaliation, violation of civil rights, etc.) brought by two (2) supervisory-level Jersey City police officers against the City and several individual defendants. The 2 Plaintiffs in this case are among the 3 officers in the above mentioned criminal case. During the period while the criminal charges were pending, the civil case was administratively terminated by the federal court. However, we expect that the Plaintiffs will soon reactivate the case in light the termination of the criminal case – and perhaps add additional defendants and causes of action. Although the City intends to vigorously defend the case, the value of these claims could exceed \$700,000 due to the procedural history of this case, including the acquittals in the criminal case.

*R.M. v. Toloza, et al* – This is a federal employment discrimination and retaliation, breach of contract and civil rights case that has been in procedural standstill since January, 2017 due to discovery disputes.

*D.L. & F.P. v. City of Jersey City* – This is a political retaliation case filed by two former Jersey City Parking Authority employees, in which certain claims have been dismissed but in which an appeal is pending.

*Rockaway Valley Regional Sewerage Authority.* In compliance with a court decree, the City entered into an agreement, dated July 30, 1971, with the Rockaway Valley Regional Sewerage Authority (“RVRSA”), whereby the City agreed to share in the operating costs of the RVRSA which provides sewerage treatment services in the vicinity of the City's watershed properties. In 2013, 2014 and 2015, the JCMUA contributed \$2,730,857. In 2016 and 2017, the JCMUA contributed \$3,429,757 and \$2,858,130, respectively. Under the same agreement, the City is also required to pay a share of the capital and operating cost of construction of an advanced treatment sewerage facility, which the RVRSA has designed. Under the current plans, the cost of construction is estimated to be \$60,000,000, less any federal funds, the amount of which is presently uncertain. Based upon the design capacity, the City will be responsible for 37 1/2% of the excess cost of financing construction over available federal funds. The amount of the City's contribution for the new facility is a portion of the City's share of the operating costs outlined in the immediately preceding paragraph. The RVRSA has permanently financed substantially all of the non-grant share of project costs with the sale of long-term tax-exempt bonds.



**CITY OF JERSEY CITY  
NOTES TO FINANCIAL STATEMENTS**

**DECEMBER 31, 2017 AND 2016**

**NOTE V. CONTINGENCIES (continued)**

*NJDEP and the Administrator of the Spill Compensation Fund v. Honeywell International, Inc., and PPG Industries, Inc. v. City of Jersey City. et al.* - This matter arises out of legacy chromium site contamination in Jersey City, located near the intersection of the Hudson Bergen Light Rail tracks and Garfield Avenue. In 1990, PPG signed an administrative consent order with the New Jersey Department of Environmental Protection, which included accepting responsibility for the cleanup of the Garfield Avenue chromite ore processing residue site. PPG had agreed to cover all "site remediation" costs; it did not, however, agree to cover what it considers to be restoration or incremental costs to redevelop the contaminated properties. PPG and the City disagree what costs are remedial and what costs are incremental, and disagree as to the amounts of those costs. Further, the parties have disagreements over certain methods of remediation. This matter is currently pending before the Superior Court of New Jersey, Hudson County. The matter has progressed through some amount of dispositive motion practice, but dispositive motions have been held in abeyance or withdrawn pending ongoing, extensive settlement negotiations. No trial date has been scheduled. Counsel notes this case will be contested vigorously, however, at this time, the parties are engaged in extensive settlement negotiations involving complex environmental and redevelopment - land use issues.

*Estate of G. v. City of Jersey City* - On August 8, 2014, two City officers were dispatched to assist a driver whose vehicle was disabled. After the disabled vehicle was towed, the owner was later struck by a vehicle and killed. Plaintiff alleges the owner of the disabled vehicle was intoxicated when City officers assisted him, and their failure to drive the decedent to a safe area resulted in his death. Counsel notes that because this is a wrongful death action, the City's exposure could well exceed \$500,000.

*Estate of L.K. v. City of Jersey City* - In this matter, a Jersey City police officer fatally shot decedent after he tried to disarm the officer. Plaintiffs contend that the officer unnecessarily used excessive force in violation of the decedent's constitutional rights. The City disputes the allegations and will continue to defend the matter. The City contends that the officer used reasonable force. If plaintiff succeeds, exposure could surpass \$700,000.

*F-R v. City of Jersey City* - On June 4, 2017, members of the JCPD were involved in a motor vehicle pursuit. During the pursuit, the vehicle being pursued crashed into plaintiff's vehicle causing both vehicles to engulf in flames. Plaintiff sustained severe burns to his body. In addition, plaintiff claims that as he exited his vehicle, he was attacked by members of the JCPD. Plaintiff has brought suit against the City and numerous police officers for an assortment of negligence and civil rights claims. This matter is in the infancy stages of litigation. Counsel notes that because of the alleged injuries, the City's exposure may exceed \$700,000.

**CITY OF JERSEY CITY  
NOTES TO FINANCIAL STATEMENTS**

**DECEMBER 31, 2017 AND 2016**

**NOTE W. SUBSEQUENT EVENTS**

Subsequent events have been evaluated through October 26, 2018, the date which the financial statements were available to be issued. The following material subsequent events have been noted:

**Special Emergency Appropriation: \$940,500** – On April 25, 2018, the City adopted Ordinance No. 18-028 providing for a special emergency appropriation in the amount of \$940,500 for the preparation of a Master Plan. Statutes require this emergency to be funded by budget appropriation in equal installments over a period of five years, beginning with the 2019 budget. Statutes further allow for notes to be authorized and issued to finance the emergency.

**Special Emergency Appropriation: \$14,500,000** – On October 10, 2018, the City adopted Ordinance No. 18-114 providing for a special emergency appropriation in the amount of \$14,500,000 for the payment of contractually required severance liabilities resulting from the retirement of City employees. Statutes require this emergency to be funded by budget appropriation in equal installments over a period of five years, beginning with the 2019 budget. Statutes further allow for notes to be authorized and issued to finance the emergency.

**Re-Appropriation Ordinance: \$514,287** - On February 28, 2018, the City adopted Ordinance No. 18-008 re-appropriating \$514,287 of proceeds of obligations not needed for their original purposes in order to provide for funding for the renovation of a Fire House in and by the City.

**Re-Appropriation Ordinance: \$1,800,000** - On February 28, 2018, the City adopted Ordinance No. 18-013 re-appropriating \$1,800,000 of proceeds of obligations not needed for their original purposes in order to provide for various capital improvements in and by the City.

**Capital Ordinance: \$150,000** - On February 28, 2018, the City adopted Ordinance No. 18-009 appropriating \$150,000 from General Capital Fund Balance for the acquisition of a Mask Service Unit Truck for the City Fire and Emergency Services.

**Capital Ordinance: \$205,000** - On March 14, 2018, the City adopted Ordinance No. 18-017 appropriating \$205,000 from General Capital Fund Balance for the acquisition of two passenger buses for the City Department of Recreation.

**CITY OF JERSEY CITY  
NOTES TO FINANCIAL STATEMENTS**

**DECEMBER 31, 2017 AND 2016**

**NOTE W. SUBSEQUENT EVENTS (continued)**

**Capital Ordinance: \$47,282,671** – On May 9, 2018, the City adopted Ordinance No. 18-038 providing for various capital improvements for the City and appropriating \$47,282,671 therefore. General Improvement bonds or notes are authorized in the amount of \$45,031,115 to finance such costs. The remaining \$2,251,556 will be funded by the Capital Improvement Fund

**Capital Ordinance: \$170,000,000** – On October 10, 2018, the City adopted Ordinance No. 18-113 authorizing the City to enter into a real estate purchase and environmental agreement in order to purchase certain real property, demolish certain structures and construct infrastructure improvements within the Bayfront I Redevelopment Area and appropriating \$170,000,000 therefore. In order to finance the cost of this project, the City has authorized the issuance of \$170,000,000 of bonds and notes.

**Bond Anticipation Notes: \$17,734,000** – On January 18, 2018, the City issued \$17,734,000 of Bond Anticipation Notes, Series 2018A at an interest rate of 2.5% and due on January 18, 2019. The City will apply the proceeds from the sale of the Notes to pay a portion of the maturing principal of the City's \$9,966,000 Bond Anticipation Notes, Series 2017A which were issued on January 19, 2017 and mature on January 19, 2018, and used to refinance certain capital improvements, notably the PJP Landfill Acquisition authorized by Ordinance No. 09-097 and the Newark Ave Streetscape authorized by Ordinance No. 09-127, and pay a portion of the costs of issuing the Notes. These notes will also be used to aid in the West Campus Redevelopment Project authorized by Ordinance No. 16.106 on July 13, 2016. The remaining \$242,000 of maturing principal of the Series 2017A Notes will be paid from budgeted appropriations.

**CITY OF JERSEY CITY  
NOTES TO FINANCIAL STATEMENTS**

**DECEMBER 31, 2017 AND 2016**

**NOTE W. SUBSEQUENT EVENTS (continued)**

**Bond Anticipation Notes: \$52,796,615** – On June 20, 2018, the City issued \$52,796,615, of Bond Anticipation Notes maturing June 20, 2019, consisting of:

- ◆ \$6,825,000 Series 2018B (Federally Taxable) Bond Anticipation Notes with an interest rate of 2.875%. The City will apply the proceeds from the sale of the Notes to pay a portion of the maturing principal of the City's \$6,955,000 Bond Anticipation Notes, Series 2017B which were issued on June 22, 2017 and mature on June 22, 2018, and used to refinance certain capital improvements, notably the Sixth Street Embankment authorized by Ordinance No. 10-085, and pay a portion of the costs of issuing the Notes. The remaining \$130,000 of maturing principal of the Series 2017B Notes will be paid from budgeted appropriations.
- ◆ \$45,031,115 Series 20018C Bond Anticipation Notes with an interest rate of 3.0%. These notes were issued to finance capital improvements as authorized by Ordinance No. 18-038 adopted on May 9, 2018.
- ◆ \$940,500 Series 2018D Special Emergency Notes with an interest rate of 3.0%. The City will apply the proceeds of these notes to finance the costs of a Master Plan as authorized by Special Emergency Authorization adopted on April 25, 2018 by Ordinance No. 18-028.

**RESOLUTION FACT SHEET – NON-CONTRACTUAL**

This summary sheet is to be attached to the front of any resolution that is submitted for Council consideration. Incomplete or vague fact sheets will be returned with the resolution.

**Full Title of Ordinance/Resolution**

**RESOLUTION OF THE CITY OF JERSEY CITY PROVIDING FOR AN ISSUE OF GENERAL IMPROVEMENT BONDS, AUTHORIZING THE SALE OF \$9,447,000 PRINCIPAL AMOUNT OF GENERAL IMPROVEMENT BONDS, SERIES 2018, AUTHORIZING ADVERTISEMENT OF A NOTICE OF SALE; AUTHORIZING THE CHIEF FINANCIAL OFFICER TO SELL AND AWARD THE BONDS; DETERMINING THE FORM AND OTHER DETAILS OF THE BONDS; AND AUTHORIZING OTHER MATTERS RELATING THERETO AND TO CERTAIN NOTES OF THE CITY.**

**Initiator**

Department/Division	Administration	Management & Budget
Name/Title	Donna Mauer	Chief Financial Officer
Phone/email	201-547-5042	DonnaM@cnj.org

Note: Initiator must be available by phone during agenda meeting (Wednesday prior to council meeting @ 4:00 p.m.)

**Resolution Purpose**

This resolution allows the CFO to sell general improvement bonds on behalf of the City and also specifies the form of these bonds. These bonds are to permanently finance the remaining portion of the projects authorized in Ordinances 09-097 and 09-127.

This resolution also approves the Preliminary Official Statement and Continuing Disclosure Certificate for the sale of these bonds as well as bond anticipation and special emergency notes.

I certify that all the facts presented herein are accurate.

Donna Mauer  
Signature of Department Director

10/30/18  
Date

# Resolution of the City of Jersey City, N.J.

City Clerk File No. Res. 18-962

Agenda No. 10.C

Approved: NOV 07 2018

TITLE:



**RESOLUTION AUTHORIZING REFUNDS DUE TO OVERPAYMENTS ON PROPERTY TAX ACCOUNTS.**

**COUNCIL OFFERED, AND MOVED ADOPTION OF THE FOLLOWING RESOLUTION:**

**WHEREAS**, the attached tax accounts have duplicate payments on the property tax accounts; and

**WHEREAS**, the owner/entity acting on behalf of the owner has requested a refund due to the duplicate payment; and

**WHEREAS**, the Tax Collector would like to issue a tax refund to the individual/entity acting on behalf of the owner requesting the refund on the attached schedule and;

**NOW, THEREFORE, BE IT RESOLVED**, by the Municipal Council of the City of Jersey, in the County of Hudson, state of New Jersey, that the refunds, as outlined on the attached schedule be issued, and the records of the Tax Collector's office be accordingly adjusted.

Voucher B092215 Total of Refund \$86,337.53

APPROVED: [Signature]  
 APPROVED: [Signature]  
 Business Administrator

APPROVED AS TO LEGAL FORM  
[Signature]  
 Corporation Counsel

Certification Required   
 Not Required

APPROVED 8-0

RECORD OF COUNCIL VOTE ON FINAL PASSAGE 11.7.18											
COUNCILPERSON	AYE	NAY	N.V.	COUNCILPERSON	AYE	NAY	N.V.	COUNCILPERSON	AYE	NAY	N.V.
RIDLEY	✓			YUN	✓			RIVERA	✓		
PRINZ-AREY	✓			SOLOMON	✓			WATTERMAN	ABSENT		
BOGGIANO	✓			ROBINSON	✓			LAVARRO, PRES.	✓		

✓ Indicates Vote

N.V.-Not Voting (Abstain)

Adopted at a meeting of the Municipal Council of the City of Jersey City N.J.

[Signature]  
 Rolando R. Lavarro, Jr., President of Council

[Signature]  
 Robert Byrne, City Clerk

**RESOLUTION FACT SHEET – NON-CONTRACTUAL**

This summary sheet is to be attached to the front of any resolution that is submitted for Council consideration. Incomplete or vague fact sheets will be returned with the resolution.

**Full Title of Ordinance/Resolution**

RESOLUTION AUTHORIZING REFUNDS DUE TO OVERPAYMENTS ON PROPERTY TAX ACCOUNTS.

**Initiator**

Department/Division	ADMINISTRATION	TAX COLLECTION
Name/Title	ANTHONY ESPOSITO	ACTING TAX COLLECTOR
Phone/email	(201) 547-5526	ANTHONYE@JCNJ.ORG

Note: Initiator must be available by phone during agenda meeting (Wednesday prior to council meeting @ 4:00 p.m.)

**Resolution Purpose**

REFUNDS DUE TO OVERPAYMENTS ON PROPERTY TAX ACCOUNTS.

I certify that all the facts presented herein are accurate.

*1/6/18*  
Signature of Department Director

*10/15/18*  
Date

18-962 NOV 07 2018

Voucher N	Name	Address 1	City	State	Zip	Principal	Total	Account	Block	Lot	Qualify	Property Location
1	B092215	CORELOGIC	P.O. BOX 9205	COPPELL	TX 75019-9214	\$ 4,680.00	\$ 4,680.00	105882	1704	2		647 PALISADE AVE
2	B092215	PAT CARABELLESE	127 SO WASHINGTON AVENUE	BERGENFIELD	NJ 07621	\$ 461.72	\$ 461.72	392993	2202	11		456 CENTRAL AVENUE
3	B092215	PAT CARABELLESE	127 SO WASHINGTON AVE	BERGENFIELD	NJ 07621	\$ 1,560.00	\$ 1,560.00	102707	2402	21		415 OGDEN AVE
4	B092215	ROSE MARCHESE	226 MADISON AVE	HASBROUCK H	NJ 07604	\$ 1,434.88	\$ 1,434.88	115873	3702	10		141 HUTTON ST
4	B092215	SYLVIA DUNCAN	314 WEBSTER AVE	JERSEY CITY	NJ 07307	\$ 1,614.38	\$ 1,614.38	92650	3804	1		118 SHERMAN AVE
6	B092215	33 GRIFFITH STREET ASSOCI	33 GRIFFITH ST	JERSEY CITY	NJ 07307	\$ 1,287.00	\$ 1,287.00	396630	3903	36		33 GRIFFITH ST
7	B092215	VIOLA GEDEON	6791 EL PASO ST	BONNERS FERI	ID 83805	\$ 1,596.00	\$ 1,596.00	80374	5805	5		87 PROSPECT ST
8	B092215	MELISSA LIEM	10 JASMINE COURT	MALVERN	PA 19355	\$ 3,914.00	\$ 3,914.00	591830	6102	4	C1211	700 GROVE ST
8	B092215	PAT CARABELLESE	127 SO WASHINGTON AVENUE	BERGENFIELD	NJ 07621	\$ 886.27	\$ 886.27	421974	6502	2	c0718	201 St. Paul's Avenue
10	B092215	PAT CARABELLESE	127 SO WASHINGTON AVENUE	BERGENFIELD	07621	\$ 1,299.22	\$ 1,299.22	415562	6502	14	c0116	10 Huron Avenue
11	B092215	MONTCLAIR RADIOLOGY	777 PASSAIC AVE	CLIFTON	NJ 07012	\$ 593.51	\$ 593.51	468173	8001	26	C8022	550 SUMMIT AVE
12	B092215	CORELOGIC	P.O. BOX 9205	COPPELL	NJ 75019-9214	\$ 2,626.65	\$ 2,626.65	54049	9706	3		158 CHESTNUT AVE
13	B092215	CORELOGIC	3001 HACKBERRY RD	IRVING	TX 75063	\$ 7,318.04	\$ 7,318.04	656095	10001	43	C0302	304 PAVONIA AVE
14	B092215	CORELOGIC	P.O. BOX 9205	COPPELL	TX 75019	\$ 2,246.40	\$ 2,246.40	39487	10008	36		334.5 EIGHTH ST
15	B092215	CONSOLIDATED RAIL	P.O. BOX 8499	PHILADELPHIA	PA 19108	\$ 453.36	\$ 453.36	50724	10901	122		NEWARK AVE
16	B092215	HAVEN SAVINGS BANK	621 WASHINGTON ST	HOBOKEN	NJ 07030	\$ 3,900.00	\$ 3,900.00	48330	11009	6		367 THIRD ST
17	B092215	CORELOGIC REFUND DEPT	3001 HACKBERRY RD	IRVING	TX 75063	\$ 6,906.14	\$ 6,906.14	642755	11603	24	C0805	2 SECOND ST
18	B092215	WILLIAM MELIA	433 CHERRY ST	PATTSTOWN	PA 19464-5927	\$ 11,884.66	\$ 11,884.66	16097	12906	35		56 MERCER ST
19	B092215	Able Title Agency LLC	84 Washington Street	Hoboken	NJ 07030	\$ 2,536.70	\$ 2,536.70	580770	13903	24	c0006	444 Jersey Avenue
20	B092215	SEAN M. DOHERTY	407 QUINCY SHORE DR	QUINCY	MA 02171	\$ 2,533.20	\$ 2,533.20	635340	13502	26	C0404	650 MONTGOMERY ST
21	B092215	WENHUA JU	420 E OHIO ST	CHICAGO	IL 60611	\$ 4,979.20	\$ 4,979.20	527804	13904	21		310 GRAND ST
22	B092215	Jun Qian & Ibrahim Kara	250 York Street	Jersey City	NJ 07302	\$ 2,648.59	\$ 2,648.59	471458	14101	33	c0204	250 York Street
23	B092215	JASON O'BRIEN	99 MONTGOMERY ST	JERSEY CITY	NJ 07302	\$ 3,216.87	\$ 3,216.87	589525	14301	2	C9002	99 MONTGOMERY ST
24	B092215	ONKAR SINGH	P.O. BOX 8008	JERSEY CITY	NJ 07308	\$ 1,876.01	\$ 1,876.01	4929	14202	35		152 SUSSEX ST
25	B092215	Simplicity Title LLC	70 Grove Street	Somerville	NJ 08876	\$ 1,264.44	\$ 1,264.44	660120	16203	9		126 Delaware Avenue
26	B092215	James Meade	611 Harrison Street	Frenchtown	NJ 08825	\$ 1,595.03	\$ 1,595.03	433748	16502	3	c0033	53 Duncan Avenue
27	B092215	Commonwealth USA Settlements	100 Park Manor Drive	Pittsburgh	PA 15205	\$ 1,212.80	\$ 1,212.80	333773	17101	19		7 Astor Place
28	B092215	CORELOGIC REFUND DEPT	3001 HACKBERRY RD	IRVING	TX 75063	\$ 1,141.21	\$ 1,141.21	333773	17101	19		7 Astor Place
29	B092215	CORELOGIC	3001 HACKBERRY RD	IRVING	TX 75063	\$ 2,184.00	\$ 2,184.00	610030	20003	16	C0001	372 COMMUNIPAW AVE
30	B092215	CAROL COSLFORE	1923 E. LEEWYNN DR	SARASOTA	FL 34240	\$ 977.65	\$ 977.65	403378	20901	5		239 VIRGINIA AVE
31	B092215	CORELOGIC REFUND DEPT	3001 HACKBERRY RD	IRVING	TX 75063	\$ 1,795.95	\$ 1,795.95	175661	25303	11		325 Srevens Avenue
32	B092215	SAVLAI HO	41-28 COLLEGE PT BLVD	QUEENS	NY 11354	\$ 948.27	\$ 948.27	531756	26102	18	C1312	38 LYON CT
33	B092215	SAVLAI HO	41-28 COLLEGE PT BLVD	QUEENS	NY 11354	\$ 708.13	\$ 708.13	534008	26102	15	C3011	17 LEE CT



18-962

NOV 07 2018

34 B092215 ROSA LONGO	133 MC ADOO AVE	JERSEY CITY	NJ	07305	\$ 861.20	\$ 861.20	174722	26201	38	133 MC ADOO AVE
35 B092215 SELECT PORTFOLIO C/O LERE	1123 PARKVIEW DR	COVINA	CA	91724	\$ 1,196.05	\$ 1,196.05	504977	26801	60	54 GRIECO DR

TOTAL TO BE REFUNDED

\$ 86,337.53 \$ 86,337.53

OVERPAYMENTS

# Resolution of the City of Jersey City, N.J.

City Clerk File No. Res. 18-963  
 Agenda No. 10.D  
 Approved: NOV 07 2018  
 TITLE:



## RESOLUTION TO CANCEL A PORTION OF 2018 REAL ESTATE TAXES DUE TO AFFORDABLE HOUSING RESTRICTIONS ON VARIOUS PROPERTIES

**WHEREAS**, properties whose titles are subject to Affordable Housing Covenants and Remedies are treated differently in valuation for assessing purposes; and

**WHEREAS**, affordable housing deeds state the restrictions in place which will have a depreciating effect on property values due to limitations on resale pricing which is designed to secure a public benefit for the maintenance of affordable housing units; and

**WHEREAS**, the City of Jersey City has assessed properties on the attached, SCHEDULE A' at market rate, without recognizing government easements/restrictions for the year 2018; and

**WHEREAS**, the New Jersey Department of Community Affairs, Counsel on Affordable Housing (COAH) has developed calculators used by municipalities in valuing such type of properties; and

**WHEREAS**, properties listed on "SCHDULE A", show the calculated maximum allowable resale price based on the COAH calculations; and

**NOW THEREFORE, BE IT RESOLVED**, by the Municipal Council of the City of Jersey City that;

1. The Tax Collector is authorized to cancel the 2018 prorated amounts in the amount specified in the schedule;
2. Credit or refund all monies due to owners if applicable as specified on the schedule.

APPROVED: \_\_\_\_\_

APPROVED AS TO LEGAL FORM

APPROVED: [Signature]

Business Administrator

[Signature]

Corporation Counsel

Certification Required

Not Required

APPROVED 8-0

RECORD OF COUNCIL VOTE ON FINAL PASSAGE 11.7.18											
COUNCILPERSON	AYE	NAY	N.V.	COUNCILPERSON	AYE	NAY	N.V.	COUNCILPERSON	AYE	NAY	N.V.
RIDLEY	✓			YUN	✓			RIVERA	✓		
PRINZ-AREY	✓			SOLOMON	✓			WATTERMAN	ABSENT		
BOGGIANO	✓			ROBINSON	✓			LAVARRO, PRES.	✓		

✓ Indicates Vote

N.V.-Not Voting (Abstain)

Adopted at a meeting of the Municipal Council of the City of Jersey City N.J.

[Signature]  
 Rolando R. Lavarro, Jr., President of Council

[Signature]  
 Robert Byrne, City Clerk

**RESOLUTION FACT SHEET - CONTRACT AWARD**

This summary sheet is to be attached to the front of any resolution that is submitted for Council consideration. Incomplete or vague fact sheets will be returned with the resolution.

**Full Title of Ordinance/Resolution**

**RESOLUTION TO CANCEL 2018 REAL ESTATE TAXES DUE TO AFFORDABLE HOUSING RESTRICTIONS ON VARIOUS PROPERTIES.**

**Project Manager**

Department/Division	Tax Assessor's Office	
Name/Title	Ed Toloza	Tax Assessor
Phone/email	(201) 547 4804	edward@jcnj.org

Note: Project Manager must be available by phone during agenda meeting (Wednesday prior to council meeting @ 4:00 p.m.)

**Contract Purpose**

The attached resolution requests the Municipal Council to authorize cancellation of 2018 taxes on properties whose title contains restrictions in terms of its resale values which impact property valuations. The total amount of credits or refund amount to \$46,636.90

**I certify that all the facts presented herein are accurate.**

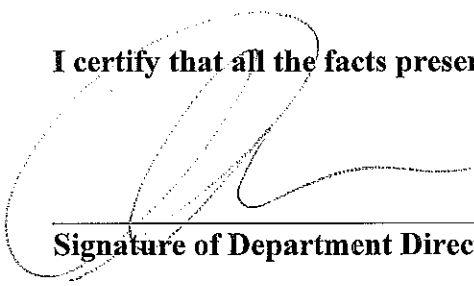
  
\_\_\_\_\_  
**Signature of Department Director**

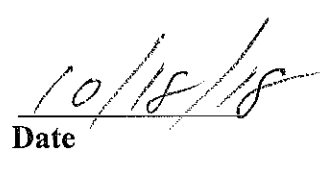
  
**Date**

RES. 18-963

NOV 07 2018

**SCHEDULE A**  
**Affordable Housing Units**

Block Lot	QL	Location	Owner	Sale Date	Orig. Price	Maximum Resale Price	2018 A. V.	Diff	Amount of Credit/Refund
16703	20	86 Jewett	Johnson, Jestina	12/20/1991	72,900	201,700	469,000	267,300	3,977.42
17001	28	67 Astor Place	Brown, Dionne	11/2/2004	90,000	114,000	560,800	446,800	6,648.38
24001	19	133 Bayview Av	Bethea, Heidi	10/14/2016	150,000	150,000	308,600	158,600	2,359.97
25101	42	184 Dwight Av	Cisse, Ben	6/5/2014	165,000	165,000	319,600	154,600	2,300.45
25704	11	139 Dwight Av	Guy & Lorraine Oliver	3/31/2014	165,000	165,000	370,700	205,700	3,060.82
19004	30 C0101	248 Pine St	Pearson, Marie	1/16/2007	159,900	180,400	275,400	95,000	1,413.60
19004	30 C0201	248 Pine St	Edwards, Doris	1/12/2007	159,900	180,400	275,400	95,000	1,413.60
19004	31 C0101	250 Pine St	Forbes, Sharlese	1/26/2007	159,900	180,400	275,400	95,000	1,413.60
19004	31 C0201	250 Pine St	Cruz, Elizabethqq	1/8/2007	159,900	180,400	275,400	95,000	1,413.60
20003	24 C0101	224 Van Horne St	Santos, Arlos & Samya	5/19/2006	159,900	187,200	403,700	216,500	3,221.52
20003	24 C0201	224 Van Horne St	Lise, Maurice & Anika	5/3/2006	159,900	187,200	403,700	216,500	3,221.52
20101	1	116 Woodward St	Romero, Francisco & Sarah	10/3/1990	45,000	137,000	378,800	241,800	3,597.98
20101	6	126 Woodward St	High, Shannett	10/22/1990	45,000	137,000	352,000	215,000	3,199.20
20102	66 C0101	213 Halladay St	Lane, Cornelius	6/14/2006	159,900	187,200	415,000	227,800	3,389.66
20102	66 C0201	213 Halladay St	Downs, Danielle	5/30/2006	159,900	187,200	415,000	227,800	3,389.66
20201	36 C0101	341 Communipaw Av	Ingram, Kim	11/6/2006	137,900	161,500	337,300	175,800	2,615.90
									46,636.90

# Resolution of the City of Jersey City, N.J.

City Clerk File No. Res. 18-964

Agenda No. 10.E

Approved: NOV 07 2018

TITLE:



**RESOLUTION TO CANCEL A PORTION OF 2018 REAL ESTATE TAXES DUE TO AFFORDABLE HOUSING RESTRICTIONS ON BLOCK 25704 Lot 14 A/K/A 131 DWIGHT STREET, JERSEY CITY, NEW JERSEY**

**WHEREAS**, properties whose titles are subject Affordable Housing Covenants and Remedies are treated differently in valuation for assessing purposes; and

**WHEREAS**, affordable housing deed restrictions have a depreciating effect on property values due to limitations on resale pricing which is designed to secure a public benefit for the maintenance of affordable housing units; and

**WHEREAS**, the City of Jersey City has assessed 131 Dwight Street at market rate, without recognizing government easements/restrictions for the year 2018; and

**WHEREAS**, the New Jersey Department of Community Affairs, Counsel on Affordable Housing (COAH) has developed calculators used by municipalities in valuing such type of properties; and

**WHEREAS**, subject property show the calculated maximum allowable resale price based on the COAH calculations; and

**NOW THEREFORE, BE IT RESOLVED**, by the Municipal Council of the City of Jersey City that;

1. The Tax Collector is authorized to cancel the 2018 prorated taxes in the amount of \$2,717.09.
2. Credit or refund all overpayments due as a result of this error..

APPROVED: \_\_\_\_\_

APPROVED AS TO LEGAL FORM

APPROVED: \_\_\_\_\_

Business Administrator

\_\_\_\_\_

Corporation Counsel

Certification Required

Not Required

**APPROVED 8-0**

RECORD OF COUNCIL VOTE ON FINAL PASSAGE 11.7.18											
COUNCILPERSON	AYE	NAY	N.V.	COUNCILPERSON	AYE	NAY	N.V.	COUNCILPERSON	AYE	NAY	N.V.
RIDLEY	✓			YUN	✓			RIVERA	✓		
PRINZ-AREY	✓			SOLOMON	✓			WATTERMAN	ABSENT		
BOGGIANO	✓			ROBINSON	✓			LAVARRO, PRES.	✓		

✓ Indicates Vote

N.V.-Not Voting (Abstain)

Adopted at a meeting of the Municipal Council of the City of Jersey City N.J.

\_\_\_\_\_  
Rolando R. Lavarro, Jr., President of Council

\_\_\_\_\_  
Robert Byrne, City Clerk

**RESOLUTION FACT SHEET – NON-CONTRACTUAL**

This summary sheet is to be attached to the front of any resolution that is submitted for Council consideration. Incomplete or vague fact sheets will be returned with the resolution.

**Full Title of Ordinance/Resolution**

**Resolution to cancel a portion of 2018 real estate taxes due to affordable housing restrictions on Block 25704 Lot 14 A/K/A 131 Dwight Street, Jersey City, New Jersey**

**Initiator**

Department/Division	Office of the City Assesso	Office of the City Assessor
Name/Title	Ed Toloza	Assessor
Phone/email	Ext. 4707	Edward@jcnj.org

Note: Initiator must be available by phone during agenda meeting (Wednesday prior to council meeting @ 4:00 p.m.)

**Resolution Purpose**

The attached resolution requests the Municipal Council to authorize settlement agreements and to cancel a portion of 2018 real estate taxes due to affordable housing restrictions.

I certify that all the facts presented herein are accurate.

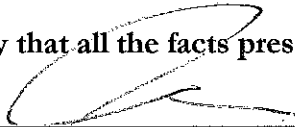
  
\_\_\_\_\_  
Signature of Department Director

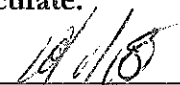
  
\_\_\_\_\_  
Date

PRESS(Q)uery, (N)ext, (P)revious, (A)dd, (U)pdate, (R)emove, (O)utput (B)ye  
(S)creen \*\* 1: prc file\*\*

-----Screen:1 of 2

0906 Block: 25704 Lot: 14 Q: M  
Prior Block: 1330 Lot: 58 Q: 09/28/18  
Loc: 131 DWIGHT ST. 06 JERSEY CITY, NJ 00000  
Owner: DAVID, DIANE B. Billing Code:  
Street: 131 A DWIGHT STREET Account Num: 00496810  
Town: JERSEY CITY, N.J. Zip: 07305 Mtg Acct#:  
Class: 2 Deductions:S 0 V 0 W 0 R 0 D 0 Own: 0 Amt: 0  
Saled: 09/30/10 Bk: 8756 Pg: 671 Price: 175000 NU#: 15 Cd: R: 211.83

	2018	2019	Taxes	Exemptions/Abatements	
Land:	91000	91000	(57): 4095.00	1	0
Impr:	279700	279700	(58): 5516.02	2	0
	0	0		3	0 NetCalc
Net:	370700	370700	Partial:	4	0 0

Land Dim: 25.58X102.1 Class4Cd: YrBlt: 1995  
Bldg Desc: 2S-F-D-2U BldgClass: SF: 0  
Addl Lots: Type/Use: PrcSF 0 UCd: 20  
Style: Zone: Map: 257

1 record(s) found



OFFICE OF THE CITY ASSESSOR  
280 Grove Street  
Jersey City, NJ 07302  
Tel. 201-547-5131 Fax 201-547-4949

**Eduardo Toloza**  
Assessor

September 28, 2018

Diane David  
131 Dwight St.  
Jersey City, NJ 07305

Re: Amending 2018 Billing  
Block 25704 Lot 14  
a/k/a 131 Dwight St.

Dear Ms. David:

Please be advised that a resolution to cancel a portion of your 2018 taxes will be presented to the Council for approval. This Resolution seeks to authorize the Tax Collector to make adjustments on the 2018 billings, reflecting the affordability status of these units.

Attached is your amended tax bill which reflecting these adjustments which you can forward to your bank to make payments. If payments were made on your 3<sup>rd</sup> quarter of 2018, excess monies can be applied to the next quarter of 2018.

Should you have any question on this matter, please do not hesitate to give us a call.

Sincerely yours,

Ed Toloza  
City Assessor  
w/enc



# Resolution of the City of Jersey City, N.J.

City Clerk File No. Res. 18-965

Agenda No. 10.F

Approved: NOV 07 2018

TITLE:



**RESOLUTION AUTHORIZING THE BUSINESS ADMINISTRATOR TO EXECUTE A DISCHARGE OF MORTGAGE AFFECTING 108 RANDOLPH AVENUE, A/K/A BLOCK 22704, LOT 27, F/K/A BLOCK 2008, LOT 3.D**

**COUNCIL** offered and moved adoption of the following Resolution:

**WHEREAS**, on March 17, 2005, Lorraine A. Rollins, (Borrower) executed a Mortgage and Note in favor of the City of Jersey City (City) to secure the City's loan to her in the amount of \$22,274.00 made under the Golden Neighborhood Homeownership Program (GNHP); and

**WHEREAS**, on March 22, 2005 the Mortgage was recorded in Book 12621 at Page 00312 of the Register of Deeds for Hudson County; and

**WHEREAS**, the City's mortgage self-amortizes over ten (10) years provided the homeowner resides in the property and does not sell the property; and

**WHEREAS**, the mortgage affects property knowns as 108 Randolph Avenue, Jersey City, a/k/a Block 22704, Lot 27, f/k/a Block 2008, Lot 3D.

**WHEREAS**, ten (10) years have passed since the loan was made and so the City is obligated to execute a Discharge of Mortgage to remove the mortgage from the public record.

**NOW, THEREFORE, BE IT RESOLVED**, that the Business Administrator is authorized to execute a Discharge of Mortgage in the sum of \$22,274.00 affecting property known as 108 Randolph Avenue, a/k/a Block 22704, Lot 27, f/k/a Block 2008, Lot 3D.

JML/mma  
10/29/18

APPROVED: \_\_\_\_\_

APPROVED AS TO LEGAL FORM

APPROVED: [Signature]

Business Administrator

[Signature]  
Corporation Counsel

Certification Required

Not Required

APPROVED 8-0

RECORD OF COUNCIL VOTE ON FINAL PASSAGE 11.7.18											
COUNCILPERSON	AYE	NAY	N.V.	COUNCILPERSON	AYE	NAY	N.V.	COUNCILPERSON	AYE	NAY	N.V.
RIDLEY	✓			YUN	✓			RIVERA	✓		
PRINZ-AREY	✓			SOLOMON	✓			WATTERMAN	ABSENT		
BOGGIANO	✓			ROBINSON	✓			LAVARRO, PRES.	✓		

✓ Indicates Vote

N.V. - Not Voting (Abstain)

Adopted at a meeting of the Municipal Council of the City of Jersey City N.J.

[Signature]  
Rolando R. Lavarro, Jr., President of Council

[Signature]  
Robert Byrne, City Clerk

**RESOLUTION FACT SHEET**

This summary sheet is to be attached to the front of any resolution that is submitted for Council consideration. Incomplete or vague fact sheets will be returned with the resolution.

**Full Title of Ordinance/Resolution**

**RESOLUTION AUTHORIZING THE BUSINESS ADMINISTRATOR TO EXECUTE A DISCHARGE OF MORTGAGE AFFECTING 108 RANDOLPH AVENUE, A/K/A BLOCK 22704, LOT 27, F/K/A BLOCK 2008, LOT 3.D**

**Initiator**

Department/Division	HEDC	
Name/Title	Rodney Hairston	Real Estate Officer
Phone/email		RHairston@jcnj.org

Note: Initiator must be available by phone during agenda meeting (Wednesday prior to council meeting @ 4:00 p.m.)

**Resolution Purpose**

The purpose of this resolution is to approve the discharge of mortgage for 108 Randolph Ave.

**I certify that all the facts presented herein are accurate.**

\_\_\_\_\_  
Signature of Department Director

 \_\_\_\_\_  
Date

# Resolution of the City of Jersey City, N.J.

City Clerk File No. Res. 18-966

Agenda No. 10.G

Approved: NOV 07 2018

TITLE:



**RESOLUTION AUTHORIZING THE BUSINESS ADMINISTRATOR TO EXECUTE A DISCHARGE OF MORTGAGE AFFECTING 279 1/2 SECOND STREET, A/K/A BLOCK 11114, LOT 00005 F/K/A BLOCK 276, LOT K.1.**

**COUNCIL** offered and moved adoption of the following resolution:

**WHEREAS**, on January 17, 2001, Felicita & Pastor Negron ("Borrower") executed a Mortgage and Note in favor of the City of Jersey City ("City") to secure the City's loan to him in the amount of \$6,000.00 made under the HORP/SHRP Program; and

**WHEREAS** the Mortgage was recorded in Book 7910 at Page 116 of the Register of Deeds for Hudson County on March 28, 2001; and

**WHEREAS**, the loan self-amortizes over five (5) years provided the homeowner resides in the property and does not sell the property; and

**WHEREAS**, the mortgage affects property known as 279 1/2 Second Street, Jersey City, a/k/a Block 11114, Lot 00005, and f/k/a Block 276, Lot K.1;

**WHEREAS**, five (5) years have passed since the loan was made and the City is obligated to execute a Discharge of Mortgage to remove the mortgage from the public record.

**NOW, THEREFORE, BE IT RESOLVED**, that the Business Administrator is authorized to execute a Discharge of Mortgage in the sum of \$6,000.00 affecting 279 1/2 Second Street, Jersey City, a/k/a Block 11114, Lot 00005, and f/k/a Block 276, Lot K.1.

HB  
10/25/18

APPROVED: \_\_\_\_\_

APPROVED AS TO LEGAL FORM

APPROVED: [Signature]  
Business Administrator

[Signature]  
Corporation Counsel

Certification Required

Not Required

APPROVED 8-0

RECORD OF COUNCIL VOTE ON FINAL PASSAGE											
11.7.18											
COUNCILPERSON	AYE	NAY	N.V.	COUNCILPERSON	AYE	NAY	N.V.	COUNCILPERSON	AYE	NAY	N.V.
RIDLEY	✓			YUN	✓			RIVERA	✓		
PRINZ-AREY	✓			SOLOMON	✓			WATTERMAN	ABSENT		
BOGGIANO	✓			ROBINSON	✓			LAVARRO, PRES.	✓		

✓ Indicates Vote

N.V.-Not Voting (Abstain)

Adopted at a meeting of the Municipal Council of the City of Jersey City N.J.

[Signature]  
Rolando R. Lavarro, Jr., President of Council

[Signature]  
Robert Byrrie, City Clerk

**RESOLUTION FACT SHEET – NON-CONTRACTUAL**

This summary sheet is to be attached to the front of any resolution that is submitted for Council consideration. Incomplete or vague fact sheets will be returned with the resolution.

**Full Title of Ordinance/Resolution:**

**Resolution authorizing the Business Administrator to execute a Discharge of Mortgage affecting real property located at: 279 ½ Second Street, Jersey City, NJ 07302**

**Initiator**

<b>Department/Division:</b>	<b>HEDC</b>	<b>Community Development</b>
<b>Name/Title:</b>	<b>Bill Lenahan</b> <i>BL</i>	<b>Program Monitor/Grant Analyst</b>
<b>Phone/Email:</b>	<b>201-547-4728</b>	<b>BLenahan@jcnj.org</b>

Note: Initiator must be available by phone during agenda meeting (Wednesday prior to council meeting @ 4:00 p.m.)

**Resolution Purpose**

**Discharge of HIP Mortgage affecting real property located at:**

Property Address: 279 ½ Second Street, Jersey City, NJ 07302

Old Block: 276 Lot: K.1, New Block: 11114 Lot: 00005

HORP/SHRP Mortgage Amount: \$6,000.00

Execution Date of HIP Mortgage: January 17, 2001

Recording Date of HIP Mortgage: March 28, 2001 Book: 7910 Page: 116

**Basis for Discharge of Mortgage:**

Maturity of HORP/SHRP Mortgage: January 17, 2006  
Maturity Date

Satisfaction of HORP/SHRP Mortgage: \_\_\_\_\_  
Payoff Amount Date Payoff Received

**I certify that all the facts presented herein are accurate.**

*[Handwritten Signature]*  
\_\_\_\_\_  
**Signature of Department Director**

10-22-18  
\_\_\_\_\_  
**Date**

# Resolution of the City of Jersey City, N.J.

City Clerk File No. Res. 18-967

Agenda No. 10.H

Approved: NOV 07 2018

TITLE:



**RESOLUTION AUTHORIZING THE BUSINESS ADMINISTRATOR TO EXECUTE TWO DISCHARGES OF MORTGAGES AFFECTING 17 ROMAINE AVENUE, A/K/A BLOCK 12003, LOT 00022 F/K/A BLOCK 1843, LOT 25.**

**COUNCIL offered and moved adoption of the following resolution:**

**WHEREAS**, on February 5, 2008, Mohammad Tahir ("Borrower") executed a Mortgage and Note in favor of the City of Jersey City ("City") to secure the City's loan to him in the amount of \$24,900.00 made under the HROP/SHRP Program ("First Mortgage"); and

**WHEREAS** the First Mortgage was recorded in Book 16667 at Page 345 of the Register of Deeds for Hudson County on February 25, 2008; and

**WHEREAS**, on March 13, 2008, Borrower executed a second Mortgage and Note in favor of the City to secure the City's loan to him in the amount of \$24,900.00 made under the HROP/SHRP Program ("Second Mortgage"); and

**WHEREAS** the Second Mortgage was recorded in Book 12003 at Page 323 of the Register of Deeds for Hudson County on March 19, 2008; and

**WHEREAS**, the First Mortgage and the Second Mortgage self-amortize over ten (10) years provided the homeowner resides in the property and does not sell the property; and

**WHEREAS**, the First Mortgage and the Second Mortgage affect property known as 17 Romaine Avenue, Jersey City, a/k/a Block 12003, Lot 00022 f/k/a Block 1843, Lot 25;

**WHEREAS**, ten (10) years have passed since the First Mortgage and the Second Mortgage were made and the City is obligated to execute a Discharge of Mortgage to remove the mortgages from the public record.

**NOW, THEREFORE, BE IT RESOLVED**, that the Business Administrator is authorized to execute a Discharge of Mortgage in the sum of \$24,900.00 for the Mortgage executed on February 2, 2008 and recorded February 25, 2008 in Book 16667 at Page 345 affecting 17 Romaine Avenue, Jersey City, a/k/a Block 12003, Lot 00022 f/k/a Block 1843, Lot 25.

**BE IT FURTHER RESOLVED**, that the Business Administrator is authorized to execute a Discharge of Mortgage in the sum of \$24,900.00 for the Mortgage executed on March 13, 2008 and recorded March 19, 2008 in Book 12003 at Page 323 affecting 17 Romaine Avenue, Jersey City, a/k/a Block 12003, Lot 00022 f/k/a Block 1843, Lot 25.

HB 10/25/18

APPROVED: \_\_\_\_\_

APPROVED AS TO LEGAL FORM

APPROVED: \_\_\_\_\_

\_\_\_\_\_  
Corporation Counsel

Business Administrator

Certification Required

Not Required

APPROVED 8-0

RECORD OF COUNCIL VOTE ON FINAL PASSAGE 11.7.18											
COUNCILPERSON	AYE	NAY	N.V.	COUNCILPERSON	AYE	NAY	N.V.	COUNCILPERSON	AYE	NAY	N.V.
RIDLEY	✓			YUN	✓			RIVERA	✓		
PRINZ-AREY	✓			SOLOMON	✓			WATTERMAN	ABSENT		
BOGGIANO	✓			ROBINSON	✓			LAVARRO, PRES.	✓		

✓ Indicates Vote

N.V.-Not Voting (Abstain)

Adopted at a meeting of the Municipal Council of the City of Jersey City N.J.

\_\_\_\_\_  
Rolando R. Lavarro, Jr., President of Council

\_\_\_\_\_  
Robert Byrne, City Clerk

**RESOLUTION FACT SHEET**

This summary sheet is to be attached to the front of any resolution that is submitted for Council consideration. Incomplete or vague fact sheets will be returned with the resolution.

**Full Title of Ordinance/Resolution**

**RESOLUTION AUTHORIZING THE BUSINESS ADMINISTRATOR TO EXECUTE TWO DISCHARGES OF MORTGAGES AFFECTING 17 ROMAINE AVENUE, A/K/A BLOCK 12003, LOT 00022 F/K/A BLOCK 1843, LOT 25.**

**Initiator**

Department/Division	HEDC	Community Development
Name/Title	Bill Lenahan <i>BL</i>	Program Monitor/Grant Analyst
Phone/email	201-547-4728	BLenahan@jcnj.org

Note: Initiator must be available by phone during agenda meeting (Wednesday prior to council meeting @ 4:00 p.m.)

**Resolution Purpose**

The purpose of this resolution is to discharge the HIP Mortgages affecting real property located at 17 Romaine Avenue, Jersey City, New Jersey 07306 a/k/a/ Block 12003 Lot 00022 f/k/a Block 1843 Lot 25

The first HORP/SHRP Mortgage for \$24,900.00 was executed on February 5, 2008, recorded on February 25, 2008 in Book 16667 at Page 345 of the Register for Deeds for Hudson County, and matured on February 5, 2018.

The Second HORP/SHRP Mortgage for \$24,900.00 was executed on March 13, 2008, recorded on March 19, 2008 in Book 16738 at Page 323 of the Register for Deeds for Hudson County, and matured on March 13, 2018.

I certify that all the facts presented herein are accurate.

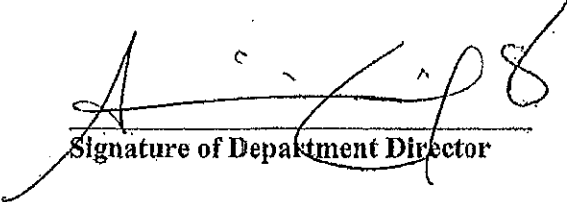
  
Signature of Department Director

10/31/2018  
Date

# Resolution of the City of Jersey City, N.J.

City Clerk File No. Res. 18-968

Agenda No. 10.1

Approved: NOV 07 2018

TITLE:



**RESOLUTION AMENDING RESOLUTION 18-808 AUTHORIZING THE EXECUTION OF A MORTGAGE SUBORDINATION AGREEMENT AFFECTING THE PROPERTIES KNOWN AS 462, 466, 470, 474 AND 478 BRAMHALL AVENUE A/K/A, BLOCK 18802, LOTS 3,4,5,6 AND 7, F/K/A BLOCK 1949, LOTS 4.N,4.P, 4.H, 4.L AND 4.M**

**COUNCIL offered and moved adoption of the following Resolution:**

**WHEREAS**, on September 12, 2018 the Council adopted Resolution 18-808, which approved the subordination of three City affordable housing mortgages against 462, 466, 470 and 478 Bramhall Avenue, a/k/a Block 18802, Lots 3-7, f/k/a Block 1949, Lots 4.N, 4.P, 4.H, 4.L and 4.M (the Properties) to the interests of a new \$1 million mortgage to Investors Bank; and

**WHEREAS**, it was subsequently discovered that the City holds a fourth mortgage against the Properties, which should have been included in the Council's approval of the subordination request; and

**WHEREAS**, the omitted mortgage was executed on March 16, 2001 and provided an additional \$150,000 of Linkage funds; and

**WHEREAS**, the fourth/omitted mortgage was recorded on March 28, 2001 in Book 7910, Page 251; and

**WHEREAS**, this resolution further amends Resolution 18-808 to correct the recording data of both City Linkage Fund mortgages and to update the current amount of the City's investment in the Properties; and

**WHEREAS**, the City's other Linkage mortgage in the amount of \$150,000 was executed on August 14, 1997 and recorded on August 18, 1997 in Book 6313 Page 287; and

**WHEREAS**, the total City investment in the Properties is \$1,400,145; and

**WHEREAS**, the Properties are deed restricted for 30 years from the date a permanent certificate of occupancy is issued; and

**WHEREAS**, the Developer is seeking to obtain a new loan from Investors Bank in order to lower its interest rate; and

**WHEREAS**, the Developer will use the loan proceeds of \$1 million dollars to pay down existing debt against the Properties; and

**WHEREAS**, the Properties recently appraised for \$7 million; and

**WHEREAS**, the City's Division of Community Development has reviewed the Developer's request to subordinate and has found that the appraised value of the Properties are sufficient to sustain the new debt and therefore recommends that the subordination be approved.

TITLE:

**RESOLUTION AUTHORIZING THE EXECUTION OF A MORTGAGE SUBORDINATION AGREEMENT AFFECTING THE PROPERTIES KNOWN AS 462, 466, 470, 474 AND 478 BRAMHALL AVENUE A/K/A, BLOCK 18802, LOTS 3,4,5,6 AND 7, F/K/A BLOCK 1949, LOTS 4.N,4.P, 4.H, 4.L AND 4.M**

**NOW, THEREFORE BE IT RESOLVED** by the Municipal Council of the City of Jersey City that:

- 1) The Mayor or Business Administrator is authorized to execute a Mortgage Subordination Agreement, subordinating the following mortgages to the interests of the new \$1 million mortgage with Investors Bank:
  - a) Mortgage and Note dated August 14, 1997 in the amount of \$1,050,000 between City of Jersey City and Bramhall, L.P. and recorded on August 18, 1997 in Book 6313 Page 287;
  - b) Mortgage and Note dated August 14, 1997 in the amount of \$150,000 between City of Jersey City and Bramhall, L.P. and recorded on August 18, 1997 in Book 6313 Page 319;
  - c) Mortgage and Note dated March 16, 2001 in the amount of \$150,000 between City of Jersey City and Bramhall, L.P. and recorded on March 28, 2001 in Book 7910 Page 251; and
  - d) Mortgage and Note dated April 22, 2002 in the amount of \$50,145 between City of Jersey City and Bramhall, L.P. and recorded on May 17, 2002 in Book 8900 Page 162.
  
- 2) The Agreement shall be in a form consistent with the above stated terms as approved by the Corporation Counsel.

JML/mma  
10/29/18

APPROVED: \_\_\_\_\_

APPROVED AS TO LEGAL FORM

APPROVED: [Signature]  
Business Administrator

[Signature]  
Corporation Counsel

Certification Required

Not Required

**APPROVED 8-0**

RECORD OF COUNCIL VOTE ON FINAL PASSAGE 11.7.18											
COUNCILPERSON	AYE	NAY	N.V.	COUNCILPERSON	AYE	NAY	N.V.	COUNCILPERSON	AYE	NAY	N.V.
RIDLEY	✓			YUN	✓			RIVERA	✓		
PRINZ-AREY	✓			SOLOMON	✓			WATTERMAN	ABSENT		
BOGGIANO	✓			ROBINSON	✓			LAVARRO, PRES	✓		

✓ Indicates Vote

N.V.-Not Voting (Abstain)

Adopted at a meeting of the Municipal Council of the City of Jersey City N.J.

[Signature]  
Rolando R. Lavarro, Jr., President of Council

[Signature]  
Robert Byrne, City Clerk



**RESOLUTION FACT SHEET**

This summary sheet is to be attached to the front of any resolution that is submitted for Council consideration. Incomplete or vague fact sheets will be returned with the resolution.

**Full Title of Ordinance/Resolution**

**RESOLUTION AMENDING A RESOLUTION 18-808 AUTHORIZING THE EXECUTION OF A MORTGAGE SUBORDINATION AGREEMENT AFFECTING THE PROPERTIES KNOWN AS 462, 466, 470, 474 AND 478 BRAMHALL AVENUE A/K/A, BLOCK 18802, LOTS 3,4,5,6 AND 7, F/K/A BLOCK 1949, LOTS 4.N,4.P, 4.H, 4.L AND 4.M**

**Initiator**

Department/Division	HEDC	
Name/Title	Rodney Hairston	Real Estate Officer
Phone/email		RHairston@jcnj.org

Note: Initiator must be available by phone during agenda meeting (Wednesday prior to council meeting @ 4:00 p.m.)

**Resolution Purpose**

The purpose of this resolution is to amend the earlier resolution 18-808 authoring the subordination of three City mortgages to a first mortgage required to develop affordable housing on Bramhall Ave.

After the adoption of the earlier resolution, it was discovered that there was actually a fourth city mortgage. This resolution, required by lenders' Title the company, authorizes the subordination of all four mortgages.

**I certify that all the facts presented herein are accurate.**

  
\_\_\_\_\_  
**Signature of Department Director**                      **Date**

# Resolution of the City of Jersey City, N.J.

City Clerk File No. Res. 18-969

Agenda No. 10.J

Approved: NOV 07 2018



TITLE:

**RESOLUTION AUTHORIZING THE EXECUTION OF A THIRD MEMORANDUM OF AGREEMENT WITH THE CORPORATION FOR NATIONAL AND COMMUNITY SERVICE REGARDING THE CITY OF JERSEY CITY'S PARTICIPATION IN THE VISTA PROGRAM**

**WHEREAS** the AmeriCorps Volunteer In Service to America Program ("VISTA") is administrated by the Corporation for National and Community Service ("CNCS"), a federal agency of the United States of America established pursuant to the National and Community Service Trust Act of 1993, 42 U.S.C. 12651 et seq.; and

**WHEREAS** the VISTA Program is a project that seeks to increase economic opportunity and workforce development within Jersey City; to expand and support youth development and mentorships that align with "My Brother's Keeper" initiatives, to develop data collection and management results protocol that deliver better services and conduct better outreach between the Resident Response Center and the Mayor's Quality of Life Task Force; and to cultivate, promote and institutionalize a culture of volunteerism that will strengthen connections between residents, local organizations and families in need while expanding access to diverse opportunities for residents to get involved and give back to their community; and

**WHEREAS**, the City of Jersey City ("City") submitted an application in 2015 to the CNCS for the City to participate in the VISTA Program which was approved; and

**WHEREAS**, Resolution 15.327, approved on May 13, 2015, and amended by Resolution 16.703 on October 26, 2016, authorized the City to execute a Memorandum of Agreement (MOA) with CNCS for the provision of VISTA Program services to the City for a three year period beginning on April 19, 2015; and

**WHEREAS**, under the terms of the original MOA, the CNCS provides the City with the services of nine VISTA volunteers and the City pays a living stipend of \$13,296.00 per VISTA volunteer per year for up to three of the VISTA Volunteers as well as costs for health benefits, FICA, optional life insurance and education awards/end-of-year stipends for each of the nine VISTA volunteers; and

**WHEREAS**, the approximate value of the services provided by the VISTA volunteers to the City during the first year of the contract was \$338,558.00; and

**WHEREAS**, the City applied to CNCS to expand the VISTA Program by increasing the number of City Departments and Divisions that the VISTA volunteers provide services to; and

TITLE:

**RESOLUTION AUTHORIZING THE EXECUTION OF A THIRD MEMORANDUM OF AGREEMENT WITH THE CORPORATION FOR NATIONAL AND COMMUNITY SERVICE REGARDING THE CITY OF JERSEY CITY'S PARTICIPATION IN THE VISTA PROGRAM**

**WHEREAS**, the CNCS agreed to the expansion of the VISTA Program and will provide the City with up to fourteen VISTA volunteers provided the City pays the updated living stipend of \$18,127.20 per year for up to three VISTA volunteers and fringe benefits; and

**WHEREAS**, the VISTA Project term is two (2) years effective April, 29 2018 through April 28, 2020 or until the final VISTA volunteer closes service; and

**WHEREAS**, the City's total cost to pay for one year of the living stipends for up to 3 VISTAs of VISTA Program volunteers will not exceed \$54,382; and

**WHEREAS**, the sum of \$21,100 is available in the Resident Response Center Operating Current Fund Account No. 01-201-20-111-314 and the remaining funds will be made available in the fiscal year 2018 temporary and/or permanent budgets; and

**WHEREAS**, in order to expand the VISTA Program, the City is required to execute a third Memorandum of Agreement with CNCS; and

**WHEREAS**, pursuant to N.J.S.A. 40A:11-5(2) of the Local Public Contracts Law, the City is authorized to execute the Memorandum of Agreement because it is with a federal agency.

**NOW, THEREFORE, BE IT RESOLVED** by the Municipal Council of the City of Jersey City that:

1. The Mayor or Business Administrator is authorized to execute a third Memorandum of Agreement in the form of the attached with the Corporation for National and Community Service that allows the City of Jersey City to expand the VISTA Program by adding five additional VISTA Program volunteers; and
2. The City shall pay the annual living stipend for up to three VISTA volunteers at an annual cost to the City of \$54,382.00.

I, Donna Maurer, Donna Maurer Chief Financial Officer, certify that funds in the amount of \$ 21,100.00 are available in Account No. 01-201-20-111-314. Ref# 131108

*SMC  
10/20/18*

APPROVED: *Kevin Lyons*  
 for 2018/10/20  
 Business Administrator

APPROVED AS TO LEGAL FORM  
*[Signature]*  
 Corporation Counsel

Certification Required   
 Not Required  **APPROVED 8-0**

RECORD OF COUNCIL VOTE ON FINAL PASSAGE 11.7.18											
COUNCILPERSON	AYE	NAY	N.V.	COUNCILPERSON	AYE	NAY	N.V.	COUNCILPERSON	AYE	NAY	N.V.
RIDLEY	✓			YUN	✓			RIVERA	✓		
PRINZ-AREY	✓			SOLOMON	✓			WATTERMAN	ABSENT		
BOGGIANO	✓			ROBINSON	✓			LAVARRO, PRES	✓		

✓ Indicates Vote N.V.-Not Voting (Abstain)

Adopted at a meeting of the Municipal Council of the City of Jersey City N.J.

*[Signature]*  
 Rolando R. Lavarro, Jr., President of Council

*[Signature]*  
 Robert Byrne, City Clerk

**RESOLUTION FACT SHEET - CONTRACT AWARD**

This summary sheet is to be attached to the front of any resolution that is submitted for Council consideration. Incomplete or vague fact sheets will be returned with the resolution.

**Full Title of Ordinance/Resolution**

**RESOLUTION AUTHORIZING THE EXECUTION OF A THIRD MEMORANDUM OF AGREEMENT WITH THE CORPORATION FOR NATIONAL AND COMMUNITY SERVICE REGARDING THE CITY OF JERSEY CITY'S PARTICIPATION IN THE VISTA PROGRAM**

**Project Manager**

Department/Division	Office of the Mayor Resident Response Center	Office of Community Engagement & Volunteerism
Name/Title	Kevin Lyons	Supervising Administrative Analyst
Phone/email	201-547-5116	lyonsk@jcnj.org

Note: Project Manager must be available by phone during agenda meeting (Wednesday prior to council meeting @ 4:00 p.m.)

**Contract Purpose**

This resolution is the third amendment to the Memorandum of Agreement (MOA) authorizing the cost share payment for the AmeriCorps VISTA program. The MOA is between the City of Jersey City and the Corporation for National and Community Service. This agreement authorizes up to 14 VISTAs and the cost share for up to 3 VISTAs at an amount not to exceed \$54,382.00. This agreement is for 2 years, effective April 29, 2018 through April 28, 2020.

**Cost (Identify all sources and amounts)**

Amount to be encumbered is \$21,100 of City funds budgeted in the CY 2018 RRC Operating Expenses

**Contract term (include all proposed renewals)**

April 29, 2018 through April 28, 2020

Type of award

If "Other Exception", enter type

**Additional Information**

I certify that all the facts presented herein are accurate.

Kevin Lyons  
Signature of Department Director

10/26/18  
Date

CORPORATION FOR NATIONAL AND COMMUNITY SERVICE  
AmeriCorps VISTA  
**MEMORANDUM OF AGREEMENT**



Between

City of Jersey City  
280 Grove Street  
Jersey City, NJ 07302-3610  
EIN: 226002013

and

Corporation for National and Community Service  
New Jersey State Office  
44 South Clinton Ave  
Suite 312  
Trenton, NJ 08609-1241

*Pursuant to Title I, Pub.L. 93-113, the Domestic Volunteer Service Act of 1973, as amended, 87 Stat. 394 hereinafter, the "Act"*

This Memorandum of Agreement, hereinafter referred to as "the Agreement", between the two above-captioned parties: 1) Corporation for National and Community Service, hereinafter referred to as "CNCS"; and 2) City of Jersey City, hereinafter referred to as the "Sponsor", sets forth the parties' understanding concerning the establishment and operation of a local project under the AmeriCorps VISTA program, pursuant to Title I, Part A of the Domestic Volunteer Service Act, as amended, (42 U.S.C. §§ 4950 et seq.), hereinafter may be referred to as "the Act". The primary purpose of this agreement is for CNCS to provide the Sponsor with up to fourteen (14) AmeriCorps VISTA members and up to fifteen (15) Summer Associates to perform volunteer service to strengthen and supplement efforts to eliminate poverty and poverty-related human, social, and environmental problems as specified in the Project Application. The Project Application is incorporated in this Agreement by reference.

The project shall be cost-shared between CNCS and the Sponsor. Accordingly, the Agreement provides for the Sponsor's funding of up to \$39,888.00 to cost-share up to three (3) AmeriCorps VISTA member(s) and up to zero (0) Summer Associates and the assignment of up to eleven (11) AmeriCorps VISTA members(s) and up to fifteen (15) Summer Associates supported by CNCS. The Sponsor's cost-share of up to three (3) VISTAs and Summer Associates is subject to annual review and renewal every 12 months. The final numbers of AmeriCorps VISTA members and/or Summer Associates placed may be less than the number listed above due to considerations, such as those related to the management, resources and budget of the VISTA program. Specific details regarding cost-share payment roles and responsibilities associated with this Agreement are set forth in paragraph 20 of Part II of this Agreement.

This Agreement is for one year, and shall become effective on the date of 09/17/2017 execution of this Agreement. The date of execution of this agreement is the date that the final signatory for either party signs and dates this Agreement. This Agreement is subject to performance of the terms as set forth in this Agreement, below in Part II. Activity on the project shall be deemed to have begun on 09/17/2017 and shall end thereafter on 09/15/2018, unless terminated sooner by either or both of the parties.

Click below to view:  
General Provisions of the Cost Share MA

In witness whereof, the parties whose signatures appear below attest to having the authority to enter into this Agreement and agree that this Agreement will become effective on the aforementioned date. (The Sponsor and Corporation for National and Community Service staff must sign the Memorandum of Agreement even though single signatures only are required for grant agreements.)

**Sponsor**

**Corporation for National and Community Service**

Electronically  
Signed By: Lyons, Kevin T

Title:

Date: 01-SEP-17

City of Jersey City  
Address: 280 Grove Street  
Jersey City, NJ 07302-3610

Phone: (201) 547-5116

Sponsor Location Code Number: 61125

Sponsor DUNS Number: 831438275

Electronically  
Signed By: Brown, Bernard

Title: State Program Director

Date: 08-SEP-17

Corporation for National and Community Service  
Address: New Jersey State Office  
44 South Clinton Ave  
Suite 312  
Trenton, NJ 08609-1241

Phone: 609-989-0474

Electronically  
Signed By: George, Michelle

Title: Executive Officer

Date: 08-SEP-17

Corporation for National and Community Service  
Address: 250 E Street SW  
Suite 300  
Washington, DC 20525-0001

Phone: 202-606-6626

CORPORATION FOR NATIONAL AND COMMUNITY SERVICE  
AmeriCorps VISTA  
**MEMORANDUM OF AGREEMENT**

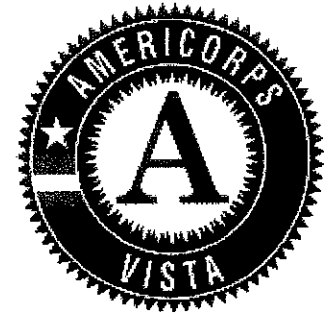

Between

City of Jersey City  
280 Grove Street  
Jersey City, NJ 07302-3610  
EIN: 226002013

and

Corporation for National and Community Service  
New Jersey State Office  
44 South Clinton Ave  
Suite 312  
Trenton, NJ 08609-1241

*Pursuant to Title I, Pub.L. 93-113, the Domestic Volunteer Service Act of 1973, as amended, 87 Stat. 394 hereinafter, the "Act"*

This Memorandum of Agreement, hereinafter referred to as "the Agreement", between the two above-captioned parties: 1) Corporation for National and Community Service, hereinafter referred to as "CNCS"; and 2) City of Jersey City, hereinafter referred to as the "Sponsor", sets forth the parties' understanding concerning the establishment and operation of a local project under the AmeriCorps VISTA program, pursuant to Title I, Part A of the Domestic Volunteer Service Act, as amended, (42 U.S.C. §§ 4950 et seq.), hereinafter may be referred to as "the Act". The primary purpose of this agreement is for CNCS to provide the Sponsor with up to five (5) AmeriCorps VISTA members and up to zero (0) Summer Associates to perform volunteer service to strengthen and supplement efforts to eliminate poverty and poverty-related human, social, and environmental problems as specified in the Project Application. The Project Application is incorporated in this Agreement by reference.

The project shall be cost-shared between CNCS and the Sponsor. Accordingly, the Agreement provides for the Sponsor's funding of up to \$15,228.00 to cost-share up to one (1) AmeriCorps VISTA member(s) and up to zero (0) Summer Associates and the assignment of up to four (4) AmeriCorps VISTA members(s) and up to zero (0) Summer Associates supported by CNCS. The Sponsor's cost-share of up to one (1) VISTAs and Summer Associates is subject to annual review and renewal every 12 months. The final numbers of AmeriCorps VISTA members and/or Summer Associates placed may be less than the number listed above due to considerations, such as those related to the management, resources and budget of the VISTA program. Specific details regarding cost-share payment roles and responsibilities associated with this Agreement are set forth in paragraph 20 of Part II of this Agreement.

This Agreement is for one year, and shall become effective on the date of 09/16/2018 execution of this Agreement. The date of execution of this agreement is the date that the final signatory for either party signs and dates this Agreement. This Agreement is subject to performance of the terms as set forth in this Agreement, below in Part II. Activity on the project shall be deemed to have begun on 09/16/2018 and shall end thereafter on 09/14/2019, unless terminated sooner by either or both of the parties.

Click below to view:  
General Provisions of the Cost Share MA

In witness whereof, the parties whose signatures appear below attest to having the authority to enter into this Agreement and agree that this Agreement will become effective on the aforementioned date. (The Sponsor and Corporation for National and Community Service staff must sign the Memorandum of Agreement even though single signatures only are required for grant agreements.)

**Sponsor**

**Corporation for National and Community Service**

By: \_\_\_\_\_  
(Sponsor signature)

By: \_\_\_\_\_  
(State Director signature)

Name: Mr. Kevin T. Lyons

Name: Melissa Allen

Title:

Title: State Program Director

Date: \_\_\_\_\_

Date: \_\_\_\_\_

City of Jersey City  
Address: 280 Grove Street  
Jersey City, NJ 07302-3610

Corporation for National and Community Service  
Address: New Jersey State Office  
44 South Clinton Ave  
Suite 312  
Trenton, NJ 08609-1241

Phone: (201) 547-5116

Phone: 609-989-0474

Sponsor Location Code Number: 61125

Sponsor DUNS Number: 831438275

By: \_\_\_\_\_  
(Executive Officer signature)

Name: Management and Program Analyst  
Kira Weiss

Title:

Date: \_\_\_\_\_

Corporation for National and Community Service  
Address: 250 E Street SW  
Suite 300  
Washington, DC 20525-0001

Phone: 202-606-6626



# Resolution of the City of Jersey City, N.J.

City Clerk File No. Res. 18-970

Agenda No. 10-K

Approved: NOV 07 2018

TITLE:



## RESOLUTION AUTHORIZING THE GRANTING OF A PERMIT TO D&M FIREWORKS, LLC, FOR A FIREWORKS DISPLAY ON NOVEMBER 30<sup>th</sup>, 2018

**COUNCIL** Offered and moved adoption of the following Resolution:

**WHEREAS**, D&M Fireworks, LLC, has applied for a permit to display fireworks on November 30, 2018 for Liberty National Golf Course, 100 Caven Point Road, Jersey City, N.J.; and

**WHEREAS**, the application for fireworks display has been reviewed and approved by the Chief of Police and the Fire Official, and is in compliance with the regulations of the Fire Prevention Code of the City; and

**WHEREAS**, D&M Fireworks, LLC, has obtained public liability insurance in the total amount of \$1,000,000 covering bodily injury and property damage with the City of Jersey City being named as an additional co-insured; and

**WHEREAS**, N.J.S.A. 21:3-3 provides that the permits for the display of fireworks must be authorized by resolution of the Municipal Council.

**NOW, THEREFORE, BE IT RESOLVED**, by the Municipal Council of the City of Jersey City that:

- (1) A permit be issued to D&M Fireworks, LLC, to display fireworks for Liberty National Golf Course on November 30, 2018 at Liberty National Golf Course, 100 Caven Point Road, Jersey City, New Jersey; and
- (2) The permit be issued on condition that no fireworks display shall commence later than 10:45 P.M. on said date; and
- (3) The permit be canceled in the event that D&M Fireworks, LLC, fails to comply with any of the provisions of the Fire Department Code of the City of Jersey City; and
- (4) A duplicate copy of the application and permit shall be forwarded to the Bureau of Explosives of the Department of Labor for filing and public inspection.

*JMK  
10/29/18*

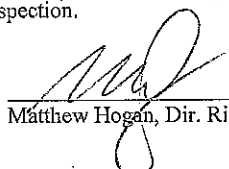
  
Matthew Hogan, Dir. Risk Management

APPROVED:   
Business Administrator

APPROVED AS TO LEGAL FORM  
  
Corporation Counsel

Certification Required   
Not Required

**APPROVED 8-0**

RECORD OF COUNCIL VOTE ON FINAL PASSAGE 11.7.18											
COUNCILPERSON	AYE	NAY	N.V.	COUNCILPERSON	AYE	NAY	N.V.	COUNCILPERSON	AYE	NAY	N.V.
RIDLEY	✓			YUN	✓			RIVERA	✓		
PRINZ-AREY	✓			SOLOMON	✓			WATTERMAN	ABSENT		
BOGGIANO	✓			ROBINSON	✓			LAVARRO, PRES.	✓		

✓ Indicates Vote

N.V.-Not Voting (Abstain)

Adopted at a meeting of the Municipal Council of the City of Jersey City N.J.

  
Rolando R. Lavarro, Jr., President of Council

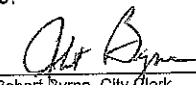
  
Robert Byrne, City Clerk

**RESOLUTION FACT SHEET – NON-CONTRACTUAL**

This summary sheet is to be attached to the front of any resolution that is submitted for Council consideration. Incomplete or vague fact sheets will be returned with the resolution.

**Full Title of Ordinance/Resolution**

Resolution authorizing the granting of a permit to D&M Fireworks, LLC, for a firework display on November 30, 2018.

**Initiator**

Department/Division	Mayor's Office	Divison of Cultural Affairs
Name/Title	Christine Goodman	Director
Phone/email	201-547-6921	cgoodman@icnj.org

Note: Initiator must be available by phone during agenda meeting (Wednesday prior to council meeting @ 4:00 p.m.)

**Resolution Purpose**

Granting of a permit to have a firework display by D&M Fireworks, LLC, for Liberty National Golf Course. The application attached was reviewed and signed by the Police Chief and Fire Official. D&M Fireworks have obtained public liability insurance in the total amount of \$1,000,000 covering bodily injury and property damage with the City of Jersey City being named as an additional co-insured. This resolution requires the signature of Matthew Hogan, Director of Risk Management.

I certify that all the facts presented herein are accurate.

        1/2          
Signature of Department Director

        10/31/18          
Date



Steven M. Fulop  
Mayor

# CITY OF JERSEY CITY OFFICE OF CULTURAL AFFAIRS

City Hall 280 Grove Street #215  
Jersey City, NJ 07302  
(201)547-6921 culturalaffairs@jcnj.org

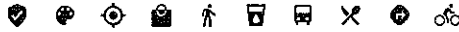

ART. MUSIC. FILM. DANCE. HERITAGE. #JERSEYCITY  
**SPECIAL EVENT APPLICATION**

Signature Page



Christine Goodman  
Director

**EVENT NAME:** LIBERTY NATIONAL GOLF COURSE FIREWORKS 2018 (PRIVATE PROPERTY) **EVENT DATE:** NOV 30 2018

**EVENT LOCATION:** LIBERTY NATIONAL

**OFFICE OF CULTURAL AFFAIRS REVIEWER**



Initials of CA Reviewer: *Cultural Affairs Event Planner*

DocuSigned by:

*Cultural Affairs Event Planner*

C2E39AE6294247B...

**JERSEY CITY POLICE DEPARTMENT: EAST DISTRICT COMMANDER**

- Approved  Coordinate On-Duty Personnel Signature of District Commander: .....
- NOT Approved  Coordinate Off-Duty Personnel Comments: ..... Date: .....

**JERSEY CITY POLICE DEPARTMENT: NORTH DISTRICT COMMANDER**

- Approved  Coordinate On-Duty Personnel Signature of District Commander: .....
- NOT Approved  Coordinate Off-Duty Personnel Comments: ..... Date: .....

**JERSEY CITY POLICE DEPARTMENT: SOUTH DISTRICT COMMANDER**

- Approved  Coordinate On-Duty Personnel Signature of District Commander: .....
- NOT Approved  Coordinate Off-Duty Personnel Comments: ..... Date: .....

**JERSEY CITY POLICE DEPARTMENT: WEST DISTRICT COMMANDER**

- Approved  Coordinate On-Duty Personnel Signature of District Commander: .....
- NOT Approved  Coordinate Off-Duty Personnel Comments: ..... Date: .....

**JERSEY CITY POLICE DEPARTMENT: POLICE CHIEF**

- Approved  Coordinate On-Duty Personnel Signature of Police Chief: .....
- NOT Approved  Coordinate Off-Duty Personnel Comments: ..... Date: 11/1/2018

DocuSigned by:

*Deputy Chief Michael Gajewski*

8108999C2C0477

**JERSEY CITY POLICE DEPARTMENT: POLICE OFF DUTY COORDINATOR**

- Acknowledged Date: ..... Signature of Off Duty Coordinator: .....

**JERSEY CITY FIRE DEPARTMENT**

- Approved  No Cooking / Open Flame Signature of Fire Official: .....
- NOT Approved  Additional Permits/Inspector Required Comments: permits for fireworks/ apparatus standby Date: 11/27/2018

DocuSigned by:

*Dennis Miller*

**JERSEY CITY POLICE DEPARTMENT: SAFETY DIRECTOR**

- Approved  Coordinate On-Duty Personnel Signature of Police Director: .....
- NOT Approved  Coordinate Off-Duty Personnel Comments: Fireworks permit/court approval required Date: 11/27/2018

DocuSigned by:

*Bill O'Donnell*

**JERSEY CITY DIVISION OF ENGINEERING & TRAFFIC**

- Acknowledged  Pending Council Approval Signature of Traffic Engineer: .....
- Not Applicable  Need Completed Signature Page Comments: ..... Date: .....

**JERSEY CITY DEPARTMENT HEALTH & HUMAN SERVICES**

- No Food will be Sold  Vendor List Required Signature of Health Officer: .....
- Food will be Sold  Health Inspector Required Comments: ..... Date: .....

**JERSEY CITY DEPARTMENT OF RECREATION**

- Stage Request: Approved Signature of Stage Coordinator: .....
- Stage: NOT Approved Comments: ..... Date: .....

**JERSEY CITY DEPARTMENT OF PUBLIC WORKS: DIRECTOR'S OFFICE**

- Approved  Requiring additional form Signature of DPW Director: .....
- NOT Approved  Additional fee will apply Comments: ..... Date: .....

**JERSEY CITY DIVISION OF RISK MANAGEMENT**

- COI is Approved  Waiver request is Approved Signature of Risk Manager: .....
- COI is NOT Approved  Waiver request is NOT Approved Comments: ..... Date: 11/2/2018

DocuSigned by:

*Matthew Hogan*

6B486D389222404

**JERSEY CITY DIVISION OF COMMERCE**

- Approved Date: ..... Signature of Division of Commerce Director: .....



Steven M. Fulop  
Mayor

# CITY OF JERSEY CITY OFFICE OF CULTURAL AFFAIRS

City Hall 280 Grove Street #215  
Jersey City, NJ 07302

(201) 547 - 6921    culturalaffairs@jcnj.org



ART. MUSIC. FILM. DANCE. HERITAGE. #JERSEYCITY  
**SPECIAL EVENT APPLICATION**



Christine Goodman  
Director

## CAPTAIN & CHIEF'S NOTES

**EAST DISTRICT COMMANDER**

**WEST DISTRICT COMMANDER**

**NORTH DISTRICT COMMANDER**

**SOUTH DISTRICT COMMANDER**

**DEPUTY CHIEF OF POLICE**



Steven M. Fulop  
Mayor

# CITY OF JERSEY CITY OFFICE OF CULTURAL AFFAIRS

City Hall 280 Grove Street #215  
Jersey City, NJ 07302  
(201) 547 - 6921 culturalaffairs@jcnj.org



## ART. MUSIC. FILM. DANCE. HERITAGE. #JERSEYCITY SPECIAL EVENT APPLICATION OVERVIEW



Christine Goodman  
Director

Greetings Department Directors, Liaisons, & Staff,

Attached is a Special Event Application for a community organized special event in Jersey City. Please review, approve / disapprove & sign the Signature Page, there is also a space for comments.

In specific cases, organizations / organizers may be waiting on updated insurance or a complete vendor list. We have noted below if any documents are missing and/or incomplete and when we expect to have those documents. If you have any concerns or require clarification, please reach out to the Office of Cultural Affairs at extension 6921.

Thank you for your time & attention,  
Special Events Planning Team Office of Cultural Affairs

**TITLE:** LIBERTY NATIONAL GOLF COURSE FIREWORKS **DATE:** 11/30/2018

**LOCATION:** LIBERTY NATIONAL GC **TIME:** 10:30PM-10:45PM

**ORGANIZATION:** LIBERTY NATIONAL GC **PHONE:** 201-333-4105

**DESCRIPTION:** PRIVATE PROPERTY - FIREWORKS FROM LIBERTY GOLF COURSE

- PHOTO I.D.** .....
- NON-PROFIT** N/A .....
- INSURANCE** .....
- STREET CLOSURE** N/A .....
- SITE MAP** .....
- PARADE ROUTE** N/A .....
- OPEN FLAME / FIRE INSPECTOR** FIREWORKS INCLUDED .....
- TENTS** N/A .....
- FOOD VENDORS / HEALTH INSPECTOR** N/A .....
- ALCOHOL BEVERAGE CONTROL** N/A .....
- AMPLIFIED SOUND** N/A .....
- STAGE** N/A .....
- PARK** N/A .....
- BARRICADES** N/A .....
- SANITATION** N/A .....
- PORTOJOHNS** N/A .....
- GOODS / SERVICES VENDORS** N/A .....

CA Event Planner TDM .....



# CITY OF JERSEY CITY OFFICE OF CULTURAL AFFAIRS

City Hall, 280 Grove Street Rm #215  
Jersey City, NJ 07302

(201) 547 - 6921 culturalaffairs@jcnj.org



ART. MUSIC. FILM. DANCE. HERITAGE. #JERSEYCITY

## 2018 SPECIAL EVENT APPLICATION

\*Application MUST be submitted a minimum of 60 days prior to event date.\*



Steven M. Fulop  
Mayor

Christine Goodman  
Director

### GENERAL INFORMATION

Title of Event: Liberty National Golf course Fireworks  
Location of Event: Liberty National GC  
Contact Person / Organizer: Shaun Lewis / David Albitz  
Contact Person Address: 100 Caven Point Rd Jersey City, NJ  
Organization: Liberty National GC  
Organization Address (if different from above): NA  
Email: dave@dmfireworks.com

REQUIRED: Attach copy of photo ID   
Date of Event: 11/30/18  
Day of the Week: Friday  
Phone #: 201-333-4105 Ext. 306  
Mobile #: 516-965-9686  
Phone # for the Public: 201-333-4105 Ext. 306

Are you a Non-Profit? Yes  No  Attach proof of non-profit status (IRS approval letter) **here**.

If any person, organization, or corporation engaged in this activity will realize a profit, please provide the following:

Name: NA Address: NA

If charity, gratuity or offerings will be solicited or accepted, name the Charity and give the reason:  
NA

### EVENT TIMES

No event will be permitted past 10 PM. Amplified sound / music must be turned off 1 hour prior to event end time.

Start Time: 10:30 P.M. End Time: 10:45 P.M.

This refers to the advertised time that the event will be open / closed to the public.

Time you will begin setup: Not a public event

For events that take place in a street, this is the time that street closure will begin and Off Duty Police will be required.

Time you will be completely done with clean-up: NA P.M.

Events that surpass this approved time will be subject to additional fees.

### ATTENDANCE

Estimated for this year: 100 If applicable, attendance last year: \_\_\_\_\_

### DESCRIPTION OF EVENT

Please describe the intent of the Special Event you are proposing and how it will serve Jersey City.

This event is private.

### INSURANCE

The Applicant must have an Occurrence Based General Liability Insurance Policy with a minimum of \$1,000,000.00 coverage. The Applicant must submit a Certificate of Insurance (C.O.I) with the application evidencing the above coverage. The C.O.I. must name the **City of Jersey City, 280 Grove Street, Jersey City, NJ 07302** as the Certificate Holder and name the "City of Jersey City, its officers and employees" as additional insured and also include in the description along with the date(s) of event. Attach C.O.I. or Waiver Request letter **here**.

Check if you will be seeking an Insurance Waiver from the Office of Risk Management. (Request letter **required**) Please refer to the Cultural Affairs website [jerseycityculture.org](http://jerseycityculture.org) for minimum waiver requirements before checking box.

### TYPE OF EVENT (Check ALL that apply)

- |  |   |  |   |
|--|---|--|---|
| <input type="checkbox"/> Non-Profit        | <input type="checkbox"/> Filmmaking   Photography | <input type="checkbox"/> Moving Assemblage | <input type="checkbox"/> Holiday Market |
| <input type="checkbox"/> For Profit        | <input type="checkbox"/> Performing Arts          | <input type="checkbox"/> Parade            | <input type="checkbox"/> Farmers Market |
| <input type="checkbox"/> Festival          | <input type="checkbox"/> Visual Arts              | <input type="checkbox"/> Procession        | <input type="checkbox"/> Trade Show     |
| <input type="checkbox"/> Music             | <input type="checkbox"/> Political Organization   | <input type="checkbox"/> Run   Marathon    | <input type="checkbox"/> Health Fair    |
| <input type="checkbox"/> Carnival          | <input type="checkbox"/> Rally   Strike   Protest | <input type="checkbox"/> Charity Walk      | <input type="checkbox"/> Flea Market    |
| <input type="checkbox"/> Circus            | <input type="checkbox"/> Canning   Soliciting     | <input type="checkbox"/> Bike   Cycling    | <input type="checkbox"/> Food Market    |
| <input type="checkbox"/> Civic   Community | <input type="checkbox"/> Community Clean-up       | <input type="checkbox"/> Athletic          | <input type="checkbox"/> Sidewalk Sale  |
| <input type="checkbox"/> Environmental     | <input type="checkbox"/> Block Party              |  |   |

### LOCATION OF EVENT (Attach a site map **here** and the Property Approval letter(s) for Private Property **here**)

<input type="checkbox"/> Public Street	<input type="checkbox"/> Park	<input checked="" type="checkbox"/> Private Property	<input type="checkbox"/> Other
Street Name:.....	Name:.....	Address: <u>100 Caven Point Rd</u>	.....
Cross Streets:.....	Cross Streets:.....	Cross Streets:.....	.....
Cross Streets:.....	Cross Streets:.....	Cross Streets:.....	.....
Owner:.....	Owner:.....	Owner:.....	.....

### DIVISION OF ENGINEERING & TRAFFIC

Are you requesting a street closure? (**Street closures are subject to a vote by City Council**)  Yes  No  
If yes, which street(s)? ..... Cross street(s)? .....

When will the street closure begin?..... When will the street closure end? .....

If the event is more than one day, will the street closure be overnight?  Yes  No

If block to be closed is residential, how many residents? .....

Attach a list of the the name(s) and address(es) of all businesses on the block to be closed **here**.

\*\*Additional info may be required.

### PARKING ENFORCEMENT

Will parking be prohibited or restricted? Yes  No

If yes, once your street closure is issued by the Division of Engineering & Traffic you will be required to visit **PARKING ENFORCEMENT** to obtain paper **NO PARKING** signs no later than 72 hours before your event.

394 Central Ave, Jersey City, NJ 07307 201.547.5538

**BE ADVISED:** If you do not obtain **NO PARKING** signs and post them less than 48 hours before your event, the City cannot legally enforce, ticket, and/or remove any vehicles in your event area on the day of your event.

### PUBLIC SAFETY

Will there be a moving assembly as part of this event; ie. parade, procession, walk, run or cycle? Yes  No

If Yes , how many contingent groups / marchers are expected? Total # of Groups: ..... Total # of Marchers: .....

Will this moving assembly include Floats and/or Automobiles ? Yes  No

Number of floats: ..... Hand pushed carts: ..... Motorized vehicles: .....

**\*\*Vehicles will require valid insurance, registration, and must be operated by licensed drivers. Vehicles deemed unsafe by Public Safety will not be permitted to participate. Motorized Vehicles are not authorized at any point during an event to perform tricks, stunts, or engage in dangerous driving maneuvers.**

Parade marchers & floats will begin to assemble at: Time: ..... Location: .....

Parade will kick-off at: Time: ..... Location: .....

Parade will finish at: Time: ..... Location: .....

Route of Event: Please detail exact streets and directional turns of entire route and attach list & map **here**.

**\*\* Attach parade line-up with numbers per group here.**

### FIRE PREVENTION

Will you be using a generator over 55 gallons? Yes  No

Will you be installing electrical wiring? Yes  No

If Yes, please explain: .....

Are fireworks included in your event? Yes  No

**\*\*Application for fireworks must be submitted and approved.**

Will you have rides or inflatable amusements? Yes  No

**\*\*Only State permitted rides are allowed.** Number of Rides: .....

Are you setting up a tent? (see tent requirements) Yes  No:

Number of tent(s): ..... Size(s) of tent(s): .....

Will food be cooked on-site? Yes  No

Will any vendors present be using an open flame? Yes  No

**\*\* Additional permits will be required from Fire Prevention, 465 Marin Blvd, 201.547.4255.**

### DEPARTMENT OF HEALTH & HUMAN SERVICES

Will you or any vendor be distributing food for **free**? Yes  No

Will you or any vendor be **selling** food? Yes  No

Will there be food trucks present at your event? Yes  No

**\*\* Additional permits will be required from HHS 199 Summit Ave 201.547.6800. Attach food vendor contact list here.**

Will animals be involved in this event? Yes  No

List species of animals to be present at the event ? .....

Name of pet establishment, farm, or vendor providing the animals? .....

### ALCOHOL BEVERAGE CONTROL

Will any beer, wine or other alcoholic beverages be present and/or sold for public consumption? Yes  No

Your organization is responsible for obtaining an ABC permit directly with the State Division of Alcohol Beverage Control. If you need further assistance please visit the ABC Enforcement Bureau located at the East District Police Precinct.

Once you have your ABC permit please email a copy to the Office of Cultural Affairs [culturalaffairs@jcnj.org](mailto:culturalaffairs@jcnj.org)

**\*\*NO** glass bottles should be distributed at public events. I understand & will comply .....



### ENTERTAINMENT

Will your event involve Live Entertainment and/or Amplified sound? Yes  No

Will your event include a Stage provided by a private company? Yes  No

Please explain (describe stage: including length, width, height) .....

Contact info of company you are hiring: .....

Will you be hiring a private sound company? Yes  No

Name & contact info of company you are hiring: .....

The City of Jersey City welcomes public events and celebrates the vast diversity of our community. We encourage public art programming, civic pride events and music. We ask, that all event organizers adopt the philosophy that events should occur with as little inconvenience to our residents as possible. So, in addition to obeying all City ordinances relating to time constraints and noise, please keep amplified sound at a reasonable level. Amplified sound is intended to broadcast music and spoken word to only reach the audience in attendance. Excessive amplification is unnecessary and compromises the quality of life in our city.

I understand & will comply DA

### DEPARTMENT OF RECREATION

Check this box here if you would like to request a stage offered by the Department of Recreation. Which stage?

- SMALL SHOWMOBILE       LARGE SHOWMOBILE       MAIN STAGE
- 15' wide x 20' long      15' wide x 25' long      20' wide x 30' long

Deliver stage to (address) ..... by ..... (time) & picked up by ..... (time).

### DEPARTMENT OF PUBLIC WORKS - PARKS & FORESTRY

Will you be requesting use of a City park? Yes  No

Which park? ..... Which area inside the park? .....

Describe any literature you plan to sell or distribute: .....

\*No cooking, alcohol distribution, or private events are permitted in City parks. I understand & will comply .....

### DEPARTMENT OF PUBLIC WORKS - BUILDING & STREETS

Will you be requiring barricades for your event? Yes  No

In addition to the standard for a street closure, how many barricades are you requesting? .....

What corner or address are you requesting the barricades to be delivered? .....

### DEPARTMENT OF PUBLIC WORKS - SANITATION

Event organizers are responsible for clean-up of an event site. Many events require specific types of clean-up services. These special services are available from DPW Division of Sanitation. Additional fees will apply.

The Division of Sanitation form can be found at [jerseycityculture.org/specialeventforms](http://jerseycityculture.org/specialeventforms)

Please initial to indicate that you understand which events require additional services & will comply DA

- Street sweepers are required for any parades, walks, processions, and/or street festivals, especially if food vendors and/or alcohol are involved.
- A dumpster or packer truck pickup is required at every public event depending on expected attendance.
- Adequate trash & recycling receptacles are required, with sufficient bags to accommodate the entire event.
- A professional cleaning company with wheeled barrels & individuals sweeping to remove refuse is recommended.

If you are instead hiring a professional company to clean-up the event, provide their contact info.

Name: NA Contact number: NA

### BASIC REQUIREMENTS

Event organizers are responsible for providing at events with more than 50 attendees the following basic necessities:  
Please check below to indicate that **you understand & will comply**

- Portable Toilets: Event Organizers **MUST** provide ample units to accomodate attendees.  
(please reference chart at [www.jerseycityculture.org/specialevents](http://www.jerseycityculture.org/specialevents))
- ADA accessible units **MUST** be included and available for public. (see chart)
- Clean drinkable water **MUST** be available at public events free of charge.

Name & contact info of portable toilet company you are renting units from: .....

Number of Units: Standard..... ADA.....

Please explain your plan to provide water: .....

### SEVERE WEATHER / RESCHEDULING

Please check below to indicate that you understand & will comply

If severe weather conditions postpone the start time of the event, or if the entire event must be cancelled or moved to another location, the Office of Cultural Affairs must be notified in writing at least 24 hours prior to the start time of the event. The Office of Cultural Affairs reserves the right to rescind this application at any time for good cause, especially in the case of a State of Emergency. **Accomodations will be made based on availability.**

I understand & will comply DA

### DIVISION OF COMMERCE

- Will there be Vendors selling goods or services? Yes  No  If Yes, how many? .....
- (Please attach full list of business names, addresses, & phone numbers **here**)
- Will you conduct Raffles or Games of Chance? Yes  No
- Additional Permit must be obtained through the Division of Commerce and the **State Legalized Game of Chance Control Commission.**
- Will alcohol be consumed or sold at this event? Yes  No
- Additional Permit must be obtained through from Division of Commerce and the **State Alcohol Beverage Control.**

### INDEMNIFICATION

The undersigned Applicant agrees to assume any and all risk of loss or damage of any kind whatsoever to property or injury to or death including wrongful death of persons arising out of the Applicant's use of any premises during the Special Event. The Applicant further agrees to indemnify and hold harmless the City, its officers, directors, employees or agents from and against any and all claims, suits and demands based upon any of the risks so assumed, whether just or unjust, fraudulent or not, and for all costs and expenses incurred by them in the defense, settlement or satisfaction of any such claims, including attorney's fees and costs of suit. If so directed, the Applicant shall, at no cost or expense to the City, defend against such claims, in which event the Applicant shall not, without obtaining express permission in advance from the Corporation Counsel of the City, raise any defense involving in any way the immunity of the City, or the provisions of any statutes respecting suits against the City. The Applicant's liability hereunder shall continue after the termination of the Special Event with respect to any liability, loss, expense or damage resulting from acts occurring prior to termination.

I understand & will comply DA

### SIGNATURE

Name of Person coordinating the Event / Application ("Applicant"):  
 Print Name: shaun Lewis / David Albitz Signature Name: David Albitz  
 Phone Number: 201-333-4105 Ext. 306 Date Submitted: 10/24/18...4D4DD...

\*\*\* DO NOT WRITE BELOW THIS LINE \*\*\*

Application Received by: Cultural Affairs Event Planner Date Received: .....

C2E39AE6294247B...



# CERTIFICATE OF LIABILITY INSURANCE

DATE (MM/DD/YYYY)  
10/24/2018

**THIS CERTIFICATE IS ISSUED AS A MATTER OF INFORMATION ONLY AND CONFERS NO RIGHTS UPON THE CERTIFICATE HOLDER. THIS CERTIFICATE DOES NOT AFFIRMATIVELY OR NEGATIVELY AMEND, EXTEND OR ALTER THE COVERAGE AFFORDED BY THE POLICIES BELOW. THIS CERTIFICATE OF INSURANCE DOES NOT CONSTITUTE A CONTRACT BETWEEN THE ISSUING INSURER(S), AUTHORIZED REPRESENTATIVE OR PRODUCER, AND THE CERTIFICATE HOLDER.**

**IMPORTANT: If the certificate holder is an ADDITIONAL INSURED, the policy(ies) must be endorsed. If SUBROGATION IS WAIVED, subject to the terms and conditions of the policy, certain policies may require an endorsement. A statement on this certificate does not confer rights to the certificate holder in lieu of such endorsement(s).**

<b>PRODUCER</b> Britton Gallagher One Cleveland Center, Floor 30 1375 East 9th Street Cleveland OH 44114	<b>CONTACT NAME:</b> PHONE (A/C, No, Ext): 216-658-7100      FAX (A/C, No): 216-658-7101 E-MAIL ADDRESS: _____														
<b>INSURED</b> 6992  D & M Fireworks LLC P.O. Box 503 Bally PA 19503	<table border="1" style="width: 100%; border-collapse: collapse;"> <thead> <tr> <th style="width: 80%;">INSURER(S) AFFORDING COVERAGE</th> <th style="width: 20%;">NAIC #</th> </tr> </thead> <tbody> <tr> <td>INSURER A : Everest Indemnity Insurance Co.</td> <td style="text-align: center;">10851</td> </tr> <tr> <td>INSURER B : Everest National Insurance Company</td> <td style="text-align: center;">10120</td> </tr> <tr> <td>INSURER C : Maxum Indemnity Company</td> <td style="text-align: center;">26743</td> </tr> <tr> <td>INSURER D : Liberty Insurance Corporation</td> <td></td> </tr> <tr> <td>INSURER E :</td> <td></td> </tr> <tr> <td>INSURER F :</td> <td></td> </tr> </tbody> </table>	INSURER(S) AFFORDING COVERAGE	NAIC #	INSURER A : Everest Indemnity Insurance Co.	10851	INSURER B : Everest National Insurance Company	10120	INSURER C : Maxum Indemnity Company	26743	INSURER D : Liberty Insurance Corporation		INSURER E :		INSURER F :	
INSURER(S) AFFORDING COVERAGE	NAIC #														
INSURER A : Everest Indemnity Insurance Co.	10851														
INSURER B : Everest National Insurance Company	10120														
INSURER C : Maxum Indemnity Company	26743														
INSURER D : Liberty Insurance Corporation															
INSURER E :															
INSURER F :															

**COVERAGES      CERTIFICATE NUMBER: 2024825855      REVISION NUMBER:**

THIS IS TO CERTIFY THAT THE POLICIES OF INSURANCE LISTED BELOW HAVE BEEN ISSUED TO THE INSURED NAMED ABOVE FOR THE POLICY PERIOD INDICATED. NOTWITHSTANDING ANY REQUIREMENT, TERM OR CONDITION OF ANY CONTRACT OR OTHER DOCUMENT WITH RESPECT TO WHICH THIS CERTIFICATE MAY BE ISSUED OR MAY PERTAIN, THE INSURANCE AFFORDED BY THE POLICIES DESCRIBED HEREIN IS SUBJECT TO ALL THE TERMS, EXCLUSIONS AND CONDITIONS OF SUCH POLICIES. LIMITS SHOWN MAY HAVE BEEN REDUCED BY PAID CLAIMS.

INSR LTR	TYPE OF INSURANCE	ADDL INSR	SUBR WVD	POLICY NUMBER	POLICY EFF (MM/DD/YYYY)	POLICY EXP (MM/DD/YYYY)	LIMITS
A	<b>GENERAL LIABILITY</b> <input checked="" type="checkbox"/> COMMERCIAL GENERAL LIABILITY <input type="checkbox"/> CLAIMS-MADE <input checked="" type="checkbox"/> OCCUR  GEN'L AGGREGATE LIMIT APPLIES PER: <input type="checkbox"/> POLICY <input checked="" type="checkbox"/> PROJECT <input type="checkbox"/> LOC			S18GL00244-181	11/20/2018	11/20/2019	EACH OCCURRENCE \$1,000,000 DAMAGE TO RENTED PREMISES (Ea occurrence) \$500,000 MED EXP (Any one person) \$ PERSONAL & ADV INJURY \$1,000,000 GENERAL AGGREGATE \$2,000,000 PRODUCTS - COMP/OP AGG \$2,000,000 _____ \$
B	<b>AUTOMOBILE LIABILITY</b> <input checked="" type="checkbox"/> ANY AUTO <input type="checkbox"/> ALL OWNED AUTOS <input type="checkbox"/> SCHEDULED AUTOS <input checked="" type="checkbox"/> HIRED AUTOS <input checked="" type="checkbox"/> NON-OWNED AUTOS			S18CA00014-181	11/20/2018	11/20/2019	COMBINED SINGLE LIMIT (Ea accident) \$1,000,000 BODILY INJURY (Per person) \$ BODILY INJURY (Per accident) \$ PROPERTY DAMAGE (Per accident) \$ _____ \$
C	<b>UMBRELLA LIAB</b> <input checked="" type="checkbox"/> OCCUR <input checked="" type="checkbox"/> EXCESS LIAB <input type="checkbox"/> CLAIMS-MADE  DED    RETENTION \$			EXC6017512-08	11/20/2018	11/20/2019	EACH OCCURRENCE \$4,000,000 AGGREGATE \$4,000,000 _____ \$
D	<b>WORKERS COMPENSATION AND EMPLOYERS' LIABILITY</b> Y/N ANY PROPRIETOR/PARTNER/EXECUTIVE OFFICER/MEMBER EXCLUDED? <input type="checkbox"/> N/A (Mandatory in NH) If yes, describe under DESCRIPTION OF OPERATIONS below			WC5-33S-352348-018(NJ)	11/17/2018	11/17/2019	<input checked="" type="checkbox"/> WC STATUTORY LIMITS    OTH-ER E.L. EACH ACCIDENT \$500,000 E.L. DISEASE - EA EMPLOYEE \$500,000 E.L. DISEASE - POLICY LIMIT \$500,000

**DESCRIPTION OF OPERATIONS / LOCATIONS / VEHICLES** (Attach ACORD 101, Additional Remarks Schedule, if more space is required)  
 Additional Insured extension of coverage is provided by above referenced General Liability policy where required by written agreement.  
 Display Date: 11/30/18    Rain Date: TBD  
 Location: Liberty National GC Property  
 Liberty National GC and City of Jersey City as their interests may appear are additionally insured in regards to above listed display.

<b>CERTIFICATE HOLDER</b>  Liberty National GC 100 Caven Point Road Jersey City NJ 07305	<b>CANCELLATION</b>  SHOULD ANY OF THE ABOVE DESCRIBED POLICIES BE CANCELLED BEFORE THE EXPIRATION DATE THEREOF, NOTICE WILL BE DELIVERED IN ACCORDANCE WITH THE POLICY PROVISIONS.  AUTHORIZED REPRESENTATIVE 
--	--



# CERTIFICATE OF LIABILITY INSURANCE

DATE (MM/DD/YYYY)

10/24/2018

**THIS CERTIFICATE IS ISSUED AS A MATTER OF INFORMATION ONLY AND CONFERS NO RIGHTS UPON THE CERTIFICATE HOLDER. THIS CERTIFICATE DOES NOT AFFIRMATIVELY OR NEGATIVELY AMEND, EXTEND OR ALTER THE COVERAGE AFFORDED BY THE POLICIES BELOW. THIS CERTIFICATE OF INSURANCE DOES NOT CONSTITUTE A CONTRACT BETWEEN THE ISSUING INSURER(S), AUTHORIZED REPRESENTATIVE OR PRODUCER, AND THE CERTIFICATE HOLDER.**

**IMPORTANT: If the certificate holder is an ADDITIONAL INSURED, the policy(ies) must be endorsed. If SUBROGATION IS WAIVED, subject to the terms and conditions of the policy, certain policies may require an endorsement. A statement on this certificate does not confer rights to the certificate holder in lieu of such endorsement(s).**

<b>PRODUCER</b> Britton Gallagher One Cleveland Center, Floor 30 1375 East 9th Street Cleveland OH 44114		<b>CONTACT NAME:</b>	
		PHONE (A/C No, Ext): 216-658-7100	FAX (A/C No): 216-658-7101
		<b>E-MAIL ADDRESS:</b>	
		<b>INSURER(S) AFFORDING COVERAGE</b>	
		<b>NAIC #</b>	
<b>INSURED</b> D & M Fireworks LLC P.O. Box 503 Bally PA 19503		6992	
		<b>INSURER A : Everest Indemnity Insurance Co.</b>	
		<b>INSURER B : Everest National Insurance Company</b>	
		<b>INSURER C : Maxum Indemnity Company</b>	
		<b>INSURER D : Liberty Insurance Corporation</b>	
		<b>INSURER E :</b>	
		<b>INSURER F :</b>	

**COVERAGES**

**CERTIFICATE NUMBER: 1973076223**

**REVISION NUMBER:**

**THIS IS TO CERTIFY THAT THE POLICIES OF INSURANCE LISTED BELOW HAVE BEEN ISSUED TO THE INSURED NAMED ABOVE FOR THE POLICY PERIOD INDICATED. NOTWITHSTANDING ANY REQUIREMENT, TERM OR CONDITION OF ANY CONTRACT OR OTHER DOCUMENT WITH RESPECT TO WHICH THIS CERTIFICATE MAY BE ISSUED OR MAY PERTAIN, THE INSURANCE AFFORDED BY THE POLICIES DESCRIBED HEREIN IS SUBJECT TO ALL THE TERMS, EXCLUSIONS AND CONDITIONS OF SUCH POLICIES. LIMITS SHOWN MAY HAVE BEEN REDUCED BY PAID CLAIMS.**

INSR LTR	TYPE OF INSURANCE	ADDL SUBR INSR WVD	POLICY NUMBER	POLICY EFF (MM/DD/YYYY)	POLICY EXP (MM/DD/YYYY)	LIMITS	
A	<b>GENERAL LIABILITY</b> <input checked="" type="checkbox"/> COMMERCIAL GENERAL LIABILITY <input type="checkbox"/> CLAIMS-MADE <input checked="" type="checkbox"/> OCCUR  GEN'L AGGREGATE LIMIT APPLIES PER: <input type="checkbox"/> POLICY <input checked="" type="checkbox"/> PROJECT <input type="checkbox"/> LOC		S18GL00244-181	11/20/2018	11/20/2019	EACH OCCURRENCE	\$1,000,000
						DAMAGE TO RENTED PREMISES (Ea occurrence)	\$500,000
						MED EXP (Any one person)	\$
						PERSONAL & ADV INJURY	\$1,000,000
						GENERAL AGGREGATE	\$2,000,000
						PRODUCTS - COMP/OP AGG	\$2,000,000
							\$
B	<b>AUTOMOBILE LIABILITY</b> <input checked="" type="checkbox"/> ANY AUTO <input type="checkbox"/> ALL OWNED AUTOS <input checked="" type="checkbox"/> HIRED AUTOS <input type="checkbox"/> SCHEDULED AUTOS <input checked="" type="checkbox"/> NON-OWNED AUTOS		S18CA00014-181	11/20/2018	11/20/2019	COMBINED SINGLE LIMIT (Ea accident)	\$1,000,000
						BODILY INJURY (Per person)	\$
						BODILY INJURY (Per accident)	\$
						PROPERTY DAMAGE (Per accident)	\$
							\$
C	<input checked="" type="checkbox"/> UMBRELLA LIAB <input checked="" type="checkbox"/> EXCESS LIAB DED:      RETENTION \$	<input checked="" type="checkbox"/> OCCUR <input type="checkbox"/> CLAIMS-MADE	EXC6017512-08	11/20/2018	11/20/2019	EACH OCCURRENCE	\$4,000,000
						AGGREGATE	\$4,000,000
							\$
D	<b>WORKERS COMPENSATION AND EMPLOYERS' LIABILITY</b> ANY PROPRIETOR/PARTNER/EXECUTIVE OFFICER/MEMBER EXCLUDED? (Mandatory in NH) If yes, describe under DESCRIPTION OF OPERATIONS below	Y/N <input type="checkbox"/> N/A	WC5-33S-352348-018(NJ)	11/17/2018	11/17/2019	<input checked="" type="checkbox"/> WC STATUTORY LIMITS	OTHER
						E.L. EACH ACCIDENT	\$500,000
						E.L. DISEASE - EA EMPLOYEE	\$500,000
						E.L. DISEASE - POLICY LIMIT	\$500,000

DESCRIPTION OF OPERATIONS / LOCATIONS / VEHICLES (Attach ACORD 101, Additional Remarks Schedule, if more space is required)

Additional Insured extension of coverage is provided by above referenced General Liability policy where required by written agreement.  
 Liberty National Golf Course Fireworks  
 Display Date: 11/30/18 Rain Date: TBD  
 Location: Liberty National Golf Course 100 Caven Point Rd. Jersey City, NJ  
 City of Jersey City, its officers and employees as their interests may appear are additionally insured in regards to above listed display.

**CERTIFICATE HOLDER**

**CANCELLATION**

City of Jersey City 280 Grove Street Jersey City NJ 07302	SHOULD ANY OF THE ABOVE DESCRIBED POLICIES BE CANCELLED BEFORE THE EXPIRATION DATE THEREOF, NOTICE WILL BE DELIVERED IN ACCORDANCE WITH THE POLICY PROVISIONS.
	AUTHORIZED REPRESENTATIVE 

© 1988-2010 ACORD CORPORATION. All rights reserved.



FIRE PREVENTION BUREAU  
465 MARIN BLVD.  
JERSEY CITY, NJ 07302  
(201) 547-4260//FAX (201) 547-5733



The undersigned, carrying on the business of pyrotechnics, manufacturing and the displaying of fireworks at PO Box 503 City: Bally

State of: Pennsylvania makes application, as required by Law, to have a Public Display of Fireworks, in accordance with the rules and regulations of the City of Jersey City and National Fire Protection Association (NFPA) 1123, Code for Outdoor Display of Fireworks and the National Fire Protection Association (NFPA) 1124, Code for the Manufacturing, Transportation and the Storage of Fireworks.

Violations of any of the conditions imposed by the City of Jersey City, will result in the immediate cancellation of the permit, and steps will be taken to punish the offenders as provided in the Laws of New Jersey, and the Ordinance of the City of Jersey City, New Jersey. This application must be completed and in the Office of the Fire Official 15 days prior to the fireworks display.

NAME OF SPONSOR: Liberty National GC

ADDRESS: 100 Caven Point Rd.

CONTACT PERSON: Shaun Lewis PHONE# 201-333-4105

SPECIFIC LOCATION OF DISPLAY: Liberty National Golf Course

(A dimensional diagram shall be submitted with this application and shall include a discharge site, spectator viewing area(s), parking area and fallout area)

DATE AND HOURS OF DISPLAY: 11/30/18 Approx: 10:30 PM

DURATION OF DISPLAY: Approx. 10 minutes

NAME OF PERSON(S) IN CHARGE (ON SITE) --LOADING/DISCHARGING FIREWORKS:  
David Albitz

STATE TRANSPORT ROUTE FROM ENTERING JERSEY CITY TO POINT OF STORAGE AND/OR DISPLAY SITE:

Rt. 78 to Bay View Ave to Caven Point Road.

STORAGE SITE OF FIREWORKS PRIOR TO DISPLAY:

No storage required.

LIST SIZE AND QUANTITY OF FIREWORKS ON THIS FORM BELOW:

Size: 2.5" Shells	inches	Quantity: 240
Size: 3" Shells	inches	Quantity: 204
Size: 4" Shells	inches	Quantity: 66
Size: Multi Shot Cakes	inches	Quantity: 13
Size:	inches	Quantity:
Size:	inches	Quantity:
Size:	inches	Quantity:
Size:	inches	Quantity:
Size:	inches	Quantity:

NOTE: THE USE OF 12 INCH AND LARGER FIREWORKS ARE PROHIBITED IN THE CITY OF JERSEY CITY.

THE FOLLOWING IS ALSO REQUIRED WITH THIS APPLICATION:

1. Copy of insurance in a sum of not less than \$1,000,000 conditioned for the payment of all damages incurred.
2. A Hold-Harmless agreement for the City of Jersey City.
3. Check made payable to: "Treasurer, City of Jersey City " for all required fees.
4. Certificate of Fitness, by the employer, for each person who will do the actual discharging of the fireworks.
5. Copies of all permits, letters of permission or acknowledgements for the display from all other agencies having jurisdiction, e.g., FAA, US Coast Guard, Port Authority of NY & NJ, NJ State Park Service etc.

APPLICANT NAME: D&M Fireworks, LLC / David Albitz

ADDRESS: PO Box 503, Bally, PA 19503

APPLICANT'S SIGNATURE: *David Albitz* DATE: 10/24/18  
(Signature acknowledges receipt of Jersey City Fire Department's "Guidelines for Display of Fireworks")

APPROVALS:

FIRE OFFICIAL DATE

CHIEF OF POLICE DATE

\*\*\*\*UPON APPROVAL\*\*\*\*  
FORWARD TO LAW DEPARTMENT FOR CITY COUNCIL RESOLUTION

Page Five  
BULLETIN MEL 15-08

**FIREWORKS DISPLAY**

**HOLD HARMLESS AGREEMENT**

Between the Borough/Township/City/County of City of Jersey City  
and D&M Fireworks, LLC (Contractor).

**WITNESSETH:**

1. D&M Fireworks, LLC \_\_\_\_\_ (Contractor) agrees to release, indemnify and hold harmless the Borough/Township/City/County of City of Jersey City from and against any loss, damage or liability, including attorneys' fees and expenses incurred by the latter entities and their respective employees, agents, volunteers or other representatives arising out of or in any manner relating to the manufacture, installation, firing or disassembly of any pyrotechnic equipment or device and/or the supervision and presentation thereof.

2. The applicant has furnished the Certificate of Insurance with limits of liability described below:

Workers Compensation/Employers Liability: \$500,000

General Liability: \$1,000,000

Automobile Liability: \$1,000,000

Umbrella Liability: \$4,000,000

A true copy of the Certificate of Insurance is attached indicating the member entity and applicable associations, recreations or committees formed by the member entity to organize the "event" must be named as additional insured on all liability policies.

3. The facilities will be used for the following purpose and no other:

Event: Liberty National GC Fireworks Date: 11/30/18 Rain Date: TBD

Dated: 10/24/18 Signed: *Daniel Allard*  
(Contractor)

Witness: *Shirley Markese*



U.S. Department  
of Transportation

Eastern Service Center  
Operations Support Group  
AJV-E2

1701 Columbia Ave.  
College Park, GA 30337

## FIREWORKS DISPLAY NOTIFICATION

Company Name: D&M Fireworks, LLC

Email Address of Person Submitting Request: dave@dmfireworks.com

Cell Phone Number for On-Site Technician: 610-656-1575

Event Name: Liberty National GC

Display Date: 11/30/18 Rain Date: TBD

Display Start Time: Approx. 10:30 PM

Duration of Fireworks Display: Approx. 30 minutes

Max Height of Fireworks: 400'

Address, City and State: 100 Caven Point Rd. Jersey City, NJ

Latitude: 40° 41'47.00" (North) Longitude: 74° 04'10.00" (West)

List the Closest Public Use Airport Within 5 Nautical Miles of the Display if the Fireworks Will Reach or Exceed 500 Ft. \_\_\_\_\_

Special Notes \_\_\_\_\_

**Please email your request to:**

**9-ATO-ESA-OSG-Fireworks@faa.gov**



**Pennsylvania**  
visit Pa.gov - USA

**COMMERCIAL DRIVER'S LICENSE**



DLN: 21 086 479      DUFS: 00  
 DOB: 09/25/1966  
 EXP: 09/26/2022      ISS: 06/28/2018

1 ALBITZ  
 2 DAVID CHARLES  
 3 626 CHESTNUT STREET  
 4 P O BOX 503  
 5 BALLY PA 19003  
 6 SEX: M    EYES: BRO  
 7 HGT: 6-00"  
 8 CLASS: C  
 9 END: H  
 10 RESTR: L

DD: 101928004602  
 80060024375

**CDL**

ORGAN DONOR

*M. Albitz*

Form NC562446 (Rev. 07/10/2017)      (PSSB) 120024 - License Doc. 09/2017

**Medical Examiner's Certificate**  
for Commercial Driver's License

I certify that I have read and understand the provisions of the Pennsylvania Motor Vehicle Code, Title 17, Chapter 33, relating to the Commercial Driver's License, and the provisions of the Pennsylvania Motor Vehicle Code, Title 17, Chapter 33, relating to the Commercial Driver's License, and the provisions of the Pennsylvania Motor Vehicle Code, Title 17, Chapter 33, relating to the Commercial Driver's License, and the provisions of the Pennsylvania Motor Vehicle Code, Title 17, Chapter 33, relating to the Commercial Driver's License.

I am a Medical Examiner as defined in 17 Pa.C.S. § 3302(a)(1) and I am qualified to perform the duties of a Medical Examiner as defined in 17 Pa.C.S. § 3302(a)(1) and I am qualified to perform the duties of a Medical Examiner as defined in 17 Pa.C.S. § 3302(a)(1) and I am qualified to perform the duties of a Medical Examiner as defined in 17 Pa.C.S. § 3302(a)(1).

I am a Medical Examiner as defined in 17 Pa.C.S. § 3302(a)(1) and I am qualified to perform the duties of a Medical Examiner as defined in 17 Pa.C.S. § 3302(a)(1) and I am qualified to perform the duties of a Medical Examiner as defined in 17 Pa.C.S. § 3302(a)(1).

I am a Medical Examiner as defined in 17 Pa.C.S. § 3302(a)(1) and I am qualified to perform the duties of a Medical Examiner as defined in 17 Pa.C.S. § 3302(a)(1) and I am qualified to perform the duties of a Medical Examiner as defined in 17 Pa.C.S. § 3302(a)(1).

I am a Medical Examiner as defined in 17 Pa.C.S. § 3302(a)(1) and I am qualified to perform the duties of a Medical Examiner as defined in 17 Pa.C.S. § 3302(a)(1) and I am qualified to perform the duties of a Medical Examiner as defined in 17 Pa.C.S. § 3302(a)(1).

I am a Medical Examiner as defined in 17 Pa.C.S. § 3302(a)(1) and I am qualified to perform the duties of a Medical Examiner as defined in 17 Pa.C.S. § 3302(a)(1) and I am qualified to perform the duties of a Medical Examiner as defined in 17 Pa.C.S. § 3302(a)(1).

I am a Medical Examiner as defined in 17 Pa.C.S. § 3302(a)(1) and I am qualified to perform the duties of a Medical Examiner as defined in 17 Pa.C.S. § 3302(a)(1) and I am qualified to perform the duties of a Medical Examiner as defined in 17 Pa.C.S. § 3302(a)(1).

Medical Examiner's Certificate Expiration Date: 3/16/18

Medical Examiner's Signature: *Melvin Millican*      Medical Examiner's Telephone Number: 610-477-9614      Date Certificate Signed: 3/16/18

Medical Examiner's Name (Print or Type): MELVIN MILICAN PA-C       MD     Physician Assistant     Advanced Practice Nurse  
 DO     Chiropractor     Other Practitioner (Type):

Medical Examiner's State License, Certificate, or Registration Number: MA058105      Issuing State: PA      National Registry Number: 90780916663

Driver's Signature: *David Albitz*      Driver's License Number: 21086479      Issuing State/Province: PA

Driver's Address: 626 CHESTNUT ST BALLY PA 17503      Street Address: BALLY      State/Zip: PA 17503      City/State/Zip: PA 17503       CDL Applicant/Holder

ES-P-167 (R-7-03)



NEW JERSEY DEPARTMENT OF LABOR  
OFFICE OF SAFETY COMPLIANCE  
PO BOX 386, TRENTON, NJ 08625-0386

AUDIT NO.  
8481

PERMIT TO USE EXPLOSIVES

Grade: P  
Fee: \$200

Expiration Date: 3/31/2019  
Permit Number: 003244

David Albitz  
626 Chestnut St  
Bally, PA 19503

Carver Park Rd

280' Radius Fallout Area

Fireworks Setup Area

Liberty National GC

Liberty National Golf Course

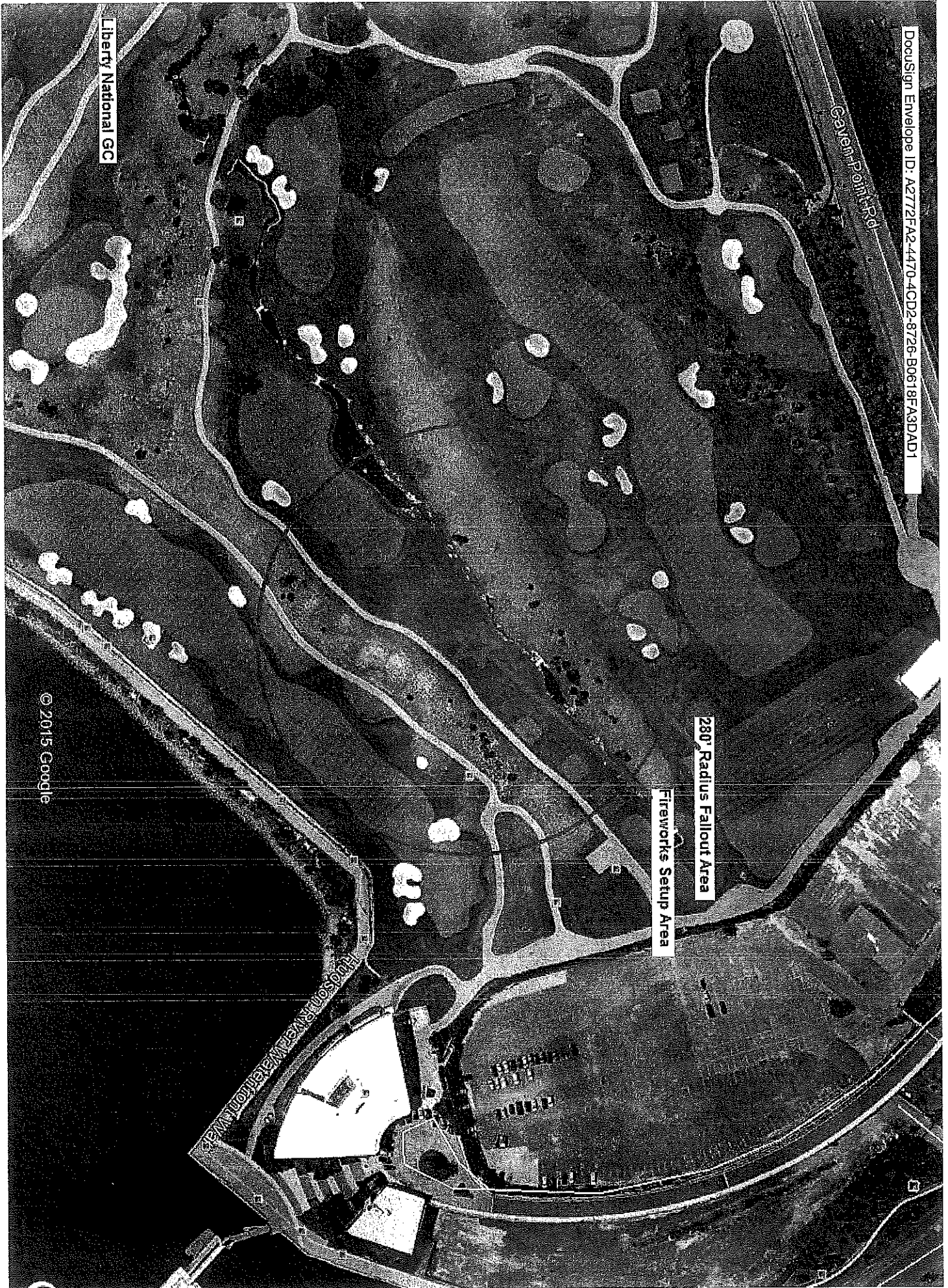

# Resolution of the City of Jersey City, N.J.

City Clerk File No. Res. 18-971

Agenda No. 10.1

Approved: NOV 07 2018

TITLE:



**RESOLUTION AUTHORIZING THE ACCEPTANCE OF THE CY 19 COOPERATIVE MARKETING GRANT FROM THE NEW JERSEY DEPARTMENT OF STATE, DIVISION OF TRAVEL & TOURISM**

**COUNCIL, AS A WHOLE OFFERED AND MOVED APPLICATION OF AND ACCEPTANCE OF THE FOLLOWING RESOLUTION:**

**WHEREAS**, the City of Jersey City ("City") has been awarded a grant in the amount of \$10,500.00 New Jersey Department of State, Division of Travel & Tourism ("State"); and

**WHEREAS**, the City would like to accept these funds from the State to assist in furthering Jersey City as a travel destination; and

**WHEREAS**, the grant will be utilized to enhance and continue the marketing efforts for the 29<sup>th</sup> Annual Jersey City Art and Studio Tour; which will take place in October 2019; and

**WHEREAS**, the grant requirements include that there is a matching fund equal to 25% of the State grant; and

**WHEREAS**, GFP Real Estate, 150 Bay Street, Jersey City, NJ 07302, will provide the City with matching funds in the amount of \$2,625.00;

**NOW, THEREFORE, BE IT RESOLVED**, by the Municipal Council of the City of Jersey City:

1. The Mayor or Business Administrator is hereby authorized to execute an electronic contract in SAGE with the New Jersey Department of State; and
2. The Office of Management and Budget is authorized to establish a grant account in the amount of \$10,500.00 for the CY19 Cooperative Marketing Grant

*JMcK  
10/29/18*

APPROVED: \_\_\_\_\_

APPROVED: \_\_\_\_\_  
Business Administrator

APPROVED AS TO LEGAL FORM

\_\_\_\_\_  
Corporation Counsel

Certification Required

Not Required

**APPROVED 8-0**

RECORD OF COUNCIL VOTE ON FINAL PASSAGE 11.7.18											
COUNCILPERSON	AYE	NAY	N.V.	COUNCILPERSON	AYE	NAY	N.V.	COUNCILPERSON	AYE	NAY	N.V.
RIDLEY	✓			YUN	✓			RIVERA	✓		
PRINZ-AREY	✓			SOLOMON	✓			WATTERMAN	ABSENT		
BOGGIANO	✓			ROBINSON	✓			LAVARRO, PRES.	✓		

✓ Indicates Vote

N.V.-Not Voting (Abstain)

Adopted at a meeting of the Municipal Council of the City of Jersey City N.J.

\_\_\_\_\_  
Rolanfo R. Lavarro, Jr., President of Council

\_\_\_\_\_  
Robert Byrne, City Clerk

**RESOLUTION FACT SHEET – NON-CONTRACTUAL**

This summary sheet is to be attached to the front of any resolution that is submitted for Council consideration. Incomplete or vague fact sheets will be returned with the resolution.

**Full Title of Ordinance/Resolution**

RESOLUTION AUTHORIZING THE ACCEPTANCE OF THE CY19 COOPERATIVE MARKETING GRANT FROM THE NEW JERSEY DEPARTMENT OF STATE, DIVISION OF TRAVEL AND TOURISM

**Initiator**

Department/Division	Mayor's Office	Jersey City Office of Cultural Affairs
Name/Title	Christine Goodman	Director
Phone/email	(201) 549-4303	cgodman@jcnj.org

Note: Initiator must be available by phone during agenda meeting (Wednesday prior to council meeting @ 4:00 p.m.)

**Resolution Purpose**

RESOLUTION AUTHORIZING THE ACCEPTANCE IF THE CY19 COOPERATIVE MARKETING GRANT FROM THE NEW JERSEY DEPARMENT OF STATE, DIVISION OF TRAVEL & TOURISM.

The CY19 Cooperative Marketing Grant will be utilized to enhance and continue the marketing efforts for the 29<sup>th</sup> Annual Jersey City Art and Studio Tour and Art commencing on January 1, 2019 and ending October 31, 2019.

The grant will provide the opportunity to further the City's reach in marketing to attract visitors and to increase economic development and tourism throughout Jersey City.

I certify that all the facts presented herein are accurate.

  
\_\_\_\_\_  
Signature of Department Director

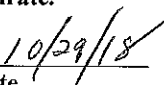
  
\_\_\_\_\_  
Date

**STATE OF NEW JERSEY  
DEPARTMENT OF STATE  
GRANT AGREEMENT**

**I. Grant Agreement Data**

1. Date Issued: 10/11/2018

3.a. Grant Award Number: TRAV-2019-CMP-00047

2. Supersedes Notice Dated:

3.b. DUNS Number: 831438275

4. Title of Grant Award: Cooperative Marketing Program 2019

5.a. Department, Division, Name/Address: NJ Division of Travel and Tourism PO Box 460 Trenton, NJ 08625-0460

5.b. Financial Officer Name and Title: - Grant Officer

5.c. Phone No. (609) 633-7985

6. Grant Period (Month/Day/Year)

From: 9/30/2018 To: 12/31/2019

5.d. Grantee:

7. Vendor ID Number:

Name: Jersey City

226002013-00

Street: 280 Grove Street

City: Jersey City State: NewJersey Zip: 07302-3610

**8. Source of Funds:**

<u>Fiscal year</u>	<u>Account Number</u>	<u>C.F.D.A.</u>	<u>Amount</u>
2019	19-100-074-2510-013-6130--		\$10,500
2019	-----		
2019	-----		
2019	-----		
2019	-----		

**9. Award Computation for Grant:**

a. Amount of Financial Assistance:	\$10,500
b. Less Unobligated Balance from Prior Budget Periods:	
c. Less Cumulative Prior Award(s) this Budget Period:	
d. AMOUNT of this ACTION:	\$10,500

10.a. Nature and Purpose of Program Funded: Cooperative Marketing Program 2019

10.b. This Grant is subject to the terms and conditions incorporated either directly or references in the following:

- Attachment A - Audits; Insurance; Reporting
- Attachment B - Approved Budget
- Attachment C - Final Comparison of Actual to Budget Expend/Reporting Requirements
- Attachment D - Program Specifications

The Grantee's Terms and Conditions for administration of Grants is referenced in this Grant. Acceptance of this grant terms and conditions is acknowledged by the grantee by:

- (1) Returning a copy of this Grant Agreement with Section I (12) properly completed; or
- (2) Accepting funds from the State Grantor Agency. This method of acceptance is valid if a grant application signed by an officer of the grantee is on file at the State Grantor Agency.

11. Remarks (Other terms and conditions):  Yes  No

**12. DEPARTMENT AND GRANTEE SIGNATURES**

If this grant, including all attachment annexed hereto, correctly sets for your understanding of the terms of the Agreement, please indicate your organization's concurrence with such terms by having the enclosed copy of this grant signed by an appropriate officer of your organization and returned to the Department

**ACCEPTED AND AGREE:**

**COUNTERSIGNED:**

<u>Jersey City</u>	Date	<u>NJ Dept. of State/Travel and Tourism</u>	Date
		Grantor Division	
By:		By:	
Title:		Title:	

DEPARTMENT OF STATE:

I attest that sufficient funds have been appropriated by the State Legislature to cover the current state fiscal year portion of the grant.

Department of State Grant Approval Officer

**NEW JERSEY DEPARTMENT OF STATE**  
**DIVISION OF TRAVEL AND TOURISM – COOPERATIVE MARKETING PROGRAM**

**TABLE OF CONTENTS:**

**GENERAL TERMS AND CONDITIONS**

- I. Grant Agreement Data
- II. Compliance with Existing Laws
- III. Bonding and Insurance
- IV. Indemnification
- V. Assignability
- VI. Availability of Funds

**PRE-AWARD REQUIREMENTS**

- VII. Special Grant Conditions for "High Risk" Grantees

**POST-AWARD REQUIREMENTS**

- VIII. Financial Management System
- IX. Method of Payment
- X. Allowable Costs
- XI. Period of Availability of Funds
- XII. Matching and Cost Sharing
- XIII. Program Income
- XIV. Audit Requirements
- XV. Budget Revision and Modification
- XVI. Property Management Standards
- XVII. Procurement Standards
- XVIII. Monitoring of Program Performance
- XIX. Financial and Performance Reporting
- XX. Access to Records
- XXI. Record Retention
- XXII. Enforcement
- XXIII. Termination and Suspension
- XXIV. Publicity
- XXV. Close out Procedures

**AFTER-THE-GRANT REQUIREMENTS**

- XXV. Grant Closeout Procedures

**ATTACHMENTS**

- A. Additional Grant Provisions
- B. Approved Budget
- C. Reporting Requirements
- D. Program Specifications

**OTHER TERMS & CONDITIONS**

- A. Cooperative Marketing Program Requirements

## II. Compliance with Existing Laws

- A. The Grantee, in order to permit the Department to award this grant, agrees to comply with all Federal, State and municipal laws, rules, and regulations generally applicable to the activities in which the Grantee is engaged in the performance of this grant.
- B. These laws and regulations include, but are not limited to the following:
1. Federal Office of Management and Budget (OMB) documents:  
<http://www.whitehouse.gov/omb/circulars/>
  2. New Jersey Department of the Treasury, Office of Management and Budget documents:
    - a) Circular Letter 15-08-OMB, Single Audit Policy for Recipients of Federal Grants, State Grants and State Aid:  
<http://www.state.nj.us/infobank/circular/circindx.htm> and click on "Circular Letters" and locate Circular 04-04.
  3. State Affirmative Action Legal Citations:  
The Grantee agrees to require its contractors to comply with the requirements of N.J.A.C. 17:27, applicable provisions of N.J.S.A 10:5, et. al., and P.L. 1975, c.127 and all implementing regulations.

**Failure to comply with the laws, rules and regulations shall be grounds for termination of this grant.**

## III. Bonding and Insurance Proof of Insurance must be submitted.

Bonding and insurance of the type described in Attachment A, Part VII, shall be provided by the Grantee and proof of bonding and insurance must be retained on file by the Grantee.

## IV. Indemnification

The Grantee shall be solely responsible for and shall keep, save, and hold the State of New Jersey harmless from all claims, loss, liability, expense, or damage resulting from all mental or physical injuries or disabilities, including death, to its employees or recipients of the Grantee's services or to any other persons, or from any damage to any property sustained in connection with the delivery of the Grantee's services that results from any acts or omissions, including negligence or malpractice, of any of its officers, directors, employees, agents, servants or independent contractors, or from the Grantee's failure to provide for the safety and protection of its employees, whether or not due to negligence, fault, or default of the Grantee. The Grantee's responsibility shall also include all legal fees and costs that may arise from these actions. The Grantee's liability under this agreement shall continue after the termination of this agreement with respect to any liability, loss, expense or damage resulting from acts occurring prior to termination.

## V. Assignability

The Grantee shall not subcontract any of the work or services covered by this grant, nor shall any interest be assigned or transferred except as may be provided for in this grant or with the express written approval of the Department.



## **VI. Availability of Funds**

The Recipient shall recognize and agree that both the initial provision of funding and the continuation of such funding under the Agreement is expressly dependent upon the availability to the Department of funds appropriated by the State Legislature from State and/or Federal revenue or such other funding sources as may be applicable. A failure of the Department to make any payment under this Agreement or to observe and perform any condition on its part to be performed under the Agreement as a result of the failure of the Legislature to appropriate shall not in any manner constitute a breach of the Agreement by the Department or an event of default under the Agreement and the Department shall not be held liable for any breach of the Agreement because of the absence of available funding appropriations. In addition, future funding shall not be anticipated from the Department beyond the duration of the award period set forth in the Grant/Loan Agreement and in no event shall the Agreement be construed as a commitment by the Department to expend funds beyond the termination date set in the Grant/Loan Agreement.

## **VII. Special Grant Conditions For "High Risk" Grantees**

A. A Grantee may be considered "high risk" if the Department determines that a Grantee:

1. Has a history of unsatisfactory performance.
2. Is not financially stable.
3. Has a financial management system which does not meet the standards set forth in Section VIII.
4. Has not conformed to terms and conditions of previous awards.
5. Is otherwise not responsible; and the Department determines that an award will be made; special conditions and/or restrictions shall correspond to the high risk condition and shall be included in the award.

B. Special conditions or restrictions may include:

1. Payment on a reimbursement basis.
2. Withholding authority to proceed to the next phase until receipt or evidence of acceptable performance within a given funding period.
3. Requiring additional, more detailed financial reports.
4. Additional project monitoring.
5. Requiring the Grantee to obtain technical or management assistance.
6. Establishing additional prior approvals.

C. If a Department decides to impose such conditions, the Department official will notify the Grantee as soon as possible, in writing, of:

1. The nature of the special conditions/restrictions.
2. The reason(s) for imposing the special conditions.
3. The corrective actions that must be taken before the special conditions will be removed by the Department and the time allowed for completing the corrective actions.
4. The method of requesting reconsideration of the conditions/restrictions imposed.

## **VIII. Financial Management System**

A. The Grantee shall be responsible for maintaining an adequate financial management system and will immediately notify the Department when the Grantee cannot comply with the requirements established in this Section of the grant.

B. The Grantee's financial management system shall provide for:

1. Financial Reporting:  
Accurate, current, and complete disclosure of the financial results of each grant in conformity with generally accepted principles of accounting, and reporting in a format that is in accordance with the financial reporting requirements of the grant.
2. Accounting Records:

Records that adequately identify the source and application of funds for Department supported activities. These records must contain information pertaining to grant awards and authorizations, obligations, unobligated balances, assets, liabilities, outlays or expenditures and income.

3. Internal Control:  
Effective internal and accounting controls over all funds, property and other assets. The Grantee shall adequately safeguard all such assets and assure that they are used solely for authorized purposes.
4. Budget Control:  
Comparison of actual expenditures or outlays with budgeted amounts for each grant. Also, the relationship of the financial information with performance or productivity data, including the development of unit cost information required by the Department.
5. Allowable Cost:  
Procedures for determining reasonableness, allowability, and allocability of costs generally consistent with the provisions of Federal and State requirements.
6. Source Documentation:  
Accounting records that are supported by source documentation.
7. Cash Management:  
Procedures to minimize the time elapsing between the advance of funds from the Department and the disbursement by the Grantee, whenever funds are advanced by the Department.

C. The Department may require the submission of a "Statement of Adequacy of the Accounting System," as provided in Attachment A, Section II of this grant agreement.

D. A Department may review the adequacy of the financial management system of any applicant for financial assistance as part of a pre-award review or at any time subsequent to the award. If the Department determines that the Grantee's accounting system does not meet the standards described in paragraph B above, additional information to monitor the grant may be required by the Department upon written notice to the Grantee, until such time as the system meets with Department approval.

## **IX. Method of Payment**

A payment will be made to the Grantee in a manner determined by the Department (see Attachment A, Section V), upon receipt by the Department of a properly executed copy of this grant.

## **X. Allowable Costs**

- A. Limitation on Use of Funds  
Grant funds must be used only for allowable costs.
- B. Applicable Cost Principles  
For each type of organization, there is a set of Federal principals for determining allowable costs. Allowable costs will be determined in accordance with applicable Federal cost principles specific to the organization incurring the costs (Federal OMB Circular 200 CFR, Part 200) and State requirements.

## **XI. Period of Availability of Funds**

Grantees may charge to the award only costs resulting from obligations of the funding period unless carryover of unobligated balances is permitted, in which case the carryover balances may be charged for costs resulting from obligations of the subsequent funding period.

## **XII. Matching and Cost Sharing**

The Grantee shall be required to account to the satisfaction of the Department for matching and cost sharing requirements of this program in accordance with Federal and State requirements. The Grantee shall comply

with the Matching fund requirements set forth in "Other Terms and Conditions, Cooperative Marketing Program Specifications".

### **XIII. Program Income**

Program income shall be defined as gross income earned by the Grantee from grant-supported activities. Such earnings include, but will not be limited to, income from service fees, sale of commodities, usage or rental fees, and royalties on patents and copyrights.

- A. If a Grantee receives interest earned of \$250 or more in a fiscal year on advances of grant funds, see Attachment A, Section VIII (B).
- B. Unless the grant provides otherwise, the Grantee shall have no obligation to the Department with respect to royalties received as a result of copyrights or patents produced under the grant.
- C. All other program income earned during the grant period shall be retained by the Grantee and used in accordance with Attachment A, Section IV of this grant.

### **XIV. Audit Requirements**

This grant is covered by the audit requirements of the Department of the Treasury Circular Letter 15-08-OMB, Single Audit Policy for Recipients of Federal Grants, State Grants and State Aid.

### **XV. Budget Revision and Modification**

This Section sets forth criteria and procedures to be followed by the Grantee in reporting deviations from the approved budget and in requesting approvals for budget revisions and modification. Revisions and modifications to this grant must be requested by the Grantee and approved by the Department in writing.

- A. Grantee shall request approval in writing, from the Department Grant Approval Officer designated in Attachment A, Section III when there is reason to believe a revision or modification will be necessary for the following reasons:
  1. Changes in the scope, objective, financial assistance, key personnel, timing of the project or program, or deviations from the approved budget.
  2. To provide financial assistance to a third party by sub-granting (if authorized by law) or by another means to obtain the services of a third party to perform activities which are central to the purpose of the award.
  3. The need for additional funding or to extend the period of availability of funds.
  4. Adjustments between cost categories and/or shifts of funding to direct cost categories that are not part of the approved budget.
  5. Revisions which involve the transfer of amounts budgeted for indirect costs to absorb increases in direct costs.

For the purpose of this grant, indirect costs are defined as those incurred for a common or joint purpose benefiting more than one cost objective and not readily assignable to the cost objectives specifically benefited without effort disproportionate to the results achieved.

Direct costs are defined as those which can be identified specifically with a particular cost objective. These costs may be charged directly to grants, contracts, or to other programs against which costs are finally lodged.

- B. The Department may also, at its option, establish policy to restrict transfers of funds among direct cost categories and must require Grantees to comply with applicable Federal and State requirements concerning prior approval for certain budget changes.
- C. When requesting approval for budget revisions, the Grantee shall clearly show the change in cost categories and may use the budget form provided in Attachment B of this grant.

- D. The Department may request changes in the scope of services of the Grantee to be performed hereunder. Such changes, which are mutually agreed upon by and between the Department and the Grantee must be incorporated in written amendments to this grant.
- E. If the Grantee is making program expenditures or providing grant services at a rate which, in the judgment of the Department, will result in substantial failure to expend the grant amount or provide grant services, the Department may so notify the Grantee. If, after consultation, the Grantee is unable to develop to the satisfaction of the Department a plan to rectify its low level of program expenditures or grant services, the Department may upon thirty (30) days notice to the Grantee, reduce the grant amount by a sum so that the revised grant amount fairly projects program expenditures over the grant period. This reduction shall take into account the Grantee's fixed costs and shall establish the committed level of services for each program element of grant services at the reduced grant amount. If such a determination is made by the Department subsequent to the awarding of the grant and the funds have already been received by the Grantee, the reduced amount will be remitted to the Department.
- F. If the revision requested will result in a change to the Grantee's approved project which requires Federal prior approval, the Department will obtain the Federal agency's approval before approving the Grantee's request.

#### **XVI. Property Management Standards**

Property furnished by the Department or acquired in whole or in part with Federal or Department funds or whose cost was charged to a project supported by Federal or Department funds shall be utilized and disposed of in a manner generally consistent with State and Federal requirements.

Prior approval must be received from the Commission for the use of property in other programs when it is determined that such property is no longer needed for the purposes of the original program as set forth in "Other Terms and Conditions" of this Agreement. Use in other programs shall be limited to those programs funded by the Commission that have purposes consistent with those in this Agreement. Real property obtained with funds provided in this Agreement shall not be disposed of or its title or interests encumbered by the Grantee without prior written approval from the Commission.

#### **XVII. Procurement Standards**

Procurement of supplies, equipment, and other services with funds provided by this grant shall be accomplished in a manner generally consistent with Federal and State requirements.

Adherence to the standards contained in the applicable Federal and State laws and regulations does not relieve the Grantee of the contractual responsibilities arising under its procurements. The Grantee is the responsible authority, without recourse to the Department, regarding the settlement and satisfaction of all contractual and administrative issues arising out of procurement entered in support of a grant.

#### **XVIII. Monitoring of Program Performance**

- A. The Grantee must assure compliance with applicable Federal requirements and that performance goals are being achieved. Grantee monitoring must cover each program, function or activity to monitor performance under grant supported activities to assure time schedules and objectives are being met, projected work units by time periods are being accomplished, and other performance goals are being achieved as applicable.
- B. The Grantee shall inform the Department of the following types of conditions which affect program objectives and performance as soon as they become known:
  - 1. Problems, delays, or adverse conditions which will materially impair the ability to attain program objectives, prevent meeting time schedules and goals, or preclude the attainment of project work

units by established time periods. This disclosure shall be accompanied by a statement of the action taken, or contemplated, and any Department assistance required to resolve the situation.

2. Favorable developments or events which enable meeting time schedules and goals sooner than anticipated, at a lower than anticipated cost, or produces a greater benefit than originally planned.

C. The Department may, at its discretion, make site visits to:

1. Review program accomplishments and management control systems.
2. Provide such technical assistance as may be required.
3. Perform fiscal reviews to ensure grant funds are being properly expended in a timely manner.

#### **XIX. Financial and Performance Reporting**

- A. The grant budget as used in this Section means the approved financial plan to carry out the purpose of the grant. This plan is the financial representation of the project or program as approved during the grant application and award process. The Approved Budget is contained in Attachment B.
- B. The Grantee shall submit a final report as prescribed in Attachment A, Section V of this Agreement. The final report shall present a comparison of actual expenditures with budgeted expenditures and a written narrative performance report, signed by an appropriate officer of the Grantee, of what was accomplished by the expenditure of funds towards achieving the purpose(s) of this Agreement..
- C. If requested, the Grantee shall submit interim expenditure reports comparing actual expenditures with the approved budget as prescribed in Attachment A.
- D. The Grantee If requested, the Grantee shall submit interim performance reports as prescribed by the Commission. These reports shall be submitted on a periodic basis, as prescribed in Attachment A, Section V of this Agreement; however, reports shall not be required more frequently than quarterly or less frequently than annually. Performance reports shall present the following information for each program function or activity involved:
  1. A comparison of actual accomplishments for the period to the goals established in the program specifications in Attachment C of this Agreement. Where the output of the program can be readily quantified, such quantitative data should be related to cost data for computation of unit costs.
  2. Reasons that established goals were not met.
  3. Additional pertinent information including, when appropriate, analysis and explanation of cost overruns or high unit costs
- E. The Grantee shall submit annual reports.
- F. Extensions to reporting due dates may be granted upon written request to the Department.
- G. If reports are not submitted as required, the Department may, at its discretion, suspend payments on this grant. The State of New Jersey may, at its discretion, take such action to withhold payments to the Grantee on this or any grant with other State agencies until the required reports have been submitted.

#### **XX. Access to Records**

- A. The Grantee in accepting this grant agrees to make available to the Department, any Federal agency whose funds are expended in the course of this grant, or any of their duly authorized representatives, pertinent accounting records, books, documents and papers as may be necessary to monitor and audit Grantee's operations.
- B. All visitations, inspections and audits, including visits and requests for documentation in discharge of the Department's responsibilities, shall as a general rule provide for prior notice when reasonable and practical to do so. However, the Department retains the right to make unannounced visitations, inspections, and audits as deemed necessary.
- C. The Department reserves the right to have access to records of any Subgrantees and requires the Grantee to provide for Department access to such records in any grant with the Subgrantee.

- D. The Department reserves the right to have access to all work papers produced in connection with audits made by the Grantee or independent certified public accountants, registered municipal accountants or licensed public accountants hired by the Grantee to perform such audits.

## **XXI. Record Retention**

- A. Except as otherwise provided, financial and programmatic records, supporting documents, statistical records and all other records pertinent to the grant shall be retained for a period of seven years, unless Federal or State funding Department statutes require longer periods or unless directed to extend the retention by the Department.
1. If any litigation, claim, negotiation, action or audit involving the records is started before the expiration of the seven year period, the records must be retained until completion of the action and resolution of all issues which arise from it, or until the end of the regular seven year period, whichever is later unless otherwise directed by the Department.
  2. Records for nonexpendable property acquired with Department funds shall be retained for seven years after its final disposition, unless otherwise provided or directed by the Department.
- B. For Federal and State purposes (unless otherwise provided):
1. General - The retention period starts from the date of submission of the final expenditure report, or for grants that are renewed annually, from the date of submission of the annual financial report.
  2. Real Property and Equipment - The retention period for real property and equipment records starts from the date of the disposition, replacement or transfer at the direction of the awarding Department.
- C. The Department may request transfer of certain records to its custody from the Grantee when it determines that the records possess long-term retention value and will make arrangements with the Grantee to retain any records that are continuously needed for joint use.

## **XXII. Enforcement**

### **A. Remedies for Noncompliance**

If a Grantee materially fails to comply with the term of an award, whether stated in a State or Federal statute or regulation, an assurance, in a State plan or application, a notice of award, or elsewhere, the Department may take one or more of the following actions, as appropriate in the circumstances:

1. Temporarily withhold cash payments pending correction of the deficiency by the Grantee or take more severe enforcement action.
2. Disallow all or part of the cost of the activity or action not in compliance.
3. Wholly or partly suspend or terminate the current award for the Grantee's program.
4. Withhold further awards for the program,
5. Request the balance of grant funds to be returned and/or seek reimbursement for funds expended that were not in compliance with the terms and conditions of the grant agreement.
6. Take other remedies that may be legally available.

### **B. Hearings, Appeals**

In taking an enforcement action, the Department may provide the Grantee an opportunity for such hearing, appeal or other administrative proceeding to which the Grantee is entitled under any statute or regulation applicable to the action involved.

### **C. Effects of Suspension and Termination**

Costs incurred by the Grantee, resulting from obligations incurred by the Grantee during a suspension or after termination of an award, are not allowable to be applied against the grant unless the Department expressly authorizes them in the notice of suspension or termination or subsequently. Other Grantee costs during suspension or after termination which are necessary and not reasonably avoidable are

allowable if the costs result from obligations which were properly incurred by the Grantee before the effective date of suspension or termination, and are noncancellable.

**D. Relationship to Debarment and Suspension**

The enforcement remedies identified in this Section, including suspension and termination, do not preclude the Grantee from being subject to State and Federal debarment and suspension procedures.

**XXIII. Termination and Suspension**

**A. The following definitions shall apply for the purposes of this Section:**

**1. Termination**

The termination of a grant means the cancellation of assistance, in whole or in part, under a grant at any time prior to the date of completion.

**2. Suspension**

The suspension of a grant is an action by the Department which temporarily suspends assistance under the grant pending corrective action by the Grantee or pending a decision to terminate the grant by the Department.

**3. Disallowed Costs**

Disallowed costs are those charges to the grant which the Department or its representatives shall determine to be beyond the scope of the purpose of the grant, excessive, or otherwise unallowable.

**B.** When the Grantee has failed to comply with grant award stipulations, standards, or conditions, the Department may suspend the grant and withhold further payments; prohibit the Grantee from incurring additional obligations of grant funds pending corrective action by the Grantee; or decide to terminate the grant in accordance with paragraph C below. The Department shall allow all necessary and proper costs, which the Grantee could not reasonably avoid during the period of suspension, provided they meet Federal and State requirements.

**C.** The Department may terminate the grant in whole or in part whenever it is determined that the Grantee has failed to comply with the conditions of the grant. The Department shall promptly notify the Grantee in writing of the determination and the reasons for the termination together with the effective date. Payments made to the Grantee or recoveries by the Department under the grant terminated for cause shall be in accord with the legal right and liability of the parties.

**D.** The Department and the Grantee may terminate the grant in whole, or in part, when both parties agree that the continuation of the project would not produce beneficial results commensurate with the further expenditure of funds. The two parties shall agree upon the termination conditions, including the effective date and in case of partial terminations, the portion to be terminated. The Grantee shall not incur new obligations for the terminated portion after the effective date and shall cancel as many outstanding obligations as possible.

**E.** The Grant Closeout procedures in Section XXV of the grant shall apply in all cases of termination of the grant.

**XXIV. Publicity (see also Other Terms & Conditions)**

**A.** Credit must be given to the New Jersey Department of State (NJDOS) in all printed materials, releases and announcements of the grantee regarding all activities to which NJDOS funds contribute. This applies to all promotional appearances on television and radio by representatives of the grantee organization as well. In the case of electronic media, verbal credit must be given at least once during a broadcast to acknowledge the support the grantee has received from NJDOS to its overall operation.

**B.** Credit must be given to NJDOS in all print advertising and broadcast advertising placed by a grantee. Billboard advertising must also include NJDOS credit. Any advertising, regardless of size or length, placed by a grantee that credits a specific funding source must also acknowledge NJDOS.

- C. Those organizations receiving funds from NJDOS through their officially designated county agency (e.g. a re-grant program) are required to comply with the terms, conditions, and language set forth by their county agency. The organization should not imply that it received funds directly from the Division of Travel & Tourism, but rather from a grant administered by its officially designated county agency.
- D. Credit. When crediting the NJ Department of State, the following language should be read as follows:  
**“ The (name of organization) received funding through a grant from the New Jersey Department of State, Division of Travel & Tourism.”**

## **XXV. Grant Closeout Procedures**

- A. The following definitions shall apply for the purpose of this Section:
  - 1. Grant Closeout  
The closeout of a grant is the process by which the Department determines that all applicable administrative actions and all required work of the grant have been completed by the Grantee.
  - 2. Date of Completion  
The date when all activities under the grant are completed or the expiration date in the award document, or any supplement or amendment thereto.
- B. The Grantee shall submit final expenditure and performance reports as prescribed by the Department and in the timeframes set forth in Attachment A, Part VI upon completion of the grant period or termination of the grant. The Department may permit extensions when requested in writing by the Grantee.
- C. The Grantee will, together with the submission of the final report, refund to the Department any unexpended funds or unobligated (unencumbered) cash advanced, except such sums that have been otherwise authorized in writing by the Department to be retained.
- D. In the event a final audit has not been performed prior to the closeout of the grant, the Department retains the right to recover any appropriate amount after fully considering the recommendations on disallowed costs resulting from the final audit.
- E. The Grantee shall account for any property acquired with Department funds or received from the department in accordance with the provisions of Section XIV of this Agreement.



ADDITIONAL GRANT PROVISIONS

Attachment A is hereby annexed to and provides for additional grant provisions and conditions between NJ  
Department of State/Division of Travel & Tourism and Jersey City as detailed below.

**I. Audit Requirement NOTE: Audit reports are due 90 days following Grantee fiscal year end.**

- A. Any audit required under Section XIV of this grant will be conducted in the Grantee's fiscal year. It is the Department's understanding that the Grantee's fiscal year ends on 12/31
- B. Any changes in the fiscal year must be reported immediately to the Department.
- C. Copies of audit reports must be submitted to each State funding Department.
- D. Grantees must assure the Department that auditors satisfactorily comply with the General Accounting Office's Government Auditing Standards (Yellow Book) for internal and external quality control review program requirements.
- E. All grants must include the audit requirements as delineated in the Department of the Treasury Circular Letter 15-08, Single Audit Policy for Recipients of Federal Grants, State Grants and State Aid.
- F. The following method has been designated in performing audits:
  - State Auditors.
  - Departmental internal auditors.
  - CPA firm appointed by the Department
  - CPA firm appointed by the Grantee.
  - Other
- G. Grants which are basically procurement in nature and less than \$ 10,000 shall not be subject to the audit requirements contained in Section XIV of this grant.

**II. Certification of Adequacy of Accounting System**

A statement attesting to the adequacy of the Grantee's accounting system in accordance with the standards set forth in Section VIII, Financial Management System of this grant.

- Must be completed by the Chief Financial Officer
- Is not required.

**III. Budget Revision and Modification**

All budget revisions and modifications beyond the designated limits must be approved in writing by

Anthony Minick- Marketing Director - Division of Travel and Tourism hereby designated by the Department as Grant Management Officer.

The following procedures will be required for budget revisions and modifications:

- A. For all grants refer to Section XV.
- B. The budget variance request must be submitted in writing by the Grantee and must include an explanation of the reasons for the variance request.

Since the Grantee is not to incur expenditures over and above the limits set for budget variances, it is incumbent on the Grantee to request budget variance approval whenever it is anticipated that spending will exceed the limits.

**IV. Program Income**

Other program income, if any, as defined in Section XIII, shall be treated by the Grantee in the following manner:

- Added to funds committed to the project by the Department and be used to further eligible program objectives; or
- Deducted from the total project costs for the purpose of determining the net costs on which the Department grant payments shall be based.
- Cost sharing or matching method (Using program income to meet cost-sharing or matching requirements).
- Not applicable.

**V. Method of Payment**

- A. The Grant will be paid on a reimbursement basis.
- B. Where deemed applicable, the Department may authorize advance payments to the Grantee. These payments are not to exceed 50 % of the grant amount upon acceptance of the executed Grant Agreement.
- C. An additional payment of 25% will be made upon receipt and approval of the Interim fiscal and programmatic reports.
- D. A final payment 25% will be made upon receipt and approval of the FINAL fiscal and programmatic reports and compliance with mandatory trainings and technical assistance sessions.

**VI. Financial and Performance Reporting**

- A. Mid-Term Programmatic and Fiscal reports shall be submitted by March 30, 2019. See Attachments C.
- B. Final reports should be submitted by the Grantee no later than February 15, 2020. See Attachments C.
- C. The Grantee's financial reports shall be prepared, in a manner consistent with the Grantee's normal accounting records, which is:

- Cash Basis
- Accrual Basis
- Other

## ATTACHMENT A

### VII. **Bonding and Insurance** Attach copy of Insurance with Contract

**Type of Insurance Required:** The Grantee hereby agrees to include the Department of State/Division of Travel and Tourism as an additional insured on the existing general liability policy No. \_\_\_\_\_; Coverage of \$0 \_\_\_\_\_ bodily injury per occurrence and \$0 \_\_\_\_\_ property damage per occurrence are included. The Grantee shall maintain this policy during the life of this grant with the Department. (Please certify in writing if the Grantee is a self-insured, public entity). The grantee must furnish a certificate of insurance evidencing such coverage.

### VIII. **Interest**

#### A. Charges for Unresolved Audit Findings

An interest charge on unallowable costs that are not repaid by the Grantee shall begin to accrue 30 days from the date the Grantee is notified of the debt. The interest shall continue to accrue while any appeal of the audit findings is underway. In the event the Grantee is successful in its appeal, the accrued interest will be eliminated.

#### B. Interest Earned on Advanced Payments

Grantees must deposit advances or State grants and State Aid payments in interest bearing accounts.

In accordance with the Terms and Conditions of the award, interest earned on advanced payments shall be reported.

### IX. **Other Grant Provisions**

A. It is the Department's understanding that the Grantee's fiscal year ends on 12/31 \_\_\_\_\_. Any changes in the fiscal year must be reported immediately to the Department.

B. Other Terms and Conditions: I. Payment & Matching Funds; II. Approved Project; Eligible Costs; Conditions.

**ATTACHMENT B**

**APPROVED BUDGET**

Please attached the Budget submitted with your approved Application. *In the space below, indicate any revisions that are necessary to carry out your program, based on the actual amount awarded.* Attach supporting detail forms as required. These revisions are subject to approval. Please note the approved budget represents the financial plan to carry out your program, and forms the basis for the financial monitoring of this grant.

<b>Budget Categories</b>	<b>State</b>	<b>Non-State match (25%)</b>	<b>Non-State Other</b>	<b>Total Budget</b>
	\$0	\$0	\$0	\$0
	\$0	\$0	\$0	\$0
	\$0	\$0	\$0	\$0
	\$0	\$0	\$0	\$0
	\$0	\$0	\$0	\$0
	\$0	\$0	\$0	\$0
	\$0	\$0	\$0	\$0
	\$0	\$0	\$0	\$0
	\$0	\$0	\$0	\$0
	\$0	\$0	\$0	\$0
	\$0	\$0	\$0	\$0
	\$0	\$0	\$0	\$0
	\$0	\$0	\$0	\$0
	\$0	\$0	\$0	\$0
	\$0	\$0	\$0	\$0
	\$0	\$0	\$0	\$0
	\$0	\$0	\$0	\$0
	\$0	\$0	\$0	\$0
	\$0	\$0	\$0	\$0
	\$0	\$0	\$0	\$0
	\$0	\$0	\$0	\$0
	\$0	\$0	\$0	\$0
	\$0	\$0	\$0	\$0
	\$0	\$0	\$0	\$0
	\$0	\$0	\$0	\$0
<b>Sub-total Marketing Expense:</b>	<b>\$0</b>	<b>\$0</b>	<b>\$0</b>	<b>\$0</b>

## ATTACHMENT C

### REPORTING REQUIREMENTS

#### REPORTING REQUIREMENTS – COOPERATIVE MARKETING PROGRAM

**Please note that Final reports are due within 45 days following the end of the grant period. All funds will not be disbursed until all reports have been received and approved.**

- I. Interim Report – a Programmatic report is required, to include a narrative on the progress of the project, including a record of money spent do date and expectation of remaining spending to complete the project.
- II. Final Narrative Programmatic Report. The following items must be addressed in the reports submitted. Provide a summary to include:
  - A. Provide information on Return on Investment such as increased attendance, web hits, economic impact, etc.
  - B. Provide copies of collateral material and/or ads created with grant money
  - C. Provide proof of fulfillment of opportunities/benefits to the state as outlined in proposal, i.e. logo on collateral and ads, brochure distribution, logo on website, etc.
  - D. Indicate how objectives were achieved
  - E. Indicate project success that occurred
- II. Final Financial Report. Use the attached form to indicate the Approved Budget vs. Actual Costs. Please have supporting documentation available upon request.
  - A. Provide a final actual budget showing the grant plus the match
    1. Indicate the origin of the match. ATTACH PROOF (e.g., cancelled check);
    2. Show eligible expenses on which the grant plus match were spent;
    3. Attach receipts of expenditures for grant plus eligible match.

**PROGRAM SPECIFICATIONS**

**Program Specifications**

Cooperative Marketing grant requirements, including: the grantee will place the Division's logo and mandatory statement, "Supported in part by a grant from the New Jersey Department of State, Division of Travel and Tourism," on collateral material, including the grantee's website after presenting to the Division for approval. The grantee will submit to the Division of Travel and Tourism, in writing, any proposed changes to the awarded marketing program for the Division's approval.

A final report is due from the grantee 45 days after the grant conclusion date, including an actual budget showing the grant plus the match spent on eligible expenses, receipts, samples of collateral material and return on investment information, as well as proof the organization has fulfilled the promotional opportunities to the Division of Travel and Tourism.

ANY SPECIAL CONDITIONS OR PROGRAM REVISIONS ARE NOTED BELOW:

Conditions

## Program Revisions

Other Terms and Conditions

NJ DEPARTMENT OF STATE/DIVISION OF TRAVEL AND TOURISM

COOPERATIVE MARKETING GRANT PROGRAM

The following items are hereby annexed to and included with the Terms and Conditions contained in the Grant Agreement for this award.

WHEREAS, the Cooperative Marketing Grant Program is a collaboration between the Department of State/Division of Travel and Tourism and the New Jersey Travel Industry to promote New Jersey as a premier travel destination.

WHEREAS, these Program Specifications establish mandatory requirements for the award of Cooperative Marketing Grant funds.

WHEREAS, Jersey City is organized under the law of the State of New Jersey, which operates the organization located in New Jersey having applied for funding under the Cooperative Marketing Grant Program.

NOW THEREFORE, in addition to the general terms and conditions previously set forth in this Agreement, and for the purposes set forth above, the parties agree as follows:

SECTION I. Payment and Matching Funds

- A. Statutory Requirements. The funds awarded pursuant to this Agreement shall be distributed by the Department only to the extent that an amount equal to 25% of the State funds are expended from funds raised by the Department of State/Division of Travel & Tourism, pursuant to subsection j. of section 9 of P.L. 1977, c. 225 (C.34:1A-53), through contributions from private tourism industry concerns and non-State public entities as determined by the Director of the Division of Budget and Accounting.
- B. Payment and Limitation. Pursuant to and in accordance with the provisions of the Act and this Agreement, the Department shall provide to the Grantee an award from State funds. Payment of this award is conditioned upon payment by the Grantee of the matching funds required pursuant to Paragraph G of this Section. The Award Amount shall not be increased at any time for any reason and shall be decreased in proportion to the matching funds actually spent. The Grantee shall return with interest at any funds received that are in excess of this limitation.
- C. Matching Fund Amount. The Grantee agrees to contribute matching funds in an amount equal to or greater than 25% of amount awarded by the Department for the project. The Grantee shall provide qualified matching funds for the amount identified in the Budget, Attachment B.
- D. Source of Qualified Matching Funds. The Grantee represents, warrants and certifies that its payment of matching funds is from a source or sources other than the State of New Jersey or any State department, agency, board, commission or authority or other instrumentality of the State of New Jersey. The Matching funds shall be contributed in cash. *In-kind contributions of services, labor and materials shall not qualify as matching funds.* A cash match that comes from private tourism industry sources or non-State public entities is required. The Grantee represents, warrants and certifies that Attachment B, the Approved Budget is a true and accurate statement of the source(s) of matching funds.
- E. Commitments Qualifying as Cash in Hand. The Grantee may show the existence of a cash contribution by demonstrating a firm commitment from any third party source contributing funds to the Grantee which are dedicated to the Grantee to satisfy the matching fund requirements hereunder. Any such commitment shall be



documented to the satisfaction of the Department. Commitment letters from banks, local government agencies, or private sources must include the amount pledged and any conditions or limitations imposed. Tentative sources of cash matches, such as proposed fund-raising campaigns, are not acceptable.

- F. Support Documentation for Match Requirement. The Grantee shall obtain supporting documents for all sources of matching funds. (Examples are letters from banks to verify loans and terms, letters of commitment from volunteers or donors, other grant or loan program commitments, government body resolutions, etc.) The Grantee shall provide, upon request of the Department, documentation that the required matching funds are held by, or under the control of, the Grantee.
- G. Delivery of Matching Funds. In accord with Section XII of this Agreement, the Grantee shall demonstrate meeting the matching funds requirement as follows:
- A. Certification as to Availability of Matching Funds. The Grantee hereby represents, warrants and certifies that it has cash on hand in the required amount set forth in Section I Paragraph B. The Grantee further certifies that acceptance of Commission funds warrants that the proportional matching funds are immediately available to be used with the State funds, for payment of the eligible costs and expenses of the Grant Project.
  - B. Proportional Expenditure of Funds. Matching fund contributions shall be expended for the expenses and purposes authorized under this Agreement at the same rate, and in proportion to, the Grantee's expenditure of the State's share awarded under this Agreement.

**SECTION II. Approved Cooperative Marketing Grant Project; Eligible Costs; Conditions**

- A. Approval of Project. This Cooperative Marketing Program Grant is awarded for, and limited to the purposes, described in the Grantees Approved Proposal (the "Project"). Funds shall be expended by the Grantee only for purposes listed the Proposal and in the approved Budget. Expenditures are subject to any conditions or limitations of the project approval. The Grantee's Proposal is on file at the Department and funding awarded pursuant to this Agreement shall be used exclusively for authorized and qualifying expenses ("eligible costs") of the approved Proposal and the Approved Budget (Attach. B).
- B. Use of Division of Travel & Tourism Logo. The Grantee is permitted to use the Department's logo in public displays of the Project, subject to review and approval by the Department, pursuant to Section XXIV.
- C. Approval of Advertising Copy, Press Release. The Grantee shall retain responsibility for the character, diversity, quality and excellence of advertising undertaken as part of the scope of an approved Cooperative Marketing Grant Project, subject to review and approval of the content by the Department in accord with applicable State guidelines. The Grantee shall obtain pre-approval from the Division of Travel and Tourism for all advertising, press releases and collateral materials that contain the logo or name of the Department of State, Division of Travel and Tourism.
- D. Ownership and Copyright: Credits. The parties agree and understand that this Cooperative Marketing Grant is intended to promote tourism in the State of New Jersey and therefore, the approved scope of work may include advertising of tourism events or programs in various mediums. The parties agree, that any advertising procured by the Grantee utilizing funds provided pursuant to this Agreement, shall not be deemed a work for hire to the Department of State and the Department shall hold no rights concerning the content thereof. Any print publication or advertising in any medium that is procured by the Grantee as part of the Project shall include an acknowledgment that, pursuant to Section XXIV, funding, in part, was provided by the New Jersey Department of State, Division of Travel & Tourism. Unless other language is expressly authorized by the Department, the acknowledgment shall read as follows: **"Supported in part by a Grant from the New Jersey Department of State, Division of Travel and Tourism."**
- E. Copyright Indemnification. The Grantee shall hold and save harmless the State of New Jersey, the Department of State, and their officers, agents, servants and employees, from liability of any nature or kind for or on account of the use of any copyrighted or un-copyrighted composition, secret process, patented or unpatented invention, article or appliance furnished or used in the performance of this Agreement. The provisions of this Paragraph shall survive expiration or termination of this Agreement.

## OTHER TERMS & CONDITIONS

Page 3 of 3

- F. Agreement For Web Link and to Permit Commission to Market Project. The Grantee shall provide web links to the website of the Department of State and the Division of Travel and Tourism for the approved Project. Notwithstanding the foregoing requirement, a decision as to whether or not the link shall be displayed, effected, activated or enabled on the Department's website shall be within the sole discretion of the Department and in accordance with State guidelines. The Grantee hereby authorizes the Department to publish, advertise, list and include information about the Project in any of the Department's tourism marketing promotions, in any medium, and in the tourism marketing promotions of any other State agency working with the Department. The foregoing authorization is without limitation and does not require further approval, and shall extend to any use by the Department or State entity directly or indirectly through a contract vendor.
- G. Final Report. As specified in Attachment C, in addition to the report of expenditures required pursuant to this Agreement, the Grantee shall submit to the Division of Travel and Tourism a detailed report that outlines the Project and illustrates the measurable results of the Project. The report shall include details on how the results were measured, a copy of any press clippings, photos, radio and television transcripts, video and marketing materials were supported with the Project funding. The report is due within 45 days after conclusion of the Project and contain a certification of the amount of matching funds spent.
- H. Cancellation of Project Events. The Grantee shall immediately notify the Division of Travel and Tourism, by telephone and in writing if a Project event or program is cancelled or postponed. The Division shall approve any new date or extension of this Agreement as a modification to the Approved Project. This approval if granted orally by the Division shall be confirmed in writing by the Grantee within seven (7) days. If the Project is not rescheduled, the Grantee shall immediately return all funds advanced by the Department. If the Department fails to receive the repayment of the advanced funding within 15 days of the cancellation, the Grantee shall be deemed in default of this Agreement and no further notice or hearing shall be required prior to the Department pursuing any available remedies.

# Resolution of the City of Jersey City, N.J.

City Clerk File No. Res. 18-972

Agenda No. 10.M

Approved: NOV 07 2018

TITLE:



## RESOLUTION AUTHORIZING THE EXECUTION OF A LICENSE AGREEMENT WITH NEW JERSEY CITY UNIVERSITY ("NJCU") FOR FACILITY RENTAL AND USAGE

**COUNCIL** offered and moved adoption of the following resolution:

**WHEREAS**, the City of Jersey City ("the City") Department of Health & Human Services will be hosting a conference and training session for local non-profits and government agencies on November 15, 2018; and

**WHEREAS**, New Jersey City University, with offices located at 2039 Kennedy Boulevard (the "Licensor") is the owner of property located at 200 Hudson Street ("the Property") that the City intends to use for the purposes stated above on November 15, 2018; and

**WHEREAS**, Licensor agrees to permit the City to enter onto its Property for the purpose of conducting an educational seminar, time for networking, and technological training on social service software; and

**WHEREAS**, the License Agreement requires that the City indemnify Licensor from all risk of loss and/or damage to property or injury to or death of persons arising out of the City's use of Licensor's Property; and

**WHEREAS**, the City shall pay a \$711.60 deposit, followed by a payment of \$2846.40 for a total of \$3,558.00, to NJCU in exchange for the use of the Property; and,

**WHEREAS**, the License Agreement requires that the City provide a Certificate of Insurance that names Licensor as an additional insured; and,

**WHEREAS**, funds are available for this contract in the account;

<u>Account</u>	<u>PO #</u>	<u>Total Contract</u>
01-201-27-330-307	131139	\$3,558.00

**NOW, THEREFORE, BE IT RESOLVED**, by the Municipal Council of the City of Jersey City that:

1. The City and its employees, agents, guests, invitees or contractors are authorized to enter onto Licensor's Property to perform the activities described in the License Agreement attached hereto;
2. Subject to such modifications as may be deemed necessary or appropriate by Corporation Counsel, the Mayor or Business Administrator is authorized to execute the License Agreement attached hereto; and

City Clerk File No. Res. 18-972

Agenda No. 10.M NOV 07 2018

TITLE:

**RESOLUTION AUTHORIZING THE EXECUTION OF A LICENSE AGREEMENT WITH NEW JERSEY CITY UNIVERSITY ("NJCU") FOR FACILITY RENTAL AND USAGE**

- 3. The term of the License Agreement shall be effective for the date of November 15, 2018.
- 4. The City is authorized to pay NJCU \$3,558,000 in exchange for the use of the property.
- 5. The office of Risk Management is authorized to add NJCU, the State of New Jersey, and the New Jersey Educational Facilities Authority as "additional insureds" party to the City's insurance policies in accordance with the requirements of the License Agreement attached hereto.

I, Donna Mauer, Donna Mauer, Chief Financial Officer, hereby certify that there are sufficient funds available for payment of this resolution.

Account  
01-201-27-330-307

PO # 131139

Total Contract  
\$3,558.00

Approved by: \_\_\_\_\_  
Peter Folgado, Director of Purchasing  
QPA,RPPO

Date

*JMK  
10/29/18*

APPROVED: [Signature]  
APPROVED: \_\_\_\_\_  
Business Administrator

APPROVED AS TO LEGAL FORM  
[Signature]  
Corporation Counsel

Certification Required

Not Required

**APPROVED 8-0**

RECORD OF COUNCIL VOTE ON FINAL PASSAGE											
11.7.18											
COUNCILPERSON	AYE	NAY	N.V.	COUNCILPERSON	AYE	NAY	N.V.	COUNCILPERSON	AYE	NAY	N.V.
RIDLEY	✓			YUN	✓			RIVERA	✓		
PRINZ-AREY	✓			SOLOMON	✓			WATTERMAN	ABSENT		
BOGGIANO	✓			ROBINSON	✓			LAVARRO, PRES	✓		

✓ Indicates Vote

N.V.-Not Voting (Abstain)

Adopted at a meeting of the Municipal Council of the City of Jersey City N.J.

[Signature]  
Rolando R. Lavarro, Jr., President of Council

[Signature]  
Robert Byrne, City Clerk

**RESOLUTION FACT SHEET - CONTRACT AWARD**

This summary sheet is to be attached to the front of any resolution that is submitted for Council consideration. Incomplete or vague fact sheets will be returned with the resolution.

**Full Title of Ordinance/Resolution**

**RESOLUTION AUTHORIZING THE EXECUTION OF A LICENSE AGREEMENT WITH NEW JERSEY CITY UNIVERSITY ("NJCU") FOR FACILITY RENTAL AND USAGE**

**Project Manager**

Department/Division	Health & Human Services	Director's Office
Name/Title	Stacey Flanagan	Director, HHS
Phone/email	(201) 547 6560	SFlanagan@jcnj.org

Note: Project Manager must be available by phone during agenda meeting (Wednesday prior to council meeting @ 4:00 p.m.)

**Contract Purpose**

This is a resolution approving an agreement between Jersey City and NJCU allowing the City to use the Harborside Business School for a conference on November 15<sup>th</sup>, 2018. This resolution directs the City to issue a certificate of insurance for the event and encumbers the funds necessary to pay for the rental and use of their facility.

**Cost (Identify all sources and amounts)**

\$3558.00

**Contract term (include all proposed renewals)**

November 15, 2018

Type of award License/Use Agreement

If "Other Exception", enter type

**Additional Information**

I certify that all the facts presented herein are accurate.

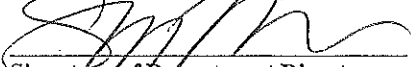
  
Signature of Department Director

10/25/18  
Date

## INDEMNIFICATION AGREEMENT

This Indemnification Agreement is made and entered into on this \_\_\_ of \_\_\_ 2018, by the City of Jersey City, a Municipal Corporation of the State of New Jersey (hereinafter referred to as "City") and New Jersey City University (hereafter referred to as "NJCU") 2039 John F. Kennedy Blvd., Jersey City, NJ 07305; and,

**WHEREAS**, the City Department of Health & Human Services ("HHS") is planning to host a conference at NJCU on November 15, 2018; and

**WHEREAS**, NJCU will permit the City to use its facilities provided the City provides indemnification and issues a certificate of insurance which lists NJCU as an additional insured; and

**WHEREAS**, the City will use NJCU for a conference on November 15, 2018;

**NOW, THEREFORE**, in consideration of NJCU's agreement to permit the City to use its facilities, the City hereby agrees as follows:

1) The City agrees to assume any and all risk of loss or damage of any kind whatsoever caused by the City's sole negligence to property or injury to or death including wrongful death of persons arising out of or in connection with the City's use of NJCU. The City further agrees to indemnify and hold harmless NJCU, its officers, directors, employees or agents from and against any and all claims, suits and demands based upon any of the risks so assumed, whether just or unjust, fraudulent or not, and for all costs and expenses incurred by them in the defense, settlement or satisfaction of any such claims, including attorney's fees and costs of suit. If so directed, the City shall, at no cost or expense to LSP, defend against such claims.

2) Nothing herein contained shall be understood or construed to create or grant any third party benefits, rights or property interest unless the person claiming such rights is identified herein and the rights claimed are expressly set forth herein.

3) The term of this Agreement is one year commencing on its execution date.

ATTEST:

City of Jersey City

By: \_\_\_\_\_

By: \_\_\_\_\_  
Brian Platt, Business Administrator

# INVOICE



**NEW JERSEY CITY UNIVERSITY**  
 2039 Kennedy Boulevard  
 Jersey City, New Jersey 07305  
 P: 201-200-3352  
 E: [eventservices@njcu.edu](mailto:eventservices@njcu.edu)  
 W: [www.njcu.edu/eventservices](http://www.njcu.edu/eventservices)

Client
Company/Organization: The City of New Jersey, Department of Health & Human Services
Event Name: Using Health Data for a HealthierJC
Event Date/Time: November 15, 2018; 7:30 AM-4:30 PM

Description	Fee
Venue(s)/Space(s)	\$ 2,300.00
a. NJCU School of Business, Lecture Hall 202 (7:30 AM-4:30 PM)	
b. NJCU School of Business, Classroom 201B (7:30 AM - 4:30 PM)	
c. NJCU School of Business, Computer Lab 105 (10:30 AM-12:30 PM)	
Service Providers	\$ 715.00
a. Custodial	
b. Public Safety	
c. Event Services Event Assistant	
Audio Visual	\$ 180.00
a. A/V Technician	
b. Equipment	

Special Notes/Instructions
Catering and/or table and linens can be ordered directly through Gourmet Dining - <a href="http://njcudining.com/">http://njcudining.com/</a> or contact 201-200-2113

Non-Profit Discount (10%)	\$ (230.00)
<b>Subtotal</b>	<b>\$ 2,965.00</b>
Administrative Fee (20%)	\$ 593.00
<b>Total</b>	<b>\$ 3,558.00</b>

A 20% deposit is due upon signing of the license agreement with the remaining balance due 14-days prior to the event start date. NJCU accepted payment in the form of business or certified check, money order made payable to 'New Jersey City University'.

Questions? Please contact NJCU Event Services Department, Kristen Stewart, at 201-200-3352 or [kstewart2@njcu.edu](mailto:kstewart2@njcu.edu)

**Thank you for your business!**



**NEW JERSEY CITY UNIVERSITY**  
 Department of Event Services  
 2039 Kennedy Boulevard, Jersey City, NJ 07305  
 Contact: (201) 200-3352 / [eventservices@nicu.edu](mailto:eventservices@nicu.edu)

**Facility Rental Agreement & Terms & Conditions**

This facility rental/usage Agreement ("Agreement") is entered into as of October 17, 2018 between, The City of New Jersey, Department of Health & Human Services, ("LICENSEE") having offices at Dr MLK Jr City Hall Annex, 1 Jackson Square, New Jersey, NJ 07305, and New Jersey City University ("NJCU"), a public institution of higher education of the State of New Jersey, having offices at 2039 Kennedy Boulevard, Jersey City, New Jersey, for use by LICENSEE of designated space or facilities owned by NJCU.

**SPACE USE**

LICENSEE agrees to rent ("SPACE") from University as follows:

Date	Time	Space	Activity
November 15, 2018	7:30 AM-4:30 PM	NJCU School of Business, Lecture Hall (202)	Event
November 15, 2018	7:30 AM-4:30 PM	NJCU School of Business, Classroom 201B	Event
November 15, 2018	10:30 AM-12:30 PM	NJCU School of Business, Computer Lab 105	Event

In doing so, LICENSEE agrees to the following terms and conditions:

**USAGE FEE AND PAYMENT**

LICENSEE agrees to pay \$3,558.00 to NJCU, a non-refundable 20% deposit in the amount of \$711.60 upon receipt of signed agreement and the remaining balance of \$2,846.40 no later than November 1, 2018. *A damage deposit may be requested at the discretion of NJCU.* Payments of the Usage Fee shall be made by business or certified check made payable to New Jersey City University and delivered or mailed to Kristen Stewart, Director of Event Services, at Office of University Advancement, New Jersey City University, Hepburn Hall - 321, Jersey City, New Jersey, 07305.

**INSURANCE AND INDEMNIFICATION**

LICENSEE shall indemnify and defend NJCU, its officers, employees and agents from any and all claims, contests, disputes, complaints, or causes of action arising from the operation of this Agreement. LICENSEE shall secure and maintain in force for the term of the Agreement, insurance coverage provided herein. All insurance coverage is subject to the approval of NJCU and shall be issued by an insurance company authorized to do business in the State of New Jersey and which maintains an A.M. Best rating of A- (VII) or better. LICENSEE shall provide NJCU with current Certificates of Insurance for all coverage and renewals thereof which must contain the provision that the insurance provided in the certificate shall not be canceled for any reason except after thirty (30) days written notice to University. All insurance required herein shall contain a waiver of subrogation in favor of NJCU. All insurance required herein, except Workers' Compensation, shall name LICENSEE, NJCU, the State of New Jersey, and the New Jersey Educational Facilities Authority, as additional insureds.

Commercial General Liability insurance written on an occurrence form including independent contractor liability, products/completed operations liability, contractual liability, covering but not limited to the liability assumed under the indemnification provisions of this contract. Coverage for bodily injury and property damage claims arising out of the professional acts of LICENSEE, its officers, employees, agents, volunteers, and subcontractors shall also be included should the events or activities require the attendance of a practitioner of the medical arts. The policy shall not include any endorsement that restricts or reduces coverage as provided by the ISO CG0001



form without the approval of the NJCU. The minimum limits of liability shall not be less than a combined single limit of one million dollars (\$1,000,000) per occurrence, two million dollars (\$2,000,000) general aggregate, one million dollars (\$1,000,000) product/completed operations aggregate. A "per location endorsement" shall be included, so that the general aggregate limit applies separately to the location that is the subject of this contract. Comprehensive Automobile Liability covering owned, non-owned, and hire vehicles shall be in force. The limits of liability shall not be less than a combined single limit of one million dollars (\$1,000,000) per occurrence.

Worker's Compensation Insurance applicable to the laws of the State of New Jersey and other State or Federal jurisdiction required to protect the employees of LICENSEE and any subcontractor who will be engaged in the performance of this Agreement. The certificate must so indicate that no proprietor, partner, executive officer or member is excluded. This insurance shall include Employers' Liability Protection with a limit of liability not less than one million dollars (\$1,000,000) bodily injury, each occurrence, one million dollars (\$1,000,000) disease, each employer, and one million dollars (\$1,000,000) disease, aggregate limit. Lower primary limits will be accepted if employer's liability insurance is included under umbrella insurance and the umbrella limit exceeds the above employer's liability limit requirements.

LICENSEE shall require all subcontractors, agents and franchisee to comply with all of the insurance requirements described above. LICENSEE shall be responsible for obtaining certificates of insurance for all coverage and renewals thereof for each subcontractor, agent and franchisee prior to their beginning work at NJCU. LICENSEE shall provide copies of all subcontractor, agents and franchise certificates of insurance to NJCU upon request.

#### **ASSIGNMENT AND SUBLETTING**

LICENSEE does not have the right to assign this Agreement or allow any other person or entity to use or occupy any of the Space without written consent of NJCU.

#### **DEFAULT**

If LICENSEE fails to pay any fee or other sum required to be paid by LICENSEE when due, or otherwise fails to comply with or observe any other provision of this Agreement, in addition to any other remedy that may be available to University, whether at law or in equity, NJCU may immediately terminate this Agreement and all rights of LICENSEE.

#### **FORCE MAJEURE**

If NJCU is unable to give possession of the Space on the date specified within the Agreement by reason of "force majeure," NJCU shall not be subject to liability for failure to give possession. Under such circumstances, LICENSEE shall be entitled to a return of all payments and deposits. For purposes of this Agreement, the term "force majeure" shall mean fire, earthquake, flood, heavy rain/thunderstorms, strikes of lightning, Act of God, or other labor disturbances, riots, or civil commotions, litigation, war or other act of foreign nation, power of government, or governmental agency or authority, or any other cause like or unlike any cause mentioned which is beyond the control of NJCU.

#### **INTERPRETATION**

This Agreement constitutes the entire agreement and understanding of the parties with respect to its subject matter. No prior or contemporaneous agreement or understanding will be effective. This Agreement may not be modified or amended except by written instrument signed by both parties. This Agreement shall be governed by the laws of New Jersey, the courts of which state shall have jurisdiction over its subject matter.

## **RELATIONSHIP**

Neither LICENSEE nor any personnel of LICENSEE will for any purpose be considered employees or agents of NJCU. LICENSEE assumes full responsibility for the actions of LICENSEE'S personnel, and is solely responsible for their supervision, daily direction and control, payment of salary (including withholding income taxes and social security), worker's compensation and disability benefits.

## **FACILITY/SPACE USAGE**

LICENSEE agrees:

To maintain the Space in as good order and condition as it was prior to LICENSEE'S use and will be held responsible for any damages to the Space or facility or loss or replacement of any equipment that is damaged and lost that may be incurred as a result of activity/usage of Space.

Not to use or allow the Space to be used for any unlawful purpose. Additionally, boisterous or nuisance persons may be requested to leave premises by NJCU.

Use of Space will be used only for activities for which they have been designated.

It shall not make any statements, written, oral, or otherwise, including promotional materials related to Space that could cause confusion as to the entity sponsoring the event occurring within the Space. Furthermore, agrees NJCU name and/or logo may not be used to advertise an event unrelated to university business and is only permitted to be used as specific venue as the location of the event on invitation and/or promotional materials.

Smoking is prohibited in NJCU facilities.

Parking on NJCU campus is subject to university regulations and availability, and charges will be at the expense of LICENSEE unless noted otherwise.

Not to affix décor or signage to NJCU property with nails, screws, or staple guns and agrees to remove all décor, signage directly following event. Moreover, candles/open flames are prohibited in NJCU facilities.

All catering services are provided through Gourmet Dining, NJCU's food service provider, unless NJCU provides written consent otherwise. Catering may be arranged directly with Gourmet Dining. (see <http://www.gourmetdiningllc.com/campus/njcu/>)

To obtain a Social Affair Permit from the State of New Jersey if alcohol will be served. (see [http://www.nj.gov/oag/abc/downloads/social\\_affair\\_permit.pdf](http://www.nj.gov/oag/abc/downloads/social_affair_permit.pdf))

## **TERMINATION**

This Agreement may be terminated for cause by NJCU for any breach of the Agreement provided that NJCU provides written notice to User of the breach and allows five days from the date of the notice for the breach to be cured. The Agreement may be terminated by either Party on written notice of thirty days. In the event of termination of the Agreement upon written notice, the Agreement shall be deemed terminated as of the date of the end of the notice period and any remaining payments to NJCU shall be prorated to the date of the termination of the Agreement. In all other cases the Agreement shall terminate at the end of the Term as specified Space Use of this Agreement.

**JURISDICTION**

This Agreement shall be governed and construed in accordance with the laws of the State of New Jersey and any action shall be brought in the courts of the State of New Jersey. Any claims against NJCU, its officers, employees, or agents shall be subject to the provisions of the New Jersey Tort Claims Act and the New Jersey Contractual Liabilities Act.

**LICENSEE CONTACT INFORMATION**

Name: Stacey L Flanagan  
Company/Organization: The City of Jersey City, Department of Health & Human Services  
Address: Dr MLK Jr City Hall Annex, 1 Jackson Square, Jersey City, NJ 07305  
Telephone: 201-577-2340  
Email: sflanagan@jcnj.org

In signing, I agree to the terms of this Agreement:

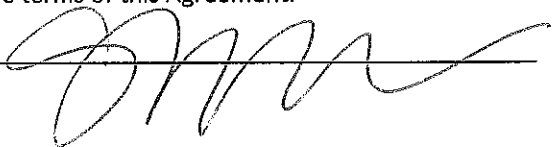
Signature of LICENSEE:  Date: 10/25/18

# Resolution of the City of Jersey City, N.J.

City Clerk File No. Res. 18-973

Agenda No. 10.N

Approved: NOV 07 2018

TITLE:



## RESOLUTION AUTHORIZING THE SETTLEMENT OF THE LAWSUIT CLAYTON DABNEY V. CITY OF JERSEY CITY

COUNCIL  
the following Resolution:

offered and moved adoption of

NOW, THEREFORE BE IT RESOLVED, by the Municipal Council of the City of Jersey City that:

WHEREAS, Clayton Dabney ("plaintiff") having filed suit against the City of Jersey City, in the Superior Court of New Jersey, Docket No.: HUD-L-2463-18; and

WHEREAS, the plaintiff was employed by the Jersey City Incinerator Authority ("JCIA") from April 5, 1982, until his retirement on October 1, 2015; and

WHEREAS, the terms of plaintiff's employment with the JCIA included compensation for unused his unused vacation time, sick time, personal days, snow time and severance pay; and

WHEREAS, October 14, 2015, the City dissolved the JCIA by Ordinance 15.104 and assumed responsibility for the payment of any and all debts and obligations of the JCIA; and

WHEREAS, plaintiff has accrued unused compensatory time totaling \$167,552.10, which consists of his unused vacation time, sick time, personal days, snow time and severance pay, that he is entitled to pursuant to the terms of his employment with the JCIA; and

WHEREAS, the Corporation Counsel has recommended a settlement in the amount of \$167,552.10; and

WHEREAS, the settlement shall be paid in two equal installments of \$83,776.10, with the first payment due within 60 days of the date of the settlement agreement and the second payment due on or before January 31, 2019; and

WHEREAS, plaintiff has agreed to this settlement and has signed a settlement agreement resolving all claims related to this litigation and agreeing to dismiss this lawsuit with prejudice; and

WHEREAS, the necessary funds for this settlement are available in the City of Jersey City Insurance Fund Commission Accounts.

TITLE:

**RESOLUTION AUTHORIZING THE SETTLEMENT OF THE LAWSUIT  
CLAYTON DABNEY V. CITY OF JERSEY CITY**

**NOW THEREFORE, BE IT RESOLVED** by the Municipal Council of the City of Jersey City that:

1. The Corporation Counsel is authorized to settle this lawsuit for \$167,552.10.
2. The Jersey City Insurance Fund Commission is authorized to issue two checks for \$83,776.10. The first check must be issued no later than 60 days of the date of the agreement. The second check must be issued on or before January 31, 2019.

APPROVED: \_\_\_\_\_

APPROVED AS TO LEGAL FORM

APPROVED: \_\_\_\_\_

Business Administrator

\_\_\_\_\_  
Corporation Counsel

Certification Required

Not Required

**APPROVED 8-0**

RECORD OF COUNCIL VOTE ON FINAL PASSAGE <b>11.7.18</b>											
COUNCILPERSON	AYE	NAY	N.V.	COUNCILPERSON	AYE	NAY	N.V.	COUNCILPERSON	AYE	NAY	N.V.
RIDLEY	✓			YUN	✓			RIVERA	✓		
PRINZ-AREY	✓			SOLOMON	✓			WATTERMAN	ABSENT		
BOGGIANO	✓			ROBINSON	✓			LAVARRO, PRES	✓		

✓ Indicates Vote

N.V.-Not Voting (Abstain)

Adopted at a meeting of the Municipal Council of the City of Jersey City N.J.

\_\_\_\_\_  
Rolando R. Lavarro, Jr., President of Council

\_\_\_\_\_  
Robert Byrne, City Clerk

**RESOLUTION FACT SHEET - NON CONTRACTUAL**

This summary sheet is to be attached to the front of any resolution that is submitted for Council Consideration. Incomplete or vague fact sheets will be returned with the resolution.

**Full Title of Ordinance/Resolution**

RESOLUTION AUTHORIZING THE SETTLEMENT OF THE LAWSUIT OF CLAYTON DABNEY V. CITY OF JERSEY CITY

**Initiator**

Department/Division	Law Department	Law Department
Name/Title	Peter J. Baker	Corporation Counsel
Phone/email	(201) 547-4667	pbaker@jcnj.org

Note: Initiator must be available by phone during the agenda meeting (Wednesday prior to council meeting @ 4:00 p.m.)

**Resolution Purpose**

To settle the above-referenced lawsuit for \$167,552.10, which is the value of Plaintiff Clayton Dabney's severance pay, as well as his unused vacation time, sick time, personal days, snow time and severance pay accumulated during his employment with the Jersey City Incinerator Authority. The settlement will be paid in two disbursements of \$83,776.10. The first payment is due within 60 days of the settlement agreement. The second payment is due on or before January 31, 2019.

I certify that all the facts presented herein are accurate

  
\_\_\_\_\_  
Signature of Department Director

10/30/18  
\_\_\_\_\_  
Date

EMPLOYEE SEPARATION - FINANCIAL WORKSHEET

EMPLOYEE NAME: Clayton Dabney LAST DAY WORKED: 07/01/2015  
ANNUAL SALARY: 106097.00 WEEKLY 2021.09 DAILY 404.71 HOURLY 53.89

RENUMERATION

VACATION DUE

$\frac{675}{\text{\# OF HOURS}} \times \frac{\$ 53.89}{\text{Hourly Rate}} = \$ 36,375.75$

SICK TIME (only in case of retirement)

$\frac{1825.75}{\text{\# OF HOURS}} \times \frac{\$ 53.89}{\text{Hourly Rate}} \times (80\%) = \$ 78,711.74$

TIME WITHHELD (Salary at time of hire)

$\frac{32}{\text{\# OF HOURS}} \times \frac{\$ 6.01}{\text{Hourly Rate}} = \$ 192.32$

PERSONAL DAYS DUE

$\frac{22.60}{\text{\# OF HOURS}} \times \frac{\$ 53.89}{\text{Hourly Rate}} = \$ 1,212.52$

SEVERANCE PAY DUE

$\frac{742.60}{\text{\# OF HOURS}} \times \frac{\$ 53.89}{\text{Hourly Rate}} = \$ 40,013.33$

SUB TOTAL \$ 156,504.05

DEDUCTIONS

OUTSTANDING LOANS \$ \_\_\_\_\_

UNRETURNED EQUIPMENT \$ \_\_\_\_\_

\_\_\_\_\_  
(Signature/Title) Date \_\_\_\_\_

\_\_\_\_\_  
(Signature/Title) Date \_\_\_\_\_

\_\_\_\_\_  
(Signature/Title) Date \_\_\_\_\_

Original Signatures Only

182

EMPLOYEE SEPARATION - FINANCIAL WORKSHEET

EMPLOYEE NAME: Clayton Dabney LAST DAY WORKED: 07/01/2016  
ANNUAL SALARY: 105097.00 WEEKLY 2021.09 DAILY 404.71 HOURLY 53.89

RENUMERATION

SNOW EMERGENCY COMP TIME

206 # OF HOURS x \$ 53.89 Hourly Rate ----- \$ 11,047.45

SICK TIME (only in case of retirement)

\_\_\_\_\_ # OF HOURS x \$ Hourly Rate x (80%) ----- \$ \_\_\_\_\_

TIME WITHHELD (Salary at time of hire)

\_\_\_\_\_ # OF HOURS x \$ Hourly Rate ----- \$ \_\_\_\_\_

PERSONAL DAYS DUE

\_\_\_\_\_ # OF HOURS x \$ Hourly Rate ----- \$ \_\_\_\_\_

SEVERANCE PAY DUE

\_\_\_\_\_ # OF HOURS x \$ Hourly Rate ----- \$ \_\_\_\_\_

GRAND TOTAL \$ 167,552.10

DEDUCTIONS

OUTSTANDING LOANS ----- \$ \_\_\_\_\_  
UNRETURNED EQUIPMENT ----- \$ \_\_\_\_\_

\_\_\_\_\_  
(Signature/Title) Date \_\_\_\_\_

\_\_\_\_\_  
(Signature/Title) Date \_\_\_\_\_

\_\_\_\_\_  
(Signature/Title) Date \_\_\_\_\_

Original Signatures Only

282



**SETTLEMENT AGREEMENT AND GENERAL RELEASE**

This Settlement Agreement and General Release ("Agreement") is by and between: (1) Clayton Dabney ("Dabney"); and (2) the City of Jersey ("Jersey City"). Dabney and Jersey City will sometimes collectively be referred to herein as "the Parties."

**WHEREAS**, Dabney filed a lawsuit against Jersey City, in Hudson County Superior Court bearing Docket No. HUD-L-2463-18 ("Complaint"); and

**WHEREAS**, the Parties now mutually desire to resolve all of their disputes;

**NOW THEREFORE**, in consideration of the foregoing, and of the promises and mutual covenants herein contained, the Parties agree as follows:

**1. SETTLEMENT PAYMENT**

In consideration for Dabney's agreement to all of the terms, conditions and promises in this Agreement, Jersey City shall issue two (2) checks payable to "Clayton Dabney" as follows: (1) within sixty (60) days from the date of this Agreement, Jersey City will issue the a check in the amount of \$83,776.05 representing the first half of the total settlement amount; and (2) on or before January 31, 2019, Jersey City will issue the a check in the amount of \$83,776.05 representing the second half of the total settlement amount (collectively the "Settlement Payment"). The Settlement Payment (i.e., both payments as set forth above) represent full and complete satisfaction of all of Dabney's claims, including any claims for attorneys' fees, costs, and other legal expenses. Each payment shall be reported as income on IRS Form 1099 for the calendar year in which the payment was made. The two (2) checks comprising the Settlement Payment will be delivered to Dabney's attorney at the following address: Raff & Masone, P.A., 1081 Avenue C, Bayonne, New Jersey 07002.

**2. TAX LIABILITY**

Dabney agrees that he shall be liable for the payment of all federal, state and local taxes which may be due as the result of the consideration received in the Settlement Payment described above, and that such Settlement Payment is made for the settlement of disputed claims as set forth herein. Dabney agrees that he shall pay such taxes at the time and in the amount required by law. In addition, Dabney agrees fully to defend, indemnify and hold Jersey City harmless from any liability for payment of these taxes and/or any penalties, withholding obligations and interest that are required of him by any government agency as the result of the Settlement Payment.

**3. DISMISSAL OF CASE**

Dabney agrees that upon execution of this Agreement, he shall take all steps to facilitate the dismissal with prejudice of the Complaint bearing Docket No. HUD-L-2463-18. Dabney represents that, other than the Complaint, he is not a party in any pending administrative charge, lawsuit, civil action, collective action, class action, or claim of any kind against Jersey City, including Jersey City or any of its agencies, subsidiaries, affiliates, divisions, agents, servants, officers, directors, employees, insurers, benefit plan fiduciaries, or successors.

**4. SUFFICIENCY OF CONSIDERATION**

Dabney acknowledges and agrees that the consideration provided by Jersey City to him pursuant to this Agreement constitutes good and valuable consideration for the general release and the other promises and terms in this Agreement. Dabney understands and agrees that he is not eligible for or entitled to any other benefit or consideration from Jersey City, except as provided in this Agreement.

**5. GENERAL RELEASE**

In exchange for the Settlement Payment set forth above in Paragraph 1, Dabney agrees, intending to be legally bound, to the maximum extent permitted by law, to release and forever discharge Jersey City, including its agencies, subsidiaries, affiliates, divisions, agents, servants, officers, directors, employees, insurers, benefit plan fiduciaries, or predecessors or successors (collectively, the "Released Parties") individually and

collectively, from any and all claims, causes of action, complaints, lawsuits or liabilities of any kind (collectively "Released Claims"), which Dabney, his heirs, agents, attorneys, administrators or executors may have against Jersey City or any of the other Released Parties. The Release Parties specifically includes the Jersey City Incinerator Authority ("JCIA").

**6. PROMISE NOT TO APPLY FOR WORK WITH JERSEY CITY**

In addition to the waiver of the Released Claims by Dabney set forth in Paragraph 5 above, Dabney agrees not to apply for employment with Jersey City or any of its agencies, subsidiaries, affiliates, divisions or departments at any time in the future.

**7. COVENANT NOT TO SUE**

Dabney agrees not to file or initiate a lawsuit in any court, initiate any grievance or arbitration proceeding, or opt into any collective action or class action, asserting any of the Released Claims against any of the Released Parties.

**8. NO FAIR LABOR STANDARDS ACT CLAIM**

Dabney represents that he is not aware of any facts that would support a claim against any of the Released Parties for unpaid overtime or any other alleged violation of the Fair Labor Standards Act or comparable state or local law.

**9. NON-DISPARAGEMENT**

Dabney agrees that he will not make any negative comments or disparaging remarks, in writing, orally or electronically, about Jersey City, including any of the Released Parties. However, nothing in this Agreement shall be interpreted to restrict his right and obligation: (i) to testify truthfully in any forum; (ii) to cooperate fully and provide information as requested in any investigation by a governmental agency or commission or as required by law; or (iii) to exercise his First Amendment rights to participate in public discourse about public issues that are

unrelated to his employment with the JCIA or the facts of the Complaint.

**10. NO ADMISSION OF WRONGDOING**

The Parties acknowledge that this Agreement does not constitute an admission by the JCIA, Jersey City or any of the Released Parties of any of the matters alleged in the Complaint or of any violation by them of any federal, state or local law, ordinance or regulation, or of any violation of any policy or procedure, or of any liability or wrongdoing whatsoever. Neither this Agreement nor anything in this Agreement shall be construed to be or shall be admissible in any proceeding as evidence of liability or wrongdoing by the JCIA, Jersey City or the Released Parties. This Agreement may be introduced, however, in any proceeding to enforce this Agreement.

**11. GOVERNING LAW**

This Agreement shall be governed by and conformed in accordance with the laws of the State of New Jersey without regard to its conflict of law jurisprudence.

**12. COUNTERPARTS**

This Agreement may be executed, by the Parties or their attorneys, in counterparts and each counterpart will be deemed an original.

**13. UNDERSTANDING OF AGREEMENT BY DABNEY**

Dabney agrees and represents that:

- o he has read carefully the terms of this Agreement, including the General Release;
- o he has had an opportunity to and has been encouraged to review this Agreement, including the General Release, with an attorney;
- o he understands the meaning and effect of the terms of this Agreement, including the General Release;
- o his decision to sign this Agreement, including the General Release, is of his own free and voluntary act without compulsion of any kind;
- o he has been made no promise or inducement, other than those contained in this Settlement Agreement; and

- o he has adequate information to make a knowing and voluntary decision to entered into this Settlement Agreement.

**14. SEVERABILITY**

Should any term or provision of this Agreement be declared illegal, invalid or unenforceable by any court of competent jurisdiction and if such provision cannot be modified to be enforceable, such provision shall immediately become null and void, leaving the remainder of this Agreement in full force and effect. The language of all parts of this Agreement shall in all cases be construed as a whole, according to its fair meaning, and not strictly for or against any of the parties.

**15. ENTIRE AGREEMENT**

This Agreement sets forth the entire agreement between the Parties hereto and fully supersedes any and all prior and/or supplemental understandings, whether written or oral, between the Parties concerning the subject matter of this Agreement. Dabney acknowledges that he has not relied on any representations, promises or agreements of any kind made to him in connection with the decision to accept the terms of this Agreement, except for the representations, promises and agreements herein. Any modification to this Agreement must be in writing and signed by Dabney and the Business Administrator and/or Corporation Counsel.

**IN WITNESS WHEREOF**, the Parties knowingly and voluntarily executed this Settlement Agreement and General Release as of the date set forth below.

**FOR DABNEY:**

  
\_\_\_\_\_  
CLAYTON DABNEY

Dated: 10/5/2018

**WITNESS:**

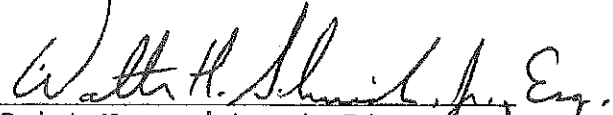
  
\_\_\_\_\_  
Print Name: Walter H. Schneider, Jr., Esq.

Dated: 10/5/18

**FOR JERSEY CITY:**

BRIAN PLATT  
Business Administrator

Dated: \_\_\_\_\_

# Resolution of the City of Jersey City, N.J.

City Clerk File No. Res. 18-974

Agenda No. 10.0

Approved: NOV 07 2018



TITLE:

**RESOLUTION OF THE MUNICIPAL COUNCIL OF THE CITY OF JERSEY CITY AUTHORIZING THE ACCEPTANCE OF THE USA SWIMMING FOUNDATION LOCAL PARTNERS PROGRAM GRANT AWARD FOR THE JERSEY CITY DEPARTMENT OF RECREATION**

**COUNCIL AS A WHOLE  
FOLLOWING RESOLUTION:**

**OFFERED AND MOVED ADOPTION THE**

**WHEREAS**, the City of Jersey City Department of Recreation would like to accept the USA Swimming Foundation "Make A Splash" Local Partner grant to teach children how to swim, and

**WHEREAS**, the USA Swimming Foundation "Make A Splash" grant award would provide 900 children with swim instruction; and

**WHEREAS**, the grant award from the USA Swimming Foundation program will become integrated into the Department of Recreation Learn to Swim curriculum; and

**WHEREAS**, the Department of Recreation will provide training, risk management counseling, and ongoing supervision of the Department of Recreation aquatic staff; and

**WHEREAS**, the program will be conducted as part of the Department of Recreation lesson program with no less than four (4) hours in-water instruction for each participant; and

**WHEREAS**, this approved grant is for the period through December 15, 2018 in the amount of \$4,824; and

**NOW, THEREFORE, BE IT RESOLVED**, by the Municipal Council of the City of Jersey City that:

1. The Office of Management and Budget is authorized to established an account in the amount of \$4,824 for the USA Swimming Foundation "Make A Splash" grant.
2. The Mayor and/or Business Administrator is authorized to accept the grant award for the City of Jersey City Department of Recreation's "Make A Splash" program in the amount of \$4824.
3. The Mayor and/or Business Administrator acknowledge the terms and conditions for administering the USA Swimming Foundation "Make A Splash" grant, including the administrative compliance and audit.

TITLE:

JMcK  
10/24/18

APPROVED: \_\_\_\_\_

APPROVED AS TO LEGAL FORM

APPROVED: [Signature]

Business Administrator

[Signature]  
Corporation Counsel

Certification Required

Not Required

APPROVED 8-0

RECORD OF COUNCIL VOTE ON FINAL PASSAGE 11.7.18											
COUNCILPERSON	AYE	NAY	N.V.	COUNCILPERSON	AYE	NAY	N.V.	COUNCILPERSON	AYE	NAY	N.V.
RIDLEY	✓			YUN	✓			RIVERA	✓		
PRINZ-AREY	✓			SOLOMON	✓			WATTERMANN	ABSENT		
BOGGIANO	✓			ROBINSON	✓			LAVARRO, PRES.	✓		

✓ Indicates Vote

N.V.-Not Voting (Abstain)

Adopted at a meeting of the Municipal Council of the City of Jersey City N.J.

[Signature]  
Rolando R. Lavarro, Jr., President of Council

[Signature]  
Robert Byrne, City Clerk



**RESOLUTION FACT SHEET – NON CONTRACTUAL**

This summary sheet is to be attached to the front of any resolution that is submitted for Council consideration. Incomplete or vague fact sheets will be returned with the resolution.

**Full Title of Ordinance/Resolution**

**RESOLUTION AUTHORIZING THE CITY OF JERSEY CITY DEPARTMENT OF RECREATION TO ACCEPT THE GRANT FROM THE USA SWIMMING FOUNDATION PARTNER PROGRAM IN THE AMOUNT OF \$4,824**

**Initiator**

Department/Division	Department of Recreation	
Name/Title	Arthur Williams	Director
Phone/email	(201) 547-4537	ajwilliams@jcnj.org

Note: Project Manager must be available by phone during agenda meeting (Wednesday prior to council meeting @ 4:00 p.m.)

**Resolution Purpose**

The purpose of this resolution is to accept the award of \$4,824 from the USA Swimming Foundation to support the department's efforts to expand its water safety and instruction program. To provide approximately 900 children swimming lessons and awareness about water safety measures through December 15, 2018

I certify that all the facts presented herein are accurate.

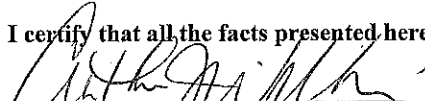
  
Signature of Department Director

  
Date

# Resolution of the City of Jersey City, N.J.

City Clerk File No. Res. 18-975

Agenda No. 10.P

Approved: NOV 07 2018



TITLE:

**RESOLUTION AUTHORIZING THE EXECUTION OF A MEMORANDUM OF UNDERSTANDING WITH THE STATE OF NEW JERSEY DEPARTMENT OF MILITARY AND VETERANS AFFAIRS PERMITTING THE CITY OF JERSEY CITY TO USE THE NATIONAL GUARD ARMORY AT 678 MONTGOMERY STREET, JERSEY CITY, NEW JERSEY**

**COUNCIL AS A WHOLE  
FOLLOWING RESOLUTION:**

**OFFERED AND MOVED ADOPTION THE**

**WHEREAS**, the State of New Jersey, Department of Military and Veterans Affairs ("DMVA") is the owner of the National Guard Armory located at 678 Montgomery Street, Jersey City, New Jersey ("Armory"); and

**WHEREAS**, the City of Jersey City ("City") desires to use the Armory to provide structured recreational programs and activities for the benefit of the children and adults of Jersey City; and

**WHEREAS**, the DMVA agrees to permit the City to use the Armory for the period effective as of November 24, 2018 through March 8, 2019 provided the City pays a total user fee of \$104,714.00; and

**WHEREAS**, for the period of November 24, 2018 through December 28, 2018 the user fee will be approximately \$32,045.50 which is available in account 18-10-201-28-370-304; and

**WHEREAS**, for the period of January 2, 2018 through March 8, 2019 the user fee will be approximately \$72,668.50; and

**WHEREAS**, the Armory will enable the Department of Recreation to accommodate approximately 500 children per night for various recreational programs; and

**WHEREAS**, the City desires to execute a memorandum of understanding with DMVA authorizing the City to use the Armory; and

**WHEREAS**, the City is authorized to execute a memorandum of understanding with another public body pursuant to N.J.S.A. 40A:11-5(2) of the Local Public Contracts Law;

**NOW, THEREFORE, BE IT RESOLVED**, by the Municipal Council of the City of Jersey City that:

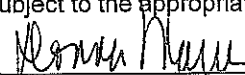
1. The Mayor or Business Administrator is authorized to execute the Memorandum of Understanding attached hereto; and
2. Pursuant to N.J.A.C. 5:30-5.5 (c), the continuation of the contract after the expenditure of funds encumbered in the 2018 fiscal year budget shall be subject to the appropriation of funds in the 2019 fiscal year budget.
3. I,  Donna Mauer, Chief Financial Officer, certify that funds in the amount of \$32,045.50 are available in Account No. 18-10-201-28-370-304. P.O.# 131227

TITLE:

JMcK  
10/26/18

APPROVED: \_\_\_\_\_

APPROVED AS TO LEGAL FORM

APPROVED: \_\_\_\_\_  
 Business Administrator

\_\_\_\_\_  
 Corporation Counsel

Certification Required

Not Required

APPROVED 8-0

RECORD OF COUNCIL VOTE ON FINAL PASSAGE 11.7.18											
COUNCILPERSON	AYE	NAY	N.V.	COUNCILPERSON	AYE	NAY	N.V.	COUNCILPERSON	AYE	NAY	N.V.
RIDLEY	✓			YUN	✓			RIVERA	✓		
PRINZ-AREY	✓			SOLOMON	✓			WATTERMAN	ABSENT		
BOGGIANO	✓			ROBINSON	✓			LAVARRO, PRES.	✓		

✓ Indicates Vote

N.V.-Not Voting (Abstain)

Adopted at a meeting of the Municipal Council of the City of Jersey City N.J.

\_\_\_\_\_  
 Rolando R. Lavarro, Jr., President of Council

\_\_\_\_\_  
 Robert Byrne, City Clerk

**RESOLUTION FACT SHEET – NON CONTRACTUAL**

This summary sheet is to be attached to the front of any resolution that is submitted for Council consideration. Incomplete or vague fact sheets will be returned with the resolution.

**Full Title of Ordinance/Resolution**

**RESOLUTION AUTHORIZING THE EXECUTION OF A MEMORADUM OF UNDERSTANDING WITH THE STATE OF NEW JERSEY DEPARTMENT OF MILITARY AND VETERANS AFFAIRS PERMITTING THE CITY OF JERSEY CITY TO USE THE NATIONAL GUARD ARMORY AT 678 MONTGOMERY STREET, JERSEY CITY, NEW JERSEY**

**Initiator**

Department/Division	Department of Recreation	
Name/Title	Arthur Williams	Director
Phone/email	(201) 547-4537	ajwilliams@cnj.org

Note: Project Manager must be available by phone during agenda meeting (Wednesday prior to council meeting @ 4:00 p.m.)

**Resolution Purpose**

To provide structured recreational programs and activities for the benefit of the children and adults of Jersey City. These activities comprise of such programs as football programs, boxing programs, tennis programs, and various indoor recreational activities for youth and seniors.

I certify that all the facts presented herein are accurate.

  
Signature of Department Director

10/26/18  
Date

**State of New Jersey**  
**Department of Military & Veterans Affairs-RPB**  
**P.O. Box 340**  
**Trenton, NJ 08625-0340**

Date of Use Agreement: Tuesday September 26, 2017

Use Agreement Number: 18180 – R4  
**Revised 9 Jan 2018**

This Use Agreement, made and entered into on the above date between the Department of Military and Veterans Affairs, State of New Jersey, (hereinafter Department), and

City of Jersey City/Department of Recreation  
Caven Point Complex-1 Chapel Avenue  
Jersey City, NJ 07305

Robert J. Kakoleski, Business Administrator  
Kevin Williamson, Director Dept of Recreation  
(201) 547-4537

hereinafter referred to as the User.

WITNESSETH that the parties hereto for the considerations hereinafter mentioned and agree as follows:

1. The Department hereby leases to the User, space at the following premises for the term and purpose stated:

National Guard Armory: 678 Montgomery Street

Jersey City, NJ 07306-3395

Dates: Saturday, November 18, 2017 - Thursday, March 08, 2018 (See Anticipated Use Schedule 9 Jan 2018)

Time: Various – (See Anticipated Use Schedule dated 9 Jan 2018)

Purpose: Recreation Activities and 8 Special Events

Space Used: Drill floor

Seating Areas Drill Floor Level

Restrooms: All on the drill floor level and on the Summit Avenue side of the building

*Locker rooms during special events only*

*Control room during special events only*

*Seating Areas – second level during special events only*

*Restrooms on the second level - Jordan Avenue side of the building during special events only*

2. The User shall pay the Department, in advance, by Bank, Cashier, Certified Check or Money Order to the Treasurer, State of New Jersey as indicated below:

Application Fee: \$75.00

Total Fees: **\$116,018.50**

Balance Due: **\$78,096.50**

Use Fee: \$94,300.00

Payments Received: **\$37,922.00**

Estimated Armorer Fee: **\$21,643.50**

The Armorer Fee is for custodial services that include those services required before, during and the after the use. Fee is based upon overtime or premium rates for personnel engaged to perform these services. Additional Fees may be assessed if estimated Armorer fee is not sufficient to cover the required custodial services.

User will be responsible for the payment of any and all fees related to the use of additional space and Armorer fees worked not listed on the original contract.

3. Person of contact for the Department will be:

Charles Parsons

Telephone (201) 433-0619

Cell: (201) 206-6366

Any problems or inquiries should be directed to this person.

4. The User shall obtain liability insurance coverage for the period of the use in the following minimum amounts. Insurance policy shall name the New Jersey Department of Military and Veterans' Affairs and its employees as an additional insured.

Insurance: \$1,000,000 Bodily Injury

\$1,000,000 Property Damage

NOTE: Memorandum of Understanding is incorporated into this Use Agreement.

**State of New Jersey  
Department of Military & Veterans Affairs-RPB  
P.O. Box 340  
Trenton, NJ 08625-0340**

ID-RPB

Tuesday, January 9, 2018

SUBJECT: Use of Jersey City Armory

TO: City of Jersey City/Department of Recreation

1. Attached is use agreement number 18180 in triplicate, covering the following:

Date(s): 11/18/2017 - 3/8/2018

Purpose: Meeting

Application Fee _____	\$ 75.00
Armorer Fee _____	\$21,643.50
Use Fee _____	\$94,300.00
Total Fees _____	\$116,018.50

Revision 4

2. The User assumes full and complete responsibility for the safety of the public during any occupancy, and **must obtain** (if applicable) an **insurance policy** to support their use. The proof/certificate of insurance must cover all injuries and property damage that may be sustained by any person occupying the premises as a result of said use agreement.

3. Insurance policies/certificates **must include the following statement, "THE NEW JERSEY DEPARTMENT OF MILITARY AND VETERANS AFFAIRS AND ITS EMPLOYEES ARE NAMED AS ADDITIONAL INSURED."** Coverage amounts required are as shown on your use agreement and must be provided in advance of use.

4. **Payment is required in advance of use and must be remitted by CERTIFIED CHECK, BANK CHECK, CASHIER CHECK, or MONEY ORDER made payable to "TREASURER, STATE OF NEW JERSEY, DEPARTMENT OF MILITARY AND VETERANS' AFFAIRS."** No personal checks please and **DO NOT SEND CASH.**

5. Please sign and return all three (3) copies of the attached agreement along with payment and proof of insurance. **Please ensure all three original signature agreements are returned.** A fully endorsed copy of the agreement will be returned to you. Documentation **must be received** by this office at least ten (10) days prior to your use.

6. **No use of the facility will be allowed without endorsed agreements, payment and proof of insurance.** Other documentation (floor plans, permits and licenses) may be required to support use. Failure to produce the documentation may result in access to the facility being denied.

7. If you have any questions or concerns regarding your use agreement or the requirements to secure use please call us at (609) 530-6906 or (609) 530-6856.

FOR THE ADJUTANT GENERAL:

Office of Real Property  
Rental and Leasing Section

3 Enclosures  
CF: Chief Armorer

# November 2018

December 2018

November 2018

Su	Mo	Tu	We	Th	Fr	Sa
1	2	3	4	5	6	7
8	9	10	11	12	13	14
15	16	17	18	19	20	21
22	23	24	25	26	27	28
29	30	31				

Sunday	Monday	Tuesday	Wednesday	Thursday	Friday	Saturday
Oct 28	29	30	31	Nov 1	2	3
4	5	6	7	8	9	10
11	12	13	14	15	16	17
18	19	20	21	22	23	24
25	26 1 <sup>st</sup> DAY	27	28	29	30	Dec 1
	Opening Day		3 pm - 8 pm		Holidays	

Joe Macchi

9/17/2018 3:21 PM

# December 2018

December 2018							January 2019						
Su	Mo	Tu	We	Th	Fr	Sa	Su	Mo	Tu	We	Th	Fr	Sa
	1	2	3	4	5	6	7	8	9	10	11	12	13
14	15	16	17	18	19	20	21	22	23	24	25	26	27
28	29	30	31										

	Sunday	Monday	Tuesday	Wednesday	Thursday	Friday	Saturday
11/25 - 30	Nov 25	26	27	28	29	30	Dec 1
	X — Nov. CALENDAR X						
12/2 - 7	2	3	4	5	6	7	8
	— 3pm — 8pm —						
12/9 - 14	9	10	11	12	13	14	15
	— 3pm — 8pm					SE	
					LEON BAILEY 3pm - 10pm		
12/16 - 21	16	17	18	19	20	21	22
	— 3pm — 8pm —				12pm/NOON - 5pm		
12/23 - 28	23	24	25	26	27	28	29
	Closed		10AM — 3pm				
12/30 - 1/4	30	31	Jan 1, 19	2	3	4	5
	Closed		3pm — 8pm				

Joe Macchi



# January 2019

January 2019

February 2019

Su	Mo	Tu	We	Th	Fr	Sa
3	4	5	6	7	8	9
10	11	12	13	14	15	16
17	18	19	20	21	22	23
24	25	26	27	28		

Su	Mo	Tu	We	Th	Fr	Sa
6	7	8	9	10	11	12
13	14	15	16	17	18	19
20	21	22	23	24	25	26
27	28	29	30	31		

Sunday	Monday	Tuesday	Wednesday	Thursday	Friday	Saturday
Dec 30	Jan 1, 19	2	3	4	5	
6	7	8	9	10	11	12
13	14	15	16	17	18	19
20	21	22	23	24	25	26
27	28	29	30	31	Feb 1	2

Handwritten notes in the calendar grid:

- Jan 1: X - Dec calendar
- Jan 7: 3pm - 8pm
- Jan 8: HCTCA Relays 3pm - 8pm
- Jan 14: 3pm - 8pm
- Jan 15: 3pm - 8pm
- Jan 21: Holiday
- Jan 22: Closed
- Jan 28: 3pm - 8pm
- Jan 29: 3pm - 8pm
- Jan 30: 3pm - 8pm
- Jan 31: 3pm - 8pm
- Feb 1: 3pm - 8pm
- Feb 2: 3pm - 8pm

Joe Macchi

9/17/2018 3:22 PM

TBA - JJC Championship, Bill Reid, Ed Grant

# February 2019

31	30	29	28	27	26	25	24	23	22	21	20	19	18	17	16	15	14	13	12	11	10	9	8	7	6	5	4	3	2	1				
Su	Mo	Tu	We	Th	Fr	Sa	Su	Mo	Tu	We	Th	Fr	Sa	Su	Mo	Tu	We	Th	Fr	Sa	Su	Mo	Tu	We	Th	Fr	Sa	Su	Mo	Tu	We	Th	Fr	Sa

Jan 27	28	29	30	31	Feb 1	2	3	4	5	6	7	8	9	10	11	12	13	14	15	16	17	18	19	20	21	22	23	24	25	26	27	28	Mar 1	2
Sunday	Monday	Tuesday	Wednesday	Thursday	Friday	Saturday																												

X - JAN. ARTS MARKET X

Open - 8pm

Open - 8pm

Closed

Open - 8pm

Open - 8pm

SPRING  
EXPO  
8am - 8pm

9/17/2018 3:22 PM

TRH - 3 TRACK MEETS (JAN. 2019)

Joe Machi

Feb 24 - Mar 2

Feb 17 - 23

Feb 10 - 16

Feb 3 - 9

Jan 27 - Feb 2

# March 2019

April 2019

Su	Mo	Tu	We	Th	Fr	Sa
1	2	3	4	5	6	7
8	9	10	11	12	13	14
15	16	17	18	19	20	21
22	23	24	25	26	27	28
29	30					

March 2019

Su	Mo	Tu	We	Th	Fr	Sa
1	2	3	4	5	6	7
8	9	10	11	12	13	14
15	16	17	18	19	20	21
22	23	24	25	26	27	28
29	30	31				

	Sunday	Monday	Tuesday	Wednesday	Thursday	Friday	Saturday
Feb 24		25	26	27	28		
3		4	5	6	7	8 LAST DAY	9
10		11	12	13	14	15	16
17		18	19	20	21	22	23
24		25	26	27	28	29	30
31		Apr 1	2	3	4	5	6

X - Feb - calendar -  
 - Spr - Spr -

**JERSEY CITY ARMORY**  
**Anticipated Use Schedule - CITY OF JERSEY CITY**  
**UA 18180 R-4**

Date of Use	Day of Week	Purpose	Area/s of Use	USE TIMES			ARMORER			Revision Number	
				Start	End	HOURS	Start	End	# Required		HOURS
18-Nov-17	Saturday	Open Recreation	Lower Tier	9:00 AM	5:00 PM	8	8:30 AM	5:30 PM	1	9	R-1
25-Nov-17	Saturday	Open Recreation	Lower Tier	9:00 AM	1:00 PM	4	8:30 AM	1:30 PM	1	5	R-3
26-Nov-17	Sunday	Open Recreation	Lower Tier	9:00 AM	12:00 PM	3	8:30 AM	12:30 PM	1	4	R-3
27-Nov-17	Monday	Open Recreation	Lower Tier	3:00 PM	8:00 PM	5	3:00 PM	8:30 PM	1	5.5	
28-Nov-17	Tuesday	Open Recreation	Lower Tier	3:00 PM	8:00 PM	5	3:00 PM	8:30 PM	1	5.5	
29-Nov-17	Wednesday	Open Recreation	Lower Tier	3:00 PM	8:00 PM	5	3:00 PM	8:30 PM	1	5.5	
30-Nov-17	Thursday	Open Recreation	Lower Tier	3:00 PM	8:00 PM	5	3:00 PM	8:30 PM	1	5.5	
1-Dec-17	Friday	Open Recreation	CANCELLED by DMAVA 31 OCT	<del>5:00 PM</del>	<del>9:00 PM</del>		4:30 PM	9:30 PM			R-3
4-Dec-17	Monday	Open Recreation	Lower Tier	3:00 PM	8:00 PM	5	3:00 PM	8:30 PM	1	5.5	
5-Dec-17	Tuesday	Open Recreation	Lower Tier	3:00 PM	8:00 PM	5	3:00 PM	8:30 PM	1	5.5	
6-Dec-17	Wednesday	Open Recreation	Lower Tier	3:00 PM	8:00 PM	5	3:00 PM	8:30 PM	1	5.5	
7-Dec-17	Thursday	Open Recreation	Lower Tier	3:00 PM	7:30 PM	4.5	3:00 PM	8:30 PM	1	5.5	
8-Dec-17	SDO FRIDAY	Open Recreation	Lower Tier	5:00 PM	9:00 PM	4.5	4:30 PM	9:30 PM	1	4.5	
10-Dec-17	Sunday	Special Event	Both Tiers & Lockerroom	7:00 AM	7:00 PM	12	6:30 AM	7:30 PM	1	13	
11-Dec-17	Monday	Open Recreation	Lower Tier	3:00 PM	8:00 PM	5	3:00 PM	8:30 PM	1	5.5	
12-Dec-17	Tuesday	Open Recreation	Lower Tier	3:00 PM	8:00 PM	5	3:00 PM	8:30 PM	1	5.5	
13-Dec-17	Wednesday	Open Recreation	Lower Tier	3:00 PM	8:00 PM	5	3:00 PM	8:30 PM	1	5.5	
14-Dec-17	Thursday	Open Recreation	Lower Tier	3:00 PM	8:00 PM	5	3:00 PM	8:30 PM	1	5.5	
15-Dec-17	Friday	Special Event	Both Tiers & Lockerroom	3:00 PM	11:00 PM	8	3:00 PM	11:30 PM	1	8.5	
16-Dec-17	Saturday	Open Recreation	Lower Tier	9:00 AM	1:00 PM	4	8:30 AM	1:30 PM	1	5	R-3
17-Dec-17	Sunday	Open Recreation	Lower Tier	9:00 AM	12:00 PM	3	8:30 AM	12:30 PM	1	4	R-3
18-Dec-17	Monday	Open Recreation	Lower Tier	3:00 PM	8:00 PM	5	3:00 PM	8:30 PM	1	5.5	
19-Dec-17	Tuesday	Open Recreation	Lower Tier	3:00 PM	8:00 PM	5	3:00 PM	8:30 PM	1	5.5	
20-Dec-17	Wednesday	Open Recreation	Lower Tier	3:00 PM	8:00 PM	5	3:00 PM	8:30 PM	1	5.5	
21-Dec-17	Thursday	Open Recreation	Lower Tier	3:00 PM	8:00 PM	5	3:00 PM	8:30 PM	1	5.5	
26-Dec-17	Tuesday	Open Recreation	Lower Tier	10:00 AM	3:00 PM	5					
27-Dec-17	Wednesday	Open Recreation	Lower Tier	10:00 AM	3:00 PM	5					
28-Dec-17	Thursday	Open Recreation	Lower Tier	10:00 AM	3:00 PM	5					
30-Dec-17	Saturday	Open Recreation	Lower Tier	9:00 AM	1:00 PM	4	8:30 AM	1:30 PM	1	5	R-3
31-Dec-17	Sunday	Open Recreation	Lower Tier	9:00 AM	12:00 PM	3	8:30 AM	12:30 PM	1	4	R-3
2-Jan-18	Tuesday	Open Recreation	Lower Tier	3:00 PM	8:00 PM	5	3:00 PM	8:30 PM	1	5.5	

**JERSEY CITY ARMORY**  
**Anticipated Use Schedule - CITY OF JERSEY CITY**  
**UA 18180 R-4**

15-Feb-18	Thursday	Open Recreation	Lower Tier	3:00 PM	8:00 PM	5	3:00 PM	8:30 PM	1	5.5	
16-Feb-18	SDO FRIDAY	Open Recreation	Lower Tier	5:00 PM	9:00 PM	4	4:30 PM	9:30 PM	1	5	
17-Feb-18	Saturday	Open Recreation	Lower Tier	10:00 AM	1:00 PM	3	9:30 AM	1:30 PM	1	4	R-4
18-Feb-18	Sunday	Open Recreation	Lower Tier	9:00 AM	12:00 PM	3	8:30 AM	12:30 PM	1	4	R-4
20-Feb-18	Tuesday	Open Recreation	Lower Tier	3:00 PM	8:00 PM	5	3:00 PM	8:30 PM	1	5.5	
21-Feb-18	Wednesday	Open Recreation	Lower Tier	3:00 PM	8:00 PM	5	3:00 PM	8:30 PM	1	5.5	
22-Feb-18	Thursday	Open Recreation	Lower Tier	3:00 PM	8:00 PM	5	3:00 PM	8:30 PM	1	5.5	
23-Feb-18	Friday	Open Recreation	Lower Tier	5:00 PM	9:00 PM	4	4:30 PM	9:30 PM	1	5	
24-Feb-18	Saturday	Special Event	Both Tiers & Lockerroom	7:00 AM	5:00 PM	10	6:30 AM	5:30 PM	1	11	R-2
26-Feb-18	Monday	Open Recreation	Lower Tier	3:00 PM	8:00 PM	5	4:30 PM	9:30 PM	1	5	
27-Feb-18	Tuesday	Open Recreation	Lower Tier	3:00 PM	8:00 PM	5	3:00 PM	8:30 PM	1	5.5	
28-Feb-18	Wednesday	Open Recreation	Lower Tier	3:00 PM	8:00 PM	5	3:00 PM	8:30 PM	1	5.5	
1-Mar-18	Thursday	Open Recreation	Lower Tier	3:00 PM	8:00 PM	5	3:00 PM	8:30 PM	1	5.5	
2-Mar-18	SDO FRIDAY	Open Recreation	Lower Tier	5:00 PM	9:00 PM	4	4:30 PM	9:30 PM	1	5	
3-Mar-18	Saturday	Open Recreation	Lower Tier	9:00 AM	1:00 PM	4	8:30 AM	1:30 PM	1	5	R-4
4-Mar-18	Sunday	Open Recreation	Lower Tier	9:00 AM	12:00 PM	3	8:30 AM	12:30 PM	1	4	R-4
5-Mar-18	Monday	Open Recreation	Lower Tier	3:00 PM	8:00 PM	5	3:00 PM	8:30 PM	1	5.5	
6-Mar-18	Tuesday	Open Recreation	Lower Tier	3:00 PM	8:00 PM	5	3:00 PM	8:30 PM	1	5.5	
7-Mar-18	Wednesday	Open Recreation	Lower Tier	3:00 PM	8:00 PM	5	3:00 PM	8:30 PM	1	5.5	
8-Mar-18	Thursday	Open Recreation	Lower Tier	3:00 PM	8:00 PM	5	3:00 PM	8:30 PM	1	5.5	
17-Mar-18	Saturday	Open Recreation	Lower Tier	9:00 AM	1:00 PM	4	8:30 AM	1:30 PM	1	5	R-4
18-Mar-18	Sunday	Open Recreation	Lower Tier	9:00 AM	12:00 PM	3	8:30 AM	12:30 PM	1	4	R-4
31-Mar-18	Saturday	Open Recreation	Lower Tier	9:00 AM	1:00 PM	4	8:30 AM	1:30 PM	1	5	R-4

425

480.5

Application Fee:	\$	75.00
Use Fee:		\$94,300.00
Armorer OT:		\$21,643.50
<b>Total Estimate:</b>	<b>\$</b>	<b>116,018.50</b>

425.00 Hrs @ \$220 per hour + \$50 per Lockerroom Use (8 Special Events)  
 480.50 Hrs @ \$47 per hour

**Revised Estimated Costs**

**JERSEY CITY ARMORY**  
**Anticipated Use Schedule - CITY OF JERSEY CITY**  
**UA 18180 R-4**

3-Jan-18	Wednesday	Open Recreation	Lower Tier	3:00 PM	8:00 PM	5	3:00 PM	8:30 PM	1	5.5	
4-Jan-18	Thursday	Open Recreation	Lower Tier	3:00 PM	8:00 PM	5	3:00 PM	8:30 PM	1	5.5	
5-Jan-18	Friday	Open Recreation	Lower Tier	5:00 PM	9:00 PM	4	4:30 PM	9:30 PM	1	5	
8-Jan-18	Monday	Open Recreation	Lower Tier	3:00 PM	8:00 PM	5	3:00 PM	8:30 PM	1	5.5	
9-Jan-18	Tuesday	Special Event	Both Tiers & Lockerroom	3:00 PM	11:00 PM	8	3:00 PM	11:30 PM	1	8.5	
10-Jan-18	Wednesday	Open Recreation	Lower Tier	3:00 PM	8:00 PM	5	3:00 PM	8:30 PM	1	5.5	
11-Jan-18	Thursday	Open Recreation	Lower Tier	3:00 PM	8:00 PM	5	3:00 PM	8:30 PM	1	5.5	
12-Jan-18	SDO FRIDAY	Open Recreation	NOT AVAILABLE FOR USE	5:00 PM	9:00 PM		4:30 PM	9:30 PM			
16-Jan-18	Tuesday	Special Event	Both Tiers & Lockerroom	3:00 PM	10:00 PM	7	3:00 PM	10:30 PM	1	7.5	
17-Jan-18	Wednesday	Open Recreation	Lower Tier	3:00 PM	8:00 PM	5	3:00 PM	8:30 PM	1	5.5	
18-Jan-18	Thursday	Open Recreation	Lower Tier	3:00 PM	8:00 PM	5	3:00 PM	8:30 PM	1	5.5	
19-Jan-18	Friday	Open Recreation	Lower Tier	5:00 PM	9:00 PM	4	4:30 PM	9:30 PM	1	5	
20-Jan-18	Saturday	Open Recreation	Lower Tier	9:00 AM	1:00 PM	4	8:30 AM	1:30 PM	1	5	R-4
21-Jan-18	Sunday	Open Recreation	Lower Tier	9:00 AM	12:00 PM	3	8:30 AM	12:30 PM	1	4	R-4
22-Jan-18	Monday	Open Recreation	Lower Tier	3:00 PM	8:00 PM	5	3:00 PM	8:30 PM	1	5.5	
23-Jan-18	Tuesday	Open Recreation	Lower Tier	3:00 PM	8:00 PM	5	3:00 PM	8:30 PM	1	5.5	
24-Jan-18	Wednesday	Open Recreation	Lower Tier	3:00 PM	8:00 PM	5	3:00 PM	8:30 PM	1	5.5	
25-Jan-18	Thursday	Open Recreation	Lower Tier	3:00 PM	8:00 PM	5	3:00 PM	8:30 PM	1	5.5	
26-Jan-18	SDO FRIDAY	Special Event	Both Tiers & Lockerroom	3:00 PM	11:00 PM	8	2:30 PM	11:30 PM	1	9	
29-Jan-18	Monday	Open Recreation	Lower Tier	3:00 PM	8:00 PM	5	3:00 PM	8:30 PM	1	5.5	
30-Jan-18	Tuesday	Open Recreation	Lower Tier	3:00 PM	8:00 PM	5	3:00 PM	8:30 PM	1	5.5	
31-Jan-18	Wednesday	Open Recreation	Lower Tier	3:00 PM	8:00 PM	5	3:00 PM	8:30 PM	1	5.5	
1-Feb-18	Thursday	Special Event	Both Tiers & Lockerroom	3:00 PM	11:00 PM	8	3:00 PM	8:30 PM	1	5.5	
2-Feb-18	Friday	Open Recreation	Lower Tier	5:00 PM	9:00 PM	4	4:30 PM	9:30 PM	1	5	
5-Feb-18	Monday	Open Recreation	Lower Tier	3:00 PM	8:00 PM	5	3:00 PM	8:30 PM	1	5.5	
6-Feb-18	Tuesday	Open Recreation	Lower Tier	3:00 PM	8:00 PM	5	3:00 PM	8:30 PM	1	5.5	
7-Feb-18	Wednesday	Open Recreation	Lower Tier	3:00 PM	8:00 PM	5	3:00 PM	8:30 PM	1	5.5	
8-Feb-18	Thursday	Open Recreation	Lower Tier	3:30 PM	8:00 PM	5	3:00 PM	8:30 PM	1	5.5	
9-Feb-18	Friday	Open Recreation	Lower Tier	5:00 PM	9:00 PM	4	4:30 PM	9:30 PM	1	5	
11-Feb-18	Sunday	Special Event	Both Tiers & Lockerroom	7:00 AM	7:00 PM	12	6:30 AM	7:30 PM	1	13	
13-Feb-18	Tuesday	Open Recreation	Lower Tier	3:00 PM	8:00 PM	5	3:00 PM	8:30 PM	1	5.5	
14-Feb-18	Wednesday	Open Recreation	Lower Tier	3:00 PM	8:00 PM	5	3:00 PM	8:30 PM	1	5.5	

- 17 Board Meeting
- 21 Martin Luther King, Jr. Day – District Closed
- 31 End of MP 2
- 31 Half-Day Session For Students, PD for Teachers

**February**

- 5 High School Parent Conference 1:30-3pm, 12:45 Dismissal HS only
- 6 Elementary School Parent Conference 1:30-3pm, 12:45 Dismissal ES only
- 7 Middle School Parent Conference 1:30-3pm, 12:45 Dismissal MS only
- 18 Presidents' Day – District Closed
- 19 Board Caucus
- 21 Board Meeting

**March**

- 1 Read Across America Day
- 4-8 Sneak-A-Peak Week (Elementary Schools)
- 19 Board Caucus
- 21 Board Meeting

**April**

- 5 End of MP 3
- 9 Middle School Report Card Night, 6:30-8:00
- 10 High School Report Card Night, 6:30-8:00
- 11 Elementary School Report Card Night, 6:30-8:00
- 11 Board Caucus\*\*
- 16 Board Meeting\*\*
- 18 Half-Day Session, 12:45 Dismissal
- 19 Good Friday – District Closed
- 22-28 Spring Recess, Schools Closed, Central Office Open
- 29 Schools Reopen

**May**

- 14 Board Caucus
- 16 Board Meeting
- 24 Half Day Session for Schools-12:45 Dismissal
- 27 Memorial Day-District Closed

**June**

- 4 Eid-al-Fitr - PD Day for Teachers, No classes for students, CO open
- 17-19 Contractual Half-Day Sessions if no emergency days needed
- 18 Board Caucus
- 20 Board Meeting
- 20-24 Emergency Days

**July**

- 3 Last day for Administrators if 5 flex days used and no emergency days
- 4 Independence Day-District Closed
- 11 Last day for Administrators if no flex days used and no emergency days

\* Dates listed works best to allow the district to build agenda

\*\* Proposed changes out of respect for religious holidays

## Approved Calendar – Jersey City Public Schools 2018-2019

### August

- 20 Administrators return
- 28\* Board Caucus
- 30\* Board Meeting

### September

- 3 Labor Day – District Closed
- 4 & 5 Staff In-Service PD-No Students
- 6 First Day of School For Students
- 12 Elementary Parent Orientation
- 13 Middle School Parent Orientation
- 20 High School Parent Orientation
- 25\*\* Board Caucus
- 27\*\* Board Meeting
- 29 "I Love Jersey City Public Schools" Back-to-School Festival (Saturday)

### October

- 8 Columbus Day – District Closed
- 16 Board Caucus
- 18 Board Meeting
- 22-25 NJ School Boards Association Convention

### November

- 6 Election Day – District Closed
- 7 Diwali-Face-Off Professional Development – No Classes for Students
- 8-9 NJEA Convention - Schools Closed, CO open
- 12 Veterans' Day Observed-District Closed
- 13 Board Caucus
- 15 End of MP I
- 15 Board Meeting
- 21 Half-Day Session, 12:45 Dismissal
- 22-23 Thanksgiving Recess-District Closed
- 27 High School Report Card Night – 6:30-8:00
- 28 Middle School Report Card Night – 6:30-8:00
- 29 Elementary School Report Card Night – 6:30-8:00

### December

- 18 Board Caucus
- 20 Board Meeting
- 21 Half-Day Session, 12:45 Dismissal
- 24 Christmas Eve-District Closed
- 25 Christmas Day – District Closed
- 26-28 Winter Recess – Schools Closed, Central Office open
- 31 New Year's Eve – District Closed

### January

- 1 New Year's Day – District Closed
- 2 Schools Reopen
- 8 Reorganization Meeting
- 15 Board Caucus



Joe Macchi

From: John Nagel  
Sent: Thursday, September 06, 2018 4:08 PM  
To: Joe Macchi  
Subject: FW: JC Armory - Nov. 2018  
Attachments: sept oct nov.docx

More to follow

At leisure send me a Caven Point FB schedule thanks

From: Matthew Hogan  
Sent: Thursday, September 6, 2018 2:30 PM  
To: John Nagel <NagelJ@icni.org>  
Subject: RE: JC Armory - Nov. 2018

John E. -

Attached is the calendar.  
Check winter info below and we can discuss the rec and jc day/dates.

I would defer to John Nagel to CONFIRM the dates but the proposed and/or corresponding dates are:

Day	Date	Meet	Start	End	NOTES /
Request					
Fri	12/14/18	JC Rec -Leon Bailey Relays	4:00 pm	10:00 pm	track and infield,
		hurdles, HJ, access to full upper deck, bathrooms			
Tues	1/8/19	HCTCA -HC Relays	4:00 pm	8:00 pm	track and infield,
		hurdles, HJ, access to full upper deck, bathrooms			
	TBA	HCTCA -Jersey City Champs	4:00 pm	8:00 pm	track and infield,
		hurdles, HJ, access to full upper deck, bathrooms			
Fri	TBA	JC Rec -Bill Reid Memorial	4:00 pm	10:00 pm	track and infield,
		hurdles, HJ, access to full upper deck, bathrooms			
Fri	TBA	JC Rec -Ed Grant Last Chance	4:00 pm	10:00 pm	track and infield,
		hurdles, HJ, access to full upper deck, bathrooms			

Regards,  
Matt Hogan, Risk Mgr.

Office of Risk Mgmt.  
280 Grove Street - Room 320  
Jersey City, NJ 07302  
TEL: 201.547.5034  
FAX: 201.547.4761  
E-MAIL: [matthew@icni.org](mailto:matthew@icni.org)



JAN. / Feb. 2019  
TBA

From: Joe Macchi  
Sent: Friday, August 31, 2018 9:06 AM  
To: Matthew Hogan <Matthew@icni.org>; John Nagel <NagelJ@icni.org>  
Cc: Arthur J. Williams <AJWilliams@icni.org>; Simuel Wilson <SWilson@icni.org>; Donna Ward <DWard@icni.org>;  
Jephthe Zayas <JZayas@icni.org>  
Subject: JC Armory - Nov. 2018

On behalf of Dir. Arthur Williams/Dept. of Recreation, we are in the process of securing the JC Armory for numerous Recreation Programs & Activities.  
As you are aware; this facility is home to all public/non-public schools track teams and additional sports.  
The tentative schedule : Monday through Friday Nov. 26, 2018 till March 15, 2019- possible additional dates depending on event.  
As in previous years; Recreation has partnered w/Hudson County-Jersey City Track Association w/access for your events.  
Inquiring if you have any of those dates yet? If not no problem.  
The annual meeting, TBA, will address all logistics related to track meets and any other issues/concerns.  
Appreciate cooperation-- be in touch thx

## Alita Carter

---

**From:** Joe Macchi  
**Sent:** Wednesday, October 03, 2018 3:50 PM  
**To:** Tamika McReynolds; Melissa Troncoso; Simuel Wilson; Gary Nye; Jephthe Zayas; Donna Ward; Ronald Uttariello; Andrew Kemp; Frank Gilmore; Alita Carter  
**Cc:** Arthur J. Williams; Sabrina Harrold; Daniel Ali  
**Subject:** RE: JC Armory Nov. 2018-March 2019

Alita,

As discussed; if you can prepare Reso- previous email below dated--- Sept. 18, 2018 contained 2017 documents. The following, in my view, would be changes to new Reso:

Paragraph # 3 - DMVA permits City use of Armory:

--new dates Nov. 24, 2018 through March 8, 2019 total user fees = TBA ? awaiting total amount/ new contract from DMVA

Paragraph # 4 - period of Nov. 26 until Dec. 28, 2018 fee will be approx. TBA available in account # (Simuel and/or Donna pls. advise)

Paragraph # 5 -period of Jan 2 until March 8, 2019 fee will be TBA/balance of amount from account # (above)

Page 2- will change dates & total amount----

Page 3- Project manager & required signature of Director Arthur Williams.

Should anyone have any questions/concerns or amendments--- pls. advise---  
much appreciated--- thx

---

**From:** Joe Macchi  
**Sent:** Tuesday, September 18, 2018 2:47 PM  
**To:** Tamika McReynolds; Melissa Troncoso; Simuel Wilson; Gary Nye; Jephthe Zayas; Donna Ward; Ronald Uttariello; Andrew Kemp; Frank Gilmore; Alita Carter  
**Cc:** Arthur J. Williams; Sabrina Harrold; Daniel Ali  
**Subject:** FW: JC Armory Nov. 2018-March 2019

One of the issues discussed @ yesterdays- Sept. 17- meeting was the JC Armory/NJDMVA schedule for upcoming Nov. 2018-March 2019 season.

They were numerous documents on file; additionally able to ascertain other paperwork related to schedule/agreement. Pls. refer to attachments, in no particular order, are the following:

1. Email from John Nagel/Matt Hogan - liaison to High School Track Coaches + responsible for events. They have scheduled 2 meets so far; I spoke w/Matt this morning- requested until Friday for three remaining dates. (probably Jan/Feb. 2019)

2. Spring Sports Expo - conducted last year Feb. 24, 2018- if approved will be Feb. 23, 2019.

3. Approved Reso from Oct. 2017; will require new document w/dates, costs and related information.

4. Copy of agreement/Revision # 4 w/schedule, fees/cost, and other requirements.

5. Draft schedule - opening date : Monday Nov. 26, 2018 concluding March 8, 2019; pls. note the present schedule does not list any Saturday(s) or Sunday(s) unless special event.

There are three dates from High School + Youth Track events , I spoke w/Andy Kemp he is communicating w/Coach George Chislom, that are not included - will be added when confirmed/notified.

The daily schedule is - Monday through Friday from 3pm-8pm ; unless indicated.

6. City of JC holiday schedule

7. JC Public Schools calendar

We must submit to Ms. Jill Priar/NJDMVA requested schedule of all dates & times based upon approval; invoice/bill will be sent to Recreation.

New Reso is required must include : schedule, cost and other related information.  
Pls. review all documents/related information and advise to any changes/suggestions.  
If anyone was omitted ; pls. forward email.  
Appreciate everyone's cooperation--- be in touch thx

---

**From:** Joe Macchi  
**Sent:** Tuesday, September 18, 2018 11:41 AM  
**To:** Joe Macchi  
**Subject:** JC Armory Nov. 2018-March 2019

## Alita Carter

---

**From:** Joe Macchi  
**Sent:** Tuesday, September 18, 2018 2:47 PM  
**To:** Tamika McReynolds; Melissa Troncoso; Simuel Wilson; Gary Nye; Jephthe Zayas; Donna Ward; Ronald Uttariello; Andrew Kemp; Frank Gilmore; Alita Carter  
**Cc:** Arthur J. Williams; Sabrina Harrold; Daniel Ali  
**Subject:** FW: JC Armory Nov. 2018-March 2019  
**Attachments:** 2018\_09\_18\_11\_38\_58.pdf

One of the issues discussed @ yesterdays- Sept. 17- meeting was the JC Armory/NJDMVA schedule for upcoming Nov. 2018-March 2019 season.

They were numerous documents on file; additionally able to ascertain other paperwork related to schedule/agreement. Pls. refer to attachments, in no particular order, are the following:

1. Email from John Nagel/Matt Hogan – liaison to High School Track Coaches + responsible for events. They have scheduled 2 meets so far; I spoke w/Matt this morning- requested until Friday for three remaining dates. (probably Jan/Feb. 2019)
2. Spring Sports Expo – conducted last year Feb. 24, 2018- if approved will be Feb. 23, 2019.
3. Approved Reso from Oct. 2017; will require new document w/dates, costs and related information.
4. Copy of agreement/Revision # 4 w/schedule, fees/cost, and other requirements.
5. Draft schedule – opening date : Monday Nov. 26, 2018 concluding March 8, 2019; pls. note the present schedule does not list any Saturday(s) or Sunday(s) unless special event.

There are three dates from High School + Youth Track events , I spoke w/Andy Kemp he is communicating w/Coach George Chislom, that are not included – will be added when confirmed/notified.

The daily schedule is – Monday through Friday from 3pm-8pm ; unless indicated.

6. City of JC holiday schedule
7. JC Public Schools calendar

We must submit to Ms. Jill Priar/NJDMVA requested schedule of all dates & times based upon approval; invoice/bill will be sent to Recreation.

New Reso is required must include : schedule, cost and other related information.

Pls. review all documents/related information and advise to any changes/suggestions.

If anyone was omitted ; pls. forward email.

Appreciate everyone's cooperation--- be in touch thx

---

**From:** Joe Macchi  
**Sent:** Tuesday, September 18, 2018 11:41 AM  
**To:** Joe Macchi  
**Subject:** JC Armory Nov. 2018-March 2019



STEVEN M. FULOP  
MAYOR OF JERSEY CITY

CITY OF JERSEY CITY  
DEPARTMENT OF ADMINISTRATION

CITY HALL | 280 GROVE STREET | JERSEY CITY, NJ 07302  
P: 201 547 5147 | F: 201 547 4833



ROBERT J. KAKOLESKI  
BUSINESS ADMINISTRATOR

MEMORANDUM

DATE : October 5, 2017  
TO : ALL DEPARTMENT DIRECTORS  
FROM : ROBERT J. KAKOLESKI, BUSINESS ADMINISTRATOR  
SUBJECT : HOLIDAYS - CALENDAR YEAR 2018

PLEASE POST

Holiday	Day	Date
New Year's Day	Monday	January 1
Martin Luther King, Jr.'s Birthday	Monday	January 15
Lincoln's Birthday	Monday	February 12
President's Day	Monday	February 19
Good Friday	Friday	March 30
Memorial Day	Monday	May 28
Independence Day	Wednesday	July 4
Labor Day	Monday	September 3
Columbus Day	Monday	October 8
Election Day	Tuesday	November 6
Veterans' Day (OBSERVED)	Monday	November 12*
Thanksgiving Day	Thursday	November 22
Friday after Thanksgiving	Friday	November 23
Christmas	Tuesday	December 25

As you know, this only applies to employees covered by contracts which specifically grant the days as holidays. Department directors are responsible for seeing that essential services are performed.

c: Hon. Steven Fulop, Mayor  
Rolando Lavarro, Council President and Members of Municipal Council  
Robert Byrne, City Clerk

\*Note: Statutory holidays falling on a Saturday shall be celebrated on the preceding Friday.  
Statutory holidays falling on a Sunday shall be celebrated on the following Monday.



MAYOR STEVEN M. FULOP  
 THE JERSEY CITY MUNICIPAL COUNCIL  
 AND THE DEPARTMENT OF RECREATION  
 PRESENT

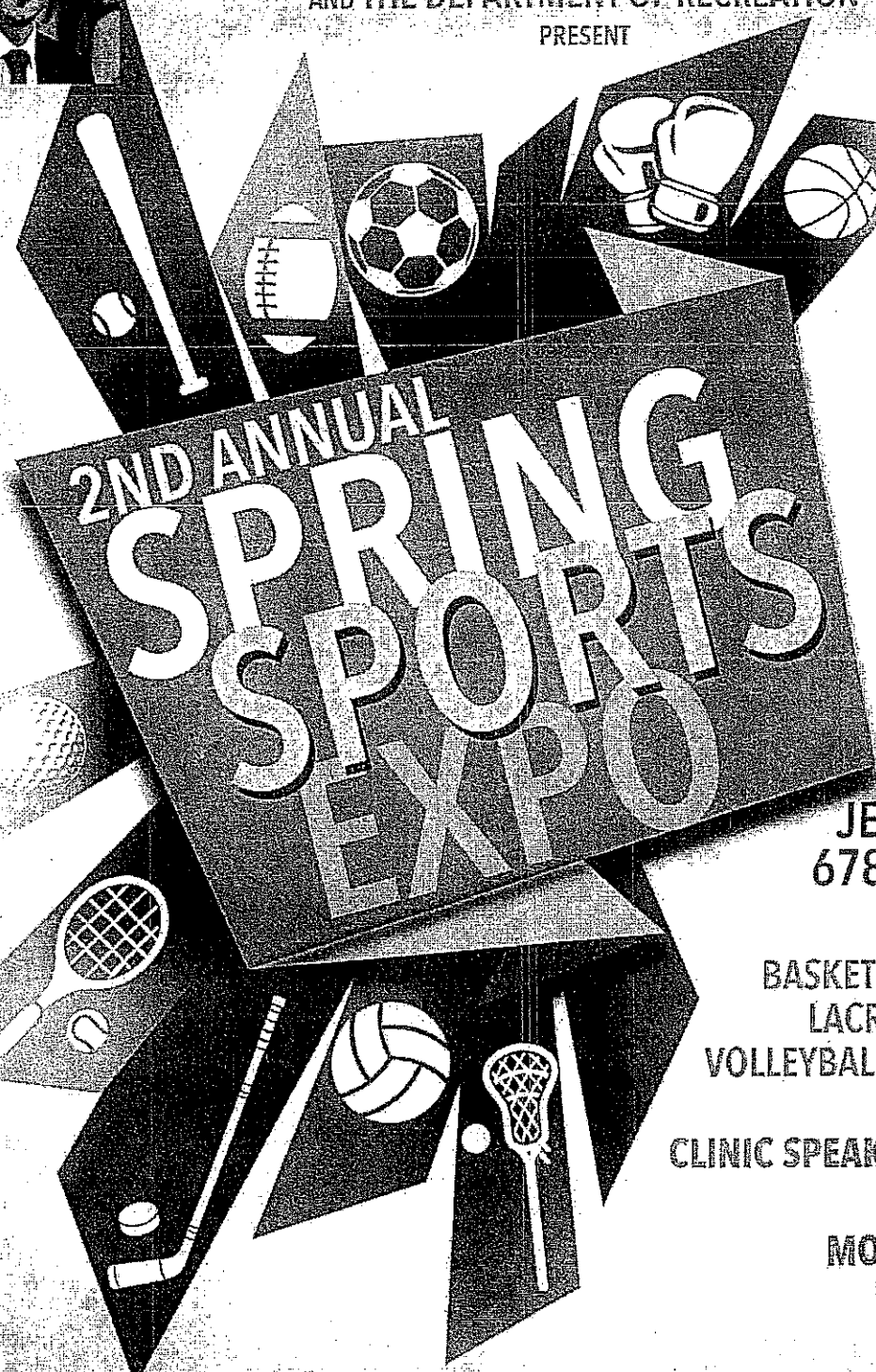
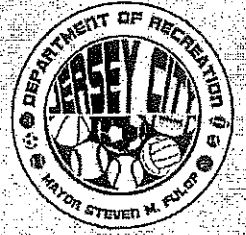

**SATURDAY  
 FEB 24TH  
 2018  
 9AM-2PM**

**JERSEY CITY ARMORY  
 678 MONTGOMERY ST.**

CLINICS PROVIDED FOR  
 BASKETBALL, SOCCER, HOCKEY,  
 LACROSSE, TENNIS, BOXING,  
 VOLLEYBALL, FOOTBALL AND MORE

**CLINIC SPEAKERS | ORGANIZATIONS  
 OPEN TO THE PUBLIC  
 MORE TO BE ANNOUNCED**

LET'S BRING THE WARDS TOGETHER TO MAKE A GREAT DAY FOR OUR KIDS AND FAMILIES.  
**Space is limited first come first serve basis. Please RSVP to [ecupo@jcnj.org](mailto:ecupo@jcnj.org).**

**VENDORS WANTED**

FOR MORE INFORMATION: CALL 201 547 5003 | EMAIL [RECREATION@JCNJ.ORG](mailto:RECREATION@JCNJ.ORG) | VISIT [WWW.JCREC.RECDESK.COM](http://WWW.JCREC.RECDESK.COM)

NOT A SCHOOL DISTRICT SPONSORED PROGRAM



THE CITY OF JERSEY CITY  
 MAYOR STEVEN M. FULOP  
 THE MUNICIPAL COUNCIL  
 THE DEPARTMENT OF RECREATION

JerseyCityNJ  
 JC\_GOV  
 jerseycitynj

# Resolution of the City of Jersey City, N.J.

City Clerk File No. Res. 17-797  
Agenda No. 10.H  
Approved: OCT 11 2017  
TITLE:



**RESOLUTION AUTHORIZING THE EXECUTION OF A MEMORANDUM OF UNDERSTANDING WITH THE STATE OF NEW JERSEY DEPARTMENT OF MILITARY AND VETERANS AFFAIRS PERMITTING THE CITY OF JERSEY CITY TO USE THE NATIONAL GUARD ARMORY AT 678 MONTGOMERY STREET, JERSEY CITY, NEW JERSEY**

**COUNCIL OFFERED AND MOVED ADOPTION OF THE FOLLOWING RESOLUTION:**

**WHEREAS**, the State of New Jersey, Department of Military and Veterans Affairs ("DMVA") is the owner of the National Guard Armory located at 678 Montgomery Street, Jersey City, New Jersey ("Armory"); and

**WHEREAS**, the City of Jersey City ("City") desires to use the Armory to provide structured recreational programs and activities for the benefit of the children and adults of Jersey City; and

**WHEREAS**, the DMVA agrees to permit the City to use the Armory for the period effective as of November 27, 2017 through March 8, 2018 provided the City pays a total user fee of \$97,521; and

**WHEREAS**, for the period of November 27, 2017 through December 31, 2017 the user fee will be the approximately \$27,000 which is available in account 17-10-201-28-370-304; and

**WHEREAS**, for the period of January 1, 2018 through March 8, 2018 the user fee will be approximately \$70,521 and will be subject to the availability and appropriation of funds in the fiscal year 2018 temporary and permanent budgets in account number 18-01-201-28-370-304; and

**WHEREAS**, the Armory will enable the Department of Recreation to accommodate approximately 500 children per night for various recreational programs; and

**WHEREAS**, the City desires to execute a memorandum of understanding with DMVA authorizing the City to use the Armory; and

**WHEREAS**, the City is authorized to execute a memorandum of understanding with another public body pursuant to N.J.S.A. 40A:11-5(2) of the Local Public Contracts Laws;

**NOW THEREFORE, BE IT RESOLVED**, by the Municipal Council of the City of Jersey City that:

**Resolution Fact Sheet:**

This summary sheet is to be attached to the front of any resolution that is submitted for the Council consideration. Incomplete or vague fact sheets will be returned with the resolution.

**Full Title of Ordinance/Resolution**

**RESOLUTION AUTHORIZING THE EXECUTION OF A MEMORADUM OF UNDERSTANDING WITH THE STATE OF NEW JERSEY DEPARTMENT OF MILITARY AND VETERANS AFFAIRS PERMITTING THE CITY OF JERSEY CITY TO USE THE NATIONAL GUARD ARMORY AT 678 MONTGOMERY STREET, JERSEY CITY, NEW JERSEY**

**Project Manager**

Department/Division	Department of Recreation	
Name/Title	Kevin Williamson	Director
Phone/email	201-547-4537	kwilliamson@jcnj.org

**Resolution Purpose**

To provide structured recreational programs and activities for the benefit of the children and adults of Jersey City. These activities comprise of such programs as football programs, boxing programs, tennis programs, and various indoor recreational activities for youth and seniors.

I certify that all facts presented herein are accurate.

  
\_\_\_\_\_  
Signature of Department Director



# Resolution of the City of Jersey City, N.J.

City Clerk File No. Res. 17-797

pg 2

Agenda No. 10-H

Approved: OCT 11 2017

TITLE:



**RESOLUTION AUTHORIZING THE EXECUTION OF A MEMORANDUM OF UNDERSTANDING WITH THE STATE OF NEW JERSEY DEPARTMENT OF MILITARY AND VETERANS AFFAIRS PERMITTING THE CITY OF JERSEY CITY TO USE THE NATIONAL GUARD ARMORY AT 678 MONTGOMERY STREET, JERSEY CITY, NEW JERSEY**

1. The Mayor or Business Administrator is authorized to execute the memorandum of understanding and other documents attached hereto, with the State of New Jersey Department of Military and Veterans Affairs;
  2. The term of the Use Agreement shall be effective as of November 27, 2017 through March 8, 2018 and the City shall pay the State of New Jersey Department of Military and Veterans Affairs the total user fee of \$97,521; and
  3. Pursuant to N.J.A.C. 5:30-5.5(e), the continuation of the Use Agreement after the expenditure of funds encumbered in the fiscal year 2017 budget shall be subject to the availability and appropriation of sufficient funds in the fiscal year 2018 temporary and permanent budgets.
- I, Donna Mauer Donna Mauer, Chief Financial Officer, certify that funds in the amount of \$27,000.00 are available in account number 17-01-201-28-370-304. P.O # 126652

APPROVED: [Signature] APPROVED AS TO LEGAL FORM [Signature] P.R. a. 2. 2. 2.

APPROVED: [Signature] Business Administrator [Signature] Corporation Counsel

Certification Required  Not Required  APPROVED 8-0

RECORD OF COUNCIL VOTE ON FINAL PASSAGE 10.11.17											
COUNCILPERSON	AYE	NAY	N.V.	COUNCILPERSON	AYE	NAY	N.V.	COUNCILPERSON	AYE	NAY	N.V.
GAJEWSKI	/			YUN	/			RIVERA		ABSENT	
GADSDEN	/			OSBORNE	/			WATTMAN	/		
BOGGIANO	/			ROBINSON	/			LAVARRO, PRES	/		

Indicates Vote N.V.-Not Voting (Abstain)

Adopted at a meeting of the Municipal Council of the City of Jersey City N.J.

[Signature] Robert R. Lavarno, Jr., President of Council [Signature] Robert Byrns, City Clerk

# Resolution of the City of Jersey City, N.J.

City Clerk File No. Res. 18-976

Agenda No. 10.Q

Approved: NOV 07 2018



TITLE: **A RESOLUTION SUBMITTING A STRATEGIC PLAN TO THE GOVERNOR'S COUNCIL ON ALCOHOLISM AND DRUG ABUSE FOR FISCAL GRANT CYCLE JULY 2014 - JUNE 2020**

**COUNCIL** Offered and Moved Adoption of the Following Resolution:

**WHEREAS**, the Governor's Council on Alcoholism and Drug Abuse established the Municipal Alliances for the Prevention of Alcoholism and Drug Abuse in 1989 to educate and engage residents, local government and law enforcement officials, schools, nonprofit organizations, the faith community, parents, youth and other allies in efforts to prevent alcoholism and drug abuse in communities throughout New Jersey; and,

**WHEREAS**, the Jersey City Municipal Council recognizes that the abuse of alcohol and drugs is a serious problem in our society among persons of all ages, and therefore has an established Municipal Alliance Committee; and,

**WHEREAS**, the Jersey City Municipal Council further recognizes that it is incumbent upon not only public officials but the entire community to take action to prevent such abuses in our community; and,

**WHEREAS**, the Jersey City Municipal Council has applied for funding to the Governor's Council on Alcoholism and Drug Abuse through the County of Hudson;

**NOW, THEREFORE, BE IT RESOLVED** that the Jersey City Municipal Council hereby recognizes the following:

- The Jersey City Municipal Council does hereby authorize submission of a strategic plan for the Jersey City Municipal Alliance grant year July 1, 2019 to June 30, 2020 in the amount of:
 

DEDR	\$ 213,903.00
Cash Match	\$ 53,476.00
In-Kind	\$ 160,427.00
- The Jersey City Municipal Council acknowledges the terms and conditions for administering the Municipal Alliance grant, including the administrative compliance and audit requirements.
- The Mayor or Business Administrator is authorized to execute the strategic plan and any other documents necessary to effectuate the purpose of this resolution.

APPROVED:   
 Business Administrator

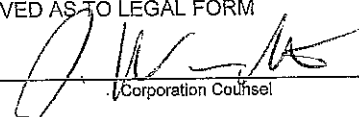
APPROVED AS TO LEGAL FORM  
  
 Corporation Counsel

Certification Required   
 Not Required

APPROVED 8-0

RECORD OF COUNCIL VOTE ON FINAL PASSAGE 11.7.18											
COUNCILPERSON	AYE	NAY	N.V.	COUNCILPERSON	AYE	NAY	N.V.	COUNCILPERSON	AYE	NAY	N.V.
RIDLEY	✓			YUN	✓			RIVERA	✓		
PRINZ-AREY	✓			SOLOMON	✓			WATTERMAN	ABSENT		
BOGGIANO	✓			ROBINSON	✓			LAVARRO, PRES.	✓		

✓ Indicates Vote

N.V.-Not Voting (Abstain)

Adopted at a meeting of the Municipal Council of the City of Jersey City N.J.

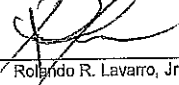
  
 Rolando R. Lavarro, Jr., President of Council

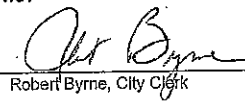
  
 Robert Byrne, City Clerk

**RESOLUTION FACT SHEET – NON-CONTRACTUAL**

This summary sheet is to be attached to the front of any resolution that is submitted for Council consideration. Incomplete or vague fact sheets will be returned with the resolution.

**Full Title of Ordinance/Resolution**

**A RESOLUTION SUBMITTING A STRATEGIC PLAN TO THE GOVERNOR'S COUNCIL ON ALCOHOLISM AND DRUG ABUSE FOR FISCAL GRANT CYCLE JULY 2014 - JUNE 2020**

**Initiator**

Department/Division	Health & Human Services	Partnership for a Healthier JC
Name/Title	Maryanne Kelleher	Partnership Director
Phone/email	(201) 547 5024	MKelleher@jcj.org

Note: Initiator must be available by phone during agenda meeting (Wednesday prior to council meeting @ 11:00am)

**Resolution Purpose**

This resolution submits a strategic plan to Hudson County HHS for the 2019-2020 Municipal Alliance budget.

I certify that all the facts presented herein are accurate.

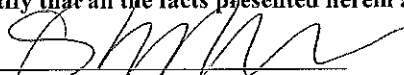
  
Signature of Department Director

10/31/18  
Date

# Resolution of the City of Jersey City, N.J.

City Clerk File No. Res. 18-977

Agenda No. 10.R

Approved: NOV 07 2018

TITLE:



**ENABLING RESOLUTION AUTHORIZING THE EXECUTION OF A GRANT AGREEMENT AND THE ACCEPTANCE OF A GRANT AWARD FROM THE SUBSTANCE ABUSE AND MENTAL HEALTH SERVICES ADMINISTRATION (SAMHSA)**

**COUNCIL** offered and moved adoption of the following resolution:

**WHEREAS**, the Substance Abuse and Mental Health Services Administration ("SAMHSA") provides grants to municipal governments for Mental Health Awareness Training; and

**WHEREAS**, the City of Jersey City ("the City") has devised a plan to implement mental health awareness training by accepting a grant of \$375,000 from SAMHSA, and will target these trainings to non-profit and public employees who interact regularly with the public; and

**WHEREAS**; the City is willing to use the SAMHSA's funds in accordance with such rules, regulations and applicable statutes, and is willing to enter into an agreement with SAMHSA for the above named project;

**NOW, THEREFORE BE IT RESOLVED**, by the Municipal Council of the City of Jersey City that:

1. the Mayor is hereby authorized to execute an agreement and any amendment thereto with SAMHSA known as Jersey City Mental Health Awareness Training (MHAT);
2. the City agrees to comply with all applicable federal, state and local laws, rules, and regulations in its performance of the project; and,
3. this resolution shall take effect immediately.

*JMcK  
10/21/18*

APPROVED: [Signature]

APPROVED AS TO LEGAL FORM

APPROVED: [Signature]  
Business Administrator

[Signature]  
Corporation Counsel

Certification Required

Not Required

APPROVED 8-0

RECORD OF COUNCIL VOTE ON FINAL PASSAGE 11.7.18											
COUNCILPERSON	AYE	NAY	N.V.	COUNCILPERSON	AYE	NAY	N.V.	COUNCILPERSON	AYE	NAY	N.V.
RIDLEY	✓			YUN	✓			RIVERA	✓		
PRINZ-AREY	✓			SOLOMON	✓			WATTERMAN	ABSENT		
BOGGIANO	✓			ROBINSON	✓			LAVARRO, PRES.	✓		

✓ Indicates Vote

N.V.-Not Voting (Abstain)

Adopted at a meeting of the Municipal Council of the City of Jersey City N.J.

[Signature]  
Rolando R. Lavarro, Jr., President of Council

[Signature]  
Robert Byrne, City Clerk

**RESOLUTION FACT SHEET - CONTRACT AWARD**

This summary sheet is to be attached to the front of any resolution that is submitted for Council consideration. Incomplete or vague fact sheets will be returned with the resolution.

**Full Title of Ordinance/Resolution**

**ENABLING RESOLUTION AUTHORIZING THE EXECUTION OF A GRANT AGREEMENT AND THE ACCEPTANCE OF A GRANT AWARD FROM THE SUBSTANCE ABUSE AND MENTAL HEALTH SERVICES ADMINISTRATION (SAMHSA)**

**Project Manager**

Department/Division	Health & Human Services	Injury Prevention
Name/Title	Paul Bellan-Boyer	Director, Injury Prevention
Phone/email	(201) 547 5114	PBellan-Boyer@jcnj.org

Note: Project Manager must be available by phone during agenda meeting (Wednesday prior to council meeting @ 4:00 p.m.)

**Contract Purpose**

This resolution accepts a grant from SAMHSA to conduct mental health awareness training over the course of three years. The grant award is in the amount of \$125,000 per year for each of the three years. Our goal is the work with public sector and non-profit employees and volunteers who come in regular contact with members of the general public.

**Cost (Identify all sources and amounts)**

Grant Award: \$125,000 annual for three years, for a total award amount of \$375,000

**Contract term (include all proposed renewals)**

January 1, 2019 through December 31, 2021

Type of award

If "Other Exception", enter type

**Additional Information**

Jersey City is one of only five municipalities across the country to receive this award. There is no requirement for matching funds.

I certify that all the facts presented herein are accurate.

  
Signature of Department Director

10/25/18  
Date



Notice of Award

Mental Health Awareness Training Grants  
Department of Health and Human Services  
Substance Abuse and Mental Health Services Administration

Issue Date: 09/18/2018

Center for Mental Health Services

**Grant Number:** 1H79SM081206-01  
**FAIN:** H79SM081206  
**Program Director:** Paul Bellan-Boyer

**Project Title:** Jersey City Mental Health Awareness Training Program

<b>Grantee Address</b>	<b>Business Address</b>
CITY OF JERSEY CITY Paul Bellan-Boyer  280 Grove Street Jersey City, NJ 073023610	Brian Platt City of Jersey City 280 Grove Street Jersey City, NJ 073023610

**Budget Period:** 09/30/2018 – 09/29/2019

**Project Period:** 09/30/2018 – 09/29/2021

Dear Grantee:

The Substance Abuse and Mental Health Services Administration hereby awards a grant in the amount of \$125,000 (see "Award Calculation" in Section I and "Terms and Conditions" in Section III) to CITY OF JERSEY CITY in support of the above referenced project. This award is pursuant to the authority of under Section 520J of the PHS Act(42USC 290bb-41) as amended and is subject to the requirements of this statute and regulation and of other referenced, incorporated or attached terms and conditions.

Award recipients may access the SAMHSA website at [www.samhsa.gov](http://www.samhsa.gov) (click on "Grants" then SAMHSA Grants Management), which provides information relating to the Division of Payment Management System, HHS Division of Cost Allocation and Postaward Administration Requirements. Please use your grant number for reference.

Acceptance of this award including the "Terms and Conditions" is acknowledged by the grantee when funds are drawn down or otherwise obtained from the grant payment system.

If you have any questions about this award, please contact your Grants Management Specialist and your Government Project Officer listed in your terms and conditions.

Sincerely yours,  
Gwendolyn Simpson  
Grants Management Officer  
Division of Grants Management

See additional information below

**SECTION I – AWARD DATA – 1H79SM081206-01**

**Award Calculation (U.S. Dollars)**

Salaries and Wages	\$34,500
Personnel Costs (Subtotal)	\$34,500
Materials & Supplies	\$17,502
Contractual	\$72,300
Travel	\$698
 Direct Cost	 \$125,000
<b>Approved Budget</b>	<b>\$125,000</b>
Federal Share	\$125,000
Cumulative Prior Awards for this Budget Period	\$0
 <b>AMOUNT OF THIS ACTION (FEDERAL SHARE)</b>	 <b>\$125,000</b>

SUMMARY TOTALS FOR ALL YEARS	
YR	AMOUNT
1	\$125,000
2	\$125,000
3	\$125,000

\*Recommended future year total cost support, subject to the availability of funds and satisfactory progress of the project.

**Fiscal Information:**

CFDA Number: 93.243  
 EIN: 1226002013A3  
 Document Number: 18SM81206A  
 Fiscal Year: 2018

IC	CAN	Amount
SM	C96J056	\$125,000

IC	CAN	2018	2019	2020
SM	C96J056	\$125,000	\$125,000	\$125,000

**SM Administrative Data:**

PCC: MHAT / OC: 4145

**SECTION II – PAYMENT/HOTLINE INFORMATION – 1H79SM081206-01**

Payments under this award will be made available through the HHS Payment Management System (PMS). PMS is a centralized grants payment and cash management system, operated by the HHS Program Support Center (PSC), Division of Payment Management (DPM). Inquiries regarding payment should be directed to: The Division of Payment Management System, PO Box 6021, Rockville, MD 20852, Help Desk Support – Telephone Number: 1-877-614-5533.

The HHS Inspector General maintains a toll-free hotline for receiving information concerning fraud, waste, or abuse under grants and cooperative agreements. The telephone number is: 1-800-HHS-TIPS (1-800-447-8477). The mailing address is: Office of Inspector General, Department of Health and Human Services, Attn: HOTLINE, 330 Independence Ave., SW, Washington, DC 20201.

---

## SECTION III – TERMS AND CONDITIONS – 1H79SM081206-01

This award is based on the application submitted to, and as approved by, SAMHSA on the above-title project and is subject to the terms and conditions incorporated either directly or by reference in the following:

- a. The grant program legislation and program regulation cited in this Notice of Award.
- b. The restrictions on the expenditure of federal funds in appropriations acts to the extent those restrictions are pertinent to the award.
- c. 45 CFR Part 75 as applicable.
- d. The HHS Grants Policy Statement.
- e. This award notice, INCLUDING THE TERMS AND CONDITIONS CITED BELOW.

### **Treatment of Program Income: Additional Costs**

In accordance with the regulatory requirements provided at 45 CFR 75.113 and Appendix XII to 45 CFR Part 75, recipients that have currently active Federal grants, cooperative agreements, and procurement contracts with cumulative total value greater than \$10,000,000 must report and maintain information in the System for Award Management (SAM) about civil, criminal, and administrative proceedings in connection with the award or performance of a Federal award that reached final disposition within the most recent five-year period. The recipient must also make semiannual disclosures regarding such proceedings. Proceedings information will be made publicly available in the designated integrity and performance system (currently the Federal Awardee Performance and Integrity Information System (FAPIIS)). Full reporting requirements and procedures are found in Appendix XII to 45 CFR Part 75.

---

## SECTION IV – SM Special Terms and Conditions – 1H79SM081206-01

### **REMARKS**

#### **FY 2018 New Award**

1. This Notice of Award (NoA) is issued to inform your organization that the application submitted through the funding opportunity ***Mental Health Awareness Training Grants SM-18-009*** has been selected for funding.

1a) This award reflects approval of the budget submitted *June 8, 2018* as part of the application by your organization.

2. Recipients are expected to plan their work to ensure that funds are expended within the 12-month budget period reflected on this Notice of Award. If activities proposed in the approved budget cannot be completed within the current budget period, SAMHSA cannot guarantee the approval of any request for carryover of remaining unobligated funding.

3. All responses to award terms and conditions and prior approval requests must be submitted as .pdf documents in the "View Terms Tracking Details" page in eRA Commons.

For more information on how to upload a document in response to a tracked term, please reference under heading "**4 Additional Materials – grantee**" in the User Guide located at: [https://era.nih.gov/files/TCM\\_User\\_Guide\\_Granttee.pdf](https://era.nih.gov/files/TCM_User_Guide_Granttee.pdf)



---

#### 4. Register Program Director/Project Director (PD) in eRA Commons:

If you have not already done so, you must register the PD listed on the HHS Checklist in eRA Commons to assign a Commons ID. Once the PD has received their Commons ID, please send this information to your Grants Management Specialist. You can find additional information about the eRA Commons registration process at [https://era.nih.gov/reg\\_accounts/register\\_commons.cfm](https://era.nih.gov/reg_accounts/register_commons.cfm).

#### Key Staff

Key staff (or key staff positions, if staff has not been selected) are listed below:

*Paul Bellan-Boyer, Project Director @ 20% level of effort In-Kind*

Any changes in key staff including level of effort involving separation from the project for more than three months or a 25 percent reduction in time dedicated to the project, requires prior approval. Reference the Prior Approval Standard Term for additional information and instructions.

### **SPECIAL TERMS**

#### **Disparity Impact Statement (DIS)**

By **November 30, 2018** you must submit via eRA Commons.

The DIS should be consistent with information in your application regarding access, \*service use and outcomes for the program and include three components as described below. Questions about the DIS should be directed to your GPO. Examples of DIS can be found on the SAMHSA website at <http://www.samhsa.gov/grants/grants-management/disparity-impactstatement>.

\*Service use is inclusive of treatment services, prevention services as well as outreach, engagement, training, and/or technical assistance activities.

The disparity impact statement consists of three components:

1. Proposed number of individuals to be served and/or reached by subpopulations in the grant implementation area should be provided in a table that covers the entire grant period. The disparate population(s) should be identified in a narrative that includes a description of the population and rationale for how the determination was made.
2. A quality improvement plan for how you will use your program (GPRA) data on access, use and outcomes to monitor and manage program outcomes by race, ethnicity and LGBT status, when possible. The quality improvement plan should include strategies for how processes and/or programmatic adjustments will support efforts to reduce disparities for the identified subpopulations.
3. The quality improvement plan should include methods for the development and implementation of policies and procedures to ensure adherence to the Enhanced Culturally and

---

Linguistically Appropriate Services (CLAS) Standards and the provision of effective care and services that are responsive to:

- a. Diverse cultural health beliefs and practices;
- b. Preferred languages; and
- c. Health literacy and other communication needs of all sub-populations within the proposed geographic region.

**All responses to award terms and conditions must be submitted as .pdf documents in the “View Terms Tracking Details” page in eRA Commons.**

For more information on how to upload a document in response to a tracked term, please reference under heading “4 Additional Materials – grantee” in the User Guide located at: [https://era.nih.gov/files/TCM\\_User\\_Guide\\_Grantee.pdf](https://era.nih.gov/files/TCM_User_Guide_Grantee.pdf)

## **SPARS**

All SAMHSA recipients are required to collect and report certain data so that SAMHSA can meet its obligations under the Government Performance and Results Act (GPRA) Modernization Act of 2010. These data are gathered using SAMHSA's Performance Accountability and Reporting System (SPARS). MHAT recipients will be expected to complete Annual Goals and Budget training no later than December 30, 2018, and will be expected to enter Annual Goals and Budget data and information no later than January 30, 2019.

## **STANDARD TERMS AND CONDITIONS**

### **Standard Terms for Awards FY 2018**

Your organization must comply with the Standard Terms and Conditions for grants awarded in Fiscal Year 2018 and the following award terms applicable to your award type as identified below:

\* New Grant

SAMHSA's Terms and Conditions Webpage is located at:  
<https://www.samhsa.gov/grants/grants-management/notice-award-noa/standard-terms-conditions>.

### **Annual Federal Financial Report (SF-425)**

The Federal Financial Report (FFR) (SF-425) is required on an annual basis and must be submitted no later than 90 days after the end of the budget period. The annual FFR should reflect only cumulative actual Federal funds authorized and disbursed, any non-Federal matching funds (if identified in the Funding Opportunity Announcement (FOA)), unliquidated obligations incurred, the unobligated balance of the Federal funds for the award, as well as program income generated during the timeframe covered by the report. Additional guidance to complete the FFR can be found at <http://www.samhsa.gov/grants/grants-management/reporting-requirements>.

FFR reporting must be entered directly into the eRA Commons system. Instructions on how to submit a Federal Financial Report (FFR) via the eRA Commons is available at <https://www.samhsa.gov/sites/default/files/samhsa-grantee-submit-ffr-10-22-17.pptx>.

---

## Annual Programmatic Progress Report

Submission of an annual Programmatic Report is due no later than December 30, 2019.

Note: Recipients must also comply with the GPRA requirements that include the collection and periodic reporting of performance data as specified in the FOA or by the Grant Program Official (GPO). This information is needed in order to comply with PL 102-62, which requires that Substance Abuse and Mental Health Services Administration (SAMHSA) report evaluation data to ensure the effectiveness and efficiency of its programs.

The response to this term must be submitted as .pdf documents in the "View Terms Tracking Details" page in eRA Commons. Please contact your Government Program Official (GPO) for program specific submission information.

For more information on how to upload a document in response to a tracked term, please reference under heading "4 Additional Materials – grantee" in the User Guide located at: [https://era.nih.gov/files/TCM\\_User\\_Guide\\_Grantee.pdf](https://era.nih.gov/files/TCM_User_Guide_Grantee.pdf)

Additional information on reporting requirements is available at <https://www.samhsa.gov/grants/grants-management/reporting-requirements>.

### Compliance with Terms and Conditions

FAILURE TO COMPLY WITH THE ABOVE STATED TERMS AND CONDITIONS MAY RESULT IN ACTIONS IN ACCORDANCE WITH 45 CFR 75.3 71, REMEDIES FOR NON-COMPLIANCE AND 45 CFR 75.372 TERMINATION. THIS MAY INCLUDE WITHHOLDING PAYMENT, DISALLOWANCE OF COSTS, SUSPENSION AND DEBARMENT, TERMINATION OF THIS AWARD, OR DENIAL OF FUTURE FUNDING.

**All previous terms and conditions remain in effect until specifically approved and removed by the Grants Management Officer.**

### Staff Contacts:

Yanique Edmond, Program Official  
Phone: (240) 276-1574 Email: [Yanique.Edmond@samhsa.hhs.gov](mailto:Yanique.Edmond@samhsa.hhs.gov)

Salvador Ortiz, Grants Specialist  
Phone: (240) 276-1421 Email: [salvador.ortiz@samhsa.hhs.gov](mailto:salvador.ortiz@samhsa.hhs.gov) Fax: (240) 276-1430

# Resolution of the City of Jersey City, N.J.

City Clerk File No. Res. 18-978

Agenda No. 10.5

Approved: NOV 07 2018

TITLE:



## RESOLUTION AUTHORIZING THE CITY OF JERSEY CITY TO APPLY FOR GRANT FUNDS FROM THE FIREHOUSE SUBS PUBLIC SAFETY FOUNDATION

**COUNCIL as a whole**  
of the following resolution

Offered and moved adoption

**WHEREAS**, Police Officers put their lives at risk everyday while performing their duties and protecting the community; and

**WHEREAS**, the Firehouse Subs Public Safety Foundation is committed to giving back to the communities by supporting first responders and public safety organizations with life-saving equipment and funding resources; and

**WHEREAS**, the Firehouse Subs Public Safety Foundation allows municipalities to apply for this Public Safety Grant to purchase life-saving equipment; and

**WHEREAS**, the City of Jersey City would like to apply for this grant in order to purchase life-saving equipment for police officers to wear while protecting and serving the community; and

**WHEREAS**, the Jersey City Police Department would like to submit a grant application to the Firehouse Subs Public Safety Foundation Grant requesting \$22,375.00 to purchase 25 ballistic vests.

**NOW, THEREFORE, BE IT RESOLVED** by the Municipal Council of the City of Jersey City that:

1. The City of Jersey City is authorized to submit an application to the Firehouse Subs Public Safety Foundation; and
2. The funds will be used to purchase body armor for police officers.

JMcK  
10/31/18

APPROVED: [Signature]  
Business Administrator

APPROVED AS TO LEGAL FORM  
[Signature]  
Corporation Counsel

Certification Required

Not Required

APPROVED 8-0

RECORD OF COUNCIL VOTE ON FINAL PASSAGE 11.7.18											
COUNCILPERSON	AYE	NAY	N.V.	COUNCILPERSON	AYE	NAY	N.V.	COUNCILPERSON	AYE	NAY	N.V.
RIDLEY	✓			YUN	✓			RIVERA	✓		
PRINZ-AREY	✓			SOLOMON	✓			WATTERMAN	ABSENT		
BOGGIANO	✓			ROBINSON	✓			LAVARRO, PRES.	✓		

✓ Indicates Vote

N.V.-Not Voting (Abstain)

Adopted at a meeting of the Municipal Council of the City of Jersey City N.J.

[Signature]  
Rolando R. Lavarro, Jr., President of Council

[Signature]  
Robert Byrne, City Clerk

**RESOLUTION FACT SHEET - CONTRACT AWARD**

This summary sheet is to be attached to the front of any resolution that is submitted for Council consideration. Incomplete or vague fact sheets will be returned with the resolution.

**Full Title of Ordinance/Resolution**

**RESOLUTION AUTHORIZING THE CITY OF JERSEY CITY TO  
APPLY FOR GRANT FUNDS FROM THE FIREHOUSE SUBS PUBLIC SAFETY FOUNDATION**

**Project Manager**

Department/Division	Jersey City Police Department	Grants Office
Name/Title	Sgt. Jaclyn Marcazo	Sergeant
Phone/email	201- 547-4736	jmarcazo@njcps.org

Note: Project Manager must be available by phone during agenda meeting (Wednesday prior to council meeting @ 4:00 p.m.)

**Contract Purpose**

The Jersey City Police Department will apply for the **Firehouse Subs Public Safety Foundation Grant** in the amount of \$22,375.00 in order to purchase 25 ballistic vests for police officers.

**Cost (Identify all sources and amounts)**

Grant Funds

**Contract term (include all proposed renewals)**

Not Applicable

**Type of award** Foundation Grant

If "Other Exception", enter type

**Additional Information**

Not Applicable

I certify that all the facts presented herein are accurate.

  
Signature of Department Director

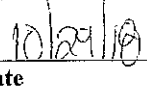
  
Date

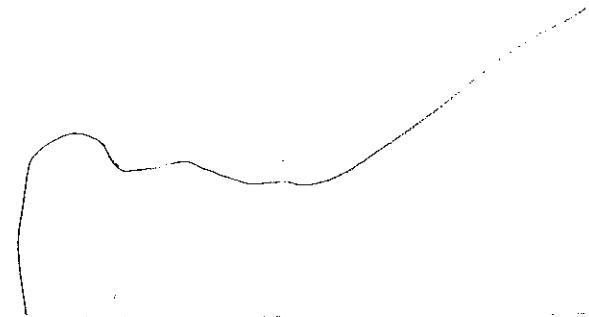

# Resolution of the City of Jersey City, N.J.

City Clerk File No. Res. 18-979  
 Agenda No. 10.T  
 Approved: NOV 07 2018  
 TITLE:



**RESOLUTION AUTHORIZING THE ACCEPTANCE OF GRANTS FUNDS FROM THE NEW JERSEY DEPARTMENT OF LAW AND PUBLIC SAFETY, DIVISION OF HIGHWAY TRAFFIC SAFETY FOR THE JERSEY CITY COMPREHENSIVE TRAFFIC SAFETY PROGRAM (2019)**

**COUNCIL**  
 following resolution.

Offered and moved adoption of the

**WHEREAS**, the need to raise the awareness and increase safety through a combination of enforcement and education initiatives which are essential to all motorists and pedestrians who utilize the streets of Jersey City; and

**WHEREAS**, the New Jersey Department of Law and Public Safety has recognized this need; and

**WHEREAS**, the Division of Highway Traffic Safety has awarded the Jersey City Police Department the FY 2019 award of **\$28,440.00** in overtime reimbursement grant funding to be utilized during the time period from October 1, 2018 until September 30, 2019; and

**WHEREAS**, the Jersey City Police Department wishes to accept these funds to promote enforcement and awareness in the areas of Pedestrian Safety, Aggressive Driving, Drunk Driving, and to purchase commodities; and

**WHEREAS**, the Jersey City Police Department would like to accept the **\$28,440.00** in overtime reimbursement grant funding to be utilized during the above mentioned time frame which has been deemed appropriate as per the Division of Traffic Highway Safety upon the acceptance of this award.

**NOW, THEREFORE, BE IT RESOLVED** by the Municipal Council of the City of Jersey City that:

- The City of Jersey City authorizes to accept the award of **\$28,440.00** from the Division of Highway Traffic Safety to be used to reimburse for overtime patrols to promote education and enforcement for pedestrian safety, aggressive driving, drunk driving, and purchase commodities to help spread the message to "Walk and Drive Safely Jersey City."
- The Office of Management and Budget is hereby authorized to establish the proper account for these funds.

APPROVED: Lavara Moody  
 APPROVED: [Signature]  
 Business Administrator

APPROVED AS TO LEGAL FORM  
[Signature]  
 Corporation Counsel

JMK  
 12/16/18

Certification Required   
 Not Required

APPROVED 8-0

RECORD OF COUNCIL VOTE ON FINAL PASSAGE 11.7.18											
COUNCILPERSON	AYE	NAY	N.V.	COUNCILPERSON	AYE	NAY	N.V.	COUNCILPERSON	AYE	NAY	N.V.
RIDLEY	✓			YUN	✓			RIVERA	✓		
PRINZ-AREY	✓			SOLOMON	✓			WATTERMAN	ABSENT		
BOGGIANO	✓			ROBINSON	✓			LAVARRO, PRES.	✓		

✓ Indicates Vote

N.V.-Not Voting (Abstain)

Adopted at a meeting of the Municipal Council of the City of Jersey City N.J.

[Signature]  
 Rolando R. Lavarro, Jr., President of Council

[Signature]  
 Robert Byrne, City Clerk

**RESOLUTION FACT SHEET - CONTRACT AWARD**

This summary sheet is to be attached to the front of any resolution that is submitted for Council consideration. Incomplete or vague fact sheets will be returned with the resolution.

**Full Title of Ordinance/Resolution**

**RESOLUTION AUTHORIZING THE ACCEPTANCE OF GRANTS FUNDS FROM THE NEW JERSEY DEPARTMENT OF LAW AND PUBLIC SAFETY, DIVISION OF HIGHWAY TRAFFIC SAFETY FOR THE JERSEY CITY COMPREHENSIVE TRAFFIC SAFETY PROGRAM (2019)**

**Project Manager**

Department/Division	Jersey City Police Department	Grants Office
Name/Title	Sgt. Jaclyn Marcazo	Sergeant
Phone/email	201- 547-4736	jmarcazo@njcps.org

Note: Project Manager must be available by phone during agenda meeting (Wednesday prior to council meeting @ 4:00 p.m.)

**Contract Purpose**

The Jersey City Police Department would like to accept the FY 2019 grant award from New Jersey Division of Highway Traffic Safety in the amount of **\$28,440.00** to support the Jersey City Comprehensive Traffic Safety Program. This grant will continue to provide the funding to support overtime salaries for enforcement initiatives such as DWI Checkpoints, DWI Roving Patrols, Seatbelt Enforcement, Aggressive Driving Enforcement, and Pedestrian Decoy Operations.

Funds will also be used to purchase traffic safety activity books for children to learn about safe walking tips.

**Cost (Identify all sources and amounts)**

Grant Funds

**Contract term (include all proposed renewals)**

October 1, 2018 until September 30, 2019

Type of award

If "Other Exception", enter type

**Additional Information**

The DHTS FY 2019 award letter is attached to this Resolution.

I certify that all the facts presented herein are accurate.

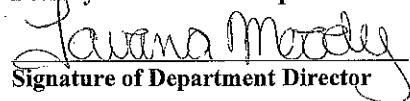
  
Signature of Department Director

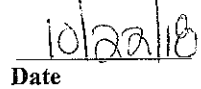
  
Date

**ADD NOTE**

[Menu](#)
 [Forms Menu](#)
 [Status Changes](#)
 [Management Tools](#)
 [Related Documents and Messages](#)

[Back](#)

Document information: [FED-2019-Jersey City-00139](#)

[Details](#)

**GRANT SNAPSHOT**

<b>Grant #:</b>	<b>PT-19-03-04-01</b>
<b>Status:</b>	<b>Grant Agreement Executed</b>
<b>Project Title:</b>	<b>Jersey City Comprehensive Traffic Safety Program</b>
<b>Grantee/Organization Name:</b>	<b>Jersey City</b>
<b>Project Period:</b>	<b>From: 10/01/2018 To: 09/30/2019</b>
<b>Total Grant Award:</b>	<b>\$28,440.00</b>

[Top of the Page](#)

Powered by IntelliGrants®

© Copyright 2000-2018 Agate Software, Inc.





Home Calendar Documents

Reports | Training Materials | Organization(s) | Profile:egibbs | Logout

NEXT PRINT VERSION ADD NOTE CHECK GLOBAL ERRORS

Menu Forms Menu Status Changes Management Tools Related Documents and Messages

Back

Document Information: FED-2019-Jersey City-00139

Details

You are here: > HTS Federal Highway Safety Grant 2019 Menu > Forms Menu > Budget

BUDGET SUMMARY

Instructions:

- Click the SAVE button to finalize your grant budget.
To proceed to the next page you may click the NEXT button or use the FORMS MENU tab at the top of the page.

Table with 4 columns: Budget Line Item, Federal Share, State/Local Share, Total Amount Requested. Rows include Salaries and Wages, Fringe Benefits, Travel, Enforcement/Education Details, Miscellaneous Personal Services, Contractual Services, Commodities, Other Direct Costs, Indirect Costs, and a Total row.

1775796

Top of the Page

Powered by IntelliGrants

© Copyright 2000-2018 Agate Software, Inc.

[Menu](#)  [Forms Menu](#)  [Status Changes](#)  [Management Tools](#)  [Related Documents and Messages](#)

 [Page Information](#)  
 The information has been saved.

[Back](#)

Document Information: [FED-2019-Jersey City-00139](#)

[Details](#)

You are here: > [HTS Federal Highway Safety Grant 2019 Menu](#) > [Forms Menu](#) > Contract Agreement

**CONTRACT AGREEMENT**

**Project Title** Jersey City Comprehensive Traffic Safety Program  
**Grant Number** PT-19-03-04-01  
**Federal Fiscal Year** 2019  
**Amount Awarded** \$28,440  
**Funding Source** SECTION 402-STATE AND COMMUNITY HIGHWAY SAFETY-CFDA 20.600  
**Project Period** 10/1/2018 - 9/30/2019

**Project Director** Jaclyn Marcano  
**Financial Officer** Donna Mauger  
**Authorizing Official** Steven Fulop

**Federal Award Id #** 60A3751930004020NJ0

**Federal Award Agency:** U.S. DOT/National Highway Traffic Safety Administration

**Granting Agency Contact Information:**  
 NJ Division of Highway Traffic Safety  
 140 East Front Street  
 Trenton, NJ 08625  
 Gary Podubicky  
 Acting Director  
 609-833-9300

In accordance with the provisions of 23 U.S.C. Chapter 4, the Highway Safety Act of 1966 as amended, the Department of Law and Public Safety hereby awards to the above named Subrecipient a subaward in the amount specified for the purposes set forth in the approved application.

This subaward is subject to the requirements set forth in the appropriate Federal Regulations, the General Conditions for subawards promulgated by the Department of Law and Public Safety, all applicable Statutes of the State of New Jersey and the requirements of the State of New Jersey for State and local financial accounting including the filing of single audits as required under 2 C.F.R. Part 200, Subpart F, Audit Requirements (2 C.F.R. 200.500, et seq.) and/or State Circular Letters 15-08-OMB and 07-05-OMB (if applicable); It is subject also to any general conditions and assurances, approved budget, application authorization, certifications, and special conditions attached to this program.

This subaward incorporates all conditions and representations contained or made in the application and notice of award (if applicable).

I the Project Director agree to the Terms and Conditions above.\*

Additional approval information (if applicable) is attached here

1775803

# Resolution of the City of Jersey City, N.J.

City Clerk File No. Res. 18-980

Agenda No. 10.U

Approved: NOV 07 2018



TITLE:

**RESOLUTION RATIFYING THE SUBMISSION OF A GRANT APPLICATION AND AUTHORIZING THE EXECUTION OF A GRANT AGREEMENT WITH THE NEW JERSEY DEPARTMENT OF TRANSPORTATION FOR THE 2019 BIKEWAYS PROGRAM TO FUND THE JERSEY CITY MORRIS CANAL GREENWAY PROJECT FOR THE CITY OF JERSEY CITY**

**COUNCIL AS A WHOLE  
FOLLOWING RESOLUTION:**

**OFFERED AND MOVED ADOPTION THE**

**WHEREAS**, the State of New Jersey Department of Transportation announced that it is accepting grant applications for the 2019 Bikeway Program that must be completed and submitted through the System for Administering Grants Electronically (SAGE) on or before October 8, 2018; and

**WHEREAS**, the City of Jersey City ("City"), Department of Administration, Division of Engineering, Traffic and Transportation prepared and submitted an electronic application identified as BIKE-2019-Jersey City Morris Canal Greenway-00061; and

**WHEREAS**, the City is requesting State aid funding from the New Jersey Department of Transportation to implement the construction of safe off-road bike paths and bike lanes within the City limits; and

**WHEREAS**, the City agrees that it shall be required to appropriate funds for State non-participating items such as police salary hours and/or other ineligible project costs;

**WHEREAS**, the City agrees to assume a commitment for maintenance and repair of the bike paths and bike lanes within the City limits;

**NOW, THEREFORE, BE IT RESOLVED**, by the Municipal Council of the City of Jersey City that it ratifies and approves the submission of a grant application for the above stated project;

**BE IT FURTHER RESOLVED**, that the Mayor and Clerk of the City of Jersey City, County of Hudson, State of New Jersey are hereby authorized to submit an electronic grant application identified as BIKE-2019-Jersey City Morris Canal Greenway-00061 to the New Jersey Department of Transportation on behalf of the City of Jersey City; and

**BE IT FURTHER RESOLVED**, that the Mayor and Clerk of the City of Jersey City, County of Hudson, State of New Jersey are hereby authorized to sign the grant agreement on behalf of the City of Jersey City and that their signatures constitute acceptance of the terms and conditions of the grant agreement and approves the execution of the grant agreement and the establishment of an account for the grant.

TITLE:

**RESOLUTION RATIFYING THE SUBMISSION OF A GRANT APPLICATION AND AUTHORIZING THE EXECUTION OF A GRANT AGREEMENT WITH THE NEW JERSEY DEPARTMENT OF TRANSPORTATION FOR THE 2019 BIKEWAYS PROGRAM TO FUND THE JERSEY CITY MORRIS CANAL GREENWAY PROJECT FOR THE CITY OF JERSEY CITY**

Certified as a true copy of the Resolution adopted by Council,  
 On this 7th day of NOVEMBER, 2018

\_\_\_\_\_  
 City Clerk

My signature and the Clerk's seal serve to acknowledge the above resolution and constitute acceptance of the terms and conditions of the grant agreement and approve the execution of the grant agreement as authorized by the resolution above.

ATTEST and AFFIX SEAL

\_\_\_\_\_  
 City Clerk  
 Robert Byrne

\_\_\_\_\_  
 Presiding Officer  
 Steven M. Fulop, Mayor of Jersey City

JRC/dlo  
 10-3-18  
 JMcK  
 10/26/18

APPROVED: Jose R. Curb  
 APPROVED: [Signature]  
 Business Administrator

APPROVED AS TO LEGAL FORM  
[Signature]  
 Corporation Counsel

Certification Required

Not Required

APPROVED 8-0

RECORD OF COUNCIL VOTE ON FINAL PASSAGE 11.7.18											
COUNCILPERSON	AYE	NAY	N.V.	COUNCILPERSON	AYE	NAY	N.V.	COUNCILPERSON	AYE	NAY	N.V.
RIDLEY	✓			YUN	✓			RIVERA	✓		
PRINZ-AREY	✓			SOLOMON	✓			WATTERMAN	ABSENT		
BOGGIANO	✓			ROBINSON	✓			LAVARRO, PRES	✓		

✓ Indicates Vote

N.V.-Not Voting (Abstain)

Adopted at a meeting of the Municipal Council of the City of Jersey City N.J.

\_\_\_\_\_  
 Rolando R. Lavarro, Jr., President of Council

\_\_\_\_\_  
 Robert Byrne, City Clerk

**RESOLUTION FACT SHEET – NON-CONTRACTUAL**

This summary sheet is to be attached to the front of any resolution that is submitted for Council consideration. Incomplete or vague fact sheets will be returned with the resolution.

**Full Title of Ordinance/Resolution**

**RESOLUTION RATIFYING THE SUBMISSION OF A GRANT APPLICATION AND AUTHORIZING THE EXECUTION OF A GRANT AGREEMENT WITH THE NEW JERSEY DEPARTMENT OF TRANSPORTATION FOR THE 2019 BIKEWAYS PROGRAM TO FUND THE JERSEY CITY MORRIS CANAL GREENWAY PROJECT FOR THE CITY OF JERSEY CITY**

**Initiator**

Department/Division	ADMINISTRATION	ENGINEERING
Name/Title	JOSE R. CUNHA, C.M.E., P.E.	MUNICIPAL ENGINEER
Name/Title		
Phone/email	201-547-4411	jcunha@jcnj.org

Note: Initiator must be available by phone during agenda meeting (Wednesday prior to council meeting @ 4:00 p.m.)

**Resolution Purpose**

The FY2019 State-funded Bikeway Grant Program administered by the New Jersey Department of Transportation (NJ DOT) provides funds to counties and municipalities to promote bicycling as an alternate mode of transportation in the State of New Jersey. The City of Jersey City ("City") wishes to apply for transportation funding in the amount of **\$529,100.00** for a project identified as BIKE-2019-Jersey City-Morris Canal Greenway. The proposed project is to construct segment 3 of the 17 segment Morris Canal Greenway within The City limits and provide for safer off-road bike path.

**Cost (Identify all sources and amounts)**

**Contract term (include all proposed renewals)**

Construction Estimate	—	\$529,100.00
<b>GRANTAPPLICATION</b>	<b>TOTAL REQUEST</b>	<b>\$529,100.00</b>
Professional Design Services		\$52,910.00
Const. Mgmt/Inspection/Testing		\$79,365.00

\* Note – Upon award of grant, the City may need to supplement project with capital funds in order to award the construction project.

[Empty box for contract term details]

**Type of award**

Grant Application

If "Other Exception", enter type

[Empty box for other exception type]

I certify that all the facts presented herein are accurate.

Jose R. Cunha  
Jose R. Cunha, P.E., C.M.E.,  
Director of Engineering

10/18/18  
Date

Brian D. Platt  
Brian D. Platt, Business Administrator  
Department Director

10/31/18  
Date



STEVEN M. FULOP  
MAYOR OF JERSEY CITY

CITY OF JERSEY CITY  
DEPARTMENT OF ADMINISTRATION  
DIVISION OF ENGINEERING, TRAFFIC & TRANSPORTATION  
MUNICIPAL SERVICES COMPLEX | 13-15 LINDEN AVE EAST | JERSEY CITY, NJ 07305  
P: 201 547 4470 | F: 201 369 7292



BRIAN D. PLATT  
BUSINESS ADMINISTRATOR

MEMORANDUM

DATE : October 3, 2018

TO : Rolando R. Lavarro, Council President and  
Members of the Municipal Council

FROM :  Jose R. Cunha, P.E., C.M.E., C.P.W.M., C.R.P.  
Director of Engineering

SUBJECT : **Resolution to Ratify Application to New Jersey Department of  
Transportation 2019 Bikeways Program to fund the Morris Canal  
Greenway Project**

Attached for your consideration is a resolution ratifying the electronic submission of the 2019 Bikeway grant application to the New Jersey Department ("NJDOT") for the 2019 Bikeways Program and execution of a grant agreement to be identified as BIKE-2019-Jersey City Morris Canal Greenway-00061.

The City is very dedicated in enhancing our bicycling community and seeking funding from NJDOT Bikeways program to make improvements to the bikeways infrastructure. The continue planning and construction of bike paths and bike lanes are more imperative than ever before to ensure the success of a bike friendly city and ensure fulfillment of our pedestrian safety improvements. In this application, the first priority will be to construct signs, improve striping and markings and provide for clear and safe off-road bike path. The City is requesting \$529,100.00 for construction.

Please contact my office at 201-547-4411 should you have any questions or need additional information.

CC: Robert Byrne, City Clerk  
Brian D. Platt, Business Administrator  
Donna Mauer, Chief Financial Officer  
Paul Russo, Supervising Engineer  
Andrew Vischio, Director of Traffic and Transportation  
Dawn Odom, Supervising Administrative Analyst



[NJDOT Home](#)  
[Engineering](#)

[About NJDOT](#)  
[In the Works](#)

[NJcommuter.com](#)  
[Capital Program](#)

[Community Programs](#)  
[Freight, Air and Water](#)

[Reference / Links](#)  
[Doing Business](#)

[Local Aid and Economic Development Overview](#)

[What's New](#)

[Funding Programs](#)

[Recent Grant Recipients](#)

**State Funded Programs**

**Municipal Aid**

- [County Aid](#)
- [Local Aid](#)
- [Infrastructure Fund](#)
- [Bikeways](#)
- [Safe Streets to Transit](#)
- [Transit Village](#)
- [Local Bridges, Future Needs](#)
- [Local Freight Impact Fund \(LFIF\)](#)

**Federally Funded Programs**

[Transportation Infrastructure Bank Fund](#)

[Federal Eligibility Requirements](#)

[Publications](#)

[Forms and Applications](#)

[District Offices](#)

# Local Aid

## and Economic Development

### Municipal Aid

**FY 2019 Grant Solicitation – State Aid Programs**

The Division of Local Aid is currently accepting application for Following State Aid program through SAGE.

- Municipal Aid
- Transit Village
- Bikeways
- Safe Streets to Transit

Application Deadline: October 8, 2018

The Municipal Aid program is a competitive program intended to provide municipalities with transportation based grants to supplement their transportation programs. Starting in FY2018 the Transportation Trust Fund (TTF) will provide \$400 million in State Aid to municipalities and counties for local transportation improvements. Of that amount the Municipal Aid Program will be funded at level of \$140 million. Additionally \$10 million is allotted for municipalities qualifying for Urban Aid under P.L. 1978 c.14 (N.J.S.A. 52:27D-178 et seq.,). The individual allotments to qualifying municipalities are based on proportions determined by the Department of Community Affairs.

Each fiscal year, the New Jersey Department of Transportation (NJDOT) issues a solicitation announcement to municipalities inviting them to apply for funding for their specific project needs. The Municipal Aid Program is administered consistent with the language and formula distribution contained within the TTF legislation that allocates funds by county based a formula that considers population and municipal roadway miles.

Municipalities can apply for projects for Municipal Aid within one of the 7 categories below:

- Bikeway
- Primary project purpose is for constructing new bikeways (e.g.

- bike lanes, bike paths, bike compatible roadways).
- Bridge Preservation
  - Primary project purpose is for improving the condition of bridge infrastructure (e.g. new deck, rehabilitation, replacement).
- Mobility
  - Primary project purpose is to enhance mobility and reduce congestion (e.g. adding lanes, signal optimization).
- Pedestrian Safety
  - Primary project purpose is to enhance pedestrian safety (e.g. new sidewalks, new crosswalks, traffic calming, pedestrian overpass).
- Quality of Life
  - Primary project purpose is for beautification, environmental mitigation, economic development or historic preservation.
- Roadway Preservation
  - Primary project purpose is for improving the condition of roadway infrastructure (e.g. resurfacing, reconstruction, drainage).
- Roadway Safety
  - Primary project purpose is to enhance vehicular safety (e.g. guide rail, signing, warning devices, and striping).

All applications for the Municipal Aid Program are to be submitted online through System for Administering Grants Electronically (SAGE). Each district office will review applications within their designated geographic area for completeness, make a field investigation, evaluate and assign a rating to each project. Applications receive points based on various criteria including existing conditions, Average Daily Traffic (ADT), safety improvements, and access to services to public. Other important criteria include the municipality's special designation, whether the municipality has received an allotment within the last three years, and the municipality's award and close-out performance on previously awarded State grants.

Projects for which online applications have been submitted are presented to a screening committee comprised of municipal engineers and NJDOT staff appointed by the Commissioner. The committee evaluates the projects presented and makes recommendations to the Commissioner of Transportation for consideration and approval. The State pays 75% of the funds at the time of award concurrence and the remainder on a reimbursement basis after acceptance by the municipality and the State of the work completed.



Additional information can be found in Municipal Aid Handbook and State Aid Handbook.

- [Application for Funding \(SAGE\)](#)
- [FY 2018 Municipal Aid Grant Recipients](#) (pdf 96k)
- [Municipal Aid Regulations](#) (Adopted April 16, 2014) (pdf 69k)
- [Special Provisions and State Aid Projects](#) (pdf 95k)
- [Special Provisions, Baseline Document Changes and Pay Items](#)
- [State Aid Handbook](#) (pdf 95k)
- [Municipal Aid Handbook](#) (pdf 63k)

You will need Adobe Acrobat Reader to view the PDF files which is available at our state [Adobe Acrobat Access](#) page.

 [Contact Us](#) | [Privacy Notice](#) | [Legal Statement](#) | [Accessibility Statement](#) 

department: [home](#) | [about](#) | [NJ commuter](#) | [in the works](#) | [business](#) | [engineering](#) | [freight, air & water](#) | [capital](#) | [community](#) | [data](#) | [links](#) | [index](#)  
statewide: [NJ Home](#) | [about NJ](#) | [business](#) | [government](#) | [state services A to Z](#) | [departments](#)

Copyright © State of New Jersey, 2002-2018  
Department of Transportation  
P.O. Box 600  
Trenton, NJ 08625-0600



Last Updated: July 25, 2018

Bikeways Application 2019  
BIKE-2019-Jersey City Morris Canal Greenway -00061  
Type of Improvement: 1

**Infrastructure**

Bikeway

**Purpose**

Primary project purpose is for constructing new bikeways (e.g. bike lanes, bike paths, bike compatible roadways).

Will the project create new linear bike path mileage?

Yes

No

(Examples of ineligible Projects under this program may be:  
rehabilitation of existing bikeway, widening of existing bikeway)

**If NO, please apply for Bikeway under the Municipal Aid Program**

Bikeways Application 2019

BIKE-2019-Jersey City Morris Canal Greenway -00061

Project Name: Jersey City Morris Canal Greenway (Segment 3)

**Note:** If you have multiple locations for the same type of improvement and scope of work, you may enter "various" for the project limits, [download the excel spreadsheet here](#), fill it out and attach it below.

**Project Title:** Jersey City Morris Canal Greenway (Segment 3)  
**From:** Sullivan Drive near intersection with Grieco Drive  
**To:** Intersection at John F. Kennedy Boulevard and Mercer Park  
**Project Distance (Miles):** 0.85

Bikeways Application 2019  
BIKE-2019-Jersey City Morris Canal Greenway -00061  
Project Location

**County to filter by:** Hudson County

**Municipalities:** Jersey City

**Bikeways Application 2019**  
**BIKE-2019-Jersey City Morris Canal Greenway -00061**  
**Scope of Work**

**Please provide description for Scope of Work:**

The proposed project seeking funding under the FY2019 New Jersey Department of Transportation Bikeways Program is to construct Segment 3 of the 14-segment Morris Canal Greenway in Jersey City, New Jersey. The Jersey City Morris Canal Greenway is a surface transportation project that will be constructed in the form of a linear bikeway alignment through a combination of on-road and off-road facilities. The project provides much-needed open space dedicated to bicyclists, as well as pedestrians, for both circulation and recreation. The full linear alignment of the bikeway also facilitates connections to existing regional greenways, including the East Coast Greenway and the Hudson River Waterfront Walkway.

Segment 3 adjusts the path of the Morris Canal Greenway as originally proposed in the 2013 Jersey City Morris Canal Greenway Plan. Segment 3 was originally comprised of on-street segments; however, the City recently purchased a right-of-way from the City of Bayonne, allowing for the Greenway to transition to a safer off-road alignment for the segment within the original footprint of the Morris Canal (Property Survey attached in the Location Map attachment). This segment includes Block 27804, Lot 13, and Block 28401, Lot 40, encompassing 4.87 acres. The route then transitions to an on-road segment beginning on Custer Avenue at the property line of Block 28401, Lot 40, and continues on John F. Kennedy Boulevard before entering Mercer Park near the intersection with W 63rd Street. Alternatively, the route may pass through McGovern Park onto Sycamore Road, continuing on West 63rd Street before entering Mercer Park (Segment 4, owned by Hudson County and under construction with funding from the FY17 NJDOT Transportation Alternatives Program) at the intersection of West 63rd Street and John F. Kennedy Boulevard. The northern and southern termini of Segment 3 both connect with the broader Jersey City on-street bicycle network, as outlined in the Jersey City Master Plan Circulation Element (maps attached in the Location Map attachment).

The proposed scope of work for Segment 3 includes:

- Site Preparation and Earthwork (mobilization, cleaning and grubbing, remove existing concrete curb/sidewalk/wall, remove existing pavement, and disposal of historic fill) (\$145,000)
- Paving of the Greenway path (clean fill, dense graded aggregate base, and full depth asphalt pavement) (\$278,500)
- Roadway crossing improvements at four locations along the Greenway route, including striping and traffic control signage (\$80,000)
- Bike racks (4) and concrete bicycle pad (4) for CitiBike, the City's bike share provider (\$12,000)
- Bollards (8) to prevent vehicle traffic from entering the bikeway (\$12,000)
- On-street bike lane medallions (\$1,600)

TOTAL COSTS: \$529,100

Additional improvements (as detailed in the enclosed cost estimate) that are necessary to complete the scope of work, but not necessarily specific to the bikeway right-of-way, include striping, benches/seating, trash/recycling receptacles, lighting, signage, stormwater management/control features, soil erosion and sediment control measures, and site preparation/earthwork activities.

Jersey City is one of the most densely populated and fastest growing cities in the state and country. According to NJDEP Balanced Land Use Standards, there is a significant shortage of open space acreage. Due to the City's ADT of passenger vehicle and heavy truck volume, bicycling can be a dangerous activity for many



# **BIKE-2019-Jersey City Morris Canal Greenway -00061**

## **Project Location Maps**



Map 1. Map of Segment 3 (in red) along right of way acquired from Bayonne, connecting Danforth Avenue with McGovern Park off-street and navigating on-street to Mercer Park (Segment 4). The yellow line depicts an alternate route that uses JFK Boulevard rather than West 63<sup>rd</sup> Street to connect Segments 3 and 4.







**MASER**  
 LAND SURVEYING & ENGINEERING  
 1000 ROUTE 100  
 SUITE 200  
 NEW JERSEY CITY, NJ 07310  
 TEL: 201-732-1100  
 FAX: 201-732-1101  
 WWW.MASER-SURVEYING.COM

**NEW JERSEY**  
 STATE DEPARTMENT OF TREASURY  
 DIVISION OF TAXATION  
 100 STATE STREET  
 NEW JERSEY CITY, NJ 07310  
 TEL: 201-261-6000  
 FAX: 201-261-6001  
 WWW.NJSTATEDEPARTMENTOFTREASURY.COM

NO.	DESCRIPTION	DATE
1	FILED MAP NO. 2146 (REFERENCE #)	
2	FILED MAP NO. 384 (REFERENCE #)	
3	FILED MAP NO. 385 (REFERENCE #)	
4	FILED MAP NO. 386 (REFERENCE #)	
5	FILED MAP NO. 387 (REFERENCE #)	
6	FILED MAP NO. 388 (REFERENCE #)	
7	FILED MAP NO. 389 (REFERENCE #)	
8	FILED MAP NO. 390 (REFERENCE #)	
9	FILED MAP NO. 391 (REFERENCE #)	
10	FILED MAP NO. 392 (REFERENCE #)	
11	FILED MAP NO. 393 (REFERENCE #)	
12	FILED MAP NO. 394 (REFERENCE #)	
13	FILED MAP NO. 395 (REFERENCE #)	
14	FILED MAP NO. 396 (REFERENCE #)	
15	FILED MAP NO. 397 (REFERENCE #)	
16	FILED MAP NO. 398 (REFERENCE #)	
17	FILED MAP NO. 399 (REFERENCE #)	
18	FILED MAP NO. 400 (REFERENCE #)	

**JERRY B. BLUNCE**  
 LICENSED PROFESSIONAL SURVEYOR  
 NO. 10101  
 1000 ROUTE 100, SUITE 200  
 NEW JERSEY CITY, NJ 07310  
 TEL: 201-732-1100  
 FAX: 201-732-1101  
 WWW.MASER-SURVEYING.COM

**BOUNDARY SURVEY**  
 FOR  
**JERSEY CITY**  
 DEVELOPMENT  
 AGENCY  
 BLOCK 2034, LOTS 485  
 BLOCK 2034, LOT 13  
 BLOCK 2034, LOT 40  
 CITY OF JERSEY CITY  
 HUDSON COUNTY  
 NEW JERSEY

**ASAP SURVEYING**  
 1000 ROUTE 100, SUITE 200  
 NEW JERSEY CITY, NJ 07310  
 TEL: 201-732-1100  
 FAX: 201-732-1101  
 WWW.MASER-SURVEYING.COM

NO.	DESCRIPTION	DATE
1	FILED MAP NO. 2146 (REFERENCE #)	
2	FILED MAP NO. 384 (REFERENCE #)	
3	FILED MAP NO. 385 (REFERENCE #)	
4	FILED MAP NO. 386 (REFERENCE #)	
5	FILED MAP NO. 387 (REFERENCE #)	
6	FILED MAP NO. 388 (REFERENCE #)	
7	FILED MAP NO. 389 (REFERENCE #)	
8	FILED MAP NO. 390 (REFERENCE #)	
9	FILED MAP NO. 391 (REFERENCE #)	
10	FILED MAP NO. 392 (REFERENCE #)	
11	FILED MAP NO. 393 (REFERENCE #)	
12	FILED MAP NO. 394 (REFERENCE #)	
13	FILED MAP NO. 395 (REFERENCE #)	
14	FILED MAP NO. 396 (REFERENCE #)	
15	FILED MAP NO. 397 (REFERENCE #)	
16	FILED MAP NO. 398 (REFERENCE #)	
17	FILED MAP NO. 399 (REFERENCE #)	
18	FILED MAP NO. 400 (REFERENCE #)	

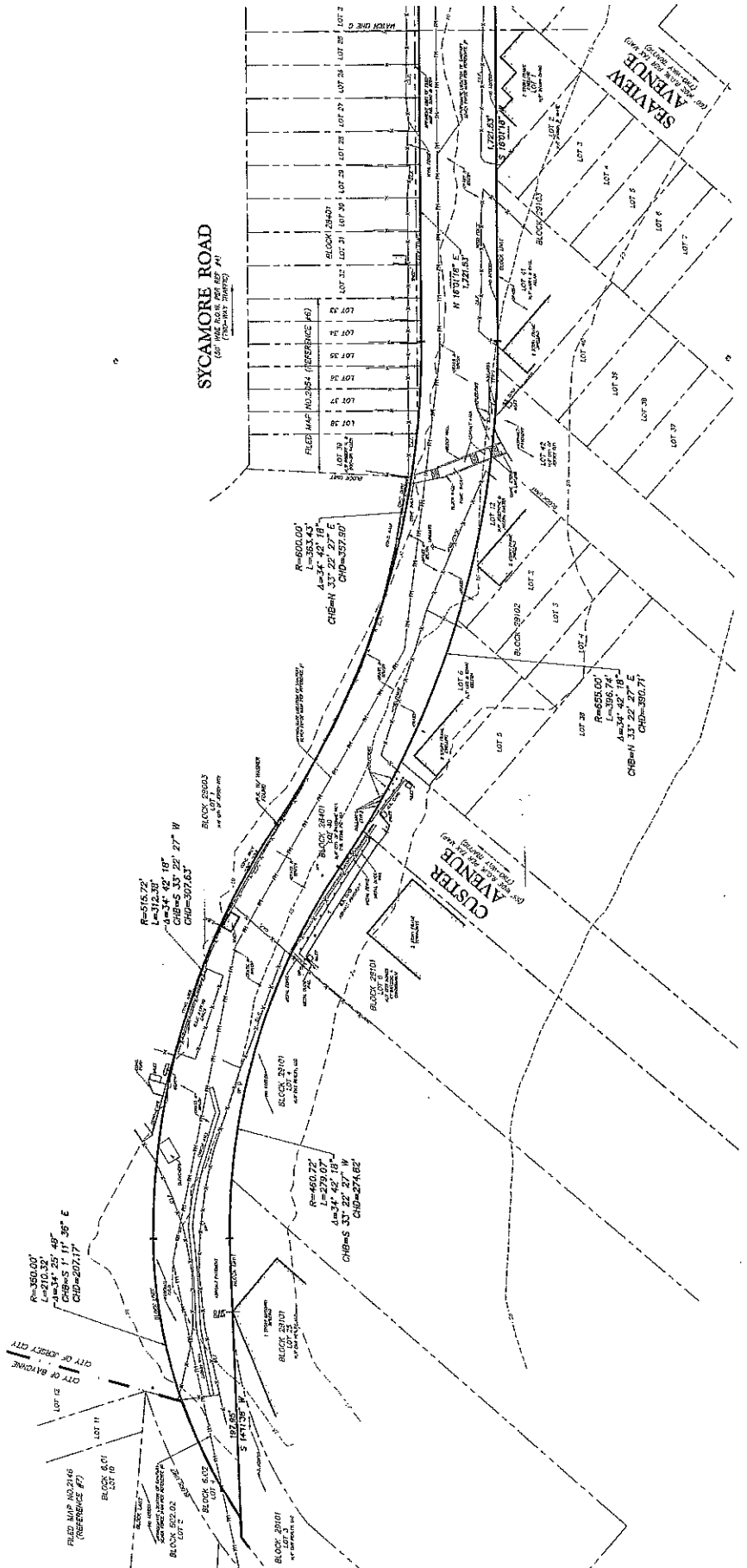
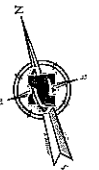

3 of 3

**Project Photos – Segment 3**

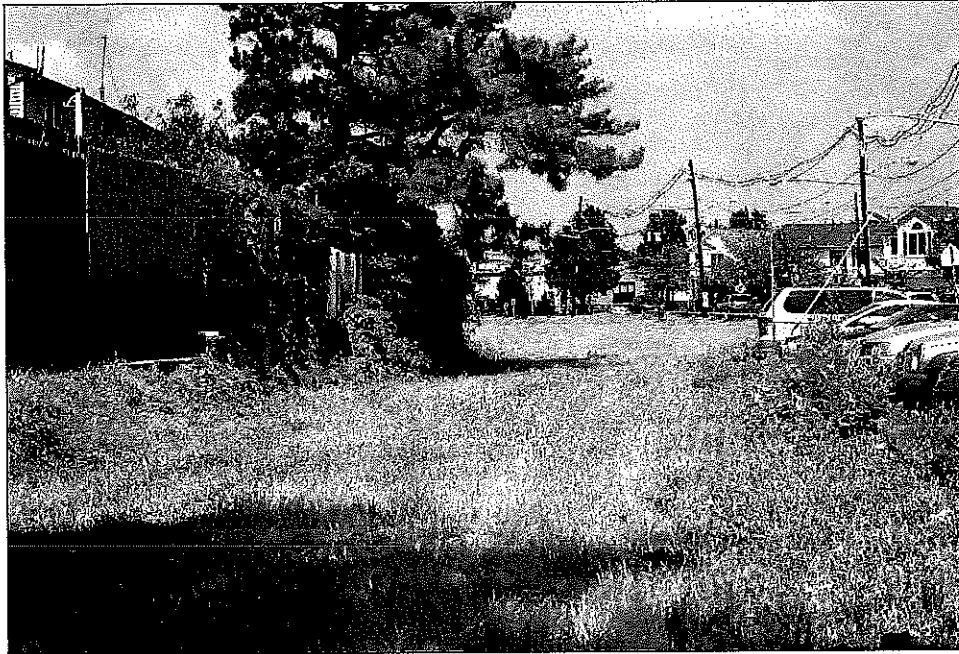

Image 1. View of Segment 3 looking north near intersection of Sullivan Drive and Lembeck Avenue, following the original right of way route of the Morris Canal.



Image 2. View of Segment 3 looking south near intersection of Sullivan Drive and Lembeck Avenue following the original right of way route of the Morris Canal.

**Project Photos – Segment 3**



Image 3. View of Segment 3 looking south crossing Sycamore Road at Sullivan Drive. Signage and crossing striping are necessary at this location.



Image 4. Providing an opportunity for historic markers and interpretive signage.

**Project Photos – Segment 3**



Image 5. View of Segment 3 looking south past canal crossing of Sycamore Road at Sullivan Drive.

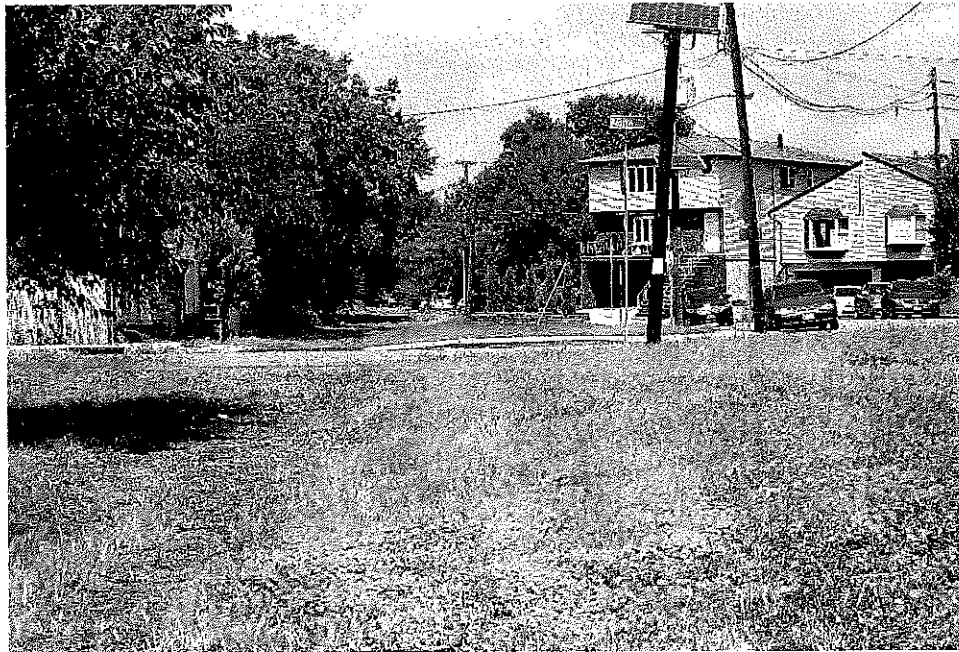

Image 6. View of Segment 3 looking north crossing Mina Drive at Sayles Street. Signage and crossing striping are necessary at this location.

**Project Photos – Segment 3**



Image 7. View of existing fence mural along Segment 3 near McGovern Park.



Image 8. View of Segment 3 heading towards rear of McGovern Park.

### Project Photos – Segment 3

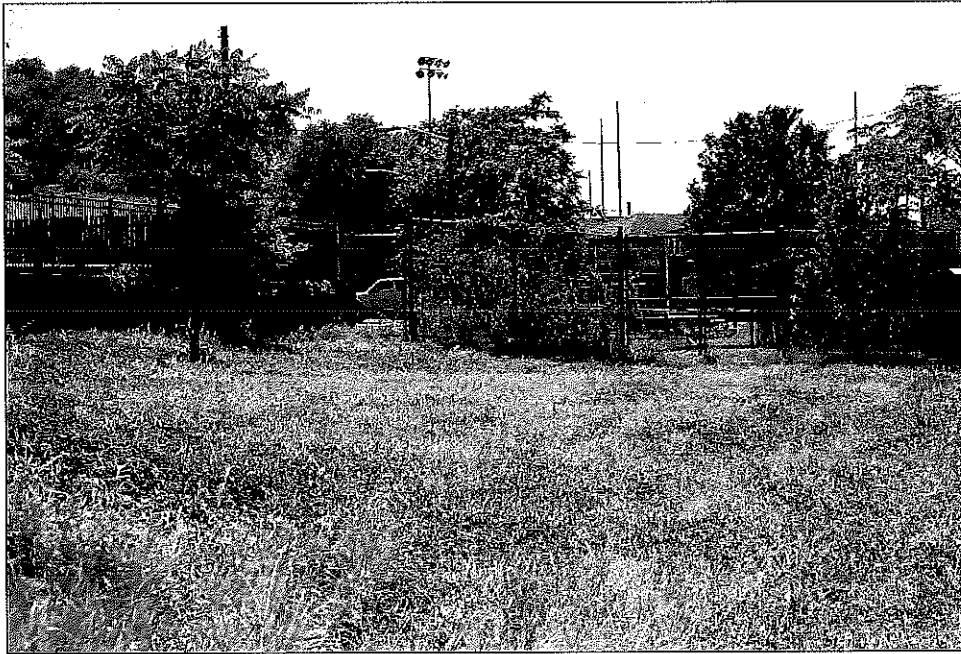

Image 9. View of southern terminus of Segment 3 looking into ball field at McGovern Park.

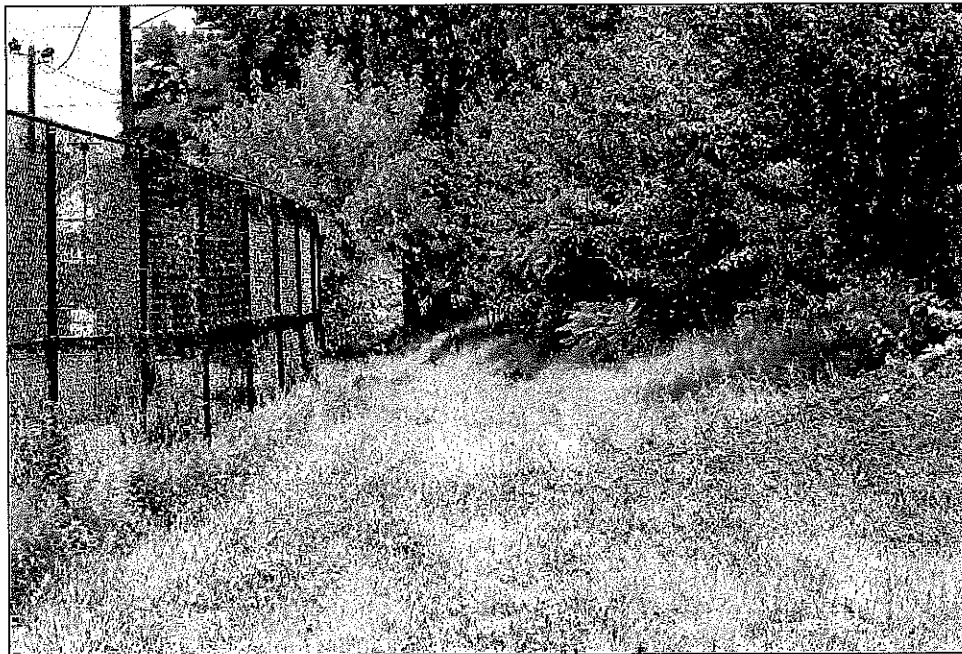

Image 10. View of Segment 3 looking north along border with McGovern Park.

**Project Photos – Segment 3**



Image 11. View of Segment 3 looking north near McGovern Park.



**Bikeways Application 2019**  
**BIKE-2019-Jersey City Morris Canal Greenway -00061**  
**Bikeways Data Sheet**

**Project Classification**

Please select the one most applicable:

- Bike Paths
- Bike Lanes
- Bike Route
- Bike Compatible Road

Is the project separated from motor vehicle traffic by a barrier or an open space?  Yes  No

Does the project serve as a connection to a local or regional system of bikepaths, bike lanes, or bike routes?  Yes  No

Show on a map, attach below.

[https://njsage.intelligrants.com/Upload/1892862\\_1530900-BicycleNetwork-FY2019JCBikeways.pdf](https://njsage.intelligrants.com/Upload/1892862_1530900-BicycleNetwork-FY2019JCBikeways.pdf)

Also, please upload photos of the existing bike facilities here:

**Does the project serve any of the public facilities listed below within the project limit? (Check all applicable).** Yes  No

- Public School(K-12)
- Private School(K-12)
- Parks/Recreational Facilities
- Transit Stations
- State Offices

Is the project part of a bicycle network that has been adopted in a municipal Master Plan?  Yes  No  
(show with relevant page(s) of Master Plan, attach below)







[https://njsage.intelligrants.com/Upload/1892862\\_1530899-PagesfromMasterPlan-CirculationandJCMorrisCanalPlan.pdf](https://njsage.intelligrants.com/Upload/1892862_1530899-PagesfromMasterPlan-CirculationandJCMorrisCanalPlan.pdf)

Has the applicant adopted a Complete Streets policy or resolution?  Yes  No

# CITY OF JERSEY CITY

## Plan for Bike Lanes and Sharrows

### Legend

-  Bike Lanes or Sharrows
-  PATH Rail System
-  Light Rail System
-  Libraries
-  Schools
-  Parks

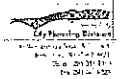

October 11, 2012

0 1,000 2,000 4,000 Feet

MAP NO.:545

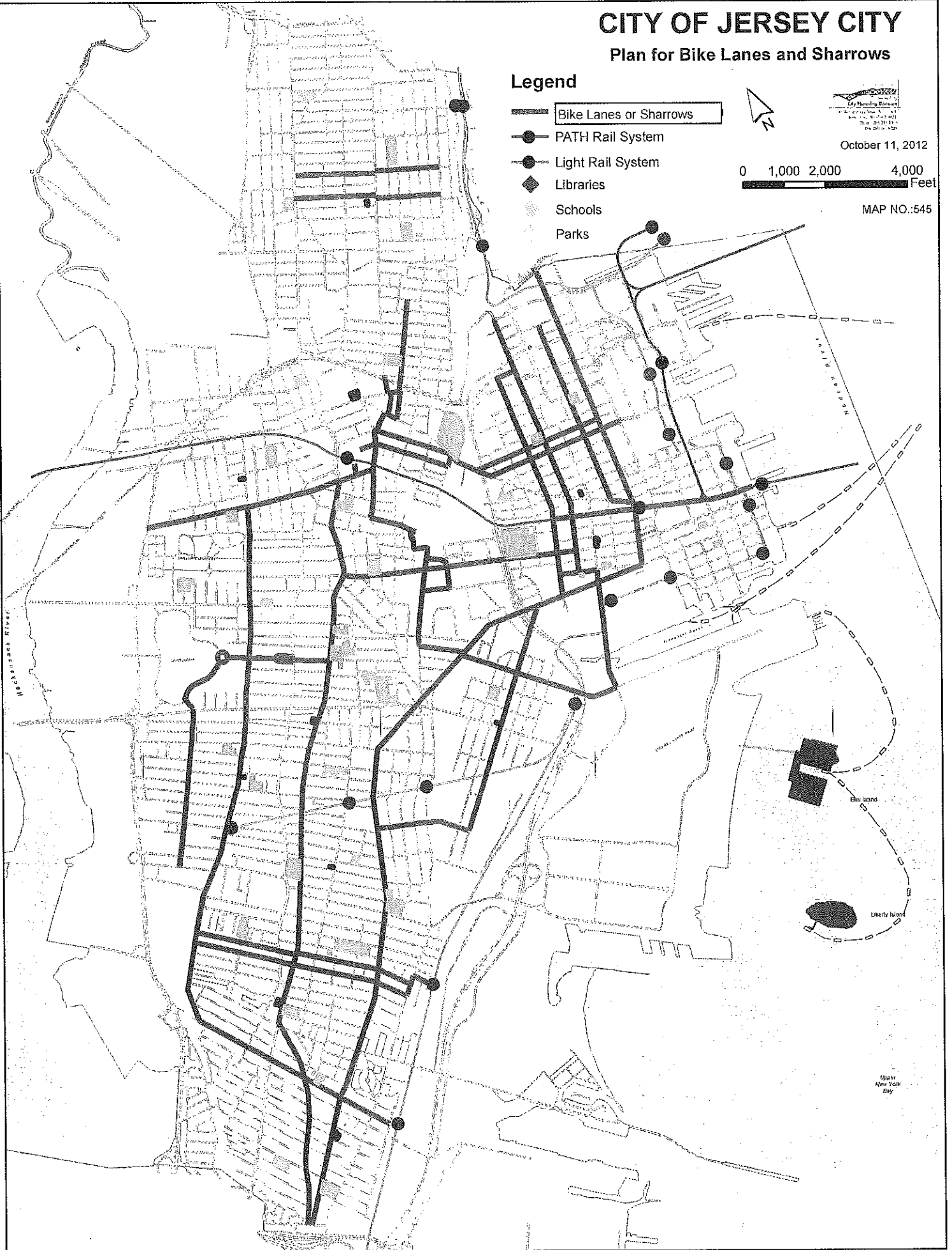

Upper New York Bay

# CITY OF JERSEY CITY

## Plan for Bike Lanes and Sharrows

### Legend

- Major Employment Centers
- ▭ Bike Lanes or Sharrows
- PATH Rail System
- Light Rail System

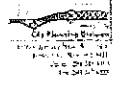

October 11, 2012

0 1,000 2,000 4,000 Feet

MAP NO.:545

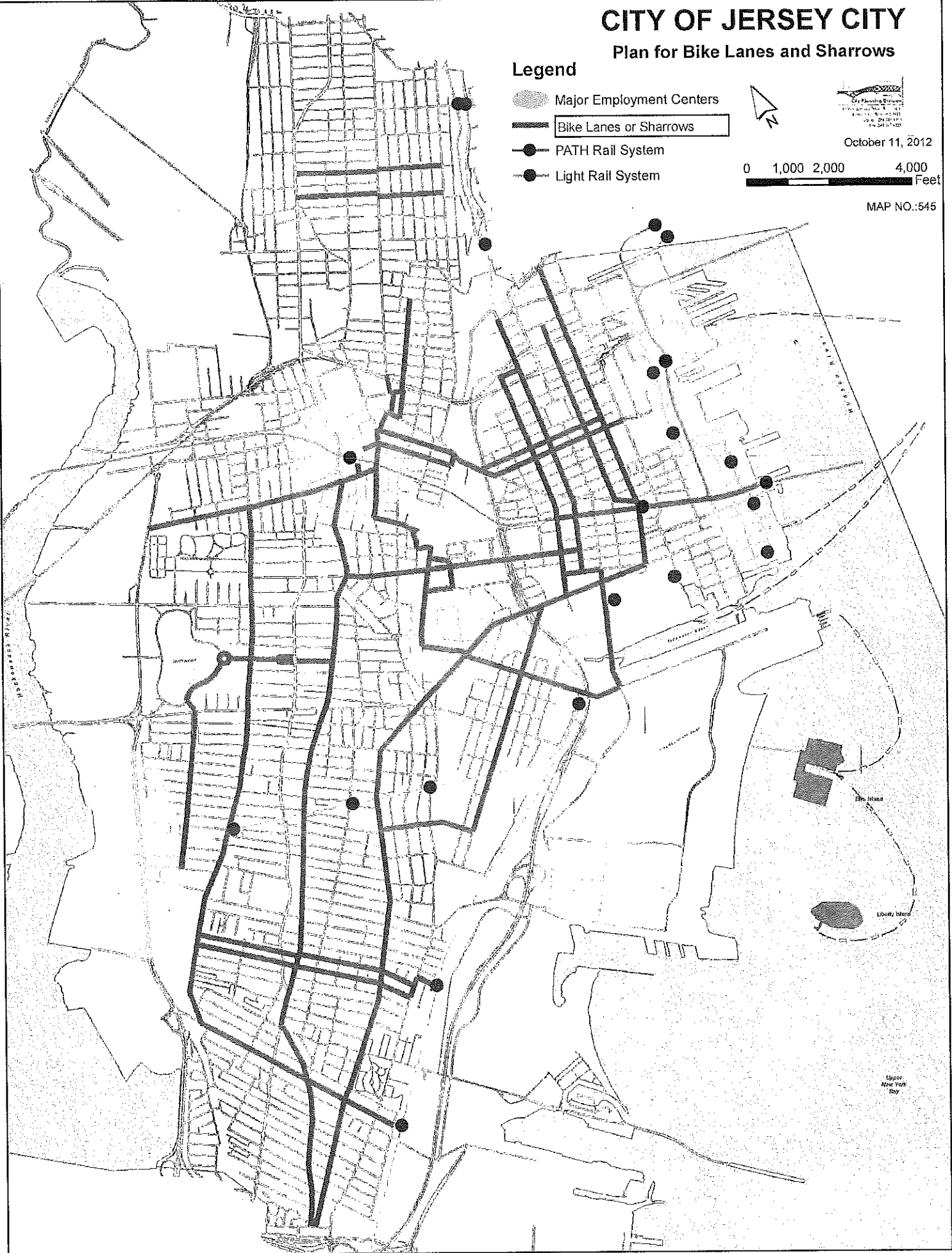

# CITY OF JERSEY CITY

## Plan for Bike Lanes and Sharrows

### Legend

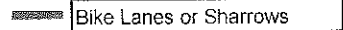
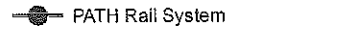
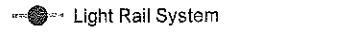
-  Bike Lanes or Sharrows
-  PATH Rail System
-  Light Rail System

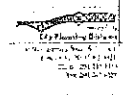

October 11, 2012



MAP NO.:545

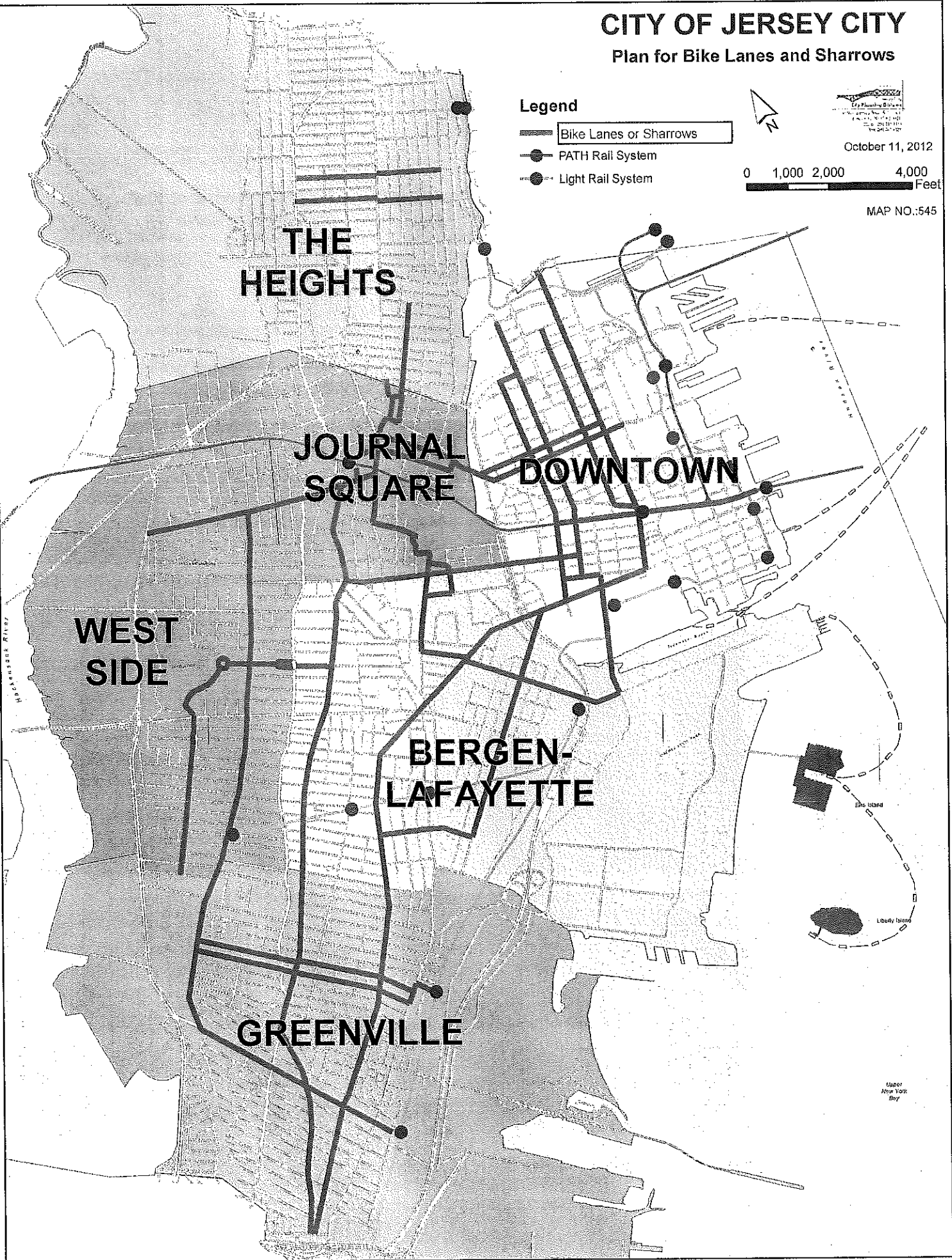

**THE HEIGHTS**

**JOURNAL SQUARE**

**DOWNTOWN**

**WEST SIDE**

**BERGEN-LAFAYETTE**

**GREENVILLE**

Upper New York Bay

**3.2.4 Goal 4: Create a city-wide pedestrian-friendly environment**

Jersey City strives to create a walkable City that is safe, secure, seamless and aesthetically-pleasing. The City aims to create a pedestrian-friendly environment that is accessible and meets the needs of all of its residents and visitors. To achieve this goal, the following Objectives should be met:

- Objective G4-1: Create a network of sidewalks, walkways and paths that allow pedestrians to walk between all neighborhoods and destinations in Jersey City.
- Objective G4-2: Provide a safe and secure environment for pedestrians.
- Objective G4-3: Create a comfortable, aesthetically-pleasing, and visually-interesting environment for pedestrians.
- Objective G4-4: Support and reinforce the existing culture of walking in Jersey City.
- Objective G4-5: Encourage walking as a means to reduce carbon emissions and to increase public health.
- Objective G4-6: Provide pedestrian linkages to all surrounding municipalities.

<b>Indicator:</b>	Linear miles of gaps in Hudson River Waterfront Walkway and Hackensack River Walkway (GIS data from August 2008, Hudson County Re-examination Report of Master Plan, and GIS data from the May 2004 Hudson County Hackensack RiverWalk Plan)
<b>Target:</b>	Zero gaps in walkways.
<b>Baseline:</b>	In 2004, there were 10.23 linear miles of gaps (i.e., areas with no permanent walkway or walkways currently under construction based on GIS data) in the Hudson River Waterfront Walkway and 3.3 linear miles of gaps in the proposed route of the Hackensack River Walkway.

<b>Indicator:</b>	Annual number of accidents reported that involved pedestrians in NJ Department of Transportation Crash Record Data per 1,000 residents, as measured by American Community Survey (ACS) Table No. B01003.
<b>Target:</b>	Annual decrease in number of accidents involving pedestrians occurring in Jersey City per 1,000 residents.
<b>Baseline:</b>	In 2007, there were 1.63 accidents involving pedestrians occurring in Jersey City per 1,000 residents, of which there were 0.37 accidents involving bicyclists occurring in Jersey City per 1,000 residents.

The Strategies to achieve Goal 4 are as follows:

- Strategy G4-A: Ensure that all streets have sidewalks.

- Strategy G4-B: Ensure that all sidewalks are of adequate width and have the capacity to carry current and anticipated future pedestrian volumes. Respect the integrity of historic districts.
- Strategy G4-C: Ensure that all sidewalks are well-maintained and well-lit.
- Strategy G4-D: Ensure an adequate number of pedestrian street crossings to minimize walking distances.
- Strategy G4-E: Locate and design street crossing in a manner that minimizes walking distances and the length of time that pedestrians are in the crosswalk by using narrow travel lane widths and curb extensions. Curb extensions should incorporate vertical elements, such as trees, utility poles, or street furniture, to provide a visual cue to alert snowplow drivers to the presence of curb extensions.
- Strategy G4-F: Fill in missing links between existing sidewalks, walkways and paths.
- Strategy G4-G: Complete Jersey City sections of regional walkways, greenways and trails.
- Strategy G4-H: Provide eyes on the street (and sidewalk, walkway and path) security.
- Strategy G4-I: Create safety buffers between pedestrians and moving vehicles.

The Actions that should be implemented to achieve Goal 4 are as follows:

- Action G4-1: Adopt as a City standard a street regulating plan that regulates the form of all streets, bike lanes, where feasible, and sidewalks in accordance with the street typologies and illustrated hierarchy of streets that are contained in this Circulation Element.
- Action G4-2: Install traffic calming devices on existing streets with problem locations in accordance with the traffic calming plan that is contained in this Circulation Element.
- Action G4-3: Adopt uniform City standards, which are ADA compliant and neighborhood appropriate, for pedestrian street crossings and crosswalks, including state-of-the-art techniques to protect pedestrian safety. For example, potential crosswalks may include a combination of crosswalk tables, curb extensions with gaps for drainage and bicycle lanes, polymer resin stamped brick crosswalks, and painted crosswalks as may be appropriate to the particular street. Curb extensions should incorporate vertical elements, such as trees or street furniture, to provide a visual cue to snowplow drivers of roadway alignments.
- Action G4-4: Install street trees spaced at a maximum of 30 feet on center to provide shade and a pleasant pedestrian environment and establish a municipal street tree fund to which developers can contribute when trees cannot be installed. Street trees should be of a variety with high branching systems so that lower branches may be pruned to maintain sight lines for public safety purposes.

- Action G4-5: Prune trees to remove low branches to provide lines of sight for vehicular and pedestrian safety and security.
- Action G4-6: Increase pedestrian safety by utilizing mechanisms, such as on-street parking, street trees, street furniture and bollards, to buffer pedestrians from moving vehicles.
- Action G4-7: Create a continuous greenway with pedestrian paths and bike lanes where the Morris Canal was filled in, where feasible.
- Action G4-8: As recommended in the Hudson River Waterfront Walkway Plan, an operating entity should be formed to ensure that walkway gaps are filled in and that the entire walkway is consistent in appearance and condition.
- Action G4-9: Construct the Lafayette Walkway parallel to the Hudson Bergen Light Rail Line.
- Action G4-10: Extend the Morris Street Right-of-Way Pedestrian Extension to the waterfront and the Hudson River Waterfront Walkway.
- Action G4-11: Continue the sidewalk on Bayview Avenue, east of the 14B interchange, by means of a designated pathway on the existing roadway, as recommended in the 2005 Liberty Access Study Final Report.
- Action G4-12: Conduct a focused study of Westside Avenue to determine the feasibility and appropriateness of Bus Rapid Transit (BRT), sidewalk widening, pedestrian safety measures and off-street parking.
- Action G4-13: Advance recommendations from NJTPA Walkable Community Workshop in the Lafayette neighborhood, including:
- a) Improving pedestrian access to the HBLR Liberty State Park station by reopening Maple Street and other walkways through the existing park-and-ride lot, constructing a sidewalk on the western edge of the park-and-ride lot, and creating a pedestrian entrance at the gated entrance on Duarte Drive and Communipaw Avenue.
  - b) Eliminating truck routes through the community along Pacific Avenue and Communipaw Avenue.
  - c) Constructing a greenway adjacent to the HBLR right-of-way with connection to the Morris Canal Greenway.
  - d) Replace missing street trees, especially along major pedestrian corridors.
- Action G4-14: Advance recommendations from NJTPA Regional Safety Priority Location Report for Central Avenue, including:
- a) At intersection with Ferry Street, add crosswalk, enhance existing crosswalk with crosshatching and post advance pedestrian crossing signs on Central Avenue.

- b) At signalized intersection with Manhattan Avenue, add pedestrian countdown heads and push buttons to the signal.
- c) At intersection with Franklin Street, replace curbing with full-height curb to separate sidewalk from street.
- d) At intersection with Hutton Street, install countdown pedestrian heads and actuation buttons.
- e) At intersection with Bowers Street, install "No Right Turn" signs on Central Avenue approach.
- f) Along Central Avenue between Jefferson Avenue and North Street, repaint crosswalks with crosshatching, install countdown pedestrian heads at all signalized intersections, install ADA pads at all crosswalk ramps, install signage to warn against wrong-way turns into one-way streets, and conduct analyses of lighting and illumination.

Action G4-15

Advance recommendations from NJTPA Regional Safety Priority Location Report for Martin Luther King Drive, including:

- a) Conduct a segment-wide program of pedestrian safety improvements on Martin Luther King Drive between McAdoo Avenue and Kearney Avenue. Pedestrian safety improvements may include:
  - 1. Spot sidewalk repairs to eliminate trip hazards.
  - 2. Installation of texture pads at ADA ramps.
  - 3. Improvements to signage by posting speed limit and pedestrian crossing warnings.
  - 4. Improvements to existing crosswalks by repainting with crosshatching, installing reflectors, and bringing all up to Jersey City's international painted crosswalk standard.
  - 5. Installation of sidewalk tree grates where missing, removal and storage of grates where trees are missing, and filling of planters with brick or gravel until replanted.
  - 6. Painting of curb and corner hatching to create visual refuge for parking lane ends and to emphasize corner sight distance clearance. Paint white stripe along the parking lane to visually restrict and calm the traffic lane.
  - 7. Improvements to bus stop safety and identity by painting yellow curbs at bus stop locations. Review specific bus stop locations to lessen potential traffic hazards.
  - 8. Relocation or removal of sidewalk obstructions (e.g., signs and other obstacles) that pose a hazard to pedestrian travel.
- b) At intersection with Bayview Avenue, install countdown pedestrian heads and replace damaged curbing.
- c) At intersection with Claremont Avenue, retime traffic signal and improve crosswalk visibility.
- d) At intersection with Bidwell Avenue, install new traffic signal and coordinate timing with adjacent Bayview Avenue intersection.



- Action G4-16 Continue Jersey City's involvement in the NJDOT Safe Routes to School program, which provides funding for pedestrian safety improvements near school sites.
- Action G4-17: Provide pedestrian access to Garfield Avenue HBLR station through Berry Lane Park.
- Action G4-18: Preserve the abandoned Lehigh Valley Railroad right-of-way to create greenway trails.
- Action G4-19: Construct the East Coast Greenway Route as an off-road facility for pedestrians, bicyclists, and other non-motorized means of travel between Hudson River and Hackensack River waterfronts. In the interim, complete on-road alignment.

**3.2.5 Goal 5: Create a city-wide bicycle-friendly environment**

In order to provide a bicycle-friendly environment, the City aims to improve the connectivity of bike routes both within the City and regionally and to provide amenities that support biking. The Circulation Element includes multiple initiatives that will support biking in Jersey City. Specifically, the East Coast Greenway Route is identified as a right-of-way need, and the Typical Roadway Sections include provisions for bike lanes. In order to further meet the Goal of providing a bicycle friendly environment, the following objectives should be achieved:

- Objective G5-1: Provide a comprehensive city-wide network of dedicated bike lanes and vehicle/bike share lanes.
- Objective G5-2: Improve connectivity between neighborhoods for bicyclists.
- Objective G5-3: Provide bicycle network linkages to all surrounding municipalities
- Objective G5-4: Provide recreational bike routes through parks and open spaces, where appropriate.
- Objective G5-5: Provide a robust set of bicycle system amenities to support bicycle usage.
- Objective G5-6: Create a safe and secure bicycling environment.
- Objective G5-7: Encourage bicycling as a means to reduce traffic congestion and carbon emissions and to improve public health.

<b>Indicator:</b>	Annual estimate of percentage of workers commuting to work by bicycle, as provided in American Community Survey (ACS) Table No. B08301, US Census Table No. P30 and private studies, if available.
<b>Target:</b>	Increase and maintain percentage of workers aged 16 and over commuting to work by bicycle, as measured by annual ACS estimates during inter-decennial years and future US Censuses.

<b>Baseline:</b>	0.03 percent of all Jersey City resident workers aged 16 and over commute to work by bicycle (2007 ACS).
<b>Baseline:</b>	In 2000, 0.25 percent of all Jersey City resident workers aged 16 and over commuted to work by bicycle (2000 US Census).
<b>Baseline:</b>	In 2008, 15.0 percent of Jersey City residents commuted to work by walking or biking (2008 Jersey City Survey, Marketing Segments 2 and 3).

<b>Indicator:</b>	Linear miles of striped bike lanes in Jersey City (source: Jersey City Division of Engineering)
<b>Target:</b>	Increase in linear miles of striped bike lanes in Jersey City.
<b>Baseline:</b>	In 2009, there were 0 linear miles of striped bike lanes in Jersey City.

<b>Indicator:</b>	Annual number of accidents involving bicyclists reported in NJ Department of Transportation Crash Record Date per 1,000 residents, as measured by American Community Survey (ACS) Table No.: B01003.
<b>Target:</b>	Annual decrease in number of accidents involving bicycles occurring in Jersey City per 1,000 residents.
<b>Baseline:</b>	In 2007, there were 0.37 accidents involving bicyclists occurring in Jersey City per 1,000 residents.

The Strategies to achieve Goal 5 are as follows:

Strategy G5-A: Create striped bicycle lanes and vehicle / bike share lanes on existing streets where feasible.

Strategy G5-B: Plan for continuing expansion of dedicated bicycle lanes and vehicle / bike share lanes as new streets are constructed.

Strategy G5-C: Fill in missing links in the street grid with public greenways or new streets.

Strategy G5-D: Complete Jersey City sections of regional greenways.

Strategy G5-E: Incorporate bicycle paths and bike lanes in the design of new parks and retrofit existing parks, where feasible.

Strategy G5-F: Raise public awareness of bicycling.

Strategy G5-G: Work collaboratively with property owners to implement bicycle system amenities. Seek grant funding for implementation of bicycle system amenities.

The Actions that should be implemented to achieve Goal 5 are as follows:

Action G5-1: Adopt as City standard a street regulating plan that regulates the form of all streets, bike lanes, where feasible, and sidewalks in accordance with the street typologies and illustrated hierarchy of streets that are contained in this Circulation Element.

Action G5-2: Construct the Jersey Avenue extension with provisions for bikes lanes.

Action G5-3: Create a continuous greenway with pedestrian paths and bike lanes where the Morris Canal was filled in, where feasible.

Action G5-4: Construct the East Coast Greenway Route as an off-road facility for pedestrians, bicyclists, and other non-motorized means of travel between Hudson River and Hackensack River waterfronts. In the interim, complete on-road alignment.

Action G5-5: Allow bicycles to use the Hudson River Waterfront Walkway and Hackensack RiverWalk, wherever feasible. Provide alternate routes to bypass areas where it is not feasible.

Action G5-6: Adopt zoning and redevelopment plan requirements to provide bicycle amenities for building users, such as interior bicycle storage facilities for residential buildings, that are accessible without stairs or tight corners; and bike racks and employee showers for commercial buildings.

Action G5-7: Work with Port Authority NYNJ, NJ TRANSIT, Jersey City Board of Education, Jersey City Department of Public Works, and commercial property owners to provide robust bicycle storage facilities at HBLR and PATH stations, schools, parks, employment centers and shopping districts citywide.

Action G5-8: Implement "Share the Road" campaign to educate bicyclists and drivers.

Action G5-9: Design and publish a foldable map of the existing signed bike routes for public distribution. Include recreational routes that highlight attractions and points of interest in Jersey City.

Action G5-10: Encourage development of Bike Share businesses with dedicated bike stations at key facilities.

Action G5-11: Organize an annual Jersey City bike tour.

Action G5-12: Create a linear park on the Sixth Street Embankment that incorporates a bike path and walkway. The linear park should share the Sixth Street Embankment with an extension of the HBLR.

Action G5-13: Construct a 0.4-mile railroad-gravel path paralleling the NJ TRANSIT Boonton Line and a 0.7-mile on-road striped bike lane along Westside



City of Jersey City



# MORRIS CANAL GREENWAY PLAN

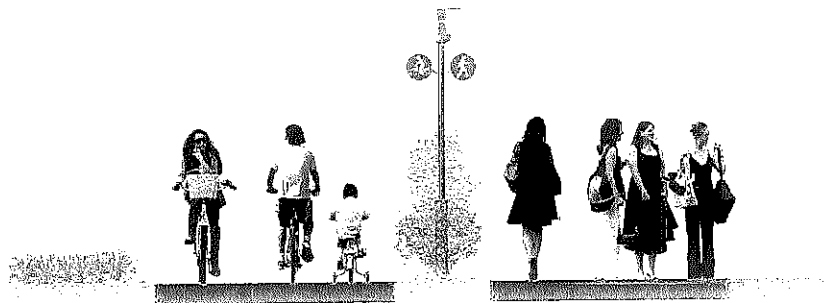

[View Full Plan Here](#)

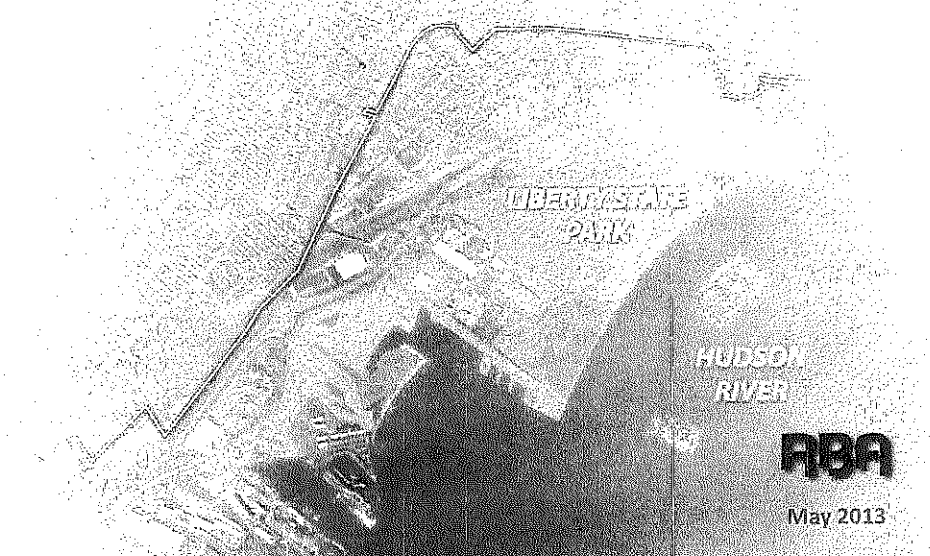

May 2013



## Morris Canal Greenway Plan



### Acknowledgements

#### City of Jersey City

**Mayor**  
The Honorable Jerramiah T. Healy

#### **City Council**

Peter Brennan, Council President  
Viola Richardson, Councilwoman-At-Large  
Rolando R. Lavarro, Jr., Councilman-At-Large  
Michael Sottolano, Ward A Councilman  
David Donnelly, Ward B Councilman  
Nidia Lopez, Ward C Councilwoman  
William Gaughan, Ward D Councilman  
Steven Fulop, Ward E Councilman  
Diane Coleman, Ward F Councilwoman

#### Steering Committee

**Bike JC**  
Chris Englese  
Kris Reiss

#### **Canal Society of New Jersey**

Bob Barth  
Joe Macasek  
Brian Morrell

#### **City of Bayonne**

John Fussa, PP

#### **City of Bayonne Municipal Utilities Authority**

Steve Gallo

#### **City of Jersey City Municipal Council**

Michael Sottolano

#### **City of Jersey City Division of Architecture**

Brian Weller, LLA, ASLA

#### **City of Jersey City Division of Business**

**Administration**  
Greg Corrado, CMFO

**Department of Housing, Economic Development  
and Commerce**  
Carl Czaplicki, Director

#### **Division of City Planning**

Robert D. Cotter, FAICP, PP, Director  
Naomi Hsu, AICP, PP, Senior Transportation Planner  
and Project Manager

#### City of Jersey City Division of City Planning

Brian Blazak  
Jeff Wenger, AICP  
Dan Wrieden

#### **City of Jersey City Division of Engineering**

Chuck Lee, PE  
Lee Klein, PE, PTOE  
Jeff Reeves, PE

#### **City of Jersey City Mayor's Office**

Doug Greenfield, AICP, PP

#### **Hudson County Division of Engineering**

John Lane

#### **Hudson County Division of Planning**

Massiel Ferrara, AICP, PP  
Francesca Giarratana  
Megan Massey, AICP, PP

#### **Hudson Transportation Management Association**

Jay DiDomenico

### Acknowledgements

#### Steering Committee (cont'd)

**Jersey City Landmarks Conservancy**  
John Hallanan  
John Hallanan, Jr.

#### **Jersey City Redevelopment Agency**

Ben Delisle  
Heather Kumer

#### **Liberty State Park**

Jonathan Luk, AICP, GISP  
Robert Rodriguez  
Michael Timpanaro

#### **NJ Department of Environmental Protection – Green Acres**

Steve Jandoli

#### **NJ Department of Environmental Protection – Historic Preservation Office**

Jonathan Kinney  
Kate Marcopul  
Vincent Maresca

#### Consultant Team

##### **The RBA Group**

Charlie Cunio, LLA  
Michael Dannemiller, PE  
Neil Desai, AICP  
Annette Schultz, AICP, PP, Project Manager  
Jackson Wandres, RLA  
Elizabeth Ward, AICP

##### **Heritage Strategies**

A. Elizabeth Watson, AICP

##### **AmerCom**

Atly Botas, PE  
Walter Conte, PE

**NJ Department of Transportation  
– Office of Bicycle and Pedestrian Programs**  
Joseph Powell

#### **NJ Department of Transportation – Bureau of Capital Program Development**

Vinay Varadarajan  
Tom Wospil

#### **NJ TRANSIT**

Mike Viscardi

#### **North Jersey Transportation Planning Authority**

Megan Kelly  
Scott Rowe, AICP, PP, CNU-A

#### **Port Authority of NY and NJ**

Lou Venech

#### **Town of Kearny (represented by Neglia Engineering)**

Kevin O'Sullivan  
Joe Vuich

#### Others

##### **Jersey City Free Public Library**

John Beekman

##### **Jersey City Economic Development Corporation**

Roberta Farber



Contents

Introduction ..... 1

Project Purpose and Scope of Work ..... 1

    A Greenway through Jersey City – a Future Vision ..... 1

    Plan Organization ..... 1

Regional Significance ..... 2

Stakeholder and Public Outreach ..... 3

    Stakeholder Input ..... 3

    Public Input ..... 3

Part 1: Alignment ..... 5

Existing Conditions along the Historic Morris Canal Alignment ..... 6

    Connectivity to Recreation Facilities & Community Features ..... 6

    Transportation ..... 7

    Historic Features, Properties & Districts ..... 7

    Environmental Conditions ..... 7

Methodology and Route Selection Criteria ..... 12

Proposed Long-Term Greenway Alignment ..... 13

Proposed Short-Term Greenway Alignment ..... 18

    Short-Term Route Roadway Characteristics ..... 20

Part 2: Design Guidelines for the Morris Canal Greenway in the City of Jersey City ..... 21

Introduction ..... 23

Context ..... 24

Vision ..... 25

Furnishings ..... 26

    Street Furniture ..... 26

    Signs ..... 27

    Lighting ..... 29

Landscape Approach ..... 30

    Street Trees ..... 30

    Promoting Tree Health ..... 31

    Sustainable Stormwater Management ..... 32

Materials ..... 33

    Surfacing ..... 33

    Edge Treatment ..... 33

Accommodating the Greenway on Streets ..... 34

    Bicycle Accommodations ..... 34

    Pedestrian Accommodations ..... 35

Accommodating the Greenway off Streets ..... 36

Public Art ..... 37

Part 3: Interpretive Development Plan ..... 38

    Morris Canal – An Historical Overview ..... 39

    Introduction ..... 39

    Benefits of Interpretation ..... 39

        Vision and Goals ..... 40

        Measures for Success ..... 40

    Background: The Morris Canal in Jersey City ..... 41

    Methodology for Interpretive Planning ..... 41

    Situation Analysis ..... 41

        Existing Interpretation ..... 41

    Existing Interpretive Themes, Audience, and Outreach ..... 45

        Existing Audiences ..... 45

        Existing Outreach ..... 45

    Potential Interpretive Concepts and Actions ..... 45

    Interpretive Topics and Recommendations ..... 46

        Telling Neighborhood Stories ..... 46

        School-based Education Programs ..... 47

        Circulation ..... 47

        Orientation ..... 47

        Leadership: Interpretive Partners ..... 47

Part 4: Implementation ..... 49

Introduction ..... 50

Updating Master Plans & Regulatory Tools ..... 50

    Circulation Element of the Jersey City Master Plan, 2009 ..... 50

    Jersey City Recreation and Open Space Master Plan, 2008 ..... 51

    Land Use Element of the Jersey City Master Plan, 2000 ..... 51

    Development Regulations ..... 51

Phasing Greenway Development ..... 52

Securing Right-of-Way ..... 58

    Short-Term Alignment ..... 58

    Long-Term Alignment ..... 58

    Prioritization ..... 59

Environmental and Cultural Impacts ..... 60

Costs, Funding, Management and Maintenance ..... 61

    Basis for On-Street Costs ..... 61

    Basis for Off-Street Costs ..... 62

Funding Greenway Development ..... 63

    Federal ..... 63

    State and Local ..... 63

    Others to Consider ..... 63

Long-Term Management Strategy ..... 63

Keeping it Lively: Early Action Items ..... 64



**MAPS**

- Map 1: Proposed Long-Term Alignment and Recreation Facilities & Community Features
- Map 2: Transportation Connections to the Long-Term Alignment
- Map 3: Historic Features, Properties and Districts
- Map 4: Environmental Conditions
- Map 5: Proposed Long-Term Alignment
- Map 6: Proposed Short-Term Alignment
- Map 7: Long-Term Implementation Segments

**TABLES**

- Table 1: Characteristics of the Proposed Long-Term Alignment
- Table 2: Roadway Characteristics of the Proposed Short-Term Alignment
- Table 3: Neighborhoods, Historic Resources, and Interpretive Sites in Jersey City in Proximity to the Morris Canal
- Table 4: Interpretive Themes Used by Liberty State Park
- Table 5: Potential Interpretive Partners and Roles for Leading Jersey City's Interpretive Presentation
- Table 6: Implementation Segments of the Long-Term Alignment
- Table 7: Early Action Recommendations and Strategies

**APPENDICES**

- A. Meeting Memos and Public Comments
- B. Descriptions and Map of Historic Features associated with the Historic Morris Canal Right-of-Way
- C. Proposed Long-Term Greenway Alignment on an Aerial Base Map
- D. Field Data Sheets
- E. Detailed Cost Estimate Tables
- F. Funding Sources
- G. Telling Neighborhood Stories with Public Art
- H. Resources related to the Morris Canal available at the New Jersey Room of the Jersey City Free Public Library
- I. Neighborhood Maps of Jersey City



## Introduction

### Project Purpose and Scope of Work

The City of Jersey City recognizes greenways as a way to provide open space, recreation and transportation opportunities. The 18½-mile Hudson River Waterfront Walkway is currently the only major off-street facility that can be used by bicyclists and pedestrians for long-distance travel, providing access to destinations along the eastern waterfront of Jersey City and beyond. The proposed Morris Canal Greenway would be a linear bicycling and walking route that can be used to access public destinations across the interior of the city and link the Hudson and Hackensack Rivers.

"With its 15 square miles, estimated population of 260,712 residents and highly-developed, multi-modal transportation system, Jersey City is arguably New Jersey's fastest-growing municipality and has one of the highest modal splits in the United States."  
*Circulation Element of the Jersey City Master Plan, Amended June 14, 2011*

The purpose of this study is to prepare a plan for a bicycle and pedestrian greenway that is, to the greatest extent possible, on the six-mile former right-of-way of the historic Morris Canal in Jersey City. Previous planning efforts that have contemplated a greenway on the Morris Canal alignment were piecemeal and a comprehensive approach was needed. Land uses and property ownership along the Morris Canal corridor have evolved and changed since 1836, when the canal section through Jersey City was first constructed. The alignment of the Morris Canal Greenway will be convenient to parks, schools, and neighborhoods as well as to the waterfront, commercial areas, and workplaces. As Jersey City's population is anticipated to grow dramatically in the coming years<sup>1</sup>, the addition of a greenway that spans the city would provide a valuable new transportation corridor and, like the Hudson River Waterfront Walkway, increase park, recreation and open space for residents and visitors. The *Circulation Element of the Jersey City Master Plan* references the Morris Canal Greenway as a facility that has the potential to address the need for improved circulation and recreational opportunities for bicycling and walking. A greenway on the Morris Canal is also consistent with the *City's Recreation and Open Space Master Plan*.



Located at the Essex Station of the Hudson-Bergen Light Rail in Jersey City, this sculpture portrays a slave family escaping across New Jersey on a Morris Canal boat.

The primary objective of this plan is to identify an alignment that will guide all parties critical to its implementation, including property owners, city government and others. Crossing many properties, the greenway will be a collaborative effort and its development will take place incrementally and over an extended timeframe. This document addresses the overall process, focusing on an alignment to be

achieved over the long-term.

The plan also addresses strategies for the short-term. Implementing a continuous Morris Canal Greenway route for bicycling and walking can make use of existing sidewalks and streets. The plan proposes a short-term alignment that follows the canal corridor closely. This will make it convenient to shift the route to the off-street segments as they are constructed.

### A Greenway through Jersey City – a Future Vision

Greenways are corridors of open space managed for conservation, recreation and transportation purposes. Greenways often follow natural land or water features, and link nature reserves, parks, cultural features, historic sites, and other public spaces with each other and with populated areas. The long-term vision for the Jersey City Morris Canal Greenway is an off-street facility to the greatest extent possible. However, sections of both the short-term and long-term greenway will include a combination of sidewalks, separated bikeways and shared-use paths to create one linear route that follows the historic canal alignment as closely as possible. Although the on-street sections will not be a 'greenway' in the traditional sense, for the purposes of this study, 'greenway' is used to describe both the on-street and off-street conditions.

The following vision describing the Morris Canal Greenway through Jersey City was developed by the project's Steering Committee.

*Stretching 8.5 miles around the southern half of the city, the Morris Canal Greenway in Jersey City is a world-class bicycle and pedestrian destination. Built upon one of Jersey City's greatest historic resources – the Morris Canal, the Greenway celebrates the City's industrial past while providing safe access for residents and visitors to neighborhoods, parks, schools, businesses, attractions, and transit. The Morris Canal Greenway is both an educational tool for displaying Jersey City's history and regional significance and a lasting source of community pride.*

### Plan Organization

The plan is presented in four parts:

Part 1, "Alignment" is a summary of two technical memorandums that were developed over the course of the project:

- Technical Memorandum 1: Data Findings, Opportunities and Constraints Mapping
- Technical Memorandum 2: Alignment Opportunities and Constraints

Part 1 covers the Morris Canal Greenway Vision and Goals that were crafted with the help of a project Steering Committee. A description of the public outreach efforts conducted throughout plan development is also included. Part 1 provides an overview of the methodology and route selection process, and presents both the proposed long-term and short-term alignments.

Part 2, "Design Guidelines," suggest materials, furnishings and design treatments to consider as greenway development advances. These concepts are intended as a guide for those who design each greenway

<sup>1</sup> NJTPA projects a 16% increase in Jersey City population, a 22.9% increase in households and a 19% increase in employment. Jersey City Master Plan Circulation Element, Amended June 14, 2011





segment. The greenway passes through a variety of land use contexts, e.g. residential, commercial, and industrial. There is not a "one size fits all" approach for design elements, although some elements can and should be applied consistently to reinforce the Morris Canal Greenway identity.

Part 3, "Interpretive Development Plan," lays out an approach and recommendations for interpreting the history of the greenway to the public, that is, telling the story of the Morris Canal. A collaborative approach to interpretive planning is critical to achieving a primary objective of the Morris Canal Greenway – the display of Jersey City's history and regional significance.

Part 4, "Implementation," presents strategies and recommendations that support greenway development. The plan outlines potential partnerships, funding opportunities, and cost estimates. Specific recommendations regarding ways to incorporate the greenway into redevelopment plans, the City's land development ordinance and master plans are also covered.

**The Morris Canal - A Waterway through the City**

In operation between 1831 and 1924, the Morris Canal stretched 102 miles across New Jersey connecting the coalfields of northeastern Pennsylvania with northern New Jersey's iron industry, major industrial cities, and the New York City markets. In 1831, the Morris Canal terminated in Newark at the Passaic River, but was extended through Jersey City in 1836. The Morris Canal in Jersey City traveled around the upland Palisades formation in the southern half of the city and linked the Hudson and Hackensack Rivers. This brought goods from Pennsylvania and northern New Jersey to the Hudson River Waterfront. It also brought new business and industries to Jersey City.

The Morris Canal was an engineering marvel of its time. Although flat through Jersey City, a system of 23 lift locks and 23 inclined planes enabled the Canal to overcome 1,674 feet of elevation change across northern New Jersey, more than any other transportation canal in the world. Its inclined planes served as a model for engineers from around the world. The Canal's historic engineering artifacts have been captured in the Historic American Engineering Record, a program established by the National Park, the American Society of Civil Engineers, and the Library of Congress to document historic mechanical and engineering artifacts.

Competition from faster, more efficient railroads at the end of the 19th century led to the Canal's decline, and eventually to its closing in the 1920s. The Morris Canal was crucial to the economy and development of northern New Jersey and is a significant historic feature of the State. In Jersey City, all sections of the Canal are listed on the State and National Registers of Historic Places.

**Regional Significance**

The Morris Canal Greenway can connect bicycle and pedestrian facilities within Jersey City, such as the paths in Lincoln Park, the East Coast Greenway, the Liberty-Water Gap Trail, the Hudson River Waterfront Walkway, the City's growing on-street bicycle network, and the planned park and walkway along the Hackensack River. Furthermore, there may be opportunities to connect the Morris Canal Greenway beyond Jersey City. There has been a long-standing effort to establish a contiguous greenway across the state of New Jersey along the 102 mile path of the historic Morris Canal. Various municipalities and counties across the state have created public spaces along the path of the Morris Canal.

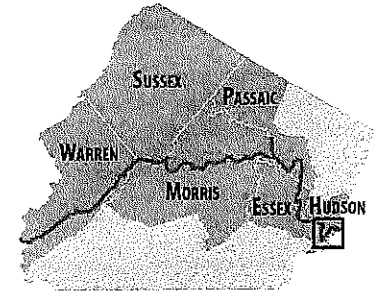

The historic Morris Canal ROW across New Jersey. The section of the canal in Jersey City is shown in the black box.

Creating a greenway on the former Morris Canal will benefit residents and visitors alike. Greenways support healthy lifestyles and improve communities by providing not only recreation and transportation opportunities, but also by influencing economic and community development. The Morris Canal Greenway Steering Committee identified these benefits from developing the greenway:

- Improved public health from expanded recreational amenities and access to open space
- Growth in the number of residents walking and bicycling for recreation and transportation
- Greater awareness of existing attractions and the creation of a new destination
- Renewed connection between the community and its history
- Preservation of culturally and historically valuable sites
- Restoration and enhancement of the natural environment through green infrastructure
- Support the local economy by attracting visitors interested in heritage and ecotourism
- Connections within Jersey City and between the City and the surrounding communities



### Stakeholder and Public Outreach

Public participation was an important component throughout the development of this study. Community involvement for this project can be divided into two groups, stakeholder and public. Engaging stakeholders and the public involved a combination of coordinated strategies.

- Outreach Activities**
- Steering Committee
  - Stakeholder Interviews
  - Focus Group Meetings
  - Project Website
  - Public Meetings

#### Stakeholder Input

##### Steering Committee

The first step in the outreach process was to establish a Steering Committee to guide the project and provide input and feedback throughout the project's duration. The Steering Committee included representatives from agencies whose involvement and support are necessary to advance the greenway including Jersey City Mayor's Office, Jersey City Division of City Planning, Jersey City Redevelopment Agency, Jersey City Division of Engineering, Jersey City Department of Business Administration, Jersey City Division of Architecture, NJDEP, NJDOT Office of Bicycle and Pedestrian Programs, NJDOT Capital Investment Planning, NJ TRANSIT, NJTPA, Port Authority of NY and NJ, Liberty State Park, Hudson County Division of Planning, Hudson County Division of Engineering, Hudson Transportation Management Agency (TMA), Town of Kearny, City of Bayonne, Canal Society of New Jersey, Jersey City Landmarks Conservancy, and Bike JC.



Steering Committee members identify opportunities and constraints along the Morris Canal Alignment

Responsibilities of the Steering Committee included:

- Developing, guiding and participating in community involvement activities.
- Providing relevant documents and data to the project team.
- Reviewing and providing feedback on draft and final project interim reports and documents throughout the study.

Four steering committee meetings were held during the project. The purpose of the first meeting was to establish a greenway vision, review the original Morris Canal alignment, identify route selection criteria, discuss opportunities and constraints that influence the greenway alignment, share data and information, and confirm a plan to engage the public and stakeholders in the greenway planning process.

The purpose of the second meeting was to review existing conditions, present the methodology used to develop potential alignments, get feedback on the preliminary proposed short-term and long-term alignments, discuss the purpose of design guidelines, and inform attendees of the first public workshop.

The purpose of the third meeting was to review and discuss the draft Design Guidelines, present an overview of the draft Interpretive Development Plan, explain the revised proposed short-term and long-term alignments, and talk about implementation strategies.

The purpose of the fourth and final steering committee meeting was to review the final draft plan and implementation strategies and prepare for the second public workshop. Meeting memoranda for all steering committee meetings are in the appendices of this report.

##### Stakeholder Interviews

Interviews with key stakeholders were conducted during the development of the Interpretive Development Plan to obtain insights about interpretive resources and themes. Discussions were held with representatives from Liberty State Park, Canal Society of New Jersey, the New Jersey Room of the Jersey City Free Public Library New Jersey Room, Jersey City Economic Development Corporation, and the Jersey City Landmarks Conservancy. These conversations provided insight into historical context and related local activities and organizations.

##### Focus Group Meetings

During a project, it is important to reach out to specific populations and agencies that may have special concerns and interests related to the project. Two targeted meetings/focus groups were held during the project's planning process with representatives of City offices and agencies. The purpose of the first focus group meeting was to finalize the long-term route, including refining the greenway alignments through redevelopment plan areas and city properties. Potential obstacles were identified and the status of redevelopment and city projects were discussed. The second focus group meeting was a discussion of potential appropriate actions, responsible parties, time frame, and phasing for implementation. The participants' input helped craft a feasible strategy for implementation that considers constraints and opportunities.

#### Public Input

##### Project Website ([www.jcmcgreenway.org](http://www.jcmcgreenway.org))

A project website was used to extend the reach of community involvement. The website served as a repository of information, a venue for discussion, and a place to get the latest project updates and news. Steering Committee meeting memos, public meeting notices, and draft work products were posted on the website. An interactive map permitted the public to identify specific locations and make notes and comments about that location to inform the plan. Another important feature of the website was the ability to subscribe to the website for automatic notification when new materials

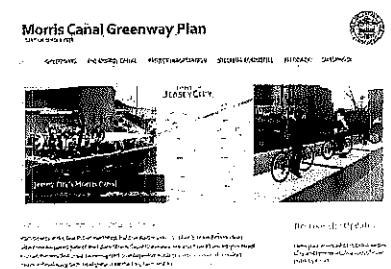

The project website homepage



were posted. This served those outside of the Steering Committee who were interested in following the planning process beyond attending the two public workshops. Contact information was posted to allow comment throughout the process. Key sections of the site were in both Spanish and English.

*Public Meetings*

Two public outreach meetings were held over the course of the project. The first public workshop was held on October 3, 2012, to introduce the project to the public and to provide an opportunity for public input on the alignment options, future design, and any other perspectives that might inform the development of the plan. The workshop was divided into three formats – open house, presentations, and interactive mapping exercise. The meeting formats gave opportunities for both one-on-one and group discussion. In addition, attendees were provided with comment sheets.



Attendees participating in a mapping exercise during the first public meeting.

A second public meeting was held on May 15, 2013, to review the draft final report, including the Design Guidelines and the implementation strategies. The emphasis of the meeting was on “getting the word out” and generating public enthusiasm for the Morris Canal Greenway and an understanding of how it will look, how it will be constructed, and ways to participate in the process. The format of the second public meeting was an open house with a formal presentation midway.

The meetings were advertised on the project website, the City’s website, and on the cultural calendar of the Jersey City Independent online newspaper. Display ads were published in *The Jersey Journal*. Steering Committee members distributed information and extended invitations to the organizations they represented. Flyers were prepared and distributed. The City issued press releases to announce the meetings.

Workshop materials were available in English and Spanish.



Map 7: Long-Term Implementation Segments

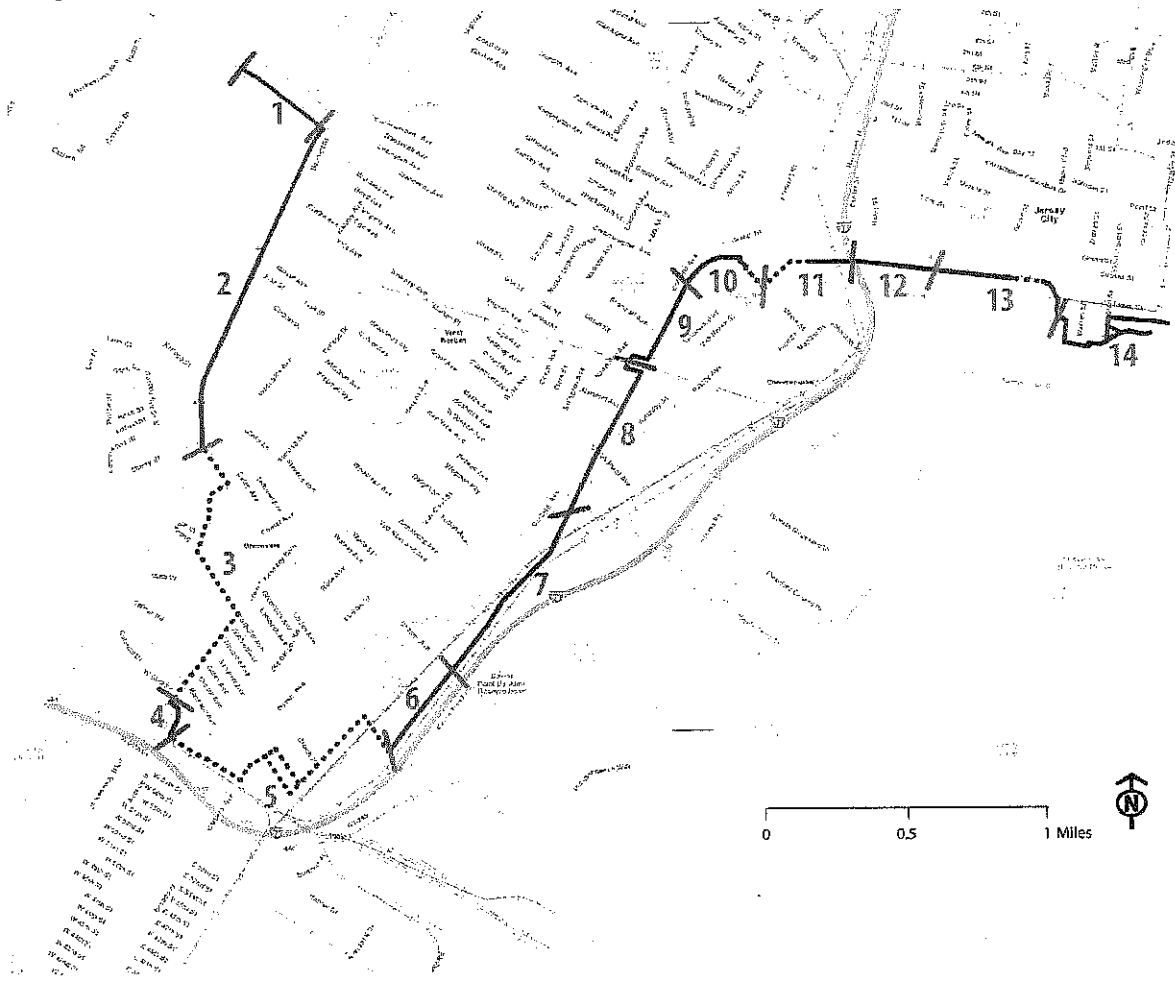

Jersey City  
 Morris Canal Greenway Plan  
**Long-Term  
 Implementation Segments**



Legend

- Long-Term Alignment Off-Street
- ..... Long-Term Alignment On-Street
- | | Long-Term Implementation Segment
- 14 Implementation Segment Number

RBA

RBA



## Morris Canal Greenway Plan

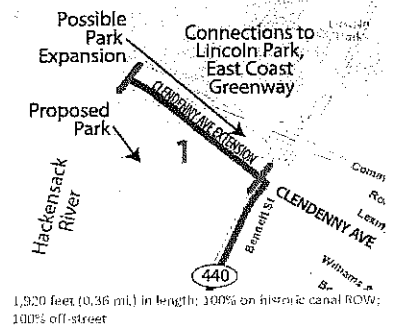

Table 6: Implementation Segments of the Long-Term Alignment

Segment Name	Length in Feet	
	On-street	Off-Street
1 Hackensack River to Route 440		1,920
2 Route 440 between Clendenny Avenue and Danforth Avenue		6,600
3 Route 440 and Danforth Avenue to JFK Boulevard and Mercer Park	5,850	
4 Hudson County's Mercer Park		760
5 Mercer Park and Merritt St to Danforth Transit Village Redevelopment Plan Area	6,900	
6 Danforth Transit Village Redevelopment Plan Area		1,980
7 Claremont Industrial Redevelopment Plan Area		3,439
8 Canal Crossing Redevelopment Plan Area		3,377
9 Berry Lane Park		2,090
10 Communipaw Avenue to Van Horne Street around Whitlock Cordage Complex	490	1,380
11 Van Horne Street and Maple Street to Grand Jersey Redevelopment Plan Area	1,075	291
12 Grand Jersey Redevelopment Plan Area		1,579
13 Liberty Harbor North Redevelopment Plan Area	650	2,405
14 HRWW to the Morris Canal Section of Liberty State Park and Colgate Park		4,000
<b>Total</b>	<b>14,965'</b> <b>or 2.8 mi.</b>	<b>29,921'</b> <b>or 5.7 mi.</b>
	<b>44,886' or 8.5 mi.</b>	

### Segment 1: Hackensack River to Route 440

- The long-term greenway alignment through this section follows the historic canal path on top of Clendenny Avenue Extension, a paper street<sup>9</sup>.
- The City's 2008 *Recreation and Open Space Master Plan* identifies the parcels immediately to the north of the Clendenny Avenue Extension in the list of 'Acquisition Recommendations to Create New City Parks' (pg. 139).
- The Locally Preferred Alternative (LPA) identified in *The Route 440/Routes 1&9T Multi-Use Urban Boulevard and Through Truck Diversion Concept Development Study* includes developing part of the Clendenny Avenue Extension into a street.



### Implementation Notes:

- Alignment goes partly through the future site of the Hackensack River Greenway Park.
- The City's 2008 *Recreation and Open Space Master Plan* recommends reconstructing the western entry/exit portion of the canal as part of the Hackensack River Greenway Park. In order to remain 100% off-street, the alignment may have to move north of the historic canal alignment through the area recommended as part of the Hackensack River Greenway Park Expansion.
- Environmental permitting will be required due to the presence of wetlands.

### Segment 2: Route 440 between Clendenny Avenue and Danforth Avenue

- The proposed long-term alignment through this section follows the historic canal path on top of Route 440.
- The Route 440/Routes 1&9T Multi-Use Urban Boulevard and Through Truck Diversion Concept Development Study* identifies a LPA for this section of Route 440 that includes 12' wide sidewalks and a buffered two-way bikeway (cycle track) in each direction of travel.
- The greenway would connect to the planned New Jersey City University west campus expansion, the Bayfront Redevelopment Plan area, as well as other proposed development along the Route 440 corridor.

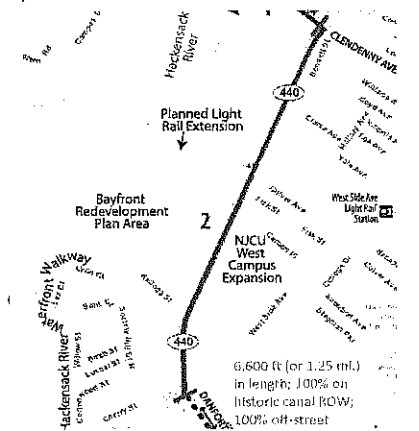

<sup>9</sup> A paper street is a street that appears on maps but does not exist in reality. The Clendenny Avenue extension appears on the City's tax maps.



# Morris Canal Greenway Plan



### Implementation Notes:

- This segment will be included as part of the future reconstruction of Route 440 as a multi-use urban boulevard. It is considered off-street based on the separated bicycle facility presented in the conceptual plan.

Route 440 Boulevard Concept Section Detail

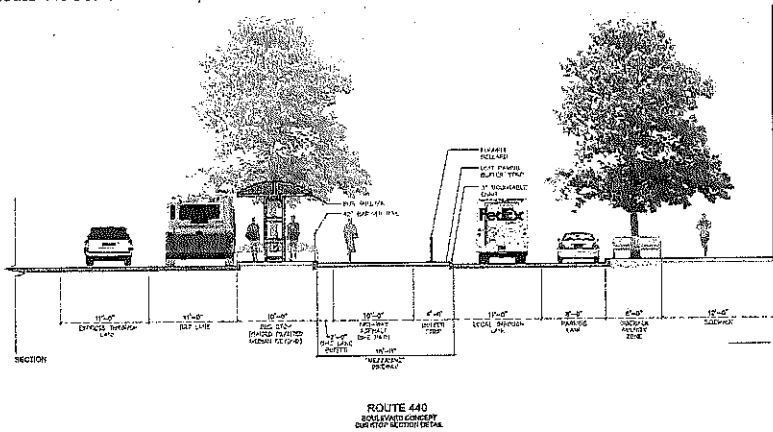

### Segment 3: Intersection of Route 440 and Danforth Avenue to John F. Kennedy Boulevard and Mercer Park

- This section of the proposed alignment is the same for both the short-term and long-term.
- The alignment follows Danforth Avenue, Sullivan Drive, Bartholdi Avenue and JFK Blvd.
- Possible connections include Columbia Park, Our Lady-Mercy Catholic School, and bus stops along JFK Blvd.
- The historic Morris Canal alignment is located through the Country Village neighborhood through this segment. Routing the greenway off-street on top of the historic canal alignment might be considered in the future pending public support.

### Implementation Notes:

- A contraflow bicycle lane should be considered to accommodate eastbound bicycle traffic on Bartholdi Avenue, which is one way westbound between JFK Boulevard and Romar Avenue.

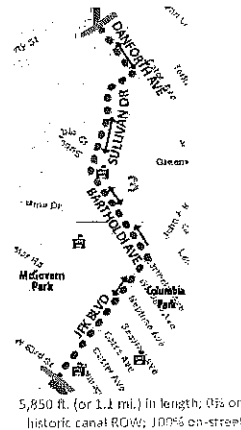

### Segment 4: Hudson County's Mercer Park

- This segment of the greenway is the same for the short- and long-term proposed alignments.
- This segment of the proposed greenway travels alongside, approximately 40' west of, the historic canal along an existing off-street path through Hudson County's Mercer Park.

### Implementation Notes:

- This park could be a candidate for an interpretive exhibit.



### Segment 5: Mercer Park and Merritt Street to Danforth Transit Village Redevelopment Plan Area

- This segment of the greenway is the same for the short-term and long-term proposed alignments.
- The route continues north of the historic canal ROW along the local street network utilizing Merritt Street, Gates Avenue, Seaview Avenue, Princeton Avenue, and Linden Avenue.

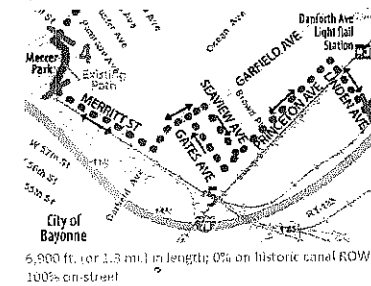

### Implementation Notes:

- Provides connections to the City of Bayonne, Mercer Park, and the Danforth Avenue Light Rail station.
- There are plans to reconstruct the NJ Turnpike 14A exit, which may be an opportunity to include pedestrian and bicycle access to the Fiddler's Elbow section of the original Morris Canal alignment in this area.
- A contraflow bicycle lane along the south side of Gates Avenue could be used to accommodate two-way bicycle travel as an alternate to routing the greenway along the one-way couplet of Gates and Seaview Avenues.



## Morris Canal Greenway Plan



### Segment 6: Danforth Transit Village Redevelopment Plan Area (Linden Ave to Chapel Ave)

- The Morris Canal historic alignment is located in the center of the Danforth Transit Village Redevelopment Plan area. Therefore, the greenway alignment has been moved one parcel east of the historic alignment in order to maintain development potential.

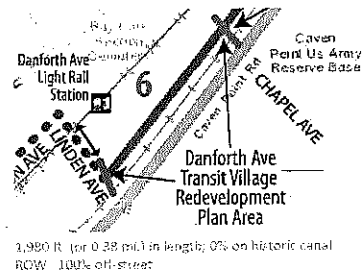

### Segment 7: Claremont Industrial Redevelopment Plan Area (Chapel Avenue to Bayview Avenue)

- This segment of the proposed long-term route is located entirely within the Claremont Redevelopment Plan Area.
- Like the Danforth Transit Village Redevelopment Area, the historic canal alignment is located in the middle of the Claremont Industrial Redevelopment Area. Therefore, the alignment through a third of this section has also been moved to the east of the historic canal in order to maintain development potential.
- Remnant concrete abutments and piers of the bridge built during the early 20<sup>th</sup> century to carry the Lehigh Valley Railroad's National Docks Railway over the canal offer an opportunity for historic interpretation.

#### Implementation Notes:

- A new crossing of the Hudson-Bergen Light Rail is required. If the rail crossing cannot be created, a new alignment through this segment would have to be proposed.
- The remnant concrete abutments and piers of the bridge have potential as an interpretive site.

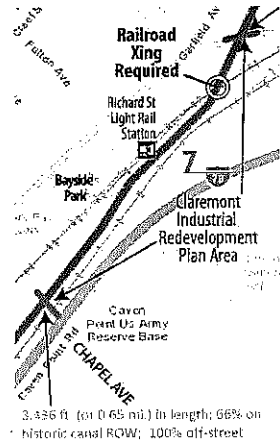

### Segment 8: Canal Crossing Redevelopment Plan Area (Bayview Avenue to the HBLR tracks)

- The long-term greenway alignment follows the historic canal path through this segment.
- The path leaves the historic canal alignment in order to get around the Hudson Bergen Light Rail embankment between the Canal Crossing Redevelopment Area and Berry Lane Park to the north. The light rail embankment includes a 54" water main that prevents the greenway from going through. Therefore, the greenway will need to be routed to Garfield Avenue for approximately 60 feet to get around the embankment. It is proposed that the sidewalk along Garfield Avenue be at least 10', preferably 15' wide in order to accommodate both pedestrians and bicyclists.

#### Implementation Notes:

- According to the Jersey City Redevelopment Agency website, "a prime open space feature of the Canal Crossing neighborhood will be the creation of 'Canal Way', an expansive green way built over the former bed of the Morris Canal. A site-wide infrastructure plan, including consideration of a new street grid (including Canal Way), open space, grading, stormwater management, and utilities is under development.

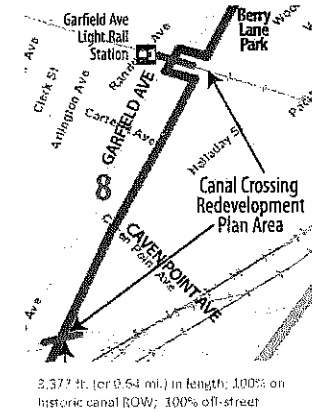

### Segment 9: Berry Lane Park (HBLR tracks to Communipaw Ave)

- The long-term greenway alignment follows the historic canal path closely through Berry Lane Park.

#### Implementation Notes:

- Berry Lane Park is currently under construction. Design plans include an off-street greenway facility.

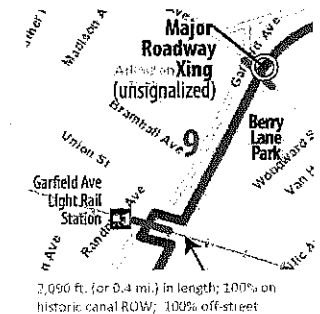



# Morris Canal Greenway Plan



### Segment 10: Whitlock Cordage (Communipaw Ave. to Van Horne St.)

- After crossing Communipaw Avenue at an unsignalized location, the long-term alignment continues off-street on top of the historic canal ROW behind the Whitlock Cordage Complex. Then, the greenway continues along the northern edge of Lafayette (Ercei Webb) Park.
- The greenway must leave the historic canal ROW because the Jersey City Regional Day School is built on top of the historic canal ROW.

#### Implementation Notes:

- The alignment crosses Communipaw Avenue at an unsignalized location. When designing a crossing it is important to ensure that drivers are aware of the presence of greenway users and that greenway users are aware they are crossing a roadway. This can be accomplished with signage, striping, median refuges and/or signals. An engineering study is required before improvements to crossings are made.
- The Jersey City Redevelopment Agency (JCRA) has surveyed and planned the segment of the greenway that travels around the Whitlock Cordage Complex. The Whitlock Cordage Complex was developed on the canal in 1855 and could be a potential site for historic interpretation.
- Maple Street, along the northern edge of the park, is one-way westbound.

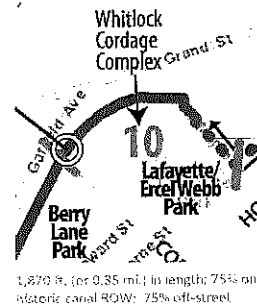

### Segment 11: Van Horne and Maple Streets to Grand Jersey Redevelopment Plan Area

- The long-term alignment through this section utilizes the existing sidewalk located on top of the former Morris Canal alignment through Lafayette Village, a Jersey City Housing Authority community.
- The path crosses Pacific Avenue at an unsignalized location near the National Docks Railway/Morris Canal and Pacific Avenue Bridge. This steel truss bridge was completed in 1909 to carry the Lehigh Valley Railroad's National Docks Railway over the Morris Canal and Pacific Avenue.

#### Implementation Notes:

- In order to accommodate both pedestrian and bicyclist traffic, the existing sidewalk through Lafayette Village should be widened to a preferred minimum width of 10'.
- The crossing at Pacific Avenue is unsignalized. An engineering study is required before improvements to crossings are made.
- The greenway travels under the Turnpike Extension.

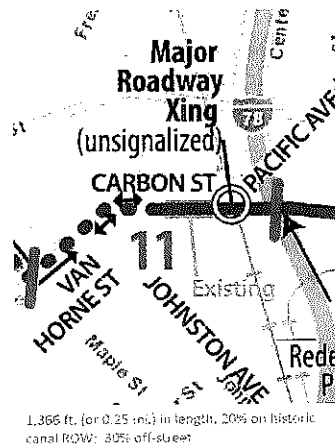

### Segment 12: Grand Jersey Redevelopment Plan Area (Under the Turnpike Extension to Jersey Avenue)

- The proposed alignment will follow the proposed street grid for the Redevelopment Area.
- Destinations in this segment include the Jersey City Medical Center and Liberty State Park.

#### Implementation Notes:

- It is recommended that the street grid include bicycle and pedestrian facilities separated from motor vehicle traffic.

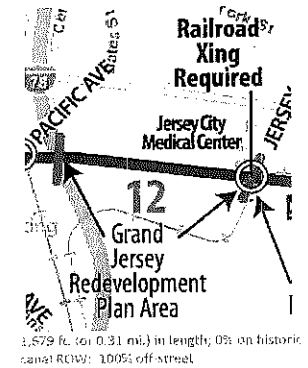

### Segment 13: Liberty North Redevelopment Plan Area (Jersey Avenue to the Hudson River Waterfront Walkway)

- After crossing Jersey Avenue at an unsignalized intersection, the greenway alignment enters the Liberty Harbor North Redevelopment Plan Area. Through this area, the long-term alignment will parallel the Hudson Bergen Light Rail tracks to the south before sharing an alignment with the Hudson River Waterfront Walkway (HRWW).
- While it is assumed that the path paralleling the light rail tracks will be off-street, the greenway will most likely have to be routed on-street along the 18 Park development currently under construction at the corner of Marin Boulevard and the Marin Boulevard Light Rail Station. The streetscape plan for 18 Park includes a one-way eastbound street, Morris Boulevard, between the building and the light rail tracks and platform.

#### Implementation Notes:

- This section will require a new at-grade crossing of the light rail tracks at Jersey Avenue.
- The existing path should be widened to a minimum of 10'.
- There is an existing outline of a full-size canal boat in the pavement along the harbor at the beginning of the HRWW. This interpretive site could be augmented.

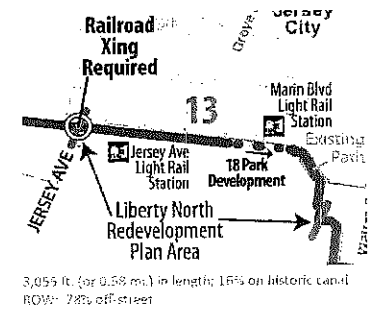





Segment 14: Hudson River Waterfront Walkway (HRWW) to the Morris Canal Section of Liberty State Park and Colgate Park

- It is proposed that the Morris Canal Greenway utilizes the completed HRWW before entering the Morris Canal Section of Liberty State Park.
- While the former Morris Canal path is located north of the proposed long-term alignment along Dudley Street, the HRWW was chosen as the proposed route because there is an existing off-street facility.
- Based on input from the Steering Committee, it was determined that both Colgate Park and the Morris Canal Section of Liberty State Park should serve as the eastern termini of the Morris Canal Greenway in Jersey City. Adding this terminus provides a stronger connection to the HRWW.

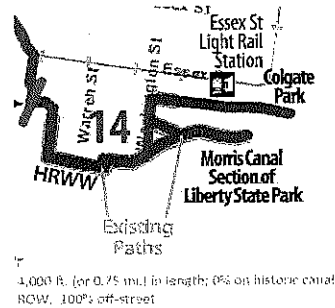

Implementation Notes:

- The HRWW segment connecting Washington Street to Colgate Park is currently under construction.
- Dudley Street should be acknowledged as the historic canal ROW, possibly through an interpretive site or signage.
- The Morris Canal Section of Liberty State Park, as the terminus of the Morris Canal Greenway in Jersey City as well as the statewide Morris Canal ROW, should be improved and featured as a destination.

Securing Right-of-Way

Short-Term Alignment

The Morris Canal Greenway Plan proposes a short-term alignment that is almost entirely on public streets. The processes to establish bicycle and pedestrian facilities associated with the greenway can be developed in conjunction with implementation of the recommendations developed by the Jersey City Bike Infrastructure Working Group of September 2012. The Working Group was formed by the City to develop a comprehensive bike program, including 35 miles of bike lanes and 19 miles of shared lanes. Implementing the on-street alignment requires that the route be made as bicycle-friendly as possible, with separate facilities for bicycling and continuous sidewalks and pathways with pedestrian-friendly street crossings at intersections.

Because the short-term alignment does not require right-of-way (ROW), this phase can be established quickly and will help to raise public awareness of the long-term plans to develop the Morris Canal Greenway. The on-street alignment is an opportunity to begin "branding" the greenway, giving it a unique identity that is immediately recognizable. The plan's Design Guidelines suggest some strategies to brand the Morris Canal Greenway, such as formally adopting a set of guidelines for a logo and distinctive design elements for both bicyclist and pedestrian wayfinding. The short-term alignment presents the opportunity to apply strategies for recognizing and interpreting Morris Canal history through exhibits, markers, and public art.

The short-term alignment also includes an off-road segment in Berry Lane Park. The Berry Lane Park property is already in public ownership; owned by the city, it is currently under construction. This is a tremendous opportunity to begin establishing the Morris Canal Greenway brand for off-street segments, showcasing the greenway and making the public aware of plans for a city-wide greenway.

Long-Term Alignment

The Morris Canal Greenway Plan proposes a long-term alignment that is as close as possible to the canal's original alignment while taking into account opportunities that would facilitate implementation (e.g., making use of parks and public right-of-ways) or constraints that would deter implementation (e.g., impacting wetlands, new railroad crossings). The entire length is approximately 8.5 miles, with 40% on the historic canal ROW; 67% off-street; and 36% in redevelopment plan areas.

The draft plan was prepared with the expectation that the proposed long-term greenway alignment would be adjusted over time as development occurs. There will need to be flexibility in the process. The location of the greenway will be finalized (and constructed) on a case-by-case basis over time, and the alignment may need to shift to a more practical location. The intent is to maintain a continuous alignment while minimizing the bifurcation of parcels into sites that are unattractive or impossible to develop.

Bikeways Application 2019  
BIKE-2019-Jersey City Morris Canal Greenway -00061  
Total Estimated Cost of Improvement

Construction Cost: \$529,100.00

Please attach a Detailed Construction Cost Estimate  
(Word, Excel, or PDF format please)

[https://njsage.intelligrants.com/Upload/1892581\\_1530844-CostEstimate-FY2019JCBikeways.pdf](https://njsage.intelligrants.com/Upload/1892581_1530844-CostEstimate-FY2019JCBikeways.pdf)

Design Engineering: \$52,910.00  
(List only if eligible for Urban Aid or as a Depressed Rural Center)

Right-of-Way: \$0  
(List only if eligible for Urban Aid or as a Depressed Rural Center)

Construction Inspection and Material Testing if requesting: \$79,365.00  
(15% of the final allowable construction cost maximum)

**Total Estimated Cost:** \$661,375.00

**Total Requested Amount** \$661,375.00

Jersey City Redevelopment Agency  
 66 York Street - 3rd floor  
 Jersey City, NJ 07302

Project Name **Morris Canal Greenway**  
 Project Number Segment 3  
 Prepared By Ben Delisle

**Preliminary Construction Cost Estimate - Segment 3**

ITEM	DESCRIPTION	QTY.	UNIT	UNIT PRICE	TOTAL
<b>Site Preparation/Earthwork</b>					
1	Mobilization	1	EA	\$15,000.00	\$15,000.00
2	Clearing and grubbing	1	LS	\$25,000.00	\$25,000.00
3	remove existing concrete curb/sidewalk/wall	1	LS	\$25,000.00	\$25,000.00
4	remove existing pavement	1	LS	\$10,000.00	\$10,000.00
5	Sawcut asphalt pavement	1,000	LF	\$6.00	\$6,000.00
6	Grading and earthwork (rough/final grading)	1	LS	\$35,000.00	\$35,000.00
7	Maintenance and protection of traffic	1	LS	\$5,000.00	\$5,000.00
8	Disposal of historic fill (ID-27)	1,000	TON	\$70.00	\$70,000.00
<b>Soil Erosion &amp; Sediment Control Measures</b>					
9	Inlet protection	10	UNIT	\$100.00	\$1,000.00
10	Silt fence	9,000	LF	\$3.00	\$27,000.00
11	Stabilized construction entrance	3	LS	\$2,500.00	\$7,500.00
<b>Stormwater Management</b>					
12	12" corrugated polyethylene pipe	1,000	LF	\$35.00	\$35,000.00
13	Yard Inlet	10	UNIT	\$2,500.00	\$25,000.00
14	Backfill	400	CY	\$30.00	\$12,000.00
<b>Site Improvements</b>					
15	Clean Fill	7,000	CY	\$25.00	\$175,000.00
16	Dense graded aggregate base (greenway path)	900	CY	\$15.00	\$13,500.00
17	full depth asphalt pavement (greenway path)	1,500	TON	\$60.00	\$90,000.00
18	6' ht Black Chain Link Fence	2,000	LF	\$45.00	\$90,000.00
19	concrete curb	2,500	LF	\$20.00	\$50,000.00
20	roadway crossing	4	EA	\$20,000.00	\$80,000.00
21	Light Pole and foundation	45	EA	\$4,000.00	\$180,000.00
22	Security Cameras	10	EA	\$5,000.00	\$50,000.00
23	conduit	4,500	LF	\$2.50	\$11,250.00
24	Trash Can	4	EA	\$1,750.00	\$7,000.00
25	Bench	8	EA	\$1,750.00	\$14,000.00
26	Bike Racks	4	EA	\$1,500.00	\$6,000.00
27	concret pad for CitiBike	4	EA	\$1,500.00	\$6,000.00
28	Bollards	8	EA	\$1,500.00	\$12,000.00
29	wayfinding signage	10	EA	\$350.00	\$3,500.00
30	Interpretive signage	3	EA	\$7,000.00	\$21,000.00
31	Shared lane markings	0	EA	\$200.00	\$0.00
32	Medallions	8	EA	\$200.00	\$1,600.00
<b>Landscaping</b>					
33	Topsoil	1,000	CY	\$40.00	\$40,000.00
34	spread topsoil	7,500	SF	\$0.50	\$3,750.00
35	Landscaping Seed Mix	7,500	SF	\$0.45	\$3,375.00
36	Shade trees	45	EA	\$600.00	\$27,000.00
37	Ornamental Trees	30	EA	\$450.00	\$13,500.00
38	shrubs	100	EA	\$30.00	\$3,000.00
				<b>subtotal</b>	<b>\$1,199,975.00</b>
	Mobilization (6% total of all other items)	1	LS	\$1.00	\$71,998.50
	Construction management (4% total of all other items)	1	LS	\$1.00	\$47,999.00

**Total Construction Cost: \$1,319,972.50**

Bikeways Application 2019  
BIKE-2019-Jersey City Morris Canal Greenway -00061  
Applicant Information

Name of Grantee: Jersey City

**Organization Address**

Jersey City  
280 Grove Street  
Jersey City, NJ 07302-3610  
Phone: (201) 547-5150

**Email Address:**

Federal Tax Identification Number: 226002013

Vendor Number: 226002013-00

Vendor Unit: CITY OF JERSEY CITY

Vendor Unit Address: ATTN BUDGET OFFICE  
280 GROVE ST, RM 208  
JERSEY CITY, NJ 07302

Application Initiation Date: 09/28/2018

Check here if the applicant information displayed below is *inaccurate*. Enter the updated information in the boxes provided.

Municipality applicants should update Mayor, Clerk and Municipal Engineer Information. County applicants should update County Executive/Freeholder Director, Clerk and County Engineer information.

**Mayor Information**

Update information here:

First Name: Steven  
Last Name: Fulop  
County: Hudson  
Municipality: Jersey City  
Address 1: City Hall  
Address 2: 280 Grove Street  
City: Jersey City  
State: NJ  
Zip: 07302  
Phone: 201-547-5200  
E-Mail: fulops@jcnj.org

Bikeways Application 2019  
BIKE-2019-Jersey City Morris Canal Greenway -00061

Applicant Information

**Clerk Information**

First Name: Robert  
Last Name: Byrne  
County: Hudson  
Municipality: Jersey City  
Address 1: City Hall  
Address 2: 280 Grove Street  
City: Jersey City  
State: NJ  
Zip: 07302  
Phone: 201-547-5150  
E-Mail: rbyrne@jcnj.org

**Municipal Engineer**

First Name: Joe  
Last Name: Cunha  
County: Hudson  
Municipality: Jersey City  
Address 1: Municipal Services  
Complex  
Address 2: 13-15 Linden Avenue East  
City: Jersey City  
State: NJ  
Zip: 07305  
Phone: 201-547-4411  
E-Mail: jcunha@jcnj.org

**County Executive/Freeholder Director**

First Name:  
Last Name:  
County:  
Address 1:  
Address 2:  
City:  
State:  
Zip:  
Phone:  
E-Mail:

**County Engineer**

First Name:

Bikeways Application 2019  
BIKE-2019-Jersey City Morris Canal Greenway -00061  
Applicant Information

Last Name:

County:

Address 1:

Address 2:

City:

State:

Zip:

Phone:

E-Mail:

Bikeways Application 2019  
BIKE-2019-Jersey City Morris Canal Greenway -00061  
Signature Page

Title of presiding officer who will be signing this application/agreement: Steven Fulop, Mayor.

Please Click here [download the attached Resolution/Agreement](#), complete, sign/seal and submit three (3) originals to the Local Aid District Office after your application has been submitted through NJDOT SAGE. Failure to submit this document within 30 days of your application submission date may jeopardize funding participation from NJDOT.

# Resolution of the City of Jersey City, N.J.

City Clerk File No. Res. 18-981

Agenda No. 10.V

Approved: NOV 07 2018

TITLE:



**RESOLUTION RATIFYING THE SUBMISSION OF A GRANT APPLICATION AND AUTHORIZING THE EXECUTION OF A GRANT AGREEMENT WITH THE NEW JERSEY DEPARTMENT OF TRANSPORTATION UNDER THE 2019 SAFE STREETS TO TRANSIT PROGRAM FOR THE CITY OF JERSEY CITY**

**COUNCIL AS A WHOLE OFFERED AND MOVED ADOPTION THE FOLLOWING RESOLUTION:**

**WHEREAS**, the State of New Jersey Department of Transportation ("NJDOT") has announced it is now accepting grant applications for the 2019 Safe Streets to Transit Program that must be completed and submitted through the System for Administering Grants Electronically (SAGE) on or before October 8, 2018; and

**WHEREAS**, the City of Jersey City ("City"), Department of Administration, Division of Engineering, Traffic and Transportation has prepared and submitted an electronic grant application to make pedestrian safety improvements on Fairmount Avenue between Bergen Avenue and Summit Avenue; and

**WHEREAS**, the City is requesting funding from the NJDOT 2019 Safe Streets to Transit Program for the primary purpose to make qualified pedestrian safety improvements to sidewalks and intersections leading to local public transportation bus stops including accessibility improvements identified in the Walkability Audit for Bergen Communities United; and

**WHEREAS**, the City agrees that it shall be required to appropriate capital funds for State non-participating items such as police salary hours and/or other ineligible costs of the project; and

**WHEREAS**, the City agrees to assume a commitment for maintenance and repair of the pedestrian safety improvements;

**NOW, THEREFORE, BE IT RESOLVED**, by the Municipal Council of the City of Jersey City that it ratifies and approves the submission of a grant application for the above stated project;

**BE IT FURTHER RESOLVED**, that the Mayor and Clerk of the City of Jersey City, County of Hudson, State of New Jersey are hereby authorized to submit an electronic grant application identified as **SST-2019-Fairmount Avenue Safety Improvements-00049** to the New Jersey Department of Transportation on behalf of the City of Jersey City; and

**BE IT FURTHER RESOLVED**, that the Mayor and Clerk of the City of Jersey City, County of Hudson, State of New Jersey are hereby authorized to sign the grant agreement on behalf of the City of Jersey City and that their signatures constitute acceptance of the terms and conditions of the grant agreement and approves the establishment of an account for the grant.

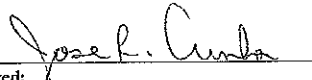
  
Approved:  
JOSE R. CUNHA, P.E., C.M.E.  
DIRECTOR OF JC ENGINEERING



TITLE:

**RESOLUTION RATIFYING THE SUBMISSION OF A GRANT APPLICATION AND AUTHORIZING THE EXECUTION OF A GRANT AGREEMENT WITH THE NEW JERSEY DEPARTMENT OF TRANSPORTATION UNDER THE 2019 SAFE STREETS TO TRANSIT PROGRAM FOR THE CITY OF JERSEY CITY**

Certified as a true copy of the Resolution adopted by Council,  
On this \_\_\_\_\_ day of \_\_\_\_\_, 2018

\_\_\_\_\_  
City Clerk

My signature and the Clerk's seal serve to acknowledge the above resolution and constitute acceptance of the terms and conditions of the grant agreement and approve the execution of the grant agreement as authorized by the resolution above.

ATTEST and AFFIX SEAL

\_\_\_\_\_  
City Clerk  
Robert Byrne

\_\_\_\_\_  
Presiding Officer  
Steven M. Fulop, Mayor of Jersey City

JRC/dlo  
10-3-18  
JMCK  
10/26/18

APPROVED: Jose L. Cunha  
APPROVED: [Signature]  
Business Administrator

APPROVED AS TO LEGAL FORM  
[Signature]  
Corporation Counsel

Certification Required   
Not Required

APPROVED 8-0

RECORD OF COUNCIL VOTE ON FINAL PASSAGE 11.7.18											
COUNCILPERSON	AYE	NAY	N.V.	COUNCILPERSON	AYE	NAY	N.V.	COUNCILPERSON	AYE	NAY	N.V.
RIDLEY	✓			YUN	✓			RIVERA	✓		
PRINZ-AREY	✓			SOLOMON	✓			WATTERMAN	ABSENT		
BOGGIANO	✓			ROBINSON	✓			LAVARRO, PRES	✓		

✓ Indicates Vote

N.V.-Not Voting (Abstain)

Adopted at a meeting of the Municipal Council of the City of Jersey City N.J.

[Signature]  
Rolando R. Lavarro, Jr., President of Council

[Signature]  
Robert Byrne, City Clerk

**RESOLUTION FACT SHEET – NON-CONTRACTUAL**

This summary sheet is to be attached to the front of any resolution that is submitted for Council consideration. Incomplete or vague fact sheets will be returned with the resolution.

**Full Title of Ordinance/Resolution**

**RESOLUTION RATIFYING THE SUBMISSION OF A GRANT APPLICATION AND AUTHORIZING THE EXECUTION OF A GRANT AGREEMENT WITH THE NEW JERSEY DEPARTMENT OF TRANSPORTATION UNDER THE 2011 SAFE STREETS TO TRANSIT PROGRAM FOR THE CITY OF JERSEY CITY**

**Initiator**

Department/Division	ADMINISTRATION	ENGINEERING
Name/Title	JOSE R. CUNHA, C.M.E., P.E.	MUNICIPAL ENGINEER
Name/Title		
Phone/email	201-547-4411	jcunha@jcnj.org

Note: Initiator must be available by phone during agenda meeting (Wednesday prior to council meeting @ 4:00 p.m.)

**Resolution Purpose**

The FY2019 State-funded Safe Streets to Transit Program (the "Program"), administered by the New Jersey Department of Transportation's (NJ DOT) Pedestrian Safety Initiative provides funds to counties and municipalities for improving access to transit facilities and all nodes of public transportation. The City of Jersey City ("City") wishes to apply for these grant funds in the amount of \$531,250.00 to improve overall safety and accessibility for pedestrians at the Fairmount Avenue Safety Improvement. The City proposes reconstruction of damaged concrete curbs and sidewalks construction of ADA compliant handicap ramps, replacement of existing pavement at crosswalks and re-striping of crosswalks, improvements to street lighting, installation of new regulatory signs, thermoplastic lane striping and traffic symbols for bus stops and other associated work. These improvements will achieve the City's goal of creating a city-wide pedestrian-friendly environment, and encourage transit users to walk to mass transit stations.

**Cost (Identify all sources and amounts)**

**Contract term (include all proposed renewals)**

Construction Estimate		\$425,000.00
Professional Design Services		\$42,500.00
Const. Mgmt/Inspection/Testing		\$63,750.00
<b>GRANT APPLICATION</b>	<b>TOTAL REQUEST</b>	<b>\$531,250.00</b>

[Empty box for contract term information]

There is no required City Match. Capital money may be used to supplement the grant allotment.

**Type of award**

Grant Application

**If "Other Exception", enter type**

[Empty box for other exception type]

I certify that all the facts presented herein are accurate.

*Jose R. Cunha*  
\_\_\_\_\_  
Jose R. Cunha, P.E., C.M.E.,  
Director of Engineering

10/18/18  
\_\_\_\_\_  
Date

\_\_\_\_\_  
Brian D. Platt, Business Administrator  
Department Director

10/31/18  
\_\_\_\_\_  
Date



**CITY OF JERSEY CITY**  
DEPARTMENT OF ADMINISTRATION  
DIVISION OF ENGINEERING, TRAFFIC & TRANSPORTATION  
MUNICIPAL SERVICES COMPLEX | 13-15 LINDEN AVE EAST | JERSEY CITY, NJ 07305  
P: 201 547 4470 | F: 201 369 7292



STEVEN M. FULOP  
MAYOR OF JERSEY CITY

BRIAN D. PLATT  
BUSINESS ADMINISTRATOR

**MEMORANDUM**

---

DATE : October 3, 2018

TO : Rolando R. Lavarro, Council President and  
Members of the Municipal Council

FROM :  Jose R. Cunha, P.E., C.M.E., C.P.W.M., C.R.P.  
Director of Engineering

SUBJECT : **Resolution to Ratify Application to New Jersey Department of  
Transportation 2019 Safe Streets to Transit Program for  
Pedestrian Safety Improvements**

---

Attached for your consideration is a resolution ratifying the submission of an electronic grant application to the New Jersey Department of Transportation ("NJDOT") for the 2019 Safe Streets to Transit Program and the execution of a grant agreement to be identified as SST-2019-Fairmount Avenue Safety Improvements-00049.

The primary purpose of the application is to seek state transportation funding to make improvements to pedestrian safety and accessibility on Fairmount Avenue for mass transit riders walking to transit facilities. The City's 2019-SST application is requesting \$531,250.00 for the proposed project. The limits and scope of project will be determined by the availability of funds from the NJDOT. As pedestrian safety continues to be of primary importance to the City and its residents, we respectfully ask for your continued support of applications for state aid program.

Please contact my office at 201-547-4411 should you have any questions or need additional information.

CC: Robert Byrne, City Clerk  
Brian D. Platt, Business Administrator  
Donna Mauer, Chief Financial Officer  
Melissa Kozakiewicz, Grant Coordinator  
Andrew Vischio, Director of Traffic and Transportation  
Dawn Odom, Supervising Administrative Analyst



[NJDOT Home](#)  
[Engineering](#)

[About NJDOT](#)  
[In the Works](#)

[NJcommuter.com](#)  
[Capital Program](#)

[Community Programs](#)  
[Freight, Air and Water](#)

[Reference / Links](#)  
[Doing Business](#)

[Local Aid and Economic Development Overview](#)

[What's New](#)

[Funding Programs](#)

[Recent Grant Recipients](#)

**State Funded Programs**

- Municipal Aid**
- County Aid
- Local Aid
- Infrastructure Fund
- Bikeways
- Safe Streets to Transit
- Transit Village
- Local Bridges, Future Needs
- Local Freight
- Impact Fund (LFIF)
- Federally Funded Programs
- Transportation Infrastructure Bank Fund
- Federal Eligibility Requirements
- Publications
- Forms and Applications
- District Offices



**Municipal Aid**

**FY 2019 Grant Solicitation – State Aid Programs**

The Division of Local Aid is currently accepting application for Following State Aid program through SAGE.

- Municipal Aid
- Transit Village
- Bikeways
- Safe Streets to Transit

Application Deadline: October 8, 2018

The Municipal Aid program is a competitive program intended to provide municipalities with transportation based grants to supplement their transportation programs. Starting in FY2018 the Transportation Trust Fund (TTF) will provide \$400 million in State Aid to municipalities and counties for local transportation improvements. Of that amount the Municipal Aid Program will be funded at level of \$140 million. Additionally \$10 million is allotted for municipalities qualifying for Urban Aid under P.L. 1978 c.14 (N.J.S.A. 52:27D-178 et seq.,). The individual allotments to qualifying municipalities are based on proportions determined by the Department of Community Affairs.

Each fiscal year, the New Jersey Department of Transportation (NJDOT) issues a solicitation announcement to municipalities inviting them to apply for funding for their specific project needs. The Municipal Aid Program is administered consistent with the language and formula distribution contained within the TTF legislation that allocates funds by county based a formula that considers population and municipal roadway miles.

Municipalities can apply for projects for Municipal Aid within one of the 7 categories below:

- Bikeway
- Primary project purpose is for constructing new bikeways (e.g.

- bike lanes, bike paths, bike compatible roadways).
- Bridge Preservation
  - Primary project purpose is for improving the condition of bridge infrastructure (e.g. new deck, rehabilitation, replacement).
- Mobility
  - Primary project purpose is to enhance mobility and reduce congestion (e.g. adding lanes, signal optimization).
- Pedestrian Safety
  - Primary project purpose is to enhance pedestrian safety (e.g. new sidewalks, new crosswalks, traffic calming, pedestrian overpass).
- Quality of Life
  - Primary project purpose is for beautification, environmental mitigation, economic development or historic preservation.
- Roadway Preservation
  - Primary project purpose is for improving the condition of roadway infrastructure (e.g. resurfacing, reconstruction, drainage).
- Roadway Safety
  - Primary project purpose is to enhance vehicular safety (e.g. guide rail, signing, warning devices, and striping).

All applications for the Municipal Aid Program are to be submitted online through System for Administering Grants Electronically (SAGE). Each district office will review applications within their designated geographic area for completeness, make a field investigation, evaluate and assign a rating to each project. Applications receive points based on various criteria including existing conditions, Average Daily Traffic (ADT), safety improvements, and access to services to public. Other important criteria include the municipality's special designation, whether the municipality has received an allotment within the last three years, and the municipality's award and close-out performance on previously awarded State grants.

Projects for which online applications have been submitted are presented to a screening committee comprised of municipal engineers and NJDOT staff appointed by the Commissioner. The committee evaluates the projects presented and makes recommendations to the Commissioner of Transportation for consideration and approval. The State pays 75% of the funds at the time of award concurrence and the remainder on a reimbursement basis after acceptance by the municipality and the State of the work completed.

Additional information can be found in Municipal Aid Handbook and State Aid Handbook.

- [Application for Funding \(SAGE\)](#)
- [FY 2018 Municipal Aid Grant Recipients](#) (pdf 96k)
- [Municipal Aid Regulations](#) (Adopted April 16, 2014) (pdf 69k)
- [Special Provisions and State Aid Projects](#) (pdf 95k)
- [Special Provisions, Baseline Document Changes and Pay Items](#)
- [State Aid Handbook](#) (pdf 95k)
- [Municipal Aid Handbook](#) (pdf 63k)

You will need Adobe Acrobat Reader to view the PDF files which is available at our state [Adobe Acrobat Access](#) page.

 [Contact Us](#) | [Privacy Notice](#) | [Legal Statement](#) | [Accessibility Statement](#) 

department: [home](#) | [about](#) | [NJ commuter](#) | [in the works](#) | [business](#) | [engineering](#) | [freight, air & water](#) | [capital](#) | [community](#) | [data](#) | [links](#) | [index](#)  
statewide: [NJ Home](#) | [about NJ](#) | [business](#) | [government](#) | [state services A to Z](#) | [departments](#)

Copyright © State of New Jersey, 2002-2018  
Department of Transportation  
P.O. Box 600  
Trenton, NJ 08625-0600



Last Updated: July 25, 2018

**Grant Application for State Aid to  
Counties and Municipalities**

Safe Streets to Transit 2019

SST-2019-Fairmount Avenue Safety Improvement-00049

Pedestrian\_Safety

**Total Estimated Cost of Improvement**

Construction Cost:	\$425,000.00
Please attach a Detailed Construction Cost Estimate (Word, Excel, or PDF format please) <a href="https://njsage.intelligrants.com/_Upload/1892584_1533343-SSTJC2019CostEstimate.pdf">https://njsage.intelligrants.com/_Upload/1892584_1533343-SSTJC2019CostEstimate.pdf</a>	
Design Engineering: (List only if eligible for Urban Aid or as a Depressed Rural Center)	\$42,500.00
Right-of-Way: (List only if eligible for Urban Aid or as a Depressed Rural Center)	\$0
Construction Inspection and Material Testing if requesting: (15% of the final allowable construction cost maximum)	\$63,750.00
<b>Total Estimated Cost:</b>	<b>\$531,250.00</b>
<b>Total Requested Amount</b>	<b>\$531,250.00</b>

Grant Application for State Aid to  
Counties and Municipalities

Safe Streets to Transit 2019

SST-2019-Fairmount Avenue Safety Improvement-00049

Pedestrian\_Safety

Type of Improvement: 1

Infrastructure	Purpose
<input checked="" type="checkbox"/>	Pedestrian Safety

Is the Project within 1 mile radius of the transit station, stop or terminal?  Yes [ ] No



Grant Application for State Aid to  
Counties and Municipalities

Safe Streets to Transit 2019

SST-2019-Fairmount Avenue Safety Improvement-00049

Pedestrian\_Safety

Project Name: Fairmount Avenue Safety Improvements

Note: If you have multiple locations for the same type of improvement and scope of work, you may enter "various" for the project limits, download the excel spreadsheet here, fill it out and attach it below.

Project Title: Fairmount Avenue Safety Improvements

From: Bergen Avenue

To: Summit Avenue

Project Distance (Miles): 0.4

Grant Application for State Aid to  
Counties and Municipalities  
Safe Streets to Transit 2019  
SST-2019-Fairmount Avenue Safety Improvement-00049  
Pedestrian\_Safety

Project Location

County to filter by: Hudson County

Municipalities: Jersey City

**Grant Application for State Aid to  
Counties and Municipalities**

Safe Streets to Transit 2019

SST-2019-Fairmount Avenue Safety Improvement-00049

Pedestrian\_Safety

**Scope Of Work**

The City of Jersey City is requesting FY2019 Safe Streets to Transit grant funding for improvements on Fairmount Avenue between Summit Avenue and Bergen Avenue. This corridor is a highly traveled route to NJ Transit Bus (Routes 6 and 87) for a large number of daily commuters. The roadways within the project limits currently prioritize vehicular travel, resulting in unsafe and dangerous conditions for pedestrians seeking to access the five bus stops along the corridor.

The scope of work includes:

- Intersection safety improvements: Redesign intersection at Fairmount Avenue, Storms Avenue, and Summit Avenue, including the restriping of crosswalks and installation of curb extensions. This work is a precursor to eventually closing Storms Avenue to vehicle traffic between Summit Avenue and Fairmount Avenue to create a community park area that enhances the pedestrian experience accessing transit in the neighborhood.
- Sidewalk widening and repair: Repair sidewalks (1,800 linear feet) along Fairmount Avenue from Bergen Avenue to Summit Avenue at prevailing sidewalk width or minimum 5' clear.
- Sidewalk construction: Construct new sidewalk at locations where sidewalk is either missing or in disrepair.
- Truncated dome pavers: Install truncated dome pavers on the approaches to large driveways at surfaced parking lots (7 driveways total).
- Pedestrian scale lighting: Install lighting along entire length Fairmount Avenue between Summit Avenue and Bergen Avenue.

This Safe Streets to Transit project is being proposed to create safer conditions for pedestrian travel to and from transit within the McGinley Square neighborhood of Jersey City. This neighborhood is replete with local businesses, houses of worship, schools, and community centers, all of which results in high pedestrian traffic. The area is also a rapidly growing and increasingly popular destination for renters, anchored by the redevelopment of the former Jersey City Medical Center into the mixed-use, 1,200-unit Beacon Apartment Complex.

A plurality of McGinley Square's residents relies on non-vehicular forms of transportation: according to the United States Census Bureau's 2015 American Community Survey, 43.8% of households in the McGinley Square neighborhood do not own or have access to a personal vehicle, and 44.7% of households utilize public transit to travel to and from work. As the closest PATH station (Journal Square) and closest Hudson-Bergen Light Rail stop (Garfield Avenue) are both over a mile away from the project area, the community is heavily dependent on NJ Transit Bus routes to commute to work, school, and other destinations. The City therefore designed the proposed improvements to create safer routes to these bus stops for the approximately 6,500 neighborhood residents who utilize public transit every day, as well as those travelling to and from McGinley Square for work and recreation.

This project aligns with and advances both the City's "Vision Zero" initiative, which seeks to eliminate traffic fatalities in Jersey City by 2026, and recommendations made in recent plans to promote sustainable transportation citywide. The City's Vision Zero Task Force—which includes representatives from the Division of Engineering, the Division of Planning, the Law Department, and the Jersey City Police Department, among others—has identified and seeks to redesign roadways in Jersey City that prioritize vehicular travel and fail to maximize pedestrian safety. Concurrently, the City has also developed a Pedestrian Enhancement Plan and

**Grant Application for State Aid to  
Counties and Municipalities**

Safe Streets to Transit 2019

SST-2019-Fairmount Avenue Safety Improvement-00049

Pedestrian\_Safety

**Scope Of Work**

is working with a consultant to complete its Bike Master Plan. Together, these plans lay out a strategic framework to encourage walking and cycling and create a safer and more sustainable transit-oriented city. This project achieves these vital goals and accelerates the City's progress towards ending traffic fatalities in Jersey City.

**Grant Application for State Aid to  
Counties and Municipalities**

Safe Streets to Transit 2019

SST-2019-Fairmount Avenue Safety Improvement-00049

Pedestrian\_Safety

**Scope Of Work**

Scope of Work cont'd

Location Map - 8.5 x 11 only - showing project limits

[https://njsage.intelligrants.com/\\_Upload/1892588\\_1533451-2019SSTMapJerseyCity.pdf](https://njsage.intelligrants.com/_Upload/1892588_1533451-2019SSTMapJerseyCity.pdf)

Note: All information must be clear and legible with street names labeled.

You may include photos with your application by uploading them here:

[https://njsage.intelligrants.com/\\_Upload/1892588\\_1533458-SSTJC2019Photos.pdf](https://njsage.intelligrants.com/_Upload/1892588_1533458-SSTJC2019Photos.pdf)

Does this project include a traffic signal?       Yes       No

If Yes, Please attach authorization to design or install if available.

Will the project meet AASHTO standards?       Yes       No

If No, list Design Exceptions below

**Grant Application for State Aid to  
Counties and Municipalities**  
Safe Streets to Transit 2019  
SST-2019-Fairmount Avenue Safety Improvement-00049  
Pedestrian\_Safety

**Safe Streets to Transit Data Sheet**

- New Sidewalk
- Pedestrian Walkway
- Pedestrian Overpass
- Pedestrian Underpass
- Pedestrian Bridge
- Crosswalk
- Sidewalk Replacement
- Traffic Signal
- Signage
- Warning Devices
- Traffic Calming
- Intersection Improvement
- Lighting

Is the proposed pedestrian project located within 0.5 mile radius of transit station, bus stop, or ferry terminal?  Yes  No

Does the project improve hazardous conditions and/or remove barriers for pedestrians at street crossings on the pedestrian route to the transit node?  Yes  No

Does the project improve overall safety along existing pedestrian walkway or path to the transit node?  Yes  No

Does the project improve pedestrian access and network connectivity by:  
Providing a pedestrian route where there is none?  Yes  No

Adding missing segments of walkways?  Yes  No

Is the transit stop part of a walking route to a public or private school located within the one (1) mile radius? (If so, show on location map on Scope of Work page)  Yes  No

Have there been any reported accidents or incidents involving pedestrians within the project limits within the last three years?  Yes  No

If yes, please attach police report(s) here:

[https://njsage.intelligrants.com/\\_Upload/1892587\\_1533406-FairmountAvenuecrashreports.pdf](https://njsage.intelligrants.com/_Upload/1892587_1533406-FairmountAvenuecrashreports.pdf)

Is the project incorporated in a State, county or municipal transportation plan or in a county or municipal master plan?  Yes  No

If so, please attach a copy of the relevant page(s) and document title page:

[https://njsage.intelligrants.com/\\_Upload/1892587\\_1533409-CirculationPlanExcerptedPages.pdf](https://njsage.intelligrants.com/_Upload/1892587_1533409-CirculationPlanExcerptedPages.pdf)

Is the applicant providing matching funds and/or drawing upon other funding sources for this project?  Yes  No

(Please indicate amount on Total Estimated Cost of Improvement page within the Detailed Construction Cost Estimate)

Grant Application for State Aid to  
Counties and Municipalities

Safe Streets to Transit 2019

SST-2019-Fairmount Avenue Safety Improvement-00049

Pedestrian\_Safety

Safe Streets to Transit Data Sheet

Has the sponsor undertaken other safety improvements utilizing their own resources to which this project is linked?  
(if so, please indicate specific projects in scope of work section)

Yes       No

Has the applicant adopted a Complete Streets policy or resolution?

Yes       No

**Grant Application for State Aid to  
Counties and Municipalities**  
Safe Streets to Transit 2019  
SST-2019-Fairmount Avenue Safety Improvement-00049  
Pedestrian\_Safety

**Total Estimated Cost of Improvement**

Construction Cost:	\$425,000.00
Please attach a Detailed Construction Cost Estimate (Word, Excel, or PDF format please) <a href="https://njsage.intelligrants.com/_Upload/1892584_1533343-SSTJC2019CostEstimate.pdf">https://njsage.intelligrants.com/_Upload/1892584_1533343-SSTJC2019CostEstimate.pdf</a>	
Design Engineering; (List only if eligible for Urban Aid or as a Depressed Rural Center)	\$42,500.00
Right-of-Way: (List only if eligible for Urban Aid or as a Depressed Rural Center)	\$0
Construction Inspection and Material Testing if requesting: (15% of the final allowable construction cost maximum)	\$63,750.00
<b>Total Estimated Cost:</b>	<b>\$531,250.00</b>
<b>Total Requested Amount</b>	<b>\$531,250.00</b>



**Grant Application for State Aid to  
Counties and Municipalities**  
Safe Streets to Transit 2019  
SST-2019-Fairmount Avenue Safety Improvement-00049  
Pedestrian\_Safety

**Applicant Information**

Name of Grantee: Jersey City

Organization Address Jersey City  
280 Grove Street  
Jersey City, NJ 07302-3610  
Phone: (201) 547-5150

Email Address:

Federal Tax Identification Number: 226002013  
Vendor Number: 226002013-00  
Vendor Unit:  
Vendor Unit Address

Application Initiation Date: 09/28/2018

**Mayor Information**

First Name: Steven  
Last Name: Fulop  
County: Hudson  
Municipality: Jersey City  
Address 1: City Hall  
Address 2: 280 Grove Street  
City: Jersey City  
State: NJ  
Zip: 07302  
Phone: 201-547-5200  
E-Mail: fulops@jcnj.org

**Clerk Information**

First Name: Robert  
Last Name: Byrne  
County: Hudson  
Municipality: Jersey City  
Address 1: City Hall  
Address 2: 280 Grove Street  
City: Jersey City  
State: NJ

**Grant Application for State Aid to  
Counties and Municipalities**  
Safe Streets to Transit 2019  
SST-2019-Fairmount Avenue Safety Improvement-00049  
Pedestrian\_Safety

**Applicant Information**

Zip: 07302  
Phone: 201-547-5150  
E-Mail: rbyrne@jcnj.org

**Municipal Engineer**

First Name: Joe  
Last Name: Cunha  
County: Hudson  
Municipality: Jersey City  
Address 1: Municipal Services  
Complex  
Address 2: 13-15 Linden Avenue  
East  
City: Jersey City  
State: NJ  
Zip: 07305  
Phone: 201-547-4411  
E-Mail: jcunha@jcnj.org

**County Executive/Freeholder Director**

First Name:  
Last Name:  
County:  
Municipality:  
Address 1:  
Address 2:  
City:  
State:  
Zip:  
Phone:  
E-Mail:

**County Engineer**

First Name:  
Last Name:  
County:  
Municipality:  
Address 1:  
Address 2:

Grant Application for State Aid to  
Counties and Municipalities  
Safe Streets to Transit 2019  
SST-2019-Fairmount Avenue Safety Improvement-00049  
Pedestrian\_Safety

Applicant Information

City:  
State:  
Zip:  
Phone:  
E-Mail:

**Grant Application for State Aid to  
Counties and Municipalities**  
Safe Streets to Transit 2019  
SST-2019-Fairmount Avenue Safety Improvement-00049  
Pedestrian\_Safety

**Signature Page**

Title of presiding officer who will be signing this application/agreement:  
Mayor

FY 2019 NJDOT SAFE STREETS TO TRANSIT  
 Fairmount Avenue from Bergen Avenue to Summit Avenue  
 ENGINEER'S DESIGN ESTIMATE

Jose R. Cunha, PE, CME  
 City Engineer

Jersey City, Hudson County, New Jersey

		UNIT	Fairmount - Bergen to Summit	TOTAL APPROX QUANTITIES	TOTAL EXTRA QUANTITIES	TOTAL CONTRACT QUANTITIES	UNIT PRICE	AMOUNT
1	CONSTRUCTION SIGNS	SF	100	100		100	\$20.00	\$ 2,000.00
2	BREAKAWAY BARRICADES	UNIT	10	10		10	\$60.00	\$ 600.00
3	TRAFFIC DRUMS	UNIT	35	35		35	\$30.00	\$ 1,050.00
4	TRAFFIC CONES	UNIT	50	50		50	\$10.00	\$ 500.00
5	INLET TYPE 'A' (IF & WHERE DIRECTED)	UNIT	1	1		1	\$4,000.00	\$ 4,000.00
6	INLET TYPE 'B' (IF & WHERE DIRECTED)	UNIT	4	4		4	\$4,000.00	\$ 16,000.00
7	INLET TYPE 'E' (IF & WHERE DIRECTED)	UNIT	1	1		1	\$4,000.00	\$ 4,000.00
8	RECONSTRUCT INLET, TYPE A, USING NEW CASTING (IF & WHERE DIRECTED)	UNIT	1	1		1	\$1,300.00	\$ 1,300.00
9	RECONSTRUCT INLET, TYPE B, USING NEW CASTING (IF & WHERE DIRECTED)	UNIT	2	2		2	\$2,200.00	\$ 4,400.00
10	RECONSTRUCT INLET, TYPE E, USING NEW CASTING (IF & WHERE DIRECTED)	UNIT	1	1		1	\$2,200.00	\$ 2,200.00
11	RESET INLET W/ NEW FRAME, CURB PIECE, BICYCLE SAFE GRATE	UNIT	3	3		3	\$1,000.00	\$ 3,000.00
12	RESET INLET W/ EXIST. FRAME, CURB PIECE, BICYCLE SAFE GRATE	UNIT	2	2		2	\$500.00	\$ 1,000.00
13	DRIVEWAY ACCESS BACKPLATE	UNIT	1	1		1	\$600.00	\$ 600.00
14	CURB PIECE TYPE 'N', 4"	UNIT	2	2		2	\$275.00	\$ 550.00
15	CURB PIECE TYPE 'N', 6"	UNIT	1	1		1	\$300.00	\$ 300.00
16	CURB PIECE TYPE 'N', 8"	UNIT	1	1		1	\$325.00	\$ 325.00
17	INLET FILTER, TYPE 1	UNIT	10	10		10	\$100.00	\$ 1,000.00
18	CATCH BASIN TRAP	UNIT	1	1		1	\$600.00	\$ 600.00
19	CATCH BASIN WALL PLATE	UNIT	1	1		1	\$650.00	\$ 650.00
20	REPAIRED CATCH BASIN WALL	SF	10	10		10	\$25.00	\$ 250.00
21	9'X20" CONCRETE VERTICAL CURB	LF	200	200		200	\$40.00	\$ 8,000.00
22	CONCRETE SIDEWALK, 4" THICK	SY	1000	1000		1000	\$80.00	\$ 80,000.00
23	CONCRETE SIDEWALK, REINFORCED 6" THICK	SY	20	20		20	\$90.00	\$ 1,800.00
24	DETECTABLE WARNING SURFACE	SY	4	4		4	\$250.00	\$ 1,000.00
25	BRICK PAVERS (IF & WHERE DIRECTED)	SY	30	30		30	\$150.00	\$ 4,500.00
26	SAWCUTTING, 10" OR LESS	LF	90	90		90	\$2.50	\$ 225.00
27	DENSE GRADED AGGREGATE, 4" THICK (IF & WHERE DIRECTED)	SY	150	150		150	\$30.00	\$ 4,500.00
28	ASPHALT PRICE ADJUSTMENT	LS		1		1	\$2,500.00	\$ 2,500.00
29	FUEL PRICE ADJUSTMENT	LS		1		1	\$1,000.00	\$ 1,000.00
30	HMA PATCH	TON	100	100		100	\$90.00	\$ 9,000.00
31	EXCAVATION UNCLASSIFIED	CY	20	20		20	\$40.00	\$ 800.00
32	EXCAVATION TEST PITS	CY	2	2		2	\$50.00	\$ 100.00
33	TRAFFIC STRIPES LONG LIFE THERMOPLASTIC, 4" THICK	LF	7500	7500		7500	\$0.65	\$ 4,875.00
34	TRAFFIC MARKINGS SYMBOLS LONG LIFE THERMOPLASTIC	SF	100	100		100	\$6.00	\$ 600.00
35	NO PARKING DRIVEWAY	UNITS	8	8		8	\$50.00	\$ 400.00
36	STRIPED RUMBLE STRIP	LF	600	600		600	\$5.00	\$ 3,000.00
37	REGULATORY TRAFFIC SIGN WITH WITH STEEL POST	SF	6	6		6	\$50.00	\$ 300.00
38	RELOCATE EXISTING TRAFFIC SIGN ON NEW STEEL POST	UNIT	3	3		3	\$160.00	\$ 480.00
39	RELOCATE OR REMOVE EXISTING TRAFFIC SIGN	UNIT	3	3		3	\$150.00	\$ 450.00
40	RECTANGULAR RAPID FLASHING SIGN	UNIT	2	2		2	\$8,000.00	\$ 16,000.00
41	RESET WATER VALVE BOX WITH RISER	UNIT	1	1		1	\$40.00	\$ 40.00
42	RESET WATER VALVE BOX (RAISE/LOWER ENTIRE BOX)	UNIT	1	1		1	\$80.00	\$ 80.00
43	NEW WATER VALVE BOX ENTIRE ASSEMBLY	UNIT	1	1		1	\$450.00	\$ 450.00
44	NEW WATER VALVE BOX UPPER ASSEMBLY	UNIT	1	1		1	\$325.00	\$ 325.00
45	IMAGING DETECTION SYSTEM	UNIT	2	2		2	\$9,000.00	\$ 18,000.00
46	PEDESTRIAN SIGNAL HEAD	UNIT	2	2		2	\$1,000.00	\$ 2,000.00
47	PEDESTRIAN SIGNAL POLE & FOUNDATION	UNIT	2	2		2	\$1,700.00	\$ 3,400.00
48	PUSH BUTTON	UNIT	2	2		2	\$300.00	\$ 600.00
49	RESET JUNCTION BOX	UNIT	2	2		2	\$1,000.00	\$ 2,000.00
50	RELOCATE JUNCTION BOX WITH NEW BOX	UNIT	2	2		2	\$6,000.00	\$ 12,000.00
51	3" RIGID METALLIC CONDUIT, TYPE EARTH	LF	100	100		100	\$60.00	\$ 6,000.00
52	PEDESTRIAN SCALE STREET LIGHT	UNIT	24	24		24	\$8,000.00	\$ 192,000.00
53	CONTROLLER MODIFICATION	UNIT	1	1		1	\$1,500.00	\$ 1,500.00
54	TRAFFIC SIGNAL CABLE, 5 CONDUCTOR	LF	250	250		250	\$5.00	\$ 1,250.00
55	CELLULAR PHONE SERVICE	LS		1		1	\$1,500.00	\$ 1,500.00

SUBTOTAL BASE BID: \$ 425,000.00

SST-2019-Fairmount Avenue Safety Improvement-00049

Project Location Map

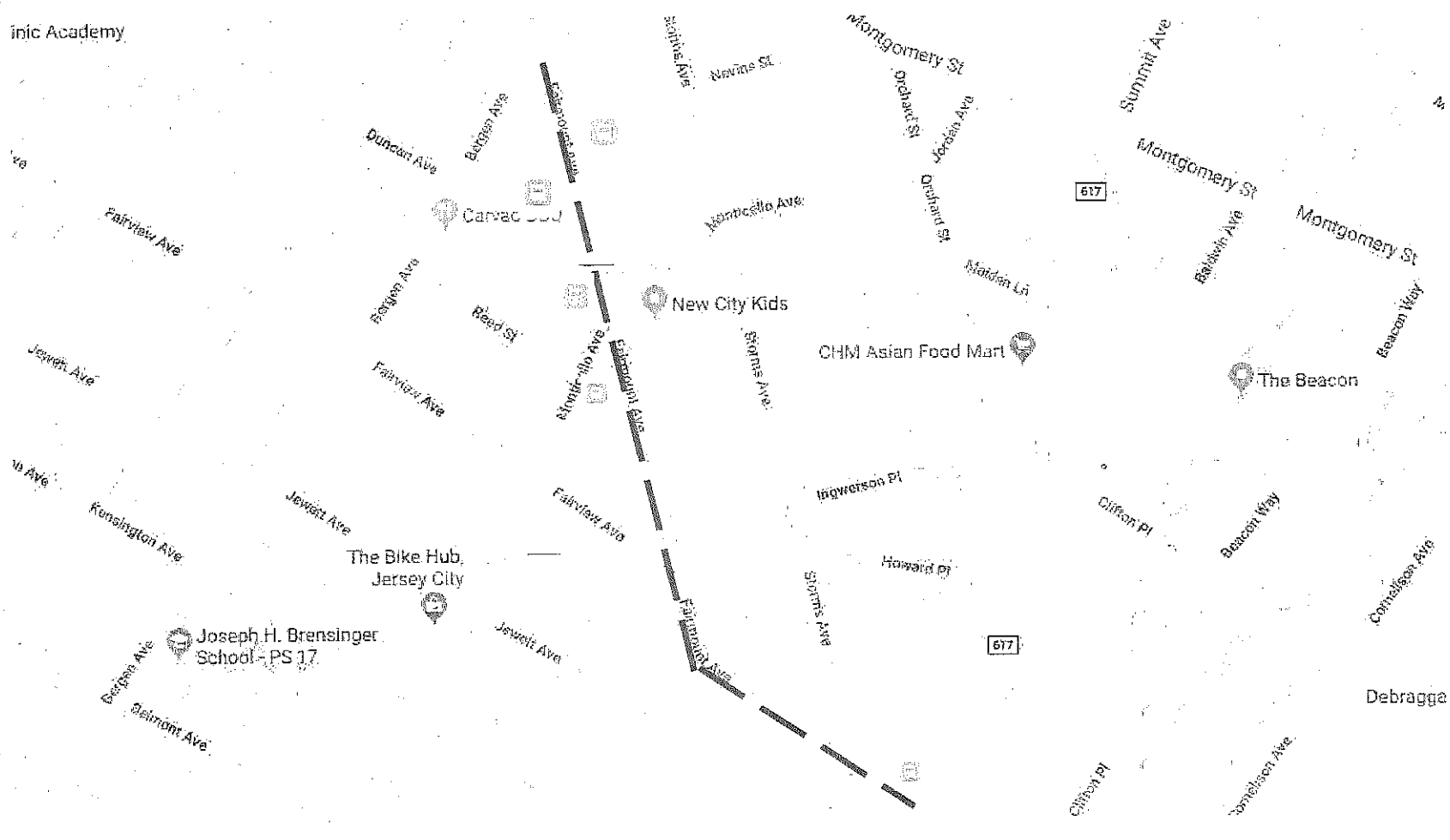

1 Case Number: **3809-16** 10 Crash Occurred On: **MONTICELLO AVE N** 11 Speed Limit: **21S** 118a **3809-16** 25  
 2 Police Dept of: **JERSEY CITY** Code: **101** 12 Route No. Suffix: **21S** 13 Milepost: **21S** 118b  
 3 Station/District: **WEST** 14  At Intersection with  Feet  Miles  N  E  S  W of: **FAIRMOUNT AVE** 18 Speed Limit: **21S** 119a  
 4 Date of Crash: **02/20/16** 5 Day of Week: **Su** 6 Time (use 2400 hrs): **0849** 7 Municipality Code: **0906** 8 Total Killed: **0** 9 Total Injured: **01** 16  NB  EB  SB  WB 119b  
 19 Ramp From: **21** To: **21** 17 Cross Road Name: **FAIRMOUNT AVE** 20 Route/Name: **21S** 21 Latitude: **40.7304** 22 Longitude: **-74.304**

23 Veh No: **405736088** 24 Policy No.: **134** 25 Ins Code: **P** 53 Veh No: **NA** 54 Policy No.: **NA** 55 Ins Code: **NA**  
 Parked  Ped  Pedalcyclist  Resp to Emergency  Hit & Run  Parked  Ped  Pedalcyclist  Resp to Emergency  Hit & Run  
 26 Driver's First Name: **MGLISSA** Initial: **P** Last Name: **POLANCO** 29 Sex: **F** 56 Driver's First Name: **LATHISHA** Initial: **R** Last Name: **REECE** 59 Sex: **F**  
 27 Number and Street: **118 JEWETT AVE Apt. 12** 30 Eyes: **2** 67 Number and Street: **130 MONTICELLO AVE 2FL** 60 Eyes: **2**  
 28 City: **JERSEY CITY** State: **NJ** Zip: **07304** 58 City: **JERSEY CITY** State: **NJ** Zip: **07305**

31 State: **NJ** 32 Drivers License No: **PL21353700151872** 33 DOB: **11/18/79** 34 Expires: **9/19** 61 State: **NJ** 62 Drivers License No: **1925189** 63 DOB: **11/25/89** 64 Expires: **9/19**  
 35 Owner's First Name: **FRANCISCO** Initial: **P** Last Name: **POLANCO-SANTANA** 65 Owner's First Name: **ANYLAA** Initial: **Q** Last Name: **QUAKHIE**  
 Same As Driver  Same As Driver  
 36 Number and Street: **118 JEWETT AVE Apt. 12** 66 Number and Street: **130 MONTICELLO AVE 2FL**  
 37 City: **JERSEY CITY** State: **NJ** Zip: **07304** 67 City: **JERSEY CITY** State: **NJ** Zip: **07305**  
 38 Make: **HONDA** 39 Model: **PIL** 40 Color: **SL** 41 Year: **11** 42 Plate No.: **ZNV11F** 43 State: **NJ** 68 Make: **HONDA** 69 Model: **PIL** 70 Color: **SL** 71 Year: **11** 72 Plate No.: **ZNV11F** 73 State: **NJ**  
 44 VIN: **5FNFK4H40BB023184** 45 Expires: **2/17** 74 VIN: **5FNFK4H40BB023184** 75 Expires: **2/17**

46 Vehicle Removed To:  Driven  Left at Scene  Towed  Impound  Disabled 47 Authority:  Owner  Driver  Police 76 Vehicle Removed To:  Driven  Left at Scene  Towed  Impound  Disabled 77 Authority:  Owner  Driver  Police  
 48 Alcohol/Drug Test Given:  No  Yes  Refused Type:  Breath  Blood  Urine Results: 0.00%  Pending  
 49 Hazardous Material On Board:  Spll  Name or Placard No.: **118 JEWETT AVE Apt. 12**  
 50 Carrier No.  USDOT  Other \*  
 51 Commercial Vehicle Weight  ≤ 10,000 lbs  10,001 - 26,000 lbs  ≥ 26,001 lbs  
 52 Carrier name: **FAIRMOUNT AVE**  
 78 Alcohol/Drug Test Given:  No  Yes  Refused Type:  Breath  Blood  Urine Results: 0.00%  Pending  
 79 Hazardous Material On Board:  Spll  Name or Placard No.: **130 MONTICELLO AVE 2FL**  
 80 Carrier No.  USDOT  Other \*  
 81 Commercial Vehicle Weight  ≤ 10,000 lbs  10,001 - 26,000 lbs  ≥ 26,001 lbs  
 82 Carrier name: **FAIRMOUNT AVE**

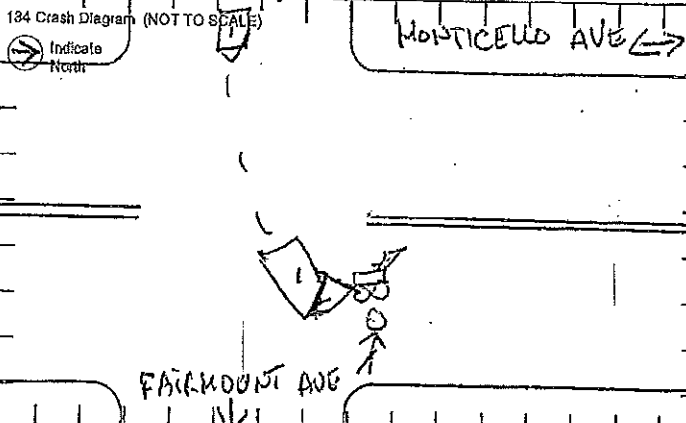

135 Crash Description: **DRIVER V#1 STATED SHE WAS MAKING A LEFT TURN ONTO MONTICELLO AVE AND DID NOT SEE THE BUS PED CROSSING THE STREET. PED# STATED THAT SHE WAS PUSHING THE BABY CARRIAGE WITH HER DAUGHTER IN IT CROSSING IN THE CROSSWALK WITH V#2 STRUCK THE BABY CARRIAGE. JUNG BUS 483 RUN K-CB3171 RESCUE AND TRANSPORTED PED TO JUNG FOR FURTHER EVALUATION FOR MINOR INJURIES. BABY WTS ALIVE.**  
 136 Damage To Other Property: **12**

137 Charge: **None**  Multiple Charges 138 Summons No.: **2** 139 Charge: **None**  Multiple Charges 140 Summons No.: **2**  
 141 Officer's Signature: **PO W. Dream** 142 Badge No.: **2701** 143 Issued By: **[Signature]** 144 Case Status:  Pending  Complete

	83	84	85	86	87	88	89	90	91	92	93	94	95	Names & Addresses of Occupants - If Deceased, Date & Time of Death
A	1	1			29	F			1					DRIVER V#1
B	1	3			50	F			1					MARIBEL CASTRO 104 JEWETT AVE JC NJ
C	1	6			5	F			1					MGLISSA POLANCO 118 JEWETT AVE JC NJ
D	P				26	F			1					LATHISHA REECE
E	P				11	F			2					5905 ANYLAA QUAKHIE



1 Case Number: **11225-16** 10 Crash Occurred On: **KENNEDY BLVD** 11 Speed Limit: **25**  
 2 Police Dept Of: **3000** Code: **101**  At Intersection With **FAIRMOUNT AVE** Dir: **S**  
 3 Station/Precinct: **WEST** 14  Feet  Miles 15  N  E  S  W of: **FAIRMOUNT AVE** 17 Cross Road Name: **FAIRMOUNT AVE** 18 Speed Limit: **25**  
 4 Date of Crash: **05/18/16** 5 Day of Week: **Th** 6 Time (use 2400 hrs): **0838** 7 Municipality Code: **0904** 8 Total Killed: **1** 9 Total Injured: **1** 19 Ramp From: **01** 20 Route/Name: **FAIRMOUNT AVE** 21 Latitude: **40.7304** 22 Longitude: **-74.1304**

23 Veh No 24 Policy No: **P1** 25 Ins Code: **01** 53 Veh No 54 Policy No: **4169173525** 55 Ins Code: **100**  
 Parked  Ped  Pedalcyclist  Resp to Emergency  Hit & Run  
 26 Driver's First Name: **WILLIAM** Initial: **W** Last Name: **DELEONARD** 29 Sex: **M** 56 Driver's First Name: **SALVADOR** Initial: **S** Last Name: **PEREZ JR.** 59 Sex: **M**  
 27 Number and Street: **429 FAIRMOUNT AVE** 30 Eyes: **BRO** 67 Number and Street: **599 WESTSIDE AVE** 60 Eyes: **BRN**

28 City: **NEW JERSEY CITY** State: **NJ** Zip: **07306** 58 City: **NEW JERSEY CITY** State: **NJ** Zip: **07304**  
 31 State: **NJ** 32 Driver's License No: **728709** 33 DOB: **10/11/75** 34 Expires: **3/20** 61 State: **NJ** 62 Driver's License No: **26786860010752** 63 DOB: **10/11/75** 64 Expires: **3/20**

35 Owner's First Name: **EAN HOLDINGS LLC** Initial: **E** Last Name: **HOLDINGS LLC**  
 Same As Driver  
 36 Number and Street: **14002 EAST 72ND ST** 66 Number and Street: **14002 EAST 72ND ST** 67 City: **TULSA** State: **OK** Zip: **74134**  
 37 City: **TULSA** State: **OK** Zip: **74134**  
 38 Make: **RAM** 39 Model: **150** 40 Color: **BLK** 41 Year: **16** 42 Plate No.: **270-JRN** 43 State: **NJ** 68 Make: **RAM** 69 Model: **150** 70 Color: **BLK** 71 Year: **16** 72 Plate No.: **270-JRN** 73 State: **NJ**

44 VIN: **1C6RR76T0G5286900** 45 Expires: **3/17** 74 VIN: **1C6RR76T0G5286900** 75 Expires: **3/17**  
 46 Vehicle Removed To:  Driven  Left at Scene  Towed  Impound  Disabled 47 Authority:  Owner  Driver  Police  
 76 Vehicle Removed To:  Driven  Left at Scene  Towed  Impound  Disabled 77 Authority:  Owner  Driver  Police

48 Alcohol/Drug Test: Given:  No  Yes  Refused Type:  Breath  Blood  Urine Results: 0.0%  Pending  
 134 Crash Diagram (NOT TO SCALE):   
 78 Alcohol/Drug Test: Given:  No  Yes  Refused Type:  Breath  Blood  Urine Results: 0.0%  Pending  
 49 Hazardous Material: On Board  Spill  Name or Placard No.: **None**  
 79 Hazardous Material: On Board  Spill  Name or Placard No.: **None**  
 50 Carrier No.:  USDOT  Other  
 80 Carrier No.:  USDOT  Other  
 51 Commercial Vehicle Weight:  ≤ 10,000 lbs  10,001 - 26,000 lbs  ≥ 26,001 lbs  
 81 Commercial Vehicle Weight:  ≤ 10,000 lbs  10,001 - 26,000 lbs  ≥ 26,001 lbs  
 62 Carrier name: **FAIRMOUNT AVE**

135 Crash Description: **PI STATES HE WAS CROSSING THE STREET WHEN V1 WAS TURNING AND STRUCK HIS LEFT FOOT. PI FATHER (WILLIAM DELEONARD) STATES HE WAS CROSSING THE STREET WITH HIS SON WITH THE RED LIGHT WHEN V1 WAS MAKING A RIGHT TURN FROM STREET HIS SON. DRIVER OF V1 STATES AS HE ATTEMPTED TO MAKE A RIGHT TURN ON TO KENNEDY BLVD PI RAN FROM HIS FATHER CROSSING THE STREET AND HE DID NOT SEE PI AND STRUCK HIM. PI WAS TAKEN TO JEROME BUS #308 RUSH 16-036178 FOR POSSIBLY**

136 Damage To Other Property: **None** FRACTURE TO LEFT FOOT - DRIVER OF V1 REFUSED MEDICAL.  
 137 Charge:  Multiple Charges 138 Summons No.: **248** 139 Charge:  Multiple Charges 140 Summons No.: **248**

141 Officer's Signature: **P.O. JERRY RUCCIO** 142 Badge No.: **248** 143 Reviewed By: **[Signature]** Badge No.: **248** 144 Case Status:  Pending  Complete

	83	84	85	86	87	88	89	90	91	92	93	94	95	Names & Address of Occupants - If Deceased, Date & Time of Death
A	P1	-	-	036	M	11072	01	-	-	-	-	-	-	5905 WILLIAM DELEONARD
B	01	01	01	-	40	M	-	-	104	-	-	-	-	SALVADOR PEREZ JR.
C														
D														
E														





1 Case Number **945-17** 10 Crash Occurred On: **Fairmount Ave** 11 Speed Limit **25** 118a **02**  
 2 Police Dept of **JCPD** Code **1001**  All Intersection with Road Name Dir **100**  Feet  N  E of: **Boland St.**  S  W 118b **10**  
 3 Station/Precinct **West** 14  Miles 15  16 19  To: 17 Cross Road Name  NB  EB 119a **72**  
 4 Date of Crash **01/13/17** 5 Day of Week **Th** 6 Time (use 2400 hrs) **1543** 7 Municipality Code **0906** 8 Total Killed **00** 9 Total Injured **01** 20 Route/Name  NB  SB  WB 119b **72**  
 23 Veh No **1** 24 Policy No. **AJT 238 3500 704065** 25 Ins Code **370** 53 Veh No **P** 54 Policy No. **P** 55 Ins Code **P**  Parked  Ped  Pedalcyclist  Resp to Emergency  Hit & Run 120 **01**

26 Driver's First Name **Shenouda** Initial **T** Last Name **Massoud** 29 Sex **M** 56 Driver's First Name **Mary** Initial **I** Last Name **Ibrahim** 59 Sex **F** 121 **01**  
 27 Number and Street **320 Fairmount Ave** 30 Eyes **BRN** 57 Number and Street **317 Fairmount Ave Apt 12** 60 Eyes **BRN**

28 City **Jersey City** State **NJ** Zip **07306** 58 City **Jersey City** State **NJ** Zip **07306**  
 31 State **NJ** 32 Drivers License No **1M0772 170683 11602** 33 DOB **11/02/80** 34 Expires **3/17** 61 State **NJ** 62 Drivers License No **12/12/04** 63 DOB **12/12/04** 64 Expires **12/12/04** 122 **13**

35 Owner's First Name **Shenouda** Initial **T** Last Name **Massoud** 65 Owner's First Name **Mary** Initial **I** Last Name **Ibrahim** 123 **13**  
 36 Number and Street **320 Fairmount Ave** 66 Number and Street **317 Fairmount Ave Apt 12** 124 **46**  
 37 City **Jersey City** State **NJ** Zip **07306** 67 City **Jersey City** State **NJ** Zip **07306** 125 **46**

38 Make **Toyota** 39 Model **Sienna** 40 Color **GY** 41 Year **04** 42 Plate No. **RG-8YM** 43 State **NJ** 68 Make **Toyota** 69 Model **Sienna** 70 Color **GY** 71 Year **04** 72 Plate No. **RG-8YM** 73 State **NJ**  
 44 VIN **5TD2A23C845115499** 45 Expires **9/17** 74 VIN **5TD2A23C845115499** 75 Expires **9/17**

46 Vehicle Removed To  Driven  Left at Scene  Towed  Impound  Disabled 47 Authority  Owner  Driver  Police 76 Vehicle Removed To  Driven  Left at Scene  Towed  Impound  Disabled 77 Authority  Owner  Driver  Police 126 **01**

48 Alcohol/Drug Test Given:  No  Yes  Refused Type:  Breath  Blood  Urine Results: 0.00%  Pending 134 Crash Diagram (NOT TO SCALE) **Parking Lot** **Boland St.** **Sidewalk** **Pedestrian sidewalk** **Fairmount Ave. (one way)** 78 Alcohol/Drug Test Given:  No  Yes  Refused Type:  Breath  Blood  Urine Results: 0.00%  Pending 127 **22**  
 49 Hazardous Material On Board Spill   Name or Placard No. 79 Hazardous Material On Board Spill   Name or Placard No. 128a **22**  
 50 Carrier No.  USDOT  Other \* 80 Carrier No.  USDOT  Other \* 128b **22**  
 51 Commercial Vehicle Weight  ≤ 10,000 lbs  10,001 - 26,000 lbs  ≥ 26,001 lbs 81 Commercial Vehicle Weight  ≤ 10,000 lbs  10,001 - 26,000 lbs  ≥ 26,001 lbs 128c **22**  
 52 Carrier name 82 Carrier name 128d **22**

135 Crash Description **Driver of Veh 2 stated he backed out of the parking lot located on the North West corner of Fairmount Ave and Boland St. Driver of Veh 1 further stated he continued driving in reverse west on Fairmount Ave, when he suddenly felt he struck a pedestrian crossing the street. Driver then stopped the car and exited his vehicle. The pedestrian struck was a 12 year old female Mary Ibrahim, who stated she lost consciousness due to the impact of the vehicle striking her and knocking** 128e **06**  
 136 Damage To Other Property **17**

Oper. **1** 137 Charge **39:4-127**  Multiple Charges 138 Summons No. **0906-9-504362** Oper. **1** 139 Charge **39:4-97**  Multiple Charges 140 Summons No. **0906-9-504361** 141 Officer's Signature **P.O. Frank Murphy** 142 Badge No. **3085** 143 Reviewed By **lit** 144 Case Status  Pending  Complete 133 **17**

	83	84	85	86	87	88	89	90	91	92	93	94	95	Names & Addresses of Occupants - If Deceased, Date & Time of Death
A	1	1	/	/	36	M	/	/	/	/	/	/	/	Driver of Veh 1.
B	P	/	/	3	12	F	02-05	2	/	/	/	/	/	5905 Pedestrian
C														
D														
E														

945-17

<b>New Jersey Police Crash Investigation Report</b> <b>Motor Vehicle Crash Description</b>	Police Dept: <u>JCPD</u> Code: <u>001</u> Station: <u>West District</u> Case No: <u>945-17</u>
---	---

(Refer to vehicle by number)

	Veh	Pos	Eject	Phys	Age	Sex	Loc	Type	Ref	Equip	Equip	Bag	Hosp	Names & Address of Occupants - If Deceased, Date & Time of Death
	Occ	In/On		Cond			In]	In]	Med	Avail	Used	Depl	Code	
ALL INVOLVED	83	84	85	86	87	88	89	90	91	92	93	94	95	
F														
G														
H														
I														
J														

135 Crash Description

her to the ground. Mary Ibrahim further stated she can recall what happened at the time.

The sister of the victim, Maddonna Mahrous, was present when the incident took place. Maddonna stated she was on the North side of the street on Fairmount Ave, and as she was crossing the street, her sister was a few steps behind her, when all of a sudden the driver of Veh. 2 was driving in reverse on Fairmount Ave and struck her sister Mary, knocking her to the ground, making her lose conscious.

A witness by the name of Ramon Rouse was on scene, who stated he saw driver of Veh. 2 back out of the parking lot, continued to drive in reverse on Fairmount Ave, and struck the victim while crossing the street.

MC bus # 317, run #17-0035 was at the scene evaluating the victim, who had non-life threatening injuries at the time. Mary had swelling to the hip, blood collection to her teeth, (unknown damage), abrasion the left lower leg, deformity of the nose. Mary was taken to the J.C.M.C. for further evaluation. She was accompanied by her father, Samy Ibrahim, who was also at the scene.

Driver of veh 2 was issued summons # 0906-9-504361 for careless driving in violation of title 39:4-97, and summons # 0906-9-504362 for improper backing in violation of title 39:4-127.

*P. G. Frank Murray*  
 Officer's Signature

3085  
 Badge Number

1. Case Number **4231-17** 10. Crash Occurred On: **Fairmount Ave** E 11. Speed Limit **25**  
 2. Police Dept. of **Jersey City** Code **101** 12. Route No. **4231-17** 13. Milepost **04**  
 3. Station/Precedent **West** 14.  At Intersection with  Feet  Miles  E  W  N  S **15** 15. **Boland St** 16. Speed Limit **25**  
 19.  Ramp  From:  To: 17. Cross Road Name/Route No.  NB  EB  SB  WB

4. Date of Crash **04/23/17** 5. Day of Week **Th** 6. Time (use 2400 hrs.) **2242** 7. Municipality Code **0906** 8. Total Killed **0** 9. Total Injured **0**  
 23. Veh. # **P1** 24. Policy No. **---** 25. NJ Ins. Code **---** 26. NJ Ins. Code **V2** 27. Veh. # **---** 28. Policy No. **---** 29. NJ Ins. Code **---**

28. Driver's First Name **Kenneth J Parker** 29. Sex **m** 30. Driver's First Name **---** 31. Initial **---** 32. Last Name **---** 33. Sex **---**  
 27. Number & Street **319 Fairmount Ave** 28. City **Jersey City** 29. State **NJ** 30. Zip **07304**

30. Eyes **---** 31. DL Class **---** 32. Restrictions **---** 33. Endorsements **---** 34. State **---** 35. Eyes **---** 36. DL Class **---** 37. Restrictions **---** 38. Endorsements **---** 39. State **---**

32. Driver's License Number **---** 33. DOB **11/03/88** 34. Expires **---** 35. Driver's License Number **---** 36. DOB **---** 37. Expires **---**

35. Owner's First Name **---** 36. Initial **---** 37. Last Name **---** 38. Owner's First Name **---** 39. Initial **---** 40. Last Name **---**

36. Number & Street **---** 37. City **---** 38. State **---** 39. Zip **---** 40. Number & Street **---** 41. City **---** 42. State **---** 43. Zip **---**

38. Make **Lincoln** 39. Model **Town Car** 40. Color **Bk** 41. Year **06** 42. Plate No. **---** 43. State **NJ** 44. Make **---** 45. Model **---** 46. Color **---** 47. Year **---** 48. Plate No. **---** 49. State **---**

44. VIN **---** 45. Expires **---** 46. VIN **---** 47. Expires **---**

48. Vehicle Removed to:  Driven  Towed Disabled  Towed Disabled & Impounded  Left at Scene  Towed Impounded  Towed Disabled & Impounded  Left at Scene  Towed Impounded  Towed Disabled & Impounded

47. Authority  Owner  Driver  Police 48. Alcohol Drug Test Given:  No  Yes  Refused Type:  Breath  Blood  Urine Results: **0.00** %  Pending 49. Hazardous Material  None  On Board  Spill Hazard Class **---** Placard No. **---**

50. Carrier No.  USDOT  MCMX  None 51. GVWR / GCWR (trucks & buses only)  ≤ 10,000 lbs.  10,001 - 28,000 lbs.  ≥ 28,001 lbs. 52. Motor Carrier or Government Entity  USDOT  MCMX  None 53. GVWR / GCWR (trucks & buses only)  ≤ 10,000 lbs.  10,001 - 28,000 lbs.  ≥ 28,001 lbs.

52. Motor Carrier or Government Entity **---** 53. Number & Street **---** 54. City **---** 55. State **---** 56. Zip **---** 57. Number & Street **---** 58. City **---** 59. State **---** 60. Zip **---**

135. Damage to Other Property  Yes (If Yes, describe)  No

136. Charge **none** 137. Summons No. **---** 138. Charge **none** 139. Summons No. **---**  
 140. Charge **---** 141. Summons No. **---** 142. Charge **---** 143. Summons No. **---**

	83	84	85	86	87	88	89	90	91	92	93	94	95	Names & Addresses of Occupants If Deceased, Date & Time of Death
A	P	-	-	04	28	m	07	08	1	-	-	-	-	Pedestrian 1
B	2	1	01	-	00	00	-	1	00	00	00	-	-	Driver of V2
C														
D														

State of New Jersey Police Crash Investigation Report NJTR-1

Use Code 00 for Unknown.

Use Code 99 for Other.

Explain Other in Crash Description

Also, Explain Items Marked with asterisk (\*) in Crash Description

If an Item Does Not Apply, Enter a Dash (-)

Eye Color (box 30, 60) 1 - Black 4 - Blue 2 - Brown 5 - Hazel 3 - Gray 6 - Green 7, 8, and 9 = Other

Vehicle Color Codes (box 40, 70)

- Belge BG Black BK Blue BL Brown BN Coral CL Cream CM Gold GD Gray GY Green GN Maroon MN Orange OG Pink PK Purple PL Red RD Silver SL Tan TN Turquoise TQ White WT Yellow YL

Overlay Page 2 of 2

Main form area containing sections: Apparent Contributing Circumstances, Driver/Pedalcyclist Actions, Vehicle Factors, Pedestrian Factors, Apparent Physical Status, Cell Phone in Use By Driver, Vehicle / Pedalcyclist Action, Pedestrian Action, Pre-Crash Action, Traffic Controls, Sequence of Events, Collision w/ Person, MV, or Non-Fixed Object, Collision w/ Fixed Object, Checkpoint Diagram, Vehicle Impact Area.

96 <b>04</b>	1. Case Number <b>18-020183</b>															118a <b>02</b>
97 <b>01</b>	2. Police Dept. of Code <b>JCPD 01</b>															118b -
98 <b>01</b>	3. Station/Precinct <b>WEST</b>															119a <b>74</b>
99 <b>07</b>	4. Date of Crash <b>09/04/18</b>															119b -
100a <b>01</b>	5. Day of Week <b>Th</b>															120a <b>01</b>
100b <b>04</b>	6. Time (use 2400 hrs) <b>0711</b>															120b -
101 <b>02</b>	7. Municipality Code <b>0906</b>															121a <b>01</b>
102 <b>01</b>	8. Total Killed <b>00</b>															121b -
103 <b>01</b>	9. Total Injured <b>01</b>															122 <b>10</b>
104 <b>01</b>	10. Crash Occurred On: <b>733 BERGEN AVE</b>															123 <b>41</b>
105 <b>13</b>	11. Speed Limit <b>25</b>															124 <b>03</b>
106 <b>02</b>	12. Route No. Suffix 13. Milepost <b>2 5</b>															125 <b>03</b>
107 -	14. Dir <b>N</b>															126a <b>28</b>
108 <b>01</b>	15. Road Name <b>FAIRMOUNT AVE</b>															126b <b>21</b>
109 -	16. Speed Limit <b>25</b>															126c -
110 <b>01</b>	17. Cross Road Name/Route No. <b>OSBORNE PL</b>															126d -
111 -	18. Direction <b>W</b>															126e <b>21</b>
112 -	19. From <b>W</b>															127a <b>69</b>
113 -	20. Route Name/Route No. <b>OSBORNE PL</b>															127b -
114 -	21. Latitude															127c -
115 -	22. Longitude															127d -
116 <b>01</b>	23. Veh. # 24. Policy No. <b>V1 4503617336</b>															127e <b>69</b>
117 -	25. NJ Ins. Code <b>148</b>															128 <b>28</b>
118 -	26. Driver's First Name Initial Last Name <b>TERMAINE Y HARGROVE-MCHENRY</b>															129 <b>09</b>
119 -	27. Number & Street <b>23 OSBORNE PL</b>															130 <b>09</b>
120 -	28. City <b>IRVINGTON</b>															131 -
121 -	29. State Zip <b>NJ 07111</b>															132 -
122 -	30. Eyes DL Class Restrictions Endorsements 31. State <b>02 D NONE NO NJ</b>															133 <b>02</b>
123 -	32. Driver's License Number <b>H0588 73388 52702</b>															134 -
124 -	33. DOB mm dd yy <b>0211070</b>															135 -
125 -	34. Expires mm yy <b>0521</b>															136 -
126 -	35. Owner's First Name Initial Last Name <b>MARIA GABRIELA VELEZ-ZAMBRANO</b>															137 -
127 -	36. Number & Street <b>BERGEN AVE</b>															138 -
128 -	37. City <b>JERSEY CITY</b>															139 -
129 -	38. State Zip <b>NJ 07304</b>															140 -
130 -	39. Make 39. Model 40. Color 41. Year 42. Plate No. 43. State <b>HONDA ACCORD SL 17 X57DAW NJ</b>															141 -
131 -	44. VIN <b>1HGCRCR3F96HA042268</b>															142 -
132 -	45. Expires <b>04/19</b>															143 -
133 -	46. Vehicle Removed to:															144 -
134 -	47. Authority <input checked="" type="checkbox"/> Owner <input type="checkbox"/> Driver <input type="checkbox"/> Police															145 -
135 -	48. Alcohol Drug Test Given <input type="checkbox"/> No <input type="checkbox"/> Yes <input type="checkbox"/> Refused															146 -
136 -	49. Hazardous Material <input type="checkbox"/> None <input type="checkbox"/> On Board <input type="checkbox"/> Spill															147 -
137 -	50. Carrier No. <input type="checkbox"/> USDOT <input type="checkbox"/> MCMX															148 -
138 -	51. GVWR / GCWR (trucks & buses only) <input type="checkbox"/> ≤ 10,000 lbs. <input type="checkbox"/> 10,001 - 25,000 lbs. <input type="checkbox"/> ≥ 26,001 lbs.															149 -
139 -	52. Motor Carrier or Government Entity															150 -
140 -	53. Damage to Other Property <input type="checkbox"/> Yes (if Yes, describe) <input type="checkbox"/> No															151 -
141 -	54. Operator 136. Charge 137. Summons No.															152 -
142 -	55. Operator 140. Charge 141. Summons No.															153 -

		Names & Addresses of Occupants If Deceased, Date & Time of Death												
		83	84	85	86	87	88	89	90	91	92	93	94	95
A	V1	01	01	-	47	F	-	-	01	11	00	-	-	TERMAINE Y HARGROVE-MCHENRY 23 Osborne Pl Irvington, NJ 07111
B	P1	11	03	04	25	F	11	08	01	08	01	-	-	MARIA GABRIELA VELEZ-ZAMBRANO Bergen Ave Jersey City, NJ 07304
C														
D														

20183-18

New Jersey Police  
Crash Investigation Report

Case Number  
**18-020183**

Page **2** of **2**

	83	84	85	86	87	88	89	90	91	92	93	94	95	Names & Addresses of Occupants If Deceased: Date & Time of Death
E														
F														
G														
H														
I														
J														

144. Crash Diagram

Show NORTH by Arrow  
(No. to Scene)

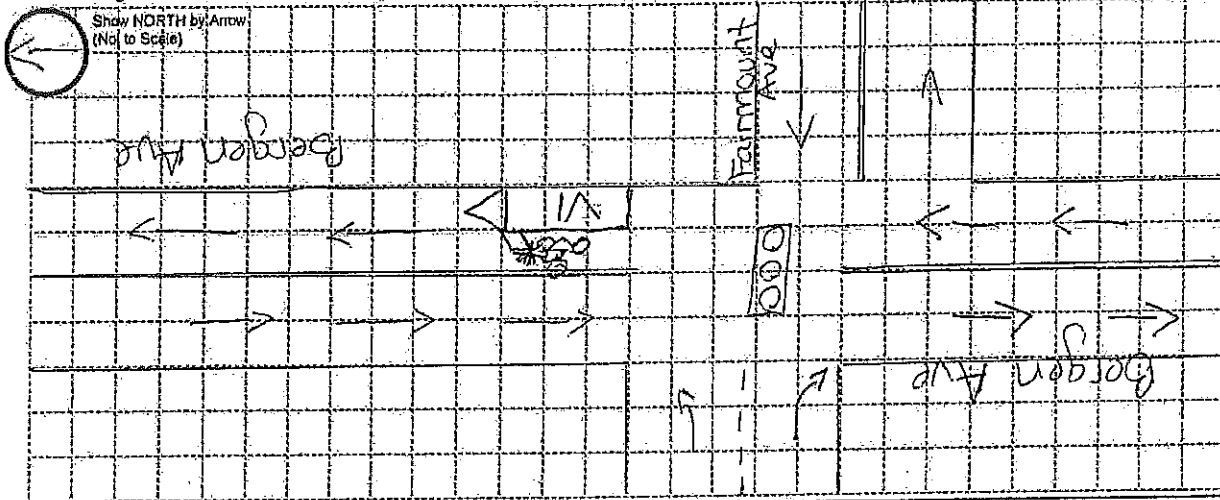

146. Crash Description/Narrative

Driver of V1 stated she parked her vehicle near the intersection of Fairmount Ave/Bergen Ave facing Northbound. As she opened the door and attempted to exit; the pedalcyclist slammed into the opened door and fell to the ground. Driver of V1 attempted to help the pedalcyclist to her feet offering medical attention as the pedalcyclist cursed at her.

Pedalcyclist stated she was riding Northbound on Bergen Ave; as she approached 733 Bergen Ave the driver of V1 swung the door open causing her to slam into it and fall to the ground. Pedalcyclist stated she was not wearing a helmet when she fell to the ground but had a complaint of pain to the right ankle.

JCMC Bus #308 responded to the scene and was canceled on scene.

146. Officer's Signature

147. Badge #  
**3104**

148. Reviewer

Badge #

149. Case Status

Pending  Complete

SST-2019-Fairmount Avenue Safety Improvement-00049

Existing Conditions Photos



Figure 1. Intersection of Fairmount Avenue with Summit Avenue and Storms Avenue – faded and/or non-existent crosswalks, poor sidewalks and curbing, and lack of signage creates dangerous crossing conditions for pedestrians.

SST-2019-Fairmount Avenue Safety Improvement-00049

Existing Conditions Photos



Figure 2. The intersection of Fairmount Avenue with Bergen Avenue has faded crosswalks, inadequate signage, and visibility issues that endanger pedestrian travel.

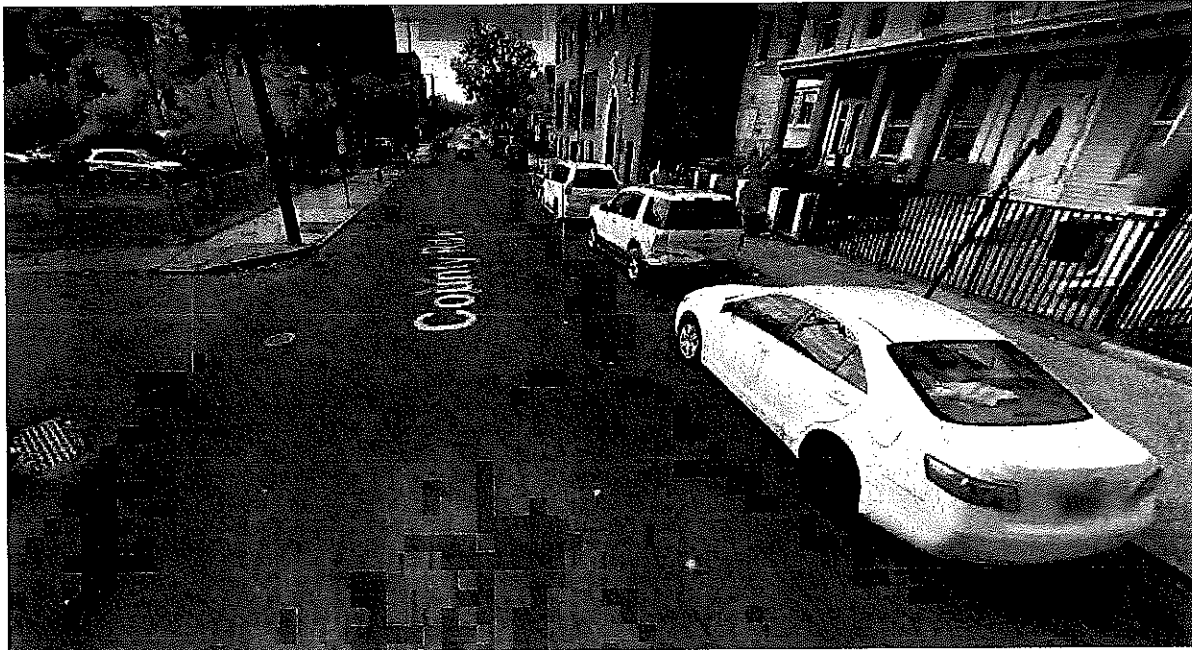

Figure 3. Road crossing lack crosswalk markings and signage. Narrow sidewalks make pedestrian travel along this route difficult.



SST-2019-Fairmount Avenue Safety Improvement-00049

Existing Conditions Photos

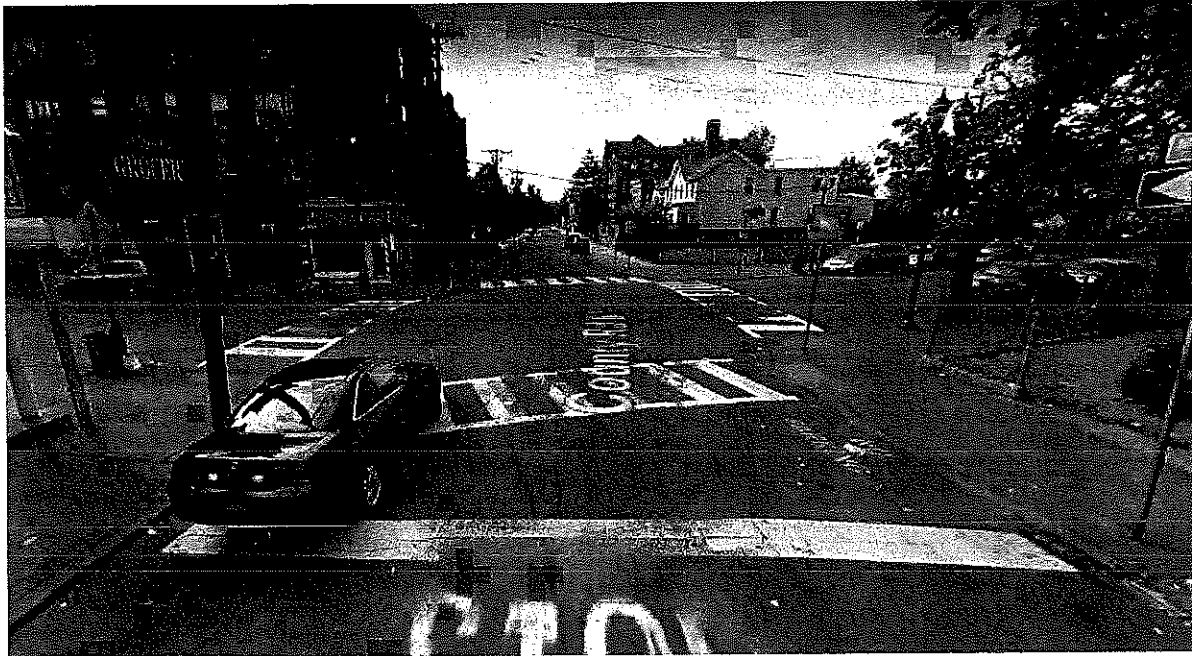

Figure 4. The crossing at Monticello Avenue is in need of repair, demonstrating by fading striping and long-crossing distances.



Figure 5. The irregular configuration of the intersection of Fairmount Avenue, Summit Avenue and Storms Avenue creates unsafe conditions for pedestrian travel.

SST-2019-Fairmount Avenue Safety Improvement-00049

Existing Conditions Photos

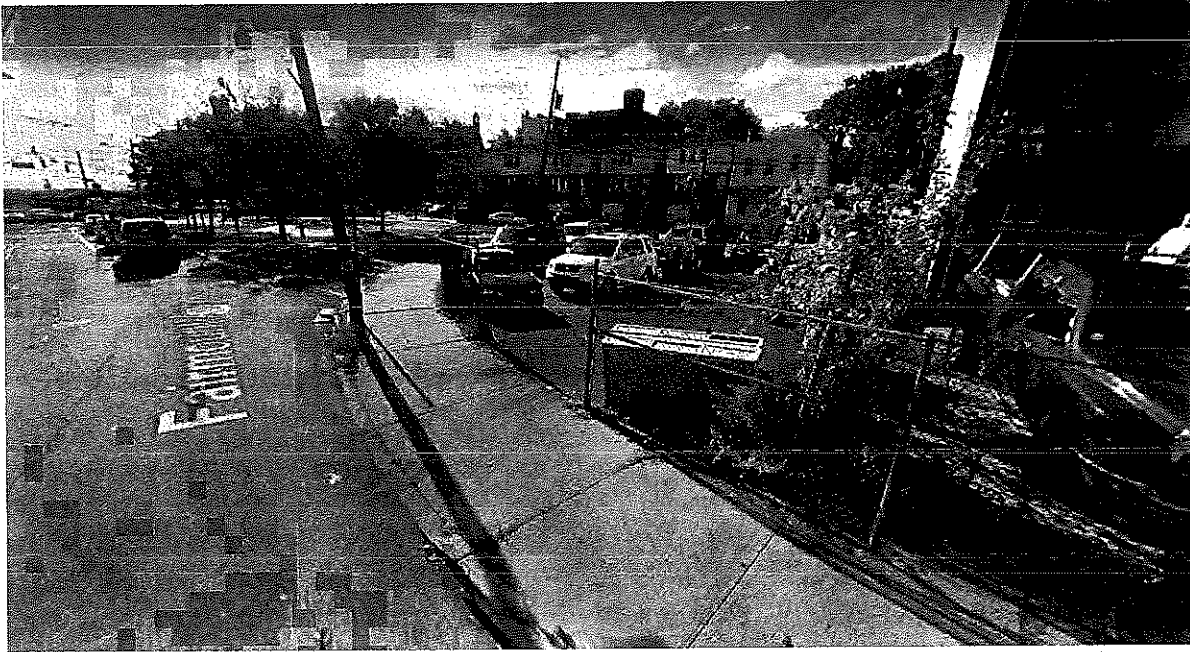

Figure 6. Parking lot exits have limited sight lines that creates risks for vehicle-pedestrian incidents.

through access management, density limitations, street modifications increase in local mass transit service, or other means.

- Action G1-10: Advance a phased approach to transportation projects and policies that support the redevelopment of Journal Square.
- Action G1-11: A capital investment prioritization study should be undertaken to develop an implementation schedule for transit improvements and use of capital resources.
- Action G1-12: Permit use of commercial parking facilities by car sharing programs.
- Action G1-13: Adopt a redevelopment plan that accommodates mixed-use development and shared parking on the HBLR Liberty State Park station park and ride lot. Perform traffic impact analysis of redevelopment and determine if there is a need to improve vehicular access in order to support redevelopment.
- Action G1-14: All city, county and state capital projects shall be submitted to the Jersey City Planning Board in accordance with N.J.S.A. 40:55D-31.

**3.2.2 Goal 2: Increase, improve, and enhance public transit service to, from, and within all areas of Jersey City**

The City seeks to increase, improve, and enhance the public transit system to provide better neighborhood connectivity and regional access. The City conducted an extensive public outreach program, and a consistent concern of Jersey City stakeholders was that the Circulation Element address neighborhood connectivity. Additionally, the Mobility 2050 Survey found that the three most desired features of transit were: 1) that it stops close to home, 2) the frequency of service, and 3) the reliability of service. The Objectives, Strategies, and Actions are designed to achieve a public transit system that meets the needs of all of Jersey City's stakeholders.

The Objectives to attain Goal 2 are as follows:

- Objective G2-1: Provide affordable, frequent, reliable, and accessible bus service to residents and visitors.
- Objective G2-2: Extend, expand and enhance the existing Hudson-Bergen Light Rail (HBLR) system and service to improve connectivity in and between existing neighborhoods, to other transportation systems, and to remote intercept parking locations.
- Objective G2-3: Increase convenience and capacity of the PATH system.
- Objective G2-4: Provide a ferry system that serves the needs of Jersey City residents and commuters to Jersey City and Manhattan.
- Objective G2-5: Make it as easy as possible to use mass transit.
- Objective G2-6: Increase mass transit ridership.

- Action G3-5: Complete street grids, as identified on Right-of Way Mapping, Figure 4.4-1, in order to increase connectivity.
- Action G3-6: Create new streets and extend existing streets to support development, increase connectivity for the multi-modal system, and to provide access to the waterfront as identified on Right-of Way Mapping, Figure 4.4-1.
- Action G3-7: Construct Center and Merseles Street Tunnel under Montgomery Street, as recommended in the 2007 Jersey City Regional Waterfront Access and Downtown Circulation Study Final Report.
- Action G3-8: Complete study of connectivity between Jersey City and Hoboken in the vicinity of Paterson Plank Road.
- Action G3-9: A capital investment prioritization study should be undertaken to develop an implementation schedule for transit improvements and use of capital resources.
- Action G3-10: Advance the recommendation(s) for the boulevard and complete street along the Route 440/Routes 1&9T corridor between the Bayonne border and Route 7 identified by the final report for the Route 440/Routes 1&9T Multi-Use Urban Boulevard and Through Truck Diversion Concept Development Study dated May 2011 prepared by Jacobs Engineering. The recommendations include a network of new local streets adjacent to the boulevard and complete street in order to enhance access for vehicles, pedestrians, and bicyclists to the Hackensack River waterfront and in the Western Waterfront area, as well as frequent crossings of the boulevard for pedestrians and bicyclists. See Route 440 and Routes 1&9T Boulevard and Complete Street Plan and Right-of-Way Needs Map in Appendix for details.

**3.2.4 Goal 4: Create a city-wide pedestrian-friendly environment**

Jersey City strives to create a walkable City that is safe, secure, seamless and aesthetically-pleasing. The City aims to create a pedestrian-friendly environment that is accessible and meets the needs of all of its residents and visitors. To achieve this goal, the following Objectives should be met:

- Objective G4-1: Create a network of sidewalks, walkways and paths that allow pedestrians to walk between all neighborhoods and destinations in Jersey City.
- Objective G4-2: Provide a safe and secure environment for pedestrians.
- Objective G4-3: Create a comfortable, aesthetically-pleasing, and visually-interesting environment for pedestrians.
- Objective G4-4: Support and reinforce the existing culture of walking in Jersey City.
- Objective G4-5: Encourage walking as a means to reduce carbon emissions and to increase public health.
- Objective G4-6: Provide pedestrian linkages to all surrounding municipalities.

<b>Indicator:</b>	Linear miles of gaps in Hudson River Waterfront Walkway and Hackensack River Walkway (GIS data from August 2008, Hudson County Re-examination Report of Master Plan, and GIS data from the May 2004 Hudson County Hackensack RiverWalk Plan)
<b>Target:</b>	Zero gaps in walkways.
<b>Baseline:</b>	In 2004, there were 10.23 linear miles of gaps (i.e., areas with no permanent walkway or walkways currently under construction based on GIS data) in the Hudson River Waterfront Walkway and 3.3 linear miles of gaps in the proposed route of the Hackensack River Walkway.

<b>Indicator:</b>	Annual number of accidents reported that involved pedestrians in NJ Department of Transportation Crash Record Data per 1,000 residents, as measured by American Community Survey (ACS) Table No. B01003.
<b>Target:</b>	Annual decrease in number of accidents involving pedestrians occurring in Jersey City per 1,000 residents.
<b>Baseline:</b>	In 2007, there were 1.63 accidents involving pedestrians occurring in Jersey City per 1,000 residents, of which there were 0.37 accidents involving bicyclists occurring in Jersey City per 1,000 residents.

The Strategies to achieve Goal 4 are as follows:

- Strategy G4-A: Ensure that all streets have sidewalks.
- Strategy G4-B: Ensure that all sidewalks are of adequate width and have the capacity to carry current and anticipated future pedestrian volumes. Respect the integrity of historic districts.
- Strategy G4-C: Ensure that all sidewalks are well-maintained and well-lit.
- Strategy G4-D: Ensure an adequate number of pedestrian street crossings to minimize walking distances.
- Strategy G4-E: Locate and design street crossing in a manner that minimizes walking distances and the length of time that pedestrians are in the crosswalk by using narrow travel lane widths and curb extensions. Curb extensions should incorporate vertical elements, such as trees, utility poles, or street furniture, to provide a visual cue to alert snowplow drivers to the presence of curb extensions.
- Strategy G4-F: Fill in missing links between existing sidewalks, walkways and paths.
- Strategy G4-G: Complete Jersey City sections of regional walkways, greenways and trails.

Strategy G4-H: Provide eyes on the street (and sidewalk, walkway and path) security.

Strategy G4-I: Create safety buffers between pedestrians and moving vehicles.

The Actions that should be implemented to achieve Goal 4 are as follows:

Action G4-1: Adopt as a City standard a street regulating plan that regulates the form of all streets, bike lanes, where feasible, and sidewalks in accordance with the street typologies and illustrated hierarchy of streets that are contained in this Circulation Element.

Action G4-2: Install traffic calming devices on existing streets with problem locations in accordance with the traffic calming plan that is contained in this Circulation Element.

Action G4-3: Adopt uniform City standards, which are ADA compliant and neighborhood appropriate, for pedestrian street crossings and crosswalks, including state-of-the-art techniques to protect pedestrian safety. For example, potential crosswalks may include a combination of crosswalk tables, curb extensions with gaps for drainage and bicycle lanes, polymer resin stamped brick crosswalks, and painted crosswalks as may be appropriate to the particular street. Curb extensions should incorporate vertical elements, such as trees or street furniture, to provide a visual cue to snowplow drivers of roadway alignments.

Action G4-4: Install street trees spaced at a maximum of 30 feet on center to provide shade and a pleasant pedestrian environment and establish a municipal street tree fund to which developers can contribute when trees cannot be installed. Street trees should be of a variety with high branching systems so that lower branches may be pruned to maintain sight lines for public safety purposes.

Action G4-5: Prune trees to remove low branches to provide lines of sight for vehicular and pedestrian safety and security.

Action G4-6: Increase pedestrian safety by utilizing mechanisms, such as on-street parking, street trees, street furniture and bollards, to buffer pedestrians from moving vehicles.

Action G4-7: Create a continuous greenway with pedestrian paths and bike lanes where the Morris Canal was filled in, where feasible.

Action G4-8: As recommended in the Hudson River Waterfront Walkway Plan, an operating entity should be formed to ensure that walkway gaps are filled in and that the entire walkway is consistent in appearance and condition.

Action G4-9: Construct the Lafayette Walkway parallel to the Hudson Bergen Light Rail Line.

Action G4-10: Extend the Morris Street Right-of-Way Pedestrian Extension to the waterfront and the Hudson River Waterfront Walkway.

# Resolution of the City of Jersey City, N.J.

City Clerk File No. Res. 18-982

Agenda No. 10.W

Approved: NOV 07 2018

TITLE:



**RESOLUTION RATIFYING THE SUBMISSION OF A GRANT APPLICATION AND AUTHORIZING THE EXECUTION OF A GRANT AGREEMENT WITH THE NEW JERSEY DEPARTMENT OF TRANSPORTATION FOR THE 2019 MUNICIPAL AID PROGRAM TO FUND ROADWAY IMPROVEMENTS FOR THE CITY OF JERSEY CITY**

**COUNCIL AS A WHOLE OFFERED AND MOVED ADOPTION THE FOLLOWING RESOLUTION:**

**WHEREAS**, the State of New Jersey Department of Transportation ("NJDOT") has announced that it is now accepting grant applications for the 2019 Municipal Aid Program to fund local transportation projects that must be completed and submitted through the System for Administering Grants Electronically (SAGE) on or before October 18, 2018; and

**WHEREAS**, the Mayor and Clerk of the City of Jersey City ("City"), Department of Administration, Division of Engineering, Traffic and Transportation are hereby authorized to submit an electronic application identified as **MA-2019-Grand Street Improvements Project-00547**, that will be a full roadway improvement project that will include all paving, handicap ramps, protected bike lanes, and other associated tasks to improve the Grand Street corridor from Bramhall Avenue to Hudson Street and the Hudson River waterfront; and

**WHEREAS**, the City is requesting State aid funding from the NJDOT 2019 Municipal Aid Program for the primary purpose of making roadway improvements; and

**WHEREAS**, the City agrees that it shall be required to appropriate capital funds for state non-participating items such as police salary hours and/or other ineligible project costs, and agrees to assume a commitment for maintenance and repair of the completed streets;

**NOW, THEREFORE, BE IT RESOLVED**, by the Municipal Council of the City of Jersey City that it ratifies and approves the submission of grant application **MA-2019- Grand Street Improvements Project-00547** to the New Jersey Department of Transportation on behalf of the City of Jersey City; and

**BE IT FURTHER RESOLVED**, that the Mayor and Clerk of the City of Jersey City, County of Hudson, State of New Jersey are hereby authorized to sign the grant agreement on behalf of the City of Jersey City and that their signatures constitute acceptance of the terms and conditions of the grant agreement and approves the establishment of an account for the grant.

City Clerk File No. Res. 18-982  
Agenda No. 10.W NOV 07 2018

TITLE:

**RESOLUTION RATIFYING THE SUBMISSION OF A GRANT APPLICATION AND AUTHORIZING THE EXECUTION OF A GRANT AGREEMENT WITH THE NEW JERSEY DEPARTMENT OF TRANSPORTATION FOR THE 2019 MUNICIPAL AID PROGRAM TO FUND ROADWAY IMPROVEMENTS FOR THE CITY OF JERSEY CITY**

Certified as a true copy of the Resolution adopted by Council,  
On this \_\_\_\_\_ day of \_\_\_\_\_, 2018

\_\_\_\_\_  
City Clerk

My signature and the Clerk's seal serve to acknowledge the above resolution and constitute acceptance of the terms and conditions of the grant agreement and approve the execution of the grant agreement as authorized by the resolution above.

ATTEST and AFFIX SEAL

\_\_\_\_\_  
City Clerk  
Robert Byrne

\_\_\_\_\_  
Presiding Officer  
Steven M. Fulop, Mayor of Jersey City

JRC/dlo  
10-05-18

*Smck*  
*10/26/18*

APPROVED: *Joseph P. Lima*

APPROVED AS TO LEGAL FORM

APPROVED: *[Signature]*  
Business Administrator

*[Signature]*  
Corporation Counsel

Certification Required

Not Required

APPROVED 8-0

RECORD OF COUNCIL VOTE ON FINAL PASSAGE 11.7.18											
COUNCILPERSON	AYE	NAY	N.V.	COUNCILPERSON	AYE	NAY	N.V.	COUNCILPERSON	AYE	NAY	N.V.
RIDLEY	✓			YUN	✓			RIVERA	✓		
PRINZ-AREY	✓			SOLOMON	✓			WATTERMANN	ABSENT		
BOGGIANO	✓			ROBINSON	✓			LAVARRO, PRES	✓		

✓ Indicates Vote

N.V.-Not Voting (Abstain)

Adopted at a meeting of the Municipal Council of the City of Jersey City N.J.

*[Signature]*  
Rólando R. Lavarro, Jr., President of Council

*[Signature]*  
Robert Byrne, City Clerk



**RESOLUTION FACT SHEET – NON-CONTRACTUAL**

This summary sheet is to be attached to the front of any resolution that is submitted for Council consideration. Incomplete or vague fact sheets will be returned with the resolution.

**Full Title of Ordinance/Resolution**

**RESOLUTION RATIFYING THE SUBMISSION OF A GRANT APPLICATION AND AUTHORIZING THE EXECUTION OF A GRANT AGREEMENT WITH THE NEW JERSEY DEPARTMENT OF TRANSPORTATION FOR THE 2019 MUNICIPAL AID PROGRAM TO FUND ROADWAY IMPROVEMENTS FOR THE CITY OF JERSEY CITY**

**Initiator**

Department/Division	ADMINISTRATION	ENGINEERING
Name/Title	JOSE R. CUNHA, C.M.E., P.E.	MUNICIPAL ENGINEER
Name/Title		
Phone/email	201-547-4411	jcunha@cnj.org

Note: Initiator must be available by phone during agenda meeting (Wednesday prior to council meeting @ 4:00 p.m.)

**Resolution Purpose**

The FY2019 State-funded Municipal Aid Program (the "Program"), administered by the New Jersey Department of Transportation (NJ DOT) provides funds to municipalities for the improvement of public roads and bridges under. Funds are allocated based on a formula in the state legislation that considers municipal road mileage within a county and county population. The City of Jersey City ("City") wishes to apply for these grant funds in the approximate amount of \$7,011,163.75 for roadway improvements along the Grand Street corridor from Bramhall Avenue to Hudson Street and the Hudson River waterfront. The City is designating Jose R. Cunha as the responsible charge for this program. Mr. Cunha is the Director of Engineering for the Jersey City Division of Engineering, Traffic and Transportation.

**Cost (Identify all sources and amounts)**

**Contract term (include all proposed renewals)**

Construction Estimate		\$5,608,931.00
10% Contingency		\$560,893.10
Const. Mgmt/Inspection/Testing		\$841,339.65
<b>GRANT APPLICATION</b>	<b>TOTAL REQUEST</b>	<b>\$7,011,163.75</b>

[Empty box for contract term information]

\* Note – No City match required by NJDOT on Municipal Aid funding. Capital money utilized on items not eligible for state reimbursement.

Type of award

If "Other Exception", enter type

I certify that all the facts presented herein are accurate.

Jose R. Cunha  
Jose R. Cunha, P.E., C.M.E.,  
Director of Engineering

10/18/18  
Date

Brian D. Platt  
Brian D. Platt, Business Administrator  
Department Director

10/31/18  
Date



**CITY OF JERSEY CITY**  
DEPARTMENT OF ADMINISTRATION  
DIVISION OF ENGINEERING, TRAFFIC & TRANSPORTATION  
MUNICIPAL SERVICES COMPLEX | 13-15 LINDEN AVE EAST | JERSEY CITY, NJ 07305  
P: 201 547 4470 | F: 201 369 7292



STEVEN M. FULOP  
MAYOR OF JERSEY CITY

BRIAN D. PLATT  
BUSINESS ADMINISTRATOR

**MEMORANDUM**

DATE : October 5, 2018

TO : Rolando R. Lavarro, Council President and  
Members of the Municipal Council

FROM :  Jose R. Cunha, P.E., C.M.E., C.P.W.M., C.R.P.  
Director of Engineering

SUBJECT : **Resolution to Ratify Submission of an Application to the New  
Jersey Department of Transportation for FY2019 Municipal Aid**

Attached for your consideration is a resolution ratifying the submission of the 2019 Municipal Aid grant application and authorizing the execution of a grant agreement with New Jersey Department of Transportation for the engineering project identified as **MA-2019-Grand Street Improvements Project-00547**. Grand Street will be a full roadway improvement project that includes paving, handicap ramps, protected bike lanes, and other associated tasks to improve the corridor from Bramhall Avenue to Hudson Street and the Hudson River waterfront.

This application is requesting \$7 million dollars for construction, contingency, and construction management. The final scope of project is determined by the available funding from NJDOT. We respectfully ask for your continued support of City applications to NJDOT for state aid.

Please contact my office at 201-547-4411 should you have any questions or need additional information.

cc: Robert Byrne, City Clerk  
Brian D. Platt, Business Administrator  
Donna Mauer, Chief Financial Officer  
Andrew Vischio, Director of Traffic and Transportation  
Paul Russo, Supervising Engineer  
Dawn Odom, Supervising Administrative Analyst

### *Scope of Work*

The City of Jersey City is requesting funding in the amount of \$7,011,163.75 to redesign Grand Street, a City-owned/maintained roadway that spans approximately two miles.

Currently, there are several deficiencies along the Grand Street corridor, including narrow sidewalk widths, which are often located close to schools; missing or worn-out crosswalk striping; lack of right-of-way dedicated to bicycle travel; poor pavement and drainage conditions between Summit Avenue and Johnston Avenue; lack of transit treatments and amenities at bus stop locations; non-ADA-compliant sidewalk curb ramps; and limited signal coordination for corridor operations.

The City seeks to address these deficiencies and transform Grand Street into a safer and more operationally-efficient roadway that provides multi-modal, east-west crosstown connections. To date, the City has completed a concept development study (attached in this application), which proposes a full redesign of Grand Street. This plan includes the following:

- Installation of a raised cycle track by closing one travel lane between Communipaw Avenue and Jersey Avenue;
- Installation of two traffic signals;
- Installation of streetscaping and green stormwater infrastructure;
- Installation of center islands and curb extensions;
- Installation of new sidewalk;
- Installation of traffic signs and roadway stripes that reflect new cross-sections;
- Installation of bus shelters with bus pull-offs;
- Milling and paving of Grand St; and
- Coordination of traffic signals and upgrades to traffic detection cameras.

This project envisions calmed vehicular traffic patterns, increased driver awareness of pedestrians, enhanced multi-modal connections, and dedicated bicycle facilities. The City now seeks FY2019 Municipal Aid funding to implement this vision.

The scope of work for this project includes:

- Installation of concrete curbs (8,000 LF), sidewalks (3,270 SY), and driveways (270 SY);
- Installation of catch basins (15 traps);
- Installation of detectable warning surfaces (100 SY);
- Installation of brick pavers (90 SY);
- Milling and paving of roadway (63,000 SY);
- Installation of thermoplastic traffic stripes (75,000 LF) and markings symbols (15,000 SF);
- Installation of striped rumble strips (200 SF);
- Installation of bus shelters (20 units);
- Planting of trees (100);
- Installation of pedestrian safety cameras (12 units)
- Installation of new traffic signal (1 unit)

- Signalization upgrades

The City will also install, reconstruct, and reset inlets; reset manholes; relocate or remove signage; reset and relocate junction boxes; and install benches, trash receptacles, and other amenities. Other activities incorporated into the full scope of work are further detailed in the attached cost estimate, prepared by the City's licensed engineer.

This project will transform the auto-oriented Grand Street by enhancing pedestrian, bicycle, and transit facilities and amenities that make alternative modes of travel easier, more attractive, and safer for all users. These types of improvements typically result in more walkable, sustainable communities that promote community interaction, residents' health, and economic growth for local small businesses. Additionally, these improvements are anticipated to yield demonstrable safety increases: the Grand Street corridor experienced 505 reportable crashes over a three-year period between January 2014 and December 2016. The City developed a weighted average crash reduction factor from crash modification factors (CMFs) and found that vehicle crashes will decrease by approximately 12% and pedestrian crashes will decrease by approximately 62% following project completion.

Following an award of grant funding, the project schedule for this project is as follows:

Months 1-3: Procurement for design work

Months 3-11: Design of Grand Street project

Months 12-14: Bid package for construction

Months 15-17 Procurement of Contractor

Months 18-23: Mill and pave Grand Street

Months 24-33: Construction of Complete Streets elements

Month 34: Project completion and NJ DOT closeout process initiated

Month 35: NJDOT inspection and project closeout

*Does the project involve any of the safety improvements listed below? If so, please check all applicable and add a narrative of proposed safety improvements in the box below.*

<b>Traffic Control Device</b>	<b>Drainage Improvements (increase capacity/new drainage)</b>
<b>Geometric Improvements</b>	<b>Guiderail (new/upgrade)</b> <b>RPMs</b> <b>Rumble Strips</b>

Two mid-block traffic control devices have been proposed between Bates Street and Jersey Avenue to mitigate aggressive driving. The schools on the north side of the corridor and the Jersey City Medical Center on the south side of the corridor generate significant pedestrian activity. Furthermore, there is a heavily-utilized mid-block bus stop that results in pedestrians crossing at an uncontrolled mid-block location. Therefore, to address this activity, signalized mid-block crosswalks are included.

To further enhance safety, this project also includes upgrades to all existing traffic signal equipment, including new signal controllers, video detection for full actuation on all approaches, emergency preemption at all signalized intersections, and improved coordination along the full length of the corridor.

Geometric improvements include pedestrian enhancements such as curb extensions and center islands as well as the creation of bike lanes.

To improve drainage, the City will install new inlets along the south side of the roadway. The City will utilize green stormwater infrastructure underneath new tree beds or within curb extension areas wherever possible.

This project also includes reconstruction of existing substandard ADA curb ramps as necessary. Therefore, there is a net benefit to accessibility for all users.

Lastly, to calm traffic, 200 linear feet of rumble strips are included in this scope of work.

FY 2019 NJDOT MUNICIPAL AID  
 Grand Street from Bramhall Avenue to Hudson Street  
 ENGINEER'S DESIGN ESTIMATE - REVISED 10/3/2018

*Jose R. Cunha*  
 Jose R. Cunha, PE, CME  
 City Engineer

Jersey City, Hudson County, New Jersey

		UNIT	TOTAL CONTRACT QUANTITIES	UNIT PRICE	AMOUNT
1	CONSTRUCTION SIGNS	SF	500	\$20.00	\$ 10,000.00
2	DECORATIVE CROSSWALK	SF	1000	\$26.00	\$ 26,000.00
3	BREAKAWAY BARRICADES	UNIT	50	\$60.00	\$ 3,000.00
4	TRAFFIC DRUMS	UNIT	150	\$30.00	\$ 4,500.00
5	TRAFFIC CONES	UNIT	300	\$10.00	\$ 3,000.00
6	TRAFFIC CONTROL TRUCK WITH MOUNTED CRASH CUSHION	UNIT	2	\$8,000.00	\$ 16,000.00
7	INLET TYPE 'A' (IF & WHERE DIRECTED)	UNIT	10	\$4,000.00	\$ 40,000.00
8	INLET TYPE 'B' (IF & WHERE DIRECTED)	UNIT	50	\$4,000.00	\$ 200,000.00
9	INLET TYPE 'E' (IF & WHERE DIRECTED)	UNIT	10	\$4,000.00	\$ 40,000.00
10	RECONSTRUCT INLET, TYPE A, USING NEW CASTING (IF & WHERE DIRECTED)	UNIT	10	\$1,300.00	\$ 13,000.00
11	RECONSTRUCT INLET, TYPE B, USING NEW CASTING (IF & WHERE DIRECTED)	UNIT	40	\$2,200.00	\$ 88,000.00
12	RECONSTRUCT INLET, TYPE E, USING NEW CASTING (IF & WHERE DIRECTED)	UNIT	10	\$2,200.00	\$ 22,000.00
13	RESET INLET W/ NEW FRAME, CURB PIECE, BICYCLE SAFE GRATE	UNIT	40	\$1,000.00	\$ 40,000.00
14	RESET INLET W/ EXIST. FRAME, CURB PIECE, BICYCLE SAFE GRATE	UNIT	50	\$500.00	\$ 25,000.00
15	DRIVEWAY ACCESS BACKPLATE	UNIT	10	\$600.00	\$ 6,000.00
16	CURB PIECE TYPE 'N', 4"	UNIT	25	\$275.00	\$ 6,875.00
17	CURB PIECE TYPE 'N', 6"	UNIT	25	\$300.00	\$ 7,500.00
18	CURB PIECE TYPE 'N', 8"	UNIT	25	\$325.00	\$ 8,125.00
19	INLET FILTER, TYPE 1	UNIT	300	\$100.00	\$ 30,000.00
20	CATCH BASIN TRAP	UNIT	15	\$600.00	\$ 9,000.00
21	CATCH BASIN WALL PLATE	UNIT	20	\$650.00	\$ 13,000.00
22	REPAIRED CATCH BASIN WALL	SF	750	\$25.00	\$ 18,750.00
23	12" DIP CLASS 52 (IF & WHERE DIRECTED)	LF	250	\$85.00	\$ 21,250.00
24	16" DIP CLASS 52 (IF & WHERE DIRECTED)	LF	250	\$100.00	\$ 25,000.00
25	3/4" WASHED GRAVEL PIPE BEDDING (IF & WHERE DIRECTED)	TON	300	\$30.00	\$ 9,000.00
26	9"X20" CONCRETE VERTICAL CURB	LF	8000	\$45.00	\$ 360,000.00
27	CONCRETE SIDEWALK, 4" THICK	SY	3600	\$60.00	\$ 216,000.00
28	CONCRETE SIDEWALK, REINFORCED 6" THICK	SY	270	\$90.00	\$ 24,300.00
29	CONCRETE DRIVEWAY, REINFORCED 8" THICK	SY	270	\$100.00	\$ 27,000.00
30	DETECTABLE WARNING SURFACE	SY	100	\$250.00	\$ 25,000.00
31	BRICK PAVERS (IF & WHERE DIRECTED)	SY	90	\$150.00	\$ 13,500.00
32	SAWCUTTING, 10" OR LESS	LF	1300	\$2.50	\$ 3,250.00
33	DENSE, GRADED AGGREGATE, 4" THICK (IF & WHERE DIRECTED)	SY	1000	\$30.00	\$ 30,000.00
34	ASPHALT PRICE ADJUSTMENT	LS	1	\$10,000.00	\$ 10,000.00
35	FUEL PRICE ADJUSTMENT	LS	1	\$5,000.00	\$ 5,000.00
36	HMA MILLING, 3" OR LESS	SY	63000	\$4.50	\$ 283,501.00
37	HMA PATCH	TON	100	\$90.00	\$ 9,000.00
38	HMA 19M64 BASE COURSE, 6" THICK (10% OF THE AREA)	TON	2250	\$90.00	\$ 202,500.00
39	HMA 9.5M64 SURFACE COURSE, 2" THICK (PLUS 1/2")	TON	10000	\$90.00	\$ 900,030.00
40	GEOTEXTILE	SY	100	\$5.00	\$ 500.00
41	EXCAVATION UNCLASSIFIED	CY	600	\$40.00	\$ 24,000.00
42	EXCAVATION TEST PITS	CY	10	\$50.00	\$ 500.00
43	TRAFFIC STRIPES LONG LIFE THERMOPLASTIC, 4" THICK	LF	75000	\$0.65	\$ 48,750.00
44	TRAFFIC MARKINGS SYMBOLS LONG LIFE THERMOPLASTIC	SF	15000	\$6.00	\$ 90,000.00
45	NO PARKING DRIVEWAY	UNITS	60	\$50.00	\$ 3,000.00
46	STRIPED RUMBLE STRIP	LF	200	\$5.00	\$ 1,000.00
47	REGULATORY TRAFFIC SIGN WITH WITH STEEL POST	SF	200	\$50.00	\$ 10,000.00
48	RELOCATE EXISTING TRAFFIC SIGN ON NEW STEEL POST	UNIT	5	\$160.00	\$ 800.00
49	RELOCATE OR REMOVE EXISTING TRAFFIC SIGN	UNIT	5	\$150.00	\$ 750.00
50	RESET SEWER MANHOLE, 24" USING NEW CASTING	UNIT	40	\$900.00	\$ 32,000.00
51	RESET SEWER MANHOLE, 30" USING NEW CASTING	UNIT	10	\$1,500.00	\$ 15,000.00
52	RESET WATER VALVE BOX WITH RISER	UNIT	150	\$40.00	\$ 6,000.00
53	RESET WATER VALVE BOX (RAISE/LOWER ENTIRE BOX)	UNIT	10	\$80.00	\$ 800.00
54	NEW WATER VALVE BOX ENTIRE ASSEMBLY	UNIT	10	\$450.00	\$ 4,500.00
55	NEW WATER VALVE BOX UPPER ASSEMBLY	UNIT	10	\$325.00	\$ 3,250.00
56	RECONSTRUCTED 8'X10' TREE PIT WITH RAILING AND ROOT BARRIERS	UNIT	100	\$1,500.00	\$ 150,000.00
57	TREE PLANTING 3 1/2 CALIPER	UNIT	100	\$50.00	\$ 5,000.00
58	TRASH RECEPTACLES	UNIT	100	\$1,200.00	\$ 120,000.00
59	BENCHES	UNIT	50	\$1,800.00	\$ 90,000.00
60	BUS SHELTERS	UNIT	20	\$8,000.00	\$ 160,000.00
61	TRAFFIC DETECTION PEDESTRIAN SAFETY CAMERA UPGRADES	UNIT	12	\$20,000.00	\$ 240,000.00
62	UPDATE EXISTING SIGNALIZED INTERSECTIONS	LS	1	\$1,000,000.00	\$ 1,000,000.00
63	PROPOSED SIGNALIZED INTERSECTIONS	LS	1	\$500,000.00	\$ 500,000.00
64	SIGNAL SYSTEM INTERCONNECTIONS	LS	1	\$125,000.00	\$ 125,000.00
65	RESET JUNCTION BOX	UNIT	20	\$1,000.00	\$ 20,000.00
66	RELOCATE JUNCTION BOX WITH NEW BOX	UNIT	10	\$8,000.00	\$ 80,000.00

SUBTOTAL BASE BID: \$ 5,608,931.00

10% CONTINGENCY: \$ 560,893.10

15% CONSTRUCTION AND INSPECTION \$ 841,339.65

TOTAL PROJECT ESTIMATED COST: \$ 7,011,163.75



[NJDOT Home](#)  
[Engineering](#)

[About NJDOT](#)  
[In the Works](#)

[NJcommuter.com](#)  
[Capital Program](#)

[Community Programs](#)  
[Freight, Air and Water](#)

[Reference / Links](#)  
[Doing Business](#)

[Local Aid and Economic Development Overview](#)

[What's New](#)

[Funding Programs](#)

[Recent Grant Recipients](#)

**State Funded Programs**

- Municipal Aid**
- County Aid
- Local Aid
- Infrastructure Fund
- Bikeways
- Safe Streets to Transit
- Transit Village
- Local Bridges, Future Needs
- Local Freight
- Impact Fund (LFIF)
- Federally Funded Programs
- Transportation Infrastructure Bank Fund
- Federal Eligibility Requirements
- Publications
- Forms and Applications
- District Offices

# Local Aid

## and Economic Development

### Municipal Aid

**FY 2019 Grant Solicitation – State Aid Programs**

The Division of Local Aid is currently accepting application for Following State Aid program through SAGE.

- Municipal Aid
- Transit Village
- Bikeways
- Safe Streets to Transit

Application Deadline: October 8, 2018

The Municipal Aid program is a competitive program intended to provide municipalities with transportation based grants to supplement their transportation programs. Starting in FY2018 the Transportation Trust Fund (TTF) will provide \$400 million in State Aid to municipalities and counties for local transportation improvements. Of that amount the Municipal Aid Program will be funded at level of \$140 million. Additionally \$10 million is allotted for municipalities qualifying for Urban Aid under P.L. 1978 c.14 (N.J.S.A. 52:27D-178 et seq.,). The individual allotments to qualifying municipalities are based on proportions determined by the Department of Community Affairs.

Each fiscal year, the New Jersey Department of Transportation (NJDOT) issues a solicitation announcement to municipalities inviting them to apply for funding for their specific project needs. The Municipal Aid Program is administered consistent with the language and formula distribution contained within the TTF legislation that allocates funds by county based a formula that considers population and municipal roadway miles.

Municipalities can apply for projects for Municipal Aid within one of the 7 categories below:

- Bikeway
- Primary project purpose is for constructing new bikeways (e.g.

- bike lanes, bike paths, bike compatible roadways).
- Bridge Preservation
  - Primary project purpose is for improving the condition of bridge infrastructure (e.g. new deck, rehabilitation, replacement).
- Mobility
  - Primary project purpose is to enhance mobility and reduce congestion (e.g. adding lanes, signal optimization).
- Pedestrian Safety
  - Primary project purpose is to enhance pedestrian safety (e.g. new sidewalks, new crosswalks, traffic calming, pedestrian overpass).
- Quality of Life
  - Primary project purpose is for beautification, environmental mitigation, economic development or historic preservation.
- Roadway Preservation
  - Primary project purpose is for improving the condition of roadway infrastructure (e.g. resurfacing, reconstruction, drainage).
- Roadway Safety
  - Primary project purpose is to enhance vehicular safety (e.g. guide rail, signing, warning devices, and striping).

All applications for the Municipal Aid Program are to be submitted online through System for Administering Grants Electronically (SAGE). Each district office will review applications within their designated geographic area for completeness, make a field investigation, evaluate and assign a rating to each project. Applications receive points based on various criteria including existing conditions; Average Daily Traffic (ADT), safety improvements, and access to services to public. Other important criteria include the municipality's special designation, whether the municipality has received an allotment within the last three years, and the municipality's award and close-out performance on previously awarded State grants.

Projects for which online applications have been submitted are presented to a screening committee comprised of municipal engineers and NJDOT staff appointed by the Commissioner. The committee evaluates the projects presented and makes recommendations to the Commissioner of Transportation for consideration and approval. The State pays 75% of the funds at the time of award concurrence and the remainder on a reimbursement basis after acceptance by the municipality and the State of the work completed.



Additional information can be found in Municipal Aid Handbook and State Aid Handbook.

- [Application for Funding \(SAGE\)](#)
- [FY 2018 Municipal Aid Grant Recipients](#) (pdf 96k)
- [Municipal Aid Regulations](#) (Adopted April 16, 2014) (pdf 69k)
- [Special Provisions and State Aid Projects](#) (pdf 95k)
- [Special Provisions, Baseline Document Changes and Pay Items](#)
- [State Aid Handbook](#) (pdf 95k)
- [Municipal Aid Handbook](#) (pdf 63k)

You will need Adobe Acrobat Reader to view the PDF files which is available at our state [Adobe Acrobat Access](#) page.



[Contact Us](#) | [Privacy Notice](#) | [Legal Statement](#) | [Accessibility Statement](#)



department: [home](#) | [about](#) | [NJ commuter](#) | [in the works](#) | [business](#) | [engineering](#) | [freight, air & water](#) | [capital](#) | [community](#) | [data](#) | [links](#) | [index](#)  
statewide: [NJ Home](#) | [about NJ](#) | [business](#) | [government](#) | [state services A to Z](#) | [departments](#)

Copyright © State of New Jersey, 2002-2018  
Department of Transportation  
P.O. Box 600  
Trenton, NJ 08625-0600



OPRA | Open  
Public Records  
Act

Last Updated: July 25, 2018

# Resolution of the City of Jersey City, N.J.

City Clerk File No. Res. 18-983

Agenda No. 10.X

Approved: \_\_\_\_\_



TITLE:

**RESOLUTION AUTHORIZING THE CITY OF JERSEY CITY TO ENTER INTO A COST REIMBURSEMENT AGREEMENT NO. 2018-DT-BLA-205 WITH THE STATE OF NEW JERSEY, DEPARTMENT OF TRANSPORTATION, DIVISION OF LOCAL AID AND ECONOMIC DEVELOPMENT FOR THE DR. MARTIN LUTHER KING DRIVE, SEC. 2 INTERSECTION IMPROVEMENTS PROVIDED FOR THROUGH THE U.S. DEPARTMENT OF TRANSPORTATION**

**COUNCIL AS A WHOLE  
FOLLOWING RESOLUTION:**

**OFFERED AND MOVED ADOPTION THE**

**WHEREAS**, the City of Jersey City (City), Department of Administration, Division of Engineering, Traffic and Transportation submitted an application to the North Jersey Transportation Planning Authority (NJTPA) for federal funding under the FY2015-2016 Local Safety Program for a project known as Dr. Martin Luther King Drive, Sec. 2 Intersection Improvements, Jersey City Project No: 15-002-T, Federal Aid Project No: HSP-0609 (357) CON was authorized and found eligible for federal cost reimbursement in the amount not to exceed \$625,173.00; and

**WHEREAS**, the New Jersey Department of Transportation (NJDOT) received federal authorization on August 6, 2018 allowing the City to move forward with the public bid and implementing the Dr. Martin Luther King Drive, Sec. 2 Intersection Improvements, Jersey City Project No: 15-002-T, Federal Aid Project No: HSP-0609 (357) CON); and

**WHEREAS**, under the terms and conditions of the federal aid agreement the City must execute the **Cost Reimbursement Agreement No. 2018-DT-BLA-205** in which all such work shall be completed by September 30, 2021 unless the Cost Reimbursement Agreement is terminated or extended by written authorization of the State; and

**WHEREAS**, the City prepared plans, specifications and designated a resident engineer to monitor and inspect all work performed by the contractor awarded the construction contract, in addition to controlling the approved budget, administering payment vouchers and submitting compliance/progress reports regarding such transactions to NJDOT for allowable cost reimbursement not to exceed \$625,173.00; and

**WHEREAS**, the City agrees to accept responsibility for maintenance of the project after construction is completed.

**NOW, THEREFORE, BE IT RESOLVED**, by the Municipal Council of the City of Jersey City that the Mayor or Business Administrator and City Clerk are authorized to execute the **Cost Reimbursement Agreement No. 2018-DT-BLA-205**, which is attached hereto, for the Dr. Martin Luther King Drive, Sec. 2 Intersection Improvements, Jersey City Project No: 15-002-T, Federal Aid Project No: HSP-0609 (357) CON and their signatures constitute acceptance of the terms and conditions of the federal grant agreement; and

*JMcK  
10/26/18*

**BE IT FURTHER RESOLVED**, that the Mayor or Business Administrator are hereby authorized to accept federal aid on behalf of the City of Jersey City from the New Jersey Department of Transportation for the Dr. Martin Luther King Drive, Sec. 2 Intersection Improvements, Jersey City Project No: 15-002-T, Federal Aid Project No: HSP-0609 (357) CON.

APPROVED: Jose R. Lavarro

APPROVED AS TO LEGAL FORM

APPROVED: \_\_\_\_\_  
Business Administrator

\_\_\_\_\_  
Corporation Counsel

Certification Required

Not Required

**APPROVED**

RECORD OF COUNCIL VOTE ON FINAL PASSAGE 11.7.18											
COUNCILPERSON	AYE	NAY	N.V.	COUNCILPERSON	AYE	NAY	N.V.	COUNCILPERSON	AYE	NAY	N.V.
RIDLEY				YUN				RIVERA			
PRINZ-AREY				SOLOMON				WATTERMAN			
BOGGIANO				ROBINSON				LAVARRO, PRES.			

✓ Indicates Vote

N.V.-Not Voting (Abstain)

Adopted at a meeting of the Municipal Council of the City of Jersey City N.J.

\_\_\_\_\_  
Rolando R. Lavarro, Jr., President of Council

\_\_\_\_\_  
Robert Byrne, City Clerk



State of New Jersey

DEPARTMENT OF TRANSPORTATION
P.O. Box 600
Trenton, New Jersey 08625-0600

PHILIP D. MURPHY
Governor

DIANE GUTIERREZ-SCACCETTI
Commissioner

SHEILA Y. OLIVER
Lt. Governor

August 22, 2018

Mr. Jose R. Cunha, PE
City Engineer
13 - 15 Linden Avenue East
Jersey City, NJ 07305

Ref.: Dr. Martin Luther King Drive
City of Jersey City, Hudson County
Federal Project No. HSP-0609 (357) CON
Job No. 6306395

RECEIVED
18 SEP 14 PM 2:06
CITY OF JERSEY CITY
ENGINEERING
DIRECTOR'S OFFICE

Dear Mr. Cunha:

On 8/6/2018, the Federal Highway Administration (FHWA) authorized funding in the amount of \$ 625,173.00 for construction and \$ 0.00 for construction inspection services for the above captioned Federal Aid Highway Program project.

Requirements for this project include, but are not limited to, the following:

Local Public Agency (LPA) Eligibility

- The SPONSOR is required to maintain its LPA Eligibility Certification current and valid during the term of this project agreement in accordance with the requirements of NJDOT Division of Local Aid and Economic Development Policy/Procedure No. 010.00 dated October 1, 2012.

Advertisement of Contract

- As per the NJDOT Procedures for Federal Aid Projects in the Division of Local Aid and Economic Development's Federal Aid Handbook, the SPONSOR is required to advertise for construction bids within 60 calendar days from the date of this letter. The project shall be advertised once a week for a minimum of three (3) consecutive weeks in at least two (2) legal newspapers. Bids may be taken a minimum of 10 days following the final

"IMPROVING LIVES BY IMPROVING TRANSPORTATION"

New Jersey Is An Equal Opportunity Employer • Printed on Recycled and Recyclable Paper

**These must be downloaded not more than ten (10) days prior to advertisement and inserted into the final bid specifications.**

- Contract completion date as noted in the bid documents must be specified in the project specifications with provisions for liquidated damages as per NJDOT 2007 Standard Specifications for Road and Bridge Construction section 108.20.

#### Pre-Award of Contract

- The SPONSOR will be require to email the following forms submitted by each bidder to the Local Aid project manager as well as cc. [DOT-CR.Verifications@dot.nj.gov](mailto:DOT-CR.Verifications@dot.nj.gov) immediately after the five day Civil Rights document submittal period following the bid opening:
  - A list of all responsive bidders as determined by the SPONSOR'S Legal Department in the order of lowest bidder to highest bidder.
  - A completed and signed Form CR-266 – Schedule of DBE/ESBE/SBE Participation for each DBE firm being used to meet the Contract goal [Forms can be downloaded from <http://www.state.nj.us/transportation/business/civilrights/forms.shtm>]. Revisions to the CR-266 will not be accepted after its initial submission and before award of the Contract.
  - A completed and signed Verification of DBE/ESBE/SBE Firm (Form CR-273) for each firm listed on the CR-266 to demonstrate direct written confirmation from each DBE firm of willingness to participate on the Contract, confirming the kind and amount of work that was provided on the Contractor's CR-266. This form must be completed in its entirety and signed by each DBE firm.
  - A completed and signed DBE/ESBE/SBE Regular Dealer/Supplier Verification (Form CR-272) for all Regular Dealers/Suppliers listed on the CR-266 form, if applicable. This form must be completed in its entirety and signed by each DBE firm.
  - A completed and signed DBE/ESBE/SBE Trucking Verification (Form CR-274) for all DBE trucking firms listed on the CR-266, if applicable. This form must be completed in its entirety and signed by each DBE firm.
  - Documented evidence of good faith efforts if the bidder's commitment shown on the CR-266 fails to equal or exceed the contract DBE goal.
  - The process contractors who fail to meet the contract goal must comply with can be found in the amended Section 102.13.01 of the NJDOT Specifications

Firms listed on the CR-266 will not be counted toward the Contract DBE goal unless completed and signed CR-273 form(s), and applicable CR-272 and CR-274 form(s) are submitted to Jersey City within the 5 days after bid opening.

NJDOT Civil Rights will review the submitted forms and if the apparent lowest responsive bidder meets the Contract DBE goal, will issue an approval to the Local Aid Project

and Evaluation, dated January 20, 2004 {Formerly T5080.4}. These Guidelines are available at: <http://www.fhwa.dot.gov/programadmin/contracts/ta508046.pdf>.

#### Project Agreement (included under separate cover letter)

- Return four (4) original signed and sealed copies of the attached agreement along with a signed/sealed Resolution for execution by the Department. **DO NOT** enter the date on page
- Signed copies of the agreement should be returned within 45 days.
- All projects constructed with Federal funds require full-time construction inspection and oversight. Failure to follow the Federal guidelines may result in the loss of Federal reimbursement.
- No reimburseable work can be performed until the project agreement is executed by the NJDOT.

#### Project Billing

- NJDOT must receive an initial billing (payment voucher) from the recipient for the construction project no later than 3 months after NJDOT has concurred in the award of the construction contract. NJDOT may receive subsequent billings (payment vouchers) on a monthly basis after the initial billing but no later than 3 months thereafter as stipulated in the project agreement. Failure to meet the billing requirements may result in the restriction of authorization of any future FWHA funding until such time as progress on timely billings is demonstrated.
- The project will be considered "Inactive" if the SPONSOR fails to submit an invoice within the durations described in 23 CFR 630.106. It is the SPONSOR'S responsibility to ensure that the federal funding is not jeopardized for this project due to an "Inactive" project status.

#### Final Inspection and Closeout

- Requests for final inspection and acceptance to NJDOT shall be made by the recipient not later than 30 days following Substantial Completion of construction.
- Close-out documents shall be submitted by the recipient to NJDOT within 6 months of receipt of acceptance by NJDOT.

Failure to meet the time requirements for project close-out may result in the restriction of authorization of future FWHA funding until such time as progress on close-out is demonstrated.

Recipients may appeal decisions made by NJDOT regarding all above compliance issues on a case-by-case basis, but NJDOT reserves the right to make a final determination whether to continue funding the project or not. NJDOT will be reviewing the status of the federal-aid agreement and the issues associated with compliance on a monthly basis.

**AMENDED FEDERAL AID AGREEMENT**

Agreement No.: 2018-DT-BLA-205

Contract ID: 19 70929

Local Public Agency (LPA): City of Jersey City

CFDA Name and Number.: Highway Planning and Construction 20.205

LPA DUNS Number: 831438275

Contact Name and Phone Number: Nabil Ayoub, 973-877-1500

This Amended Cost Reimbursement Agreement ("Agreement") is made as of the \_\_\_\_\_ day of \_\_\_\_\_, by and between the City of Jersey City, having its offices at 280 Grove Street, Jersey City, NJ 07302 ("Recipient") and the State of New Jersey, Department of Transportation, Division of Local Aid and Economic Development, having its offices at 1035 Parkway Avenue, Trenton, NJ 08625 ("State");

WITNESSETH

WHEREAS, the Recipient and the State entered into a Cost Reimbursement Agreement, executed by the Recipient on \_\_\_\_\_, for a project eligible for funding (the "Project") pursuant to the terms and conditions of the Cost Reimbursement Agreement; and

WHEREAS, the parties wish to amend the Cost Reimbursement Agreement by entering into this Agreement; and

NOW, THEREFORE, for and in consideration of the mutual covenants contained herein, and pursuant to all federal, state, and local laws and ordinances, the Recipient and the State hereby agree as follows:

**1. Description of Project – Scope of Work**

Section 1 of the Cost Reimbursement Agreement is fully incorporated into the terms of this Agreement as if fully stated at length in this Agreement.

**2. Agreement Contract Term**

Section 2 of the Cost Reimbursement Agreement is incorporated into the terms of this Agreement as if fully stated at length in this Agreement except as follows:

Paragraph 2.2 is deleted in its entirety and is replaced by the following provision:

2.2 Subject to the following, this Agreement may be terminated by either party upon thirty (30) days written notice to the other party.

2.2.1 The State may, in its sole discretion, terminate this agreement for cause and all of its obligations under this Agreement if any of the following occurs:

2.2.1.1 The Recipient fails to begin expenditure of award funds;

2.2.1.2 The Recipient fails to meet the conditions and obligations specified under this agreement, including a material failure to comply with the period of performance in section 2.1 even if it is beyond the reasonable control of the Recipient.

2.2.1.3 The State, the United States Department of Transportation (“USDOT”), or the Federal Highway Administration (“FHWA”), may terminate this agreement for convenience if, in their sole discretion, they determine that termination of this agreement is in the public interest. Costs incurred by the Recipient as a result of a termination for convenience by the State or FHWA may be included in the Recipient's claim for compensation.

2.2.2 In the event the Recipient terminates the Agreement, the State in its discretion will determine compensation, if any, to be paid.

2.2.3 Fund Liquidation, Adjustment, and Cancellation.

2.2.3.1 The Recipient shall liquidate all obligations under this award not later than 90 days after the period of performance end date that is listed in section 2.1.

2.2.3.2 Liquidation and adjustment of funds under this agreement follow the requirements of 2 CFR §§200.343–345.

### **3. Plans and Specifications**

Section 3 of the Cost Reimbursement Agreement is fully incorporated into the terms of this Agreement as if stated as if fully stated at length in this Agreement.

### **4. Project Work**

Section 4 of the Cost Reimbursement Agreement is incorporated into the terms of this Agreement as if stated at length in this Agreement except as follows:

Section 4.4 is deleted in its entirety and is replaced by the following provision:

4.4 Recipient shall solicit proposals for the work in accordance with the Brooks Act of 1972 (40 USC Chapter 11), 2 C.F.R. §§ 200.317-326, and all applicable federal and state laws, rules and regulations. All contracts entered into under this Agreement must contain the applicable provisions described in 2 C.F.R. § 200, App. II—Contract Provisions for non-Federal Entity Contracts Under Federal Awards. Additionally, all design solicitations and construction bid solicitations by the Recipient must include the following language: "Proposals are being solicited through a fair and open process in accordance with N.J.S.A. 19:44A-20.2, et seq., and as such, contractors are exempt from the limitations on making political contributions under that law. Further, for that reason, as well as because of a language in the New Jersey's Annual Appropriations Act, refusal to disclose campaign contributions otherwise required by N.J.S.A. 19:44A-20.2 et seq. and 19:44A-20.25 et seq., will not adversely affect your consideration for award."

### **5. through 31.**

Sections 5 through 31 of the Cost Reimbursement Agreement are fully incorporated into the terms of this Agreement as if fully stated at length in this Agreement.

IN WITNESS WHEREOF, the parties have caused their duly authorized representatives to duly execute this Agreement on and as of the day and year first above written.

Project: Dr. Martin Luther King Drive  
Municipality: City of Jersey City,

County: Hudson

ATTEST/WITNESSED/AFFIX SEAL:

RECIPIENT City of Jersey City

\_\_\_\_\_ Date

Name: Robert Byrne  
Title: Clerk

By: \_\_\_\_\_ Date

Name: Steven M. Fulop  
Title: Mayor

ATTEST/WITNESSED/AFFIX SEAL:

NEW JERSEY DEPARTMENT OF TRANSPORTATION

\_\_\_\_\_ Date

Anika James  
Department Secretary,  
New Jersey Department of Transportation

By: \_\_\_\_\_ Date

Laine Rankin, Director,  
Division of Local Aid & Economic  
Development

THIS DOCUMENT HAS BEEN REVIEWED AND APPROVED AS TO FORM

GURBIR S. GREWAL  
ATTORNEY GENERAL OF NEW JERSEY

By: \_\_\_\_\_

Brad M. Reiter  
Deputy Attorney General

\_\_\_\_\_ Date



# Resolution of the City of Jersey City, N.J.

City Clerk File No. Res. 18-983

Agenda No. 10.X

Approved: NOV 07 2018



TITLE:

**RESOLUTION AUTHORIZING THE CITY OF JERSEY CITY TO ENTER INTO A COST REIMBURSEMENT AGREEMENT NO. 2018-DT-BLA-205 WITH THE STATE OF NEW JERSEY, DEPARTMENT OF TRANSPORTATION, DIVISION OF LOCAL AID AND ECONOMIC DEVELOPMENT FOR THE DR. MARTIN LUTHER KING DRIVE, SEC. 2 INTERSECTION IMPROVEMENTS PROVIDED FOR THROUGH THE U.S. DEPARTMENT OF TRANSPORTATION**

**COUNCIL AS A WHOLE  
FOLLOWING RESOLUTION:**

**OFFERED AND MOVED ADOPTION THE**

**WHEREAS**, the City of Jersey City (City), Department of Administration, Division of Engineering, Traffic and Transportation submitted an application to the North Jersey Transportation Planning Authority (NJTPA) for federal funding under the FY2015-2016 Local Safety Program for a project known as Dr. Martin Luther King Drive, Sec. 2 Intersection Improvements, Jersey City Project No: 15-002-T, Federal Aid Project No: HSP-0609 (357) CON was authorized and found eligible for federal cost reimbursement in the amount not to exceed \$625,173.00; and

**WHEREAS**, the New Jersey Department of Transportation (NJDOT) received federal authorization on August 6, 2018 allowing the City to move forward with the public bid and implementing the Dr. Martin Luther King Drive, Sec. 2 Intersection Improvements, Jersey City Project No: 15-002-T, Federal Aid Project No: HSP-0609 (357) CON; and

**WHEREAS**, under the terms and conditions of the federal aid agreement the City must execute the **Cost Reimbursement Agreement No. 2018-DT-BLA-205** in which all such work shall be completed by September 30, 2021 unless the Cost Reimbursement Agreement is terminated or extended by written authorization of the State; and

**WHEREAS**, the City prepared plans, specifications and designated a resident engineer to monitor and inspect all work performed by the contractor awarded the construction contract, in addition to controlling the approved budget, administering payment vouchers and submitting compliance/progress reports regarding such transactions to NJDOT for allowable cost reimbursement not to exceed \$625,173.00; and

**WHEREAS**, the City agrees to accept responsibility for maintenance of the project after construction is completed.

**NOW, THEREFORE, BE IT RESOLVED**, by the Municipal Council of the City of Jersey City that the Mayor or Business Administrator and City Clerk are authorized to execute the **Cost Reimbursement Agreement No. 2018-DT-BLA-205**, which is attached hereto, for the Dr. Martin Luther King Drive, Sec. 2 Intersection Improvements, Jersey City Project No: 15-002-T, Federal Aid Project No: HSP-0609 (357) CON and their signatures constitute acceptance of the terms and conditions of the federal grant agreement; and

*jmck  
10/26/18*

**BE IT FURTHER RESOLVED**, that the Mayor or Business Administrator are hereby authorized to accept federal aid on behalf of the City of Jersey City from the New Jersey Department of Transportation for the Dr. Martin Luther King Drive, Sec. 2 Intersection Improvements, Jersey City Project No: 15-002-T, Federal Aid Project No: HSP-0609 (357) CON.

APPROVED: [Signature]

APPROVED AS TO LEGAL FORM

APPROVED: [Signature]  
Business Administrator

[Signature]  
Corporation Counsel

Certification Required

Not Required

APPROVED 8-0

RECORD OF COUNCIL VOTE ON FINAL PASSAGE 11.7.18											
COUNCILPERSON	AYE	NAY	N.V.	COUNCILPERSON	AYE	NAY	N.V.	COUNCILPERSON	AYE	NAY	N.V.
RIDLEY	✓			YUN	✓			RIVERA	✓		
PRINZ-AREY	✓			SOLOMON	✓			WATTERMAN	ABSENT		
BOGGIANO	✓			ROBINSON	✓			LAVARRO, PRES.	✓		

✓ Indicates Vote

N.V.-Not Voting (Abstain)

Adopted at a meeting of the Municipal Council of the City of Jersey City N.J.

[Signature]  
Rolando R. Lavarro, Jr., President of Council

[Signature]  
Robert Byrne, City Clerk

**RESOLUTION FACT SHEET – NON-CONTRACTUAL**

This summary sheet is to be attached to the front of any resolution that is submitted for Council consideration. Incomplete or vague fact sheets will be returned with the resolution.

**Full Title of Ordinance/Resolution**

**RESOLUTION AUTHORIZING THE CITY OF JERSEY CITY TO ENTER INTO A COST REIMBURSEMENT AGREEMENT NO. 2018-DT-BLA-205 WITH THE STATE OF NEW JERSEY, DEPARTMENT OF TRANSPORTATION, DIVISION OF LOCAL AID AND ECONOMIC DEVELOPMENT FOR THE DR. MARTIN LUTHER KING DRIVE, SEC. 2 INTERSECTION IMPROVEMENTS PROVIDED FOR THROUGH THE U.S. DEPARTMENT OF TRANSPORTATION**

**Initiator**

Department/Division	Administration	Engineering, Traffic & Transportation
Name/Title	Jose R. Cunha, P.E., C.M.E.	Municipal Engineer
Phone/email	201-547-4411	Cunha@jcnj.org

Note: Initiator must be available by phone during agenda meeting (Wednesday prior to council meeting @ 4:00 p.m.)

**Resolution Purpose**

Authorizing the City to enter into a cost reimbursement agreement with the New Jersey Department of Transportation for federal aid funds on the Dr. Martin Luther King Drive, Sec 2 Intersection Improvements

**I certify that all the facts presented herein are accurate.**

  
\_\_\_\_\_  
Jose R. Cunha, P.E., C.M.E.,  
Director of Engineering

10/24/18  
Date

  
\_\_\_\_\_  
Brian D. Platt  
Business Administrator

10/31/18  
Date



STEVEN M. FULOP  
MAYOR OF JERSEY CITY

CITY OF JERSEY CITY  
DEPARTMENT OF ADMINISTRATION  
DIVISION OF ENGINEERING, TRAFFIC & TRANSPORTATION  
MUNICIPAL SERVICES COMPLEX | 13-15 LINDEN AVE EAST | JERSEY CITY, NJ 07305  
P: 201 547 4470 | F: 201 369 7292



BRIAN D. PLATT  
BUSINESS ADMINISTRATOR

MEMORANDUM

DATE : October 23, 2018

TO : Rolando R. Lavarro, Council President and  
Members of the Municipal Council

FROM :  Jose R. Cunha, P.E., C.M.E., C.P.W.M., C.R.P.  
Director of Engineering

SUBJECT : **Resolution to Enter into a Federal Aid Cost  
Reimbursement Agreement 2018-DT-BLA-205 with  
The New Jersey Department of Transportation**

The purpose of this resolution is to authorize the City to enter into a Federal Aid Agreement with the State of New Jersey Department of Transportation (NJDOT) for the Dr. Martin Luther King, Section 2 Intersection Improvements, Jersey City Project No: 15-002-T.

The Cost Reimbursement Agreement No: 2018-DT-BLA-205 upon execution by the state and municipality will provide for eligible costs incurred by the City and not to exceed **\$625,173.00** on the above named project and must be completed by September 30, 2021.

Upon execution of this agreement, the City must return four (4) originally signed and sealed copies of the attached agreement along with the signed/sealed resolution for execution by the state.

In the best interest of the City, the Division of Engineering would greatly appreciate your authorization to move forward in accepting the terms and conditions of the federal aid agreement and funding of the Dr. Martin Luther King, Section 2 Intersection Improvement project.

Please contact my office at 201-547-4411 should you have any questions or need additional information.

CC: Robert Byrne, City Clerk  
Brian D. Platt, Business Administrator  
Donna Mauer, Chief Financial Officer  
Andrew Vischio, Director of Traffic and Transportation  
Dawn Odom, Supervising Administrative Analyst

Agreement No.: 2018-DT-BLA-205

Contract ID: 19 70929

CFDA Name and No.: Highway Planning and Construction 20.205

DUNS Number (Sponsor): 831438275

Contact Name and Phone Number: Nabil Ayoub; (973) 877-1500

## FEDERAL AID AGREEMENT

Project: Dr. Martin Luther King Drive

Municipality: City of Jersey City

County: Hudson

Federal Project No.: HSP-0609(357)

This Cost Reimbursement Agreement is made as of the \_\_\_\_\_ day of \_\_\_\_\_, by and between the City of Jersey City, having its offices at 280 Grove Street, Jersey City NJ 07302 ("Recipient") and the State of New Jersey, Department of Transportation, Division of Local Aid and Economic Development, having its offices at 1035 Parkway Avenue, Trenton, NJ 08625 ("State");

WITNESSETH:

WHEREAS, Recipient proposes to be the sponsor of a Project eligible for funding pursuant to the terms and conditions of this Agreement; and

WHEREAS, the Project may be included in the Metropolitan Planning Organization's Transportation Improvement Program and the State Transportation Improvement Program; and

WHEREAS, the State may award Recipient funds to finance the Project ("Project Fund"); and

WHEREAS, Recipient and the State desire to specify the conditions applicable to the financing of the costs of the Project out of the Project Fund and the obligations of Recipient and the State with respect to the Project; and

NOW, THEREFORE, for and in consideration of the mutual covenants contained herein, and pursuant to all federal, state, and local laws and ordinances, Recipient and the State hereby agree as follows:

1. Description of Project – Scope of Work

A detailed Project description is included in the Project Scope of Work and Cost Estimate attached to this Agreement.

2. Agreement Contract Term

2.1. This Agreement shall be effective upon proper execution by the State and the Recipient and shall continue in effect until the project is completed and all vouchers have been paid subject to Section 7 below. Allowable costs incurred for the performance of work in the attached Scope of Work in this Cost Reimbursement Agreement shall be eligible for reimbursement from the effective date of **this agreement (date written above)**. All such work shall be completed by September 30, 2021, unless either terminated or extended by written authorization of the State.

2.2. This Agreement may be terminated by either party upon thirty (30) days written notice to the other party in which case compensation shall be made for the costs of the work actually performed, subject to FHWA and or FTA concurrence. Costs incurred by the Recipient as a result of a termination by the State may be included in the Recipient's claim for compensation. Costs incurred by the State as a result of a termination by the Recipient may be set off against the Recipient's claim for compensation under the terms of this Agreement or any other Agreement between the State and Recipient until the costs have been fully repaid.

2.3 The Project shall not be sold, assigned or ownership transferred without the consent of the State and FHWA. In the event the Project is sold to a non-public entity for a non-public use or any use inconsistent with the terms of this Agreement, compensation according to termination of this Agreement by the Recipient shall be in effect.

3. Plans and Specifications

3.1 Recipient shall prepare, or have prepared, environmental documents, engineering documents, plans, specifications and estimates for the Project and shall submit them to the State for the State's review. A Professional Engineer licensed to practice in New Jersey must prepare the plans and specifications. The State shall review the engineering documents, plans and specifications for conformance to program requirements and design standards. All design work shall conform to the applicable American Association of State Highway and Transportation Officials (AASHTO) design criteria, the current Manual on Uniform Traffic Control Devices (MUTCD), and the New Jersey Department of Transportation Bicycle Compatible Roadway and Bikeways Planning and Design Guideline. However, the design of traffic barriers and drainage systems shall conform to the New Jersey Department of Transportation Roadway Design Manual. All workmanship and materials shall conform to the current New Jersey Department of Transportation Standard Specification for Road and Bridge Construction as amended for Federal Aid. The Recipient shall notify the State in writing of any deviation from the standards. If there is a deviation from the standards, the Recipient shall accept any and all responsibility for any injury and damage by such deviation to any person or property and shall indemnify the State as outlined in the Agreement. If the design cannot conform to the minimum standards as set forth, a design exception will be required. The State shall notify Recipient when the project is acceptable for bidding.

3.2 Project limits cannot be exceeded, plans and specifications altered, construction change orders issued, or items added or deleted from Project without prior written approval of the State.

3.3 The Recipient shall designate a resident engineer who shall be empowered to represent the Recipient in connection with the administration of the Project, and shall be responsible for the monitoring and inspection of all work performed by its contractors.

4. Project Work

4.1 Recipient shall use its best efforts to complete or cause the completion of work on the Project ("Project Work") in accordance with the plans and specifications approved by the State.

4.2 Recipient covenants that Project Work will comply with all applicable laws and other requirements of federal, state and local governmental bodies. Recipient shall obtain all permits and licenses necessary to Project Work.

4.3 The Recipient shall not proceed with any Project work for which reimbursement shall be sought without the specific written authorization of the State. It is agreed that any and all project costs incurred by the Recipient prior to FHWA authorization of any Project phase shall be non-participating by the State and FHWA.

4.4 Recipient shall solicit bids for the work in accordance with all federal and state laws, rules and regulations applicable to public bidding. Upon receipt of bids from responsible contractors, Recipient shall select the contractor submitting the lowest responsive bid and shall furnish the name of such contractor to the State for concurrence. Recipient agrees not to contract with any contractor to whom the State or the Federal Highway Administration ("FHWA") has made a reasonable and timely objection. Professional services should be competitively selected based upon qualifications.

4.5 Recipient agrees that the monies requisitioned from the Project Fund will be used only to reimburse actual Project costs and for no other purpose. Recipient agrees that it shall provide to the State and the FHWA such documentation as will enable the State and the FHWA to determine that the proceeds of the Project Fund have been applied solely to the costs of the Project.

4.6 Upon written request of the State, the Recipient shall cause its contractor to provide payment and performance bonds in an amount equal to 100% of the cost of the Project Work. A surety company satisfactory to the State and qualified to do business in the State of New Jersey shall execute such bonds. Copies of all bonds shall be delivered to the State upon request. Only those sureties listed in the US Treasury Department Circular 570 and authorized to do business in the State shall furnish the surety bonds.

4.7 When Recipient considers the Project to be finally complete, Recipient shall request that the State's representative make a final inspection of the Project. If it is determined, after such inspection, that the Project has been completed in accordance with the plans and specifications, Recipient shall prepare and submit to the State a certification that the final inspection has been made and the cost of the Project has actually been incurred in accordance with the provisions of the Agreement. Upon receipt, the State shall disburse an amount equal to the approved final payment. Upon payment of the amount approved for final payment, the State shall be released from any further responsibility in connection with the Project Fund and the Project. The New Jersey Department of Transportation, Division of Local Aid and Economic Development will monitor maintenance of completed Project by the Recipient. Failure to maintain Project will result in the withholding of funds payable to the Recipient on other State funded programs.

5. Insurance

5.1 Recipient shall maintain or cause to be maintained:

- (a) General Comprehensive Liability Insurance in the minimum amount of \$1,000,000 combined single limit plus \$1,000,000 in an umbrella policy. This insurance shall specifically provide for coverage of the State as an additional insured and shall provide for coverage at least as broad as the standard, basic unamended commercial general liability policy and shall be endorsed to include broad form contractual liability coverage, independent contractor's coverage and completed operations coverage.
- (b) Automobile Liability Insurance in the minimum amount of \$1,000,000.
- (c) Workers Compensation Insurance in the amount required by law.

5.2 A copy of each insurance policy shall be made available to the State upon request.

5.3 The RECIPIENT shall cause to be maintained Errors and Omissions, Professional Liability Insurance and/or Professional Malpractice Insurance sufficient to protect against liabilities arising out of professional obligations performed pursuant to the requirements of this Agreement. This insurance shall be in the minimum amount of \$1,000,000.00.

5.4 Recipient expressly understands and agrees that any insurance protection required by this Agreement shall in no way limit the obligations assumed by Recipient pursuant to this Agreement and shall not be construed to relieve Recipient of liability in excess of such coverage, nor shall it preclude the State from taking such other actions as are available to it under any other provision of this Agreement or otherwise in law.

6. Disbursement of Project Fund

6.1 (a) The State shall disburse monies from the Project Fund to Recipient in order to reimburse costs associated with Project Work in accordance with the terms and conditions of this Agreement. Only those costs specifically enumerated in the Project Scope of Work and Cost Estimate attached to this Agreement and outlined below will be eligible for reimbursement. Nothing contained herein shall impose upon the State any obligation to ensure the proper application of the monies paid to Recipient from the Project Fund. Furthermore, nothing contained herein shall impose any obligation upon the State to pay to Recipient any monies in excess of the Project Fund. The Recipient shall reimburse the Consultant/Contractor for allowable expenses after the receipt of properly prepared payment vouchers.

6.1 (b) The total cost of the project by the Recipient for completion of the Project Scope of Work in this Agreement shall not exceed **\$625,173.00**, with an approved budget as follows:

<u>Federal Project #</u>	<u>Project Sponsor</u>	<u>Contract</u>	<u>Sponsor In-House</u>	<u>Total</u>	<u>Date Authorized</u>	<u>Date for Completion</u>
HSP-0609(357)	City of Jersey City	\$625,173.00	\$0.00	\$625,173.00	this agreement (date written above)	<u>09/30/2021</u>

6.2 (a) Recipient shall prepare and submit payment vouchers for payment for approval by the State. Payment vouchers may be submitted as frequently as every month at most but are required at least quarterly. The payment vouchers for payment shall state, with proper documentation, the amounts due Recipient for actual allowable costs incurred in connection with the Project. The Recipient shall maintain a complete set of time sheets, records and accounts to identify eligible salaries, fringe benefits, leave, and non-salary direct expenses incurred in support of the Project, as well as material records, certifications, and as-built quantities.

(b) Progress Reports will accompany all vouchers for payment and shall include:

- A narrative description of work performed during the calendar month and any difficulties or delays encountered;
- A comparison of actual accomplishments to the goals established for the period;
- A comparison, by tasks, of costs incurred with amounts budgeted, and;
- A comparison, by task, of work performed compared to the schedule, including a percentage of the total work completed. This requirement can be met by including a bar chart showing schedule timing and actual progress.
- Copies of federal contract compliance documents as completed for the voucher payment period by the resident engineer that is designated by the Recipient, a complete set of which shall be furnished by State staff at kickoff and or preconstruction meetings.

(c) The State shall review and verify such payment vouchers for payment and remunerate the Recipient for direct and indirect costs incurred up to a maximum Project approved budget of **\$625,173.00** stated in this Agreement for satisfactorily completing the Project.

(d) "Actual allowable costs" and "direct and indirect costs" will be determined by the STATE based on the federal regulations applicable to the RECIPIENT:

- Cost principles for State & Local Governments – OMB Circular A-87
- Cost Principles for Nonprofit Organizations - OMB Circular A-122
- Commercial Entities - FAR Subpart 31.2

(e) The administrative requirements include:

- Grants and Cooperative Agreements with State & Local Governments - OMB Circular A-102
- Uniform Administrative Requirements for Grants and Other Agreements with Institutions of Higher Education, Hospitals and Other Non-profit Organizations - OMB Circular A-110

6.3 (a) The State shall make partial payments to the Recipient toward the Fixed Price of each Project work assignment upon the receipt of properly drawn monthly or quarterly payment vouchers for a percentage of work completed on the Project during the period as shown on the accompanying progress report. Where there is a disagreement between the State and the Recipient concerning the percentage of work completed during any given period that dispute shall be resolved in accordance with Paragraph 20.3 of this Agreement.

(b) The Sponsor may submit vouchers for reimbursement totaling up to 90% of the lesser of either the authorized amount or the amount eligible for State funding participation. The Sponsor shall submit a final payment voucher, along with any necessary close out documents, for reimbursement of the remaining 10%, following receipt of written final acceptance of the project by the Department of Transportation.

6.4 (a) All work performed by contractors and subcontractors on the Project shall be treated as being performed by the Recipient. The Recipient shall remain responsible for satisfactory performance of all work.

(b) The Recipient will be paid a Fixed Price for the work of each contractor and consultant. The Fixed Price shall be considered full compensation for all costs incurred by the Recipient relative to the work performed by each contractor and consultant. Payment of the Fixed Price shall be made on monthly or quarterly payment vouchers submitted by the Recipient based upon the percentage of the contracted work completed as shown in the Recipient's monthly progress reports.

(c) Recipient shall require its contractors and consultants to comply with the applicable cost principles set forth in Section 6.2 above and the requirements of Section 8 below by placing equivalent provisions in their contracts.

## 7. Audit Requirements

7.1 The Recipient shall provide the State with a fiscal year, organization-wide audit that has been conducted in accordance with the requirements of OMB Circular Letter A-133, Audits of States, Local Governments, and Non-Profit Organizations, and State Circular Letter 04-04-OMB, Single Audit Policy for Recipients of Federal Grants, State Grants and State Aid. If the Recipient is to contract with a commercial organization they must follow 48 CFR Part 31, Subpart 31.2, "Contracts with Commercial Organizations." The Recipient shall ensure that the State receives the audit within the prescribed submission period and that this Agreement is listed on the appropriate Schedule of Financial Assistance.

7.2 The State, and the FHWA, or their agents, shall be entitled to perform an audit at the following times:

(a) At any time during the performance of work set forth in this Agreement.

(b) During a period of up to three (3) years after either the date of payment of the applicable Final Invoice or a date mutually agreed to by the parties.

7.3 This agreement may be funded in whole or in part with funding provided under the American Recovery and Reinvestment Act of 2009 (ARRA). The Recipient is responsible for complying with the applicable provisions of the ARRA which are incorporated herein by reference.

Section 902 of ARRA requires that the U.S. Comptroller General has the authority to:

1. Examine records of the Recipient or its subconsultant, or State or local government agency administering such contract that directly pertain to, and involve transactions relating to, the Contract or subcontract.
2. Interview officers or employees of the Recipient or its subconsultant, or of State or local government agency administering the Contract, regarding such transactions.



Nothing in this section is to be interpreted to limit or restrict the existing authority of the U.S. Comptroller General.

Section 1515(a) of the ARRA requires that the Inspector General has the authority to:

1. Examine records of the Recipient or its subconsultants
2. Interview the Recipient's or its subconsultants's employees or officers working on this Contract.

Nothing in this section is to be interpreted to limit or restrict the existing authority of the Inspector General

7.4 The Recipient acknowledges that changes in payment due the Recipient resulting from audits performed by the State shall be made as follows:

- In the event of overpayment by the State, the Recipient shall refund the amount of such overpayment within thirty days of the request by the State. In the event the Recipient fails to comply with said request, the State is hereby authorized to deduct such overpayment from other monies due the Recipient under the terms of this Agreement or any other agreement between the State and the Recipient. Furthermore, the Recipient expressly understands and agrees that the provisions of this section shall in no way be construed to relieve the Recipient from any liability, or preclude the State from taking any other actions as are available to it under any other provisions of this Agreement or otherwise at law. The terms of this section shall survive the expiration or termination of the Agreement.
- In the event of underpayment by the State, the State shall pay sufficient funds to the Recipient to correct the underpayment as soon is practicable.

(a) The Recipient shall include in the Final Invoice the following release clause:

(b) "In consideration of the requested payment of this Final Invoice, the (Recipient) hereby releases the State of New Jersey and the New Jersey Department of Transportation, their agents, officers and employees, from all claims and liabilities arising from work done or services performed under this Agreement"

(c) Payment to the Recipient for a Final Invoice does not waive either the right of the State to establish adjustments and to collect overpayments that are disclosed by audits performed subsequent to payment of the Final Invoice, or the right of the Recipient to underpayments based upon adjustments disclosed by said audits.

## 8. Inspections

Recipient shall permit the State and FHWA, or any authorized representative of either of them, free access to the Project with the right to examine, visit and inspect, at any reasonable time, all work completed or in progress, labor performed and materials furnished in connection with the Project as well as Recipient's accounts, books and records, including its receipts, disbursements, contracts and any other matters relating thereto. Recipient shall supply such reports and information as the State or FHWA shall reasonably request. All accounts, books, records and other documents related to the Project shall be retained by Recipient for a period of three years after final payment is received from the State.

## 9. Indemnification

Recipient shall indemnify, defend, protect and hold harmless the State of New Jersey and its agents, servants and employees from and against any and all liability, fines, suits, claims, demands and actions, costs and reasonable expenses of any kind or nature or by anyone whomsoever, including, but not limited to, claims for personal injury, wrongful death, property damage and contractual liability due to or arising in any way out of the performance of any services, actions or operations in connection with the Project or any breach of this Agreement unless caused solely by

the gross negligence or default of the State or its agents, servants or employees; provided, however, that the State shall give Recipient prompt notice thereof. If Recipient shall be required to defend in any action or proceeding pursuant to this Section 6 to which action or proceeding the State is made a party, the State shall be entitled to participate in the matter, at its election and sole cost; provided, however, that any such action by the State does not limit or make void any liability of Recipient in respect to the claim or matter in question.

10. Abandonment of Project

It is understood and agreed by and between the parties hereto that Recipient shall complete the Project to provide a safe and usable unit and shall not be entitled to abandon the Project. If the Recipient abandons the project during any phase (planning, design, construction, etc.) all funds expended by the State and the FHWA, will be reimbursed by the Recipient to said parties.

11. No Personal Liability

Notwithstanding anything to the contrary contained herein, the parties hereto specifically understand and agree that there shall be no personal liability imposed on the officers, employees or agents of Recipient or the State with respect to any of the covenants or conditions of this Agreement.

12. Equal Opportunity

12.1 Recipient hereby agrees that it will incorporate or cause to be incorporated into any contract for construction work, or modification thereof, as defined in the rules and regulations of the United States Secretary of Labor at 41 CFR Chapter 60, which is paid for in whole or in part, directly or indirectly, with proceeds from the Project Fund the following equal opportunity clause:

During the performance of this contract, the contractor agrees as follows:

- (a) The contractor or subcontractor, where applicable will not discriminate against any employee or applicant for employment because of age, race, creed, color, national origin, ancestry, marital status or sex. The contractor will take affirmative action to ensure that such applicants are recruited and employed, and that employees are treated during employment, without regard to their age, race, creed, color, national origin, ancestry, marital status or sex. Such action shall include, but not be limited to the following: employment, upgrading, demotion, or transfer recruitment or recruitment advertising; layoff or termination; rates of pay or other forms of compensation; and selection for training, including apprenticeship. The contractor agrees to post in conspicuous places, available to employees and applicants for employment, notices to be provided by the Public Agency Equal Employment Opportunity Officer setting forth provisions of this non-discrimination clause;
- (b) The contractor or subcontractor, where applicable will, in all solicitations or advertisements for employees placed by or on behalf of the contractor, state that all qualified applicants will receive consideration for employment without regard to age, race, creed, color, national origin, ancestry, marital status or sex;
- (c) The contractor or subcontractor, where applicable, will send to each labor union or representative of workers with which it has a collective bargaining agreement or other contract or understanding, a notice, to be provided by the Public Agency Equal Employment Opportunity Officer advising the labor union or workers' representative of the contractor's commitments under this act and shall post copies of the notice in conspicuous places available to employees and applicants for employment.
- (d) The contractor or subcontractor, where applicable, agrees to comply with any regulations promulgated by the Treasurer pursuant to P.L. 1975, c. 127, as amended and supplemented from time to time.
- (e) The contractor or subcontractor agrees to attempt in good faith to employ minority and female workers consistent with applicable City employment goals prescribed by section 5.2 of the Regulations promulgated by the Treasurer pursuant to P.L. 1975, c. 127, as amended and supplemented from time to time.
- (f) The contractor or subcontractor agrees to inform in writing all recruitment agencies, including employment agencies, placement bureaus, colleges, universities labor unions, that it does not discriminate on the basis of age, creed, color, national origin, ancestry, marital status or sex, and that it will discontinue the use of any recruitment agency which engages in direct or indirect discriminatory practices.
- (g) The contractor or subcontractor agrees to revise any of its testing procedures, if necessary, to assure that all personnel testing conforms with the principles of job-related testing, as established by the statutes and court decisions of the State of New Jersey and as established by applicable federal law and applicable federal court decisions.
- (h) The contractor or subcontractor agrees to review all procedures relating to transfer, upgrading, downgrading and layoff to ensure that all such actions are taken without regard to age, creed, color, national origin, ancestry, marital status of sex, and conform with the applicable employment goals, consistent with the statutes and court decisions of the State of New Jersey, and applicable federal court decisions.

Provisions (d), (e), (f), (g), or (h) do not apply to subcontractors with four (4) or fewer employees or a contractor who has presented evidence of a federally approved or sanctioned Affirmative Action Program.

12.2 Recipient agrees that it will be bound by the above equal opportunity clause with respect to its own employment practices when it participates in federally assisted construction work.

12.3 Recipient also agrees:

- (a) To assist and cooperate actively with the FHWA and the United States Secretary of Labor in obtaining the compliance of contractors and subcontractors with the equal opportunity clause and the rules, regulations, and relevant orders of the United States Secretary of Labor.
- (b) To furnish the FHWA and the United States Secretary of Labor such information as they may require for the supervision of such compliance, and that it will otherwise assist the FHWA in the discharge of its primary responsibility for securing compliance.
- (c) To refrain from entering into any contract or contract modification subject to Executive Order 11246 of September 24, 1965, with a contractor debarred from, or who has not demonstrated eligibility for, government contracts and federally assisted construction contracts pursuant to the Executive Order.
- (d) To carry out such sanctions and penalties for violation of the equal opportunity clause as may be imposed upon contractors and subcontractors by the FHWA or the Secretary of Labor pursuant to Part II, Subpart D of the Executive Order.

12.4 In addition, Recipient agrees that if it fails or refuses to comply with these undertakings, the State may take any or all of the following actions:

- (a) Cancel, terminate, or suspend this Agreement in whole or in part;
- (b) Refrain from extending any further assistance to Recipient under the program with respect to which the failure or refusal occurred until satisfactory assurance of future compliance has been received from Recipient; and
- (c) Initiate appropriate legal proceedings.

13. Nondiscrimination

Recipient hereby agrees that it will comply with Title VI of the 1964 Civil Rights Act (the "Act") and related statutes and implementing regulations to the end that no person shall on the grounds of race, color, national origin, handicap, age, sex, or religion be excluded from participation in, be denied the benefits of, or be otherwise subjected to discrimination under the Project covered by this Agreement and, further Recipient agrees that:

- (a) It will insert the nondiscrimination notice required by the Standard Department of Transportation Title VI Assurance (DOT Order 1050.2) in all solicitations for bids for work or material, and, in adapted form, in all proposals for negotiated agreements.
- (b) It will insert the clauses in Appendixes A, B or C of DOT Order 1050.2 as appropriate, in all contracts, deeds transferring real property, structures, or improvements thereon or interest therein (as a covenant running with the land) and in future deeds, leases, permits, licenses, and similar agreements, related to this Project, entered into by Recipient with other parties.
- (c) It will comply with, and cooperate with, FHWA in ensuring compliance with the terms of the standard Title VI Assurance, the act and related statutes, and implementing regulations.

14. Disadvantaged Business Enterprises

Recipient hereby agrees to the following statements and agrees that these statements shall be included in all subsequent agreements between Recipient and any contractor:

- (a) "Policy. It is the policy of the United States Department of Transportation that emerging small business enterprises (ESBE's), as they are defined in 49 CFR Part 26 shall have the maximum opportunity to

participate in the performance of contracts financed in whole or in part with Federal funds under this agreement. NJDOT's ESBE program runs concurrently with the Disadvantaged Business Enterprise (DBE) program for small and disadvantaged businesses on federally-funded projects. Consequently, all applicable requirements of 49 CFR Part 26 shall apply to this agreement.

(b) **Obligation.** The contractor agrees to ensure that ESBE's, as defined in 49 CFR Part 26, have the maximum opportunity to participate in the performance of contracts and subcontracts financed in whole or in part with Federal funds provided under this agreement. In this regard, all recipients or contractors shall take all necessary and reasonable steps in accordance with the applicable section of 49 CFR Part 26 to ensure that ESBE's have the maximum opportunity to compete for and perform contracts. Recipients and their contractors shall not discriminate on the basis of race, color, national origin, handicap, religion, age, or sex, as provided in Federal and state law, in the award and performance of DOT-assisted contracts."

15. No Oral Modifications

(1) This agreement may not be changed orally, but only by an agreement in writing and signed by the party against whom enforcement of any waiver, change, modification or discharge is sought.

(2) The Recipient shall request approval by the State of any task or line item budget revision deemed necessary to carry out the project in this Agreement. This request shall be submitted in writing by the Recipient to the State. If approved by the State and the applicable Federal funding agency, the State shall provide written authorization to Recipient to proceed with the revision.

16. Notices and Demands

16.1 All notices, demands, requests or other communications required or permitted to be given pursuant to this Agreement must be in writing.

16.2 All notices, demands, requests or other communications required or permitted to be given pursuant to this Agreement shall be deemed to have been properly given or served by depositing the same in the United States mail, postpaid and registered or certified, return receipt requested, or by Federal Express or similar service providing receipt against delivery, as follows:

If to the State:

Laine Rankin  
Director  
Division of Local Aid and Economic Development  
State of New Jersey Department of Transportation  
1035 Parkway Avenue  
Trenton, New Jersey 08625

Or the designated District Office, Bureau of Local Aid, serving the area of the Recipient:

**District 2**  
153 Halsey Street - 5th floor  
Newark, NJ 07102  
Phone: (973) 877-1500  
Fax: (973) 648-4547  
Bergen, Essex, Hudson,  
and Union

Excepting Legal Notices  
Telephone:

Fax:

If to Recipient:

**Jose R. Cunha, P.E.**  
*(Engineer)*  
**City of Jersey City**  
**280 Grove Street**  
**Jersey City, NJ 07302**

17. Partial Invalidity

To the extent that the intent and underlying purpose of this Agreement are not compromised, the invalidity or unenforceability of any term, covenant, condition or provision of this Agreement, or its application to any persons, entities or circumstances shall not render invalid or unenforceable the remainder of this Agreement, or the application of such term, covenant, condition or provision to persons, entities or circumstances other than those as to which it is held invalid or unenforceable, and each term, covenant, condition and provision of this Agreement shall remain valid and enforceable to the fullest extent permitted by applicable law.

18. Further Assurances

The parties agree to cooperate with each other and to execute and deliver such further documents and assurances as may be necessary to carry out the purpose of this Agreement.

19. Subject to FHWA Regulations

(1) Notwithstanding anything contained herein to the contrary, so long as the Project is being financed out of proceeds from the Project Fund, this Agreement and the obligations of the parties hereunder are subject to the rules and regulations promulgated by the FHWA.

(2) Section 319 of the FY 1990 Department of the Interior and Related Agencies Appropriations Act, Public Law 101-121, contains a prohibition on the use of appropriated funds for "influencing or attempting to influence" Federal officials in connection with grants, contracts or cooperative agreements. The new law became effective December 23, 1989 and contains two specific requirements that prospective FTD or FHWA contractors must be aware of and comply with prior to execution of this Agreement in order to remain eligible for Federal funds.

20. Entire Agreement; Counterparts; Disputes

20.1 This Agreement contains the entire agreement between the parties hereto and supersedes any and all prior understandings and agreements, oral or written, between the parties respecting the subject matter hereof.

20.2 This Agreement may be executed in two or more counterparts, each of which shall be deemed a duplicate original and all of which together shall constitute one and the same Agreement.

20.3 In the event a dispute arises concerning the meaning of any term used in this Agreement, or the work and services required to be performed under this Agreement, or as to compensation under this Agreement, the dispute shall be decided by the Commissioner of Transportation or his duly authorized representative.

21. APPENDIX A - Regulations of the Department of Transportation relative to nondiscrimination in federally assisted Projects of the Department of Transportation (Title 49, Code of Federal Regulations, Part 21) attached hereto are made a part of this Agreement.

22. APPENDIX B - Certification of Restrictions on Lobbying is attached hereto and made part of this Agreement in accordance with 31 U.S.C. Sec. 1352 and 40 CFR Part 20. Each Recipient, Consultant and Contractor awarded a contract exceeding \$100,000 shall submit to the State a Disclosure of Lobbying Activity Form-LLL at the end of each calendar quarter in which a reportable event occurs. All completed forms shall be sent to:

New Jersey Department of Transportation  
Manager Professional Services  
Procurement Division  
1035 Parkway Avenue  
Trenton, New Jersey 08625

23. APPENDIX C - Certification of Recipient is attached hereto and made a part of this Agreement.
24. APPENDIX D - Certification of New Jersey Department of Transportation is attached hereto and made a part of this Agreement.
25. APPENDIX E - NJDOT Code of Ethics for Vendors is attached hereto and made a part of this Agreement.
26. APPENDIX F - Certification of Recipient Eligibility is attached hereto and made a part of this Agreement.
27. APPENDIX G - Americans with Disabilities Act is attached hereto and made part of this agreement.
28. APPENDIX H - State of New Jersey Equal Employment Opportunity for Contracts Funded by FHWA is attached hereto and made part of this agreement.
29. APPENDIX I – Project Scope of Work
30. APPENDIX J – Project Cost Estimate
31. Resolution

The Recipient shall supply the necessary resolution authorizing the Recipient to enter into this Agreement and this Agreement shall not become binding on either party until it is executed by the Commissioner of Transportation or the Commissioner's designee.

IN WITNESS WHEREOF, the parties have caused their duly authorized representatives to duly execute this Agreement on and as of the day and year first above written.

Project: **Dr. Martin Luther King Drive**

Municipality: **City of Jersey City**

County: **Hudson**

Federal Project No.: **HSP-0609(357)**

Agreement No.: **2018-DT-BLA-205**

ATTEST/WITNESSED/AFFIX SEAL:

RECIPIENT **City of Jersey City**

\_\_\_\_\_  
Date

Name: **Robert Byrne**  
Title **Clerk**

By: \_\_\_\_\_  
Date

Name **Steven M. Fulop**  
Title **Mayor**

ATTEST/WITNESSED/AFFIX SEAL:

NEW JERSEY DEPARTMENT OF TRANSPORTATION

\_\_\_\_\_  
Date

Anika James  
Department Secretary,  
New Jersey Department of Transportation

By: \_\_\_\_\_  
Date

Laine Rankin, Director,  
Division of Local Aid & Economic  
Development

THIS DOCUMENT HAS BEEN REVIEWED AND APPROVED AS TO FORM

ATTORNEY GENERAL OF NEW JERSEY

**Gurbir S. Grewal**

By: \_\_\_\_\_

Deputy Attorney General

\_\_\_\_\_  
Date



## APPENDIX A

### NONDISCRIMINATION

During the performance of this Agreement, the RECIPIENT, for itself, its assignees and successors in interest hereinafter referred to as the RECIPIENT, agrees as follows:

1. Compliance with Regulations: The RECIPIENT will comply with Regulations of the United States Department of Transportation relative to nondiscrimination in federally assisted programs of the Department of Transportation (Title 49, Code of Federal Regulations, Part 21 through Appendix H, and Title 23CFR Part 710.405(b), hereinafter referred to as the Regulations), which are incorporated herein by reference and made a part of this Agreement.
2. Nondiscrimination: The RECIPIENT, with regard to the work performed by it after award and prior to completion of the work, will not discriminate on the basis of race, color, age, sex, or national origin in the selection and retention of subcontractors, including procurement of materials and leases of equipment. The RECIPIENT will not participate either directly or indirectly in the discrimination prohibited by Section 21.5 of the Regulations, including employment practices when the Agreement covers a program set forth in Appendix B of the Regulations.
3. Solicitations for Subcontracts, including Procurement of Procurement of Materials and Equipment: In all solicitations either by competitive bidding or negotiation made by the RECIPIENT for work to be performed under a subcontract, including procurement of materials or equipment, such potential subcontractor or supplier shall be notified by the RECIPIENT of the RECIPIENT'S obligations under this Agreement and the Regulations relative to nondiscrimination on the basis of race, color, age, sex or national origin.
4. Information and Reports: The RECIPIENT will provide all information and reports required by the Requisitions, or orders and instructions issued pursuant thereto, and will permit access to its books, records, accounts, other sources of information, and its facilities as may be determined by the STATE or the Federal Highway Administration to be pertinent to ascertain compliance with such Regulations, orders and instructions. Where any information required of the RECIPIENT is in the exclusive possession of another who fails or refuses to furnish this information, the RECIPIENT shall so certify to the STATE or the Federal Highway Administration as appropriate, and shall set forth what efforts it has made to obtain the information.
5. Sanctions for Noncompliance: In the event of the RECIPIENT'S noncompliance with the nondiscrimination provisions of this contract, the STATE shall impose such sanctions as are appropriate and available under the laws of the STATE.
  - (a) Withholding of payments to the RECIPIENT under the contract until the RECIPIENT complies, and/or
  - (b) Cancellation, termination, or suspension of the contract, in whole or in part.
6. This Agreement is subject to all federal, State, and local laws, rules, and regulations, including, but not limited to, those pertaining to nondiscrimination in employment and affirmative action for equal employment opportunity.
7. The RECIPIENT agrees to ensure that Disadvantaged Business Enterprises (DBE's) as defined in 49 CFR, Part 23 and FTA Circular 4716.1A, have the maximum opportunity to participate in the performance of contracts and subcontracts financed in whole or in part with federal funds. Failure to make a good faith effort to meet the established DBE goal may result in sanctions as defined under paragraph 5 of this Appendix.
8. If at any time following the execution of this Agreement, the RECIPIENT intends to sublet any additional portion(s) of the work or intends to purchase materials or lease equipment not contemplated during the original proposal preparation, the RECIPIENT shall:
  - (a) Notify the Project initiator, in writing, of the type and approximate value of the work which the RECIPIENT intends to accomplish by such subcontract, purchase order or lease.
  - (b) Give DBE firms equal consideration with non-minority firms in negotiations for any such subcontracts, purchase orders or leases.
9. Incorporation of Provisions: The RECIPIENT will include the provisions of paragraph (1) through (9) in every subcontract, including procurement of materials and leases of equipment, unless exempt by the Regulations, orders or instructions, issued pursuant thereto.

**APPENDIX B**

**CERTIFICATION OF RESTRICTIONS ON LOBBYING**

I, Steven M. Fulop, Mayor, hereby certify on behalf of RECIPIENT, that:  
(Name and Title of Grantee Official)

- (1) No Federal appropriated funds have been paid or will be paid, by or on behalf of the undersigned, to any person for influencing or attempting to influence an officer or employee of any agency, a Member of Congress, an officer or employee of Congress, or an employee of a Member of Congress in connection with the awarding of any Federal contract, the making of any Federal grant, the making of any Federal loan, the entering into of any cooperative agreement, and the extension, continuation, renewal, amendment, or modification of any Federal contract, grant, loan, or cooperative agreement.
- (2) If any funds other than Federal appropriated funds have been paid or will be paid to any person for influencing or attempting to influence an officer or employee of any agency, a Member of Congress, an officer or employee of Congress, or an employee of a Member of Congress in connection with this Federal contract, grant, loan, or cooperative agreement, the undersigned shall complete and submit Standard Form-LLL, "Disclosure Form to Report Lobbying," in accordance with its instructions.
- (3) The undersigned shall require that the language of this certification be included in the award documents for all subawards at all tiers (including subcontracts, subgrants, and contracts under grants, loans, and cooperative agreements) and that all subRECIPIENT'S shall certify and disclose accordingly.

This certification is a material representation of fact upon which reliance is placed when this transaction was made or entered into. Submission of this certification is a prerequisite for making or entering into this transaction imposed by section 1352, title 31, U.S.Code. Any person who fails to file the required certification shall be subject to a civil penalty of not less than \$10,000 and not more than \$100,000 for each such failure.

Executed this \_\_\_\_\_ day of \_\_\_\_\_, 2\_\_\_\_\_.

By: \_\_\_\_\_

Steven M. Fulop, Mayor  
(Signature and Title of Authorized Official)

## APPENDIX C

### **CERTIFICATION OF RECIPIENT**

In executing the Agreement the RECIPIENT'S signatory certifies on behalf of the RECIPIENT that neither he, nor any other officer, agent or employee of the RECIPIENT has:

1. employed or retained for a commission, percentage, brokerage, contingent fee, or other consideration, any firm or person (other than a bonafide employee working solely for him or the RECIPIENT) to solicit or secure this Agreement.
  2. agreed, as an express or implied condition for obtaining this contract, to employ or retain the services of any firm or person in connection with carrying out the Agreement, or
  3. paid, or agreed to pay, to any firm, organization or person (other than a bonafide employee working solely for him or the RECIPIENT) any fee, contribution, donation, or consideration of any kind for, or in connection with, procuring or carrying out the Agreement;
- except as expressly Stated in a disclosure letter to the STATE which shall accompany the Agreement after execution by the RECIPIENT on submission to the Commissioner or his designee for execution.

The RECIPIENT acknowledges that this certificate furnished to the STATE and the Federal Highway Administration, U.S. Department of Transportation, in connection with this Agreement, is subject to applicable State and Federal laws, both criminal and civil.

**APPENDIX D**

**CERTIFICATION OF NEW JERSEY DEPARTMENT OF TRANSPORTATION**

In executing the Agreement the STATE'S signatory certifies that to the best of his knowledge, the RECIPIENT or its representative has not been required, directly or indirectly as an express or implied condition in connection with obtaining or carrying out this Agreement, to:

1. employ or retain, or agree to employ or retain, any firm or person, or
2. pay, or agree to pay, to any firm, person, or organization, any fee, contribution, donation, or consideration of any kind;

except as expressly Stated in a disclosure letter to the Federal Highway Administration and/or Federal Transportation Administration, U.S. Department of Transportation.

The STATE acknowledges that this certificate is to be furnished to the Federal Highway Administration, U.S. Department of Transportation, in connection with agreements involving participation of Federal-aid highway funds, and the Federal Transportation Administration, in connection with agreements involving participation of FTA Metropolitan Planning (PL) funds, and is subject to applicable State and Federal laws, both criminal and civil.

## APPENDIX E

### NJDOT CODE OF ETHICS FOR VENDORS

1. No vendor\* shall employ any NJDOT officer or employee in the business of the vendor or professional activity in which the vendor is involved with Department officer or employee.
2. No vendor shall offer or provide any interest, financial or otherwise, direct or indirect, in the business of the vendor or professional activity in which the vendor is involved with the Department officer or employee.
3. No vendor shall cause or influence or attempt to cause or influence any NJDOT employee or officer in his or her official capacity in any manner which might tend to impair the objectivity or independence of judgment of that NJDOT officer or employee.
4. No vendor shall cause or influence, or attempt to cause or influence, any NJDOT officer or employee to use or attempt to use his or her official position to secure any unwarranted privileges or advantages for that vendor or for any other person.
5. No vendor shall offer any NJDOT officer or employee any gift, favor, service or other thing of value under circumstances from which it might be reasonably inferred that such gift, service or other thing of value was given or offered for the purpose of influencing the RECIPIENT in the discharge of his or her official duties. In addition, employees or officers of NJDOT will not be permitted to accept breakfasts, lunches, dinners, alcoholic beverages, tickets to entertainment and/or sporting events or any other item which could be construed as having more than nominal value.

**NOTE:** This section would permit an NJDOT employee or officer to accept food or refreshments of relatively low monetary value provided during the course of a meeting, conference or other occasion where the employee is properly in attendance (for example - coffee, danish, tea or soda served during a conference break). Acceptance of unsolicited advertising or promotional materials of nominal value (such as inexpensive pens, pencils or calendars) would also be permitted.

Any questions as to what is or is not acceptable or what constitutes proper conduct for a Departmental employee or officer should be referred to the Department's Ethics Liaison Officer or his or her designee.

6. This code is intended to augment, not to replace existing administrative orders and the current Departmental Code of Ethics.
7. This code shall take effect immediately upon approval of the NJ Executive Commission on Ethical Standards and adoption by the NJDOT.

\*Vendor is defined as any general contractor, subcontractor, consultant, person, firm, corporation or organization engaging in or seeking to do business with NJDOT.

---

Adopted on the 16th day of December, 1987

**APPENDIX F**

**CERTIFICATION OF RECIPIENT ELIGIBILITY**

I Steven M. Fulop, Mayor hereby certify under penalty of perjury under the laws of the United States, that except as noted below, the company or any person associated therewith in the capacity of owner, partner, director, officer, principal, Project director, manager, auditor, or any position involving the administration of federal or State funds:

is not currently under suspension, debarment, voluntary exclusion, or determination of ineligibility by any federal, State or local government agency;

has not been suspended, debarred, voluntarily excluded or determined ineligible by any federal, State or local government agency within the past 3 years;

does not have a proposed debarment pending; and

has not been indicted, convicted, or had a civil judgment rendered against (it) by a court of competent jurisdiction in any matter involving fraud or official misconduct within the past 3 years.

(Insert exceptions - for any exception noted, indicate to whom it applies, initiating agency, and dates of action. Providing false information may result in criminal prosecution or administrative sanctions. If no exceptions, insert "None".)

Attest:

RECIPIENT

\_\_\_\_\_  
Robert Byrne, Clerk

\_\_\_\_\_  
Steven M. Fulop, Mayor

Date: \_\_\_\_\_

## APPENDIX G

### AMERICANS WITH DISABILITIES ACT

#### Equal Opportunity For Individuals With Disabilities.

The RECIPIENT and the STATE do hereby agree that the provisions of Title II of the Americans With Disabilities Act of 1990 (the "Act") (42 U.S.C. Sec. 12101 et seq.), which prohibits discrimination on the basis of disability by public entities in all services, programs, and activities provided or made available by public entities, and the rules and regulations promulgated pursuant thereto, are made a part of this contract. In providing any aid, benefit, or service on behalf of the STATE pursuant to this contract, the RECIPIENT agrees that the performance shall be in strict compliance with the Act. In the event that the RECIPIENT, its agents, servants, employees, or sub consultants violate or are alleged to have violated the Act during the performance of this contract, the RECIPIENT shall defend the STATE in any action or administrative proceeding commenced pursuant to this Act. The RECIPIENT shall indemnify, protect, and save harmless the STATE, its agents, servants, and employees from and against any and all suits, claims, losses, demands, or damages of whatever kind or nature arising out of or claimed to arise out of the alleged violation. The RECIPIENT shall, at its own expense, appear, defend, and pay any and all charges for legal services and any and all costs and other expenses arising from such action or administrative proceeding or incurred in connection therewith.

In any and all complaints brought pursuant to the STATE'S grievance procedure, the RECIPIENT agrees to abide by any decision of the STATE which is rendered pursuant to said grievance procedure. If any action or administrative proceeding results in an award of damages against the STATE or if the STATE incurs any expense to cure a violation of the ADA which has been brought pursuant to its grievance procedure, the RECIPIENT shall satisfy and discharge the same at its own expense.

The STATE shall, as soon as practicable after a claim has been made against it, give written notice thereof to the RECIPIENT along with full and complete particulars of the claim. If any action or administrative proceeding is brought against the STATE or any of its agents, servants, and employees, the STATE shall expeditiously forward or have forwarded to the RECIPIENT every demand, complaint, notice, summons, pleading, or other process received by the STATE or its representatives.

It is expressly agreed and understood that any approval by the STATE of the services provided by the RECIPIENT pursuant to this contract will not relieve the RECIPIENT of the obligation to comply with the Act and to defend, indemnify, protect, and save harmless the STATE pursuant to this paragraph.

It is further agreed and understood that the STATE assumes no obligation to indemnify or save harmless the RECIPIENT, its agents, servants, employees and sub consultants for any claim which may arise out of their performance of this Agreement. Furthermore, the RECIPIENT expressly understands and agrees that the provisions of this indemnification clause shall in no way limit the RECIPIENT'S obligations assumed in this Agreement, nor shall they be construed to relieve the RECIPIENT from any liability, nor preclude the STATE from taking any other actions available to it under any other provisions of this Agreement or otherwise at law.

## APPENDIX H

### **STATE OF NEW JERSEY EQUAL EMPLOYMENT OPPORTUNITY FOR CONTRACTS FUNDED BY FHWA**

The parties to this Agreement do hereby agree that the provisions of NJSA 10:2-1 through 10:2-4 and NJSA 10:5-31 et seq (PL 1975, c 127, as amended and supplemented) dealing with discrimination in employment on public contracts, and the rules and regulations promulgated pursuant thereto, are hereby made a part of this Agreement and are binding upon them.

During the performance of this Agreement, the RECIPIENT agrees as follows:

- a. The RECIPIENT, will not discriminate against any employee or applicant for employment because of age, race, creed, color, national origin, ancestry, marital status or sex. The RECIPIENT will take affirmative action to ensure that such applicants are recruited and employed, and that employees are treated during employment, without regard to their age, race, creed, color, national origin, ancestry, marital status or sex. Such action shall include but not be limited to the following: employment, upgrading, demotion, or transfer, recruitment or recruitment advertising; layoff or termination; rates of pay or other forms of compensation; and selection for training, including apprenticeship. The RECIPIENT agrees to post in conspicuous places, available to employees and applicants for employment, notices to be provided by the Department of Transportation's Compliance Officer setting forth provisions of this nondiscrimination clause;
- b. The RECIPIENT will, in all solicitations or advertisements for employees placed by or on behalf of the RECIPIENT, state that all qualified applicants will receive consideration for employment without regard to age, race, creed, color, national origin, ancestry, marital status or sex;
- c. The RECIPIENT, will send to each labor union or representative of workers with which it has a collective bargaining agreement or other contract or understanding, a notice, to be provided by the Department of Transportation's Compliance Officer, advising the labor union or worker's representative of the contractor's commitments under this act and shall post copies of the notice in conspicuous places available to employees and applicants for employment.

The notices referred to in paragraphs a and c may be obtained at the preconstruction conference.



# Resolution of the City of Jersey City, N.J.

City Clerk File No. Res. 18-984

Agenda No. 10.Y

Approved: NOV 07 2018

TITLE:



**RESOLUTION AUTHORIZING THE AWARD OF A CONTRACT TO ADAMO BROTHERS CONSTRUCTION FOR THE SGT. ANTHONY PARK - PLAYGROUND IMPROVEMENTS, PROJECT NO. 2016-037 FOR THE DEPARTMENT OF ADMINISTRATION/DIVISION OF ARCHITECTURE**

**COUNCIL  
OFFERED AND MOVED ADOPTION OF THE FOLLOWING RESOLUTION:**

WHEREAS, the City of Jersey City's (City) Purchasing Director acting within his authority and in conformity with N.J.S.A. 40A:11-1 et seq. publicly advertised bids for **Sgt. Anthony Park - Playground Improvements, Project No. 2016-037** for the Department of Administration/Division of Architecture pursuant to specifications and bids thereof; and

WHEREAS, pursuant to public advertisement the City of Jersey City (City) has received (2) Bids, the lowest responsible bid being that from **Adamo Brothers Construction, 1033 Alexander Avenue, Ridgefield, New Jersey 07657**, in the total bid amount of **Three Hundred Thirty Three Thousand, Nine Hundred Thirty (\$333,930.00) Dollars**; and

WHEREAS, the City's Purchasing Director has certified that he considers said bid to be fair and reasonable; and

WHEREAS, the total encumbrance amount of **Three Hundred Thirty Three Thousand, Nine Hundred Thirty (\$333,930.00) Dollars** is available in Capital Accounts #04-215-55-141-990, and 04-215-55-141-991; and

**Dept. of Administration/Division of Architecture**

Acct. No.	P.O. #		Amount
04-215-55-141-991	131019	Capital Acct	\$201,908.00
04-215-55-141-990	131018	Capital Acct	\$132,022.00
		<b>Total Contract</b>	<b>\$333,930.00</b>
04-215-55-100-990	131020	Capital Acct Conting.	\$50,089.50
		<b>Total Encumbrance</b>	<b>\$384,019.50</b>

WHEREAS, these funds are available for this expenditure in accordance with requirements of the Local Budget Law, N.J.S.A. 40A:4-1 et seq.

**NOW, THEREFORE, BE IT RESOLVED**, by the Municipal Council of the City of Jersey City that the said bid of the aforementioned **Adamo Brothers Construction** be accepted and that a contract be awarded to said company in the above amount, and the Director of Purchasing is directed to have such a contract drawn up and executed; and be it further

**RESOLVED**, that upon certification by an official or employee of the City authorized to receive the material pursuant to the contract, that the same has been received and that the requirements of the contract met, then; payment to the contractor shall be made in accordance with the provisions of the Local Fiscal Affairs Law, N.J.S.A. 40A:5-1 et seq.; and be it further

**RESOLVED**, this contract award shall be subject to the condition that the contractor provide satisfactory evidence of compliance with the Affirmative Action Amendments to the Law Against Discrimination, N.J.S.A. 10:5-31 et seq.; and be it further

(continued on page 2)

TITLE:

**RESOLUTION AUTHORIZING THE AWARD OF A CONTRACT TO ADAMO BROTHERS CONSTRUCTION FOR THE SGT. ANTHONY PARK - PLAYGROUND IMPROVEMENTS, PROJECT NO. 2016-037 FOR THE DEPARTMENT OF ADMINISTRATION/DIVISION OF ARCHITECTURE**

**RESOLVED**, that the Mayor or Business Administrator is hereby authorized to execute a contract on behalf of the City of Jersey City.

I, Donna Mauer, Donna Mauer, Chief Financial Officer, certify that there are sufficient funds available for payment of this above resolution in account shown below:

**Dept. of Administration/Division of Architecture**

Acct. No.	P.O. #		Amount
04-215-55-141-991	131019	Capital Acct	\$201,908.00
04-215-55-141-990	131018	Capital Acct	\$132,022.00
		<b>Total Contract</b>	<b>\$333,930.00</b>
04-215-55-100-990	131020	Capital Acct Conting.	\$50,089.50
		<b>Total Encumbrance</b>	<b>\$384,019.50</b>

Approved by Raquel Borado, PPA's  
for Peter Folgado, Director of Purchasing, QPA

PP/JMcK/pc  
10/26/18

JMcK  
10/26/18

APPROVED: \_\_\_\_\_

APPROVED AS TO LEGAL FORM

APPROVED: [Signature]  
Business Administrator

[Signature]  
Corporation Counsel

Certification Required

Not Required

APPROVED 8-0

RECORD OF COUNCIL VOTE ON FINAL PASSAGE 11.7.18											
COUNCILPERSON	AYE	NAY	N.V.	COUNCILPERSON	AYE	NAY	N.V.	COUNCILPERSON	AYE	NAY	N.V.
RIDLEY	✓			YUN	✓			RIVERA	✓		
PRINZ-AREY	✓			SOLOMON	✓			WATTERMEN	ABSENT		
BOGGIANO	✓			ROBINSON	✓			LAVARRO, PRES.	✓		

✓ Indicates Vote

N.V.-Not Voting (Abstain)

Adopted at a meeting of the Municipal Council of the City of Jersey City N.J.

[Signature]  
Rolando R. Lavarro, Jr., President of Council

[Signature]  
Robert Byrne, City Clerk

**RESOLUTION FACT SHEET - CONTRACT AWARD**

This summary sheet is to be attached to the front of any resolution that is submitted for Council consideration. Incomplete or vague fact sheets will be returned with the resolution.

**Full Title of Ordinance/Resolution**

RESOLUTION AUTHORIZING THE AWARD OF A CONTRACT TO ADAMO BROTHERS CONSTRUCTION FOR THE SGT. ANTHONY PARK – PLAYGROUND IMPROVEMENTS, PROJECT NO. 2016-037 FOR THE DEPARTMENT OF ADMINISTRATION, DIVISION OF ARCHITECTURE

**Project Manager**

Department/Division	Administration	Architecture
Name/Title	Brian F. Weller, L.L.A.	Director
Phone/email	(201) 547-5900	wellerb@cnj.org

Note: Project Manager must be available by phone during agenda meeting (Wednesday prior to council meeting @ 4:00 p.m.)

**Contract Purpose**

There exist a need to replacement the play structure and resurface the basketball court at Sgt. Anthony Park. Bids were received on October 16, 2018 at the Division of Purchasing. Two (2) Bids were received.

Adamo Brothers Construction	\$333,930.00
Picerno-Giordano Construction LLC	\$352,282.00

Various Parks	General Parks Account	
04-215-55-141-990	\$132,022.00	
04-215-55-141-991	\$201,908.00	
04-215-55-100-990	\$ 50,089.50	(15% Con.)
	\$384,019.50	

**Contract term (include all proposed renewals)**

Approximately 120 days after contract award

Type of award

If "Other Exception", enter type

**Additional Information**

The awarding resolution has been drafted by the Division of Purchasing.

I certify that all the facts presented herein are accurate.

  
Signature of Division Director

10-18-18  
Date

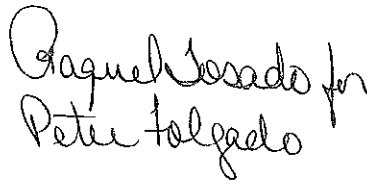
  
Peter Folgado

10-26-18



STEVEN M. FULOP  
MAYOR OF JERSEY CITY

**CITY OF JERSEY CITY  
DEPARTMENT OF ADMINISTRATION**

CITY HALL | 280 GROVE STREET | JERSEY CITY, NJ 07302  
P: 201 547 5147 | F: 201 547 4833



BRIAN D. PLATT  
BUSINESS ADMINISTRATOR

**DATE** : October 18, 2018  
**TO** : Peter Folgado, Purchasing Director  
**FROM** : Brian D. Platt, Business Administrator *kb*  
**SUBJECT** : Sgt. Anthony Park – Playground Improvements  
Project No. 2016-037  
Re: Contract Award

Please be advised, after careful and through review of the bids, I recommend that the contract be awarded to:

Adamo Brother Construction  
1033 Alexander Avenue  
Ridgefield, New Jersey 07657

Please proceed and utilize the following requisitions listed below. Kindly draft the awarding resolution for the November 7, 2018 Council Meeting.

The project is funded by Capital Parks Improvements, please encumber as follows:

<u>Purchase Requisition #</u>	<u>Account #</u>	<u>Amount</u>
R0185182	04-215-55-141-990	\$ 132,022.00
R0185598	04-215-55-141-991	\$ 201,908.00
R0185183	04-215-55-100-990	\$ <u>50,089.50</u> (15% Contingency)
		\$ 384,019.50

If you have any questions, please do not hesitate to call.

**Attachments**

c: Brian F. Weller, Director, Division of Architecture  
Raquel Tosado, Contractor Manager  
Paola Campbell, Purchasing Assistant



STEVEN M. FULOP  
MAYOR OF JERSEY CITY

CITY OF JERSEY CITY  
DEPARTMENT OF ADMINISTRATION  
DIVISION OF ARCHITECTURE  
MUNICIPAL SERVICES COMPLEX | 13-15 LINDEN AVE. EAST | JERSEY CITY, NJ 07305  
P: 201 547 5900



BRIAN D. PLATT  
BUSINESS ADMINISTRATOR

MEMORANDUM

**DATE** : October 18, 2018  
**TO** : Brian Platt, Business Administrator  
**FROM** : Brian F. Weller, L.L.A., A.S.L.A., Director *BFW*  
**SUBJECT** : Sgt. Anthony Park - Playground Improvements  
Project No. 2016-037

We have reviewed the bids received on October 16, 2018 at the Division of Purchasing at 11:00 a.m. and recommend award to the low bidder, Adamo Brothers Construction, 1033 Alexander Avenue, Ridgefield, New Jersey 07657.

Adamo Brothers Construction	\$333,930.00
Picerno-Giordano Construction, LLC	\$352,282.00

The project is funded by Capital Parks Improvements, please encumber as follows:

<u>Purchase Requisition #</u>	<u>Account #</u>	<u>Amount</u>
R0185182	04-215-55-141-990	\$132,022.00
R0185598	04-215-55-141-991	\$201,908.00
R0185183	04-215-55-100-990	<u>\$ 50,089.50</u> (15% Contingency)
		\$384,019.50

Division of Architecture formally requests that we make a recommendation to award this important project for the community.

ab  
Attachments

c: Peter Folgado, Purchasing Director  
Raquel Tosado, Contractor Manager  
Paola Campbell, Purchasing Assistant



STEVEN M. FULOP  
MAYOR OF JERSEY CITY

CITY OF JERSEY CITY  
DEPARTMENT OF ADMINISTRATION  
DIVISION OF ARCHITECTURE  
MUNICIPAL SERVICES COMPLEX | 13-15 LINDEN AVE. EAST | JERSEY CITY, NJ 07305  
P: 201 547 5900



BRIAN D. PLATT  
BUSINESS ADMINISTRATOR

MEMORANDUM

DATE : October 18, 2018

TO : Rolando R. Lavarro, Jr., Council President and Members of the Municipal Council

FROM : Brian F. Weller, L.L.A., A.S.L.A., Director *BFW*

SUBJECT : Sgt. Anthony Park - Playground Improvements  
Project No. 2016-037

Attached for your consideration is the Resolution authorizing the award of a contract to Adamo Brothers Construction for the Sgt. Anthony Park - Playground Improvements project. The work consists of the following:

1. Removal and disposal of existing site improvements, as designated on the drawings, that include but are not necessarily limited to; concrete sidewalk, curbing, play structures footings, rubber safety surfacing, fencing (remove and reinstall) as designated.
2. Earthwork.
3. Installation of new playground equipment.
4. Installation of new site furnishings.
5. Resurface and color coat basketball court.
6. Installation of new curbing and concrete flatwork surfaces as designated and specified.
7. Installation of salvaged fencing and/or gates to pre-demolition conditions or better.
8. Acquisition of all necessary permit(s) from various agencies having authority.

If you need any additional information, please do not hesitate to call.

ab

BID PROPOSAL  
Continued

TOTAL BID PRICE:

The Bidder agrees to perform and provide all labor, materials, equipment and services required to complete all work as described in the Specifications and shown on the drawings for the Lump Sum Price of:

One hundred & ninety-six thousand eight hundred & thirty dollars <sup>00</sup>/<sub>100</sub>  
(In Writing)  
\* 196,830.-  
(In Figures)

UNIT PRICE:

The Specifications and Drawings represent the Base Bid, and contain specific quantities of work based on good faith estimates. If during project construction, the quantities contained in the specifications and drawings are exceeded, payment for excess quantities shall be based on the prices set forth below:

**Item No. 1:** Unforeseen excavation and replacement with engineered fill in accordance with Section 312000 - Earth Moving

10 C.Y. @ \$ 60 Per C.Y. for a Total Cost of \$ 600.-  
(Unit Price in Figures) (Total Cost Item 1 in Figures)

10 C.Y. @ Sixty dollars  
(Write Unit Price)

Per C.Y. for a Total Cost of: Six hundred - <sup>00</sup>/<sub>100</sub>  
(Write Total Cost - Item No. 1)

**Item No. 2:** Rock removal in accordance with Section 312000 - Earth Moving. Removal shall be based on line drilling method.

5 C.Y. @ \$ 1000.- Per C.Y. for a Total Cost of \$ <sup>#</sup>5000.-  
(Unit Price in Figures) (Total Cost Item 2 in Figures)

5 C.Y. @ One thousand - <sup>00</sup>/<sub>100</sub>  
(Write Unit Price)

Per C.Y. for a Total Cost of: Five thousand - <sup>00</sup>/<sub>100</sub>  
(Write Total Cost - Item No. 2)

BID PROPOSAL  
(Continued)  
PROJECT NO. 2016-037

The Unit Price bid shall cover all costs of whatever nature, incidental to that item. In explanation but not in limitation thereof, these costs shall include the cost of all work, labor, material, equipment, transportation and all else necessary to execute the Contract, and all incidental expenses in connection therewith, including all costs on account of loss by damage or destruction encountered for settlement of damages, and including all cost for replacement of defective materials.

The Estimate of material quantities specified is approximate only and is given solely to be used as a uniform basis for comparison of basis. The minimum quantity for any item shall be zero (0). The maximum quantity shall be as stated in the Bid Proposal for each item.

Should the final quantity be less than the maximum quantity stated in the Bid Proposal for any item, the Supplier shall have no claim for loss incurred by him/her for commitments made by him/her in anticipation of the work contemplated, or for loss of anticipated profits, or for work done prior to his/her having been authorized to proceed therewith.

**GRAND TOTAL BID PRICE: (Base Bid Plus Total Cost for Items Nos. 1 and 2)**

\$ 202,430.00  
(In Figures)

two hundred + two thousand four hundred + thirty dollars - 00/100  
(In Writing)

The Contract will be awarded based on the Grand Total bid price. However, it is understood that the Total Cost for quantities are based upon a good faith estimate of the quantity of materials needed; therefore, the actual contract price, which cannot be determined until completion of the project may be for a sum either greater than or less than the Grand Total Bid Price above in accordance with the above Unit Price(s).



BID PROPOSAL  
(Continued)

**SCHEDULE OF PRICES**  
**(FOR ALTERNATES)**

**ALTERNATES:**

Indicate below the amount that will be added to or deducted from the lump sum base bid for each of the following alternates, if any are accepted by the City:

**ALTERNATE #A:**

(Add  or Deduct ) please indicate with a check mark.

**ALTERNATE #A: RESURFACE AND COLOR COAT BASKETBALL COURT**

Under Base Bid: Do not disturb the basketball court.

Under this Alternate: The bidder agrees to remove existing paved surface, base and subgrade to provide new basketball surface system, spot repair subgrade material where unsatisfactory. Reset existing drainage grates to finish grade. Provide and install new pavement system over basketball court area. Provide surface color coat and court striping. Provide and install new basketball backboard, rim with net on existing post. Provide and install concrete curb/footing as may be required to reinstall fence post and gates to pre-existing conditions at minimum.

\$ 131,500.00  
(Alternate #A - In Figures)

One hundred & thirty one thousand  
five hundred dollars - 00/100  
(Alternate #A - In Writing)

**TOTAL PRICE FOR GRAND TOTAL BASE BID PLUS ALTERNATE A**

\$ 333,930.00  
(Price in Figures)

\$ three hundred & thirty-three thousand nine hundred & thirty dollars - 00/100  
(Price in Words, Dollars and Cents)

\*NOTE: If the Base Bid is within the amount of funds available to finance the Contract and the City wishes to accept Bids on the Alternate(s), then the Contract award will be made to that responsible Bidder submitting the lowest combined Bid, consisting of the Base Bid plus Alternate Bid (s) (applied in the alphabetical order in which they are listed in the Schedule of Prices). Under this procedure, if the City wishes to award on only the Base Bid, then the Contract will be awarded to that responsible Bidder submitting the lowest Base Bid.



## STATE OF NEW JERSEY BUSINESS REGISTRATION CERTIFICATE

**Taxpayer Name:** ADAMO BROTHERS CONSTRUCTION, INC.  
**Trade Name:**  
**Address:** 1033 ALEXANDER AVE  
RIDGEFIELD, NJ 07657-1501  
**Certificate Number:** 0612212  
**Effective Date:** August 19, 1993  
**Date of Issuance:** August 24, 2018

**For Office Use Only:**  
20180824102527266



## New Jersey Division of Revenue

Revenue NJBGS

### On-Line Business Registration Certificate Service

CERTIFICATE NUMBER 0612212 FOR ADAMO BROTHERS CONSTRUCTION, INC. IS  
VALID.

VERIFIED  
PC

Certificate Number  
616430

Registration Date: 08/28/2018  
Expiration Date: 08/27/2019

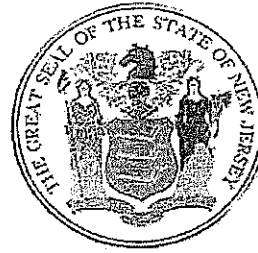

# State of New Jersey

Department of Labor and Workforce Development  
Division of Wage and Hour Compliance

## Public Works Contractor Registration Act

Pursuant to N.J.S.A. 34:11-56.48, et seq. of the Public Works Contractor Registration Act, this certificate of registration is issued for purposes of bidding on any contract for public work or for engaging in the performance of any public work to:

Adamo Brothers Construction Inc  
**2018**

Responsible Representative(s):  
Alfred Adamo, President

Responsible Representative(s):  
John Adamo, Vice-President

Robert Asaro-Angelo, Commissioner  
Department of Labor and Workforce Development

NON TRANSFERABLE

This certificate may not be transferred or assigned and may be revoked for cause by the Commissioner of Labor and Workforce Development.

EXHIBIT B (4 of 4)

(C) The contractor or subcontractor agrees that nothing contained in (B) above shall preclude the contractor or subcontractor from complying with the union hiring hall or apprenticeship policies in any applicable collective bargaining agreement or union hiring hall arrangement, and, where required by custom or agreement, it shall send journeymen and trainees to the union for referral, or to the apprenticeship program for admission, pursuant to such agreement or arrangement. However, where the practices of a union or apprenticeship program will result in the exclusion of minorities and women or the failure to refer minorities and women consistent with the targeted county employment goal, the contractor or subcontractor shall consider for employment persons referred pursuant to (B) above without regard to such agreement or arrangement; provided further, however, that the contractor or subcontractor shall not be required to employ women and minority advanced trainees and trainees in numbers which result in the employment of advanced trainees and trainees as a percentage of the total workforce for the construction trade, which percentage significantly exceeds the apprentice to journey worker ratio specified in the applicable collective bargaining agreement, or in the absence of a collective bargaining agreement, exceeds the ratio established by practice in the area for said construction trade. Also, the contractor or subcontractor agrees that, in implementing the procedures of (B) above, it shall, where applicable, employ minority and women workers residing within the geographical jurisdiction of the union.

After notification of award, but prior to signing a construction contract, the contractor shall submit to the public agency compliance officer and the Dept. of LWD, Construction EEO Monitoring Program an initial project workforce report (Form AA 201) electronically provided to the public agency by the Dept. of LWD, Construction EEO Monitoring Program, through its website, for distribution to and completion by the contractor, in accordance with N.J.A.C. 17:27-7. The contractor also agrees to submit a copy of the Monthly Project Workforce Report once a month thereafter for the duration of this contract to the Dept. of LWD, Construction EEO Monitoring Program and to the public agency compliance officer.

The contractor agrees to cooperate with the public agency in the payment of budgeted funds, as is necessary, for on the job and/or off the job programs for outreach and training of minorities and women.

(D) The contractor and its subcontractors shall furnish such reports or other documents to the Dept. of LWD, Construction EEO Monitoring Program as may be requested by the Dept. of LWD, Construction EEO Monitoring Program from time to time in order to carry out the purposes of these regulations, and public agencies shall furnish such information as may be requested by the Dept. of LWD, Construction EEO Monitoring Program for conducting a compliance investigation pursuant to Subchapter 10 of the Administrative Code (NJAC 17:27).

The undersigned vendor certifies on their company's receipt, knowledge and commitment to comply with:

EXHIBIT B

N.J.S.A. 10:5-31 et seq. (P.L. 1975, C. 127) and N.J.A.C. 17:27  
MANDATORY EQUAL EMPLOYMENT OPPORTUNITY LANGUAGE  
Construction Contracts

The undersigned vendor further agrees to furnish the required forms of evidence and understands that their contract/company's bid shall be rejected as non-responsive if said contractor fails to comply with the requirements of N.J.S.A. 10:5-31 et seq. (P.L. 1975, C. 127) and N.J.A.C. 17:27.

Representative's Name/Title (Print):

Alfred Adams

Representative's Signature:

Name of Company:

Adams Brothers

Tel. No.:

2019450064

Date:

10/17/18

**APPENDIX A**  
**AMERICANS WITH DISABILITIES ACT OF 1990**  
Equal Opportunity for Individuals with Disability

The contractor and the \_\_\_\_\_ of \_\_\_\_\_, (hereafter "owner") do hereby agree that the provisions of Title 11 of the Americans With Disabilities Act of 1990 (the "Act") (42 U.S.C. 5121 01 et seq.), which prohibits discrimination on the basis of disability by public entities in all services, programs, and activities provided or made available by public entities, and the rules and regulations promulgated pursuant thereto, are made a part of this contract. In providing any aid, benefit, or service on behalf of the owner pursuant to this contract, the contractor agrees that the performance shall be in strict compliance with the Act. In the event that the contractor, its agents, servants, employees, or subcontractors violate or are alleged to have violated the Act during the performance of this contract, the contractor shall defend the owner in any action or administrative proceeding commenced pursuant to this Act. The contractor shall indemnify, protect, and save harmless the owner, its agents, servants, and employees from and against any and all suits, claims, losses, demands, or damages, of whatever kind or nature arising out of or claimed to arise out of the alleged violation. The contractor shall, at its own expense, appear, defend, and pay any and all charges for legal services and any and all costs and other expenses arising from such action or administrative proceeding or incurred in connection therewith. In any and all complaints brought pursuant to the owner's grievance procedure, the contractor agrees to abide by any decision of the owner which is rendered pursuant to said grievance procedure. If any action or administrative proceeding results in an award of damages against the owner, or if the owner incurs any expense to cure a violation of the ADA which has been brought pursuant to its grievance procedure, the contractor shall satisfy and discharge the same at its own expense.

The owner shall, as soon as practicable after a claim has been made against it, give written notice thereof to the contractor along with full and complete particulars of the claim. If any action or administrative proceeding is brought against the owner or any of its agents, servants, and employees, the owner shall expeditiously forward or have forwarded to the contractor every demand, complaint, notice, summons, pleading, or other process received by the owner or its representatives.

It is expressly agreed and understood that any approval by the owner of the services provided by the contractor pursuant to this contract will not relieve the contractor of the obligation to comply with the Act and to defend, indemnify, protect, and save harmless the owner pursuant to this paragraph.

It is further agreed and understood that the owner assumes no obligation to indemnify or save harmless the contractor, its agents, servants, employees and subcontractors for any claim which may arise out of their performance of this Agreement. Furthermore, the contractor expressly understands and agrees that the provisions of this indemnification clause shall in no way limit the contractor's obligations assumed in this Agreement, nor shall they be construed to relieve the contractor from any liability, nor preclude the owner from taking any other actions available to it under any other provisions of the Agreement or otherwise at law.

Representative's Name/Title Print: Alfred Adams, Pres  
Representative's Signature: \_\_\_\_\_  
Name of Company: Adams Brothers Const.  
Tel. No.: 205555-XXXX Date: 10/17/18

**Minority/Woman Business Enterprise (MWBE) Questionnaire for Bidders**

Jersey City Ordinance C-829 establishes a goal of awarding 20% of the dollar amount of total city procurement to minority and woman owned business enterprises.

To assist us in monitoring our achievement of this goal, please indicate below whether your company is or is not a minority owned and/or woman owned business, and return this form with your bid proposal.

Business Name : Adams Brothers Construction Inc  
Address : 1033 Alexander Ave. Bridgefield NJ 07007  
Telephone No. : 201 945 0064  
Contact Name: Alfred Adams

Please check applicable category :

<input type="checkbox"/> Minority Owned Business (MBE)	<input type="checkbox"/> Minority & Woman Owned Business (MWBE)
<input type="checkbox"/> Woman Owned business (WBE)	<input checked="" type="checkbox"/> Neither

**Definitions:**

**Minority Business Enterprise**

Minority Business Enterprise means a business which is a sole proprietorship, partnership or corporation at least 51% of which is owned and controlled by persons who are African American, Hispanic, Asian American, American Indian or Alaskan native, defined as follows:

**African American:** a person having origins in any of the black racial groups of Africa

**Hispanic:** a person of Mexican, Puerto Rican, Central or South American or other non-European Spanish culture or origin regardless of race.

**Asian:** a person having origins in any of the original peoples of the Far East, South East Asia, Indian subcontinent, Hawaii or the Pacific Islands.

**American Indian or Alaskan Native:** a person having origins in any of the original peoples of North America and who maintains cultural identification through tribal affiliation or community recognition.

**Woman Business Enterprise**

Woman Business Enterprise means a business which is a sole proprietorship, partnership or corporation at least 51% of which is owned and controlled by a woman or women.

**OFFICE OF EQUAL EMPLOYMENT OPPORTUNITY/AFFIRMATIVE ACTION COPY**

Form MWBE Contractor's Compliance Plan to be submitted with bid document.  
**CONTRACTOR: PROVIDE TWO (2) COMPLETED COPIES OF THIS FORM WITH YOUR PROPOSAL** (or within 24 hours thereafter)

City of Jersey City  
 Department of Administration  
 Office of Equal Opportunity/Affirmative Action

Project: Sgt Anthony Park # 2016-037  
 Contractor: Adamo Brothers Const. Bid Amt. \$ 333,930 -

Please list what portions of the work, if any you intend to sublet, the approximate value of the same, and whether you anticipate subletting it to a minority or woman owned contractor, or neither.

Trade	Approx. \$ Value	Minority or Woman Owned Business Check appropriate column		
		Minority	Woman	Neither

Receipt of this report by the City does not constitute acceptance by the City of minority business participation goals less than 20% or women business participation goals less than 20% unless specifically agreed to by the Office of Equal Opportunity/Affirmative Action

CONTINUED ON NEXT PAGE

OFFICE OF EQUAL EMPLOYMENT OPPORTUNITY/AFFIRMATIVE ACTION COPY



Form MWBE Contractor's Compliance Plan to be submitted with bid document.  
**CONTRACTOR: PROVIDE TWO (2) COMPLETED COPIES OF THIS FORM WITH YOUR PROPOSAL (or within 24 hours thereafter)**

**City of Jersey City  
 Department of Administration  
 Office of Equal Opportunity/Affirmative Action**

Project: Sgt Anthony Park # 2016-037  
 Contractor: Alamo Brothers Const Bid Amt. \$ 333,930

Please list what portions of the work, if any you intend to sublet, the approximate value of the same, and whether you anticipate subletting it to a minority or woman owned contractor, or neither.

Trade	Approx. \$ Value	Minority or Woman Owned Business Check appropriate column		
		Minority	Woman	Neither

Receipt of this report by the City does not constitute acceptance by the City of minority business participation goals less than 20% or women business participation goals less than 20% unless specifically agreed to by the Office of Equal Opportunity/Affirmative Action

CONTINUED ON NEXT PAGE

DIVISION OF PURCHASING COPY

MWBE Page 3 Project Sgt Anthony Park

2. As to subcontracted trade mandated to be included in proposal pursuant to N.J.S.A. 40A:11-16, please list name of proposed subcontractor, trade, and whether minority woman, or not:

Trade	Contractor Name & Address	Approx \$ Value	Minority or Woman Owned Business Check appropriate column		
			Minority	Woman	Neither
	N/A				

3. What is your policy and practice with respect to outreach and consideration of minority and women-owned vendors/contractors as contractors and/or suppliers?

N/A

Name of Contractor Alfred Brothers Construction

By: Signature [Signature]

Type or print name/title: Alfred Alfred, Pres

Telephone No: 2019450064 Date: 10/17/18

For City Use:

Acceptable M/W Business Participation levels for this Project: \_\_\_\_\_

By \_\_\_\_\_ Date: \_\_\_\_\_

**EQUAL EMPLOYMENT OPORTUNITY COPY**

Sgt Anthony Cook

2. As to subcontracted trade mandated to be included in proposal pursuant to N.J.S.A. 40A:11-16, please list name of proposed subcontractor, trade, and whether minority woman, or not:

Trade	Contractor Name & Address	Approx. \$ Value	To Minority or Woman Owned Business		
			Minority	Woman	Neither
	N/A				

3. What is your policy and practice with respect to outreach and consideration of minority and women-owned vendors/contractors as contractors and/or suppliers?

N/A

Name of Contractor Alamo Brothers Construction

By: Signature [Signature]

Type or print name/title: Alfred Alamo

Telephone No: 2019450004 Date 10/17/18

.....  
For City Use:

Acceptable M/W Business Participation levels for this Project: \_\_\_\_\_

By \_\_\_\_\_ Date: \_\_\_\_\_

**PURCHASING COPY**

# Resolution of the City of Jersey City, N.J.

City Clerk File No. Res. 18-985

Agenda No. 10.Z

Approved: NOV 07 2018

TITLE:



**RESOLUTION AUTHORIZING THE AWARD OF A CONTRACT TO PUBLIC SERVICE ELECTRIC & GAS COMPANY FOR SUPPLYING AND INSTALLING DECORATIVE LIGHT POLES AT RIVERVIEW FISK PARK - RENOVATIONS, PROJECT NO. 2015-021, FOR THE DEPARTMENT OF ADMINISTRATION, DIVISION OF ARCHITECTURE**

**COUNCIL OFFERED AND MOVED ADOPTION OF THE FOLLOWING RESOLUTION:**

**WHEREAS**, the City of Jersey City (City) will be entering into a contract with a general contractor for the renovations to Riverview Fisk Park, Project No. 2015-021; and

**WHEREAS**, a separate prime contract is required for the installation of site lighting throughout the park; and

**WHEREAS**, Public Service Electric & Gas Company (PSE&G) as a public utility, provides the lights and poles to the City pursuant to an existing contract; and

**WHEREAS**, services to be performed by PSE&G under this contract will include the following:

- (1) Furnishing and installation of twenty-one (21) Franklin Park 85W LED Post Top Fixtures; and
- (2) Twenty-one (21) Classic I 12ft Poles Black

**WHEREAS**, pursuant to N.J.S.A. 40A:11-5(1)(f), a contract may be awarded by the City Council without publicly advertising for bids for the rendering of any service by a public utility, which is subject to the jurisdiction of the Board of Public Utilities, in accordance with tariffs and schedules of charges made, charged or exacted, filed with said board; and

**WHEREAS**, the City has negotiated a contract with PSE&G for the above mentioned project at an estimated cost of FORTY-THREE THOUSAND SEVEN HUNDRED EIGHTEEN AND 94/100 DOLLARS (\$43,718.94) with an Option to exercise a five (5%) per cent expenditure over total amount for unforeseen expenses; and

**WHEREAS**, these funds are available for this expenditure from Account Number:

04-215-55-933-990      P. O. No. 130929      \$43,718.94

**NOW, THEREFORE, BE IT RESOLVED** by the Municipal Council of the City of Jersey City that a contract be awarded to Public Service Electric and Gas in the amount of \$43,718.94 and the City Purchasing Agent is directed to have such a contract drawn up and executed; and be it further

**RESOLVED**, that upon certification by an official or employee of the City authorized to attest that the contract has complied with specifications in all respects, and the requirements of the contract met, then; payment to the contractor shall be made in accordance with the provisions of the Local Fiscal Affairs Law, N.J.S.A. 40:5-1 et. seq.; and be it further

City Clerk File No. Res. 18-985

Agenda No. 10.Z NOV 07 2018

TITLE:

**RESOLUTION AUTHORIZING THE AWARD OF A CONTRACT TO PUBLIC SERVICE ELECTRIC & GAS COMPANY FOR SUPPLYING AND INSTALLING DECORATIVE LIGHT POLES AT RIVERVIEW FISK PARK - RENOVATIONS, PROJECT NO. 2015-021, FOR THE DEPARTMENT OF ADMINISTRATION, DIVISION OF ARCHITECTURE**

**RESOLVED**, that this contract award shall be subject to the condition that the vendor provide satisfactory evidence of compliance with the Affirmative Action amendments to the Law Against Discrimination, N.J.S.A. 10:5-31 et. seq. and be it further

**RESOLVED**, that the Mayor or Business Administrator is hereby authorized to execute a contract on behalf of the City of Jersey City.

I, Donna Mau (DONNA MAUER), as Chief Financial Officer, hereby certify that these funds in the amount of \$43,718.94 are available for this expenditure in Account No. 04-215-55-933-990 for payment of the above Resolution.

October 11, 2018  
RR/ab

JMcK  
10/19/18

APPROVED: \_\_\_\_\_

APPROVED AS TO LEGAL FORM

APPROVED: RR  
Business Administrator

[Signature]  
Corporation Counsel

Certification Required

Not Required

**APPROVED 8-0**

**RECORD OF COUNCIL VOTE ON FINAL PASSAGE**

COUNCILPERSON	AYE	NAY	N.V.	COUNCILPERSON	AYE	NAY	N.V.	COUNCILPERSON	AYE	NAY	N.V.
RIDLEY	✓			YUN	✓			RIVERA	✓		
PRINZ-AREY	✓			SOLOMON	✓			WATTERMAN	ABSENT		
BOGGIANO	✓			ROBINSON	✓			LAVARRO, PRES.	✓		

✓ Indicates Vote

N.V.-Not Voting (Abstain)

Adopted at a meeting of the Municipal Council of the City of Jersey City N.J.

[Signature]  
Rólando R. Lavarro, Jr., President of Council

[Signature]  
Robert Byrne, City Clerk

**RESOLUTION FACT SHEET - CONTRACT AWARD**

This summary sheet is to be attached to the front of any resolution that is submitted for Council consideration. Incomplete or vague fact sheets will be returned with the resolution.

**Full Title of Ordinance/Resolution**

**RESOLUTION AUTHORIZING THE AWARD OF A CONTRACT TO PUBLIC SERVICE ELECTRIC & GAS COMPANY FOR SUPPLYING AND INSTALLING DECORATIVE LIGHT POLES AT RIVERVIEW FISK PARK - RENOVATIONS, PROJECT NO. 2015-021, FOR THE DEPARTMENT OF ADMINISTRATION, DIVISION OF ARCHITECTURE**

**Project Manager**

Department/Division	Administration	Architecture
Name/Title	Brian F. Weller, L.L.A., A.S.L.A.	Director
Phone/email	(201) 547-5900	Wellerb@jcnj.org

Note: Project Manager must be available by phone during agenda meeting (Wednesday prior to council meeting @ 4:00 p.m.)

**Contract Purpose**

The City of Jersey City is planning renovations to Riverview Fisk Park. In conjunction with the park renovations, installation of:

- (1) Furnishing and installation of twenty-one (21) Franklin Park 85W LED Post Top Fixtures; and
- (2) Twenty-one (21) Classic I 12ft Poles Black

**Cost (Identify all sources and amounts)**

Various City Parks Account  
04-215-55-933-990 - \$43,718.94

**Contract term (include all proposed renewals)**

The term of this will be Eight (8) weeks after award of the contract.

Type of award

If "Other Exception", enter type

**Additional Information**

The upgraded lighting system will provide uniform lighting throughout the park to enhance nighttime security and reduce the incidents of vandalism.

I certify that all the facts presented herein are accurate.

  
Signature of Division Director

10.12.18  
Date



**Request for Lighting Service - PSEG Confidential**

**Project Name:** CITY OF JERSEY CITY PARKS DEPT-RIVERVI **Project Status:** Agreement **Presented Date:** 9/10/2018  
**Customer Name:** CITY OF JERSEY CITY PARKS DEPT-RIVERVIEW-FISK PARK **BP#:** 1001014996 **Contract Account #:** 6942379409  
**Service Address:** OGDEN AVE, JERSEY CITY **Effective Date:** 9/10/2018 **Service Date:** 2/28/2019  
**Contact Name:** BRIAN WELLER **Contract Term:** 5 Years **Distribution:** UG  
**Office Tel:** (201) 547-5900 **Cell Phone:** **E-Mail:** **Fax:**

Office Record

**Purchase Order #** \_\_\_\_\_

STANDARD		SPECIAL		DWMS Customer #	DWMS LD #	DWMS E1 #	CIAC E1 #
Premise #	Installation #	Installation2 #					
5002440452	4003937689	44655506		6402726	500696536		500696437

**Rates and Costs Details**

Product	Amt	RefVal	Rate	New Pole or	Free Pole	Pole Pre-paid	Secn Avail-able	Action Type	Sales Type	Order Type	Mthly Install Rate	Mthly Remov Rate	Upfnt Rate	Access Product Qty	Access Product Code	Access Upfnt Rate	Found Credit Qty	Found Credit Amt	ID
Luminai	21	EX059999BL	BPL	<input type="checkbox"/>	<input type="checkbox"/>	<input type="checkbox"/>	<input type="checkbox"/>	Install	New	Set Exist	26.45	0.00	0.00			0.00		0.00	3779
Pole	21	EX041280LP	BPL_NC	<input type="checkbox"/>	<input type="checkbox"/>	<input type="checkbox"/>	<input type="checkbox"/>	Install			0.46	0.00	1,597.01			0.00	21	362.36	4555

**Rates and Costs Summary**

Installs: Monthly Service Charge Totals		Removes: Prior Charges (No Charge to Remove)		One-Time Cost Totals	
Luminaire Mth Svc Charge Total	\$555.45	Luminaires: Prior Monthly Charges	\$0.00	Cost for Construction (CIAC)	\$17,791.29
Pole Mthly Service Charge Total	\$9.66	Poles: Prior Monthly Charges	\$0.00	Foundation Credit Total	\$7,609.56
Bracket Mthly Serv Chrg Total	\$0.00	Brackets: Prior Monthly Charges	\$0.00	Pole Upfront Cost Total	\$33,537.21
Mthly Service Charge Totals	\$565.11	Prior Monthly Charge Totals	\$0.00	Bracket Upfront Cost Total	\$0.00
				Accessory Upfront Cost Total	\$0.00
				Lumin Upfront Cost Total	\$0.00

**Grand Total One Time Upfront Cost**  
\$43,718.94

**Comments:** FRANKLIN PARK -85W LED POST TOP- CLASSIC 1 12FT POLE BLACK

**RepEMail:** mario.zamora@pseg.com **Phon:** **Print Signatory Name/Title:** XX  
**PSEG Representative:** Mario Zamora **\*Authorized Signature:**

\*In executing this Proposal and Service Agreement, Customer: (1) accepts the Proposal for Dusk to Dawn Lighting Service; (2) acknowledges and agrees that this is an agreement for lighting Services only and that Customer in receiving Service hereunder does not acquire any right, title or interest in any of the equipment used to provide such lighting Services and that such right, title and interest shall be vested exclusively in PSE&G; (3) will provide PSE&G with reasonable access in order to enable PSE&G to maintain, replace or remove such equipment; (4) and acknowledges and agrees that, in addition to these terms, Service is subject to the terms and conditions set forth in the Service Agreement - Standard Terms and Conditions - PSEG Street Lighting Service, which are printed on the back of this Proposal and Agreement.



## STANDARD TERMS CONDITIONS

### PSEG Street and Area Lighting Service

**SECTION 1 - SCOPE OF WORK, PRICE, AND TAXES.** PSEG shall perform the services, as set forth in the Form of Proposal (the "Services") for the price specified therein. Any terms or conditions other than those stated in the Street and Area Lighting Services Agreement shall be null and void, including any preprinted terms and conditions contained in any of the Customer's purchase order forms. Customer shall be responsible for and shall pay the amount of any tax applicable to the Services. Except in cases of emergency, no extra or different Services shall be done unless written approval is issued authorizing such Services prior to the performance thereof. Any extra or different work performed by PSEG on an emergency basis shall be governed by the terms and conditions which incorporates by reference the provisions of PSEG's Tariff for Electric Service.

**SECTION 2 - TERMS OF PAYMENT.** Monthly payment for the Services shall be included in Customer's bill. Upfront payments for the Services as identified in the Form of Proposal is required before the start of work, unless otherwise indicated.

**SECTION 2a -- TERM OF AGREEMENT.** Please reference the Lighting Rate Schedule section of the Tariff regarding provisions for:

BPL: Original sheet No. 189-191	BPL-POF: Original sheet No. 199-200	PSAL: Original sheet No. 212-214
---------------------------------	-------------------------------------	----------------------------------

### SECTION 3 - WARRANTY AND REMEDIES

A. PSEG warrants that for the period of twelve (12) months after the completion of the Services, the Services will reflect competent professional knowledge, judgment and workmanship and will be performed in accordance with generally accepted professional standards and work practices applicable at the time the Services are performed. PSEG warrants that any goods (e.g. lights, brackets and poles) installed shall be free from defects in material or workmanship for one year from the date of installation or provision, whichever occurs first.

B. PSEG does not warrant and shall have no liability for any nonconformance or defects in the performance of the finish on painted street lighting equipment. Customer shall pursue all claims for nonconformance or defects in the performance of the finish on painted street lighting equipment against the manufacturer and PSEG shall take commercially reasonable efforts to support and assist Customer.

C. Conditions Applying to Warranties.

1. PSEG shall have no liability or obligation for any manufacturing, construction or design defects in the Customer's facilities and equipment, hidden hazardous conditions, or the Customer's failure to comply with all applicable codes, standards, laws, and regulations.
2. Customer shall provide PSEG with any pertinent facts or information concerning the Customer's facilities and equipment which could affect the Services to be performed therein which are known or accessible only to the Customer or not reasonably discoverable by PSEG.
3. Customer will provide written notice to PSEG specifying nonconforming Services or Goods upon discovery thereof, and in any event, any such notice of warranty nonconformance shall be given no later than forty-five (45) days after the expiration of the applicable warranty period.

4. Customer will provide PSEG with a reasonable opportunity to perform corrective work to comply with warranties herein. All corrective work will be performed on a schedule to be mutually agreed upon. Customer shall be responsible to remove and replace any equipment or structure in order to provide PSEG with access to perform warranty work.

5. PSEG shall have no liability or obligation for anything arising out of these terms, in the event that the Customer breaches any of the requirements of Paragraph C of this Article.

D. **Exclusivity of Warranties and Remedies.** The warranties set forth in these terms are exclusive and are in lieu of all other warranties, whether statutory, express or implied, including, but not limited to, any warranties or merchantability, fitness for a particular purpose or arising out of any course of dealing or usage of trade. The remedies set forth in these terms are the exclusive remedies of Customer for any breach, defect or anything arising out of the performance or nonperformance of these terms.

### SECTION 4 - INDEMNIFICATION AND LIABILITY

PSEG shall indemnify and hold Customer harmless for any claims, suits, costs, damages, losses, or judgments arising out of PSEG's negligent acts or omissions in connection with these terms. Customer shall indemnify and hold PSEG harmless for any claims, suits, costs, damages, losses, or judgments arising out of Customer's negligent acts or omissions in connection with these terms. However, the parties' entire liability and obligation under these terms shall not exceed the dollar amount of the Contract Price, as set forth in "Form of Proposal", and under no circumstances shall the parties be liable to each other for any special, incidental, indirect, punitive, or consequential losses or damages whatsoever (including for lost profits, time, or revenue) for anything arising out of the performance or nonperformance of these terms, whether claims for said losses or damages are premised on warranty, negligence, strict liability, contract, or otherwise.

**SECTION 5 - DELAYS AND FORCE MAJEURE.** Other than the obligation to pay money, the parties shall not be liable to each other for failure to perform or for delay in performance due to, any cause beyond their reasonable control: or fire; flood, strike, or other labor difficulty; acts of God; mandates, directives, orders, or restraints of any governmental, regulatory, or judicial body or agency; riot; embargo; fuel or energy shortage; delays in transportation; inability to obtain necessary labor, materials or manufacturing facilities from usual sources; or act of omission of any of the persons or entities employed by the parties. In the event of delay in performance due to any such cause, the date of performance or time for completion will be extended by a period of time reasonably necessary to overcome the effect of such delay.

**STANDARD TERMS CONDITIONS**

**PSEG Street and Area Lighting Service (continued)**

**SECTION 6 - RELATIONSHIP.** The relationship of PSEG and Customer to each other shall be that of parties to a contract, and neither these terms or anything done pursuant to these terms shall be deemed to create any partnership, joint venture, or agency relationship between the two parties. There are no third party beneficiaries to these terms.

**SECTION 7 - COMPLIANCE WITH LAW.** The Parties shall comply with all applicable laws and regulations.

**SECTION 8 - WAIVERS.** No term or condition of these terms shall be deemed to have been waived and no breach excused unless such waiver or breach is in writing signed by the party claimed to have waived or consented to excuse. Either parties' failure to demand or insist, in any one or more instances, upon strict performance of these terms, or to exercise any rights conferred under these terms, shall not be construed as a waiver or relinquishment of its right to assert or rely upon any such terms or rights in the future.

**SECTION 9 - APPLICABILITY OF TARIFF.** The PSEG Tariff For Electric Service on file with the New Jersey Board Of Public Utilities is hereby incorporated in its entirety by reference, and any conflict or inconsistency between the terms and conditions of these terms and said Tariff shall be resolved in favor of the Tariff.

**SECTION 10 - HEADINGS.** The headings assigned to the sections of these terms are for convenience only and shall not limit the scope and applicability of the sections.

**SECTION 11 - ENTIRE AGREEMENT.** These terms, which includes the "Form of Proposal" , constitutes the final, complete, and entire Agreement between the parties, and all prior discussions, negotiations, communications, proposals, or agreements, whether oral or written, are hereby superseded. Any statements, representations, terms or conditions, whether express or implied, other than those set forth in these terms may not be modified, altered, or amended in any way except in writing signed by duly authorized representatives of both the Customer and PSEG. These terms shall be governed and construed by the laws of the State of New Jersey.

**SECTION 12 - CANCELTION PRIOR TO RECEIPT OF SERVICE.** Termination of this Agreement by the Customer prior to completion of installation and receipt of service shall be done by written notice. The Customer shall be liable for cost incurred by PSEG between date of the Agreement and the date written notice for cancellation is received.



**Estimated Cost Summary - PSEG Confidential**

**Outdoor Lighting**

**Project Name:** CITY OF JERSEY CITY PARKS DEPT-RIVERVIEW-FISK PARK

**Contract Account #** 6942379409

**Customer Name** CITY OF JERSEY CITY PARKS DEPT-RIVERVIEW-FISK PARK

**For Service at Address:** OGDEN AVE, JERSEY CITY

<b>CostType</b>	<b>Product</b>	<b>Qty</b>	<b>Amount</b>
Install	Pole	21	\$9.66
	Luminaire	21	\$555.45
<b>Monthly Install Totals</b>		<b>42</b>	<b>\$565.11</b>
Upfront	Cost of Construction	1	\$17,791.29
	Pole	21	\$33,537.21
	Foundation Credit	21	(\$7,609.56)
<b>Upfront Totals</b>		<b>43</b>	<b>\$43,718.94</b>

*This is Not an Invoice*

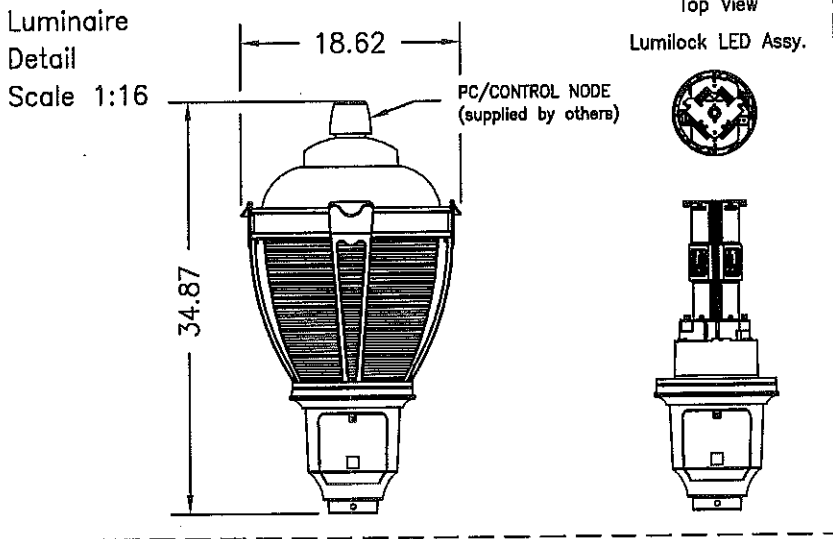
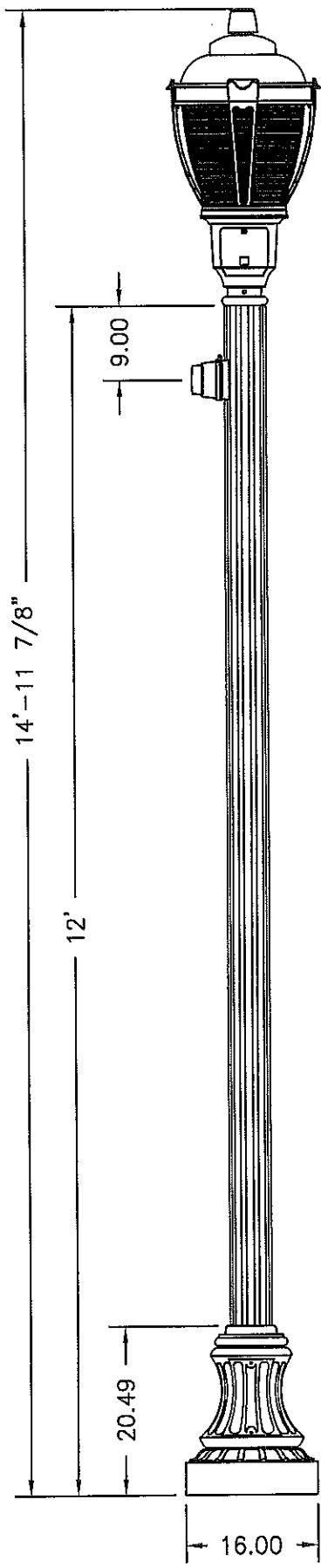

C/C	PART #	DESCRIPTION
.	C4729E-A	Franklin Park-LED, 84W, T5, Black
04-1280	SP5644-A	Classic-I Pole, 12', Black

PRODUCT APPROVALS	
HADCO	SDK
CUST.	

**CONFIDENTIAL:**  
This drawing is confidential and proprietary to Philips Hadco and may not be reproduced without the express written consent of Philips Hadco. Any use hereof or of any of the information or detail herein shall be for the sole benefit of Philips Hadco.

**NOTICE:**  
This drawing is for reference only. Check for latest revision prior to ordering.

**PSEG**  
PUBLIC SERVICE ELECTRIC AND GAS COMPANY  
NEWARK, N.J.

**PHILIPS HADCO**

100 Craftway Drive  
Littlestown, Pa 17340  
Phone 800-331-4185  
Fax 717-359-9289  
www.philips.com

JOB NAME:  
Fisk Park  
- Jersey City

DRAWN BY:  
H. Kuhn

SCALE: 1:20	DATE: 01/30/17
----------------	-------------------

DRAWING NUMBER:  
C13970-DWG03

REP:  
Dave Murphy & Assoc.

REV: C	PCN: 17-022
BY: SMK	DATE: 10/03/17

Pole Orientation

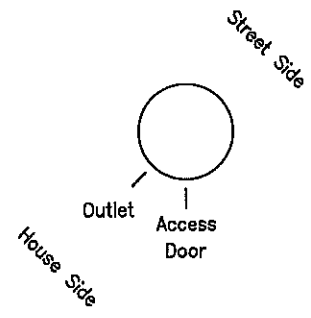

Note:  
Pole orientation for drawing purposes only, pour concrete per anchor rod template.

(REVISED 4/13)

**EXHIBIT A**  
**MANDATORY EQUAL EMPLOYMENT OPPORTUNITY LANGUAGE**  
**N.J.S.A. 10:5-31 et seq. (P.L. 1975, C. 127)**  
**N.J.A.C. 17:27**

**GOODS, PROFESSIONAL SERVICE AND GENERAL SERVICE CONTRACTS**

During the performance of this contract, the contractor agrees as follows:

The contractor or subcontractor, where applicable, will not discriminate against any employee or applicant for employment because of age, race, creed, color, national origin, ancestry, marital status, affectional or sexual orientation, gender identity or expression, disability, nationality or sex. Except with respect to affectional or sexual orientation and gender identity or expression, the contractor will ensure that equal employment opportunity is afforded to such applicants in recruitment and employment, and that employees are treated during employment, without regard to their age, race, creed, color, national origin, ancestry, marital status, affectional or sexual orientation, gender identity or expression, disability, nationality or sex. Such equal employment opportunity shall include, but not be limited to the following: employment, upgrading, demotion, or transfer; recruitment or recruitment advertising; layoff or termination; rates of pay or other forms of compensation; and selection for training, including apprenticeship. The contractor agrees to post in conspicuous places, available to employees and applicants for employment, notices to be provided by the Public Agency Compliance Officer setting forth provisions of this nondiscrimination clause.

The contractor or subcontractor, where applicable will, in all solicitations or advertisements for employees placed by or on behalf of the contractor, state that all qualified applicants will receive consideration for employment without regard to age, race, creed, color, national origin, ancestry, marital status, affectional or sexual orientation, gender identity or expression, disability, nationality or sex.

The contractor or subcontractor will send to each labor union, with which it has a collective bargaining agreement, a notice, to be provided by the agency contracting officer, advising the labor union of the contractor's commitments under this chapter and shall post copies of the notice in conspicuous places available to employees and applicants for employment.

The contractor or subcontractor, where applicable, agrees to comply with any regulations promulgated by the Treasurer pursuant to N.J.S.A. 10:5-31 et seq., as amended and supplemented from time to time and the Americans with Disabilities Act.

The contractor or subcontractor agrees to make good faith efforts to meet targeted county employment goals established in accordance with N.J.A.C. 17:27-5.2.

**EXHIBIT A (Continuation)**

The contractor or subcontractor agrees to inform in writing its appropriate recruitment agencies including, but not limited to, employment agencies, placement bureaus, colleges, universities, and labor unions, that it does not discriminate on the basis of age, race, creed, color, national origin, ancestry, marital status, affectional or sexual orientation, gender identity or expression, disability, nationality or sex, and that it will discontinue the use of any recruitment agency which engages in direct or indirect discriminatory practices.

The contractor or subcontractor agrees to revise any of its testing procedures, if necessary, to assure that all personnel testing conforms with the principles of job-related testing, as established by the statutes and court decisions of the State of New Jersey and as established by applicable Federal law and applicable Federal court decisions.

In conforming with the targeted employment goals, the contractor or subcontractor agrees to review all procedures relating to transfer, upgrading, downgrading and layoff to ensure that all such actions are taken without regard to age, race, creed, color, national origin, ancestry, marital status, affectional or sexual orientation, gender identity or expression, disability, nationality or sex, consistent with the statutes and court decisions of the State of New Jersey, and applicable Federal law and applicable Federal court decisions.

The contractor shall submit to the public agency, after notification of award but prior to execution of a goods and services contract, one of the following three documents:

Letter of Federal Affirmative Action Plan Approval

Certificate of Employee Information Report

Employee Information Report Form AA302 (electronically provided by the Division and distributed to the public agency through the Division's website at [www.state.nj.us/treasury/contract\\_compliance](http://www.state.nj.us/treasury/contract_compliance))

The contractor and its subcontractors shall furnish such reports or other documents to the Division of Purchase & Property, CCAU, EEO Monitoring Program as may be requested by the office from time to time in order to carry out the purposes of these regulations, and public agencies shall furnish such information as may be requested by the Division of Purchase & Property, CCAU, EEO Monitoring Program for conducting a compliance investigation pursuant to Subchapter 10 of the Administrative Code at N.J.A.C. 17:27.

The undersigned vendor certifies on their company's receipt, knowledge and commitment to comply with:

**EXHIBIT A**  
N.J.S.A. 10:5-31 and N.J.A.C. 17:27  
**MANDATORY EQUAL EMPLOYMENT OPPORTUNITY LANGUAGE**  
Goods, Professional Services and General Service Contracts  
(Mandatory Affirmative Action Language)

The undersigned vendor further agrees to furnish the required forms of evidence and

understands that their contract/company's bid shall be rejected as non-responsive if said contractor fails to comply with the requirements of N.J.S.A. 10:5-31 and N.J.A.C. 17:27.

Representative's Name/Title (Print): JoAnn Koon-Smith, EEO/AA Compliance Manager

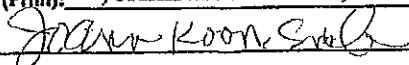
Representative's Signature: 

Name of Company: Public Service Enterprise Group

Tel. No.: 973-430-6540

Date: 8/9/2018

**APPENDIX A**  
**AMERICANS WITH DISABILITIES ACT OF 1990**  
**Equal Opportunity for Individuals with Disability**

The contractor and the City of Jersey City, (hereafter "owner") do hereby agree that the provisions of Title 11 of the Americans With Disabilities Act of 1990 (the "Act") (42 U.S.C. 5121 01 et seq.), which prohibits discrimination on the basis of disability by public entities in all services, programs, and activities provided or made available by public entities, and the rules and regulations promulgated pursuant thereto, are made a part of this contract. In providing any aid, benefit, or service on behalf of the owner pursuant to this contract, the contractor agrees that the performance shall be in strict compliance with the Act. In the event that the contractor, its agents, servants, employees, or subcontractors violate or are alleged to have violated the Act during the performance of this contract, the contractor shall defend the owner in any action or administrative proceeding commenced pursuant to this Act. The contractor shall indemnify, protect, and save harmless the owner, its agents, servants, and employees from and against any and all suits, claims, losses, demands, or damages, of whatever kind or nature, arising out of or claimed to arise out of the alleged violation. The contractor shall, at its own expense, appear, defend, and pay any and all charges for legal services and any and all costs and other expenses arising from such action or administrative proceeding or incurred in connection therewith. In any and all complaints brought pursuant to the owner's grievance procedure, the contractor agrees to abide by any decision of the owner which is rendered pursuant to said grievance procedure. If any action or administrative proceeding results in an award of damages against the owner, or if the owner incurs any expense to cure a violation of the ADA which has been brought pursuant to its grievance procedure, the contractor shall satisfy and discharge the same at its own expense.

The owner shall, as soon as practicable after a claim has been made against it, give written notice thereof to the contractor along with full and complete particulars of the claim. If any action or administrative proceeding is brought against the owner or any of its agents, servants, and employees, the owner shall expeditiously forward or have forwarded to the contractor every demand, complaint, notice, summons, pleading, or other process received by the owner or its representatives.

It is expressly agreed and understood that any approval by the owner of the services provided by the contractor pursuant to this contract will not relieve the contractor of the obligation to comply with the Act and to defend, indemnify, protect, and save harmless the owner pursuant to this paragraph.

It is further agreed and understood that the owner assumes no obligation to indemnify or save harmless the contractor, its agents, servants, employees and subcontractors for any claim which may arise out of their performance of this Agreement. Furthermore, the contractor expressly understands and agrees that the provisions of this indemnification clause shall in no way limit the contractor's obligations assumed in this Agreement, nor shall they be construed to relieve the contractor from any liability, nor preclude the owner from taking any other actions available to it under any other provisions of the Agreement or otherwise at law.

Representative's Name/Title Print: JoAnn Koon-Smith, EEO/AA Compliance Manager  
Representative's Signature: *JoAnn Koon-Smith*  
Name of Company: Public Service Enterprise Group  
Tel. No.: 973-430-6540 Date: 8/9/2018

**Minority/Woman Business Enterprise (MWBE)  
Questionnaire for Bidders**

Jersey City Ordinance C-829 establishes a goal of awarding 20% of the dollar amount of total city procurement to minority and woman owned business enterprises.

To assist us in monitoring our achievement of this goal, please indicate below whether your company is or is not a minority owned and/or woman owned business, and return this form with your bid proposal.

Business Name : Public Service Enterprise Group  
Address : 80 Park Plaza, Newark, NJ 07102  
Telephone No. : 973-430-6540  
Contact Name : JoAnn Koon-Smith

Please check applicable category :

Minority Owned Business (MBE)       Minority & Woman Owned Business (MWBE)  
 Woman Owned business (WBE)       Neither

**Definitions**

**Minority Business Enterprise**

Minority Business Enterprise means a business which is a sole proprietorship, partnership or corporation at least 51% of which is owned and controlled by persons who are African American, Hispanic, Asian American, American Indian or Alaskan native, defined as follows:

**African American:** a person having origins in any of the black racial groups of Africa

**Hispanic:** a person of Mexican, Puerto Rican, Central or South American or other non-European Spanish culture or origin regardless of race.

**Asian:** a person having origins in any of the original peoples of the Far East, South East Asia, Indian subcontinent, Hawaii or the Pacific Islands.

**American Indian or Alaskan Native:** a person having origins in any of the original peoples of North America and who maintains cultural identification through tribal affiliation or community recognition.

**Woman Business Enterprise**

Woman Business Enterprise means a business which is a sole proprietorship, partnership or corporation at least 51% of which is owned and controlled by a woman or women.

**OFFICE OF EQUAL OPPORTUNITY COPY**



Certification 7396

### CERTIFICATE OF EMPLOYEE INFORMATION REPORT

#### RENEWAL

This is to certify that the contractor listed below has submitted an Employee Information Report pursuant to N.J.A.C. 17:27-1.1 et. seq. and the State Treasurer has approved said report. This approval will remain in effect for the period of **15-MAY-2016** to **15-MAY-2019**

**PUBLIC SERVICE ENTERPRISE GROUP**  
**80 PARK PLAZA, MC/T10**  
**NEWARK NJ 07102**

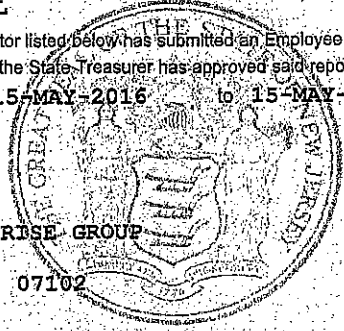

A handwritten signature in black ink, appearing to read "Ford M. Scudder".

FORD M. SCUDDER  
Acting State Treasurer

STATE OF NEW JERSEY  
BUSINESS REGISTRATION CERTIFICATE

DEPARTMENT OF TREASURY/  
DIVISION OF REVENUE  
PO BOX 252  
TRENTON, N.J. 08646-0252

TAXPAYER NAME:

PUBLIC SERVICE ELECTRIC AND GAS COMPANY

TRADE NAME:

TAXPAYER IDENTIFICATION#:

SEQUENCE NUMBER:

0062256

ADDRESS:

80 PARK PLAZA, 19A  
NEWARK NJ 07102

ISSUANCE DATE:

09/08/04

EFFECTIVE DATE:

07/25/24

Acting Director

FORM-BRC(08-01)

This Certificate is NOT assignable or transferable. It must be conspicuously displayed at above address.

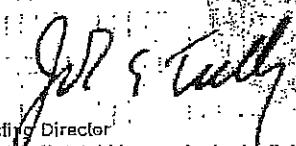

# Resolution of the City of Jersey City, N.J.

City Clerk File No. Res. 18-986

Agenda No. 10.Z.1

Approved: NOV 07 2018

TITLE:



## RESOLUTION AUTHORIZING THE AWARD OF A CONTRACT TO OBSIDIAN INTEGRATION LLC FOR THE PURCHASE AND DELIVERY OF A COVERT POLE CAMERA FOR THE DEPARTMENT OF PUBLIC SAFETY, DIVISION OF POLICE

### COUNCIL OFFERED AND MOVED ADOPTION OF THE FOLLOWING RESOLUTION:

**WHEREAS**, the function of covert pole camera is to enhance community safety by allowing police investigators to target hot-spots for criminal and nuisance activity and gather evidence for effective prosecutions; and

**WHEREAS**, in conformity with N.J.S.A. 40A:11-6.1(a), the Director of Purchasing informally solicited three quotes, including one from Obsidian Integration LLC, 2145 Getty Circle Unit 3, Cottage Grove, Oregon 97424 in the total amount of thirty three thousand, five hundred dollars (\$33,500.00); and

**WHEREAS**, the Director of Purchasing believes the proposal of Obsidian Integration LLC to be the most advantageous, price and other factors considered; and

**WHEREAS**, the City of Jersey City ("City") is acquiring these services directly and openly as a statutorily permitted contract pursuant to the provisions of N.J.S.A. 19:44A-20.5 et seq. (Pay-to-Play Law); and

**WHEREAS**, the Director of the Police Division has determined and certified in writing that the value of the contract will exceed \$17,500.00; and

**WHEREAS**, the contractor has completed and submitted a Business Entity Disclosure Certification which certifies that the contractor has not made any reportable contributions to the political candidate committees listed in the Business Entity Disclosure Certification in the previous one year, and that the contract will prohibit the contractor from making any reportable contributions during the term of the contract; and

**WHEREAS**, the contractor has submitted a Chapter 271 Political Contribution Disclosure Certification at least 10 days prior to the award of this contract; and

**WHEREAS**, the contractor has submitted its Certification of Compliance with the City's Contractor Pay-to-Play Reform Ordinance 08-128 adopted on September 3, 2008; and

**WHEREAS**, funds are available for this contract in the Operating Account:

Account	PO #	Total Contract
01-201-25-240-218	131048	\$33,500.00

**NOW, THEREFORE BE IT RESOLVED**, by the Municipal Council of the City of Jersey City that:

1. A contract award to Obsidian Integration LLC in the amount of \$33,500.00 for the purchase and delivery of a covert pole camera is authorized
2. The term of the contract will be completed upon the delivery of the goods or services.
3. Upon certification by an official or employee of the City authorized to administer the contract met, the services have been performed and that the requirements of the contract met, then payment to the contractor shall be made in accordance with the Local Fiscal Affairs Law, N.J.S.A. 40A:5-1 et seq.; and

(Continued on page 2)

TITLE:

**RESOLUTION AUTHORIZING THE AWARD OF A CONTRACT TO OBSIDIAN INTEGRATION LLC FOR THE PURCHASE AND DELIVERY OF A COVERT POLE CAMERA FOR THE DEPARTMENT OF PUBLIC SAFETY, DIVISION OF POLICE**

- 4. The Business Entity Disclosure Certification, Chapter 271 Political Contribution Disclosure Certification, the Certification of Compliance with the City's Contractor Pay-to-Play Reform Ordinance, and the Determination of Value Certification, attached hereto, shall be placed on file with this resolution.

Donna Mauer, Donna Mauer, Chief Financial Officer, certify that there are sufficient funds available for payment of this above resolution.

<b>Account</b>	<b>PO #</b>	<b>Total Contract</b>
01-201-25-240-218	131048	\$33,500.00

Approved by: Peter Folgado  
 Peter Folgado, Director of Purchasing  
 RPPO, QPA

10/25/18  
 Date

PF/pv  
 10/23/18  
 JMK  
 10/24/18

APPROVED: \_\_\_\_\_

APPROVED AS TO LEGAL FORM

APPROVED: [Signature]  
 Business Administrator

[Signature]  
 Corporation Counsel

Certification Required   
 Not Required

APPROVED 8-0

RECORD OF COUNCIL VOTE ON FINAL PASSAGE 11-7-18											
COUNCILPERSON	AYE	NAY	N.V.	COUNCILPERSON	AYE	NAY	N.V.	COUNCILPERSON	AYE	NAY	N.V.
RIDLEY	✓			YUN	✓			RIVERA	✓		
PRINZ-AREY	✓			SOLOMON	✓			WATTERMAN	ABSENT		
BOGGIANO	✓			ROBINSON	✓			LAVARRO, PRES	✓		

✓ Indicates Vote

N.V.-Not Voting (Abstain)

Adopted at a meeting of the Municipal Council of the City of Jersey City N.J.

[Signature]  
 Rolando R. Lavarro, Jr., President of Council

[Signature]  
 Robert Byrne, City Clerk

**RESOLUTION FACT SHEET**

This summary sheet is to be attached to the front of any resolution that is submitted for Council consideration. Incomplete or vague fact sheets will be returned with the resolution.

**Full Title of Ordinance/Resolution**

**RESOLUTION AUTHORIZING THE AWARD OF A CONTRACT TO OBSIDIAN INTEGRATION LLC FOR THE PURCHASE AND DELIVERY OF A COVERT POLE CAMERA FOR THE DEPARTMENT OF PUBLIC SAFETY, DIVISION OF POLICE**

**Initiator**

Department/Division	PUBLIC SAFETY	POLICE
Name/Title	TAWANA MOODY	DIRECTOR
Phone/email		TMoody@NJJCPS.ORG

Note: Initiator must be available by phone during agenda meeting (Wednesday prior to council meeting @ 4:00 p.m.)

**Resolution Purpose**

[Empty box for Resolution Purpose]

I certify that all the facts presented herein are accurate.

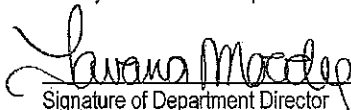
  
\_\_\_\_\_  
Signature of Department Director

10/21/18  
Date

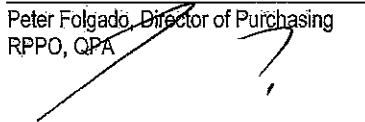
  
\_\_\_\_\_  
Peter Folgado, Director of Purchasing  
RPPO, QPA

10/25/18  
Date

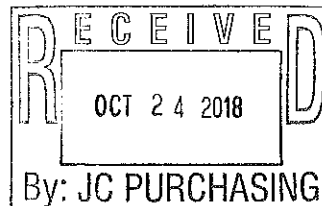

**DETERMINATION OF VALUE CERTIFICATION**

I, Tawana Moody, of full age, hereby certify the following:

1. I am the Director of the Division of Police.
2. The City needs to purchase a covert pole camera.
4. The administration's recommendation is to award a contract to Obsidian Integration, LLC.
6. The cost of the Contract exceeds \$17,500.00.
7. This certification is made pursuant to N.J.S.A. 19:44A-20.5.
8. I certify that the foregoing statements are true. I am aware that if any of the following statements made by me are willfully false, I am subject to legal action to the fullest extent of the law.

Date

10/21/18

*Tawana Moody*  
Tawana Moody, Director  
Division of Police

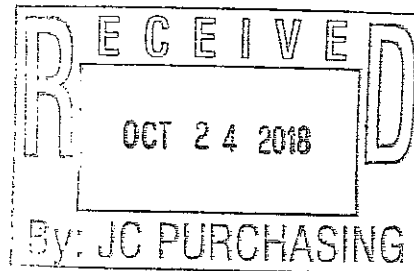

Obsidian Integration LLC

2145 Getty Circle  
 Unit 3  
 Cottage Grove  
 OR 97424

Date	Quote #
8/30/2017	1208

Name / Address
FBI - John Gikas

Item	Description	Terms		
		Qty	Cost	Total
30-0112	10 x 8 x 6 Black Widow Pole Camera: BW-FF-RV50-M50B - RV50 Multi-Carrier Cellular Modem - Canon M50B PTZ Camera - Three "High Voltage" Themed Direct Etched Acrylic Windows - Interior Blackout - Integrated Cell Antennas - Universal Rail System - Modem/Camera Removable Shelves - 802.11 Router - Keyfob Reset - Web Reset - System Power breaker - Adjustable Quickmount - 12' Twist Lock AC Cord - Environmental System	4	8,375.00	33,500.00
Shipping Charges	Shipping Charges: Standard Domestic Ground Shipping Charges Included		0.00	0.00
Expiration Date	Estimate Valid Until:9/30/17			0.00
Thank You! Please contact Chris Anderson with any questions chris@obsidianintegration.com		<b>Total</b> \$33,500.00		
Phone #	541-357-6992	Web Site	www.obsidianintegration.com	

## Louis Strikowsky

---

**From:** Caroleann Fusco <caroleannf@adorama.com>  
**Sent:** Friday, October 12, 2018 11:08 AM  
**To:** Louis Strikowsky  
**Subject:** RE: quote

Thank you for the opportunity! Unfortunately we cannot provide the requested item at this time. Have a great day!

**We offer TOP Dollar for your USED Photographic and Tactical Equipment too!**  
**Ask me about it!!**

[caroleannf@adorama.com](mailto:caroleannf@adorama.com)  
800-223-2500-x2035

---

**From:** Louis Strikowsky [mailto:StrikowskyL@jcnj.org]  
**Sent:** Tuesday, September 18, 2018 4:33 PM  
**To:** Caroleann Fusco  
**Subject:** quote

Request for quote

*Thanks*

**Louis Strikowsky, Buyer**



**City of Jersey City**  
**Division of Purchasing**  
**394 Central Avenue, 3 FLOOR**  
**Jersey City, NJ 07307**  
**Tel: (201) 547-6594**  
**Email: [StrikowskyL@jcnj.org](mailto:StrikowskyL@jcnj.org)**  
**[www.cityofjerseycity.com](http://www.cityofjerseycity.com)**

Click [here](#) to report this email as spam to System Support.



Ensemble Solutions Group  
 180 W San Angelo St  
 Gilbert, AZ 85233  
 contact@ensemblesolutionsgroup.com  
 www.ensemblesolutionsgroup.com



<b>ADDRESS</b>	<b>SHIP TO</b>
Louis Strikowsky	Louis Strikowsky
City of Jersey City	City of Jersey City
394 Central Avenue, 3 FLOOR	394 Central Avenue, 3 FLOOR
Jersey City, NJ 07307	Jersey City, NJ 07307

**ESTIMATE 1189**

**DATE 09/17/2018**

**EXPIRATION DATE 10/19/2018**

**SHIP VIA**  
 Ground

ACTIVITY	QTY	RATE	AMOUNT
10 x 8 x 6 Covert Pole Camera - Outdoor Ready Weatherproof Design - Electrical Utility Cabinet Disguise - RV50 Multi-Carrier Cellular Modem - Canon M50B PTZ Camera - Three "High Voltage" Themed Direct Etched Acrylic Windows - Interior Blackout - Integrated Cell Antennas - Universal Rail System - Modem/Camera Removable Shelves - 802.11 Router - Keyfob Reset - Web Reset - System Power breaker - Adjustable Quickmount - 12' Twist Lock AC Cord - Environmental System	4	8,670.00	34,680.00T

SUBTOTAL 34,680.00  
 TAX 0.00

**TOTAL \$34,680.00**

Accepted By

Accepted Date

NEW JERSEY DEPARTMENT OF THE TREASURY  
DIVISION OF REVENUE AND ENTERPRISE SERVICES

CERTIFICATE OF REGISTRATION  
OBSIDIAN INTEGRATION LLC  
0450306821

*hcc*

The above-named FOREIGN LIMITED LIABILITY COMPANY was duly filed in accordance with New Jersey State Law on 09/18/2018 and was assigned identification number 0450306821. Following are the articles that constitute its original certificate.

1. **Name:**  
OBSIDIAN INTEGRATION LLC
2. **Registered Agent:**  
NORTHWEST REGISTERED AGENT, LLC. *NW Reg.*
3. **Registered Office:**  
FIVE GREENTREE CENTRE, 525 ROUTE 73  
STE 104  
MARLTON, NEW JERSEY 08053
4. **Business Purpose:**  
DESIGN, BUILD AND SALES OF LAW ENFORCEMENT VIDEO SURVEILLANCE EQUIPMENT
5. **Incorporated Under the Laws of:**  
OREGON ON 02/01/2016
6. **Effective Date of this filing is:**  
09/18/2018
7. **Main Business Address:**  
285 CAP COURT  
SPACE 4E  
EUGENE, OREGON 97402

**Signatures:**

CHRISTOPHER ANDERSON  
GENERAL PARTNER

IN TESTIMONY WHEREOF, I have  
hereunto set my hand and  
affixed my Official Seal  
18th day of September, 2018

*Elizabeth Maher Muoio*

Elizabeth Maher Muoio  
State Treasurer

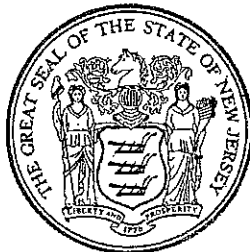

Certificate Number : 4062077375  
Verify this certificate online at

[https://www1.state.nj.us/TYTR\\_StandingCert/JSP/Verify\\_Cert.jsp](https://www1.state.nj.us/TYTR_StandingCert/JSP/Verify_Cert.jsp)

STATE OF NEW JERSEY  
DEPARTMENT OF THE TREASURY  
DIVISION OF REVENUE AND ENTERPRISE SERVICES

SHORT FORM STANDING

OBSIDIAN INTEGRATION LLC  
0450306821

*I, the Treasurer of the State of New Jersey, do hereby certify that the above-named NJ Foreign Limited Liability Company (FLC) was registered by this office on Tuesday, September 18, 2018.*

*As of the date of this certificate, said business continues as an active business in good standing in the State of New Jersey, and its Annual Reports are current.*

*I further certify that the registered agent and registered office are:*

NORTHWEST REGISTERED AGENT, LLC.  
FIVE GREENTREE CENTRE, 525 ROUTE 73  
STE 104  
MARLTON, NEW JERSEY 08053

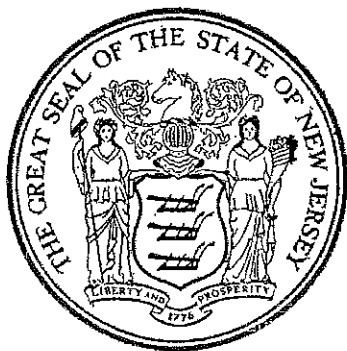

IN TESTIMONY WHEREOF, I have  
hereunto set my hand and  
affixed my Official Seal  
18th day of September, 2018

Elizabeth Maher Muoio  
State Treasurer

Certificate Number : 4062077242  
Verify this certificate online at  
[https://www1.state.nj.us/TYTR\\_StandingCert/JSP/Verify\\_Cert.jsp](https://www1.state.nj.us/TYTR_StandingCert/JSP/Verify_Cert.jsp)

N0000131134  
 5055935  
 08/11/2017  
 Chris Anderson  
 Obsidian Integration LLC  
 ###-###-097/000

08/11/2017  
 2145 Getty Circle  
 Unit 3  
 Cottage Grove OR 97424  
 Chris Anderson  
 2145 Getty Circle  
 Unit 3  
 Cottage Grove OR 97424

1614  
 Manufacturing Overt /  
 Covert Wireless  
 Audio/Video Surveillance  
 Systems

Manufacturing Overt /  
 Covert Wireless  
 Audio/Video Surveillance  
 Systems

3861

334220

0

Out-of-state LLC

December

OR

No

Christopher M Anderson  
 Managing Member (Owns  
 65%)

###-###-9243

2174 Princeton Drive  
 Eugene OR 97405

Andrew M Hostetler  
 Member (Owns 25%)  
 ###-###-7681  
 2511 LARKSPUR LN  
 Sacramento CA 95825

Gerald D Larson  
 Member (Owns 10%)  
 ###-###-9653

DLN  
 Sequence Number  
 Filing Date  
 Authorized Representative  
 Business Name  
 EIN Number  
 Trade Name on Certificate  
 Other Trade Names  
 Date of Registration filing  
 Business Location

Mailing Name and Address

Business Code  
 Principal Product or Service

Principal Activity

Industrial Code  
 NAICS Code  
 Number of Workers  
 Ownership Type  
 Last Month of Fiscal Year  
 State of Incorporation  
 Is a subsidiary  
 Owners

*bpc*

25081 Territorial Ct  
Veneta OR 97487

Chris Anderson  
Managing Member  
chris@obsidianintegration.com  
(541) 357 - 6992

Contact Name  
Title  
Email  
Daytime Phone  
Evening Phone

*Chris  
Anderson*

# C. 271 POLITICAL CONTRIBUTION DISCLOSURE FORM

Required Pursuant To N.J.S.A. 19:44A-20.26

This form or its permitted facsimile must be submitted to the local unit no later than 10 days prior to the award of the contract.

## Part I - Vendor Information

Vendor Name:	Obsidian Interiors LLC		
Address:	285 Cap Ct STE 42		
City:	Pocono	State:	PA
		Zip:	18346

The undersigned being authorized to certify, hereby certifies that the submission provided herein represents compliance with the provisions of N.J.S.A. 19:44A-20.26 and as represented by the instructions accompanying this form.

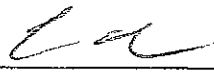
 \_\_\_\_\_  
Signature Printed Name Title  
Chris Anderson Owner

## Part II - Contribution Disclosure

Disclosure requirement: Pursuant to N.J.S.A. 19:44A-20.26 this disclosure must include all reportable political contributions (more than \$300 per election cycle) over the 12 months prior to submission to the committees of the government entities listed on the form provided by the local unit.

Check here if disclosure is provided in electronic form.

Contributor Name	Recipient Name	Date	Dollar Amount
None			\$

Check here if the information is continued on subsequent page(s)

**BUSINESS ENTITY DISCLOSURE CERTIFICATION  
FOR NON-FAIR AND OPEN CONTRACTS  
Required Pursuant To N.J.S.A. 19:44A-20.8  
CITY OF JERSEY CITY**

**Part I – Vendor Affirmation**

The undersigned, being authorized and knowledgeable of the circumstances, does hereby certify that the <name of business entity> has not made and will not make any reportable contributions pursuant to N.J.S.A. 19:44A-1 et seq. that, pursuant to P.L. 2004, c. 19 would bar the award of this contract in the one year period preceding (date of award scheduled for approval of the contract by the governing body) to any of the following named candidate committee, joint candidates committee; or political party committee representing the elected officials of the <name of entity of elected officials> as defined pursuant to N.J.S.A. 19:44A-3(p), (q) and (r).

Steven Fulop for Mayor 2017	Mira Prinz-Arey for Council
Lavarro for Councilman	Friends of Richard Boggiano
Friends of Joyce Watterman	Michael Yun for Council
Friends of Daniel Rivera	Solomon for Council
Ridley for Council	Friends of Jermaine Robinson

**Part II – Ownership Disclosure Certification**

I certify that the list below contains the names and home addresses of all owners holding 10% or more of the issued and outstanding stock of the undersigned.

Check the box that represents the type of business entity:

- Partnership     
  Corporation     
  Sole Proprietorship     
  Subchapter S Corporation  
 Limited Partnership     
 Limited Liability Corporation     
 Limited Liability Partnership

Name of Stock or Shareholder	Home Address
Chris Anderson	2174 Princeton Dr Eugene OR 97405
Gerald D. Larson	25081 Territorial Ct Veneta OR 97487
Andrew Hostetter	6012 Cochran Dr Bakersfield CA 93309

**Part 3 – Signature and Attestation:**

The undersigned is fully aware that if I have misrepresented in whole or part this affirmation and certification, I and/or the business entity, will be liable for any penalty permitted under law.

Name of Business Entity: Obscura Integration LLC  
 Signature of Affiant: [Signature] Title: owner  
 Printed Name of Affiant: Chris Anderson Date: 10-17-18

Subscribed and sworn before me this 17 day of October, 2018.

My Commission expires: 02-13-2021

[Signature]  
 (Witnessed or attested by)  
 \_\_\_\_\_  
 (Seal)

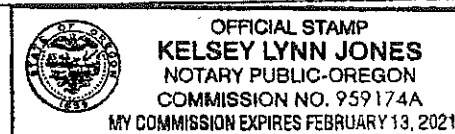

**CERTIFICATION OF COMPLIANCE WITH THE CITY OF JERSEY CITY  
CONTRACTOR PAY-TO-PLAY REFORM ORDINANCE 08-128 ADOPTED  
ON SEPTEMBER 3, 2008**

**PART I - Vendor Affirmation**

The undersigned, being authorized and knowledgeable of the circumstances, does hereby certify that Obsidian Integration LLC (name of business entity) has not made any reportable contributions in the \*\*one-year period preceding 10-17-18 (date City Council awards contract) that would be deemed to be violations of Section One of the City of Jersey City's Contractor Pay-to-Play Reform Ordinance 08-128 (attached hereto) and that would bar the award of this contract. I further certify that during the term of the contract Obsidian Integration LLC (name of business entity) will not make any reportable contributions in violation of Ordinance 08-128.

**PART II - Signature and Attestation:**

The undersigned is fully aware that if I have misrepresented in whole or part this affirmation and certification, I and/or the business entity, will be liable for any penalty permitted under law.

Name of Business Entity: Obsidian Integration LLC

Signed [Signature] Title: owner

Print Name: Chris Anderson Date: 10-17-18

Subscribed and sworn before me  
this 17 day of Oct, 2018.

My Commission expires: 02-13-2021

[Signature]  
(Affiant)  
Kelsey Jones Notary  
(Print name & title of affiant) (Corporate Seal)

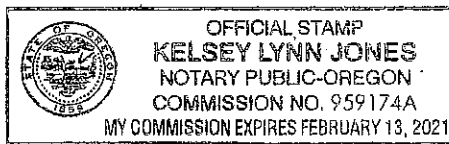

\*\*Pursuant to Section 2 of Ordinance 08-128, no contributions or solicitation of contributions made prior to the effective date Ordinance 08-128 (September 23, 2008) shall be deemed to be a violation of the Ordinance.



EXHIBIT A (Continuation)

The contractor or subcontractor agrees to inform in writing its appropriate recruitment agencies including, but not limited to, employment agencies, placement bureaus, colleges, universities, and labor unions, that it does not discriminate on the basis of age, race, creed, color, national origin, ancestry, marital status, affectional or sexual orientation, gender identity or expression, disability, national origin, sex, and that it will discontinue the use of any recruitment agency which engages in direct or indirect discriminatory practices.

The contractor or subcontractor agrees to revise any of its testing procedures, if necessary, to assure that all personnel testing conforms with the principles of job related testing, as established by the statutes and court decisions of the State of New Jersey and as established by applicable Federal law and applicable Federal court decisions.

In conforming with the larged employment goals, the contractor or subcontractor agrees to review all procedures relating to transfer, upgrading, downgrading and layoff to ensure that all such actions are taken without regard to age, race, creed, color, national origin, ancestry, marital status, affectional or sexual orientation, gender identity or expression, disability, national origin, sex, consistent with the statutes and court decisions of the State of New Jersey, and applicable Federal law and applicable Federal court decisions.

The contractor shall submit to the public agency, after notification of award but prior to execution of a goods and services contract, one of the following three documents:

Letter of Federal Affirmative Action Plan Approval

Certificate of Employee Information Report

Employee Information Report Form AA302 (electronically provided by the Division and distributed to the public agency through the Division's website at [www.state.nj.us/treasury/contract/compliance](http://www.state.nj.us/treasury/contract/compliance))

The contractor and its subcontractors shall furnish such reports or other documents to the Division of Purchase & Property, CCAU, EEO Monitoring Program as may be requested by the office from time to time in order to carry out the purposes of these regulations, and public agencies shall furnish such information as may be requested by the Division of Purchase & Property, CCAU, EEO Monitoring Program for conducting a compliance investigation pursuant to Subchapter 10 of the Administrative Code at N.J.A.C. 17:27.

The undersigned vendor certifies on their company's receipt, knowledge, and consent to comply with:

EXHIBIT A  
N.J.S.A. 10:5-31 and N.J.A.C. 17:27  
MANDATORY EQUAL EMPLOYMENT OPPORTUNITY LANGUAGE  
Goods, Professional Services and General Service Contracts  
(Mandatory Affirmative Action Language)

The undersigned vendor further agrees to furnish the required forms of evidence and

understands that their contract/company's bid shall be rejected as non-responsive if said contractor fails to comply with the requirements of N.J.S.A. 10:5-31 and N.J.A.C. 17:27.

Representative's Name (Print):

Chris Anderson Downer

Representative's Signature:

Name of Company: Obidian Integrations LLC

Date: 10.17.18

Tel. No.: 874-672-2662

**APPENDIX A**  
**AMERICANS WITH DISABILITIES ACT OF 1990**  
**Equal Opportunity for Individuals with Disability**

The contractor and the owner of Obsidian Integration LLC (hereafter "owner") do hereby agree that the provisions of Title 11 of the Americans With Disabilities Act of 1990 (the "Act") (42 U.S.C. 5121 et seq.), which prohibits discrimination on the basis of disability by public entities in all services, programs, and activities provided or made available by public entities, and the rules and regulations promulgated pursuant thereto, are made a part of this contract. In providing any aid, benefit, or services on behalf of the owner pursuant to this contract, the contractor agrees that the performance shall be in strict compliance with the Act. In the event that the contractor, its agents, servants, employees, or subcontractors violate or are alleged to have violated the Act during the performance of this contract, the contractor shall defend the owner in any action or administrative proceeding commenced pursuant to this Act. The contractor shall indemnify, protect, and save harmless the owner, its agents, servants, and employees from and against any and all suits, claims, losses, demands, or damages, of whatever kind or nature, arising out of or claimed to arise out of the alleged violation. The contractor shall, at its own expense, appear, defend, and pay any and all charges for legal services and any and all costs and other expenses arising from such action or administrative proceeding or incurred in connection therewith. In any and all complaints brought pursuant to the owner's grievance procedure, the contractor agrees to abide by any decision of the owner which is rendered pursuant to said grievance procedure. If any action or administrative proceeding results in an award of damages against the owner, or if the owner incurs any expense to cure a violation of the ADA which has been brought pursuant to its grievance procedure, the contractor shall satisfy and discharge the same at its own expense.

The owner shall, as soon as practicable after a claim has been made against it, give written notice thereof to the contractor along with full and complete particulars of the claim. If any action or administrative proceeding is brought against the owner or any of its agents, servants, and employees, the owner shall expeditiously forward or have forwarded to the contractor every demand, complaint, notice, summons, pleading, or other process received by the owner or its representatives.

It is expressly agreed and understood that any approval by the owner of the services provided by the contractor pursuant to this contract will not relieve the contractor of the obligation to comply with the Act and to defend, indemnify, protect, and save harmless the owner pursuant to this paragraph.

It is further agreed and understood that the owner assumes no obligation to indemnify or save harmless the contractor, its agents, servants, employees and subcontractors for any claim which may arise out of their performance of this Agreement. Furthermore, the contractor expressly understands and agrees that the provisions of this indemnification clause shall in no way limit the contractor's obligations assumed in this Agreement, nor shall they be construed to relieve the contractor from any liability, nor preclude the owner from taking any other actions available to it under any other provisions of the Agreement or otherwise at law.

Representative's Name/Title (Print): Chris Anderson / owner  
Representative's Signature: [Signature]  
Name of Company: Obsidian Integration LLC  
Tel. No.: 844-672-2662 Date: 10-17-18

**STATE OF NEW JERSEY**  
Division of Purchase & Property  
Contract Compliance Audit Unit  
EEO Monitoring Program

**EMPLOYEE INFORMATION REPORT**

IMPORTANT-READ INSTRUCTIONS CAREFULLY BEFORE COMPLETING FORM. FAILURE TO PROPERLY COMPLETE THE ENTIRE FORM AND TO SUBMIT THE REQUIRED \$150.00 FEE MAY DELAY ISSUANCE OF YOUR CERTIFICATE. DO NOT SUBMIT EEO-1 REPORT FOR SECTION B, ITEM 11. For Instructions on completing the form, go to: <http://www.state.nj.gov/eop/contract/compliance/audit/eo1rpt.pdf>

**SECTION A - COMPANY IDENTIFICATION**

1. FID. NO. OR SOCIAL SECURITY	2. TYPE OF BUSINESS <input checked="" type="checkbox"/> 1. MFG <input type="checkbox"/> 2. SERVICE <input type="checkbox"/> 3. WHOLESALE <input type="checkbox"/> 4. RETAIL <input type="checkbox"/> 5. OTHER	3. TOTAL NO. EMPLOYEES IN THE ENTIRE COMPANY  5
4. COMPANY NAME Obsidian Integration LLC		
5. STREET 285 Cap Ct STE 4E	CITY Eugene	COUNTY Lane
	STATE Or	ZIP CODE 97402
6. NAME OF PARENT OR AFFILIATED COMPANY (IF NONE, SO INDICATE)		
7. CHECK ONE: IS THE COMPANY: <input checked="" type="checkbox"/> SINGLE-ESTABLISHMENT EMPLOYER <input type="checkbox"/> MULTI-ESTABLISHMENT EMPLOYER		
8. IF MULTI-ESTABLISHMENT EMPLOYER, STATE THE NUMBER OF ESTABLISHMENTS IN NJ <input type="text" value="0"/>		
9. TOTAL NUMBER OF EMPLOYEES AT ESTABLISHMENT WHICH HAS BEEN AWARDED THE CONTRACT <input type="text" value="5"/>		
10. PUBLIC AGENCY AWARDED CONTRACT		
	CITY City of Jersey City	COUNTY Hudson
	STATE NJ	ZIP CODE 07302
Official Use Only	DATE RECEIVED	ASSIGNED CERTIFICATION NUMBER

**SECTION B - EMPLOYMENT DATA**

11. Report all permanent, temporary and part-time employees ON YOUR OWN PAYROLL. Enter the appropriate figures on all lines and in all columns. Where there are no employees in a particular category, enter a zero. Include ALL employees, not just those in minority/non-minority categories, in columns 1, 2, & 3. **DO NOT SUBMIT AN EEO-1 REPORT.**

JOB CATEGORIES	ALL EMPLOYEES			PERMANENT MINORITY/NON-MINORITY EMPLOYEE BREAKDOWN										
	COL. 1 TOTAL (Cols. 2 & 3)	COL. 2 MALE	COL. 3 FEMALE	***** MALE *****					***** FEMALE *****					
				BLACK	HISPANIC	AMER. INDIAN	ASIAN	NON MIN.	BLACK	HISPANIC	AMER. INDIAN	ASIAN	NON MIN.	
Officials/ Managers	2	2						2						
Professionals														
Technicians														
Sales Workers														
Office & Clerical	1		1											1
Craftworkers (Skilled)	2	2						2						
Operatives (Semi-skilled)														
Laborers (Unskilled)														
Service Workers														
<b>TOTAL</b>	5	4	1					4						1
Total employment From previous Report (if any)														
Temporary & Part-Time Employees	The data below shall NOT be included in the figures for the appropriate categories above.													

12. HOW WAS INFORMATION AS TO RACE OR ETHNIC GROUP IN SECTION B OBTAINED? <input checked="" type="checkbox"/> 1. Visual Survey <input type="checkbox"/> 2. Employment Record <input type="checkbox"/> 3. Other (Specify)	14. IS THIS THE FIRST Employee Information Report Submitted? 1. YES <input checked="" type="checkbox"/> 2. NO <input type="checkbox"/>	15. IF NO, DATE LAST REPORT SUBMITTED MO. DAY YEAR JJ
13. DATES OF PAYROLL PERIOD USED From: 10/01/18    To: 10/15/18		

**SECTION C - SIGNATURE AND IDENTIFICATION**

16. NAME OF PERSON COMPLETING FORM (Print or Type) Chris Anderson	SIGNATURE 	TITLE Owner	DATE MO   DAY   YEAR 10   22   2018
17. ADDRESS NO. & STREET 285 Cap Ct STE 4E	CITY Eugene	COUNTY Lane	STATE Or
	ZIP CODE 97402	PHONE (AREA CODE, NO., EXTENSION) 844 - 672 - 2662	

**Minority/Woman Business Enterprise (MWBE)  
Questionnaire for Bidders**

Jersey City Ordinance C-829 establishes a goal of awarding 20% of the dollar amount of total city procurement to minority and woman owned business enterprises.

To assist us in monitoring our achievement of this goal, please indicate below whether your company is or is not a minority owned and/or woman owned business, and return this form with your bid proposal.

Business Name : Obsidian Integration LLC  
Address : 285 Cap Ct STE 4E Eugene OR 97402  
Telephone No. : 844-672-2662  
Contact Name : Chris Anderson

Please check applicable category :

- |  |   |
|--|---|
| <input type="checkbox"/> Minority Owned Business (MBE) | <input type="checkbox"/> Minority & Woman Owned Business (MWBE) |
| <input type="checkbox"/> Woman Owned business (WBE)    | <input checked="" type="checkbox"/> Neither                     |

**Definitions**

**Minority Business Enterprise**

Minority Business Enterprise means a business which is a sole proprietorship, partnership or corporation at least 51% of which is owned and controlled by persons who are African American, Hispanic, Asian American, American Indian or Alaskan native, defined as follows:

- African American: a person having origins in any of the black racial groups of Africa
- Hispanic: a person of Mexican, Puerto Rican, Central or South American or other non-European Spanish culture or origin regardless of race.
- Asian: a person having origins in any of the original peoples of the Far East, South East Asia, Indian subcontinent, Hawaii or the Pacific Islands.
- American Indian or Alaskan Native: a person having origins in any of the original peoples of North America and who maintains cultural identification through tribal affiliation or community recognition.

**Woman Business Enterprise**

Woman Business Enterprise means a business which is a sole proprietorship, partnership or corporation at least 51% of which is owned and controlled by a woman or women.

Minority/Woman Business Enterprise (MWBE)  
Questionnaire for Bidders

Jersey City Ordinance C-829 establishes a goal of awarding 20% of the dollar amount of total city procurement to minority and woman owned business enterprises.

To assist us in monitoring our achievement of this goal, please indicate below whether your company is or is not a minority owned and/or woman owned business, and return this form with your bid proposal.

Business Name: Obsidian Integration LLC  
Address: 785 Cap Ct STE 4E Eugene, OR 97402  
Telephone No.: 844-672-2662  
Contact Name: Chris Anderson

Please check applicable category:

Minority Owned Business (MBE)       Minority & Woman Owned Business (MWBE)  
 Woman Owned business (WBE)       Neither

**Definitions**

**Minority Business Enterprise**

Minority Business Enterprise means a business which is a sole proprietorship, partnership or corporation at least 51% of which is owned and controlled by persons who are African American, Hispanic, Asian American, American Indian or Alaskan native, defined as follows:

**African American:** a person having origins in any of the black racial groups of Africa

**Hispanic:** a person of Mexican, Puerto Rican, Central or South American or other non-European Spanish culture or origin regardless of race.

**Asian:** a person having origins in any of the original peoples of the Far East, South East Asia, Indian subcontinent, Hawaii or the Pacific Islands.

**American Indian or Alaskan Native:** a person having origins in any of the original peoples of North America and who maintains cultural identification through tribal affiliation or community recognition.

**Woman Business Enterprise**

Woman Business Enterprise means a business which is a sole proprietorship, partnership or corporation at least 51% of which is owned and controlled by a woman or women.

DIVISION OF PURCHASING COPY

# Resolution of the City of Jersey City, N.J.

City Clerk File No. Res. 18-987

Agenda No. 10.Z.2

Approved: NOV 07 2018



TITLE:

**RESOLUTION AUTHORIZING THE AWARD OF A CONTRACT TO AAA EMERGENCY SUPPLY COMPANY INC. FOR THE PURCHASE AND DELIVERY OF FIRE HOSES FOR THE DEPARTMENT OF PUBLIC SAFETY, DIVISION OF FIRE**

## **COUNCIL OFFERED AND MOVED ADOPTION OF THE FOLLOWING RESOLUTION:**

**WHEREAS**, the purchase of fire hoses is to fill the needs within the Fire Division. First, to replace damaged and outdated hoses. Secondly, to supply our new need for high pressure hoses for high-rise operations; and

**WHEREAS**, AAA Emergency Supply Company Inc. submitted a quote in the amount of thirty eight thousand, five hundred twenty nine dollars (\$38,529.00); and

**WHEREAS**, the Purchasing Agent certifies that it is impracticable to solicit any further quotes for hoses as AAA Emergency Supply Company Inc. is the authorized Key Hose distributor in Northern New Jersey, supplying the exact fire hoses that meet the NFPA requirements, and the needs of the Fire Division; and

**WHEREAS**, the Purchasing Director believes the proposal of Contractor attached hereto, to be most advantageous, price and other factors considered; and

**WHEREAS**, the City is acquiring these services directly and openly as a statutorily permitted contract pursuant to the provisions of N.J.S.A. 19:44A-20.5 et seq. (Pay-to-Play Law); and

**WHEREAS**, the Director of the Fire Division has determined and certified in writing that the value of the contract will exceed \$17,500.00; and

**WHEREAS**, the Contractor has completed and submitted a Business Entity Disclosure Certification which certifies that the Contractor has not made any reportable contributions to the political candidate committees listed in the Business Entity Disclosure Certification in the previous one year, and that the contract will prohibit the Contractor from making any reportable contributions during the term of the contract; and

**WHEREAS**, the Contractor has submitted a Chapter 271 Political Contribution Disclosure Certification at least 10 days prior to the award of this contract; and

**WHEREAS**, the Contractor has submitted its Certification of Compliance with the City's Contractor Pay-to-Play Reform Ordinance 08-128 adopted on September 3, 2008; and

**WHEREAS**, funds are available for this contract in the Operating Account;

<b>Account</b>	<b>PO #</b>	<b>Total Contract</b>
01-201-25-265-413	131024	\$38,529.00

**NOW, THEREFORE BE IT RESOLVED**, by the Municipal Council of the City of Jersey City that:

1. A contract award to AAA Emergency Supply Company Inc. in the amount of \$38,529.00 for the purchase of fire hoses is authorized.
2. The term of the contract will be completed upon the delivery of the goods or services.
3. Upon certification by an official or employee of the City authorized to administer the contract, the services have been performed and that the requirements of the contract met, then payment to the Contractor shall be made in accordance with the Local Fiscal Affairs Law, N.J.S.A. 40A:5-1 et seq.; and

City Clerk File No. Res. 18-987  
Agenda No. 10.Z.2 NOV 07 2018

TITLE:

**RESOLUTION AUTHORIZING THE AWARD OF A CONTRACT TO AAA EMERGENCY SUPPLY COMPANY INC. FOR THE PURCHASE AND DELIVERY OF FIRE HOSES FOR THE DEPARTMENT OF PUBLIC SAFETY, DIVISION OF FIRE**

4. The Business Entity Disclosure Certification, Chapter 271 Political Contribution Disclosure Certification, the Certification of Compliance with the City's Contractor Pay-to-Play Reform Ordinance, and the Determination of Value Certification, attached hereto, shall be placed on file with this resolution.

Donna Mauer, Donna Mauer, Chief Financial Officer, certify that there are sufficient funds available for payment of this above resolution..

Account                      PO #                      Total Contract  
01-201-25-265-413        131024                    \$38,529.00

Approved by: Peter Folgado  
Peter Folgado, Director of Purchasing,  
QPA, RPPO

10/24/18  
Date

PF/pv  
10/23/18  
JMcK  
10/26/18

APPROVED: \_\_\_\_\_

APPROVED AS TO LEGAL FORM

APPROVED: [Signature]  
Business Administrator

[Signature]  
Corporation Counsel

Certification Required   
Not Required

APPROVED 8-0

RECORD OF COUNCIL VOTE ON FINAL PASSAGE 11.7.18											
COUNCILPERSON	AYE	NAY	N.V.	COUNCILPERSON	AYE	NAY	N.V.	COUNCILPERSON	AYE	NAY	N.V.
RIDLEY	✓			YUN	✓			RIVERA	✓		
PRINZ-AREY	✓			SOLOMON	✓			WATTERMAN	ABSENT		
BOGGIANO	✓			ROBINSON	✓			LAVARRO, PRES	✓		

✓ Indicates Vote

N.V.-Not Voting (Abstain)

Adopted at a meeting of the Municipal Council of the City of Jersey City N.J.

[Signature]  
Rolando R. Lavarro, Jr., President of Council

[Signature]  
Robert Byrne, City Clerk

**RESOLUTION FACT SHEET – CONTRACT AWARD**

This summary sheet is to be attached to the front of any resolution that is submitted for Council consideration. Incomplete or vague fact sheets will be returned with the resolution.

**Full Title of Ordinance/Resolution**

**RESOLUTION AUTHORIZING THE AWARD OF A CONTRACT TO AAA EMERGENCY SUPPLY COMPANY INC. FOR THE PURCHASE AND DELIVERY OF FIRE HOSES FOR THE DEPARTMENT OF PUBLIC SAFETY, DIVISION OF FIRE**

**Initiator**

Department/Division	Public Safety	Division of Fire
Name/Title	Steven McGill	Chief of the Department
Phone/email	201-547-4262	smcgill@njjepps.org

Note: Initiator must be available by phone during agenda meeting (Wednesday prior to council meeting @ 4:00 p.m.)

**Resolution Purpose**

This purchase of fire hose is to fill the needs within the Department of Public Safety/Division of Fire. First, to replace damaged and outdated hose. Secondly, to supply our new need for high pressure hose for high-rise operations. Lastly, to replenish spare hose kept within fire house locations.

I certify that all the facts presented herein are accurate.

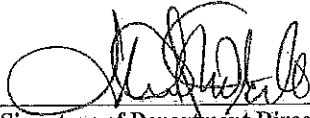
  
\_\_\_\_\_  
Signature of Department Director

10/23/18  
Date

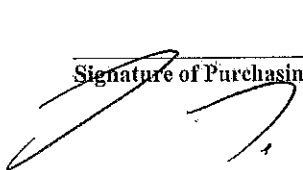
  
\_\_\_\_\_  
Signature of Purchasing Director

10/24/18  
Date



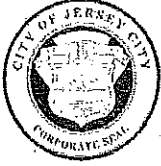

CITY OF JERSEY CITY  
DEPARTMENT OF PUBLIC SAFETY

PUBLIC SAFETY | 465 MARIN BOULEVARD | JERSEY CITY, NJ 07302  
P: 201 547 4239 | F: 201 547 5298



*MEMORANDUM*

---

**To:** Peter Folgado, Director of Purchasing  
**From:** Deputy Chief Henry DiGuilio, Executive Officer, Fire Headquarters  
**Date:** October 10, 2018  
**Subject:** Key Hose Purchases

---

It is important that when we purchase fire hose for suppression we use a vendor that not only supplies the product, but also warranties, replaces and repairs when necessary. Our current fire hose supplier is AAA Emergency Supply and has provided exceptional customer service for all our needs. AAA is in Jersey City at least three times a week seeing to our needs. The use of any other vendor will not guarantee the same quality of service the Department of Public Safety/Division of Fire requires on a daily basis.



*"The Hose Company"*

October 15, 2018

Deputy Chief Henry DiGuilio  
Jersey City Fire Department  
Jersey City, NJ

Dear Chief DiGuilio,

This correspondence serves to advise that AAA Emergency is the authorized Key Hose distributor of Key Hose products in northern New Jersey, including Jersey City. If I can provide further assistance please contact me at your earliest convenience.

Sincerely,  
Roger McCardell

**Roger McCardell**  
Regional Sales Manager  
Key Fire Hose  
313 Elkton Blvd.  
Elkton, MD 21921  
(443) 252-7946  
[rmccardell@keyhose.com](mailto:rmccardell@keyhose.com)



*"The Hose Company"*

[www.keyfire.com](http://www.keyfire.com)

---

Mailing Address: PO Box 7107 Dothan AL 36302\*Corporate Office 2926 Columbia Highway  
Dothan AL 36303

Tel: (334) 671-5532 - (800) 447-5666 Accounts Receivable Direct Fax: (334) 671-5601 - (800) 447-5664



# AAA Emergency Supply

635 North Broadway  
 White Plains, NY 10603  
 Ph. (845)570-7278 Fax (973) 749-6658  
 kevink@aaaemergency.com

Quote No.

## QUOTATION

### Customer

Dept Jersey City Fire Department  
 Attn Deputy Chief Digulio  
 City Jersey City State NJ ZIP \_\_\_\_\_  
 Phone hdigulio@njicps.org

Date October 5, 2018  
 Quote KEY HOSE  
 Rep KEVIN KHEL  
 FOB Server

Qty		Unit Price	TOTAL
40	Key - DP25-800-50 2.5" NYC Couplings WHITE Big 10 50FT	\$164.00	\$6,560.00
75	Key -DP20-1000-50 WHITE (Red & Blue Stripes) Conibat Ready 2" Double Jacket w 1.5" NST Couplings	\$263.00	\$19,725.00
6	Key -DP30-1200R-50-ARN 3" x 50FT 650LB Service, 580 Working Super High Pressure Hose w/ 2.5" NYC Corp Coupling RED	\$1,059.00	\$6,354.00
10	Key DP50-600 5" Storz ORANGE ECO 10 100FT 300psi (S70 Additional Per Length Red Head Coupling Storz Connection)  ALL HOSE STENCILED JCFD	\$589.00	\$5,890.00
INCLUDES DIRECT SHIPPING & DELIVERY			
			\$38,529.00

QUOTATION VALID FOR 90 DAYS

FIRE EQUIPMENT SPECIALISTS

## Louis Strikowsky

---

**From:** Kevin Kiel <kevink@aaaemergency.com>  
**Sent:** Friday, October 12, 2018 2:09 PM  
**To:** Louis Strikowsky  
**Subject:** Re: letter

He has two to send. I have not received it yet

Kevin W. Kiel  
AAA Emergency Supply  
201-704-3444  
[Kevink@aaaemergency.com](mailto:Kevink@aaaemergency.com)

On Oct 12, 2018, at 1:48 PM, Louis Strikowsky <[StrikowskyL@jcnj.org](mailto:StrikowskyL@jcnj.org)> wrote:

Any news on the letter from key hose

*Thanks*

**Louis Strikowsky, Buyer**  
<image001.png>City of Jersey City  
**Division of Purchasing**  
**394 Central Avenue, 3 FLOOR**  
**Jersey City, NJ 07307**  
**Tel: (201) 547-6594**  
**Email: [StrikowskyL@jcnj.org](mailto:StrikowskyL@jcnj.org)**  
**[www.cityofjerseycity.com](http://www.cityofjerseycity.com)**



## STATE OF NEW JERSEY BUSINESS REGISTRATION CERTIFICATE

**Taxpayer Name:** AAA EMERGENCY SUPPLY CO., INC.

**Trade Name:**

**Address:** 635 NORTH BROADWAY  
WHITE PLAINS, NY 10603-2408

**Certificate Number:** 1084658

**Effective Date:** September 03, 2004

**Date of Issuance:** October 23, 2018

**For Office Use Only:**

20181023133556961

**CERTIFICATION OF COMPLIANCE WITH THE CITY OF JERSEY CITY  
CONTRACTOR PAY-TO-PLAY REFORM ORDINANCE 08-128 ADOPTED  
ON SEPTEMBER 3, 2008**

**PART I - Vendor Affirmation**

The undersigned, being authorized and knowledgeable of the circumstances, does hereby certify that AAA Emergency Supply (name of business entity) has not made any reportable contributions in the one year period preceding August 2018 (date City Council awards contract) that would be deemed to be violations of Section One of the City of Jersey City's Contractor Pay-to-Play Reform Ordinance 08-128 (attached hereto) and that would bar the award of this contract. I further certify that during the term of the contract AAA Emergency Supply Co Inc (name of business entity) will not make any reportable contributions in violation of Ordinance 08-128.

**PART II - Signature and Attestation:**

The undersigned is fully aware that if I have misrepresented in whole or part this affirmation and certification, I and/or the business entity, will be liable for any penalty permitted under law.

Name of Business Entity: AAA Emergency Supply Co Inc.

Signed: Matthew Dugan Title: Manager

Print Name: Matthew Dugan Date: 8/17/18

Subscribed and sworn before me  
this 1 day of Aug, 2018.

My Commission expires:

Matthew Dugan  
(Affiant)  
Matthew Dugan, Manager  
(Print name & title of affiant) (Corporate Seal)

Stephen A. Rossi  
**STEPHEN A. ROSSI  
NOTARY PUBLIC, STATE OF NEW YORK  
REGISTRATION NUMBER: 01RO6029660  
QUALIFIED IN WESTCHESTER COUNTY  
COMMISSION EXPIRES MARCH 8, 20 19**

\*\*Pursuant to Section 2 of Ordinance 08-128, no contributions or solicitation of contributions made prior to the effective date Ordinance 08-128 (September 23, 2008) shall be deemed to be a violation of the Ordinance.

# C. 271 POLITICAL CONTRIBUTION DISCLOSURE FORM

Required Pursuant To N.J.S.A. 19:44A-20.26

This form or its permitted facsimile must be submitted to the local unit no later than 10 days prior to the award of the contract.

## Part I - Vendor Information

Vendor Name:	AAA Emergency Supply Co. Inc		
Address:	635 North Broadway		
City:	White Plains	State:	NY
		Zip:	10603

The undersigned being authorized to certify, hereby certifies that the submission provided herein represents compliance with the provisions of N.J.S.A. 19:44A-20.26 and as represented by the Instructions accompanying this form.

  
Signature

Matthew Sugar  
Printed Name

Manager  
Title

## Part II - Contribution Disclosure

Disclosure requirement: Pursuant to N.J.S.A. 19:44A-20.26 this disclosure must include all reportable political contributions (more than \$300 per election cycle) over the 12 months prior to submission to the committees of the government entities listed on the form provided by the local unit.

Check here if disclosure is provided in electronic form.

Contributor Name	Recipient Name	Date	Dollar Amount \$
<del>N/A</del>			

Check here if the information is continued on subsequent page(s)

**BUSINESS ENTITY DISCLOSURE CERTIFICATION**  
**FOR NON-FAIR AND OPEN CONTRACTS**  
 Required Pursuant To N.J.S.A. 19:44A-20.8  
**CITY OF JERSEY CITY**

**Part I - Vendor Affirmation**

The undersigned, being authorized and knowledgeable of the circumstances, does hereby certify that the <name of business entity> has not made and will not make any reportable contributions pursuant to N.J.S.A. 19:44A-1 et seq. that, pursuant to P.L. 2004, c. 19 would bar the award of this contract in the one year period preceding (date of award scheduled for approval of the contract by the governing body) to any of the following named candidate committee, joint candidates committee; or political party committee representing the elected officials of the <name of entity of elected officials> as defined pursuant to N.J.S.A. 19:44A-3(p), (s) and (v).

Steven Fulop for Mayor 2017	Mira Prinz-Arey for Council
Lavarro for Councilman	Friends of Richard Boggiano
Friends of Joyce Watterman	Michael Yun for Council
Friends of Daniel Rivera	Solomon for Council
Ridley for Council	Friends of Jermaine Robinson

**Part II - Ownership Disclosure Certification**

I certify that the list below contains the names and home addresses of all owners holding 10% or more of the issued and outstanding stock of the undersigned.

Check the box that represents the type of business entity:

- Partnership     
  Corporation     
  Sole Proprietorship     
  Subchapter S Corporation  
 Limited Partnership     
  Limited Liability Corporation     
  Limited Liability Partnership

Name of Stock or Shareholder	Home Address
Matthew Mastroti	33 Rock Cliff Place North White Plains, NY 10603

**Part 3 - Signature and Attestation:**

The undersigned is fully aware that if I have misrepresented in whole or part this affirmation and certification, I and/or the business entity, will be liable for any penalty permitted under law.

Name of Business Entity: AAA Emergency Supply Co. Inc  
 Signature of Affiant: [Signature] Title: Manager  
 Printed Name of Affiant: Matthew Dugan Date: 8/1/18

Subscribed and sworn before me this 1 day of August, 2018

My Commission expires: \_\_\_\_\_

[Signature]  
 (Witnessed or attested by)  
 \_\_\_\_\_  
 (Seal)

**STEPHEN A. ROSSI**  
**NOTARY PUBLIC, STATE OF NEW YORK**  
**REGISTRATION NUMBER: 01RO6020660**  
**QUALIFIED IN WESTCHESTER COUNTY**  
**COMMISSION EXPIRES MARCH 8, 2019**

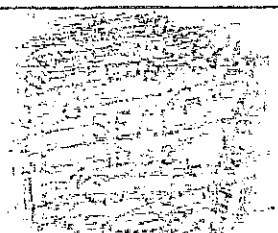



# CERTIFICATE OF EMPLOYEE INFORMATION REPORT RENEWAL

This is to certify that the contractor listed below has submitted an Employee Information Report pursuant to N.J.A.C. 17:27-1.1 et. seq. and the State Treasurer has approved said report. This approval will remain in effect for the period of **15-MAR-2016** to **15-MAR-2023**

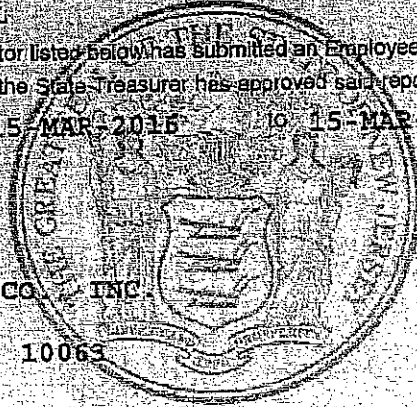

**AAA EMERGENCY SUPPLY CO., INC.**  
**635 NORTH BROADWAY**  
**WHITE PLAINS NY 10063**



*Ford M. Scudder*  
**FORD M. SCUDDER**  
Acting State Treasurer.

APPENDIX A  
AMERICANS WITH DISABILITIES ACT OF 1990  
Equal Opportunity for Individuals with Disability

The contractor and the Agency of AAA Emergency Supply (hereafter "owner") do hereby agree that the provisions of Title 11 of the Americans With Disabilities Act of 1990 (the "Act") (42 U.S.C. 5121 01 et seq.), which prohibits discrimination on the basis of disability by public entities in all services, programs, and activities provided or made available by public entities, and the rules and regulations promulgated pursuant thereto, are made a part of this contract. In providing any aid, benefit, or service on behalf of the owner pursuant to this contract, the contractor agrees that the performance shall be in strict compliance with the Act. In the event that the contractor, its agents, servants, employees, or subcontractors violate or are alleged to have violated the Act during the performance of this contract, the contractor shall defend the owner in any action or administrative proceeding commenced pursuant to this Act. The contractor shall indemnify, protect, and save harmless the owner, its agents, servants, and employees from and against any and all suits, claims, losses, demands, or damages, of whatever kind or nature, arising out of or claimed to arise out of the alleged violation. The contractor shall, at its own expense, appear, defend, and pay any and all charges for legal services and any and all costs and other expenses arising from such action or administrative proceeding or incurred in connection therewith. In any and all complaints brought pursuant to the owner's grievance procedure, the contractor agrees to abide by any decision of the owner which is rendered pursuant to said grievance procedure. If any action or administrative proceeding results in an award of damages against the owner, or if the owner incurs any expense to cure a violation of the ADA which has been brought pursuant to its grievance procedure, the contractor shall satisfy and discharge the same at its own expense.

The owner shall, as soon as practicable after a claim has been made against it, give written notice thereof to the contractor along with full and complete particulars of the claim. If any action or administrative proceeding is brought against the owner or any of its agents, servants, and employees, the owner shall expeditiously forward or have forwarded to the contractor every demand, complaint, notice, summons, pleading, or other process received by the owner or its representatives.

It is expressly agreed and understood that any approval by the owner of the services provided by the contractor pursuant to this contract will not relieve the contractor of the obligation to comply with the Act and to defend, indemnify, protect, and save harmless the owner pursuant to this paragraph.

It is further agreed and understood that the owner assumes no obligation to indemnify or save harmless the contractor, its agents, servants, employees and subcontractors for any claim which may arise out of their performance of this Agreement. Furthermore, the contractor expressly understands and agrees that the provisions of this indemnification clause shall in no way limit the contractor's obligations assumed in this Agreement, nor shall they be construed to relieve the contractor from any liability, nor preclude the owner from taking any other actions available to it under any other provisions of the Agreement or otherwise at law.

Representative's Name/Title Print: Matthew Dugan, Manager  
Representative's Signature: [Signature]  
Name of Company: AAA Emergency Supply Co. Inc  
Tel. No.: \_\_\_\_\_ Date: \_\_\_\_\_

914-949-0512

8/11/87

**EXHIBIT A (Continuation)**

The contractor or subcontractor agrees to inform in writing its appropriate recruitment agencies including, but not limited to, employment agencies, placement bureaus, colleges, universities, and labor unions, that it does not discriminate on the basis of age, race, creed, color, national origin, ancestry, marital status, affectional or sexual orientation, gender identity or expression, disability, nationality or sex, and that it will discontinue the use of any recruitment agency which engages in direct or indirect discriminatory practices.

The contractor or subcontractor agrees to revise any of its testing procedures, if necessary, to assure that all personnel testing conforms with the principles of job related testing, as established by the statutes and court decisions of the State of New Jersey and as established by applicable Federal law and applicable Federal court decisions.

In conforming with the targeted employment goals, the contractor or subcontractor agrees to review all procedures relating to transfer, upgrading, downgrading and layoff to ensure that all such actions are taken without regard to age, race, creed, color, national origin, ancestry, marital status, affectional or sexual orientation, gender identity or expression, disability, nationality or sex, consistent with the statutes and court decisions of the State of New Jersey, and applicable Federal law and applicable Federal court decisions.

The contractor shall submit to the public agency, after notification of award but prior to execution of a goods and services contract, one of the following three documents:

Letter of Federal Affirmative Action Plan Approval

Certificate of Employee Information Report

Employee Information Report Form AA302 (electronically provided by the Division and distributed to the public agency through the Division's website at [www.state.nj.us/treasury/contract/compliance](http://www.state.nj.us/treasury/contract/compliance))

The contractor and its subcontractors shall furnish such reports or other documents to the Division of Purchase & Property, CCAU, EEO Monitoring Program as may be requested by the office from time to time in order to carry out the purposes of these regulations, and public agencies shall furnish such information as may be requested by the Division of Purchase & Property, CCAU, EEO Monitoring Program for conducting a compliance investigation pursuant to Subchapter 10 of the Administrative Code at N.J.A.C. 17:27.

The undersigned vendor certifies on their company's receipt, knowledge and commitment to comply with:

**EXHIBIT A**  
N.J.S.A. 10:5-31 and N.J.A.C. 17:27  
**MANDATORY EQUAL EMPLOYMENT OPPORTUNITY LANGUAGE**  
Goods, Professional Services and General Service Contracts  
(Mandatory Affirmative Action Language)

The undersigned vendor further agrees to furnish the required forms of evidence and

understands that their contract/company's bid shall be rejected as non-responsive if said contractor fails to comply with the requirements of N.J.S.A. 10:5-31 and N.J.A.C. 17:27.

Representative's Name/Title (Print):

Representative's Signature:

Name of Company:

Tel. No.:

Date:

914-949-0512

8/1/18

Matthew Dusa, Manager  
AAA Emergency Supply Co. Inc

**Minority/Woman Business Enterprise (MWBE)  
Questionnaire for Bidders**

Jersey City Ordinance C-829 establishes a goal of awarding 20% of the dollar amount of total city procurement to minority and woman owned business enterprises.

To assist us in monitoring our achievement of this goal, please indicate below whether your company is or is not a minority owned and/or woman owned business, and return this form with your bid proposal.

Business Name : AAA Emergency Supply Co. Inc  
Address : 635 North Broadway, White Plains NY  
Telephone No. : 914-949-0512 10603  
Contact Name : Maureen Dugan

Please check applicable category :

Minority Owned Business (MBE)       Minority & Woman Owned Business (MWBE)  
 Woman Owned business (WBE)       Neither

**Definitions**

**Minority Business Enterprise**

Minority Business Enterprise means a business which is a sole proprietorship, partnership or corporation at least 51% of which is owned and controlled by persons who are African American, Hispanic, Asian American, American Indian or Alaskan native, defined as follows:

**African American:** a person having origins in any of the black racial groups of Africa

**Hispanic:** a person of Mexican, Puerto Rican, Central or South American or other non-European Spanish culture or origin regardless of race.

**Asian:** a person having origins in any of the original peoples of the Far East, South East Asia, Indian subcontinent, Hawaii or the Pacific Islands.

**American Indian or Alaskan Native:** a person having origins in any of the original peoples of North America and who maintains cultural identification through tribal affiliation or community recognition.

**Woman Business Enterprise**

Woman Business Enterprise means a business which is a sole proprietorship, partnership or corporation at least 51% of which is owned and controlled by a woman or women.

**OFFICE OF EQUAL OPPORTUNITY COPY**

Minority/Woman Business Enterprise (MWBE)  
Questionnaire for Bidders

Jersey City Ordinance C-829 establishes a goal of awarding 20% of the dollar amount of total city procurement to minority and woman owned business enterprises.

To assist us in monitoring our achievement of this goal, please indicate below whether your company is or is not a minority owned and/or woman owned business, and return this form with your bid proposal.

Business Name: AAA Emergency Supply Co. Inc  
Address: 635 North Broadway, White Plains NY  
Telephone No.: 914-949-0512 10603  
Contact Name: Matthew Dugan

Please check applicable category:

Minority Owned Business (MBE)

Minority & Woman Owned  
Business (MWBE)

Woman Owned business (WBE)

Neither

Definitions

Minority Business Enterprise

Minority Business Enterprise means a business which is a sole proprietorship, partnership or corporation at least 51% of which is owned and controlled by persons who are African American, Hispanic, Asian American, American Indian or Alaskan native, defined as follows:

African American: a person having origins in any of the black racial groups of Africa

Hispanic: a person of Mexican, Puerto Rican, Central or South American or other non-European Spanish culture or origin regardless of race.

Asian: a person having origins in any of the original peoples of the Far East, South East Asia, Indian subcontinent, Hawaii or the Pacific Islands.

American Indian or Alaskan Native: a person having origins in any of the original peoples of North America and who maintains cultural identification through tribal affiliation or community recognition.

Woman Business Enterprise

Woman Business Enterprise means a business which is a sole proprietorship, partnership or corporation at least 51% of which is owned and controlled by a woman or women.

DIVISION OF PURCHASING COPY

## DETERMINATION OF VALUE CERTIFICATION

I, Steven McGill, of full age, hereby certify the following:

1. I am the Chief of the Fire Department for the City of Jersey City.
2. The City needs to replace its fire hoses.
3. The City informally solicited quotations for the fire hoses.
4. The administration's recommendation is to award a contract to AAA Emergency Supply.
6. The cost of the Contract exceeds \$17,500.00.
7. This certification is made pursuant to N.J.S.A. 19:44A-20.5.
8. I certify that the foregoing statements are true. I am aware that if any of the following statements made by me are willfully false, I am subject to legal action to the fullest extent of the law.

Date

10/23/18



Steven McGill  
Chief of Fire Department

# Resolution of the City of Jersey City, N.J.

City Clerk File No. Res. 18-988

Agenda No. 10.Z.3

Approved: NOV 07 2018

TITLE:



**RESOLUTION AUTHORIZING THE AWARD OF A CONTRACT TO WINNER FORD FOR THE PURCHASE AND DELIVERY OF FORD F350 VEHICLES UNDER STATE CONTRACT FOR THE DEPARTMENT OF PUBLIC SAFETY, DIVISION OF FIRE**

**COUNCIL OFFERED AND MOVED ADOPTION OF THE FOLLOWING RESOLUTION:**

**WHEREAS**, the Division of Fire needs to replace two vehicles that are old and have serious mechanical problems; and

**WHEREAS**, N.J.S.A. 40A:11-12 of the Local Public Contracts Law authorizes municipalities to use a State Contract and N.J.A.C. 5:34-7.29 requires a City Council authorization for contracts exceeding \$40,000.00; and

**WHEREAS**, Winner Ford, 250 Haddonfield Berlin Road, Cherry Hill, New Jersey 08034 is in possession of state contract A88758, and will provide two Ford F350 pick up trucks for a total contract amount of fifty two thousand, three hundred ninety eight dollars (\$52,398.00); and

**WHEREAS**, funds are available for this contract in the Trust Account;

Acct #	P.O. #	State Contract	Total Contract
17-289-56-000-002	130950	A88758	\$52,398.00

**WHEREAS**, the City Purchasing Agent has certified that he considers said proposal to be fair and reasonable;

**NOW, THEREFORE, BE IT RESOLVED** by the Municipal Council of the City of Jersey City that:

1. A contract award to Winner Ford in the amount of \$52,398.00 for the purchase and delivery of two Ford F350 pick up trucks is authorized.
2. The contract is awarded without public bidding pursuant to N.J.S.A. 40A:11-12.
3. The term of the contract will be completed upon the delivery of goods and services.
4. Upon certification by an official or employee of the City authorized to administer the contract, that the services have been provided and the requirements of the contract met, then payment to the contractor shall be made in accordance with the provisions of the Local Fiscal Affairs Law, N.J.S.A. 40A:5-1 et seq.

(Continued to page 2)

TITLE:

**RESOLUTION AUTHORIZING THE AWARD OF A CONTRACT TO WINNER FORD FOR THE PURCHASE AND DELIVERY OF FORD F350 VEHICLES UNDER STATE CONTRACT FOR THE DEPARTMENT OF PUBLIC SAFETY, DIVISION OF FIRE**

I, Donna Mauer Donna Mauer, Chief Financial Officer, certify that there are sufficient funds available for payment of this above resolution.

WHEREAS, funds are available for this contract in the Trust Account;

Acct #	P.O. #	State Contract	Total Contract
17-289-56-000-002	130950	A88758	\$52,398.00

Approved by: Peter Felgado  
 Peter Felgado, Director of Purchasing  
 RPPO, QPA

10/24/18  
 Date

PF/pt  
 10/23/18

JACK  
 10/24/18

APPROVED: \_\_\_\_\_

APPROVED AS TO LEGAL FORM

APPROVED: [Signature]  
 Business Administrator

[Signature]  
 Corporation Counsel

Certification Required

Not Required

APPROVED 8-0

RECORD OF COUNCIL VOTE ON FINAL PASSAGE 11.7.18											
COUNCILPERSON	AYE	NAY	N.V.	COUNCILPERSON	AYE	NAY	N.V.	COUNCILPERSON	AYE	NAY	N.V.
RIDLEY	✓			YUN	✓			RIVERA	✓		
PRINZ-AREY	✓			SOLOMON	✓			WATTERMAN	ABSENT		
BOGGIANO	✓			ROBINSON	✓			LAVARRO, PRES	✓		

✓ Indicates Vote

N.V.-Not Voting (Abstain)

Adopted at a meeting of the Municipal Council of the City of Jersey City N.J.

[Signature]  
 Rolando R. Lavarro, Jr., President of Council

[Signature]  
 Robert Byrne, City Clerk



**RESOLUTION FACT SHEET**

This summary sheet is to be attached to the front of any resolution that is submitted for Council consideration. Incomplete or vague fact sheets will be returned with the resolution.

**Full Title of Ordinance/Resolution**

**RESOLUTION AUTHORIZING THE AWARD OF A CONTRACT TO WINNER FORD FOR THE PURCHASE AND DELIVERY OF FORD F350 VEHICLES UNDER STATE CONTRACT FOR THE DEPARTMENT OF PUBLIC SAFETY, DIVISION OF FIRE**

**Initiator**

Department/Division	PUBLIC SAFETY	FIRE
Name/Title	Chief Steven McGill	Chief of Department
Phone/email	201-547-4247	simcgill@njcps.org

Note: Initiator must be available by phone during agenda meeting (Wednesday prior to council meeting @ 4:00 p.m.)

**Resolution Purpose**

This vehicle purchase is for two Ford F-350 Pickup Trucks under State Contract and will be marked and assigned to the Fire Division Hose Shop, which handles fire equipment repairs. The two vehicles currently being used by the Hose Shop are both at least 15 years old and have serious mechanical issues.

I certify that all the facts presented herein are accurate.

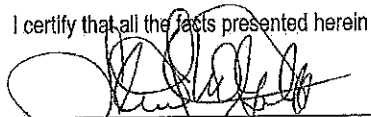
  
Signature of Department Director

10/23/18  
Date

Peter Folgado, Director of Purchasing  
RPPO, QPA

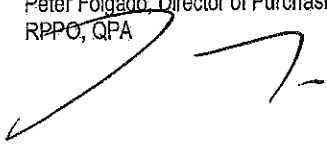

12/24/18  
Date

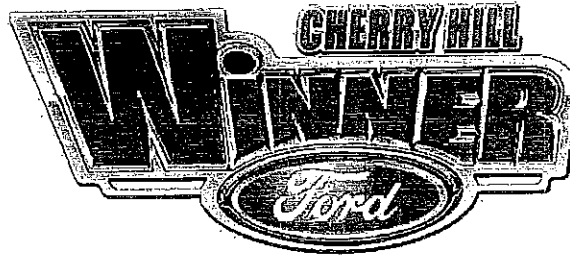

**Michael Drahuschak**

**October 3, 2018 (856) 214-0755 Phone**

**(856) 488-1915 Fax**

**(2) 2019 FORD F350 4WD PICKUP TRUCKS**

**STATE OF NEW JERSEY/CONTRACT A88758, T2101**

**Standard equipment per specifications**

6.2L V8 gas flex fuel engine 385 HP, 430 ft-lb torque with 6 speed automatic transmission  
Tilt and telescoping steering wheel, intelligent oil life monitor  
AM/FM stereo radio with 2 speakers and clock, dual air bags  
Airbags, frontal driver & passenger, side impact and side air curtains  
Safety canopy, trailer sway control, Advance Trac w/roll stability control  
4 wheel power ABS brakes, front and rear disc, power steering  
Mono-beam front axle with coil springs, 35 gallon fuel tank (8 foot bed)  
Manual floor mounted transfer case with manual locking hubs (4x4)  
157-amp HD alternator (gas), 650 CCA battery (gas)  
LT245/75Rx17E BSW all season tires, includes spare  
17" argent painted steel wheels with center hub, tire pressure monitor system  
Painted front and rear bumpers, rear bumper is step type (pickup bed application only)  
Black painted grille, solar tinted glass, air conditioning  
Manual telescoping trailer tow mirrors with manual glass  
Halogen headlamps, 2 front frame mounted tow hooks  
Full width vinyl 40/20/40 bench seat with manual recline adjustment  
Door trim-armrest/grab handle & reflector, black vinyl floor covering  
11.5" day/night rearview mirror, SecuriLock anti-theft ignition  
Tachometer, speedometer, oil pressure, transmission temp, engine temp, and fuel gauge  
Black cluster w/black gauges w/white graphics and one button message center with  
odometer, trip odometer, distance to empty, average fuel economy and engine hour meter  
Interval windshield wipers, power point, standard XL trim  
Electronic Shift on the Fly  
Rear View Camera  
3 year or 36,000 mile basic, 5 yr or 60,000 mile Powertrain Warranty  
**Regular cab 4 wheel drive Ford** \$24,669.00  
**Single Rear Wheel** NC

SHIFT ON THE FLY STANDARD. MUST REQUEST MANUAL TRANSFER  
CASE

*Options*

18B	Cab Steps (w/ Regular Cab XL)	320.00
52B	Tow Command Integrated Trailer Brake Controller	270.00
85S	Tough Bed Spray-in bedliner	540.00
76C	Exterior Back-up Chime	140.00
592	Roof Clearance Lights	95.00
66S	Upfitter Switches	165.00

*Other truck equipment available for the purpose of quotation requests*

**Total Truck & Equipment \$26,199.00**

        x 2  
**\$52,398.00**

Search

Division of Purchase and Property  
does not support script

**Notice of Award  
Term Contract(s)**

**T-2101  
VEHICLES, TRUCKS, CLASS 3, PICKUP/  
UTILITY/DUMP, WITH SNOW PLOW OPTION**

Vendor Information
By Vendor
By Item
RFP Documents
Email to SEPIDEH GHORBANI

**Downloadable NOA Documents**  
(Please utilize scroll bar on right side of box if necessary to view all documents)

The **Download All Documents** hyperlink will place compressed files on your computer. Files may be unzipped and viewed using WinZip. The evaluation version is available for free. [Click here](#) to learn more about WinZip or to download the latest version from the WinZip web site.

Forms in this section are stored in Adobe Acrobat (PDF) format. PDF formatted documents appear the same as the original printed forms. To view and print these forms, you must have a PDF viewer which is available free from Adobe. [Click here](#) to learn more about Adobe Acrobat or to download the latest version of the Adobe Acrobat viewer from the Adobe Web site.

[NOAs By Number](#)

[NOAs By Title](#)

[Search NOAs](#)

<b>Index #:</b>	T-2101
<b>Contract #:</b>	VARIOUS
<b>Contract Period:</b>	FROM: 03/19/15 TO: 03/18/19

	250 BERLIN ROAD CHERRY HILL, NJ 08034
<b>Contact Person:</b>	RICHARD COYLE
<b>Contact Phone:</b>	856-214-0758
<b>Order Fax:</b>	856-488-1915
<b>Contract#:</b>	88758
<b>Expiration Date:</b>	03/18/19
<b>Terms:</b>	NONE
<b>Delivery:</b>	120 DAYS ARO
<b>Small Business Enterprise:</b>	NO
<b>Minority Business Enterprise:</b>	NO
<b>Women Business Enterprise:</b>	NO
<b>Cooperative Purchasing *:</b>	YES

**\* WILL VENDOR EXTEND CONTRACT PRICES TO COOPERATIVE PURCHASING PARTICIPANTS?**

<b>Vendor Name &amp; Address:</b>	HERTRICH FLEET SERVICES 1427 BAY ROAD MILFORD, DE 19963
<b>Contact Person:</b>	MICHAEL WRIGHT
<b>Contact Phone:</b>	800-698-9825
<b>Order Fax:</b>	302-839-0555
<b>Contract#:</b>	88759
<b>Expiration Date:</b>	03/18/19
<b>Terms:</b>	NONE
<b>Delivery:</b>	120 DAYS ARO
<b>Small Business Enterprise:</b>	NO
<b>Minority Business Enterprise:</b>	NO
<b>Women Business Enterprise:</b>	NO
<b>Cooperative Purchasing *:</b>	YES

**\* WILL VENDOR EXTEND CONTRACT PRICES TO COOPERATIVE PURCHASING PARTICIPANTS?**

**CONTRACT ITEMS/SERVICES BY VENDOR**

<b>Vendor:</b> CHAS S WINNER INC DBA WINNER FORD		<b>Contract Number:</b> 88758			
LINE#	DESCRIPTION/MFGR/BRAND	EST QUANTITY	UNIT	% DISCOUNT	UNIT PRICE
00001	COMM CODE: 072-03-073401 [TRUCKS, INCLUDING, DIESEL, GASOLINE,...]	1.000	EACH	N/A	\$22469.00000

	<p>ITEM DESCRIPTION: TRUCK, PICKUP, CLASS 3, REGULAR CAB, 8 FT. BODY, 2WD, AS SPECIFIED IN THE RFP. (SECTION 1, T-2101)</p> <p>BRAND: 2019 FORD MODEL: F-350 XL DRW 2WD REGULAR CAB, MANUFACTURER'S BODY CODE: F3C WITH 620A PACKAGE (INCLUDES AIR CONDITIONING) AND 425 (50-STATE EMISSIONS), 996 (6.2L V8 FLEXIBLE FUEL ENGINE), 44P (6-SPEED AUTOMATIC TRANSMISSION) AND FRONT LICENSE PLATE BRACKET OPTION CODES.</p> <p>SHIP TO: RP1 STATEWIDE (PB RELEASE ORDERS)</p>				
LINE#	DESCRIPTION/MFGR/BRAND	EST QUANTITY	UNIT	% DISCOUNT	UNIT PRICE
00002	<p>COMM CODE: 072-03-073402 [TRUCKS, INCLUDING, DIESEL, GASOLINE,...]</p> <p>ITEM DESCRIPTION: VEHICLE MANUFACTURER'S PUBLISHED OPTION (FOR THE TRIM LINE AND MANUFACTURER'S BODY CODE BID FOR THE BASE VEHICLE) (SECTION 1, T-2101)</p> <p>SHIP TO: RP1 STATEWIDE (PB RELEASE ORDERS)</p>	1.000	EACH	10.00%	N/A
LINE#	DESCRIPTION/MFGR/BRAND	EST QUANTITY	UNIT	% DISCOUNT	UNIT PRICE
00003	<p>COMM CODE: 072-03-073403 [TRUCKS, INCLUDING, DIESEL, GASOLINE,...]</p> <p>ITEM DESCRIPTION: TRUCK, PICKUP, CLASS 3, REGULAR CAB, 8 FT. BODY, 4WD, AS SPECIFIED IN</p>	5.000	EACH	N/A	\$24669.00000



## STATE OF NEW JERSEY BUSINESS REGISTRATION CERTIFICATE

**Taxpayer Name:** CHAS. S. WINNER, INC.  
**Trade Name:** WINNER FORD OF CHERRY HILL  
**Address:** 250 HADDONFIELD BERLIN RD  
CHERRY HILL, NJ 08034-3507  
**Certificate Number:** 0061445  
**Effective Date:** August 28, 1946  
**Date of Issuance:** October 18, 2018

**For Office Use Only:**  
20181018142913541

EXHIBIT A (Continuation)

The contractor or subcontractor agrees to inform in writing its appropriate recruitment agencies including, but not limited to, employment agencies, placement bureaus, colleges, universities, and labor unions, that it does not discriminate on the basis of age, race, creed, color, national origin, ancestry, marital status, affectional or sexual orientation, gender identity or expression, disability, nationality or sex, and that it will discontinue the use of any recruitment agency which engages in direct or indirect discriminatory practices.

The contractor or subcontractor agrees to revise any of its testing procedures, if necessary, to assure that all personnel testing conforms with the principles of job-related testing, as established by the statutes and court decisions of the State of New Jersey and as established by applicable Federal law and applicable Federal court decisions.

In conforming with the targeted employment goals, the contractor or subcontractor agrees to review all procedures relating to transfer, upgrading, downgrading and layoff to ensure that all such actions are taken without regard to age, race, creed, color, national origin, ancestry, marital status, affectional or sexual orientation, gender identity or expression, disability, nationality or sex, consistent with the statutes and court decisions of the State of New Jersey, and applicable Federal law and applicable Federal court decisions.

The contractor shall submit to the public agency, after notification of award but prior to execution of a goods and services contract, one of the following three documents:

Letter of Federal Affirmative Action Plan Approval

Certificate of Employee Information Report

Employee Information Report Form AA302 (electronically provided by the Division and distributed to the public agency through the Division's website at [www.state.nj.us/treasury/contract\\_compliance](http://www.state.nj.us/treasury/contract_compliance))

The contractor and its subcontractors shall furnish such reports or other documents to the Division of Purchase & Property, CCAU, EEO Monitoring Program as may be requested by the office from time to time in order to carry out the purposes of these regulations, and public agencies shall furnish such information as may be requested by the Division of Purchase & Property, CCAU, EEO Monitoring Program for conducting a compliance investigation pursuant to Subchapter 10 of the Administrative Code at N.J.A.C. 17:27.

The undersigned vendor certifies on their company's receipt, knowledge and commitment to comply with:

EXHIBIT A  
N.J.S.A. 10:5-31 and N.J.A.C. 17:27  
MANDATORY EQUAL EMPLOYMENT OPPORTUNITY LANGUAGE  
Goods, Professional Services and General Service Contracts  
(Mandatory Affirmative Action Language)

The undersigned vendor further agrees to furnish the required forms of evidence and

understands that their contract/company's bid shall be rejected as non-responsive if said contractor fails to comply with the requirements of N.J.S.A. 10:5-31 and N.J.A.C. 17:27.

Representative's Name/Title (Print): MICHAEL BROTHUSCHAK Acct Mgr

Representative's Signature: [Signature]

Name of Company: WINNEN FORD

Tel. No.: 856-214-0755 Date: 9/19/18



**Minority/Woman Business Enterprise (MWBE)  
Questionnaire for Bidders**

Jersey City Ordinance C-829 establishes a goal of awarding 20% of the dollar amount of total city procurement to minority and woman owned business enterprises.

To assist us in monitoring our achievement of this goal, please indicate below whether your company is or is not a minority owned and/or woman owned business, and return this form with your bid proposal.

Business Name: Chas S. Winner, dba Winner Feas

Address: 250 Babylon Rd Cherry Hill NJ 08034

Telephone No: 856-214-0755

Contact Name: Michael Dratuschak

Please check applicable category :

Minority Owned Business (MBE)       Minority & Woman Owned Business (MWBE)

Woman Owned business (WBE)       Neither

**Definitions**

**Minority Business Enterprise**

Minority Business Enterprise means a business which is a sole proprietorship, partnership or corporation at least 51% of which is owned and controlled by persons who are African American, Hispanic, Asian American, American Indian or Alaskan native, defined as follows:

**African American:** a person having origins in any of the black racial groups of Africa

**Hispanic:** a person of Mexican, Puerto Rican, Central or South American or other non-European Spanish culture or origin regardless of race.

**Asian:** a person having origins in any of the original peoples of the Far East, South East Asia, Indian subcontinent, Hawaii or the Pacific Islands.

**American Indian or Alaskan Native:** a person having origins in any of the original peoples of North America and who maintains cultural identification through tribal affiliation or community recognition.

**Woman Business Enterprise**

Woman Business Enterprise means a business which is a sole proprietorship, partnership or corporation at least 51% of which is owned and controlled by a woman or women.

Certification 1124

**CERTIFICATE OF EMPLOYEE INFORMATION REPORT  
RENEWAL**

This is to certify that the contractor listed below has submitted an Employee Information Report pursuant to N.J.A.C. 17:27-1.1 et. seq. and the State Treasurer has approved said report. This approval will remain in effect for the period of 15 FEB 2016 to 15 FEB 2019

WINNER FORD  
250 HADDONFIELD-BERLIN RD.  
CHERRY HILL NJ 08034

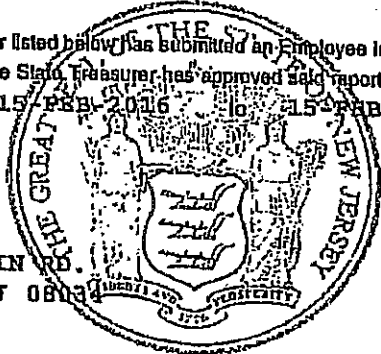

*Ford M. Scudder*  
FORD M. SCUDDER  
Acting State Treasurer

# Resolution of the City of Jersey City, N.J.

City Clerk File No. Res. 18-989

Agenda No. 10-Z-4

Approved: NOV 07 2018

TITLE:



## RESOLUTION AUTHORIZING THE PURCHASING AGENT TO SELL VARIOUS IMPOUNDED MOTOR VEHICLES AT PUBLIC AUCTION

COUNCIL  
ADOPTION OF THE FOLLOWING RESOLUTION:

OFFERED AND MOVED

**WHEREAS**, the City of Jersey City ("City") acquired title to various motor vehicles which were impounded and these vehicles have salvage value; and

**WHEREAS**, N.J.S.A. 40A:11-36 authorizes the sale of municipal personal property not needed for public use by public sale; and

**WHEREAS**, the Purchasing Agent desires to sell these motor vehicles by conducting a public auction; and

**WHEREAS**, the City will transfer title to all vehicles that remain unsold at the conclusion of the public auction to the impound operator.

**NOW, THEREFORE BE IT RESOLVED**, by the Municipal Council of the City of Jersey City that the Purchasing Agent is hereby authorized to sell the City's various motor vehicles to the highest bidder subject to the terms and conditions set forth herein:

1. The City is offering to sell one hundred and ninety eight (198) motor vehicles.
2. The successful bidder shall be required to pick up the motor vehicles at the impound operator's facility, 10 Linden Avenue East, Jersey City, NJ 07305 using its own equipment and laborers at no cost to the City. Pick up may be done on Monday through Friday between 9:00 a.m. and 3:00 p.m. Pick up must be done no later than five business days after the sale.
3. The successful bidder shall be required to pay its full bid amount at the conclusion of the bidding for each vehicle and bulk item. The form of payment is either by a company check or cash. No personal checks will be accepted.
4. The motor vehicles will be sold at a public auction conducted by the Purchasing Agent on a regular business day at a time, date, and place to be determined by the Purchasing Agent. This date must be within 60 days of the passage of this resolution. If bids are not received within 60 days, this resolution shall be deemed null and void.
5. Vehicles will be auctioned as bulk. Before the auction starts, all bidders will be advised that they may submit a sealed bid for the purchase of all the vehicles (bulk bid). At the end of the auction, the will City calculate the total individual sales amount versus the bulk bid amount. If the bulk bid amount is greater than the total individual sales amount, then the bulk bidder purchases all of the vehicles.
6. The vehicles are sold "AS IS" and the City does not guarantee the condition of the vehicles and bulk items. All sales are final. No returns and no exchanges.
7. A notice of the date, time, and place for the acceptance of bids and a description of the items to be auctioned shall be advertised in a newspaper circulating in the municipality not less than 7 nor more than 14 days before the date of the sale.
8. The City reserves the right in protection of the best interests of the City to waive any technical error, to reject any bid or any part thereof for any reason whatsoever.

TITLE:

**RESOLUTION AUTHORIZING THE PURCHASING AGENT TO  
 SELL VARIOUS IMPOUNDED MOTOR VEHICLES AT PUBLIC  
 AUCTION**

9. The City reserves the right to be exercised by the Purchasing Agent after opening all bids received to either accept the highest bid or reject all bids.

10. A list of the motor vehicles to be sold is as follows:

Number	Year	Make	Type	VIN#	Minimum Bid
1	1996	JEEP	WGN	1J4GZ58S7TC219543	\$37,258.40
2	2006	BMW	4DR	WBAVB13506KX35844	\$31,608.00
3	2006	CHR	4DR	2A8GM48446R883111	\$62,602.40
4	2002	CAD	4DR	1G6KD54Y32U129214	\$30,933.90
5	2016	YAM	SCT	JYA13T001EC100123	\$28,398.00
6	1994	OLD	4DR	1G3HN52L3R4820054	\$28,237.50
7	2002	KIA	VAN	KNDUP131126314750	\$27,884.40
8	2003	DOD	TRU	1D7HU18ZX3S199704	\$46,488.20
9	2013	HYU	4DR	5NPEB4ACXDH516231	\$27,242.40
10	2001	BMW	4DR	WBADN53411GC96671	\$26,568.30
11	2002	CAD	4-DR	1G6KS54Y32U143832	\$26,279.40
12	2000	LINCOLN	SEDAN 4-DR	1LNHM86S6YY852439	\$25,220.10
13	2001	FOR	4DR	1FAFP52261A270207	\$24,546.00
14	1994	FOR	TRK	1FDKE37H7RHA18786	\$44,947.40
15	2007	CHR	4DR	1C3LC56R87N616862	\$22,427.40
16	1996	BUI	4DR	1G4NJ52M2TC426254	\$19,024.80
17	2008	DOD	4DR	2B3KA43RX8H214753	\$18,447.00
18	2010	CHE	4DR	2G1WB5EK4A1211647	\$17,933.40
19	2000	DAE	4DR	KLAJC52Z3YK426437	\$15,397.50
20	2010	LINCOLN	4DR	3LNHL2GC1AR611738	\$15,204.90
21	1999	MER	4DR	2MEFM74W3XX687426	\$10,954.22
22	2002	INF	4DR	JNKDA31AX2T015161	\$10,473.32
23	2002	FOR	SUV	1FMZU72E02UB27576	\$9,938.94
24	2001	FOR	4DR	1FAFP55U31A106569	\$9,683.02
25	2006	DOD	4DR	1D4GP25BX6B744303	\$9,619.04
26	2006	SUZ	4DR	KL5JD56Z86K367789	\$8,947.25
27	2008	CHE	4DR	1G1ZH57B684231020	\$8,691.33
28	2001	CHR	4DR	2C4GP44391R417873	\$8,627.35
29	2003	PON	4DR	1G2HY52K334164349	\$8,467.40
30	2008	FOR	2DR	1FTNE24W08DA84164	\$16,386.94
31	2002	BMW	4DR	SUXFA53542LV71776	\$15,363.26

TITLE:

32	2017	RAM	4DR	1C6RR7FT8HS508473	\$14,275.60
33	2004	JEE	4DR	1J4GW48S84C225534	\$6,579.99
34	1999	CHR	4DR	2C3HE66G9XH825427	\$6,420.04
35	2009	HON	MOTO	JH2ME10359K501378	\$6,324.07
36	1998	LIN	4DR	1LNFM82W5WY699565	\$6,036.16
37	2003	BUI	4DR	2G4WB52K631180900	\$6,036.16
38	2005	CHE	4DR	1G1AK52F757620722	\$5,844.22
39	2010	DOD	4DR	1B3CB4HA5AD662213	\$5,780.24
40	2016	NIS	4DR	1N4AL3AP7GN355081	\$5,588.30
41	2006	LAN	4DR	SALSF25416A974578	\$10,736.80
42	2001	VW	4DR	3VWSK69M71M129716	\$5,492.33
43	2006	AUD	4DR	WAUDF78E86A220348	\$5,492.33
44	2007	LEX	4DR	JTHBJ46GX72140488	\$5,460.34
45	2006	BUI	SUV	3G5DA03L56S613311	\$5,460.34
46	2003	SAT	4DR	1G8AJ52F13Z144036	\$5,428.35
47	2008	DOD	SUV	1D8GU28KX8W262557	\$5,428.35
48	2004	LIN	4DR	5LMEU88H24ZJ12036	\$5,396.36
49	2003	FOR	4DR	1FMYU93113KB82974	\$5,332.38
50	2008	LEX	4DR	JTHBK262282071822	\$5,300.39
51	2003	HYU	4DR	KM8SC73D13U517081	\$5,300.39
52	2000	FOR	2DR	1FDRE14L5YHB74173	\$10,500.78
53	2002	MIT	4DR	6MMAP57P52T008358	\$5,268.40
54	2000	FOR	2DR	1FTRX18L1YNB36417	\$10,436.80
55	2005	LIN	4DR	1LNHM84W55Y605575	\$5,268.40
56	2004	CHRY	SPORT UTIL	2C8GF68444R182836	\$5,204.42
57	2006	TOY	2DR	JTDKB20U167059561	\$5,204.42
58	1997	TOY	4DR	2T1BA02E7VC164020	\$5,204.42
59	1996	OLD	4DR	1G3WH52M1TF350190	\$5,172.43
60	2005	CHE	2DR	1GAHG35U451241100	\$10,116.90
61	2005	HON	2DR	1HGEM21615L059123	\$5,108.45
62	2006	HON	4DR	5FNRL38696B401839	\$4,014.82
63	2000	BMW	2DR	WBABM3340YJN86960	\$5,076.46
64	2011	INF	4DR	JN8AS1MW0BM733829	\$5,044.47
65	2003	HON	4DR	1HGCM566X3A091076	\$5,044.47
66	2000	LIN	4DR	1LNHM87A5YY905637	\$4,942.53
67	2016	GMC	SUV	2GKALMEK2G6141087	\$4,948.50
68	2001	PON	4DR	1G2NF52T11M558205	\$4,916.51
69	2002	DOD	4DR	1B4GP44322B634226	\$3,854.87
70	2004	AUD	4DR	WAULT64BX4N052647	\$4,852.53
71	1997	FOR	4DR	1FALP52U0VA283397	\$4,852.53
72	1996	TOY	4DR	4T1BG12K8TU697001	\$4,820.54
73	1998	PON	4DR	1G2WJ52MXWF211477	\$4,820.54
74	2000	DOD	VAN	1B4GP44R3YB571540	\$4,852.53
75	2000	JEE	SUV	1J4GW48SXYC339377	\$4,788.55
76	2000	PON	4DR	1G2NE52T3YM835174	\$4,788.55
77	1990	OLD	4DR	1G3AM54N9L6323413	\$4,788.55

TITLE:

78	1996	BUI	2DR	1G4NJ12M2TC430572	\$4,756.56
79	1996	BUI	4DR	1G4CW52K6TH632557	\$4,756.56
80	2002	FOR	SUV	1FMZU72K92UD19696	\$4,756.56
81			MC	1FGTCKPM181007019	\$4,692.58
82	1995	HON	4DR	JHMEG866XSS025487	\$4,692.58
83	1989	MB	4DR	WDBCA39E3KA498782	\$4,660.59
84	2006	MB	4DR	WDBUF56JX6A903917	\$4,660.59
85	2003	HON	4DR	5FNRL18913B049902	\$4,628.60
86	1998	HON	2DR	1HGEJ8245WL096105	\$4,628.60
87	2001	FOR	4DR	1FAFP34P61W377399	\$4,596.61
88	2007	CHE	4DR	2G1WB58KX79284320	\$4,596.61
89	2004	NIS	4DR	1N4BA41E64C883314	\$4,596.61
90	2007	CHR	4DR	1C3LC46KX7N521815	\$4,564.62
91	2001	ACURA	4DR	2HNYD18201H544072	\$8,901.28
92	1998	FOR	2DR	3FALP1130WR118412	\$4,468.65
93	1998	PON	4DR	1G2WJ52K4WF319740	\$4,340.69
94	1985	SEA	BOAT	SERM3599E585	\$8,581.38
95	2005	CHE	4DR	1G1ZT548X5F215135	\$4,244.72
96	2010	MAZ	4DR	1YVHZ8BH4A5M20966	\$4,244.72
97	2005	HON	4DR	1HGCM72595A024495	\$4,244.72
98	2005	NIS	4DR	1N4AL11E65N920338	\$4,212.73
99	2001	MER	2DR	1ZWFT61L515615251	\$4,020.79
100	2004	AUD	4DR	WAULT64B44N055334	\$3,790.89
101	1998	JEE	4DR	1J4GZ58S5WC272732	\$4,180.74
102	2005	ACU	4DR	19UUA66295A078385	\$4,180.74
103	2001	MER	4DR	2MEFM74W01X661759	\$4,180.74
104	2003	FOR	SUV	1FMYU93143KD92470	\$4,148.75
105	2005	NIS	4DR	1N4BL11E55C288657	\$4,116.76
106	1984	OLD	2DR	1G3AZ57Y5EE336515	\$4,116.76
107	2004	PON	4DR	2G2WP522541112440	\$4,116.76
108	2003	PON	4DR	1G2NF52EX3C292984	\$4,116.76
109	1987	BAY	BOAT	BL1L78CXC787	\$4,084.77
110	2005	NIS	4DR	3N1CB51D65L504295	\$4,052.78
111	1996	HON	4DR	1HGCD562XTA085968	\$4,020.79
112	2006	FOR	4DR	1FAFP53U36A259737	\$4,020.79
113	1999	CHE	2DR	1GCEK19T6XE178088	\$7,877.60
114	2016	YAM	MC	RKRSR36Y8HA001320	\$3,988.80
115	1999	CHE	4DR	2G1WL52M0X9213490	\$3,988.80
116	2000	DAE	4DR	KLATA5266YB586400	\$3,988.80
117	2003	CHE	4DR	1GNEK13Z73R202616	\$7,813.62
118	1993	TOY	4DR	2T1AB09E8PC035163	\$3,956.81
119	2002	INF	4DR	JNKDA31A82T001548	\$3,956.81
120	2003	FOR	4DR	1FAFP53U83A118528	\$3,956.81
121	2002	NIS	4DR	JNIDA31A42T301916	\$3,924.82
122	2002	CHE	2DR	2G1WX15K829116442	\$3,892.83
123	2005	PON	4DR	2G2WP542651236506	\$3,892.83
124	1996	CHR	2DR	3C3EL55H2TT317122	\$3,860.84

## TITLE:

125	1999	CHE	VAN	1GBDM19W9XB149318	\$3,860.84
126	2001	FOR	4DR	1FAFP34321W118504	\$3,796.86
127	2006	HON	4DR	5FNRL38696B033422	\$3,796.86
128	2007	CHR	4DR	3A4FY48B57T542055	\$3,764.87
129	2000	DOD	4DR	1B4HS28N0YF271736	\$7,429.74
130	1999	ACU	2DR	19UYA3157XL004732	\$3,764.87
131	2000	DOD	4DR	2B4GP25G2YR710463	\$3,700.89
132	2015	CHE	4DR	1G1PE5SB9F7274771	\$3,700.89
133	1998	MB	4DR	4JGAB54E1WA011993	\$3,700.89
134	2002	DOD	2DR	1B7GL32X02S662217	\$3,636.91
135	2001	BUI	4DR	2G4WS52J111160588	\$3,636.91
136	2002	FOR	4DR	1FMDU74W22UA69163	\$3,572.93
137	2001	CHE	2DR	1GNCT18WX1K150861	\$3,572.93
138	1999	BUI	4DR	1G4HP52K6XH455937	\$3,604.92
139	2003	CHE	4DR	1GNDT13S332365817	\$3,540.94
140	2002	HYU	4DR	KMHFU45E02A180907	\$3,540.94
141	2004	TOY	4DR	2T1KR32E64C310447	\$3,476.96
142	2014	NIS	4DR	3N1AB7AP2EY291779	\$3,476.96
143	2002	AUD	4DR	WAULT64B62N099297	\$3,476.96
144	2011	VW	4DR	3VWDZ7AJXBM353642	\$3,444.97
145	2005	ACU	SEDAN 4-DR	19UUA662X5A018535	\$3,444.97
146	2000	SAT	4DR	1G8JS52FXYY611867	\$3,412.98
147	2006	NIS	4DR	1N4AL11D66N328270	\$3,380.99
148	1997	HON	4DR	JHMCD5637VC008973	\$3,349.00
149	2007	TOY	4DR	4T1BK46KX7U512365	\$3,285.02
150	1997	FOR	2DR	1FALP6243VH137170	\$3,285.02
151	2000	MER	4DR	1MEFM55S6YG602263	\$3,285.02
152	2004	CHE	4DR	1GNDT13S742286636	\$6,406.06
153	2008	NIS	4DR	1N4BA41EX8C838575	\$3,253.03
154	1996	FOR	4DR	1FALP52U9TA145936	\$3,253.03
155	2003	NIS	4DR	JN1DA31D53T508231	\$3,253.03
156	2017	KIA	4DR	KNDJP3A50H7429671	\$3,253.03
157	2004	HON	COUPE 2-DR	1HGEM22574L038037	\$3,221.04
158	2001	PON	4DR	1G2WP52K81F145629	\$2,927.16
159	1999	ACU	4DR	19UUA5643XA012297	\$3,189.05
160	2005	DOD	4DR	1D4HB48N95F501836	\$6,278.10
161	2006	DOD	4DR	1B3EL46X86N166840	\$3,189.05
162	1978	HON	MC	CB400T4022065	\$3,189.05
163	1995	DOD	4DR	4B3AU42Y8SE088661	\$3,189.05
164	2005	FOR	2DR	1FTSW21575EC38578	\$6,214.12
165	1997	DOD	4DR	2B4GP25R5VR230849	\$3,061.09
166	2007	BMW	4DR	WBAVC93587KX58222	\$3,061.09
167	2006	DOD	VAN	2D4GP44L96R741917	\$3,061.09
168	1999	FOR	SUV	1FMZU24E2XUA73432	\$3,061.09
169	2006	FOR	4DR	1FAFP53U76A138161	\$3,029.10

City Clerk File No. Res. 18-989  
 Agenda No. 10.Z.4 NOV 07 2018

TITLE:

170	2003	BMW	4DR	WBAEV334X3KL89209	\$2,997.11
171	2012	VW	4DR	1VWAP7A35CC015269	\$2,997.11
172	2000	PON	4DR	1G2NES2T1YM799078	\$2,997.11
173	2006	ACU	4DR	19UUA66256A075792	\$2,965.12
174	2001	CHR	4DR	2C8GP44G51R117636	\$2,965.12
175	1998	TOY	4DR	4T3ZF13C9WU027431	\$2,965.12
176	2002	CHR	4DR	3C4FY58B92T320087	\$2,933.13
177	2002	HON	4DR	1HGCG66542A022175	\$2,901.14
178	2001	PON	4DR	1GMDX03E31D237592	\$2,869.15
179	1996	NIS	4DR	JN1CA21D0TT174910	\$2,869.15
180	1995	HON	4DR	1HGCD5630SA048838	\$2,817.16
181	2009	MIN	4DR	WMWMF73579TW85168	\$2,805.17
182	2001	FRE	2DR	1FVABPCS11HH65880	\$9,300.29
183	2008	DOD	4DR	1B3HB48BX8D655489	\$2,805.17
184	1998	DOD	SUV	1B4HS28Y1WF175301	\$5,446.36
185	2002	FOR	VAN	2FMZA52472BB77076	\$2,773.18
186	2002	DOD	SUV	1B4HS38N92F192286	\$5,318.40
187	2006	FOR	4DR	1FMEU74E96ZA12544	\$5,254.42
188	2002	FOR	4DR	1FMZU73E12ZA14768	\$5,254.42
189	2006	NIS	4DR	3N1CB51D76L590721	\$2,677.21
190	1998	LEX	4DR	JT8BF28G2W5036707	\$2,645.22
191	2001	HYU	4DR	KMHNDN45D41U140869	\$2,613.23
192	2006	CHR	4DR	2C3LA53G86H228868	\$2,581.24
193	2001	BMW	SUV	WBFAFA53541LM90287	\$4,998.50
194	2002	HON	VAN	2HKRL18632H531356	\$2,549.25
195	2016	NIS	4DR	1N4AL3AP5GC273877	\$2,549.25
196	1998	HON	2DR	1HGEJ6225WL033606	\$2,549.25
197	1998	HON	4DR	1HGCG564XWA048318	\$2,549.25
198	2007	LIN	4DR	1LNHM81W27Y628738	\$2,485.27

SMcK  
10/29/18

PS /sb  
October 26, 2018

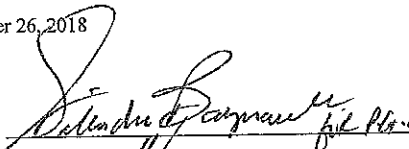
APPROVED:  Business Administrator

APPROVED AS TO LEGAL FORM

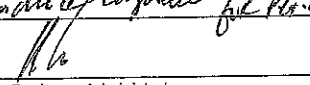
APPROVED:  Corporation Counsel

Certification Required

Not Required

APPROVED 8-0

RECORD OF COUNCIL VOTE ON FINAL PASSAGE 11.7.18											
COUNCILPERSON	AYE	NAY	N.V.	COUNCILPERSON	AYE	NAY	N.V.	COUNCILPERSON	AYE	NAY	N.V.
RIDLEY	✓			YUN	✓			RIVERA	✓		
PRINZ-AREY	✓			SOLOMON	✓			WATTERMAN	ABSENT		
BOGGIANO	✓			ROBINSON	✓			LAVARRO, PRES	✓		

✓ Indicates Vote

N.V.-Not Voting (Abstain)

Adopted at a meeting of the Municipal Council of the City of Jersey City N.J.

6 | Page

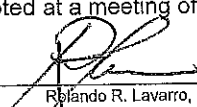
  
Rplando R. Lavarro, Jr., President of Council

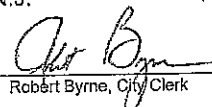
  
Robert Byrne, City Clerk



**RESOLUTION FACT SHEET - CONTRACT AWARD**

This summary sheet is to be attached to the front of any resolution that is submitted for Council consideration. Incomplete or vague fact sheets will be returned with the resolution.

**Full Title of Ordinance/Resolution**

**RESOLUTION AUTHORIZING THE PURCHASING AGENT TO SELL VARIOUS IMPOUNDED MOTOR VEHICLES AT PUBLIC AUCTION**

**Project Manager**

Department/Division	DPW	Automotive
Name/Title	Hector Ortiz Martin Valenti	Asst. DPW Director Automotive Director
Phone/email	201-547-4400 201-547-4422	ortizh@icnj.org mvalenti@icnj.org

Note: Project Manager must be available by phone during agenda meeting (Wednesday prior to council meeting @ 4:00 p.m.)

**Contract Purpose**

- \* The City of Jersey City ("City") acquired title to various motor vehicles which were impounded and these vehicles have salvage value.
- \* The City is offering to sell one hundred and ninety eight (198) motor vehicles.
- \* N.J.S.A. 40A:11-36 authorizes the sale of municipal personal property not needed for public use by public sale.
- \* The Purchasing Agent desires to sell these motor vehicles by conducting a public auction.
- \* The City will transfer title to all vehicles that remain unsold at the conclusion of the public auction to the impound operator.

**Cost (Identify all sources and amounts)**

[Empty box for cost information]

**Contract term (include all proposed renewals)**

[Empty box for contract term information]

Type of award **Auction Resolution**

If "Other Exception", enter type

[Empty box for other exception type]

**Additional Information**

[Empty box for additional information]

I certify that all the facts presented herein are accurate.

*Brenda Bayarri*  
Signature of Department Director

10/26/18  
Date

Signature of Purchasing Director

Date

# Resolution of the City of Jersey City, N.J.

City Clerk File No. Res. 18-990

Agenda No. 10.Z.5

Approved: NOV 07 2018

TITLE:



**RESOLUTION AUTHORIZING THE AWARD OF A CONTRACT TO EMERGENCY ACCESSORIES AND INSTALLATION INC. FOR THE PURCHASE AND INSTALLATION OF EMERGENCY EQUIPMENT FOR THE FORD INTERCEPTOR UTILITY VEHICLES UNDER STATE CONTRACT FOR THE DEPARTMENT OF PUBLIC SAFETY, DIVISION OF POLICE**

**COUNCIL OFFERED AND MOVED ADOPTION OF THE FOLLOWING RESOLUTION:**

WHEREAS, the Department of Public Safety, Division of Police need to purchase emergency accessories for eight police interceptor vehicles; and

WHEREAS, N.J.S.A. 40A:11-12 of the Local Public Contracts Law authorizes municipalities to use a State Contract and N.J.A.C. 5:34-7.29 requires a City Council authorization for contracts exceeding \$40,000.00; and

WHEREAS, Emergency Accessories & Installations Inc., 250 Haddonfield Berlin Road, Cherry Hill, New Jersey 08034 is in possession of State contracts A81327, A81336, A81344, and will provide emergency accessories for a total contract amount of ninety thousand, two hundred dollars (\$90,200.00); and

WHEREAS, funds are available for this contract in the Capital Account;

Acct #	P.O. #	State Contracts	Total Contract
04-215-55-176-990	130951	A81327, A81336, A81344	\$90,200.00

WHEREAS, the City Purchasing Agent has certified that he considers said proposal to be fair and reasonable;

**NOW, THEREFORE, BE IT RESOLVED** by the Municipal Council of the City of Jersey City that:

1. A contract award to Emergency Accessories & Installations Inc. in the amount of \$90,200.00 for the purchase and installation of emergency accessories is authorized.
2. The contract is awarded without public bidding pursuant to N.J.S.A. 40A:11-12.
3. The term of the contract will be completed upon the delivery of goods and services.
4. Upon certification by an official or employee of the City authorized to administer the contract, that the services have been provided and the requirements of the contract met, then payment to the contractor shall be made in accordance with the provisions of the Local Fiscal Affairs Law, N.J.S.A. 40A:5-1 et seq.

(Continued to page 2)

City Clerk File No. Res. 18-990

Agenda No. 10.Z.5 NOV 07 2018

TITLE:

**RESOLUTION AUTHORIZING THE AWARD OF A CONTRACT TO EMERGENCY ACCESSORIES AND INSTALLATION INC. FOR THE PURCHASE AND INSTALLATION OF EMERGENCY EQUIPMENT FOR THE FORD INTERCEPTOR UTILITY VEHICLES UNDER STATE CONTRACT FOR THE DEPARTMENT OF PUBLIC SAFETY, DIVISION OF POLICE**

I, Donna Mauer Donna Mauer, Chief Financial Officer, certify that there are sufficient funds available for payment of this above resolution.

WHEREAS, funds are available for this contract in the Capital Account;

Acct #	P.O. #	State Contracts	Total Contract
04-215-55-176-990	130951	A81327, A81336, A81344	\$90,200.00

Approved by: Peter Folgado, Director of Purchasing  
RPPO, QPA

Date 10/24/18

PF/pv  
10/23/18  
JMK  
10/24/18

APPROVED: \_\_\_\_\_

APPROVED AS TO LEGAL FORM

APPROVED: [Signature]  
Business Administrator

[Signature]  
Corporation Counsel

Certification Required

Not Required

APPROVED 8-0

RECORD OF COUNCIL VOTE ON FINAL PASSAGE 11.7.18											
COUNCILPERSON	AYE	NAY	N.V.	COUNCILPERSON	AYE	NAY	N.V.	COUNCILPERSON	AYE	NAY	N.V.
RIDLEY	✓			YUN	✓			RIVERA	✓		
PRINZ-AREY	✓			SOLOMON	✓			WATTERMAN	ABSENT		
BOGGIANO	✓			ROBINSON	✓			LAVARRO, PRES	✓		

✓ Indicates Vote

N.V.-Not Voting (Abstain)

Adopted at a meeting of the Municipal Council of the City of Jersey City N.J.

[Signature]  
Rolando R. Lavarro, Jr., President of Council

[Signature]  
Robert Byrne, City Clerk

# EAI



770 Cuthburt Blvd.  
 Cherry Hill, NJ 08002  
 Date: 10/17/2018

Michael Drahuschak

Desk: (856) 214-0755

Fax: (856) 488-1915

E-mail:

[mdrahuschak@winnerford.com](mailto:mdrahuschak@winnerford.com)

Contact name: Jersey City  
 Quote#  
 Contract #s 81336, 81327, 81344  
 Vehicle: 2019 Utility Interceptor

Qty	Part Number	Description	Location	List	Discount	Price
1	IB8DEDE	Whelen Liberty Duo	Roof	\$5,603.00	46%	\$3,025.62
2	IONJ	Whelen ION White	Headlight	\$150.00	46%	\$162.00
1	SSFFP16	Head Light Flasher	Headlight	\$129.00	46%	\$69.66
2	LINSV2R/2B	LINZ V Series Side Mirror	Side Mirror	\$245.00	46%	\$264.60
1	ULF44	Flash Tail Light	Brake Light	\$91.00	46%	\$49.14
2	IONJ	ION's Rear License	Rear License	\$150.00	46%	\$162.00
2	VTX609C	Whelen Vertex	Reverse Light	\$119.00	46%	\$128.52
2	AVN1R,AVN1B	Whelen Avengers	Rear Window	\$204.00	46%	\$220.32
2	IONJ/GROM	ION's Recessed Rear Hatch	Rear Hatch	\$157.15	46%	\$169.72
1	7170-0166-01	Ganber Johnson	Console	\$672.00	10%	\$604.80
1	ASA315P/SAK52	Whelen Speaker/Bracket	Grille	\$369.00	46%	\$199.26
1	295SLSA6	Whelen Siren Switch	Console	\$672.00	46%	\$362.88
1	PRPSP4704UINT13	Pro Gard Partition	Rear	\$857.00	25%	\$642.75
1	54705UINT13	Pro Gard Seat/Barrier	Rear	\$1,334.00	25%	\$1,000.50
1	40SBK4713	Outboard Seat Belt System	Rear	\$478.00	25%	\$358.50
2	IONJ	ION's Side Partition	Partition	\$150.00	46%	\$162.00
2	LSVBKT34	Bracket for Mirror	Side Mirror	\$24.50	46%	\$26.46
1	IONBKT1	Bracket for License Plate	Rear License	\$32.50	46%	\$17.55
1	FP47UINT13	Floor Pan	Rear Floor	\$209.00	25%	\$156.75
Labor to install above						\$3,491.97
<b>Total Cost</b>						<b>\$11,275.00</b>

Additional Notes: All items are quoted IAW contract #s 81336,81327, & 81344

*Line 106*

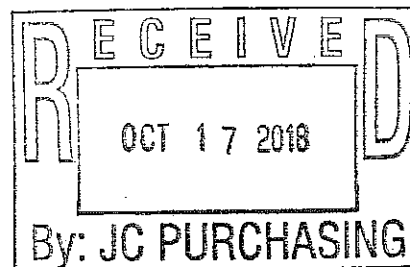



# State of New Jersey

DEPARTMENT OF THE TREASURY  
DIVISION OF PURCHASE AND PROPERTY  
PROCUREMENT BUREAU  
33 WEST STATE STREET  
P. O. BOX 230  
TRENTON, NEW JERSEY 08625-0230  
<https://www.njstart.gov>

PHILIP D. MURPHY  
*Governor*

ELIZABETH MAHER MUOIO  
*State Treasurer*

SHEILA Y. OLIVER  
*Lt. Governor*

MAURICE A. GRIFFIN  
*Acting Director*

## AMENDMENT # 236 T-0106 Solicitation # 21817 and 22630

**TO:** All Using Agencies

**DATE:** July 25, 2018

**FROM:** Donald Warren, Procurement Specialist, Commodities/Fleet Unit

**SUBJECT:** Police and Homeland Security Equipment and Supplies – Statewide – **Ninety (90) Day Transitional Extension**

**CONTRACT PERIOD:** Original: May 01, 2012 to April 30, 2015  
1<sup>st</sup> Extension: May 01, 2015 to April 30, 2016  
2<sup>nd</sup> Extension: May 01, 2016 to October 31, 2016  
3<sup>rd</sup> Extension: November 01, 2016 to April 30, 2017  
Transition: May 01, 2017 to August 28, 2017  
Transition: August 29, 2017 to December 26, 2017  
Transition: December 27, 2017 to April 27, 2018  
Transition: April 28, 2018 to July 26, 2018  
Transition: July 27, 2018 to October 24, 2018

Please be advised that the following Blanket P.O.s {Contracts} have been extended for a period of ninety (90) days, through October 24, 2018, at the same contract pricing, terms, conditions and specifications:

Vendor {Contractor}	Blanket P.O. #	Vendor {Contractor}	Blanket P.O. #
12-X-21817		12-X-21817	
1075 EMERGENCY LIGHTING	81347	LANIGAN ASSOCIATES INC.	81299
511 INC.	81360	LASER TECHNOLOGY INC.	81322
ABSOLUTE FIRE PROTECTION	81340	LAWMEN SUPPLY CO NJ INC.	81295
ADVANCED ELECTRONICS DESIGN	81300	MINE SAFETY APPLIANCES CO.	81357
AMERICAN ALUMINUM ACCESSORIES INC.	81375	MOBILE VISION INC.	81311

Search

ion of Purchase and Property  
 does not support script

**Notice of Award  
 Term Contract(s)**

**T-0106  
 POLICE AND HOMELAND SECURITY EQUIPMENT  
 AND SUPPLIES - STATEWIDE**

Vendor Information
Authorized Dealers
By Vendor
RFP Documents
Email to KRISTI THOMAS

**Downloadable NOA Documents**  
 (Please utilize scroll bar on right side of box if necessary to view all documents)

The **Download All Documents** hyperlink will place compressed files on your computer. Files may be unzipped and viewed using WinZip. The evaluation version is available for free. [Click here](#) to learn more about WinZip or to download the latest version from the WinZip web site.

Forms in this section are stored in Adobe Acrobat (PDF) format. PDF formatted documents appear the same as the original printed forms. To view and print these forms, you must have a PDF viewer which is available free from Adobe. [Click here](#) to learn more about Adobe Acrobat or to download the latest version of the Adobe Acrobat viewer from the Adobe Web site.

[NOAs By Number](#)

[NOAs By Title](#)

[Search NOAs](#)

<b>Index #:</b>	T-0106
<b>Contract #:</b>	VARIOUS
<b>Contract Period:</b>	FROM: 05/01/12 TO: 10/24/18

APPLIED CONCEPTS INC.	81323	MOOSE BOATS INC.	81317
ARAMSCO INC.	81352	MUNICIPAL EQUIPMENT	81332
ARMOR EXPRESS	81348	POINT BLANK ENTERPRISE INC.	81351
ASTROPHYSICS INC.	81310	PRO GARD	81327
ATLANTIC TACTICAL INC.	81297	SABRE SECURITY EQUIPMENT	81315
BADGE COMPANY OF NEW JERSEY	81326	SELEX ES INC.	81318
BEYER FORD LLC	81346	SIG SAUER INC.	81319
BLUE LINE EMERGENCY LIGHTING	81308	SOUND OFF INC.	81334
CODE 3 INC.	81331	SPECTRUM COMMUNICATION LLC	81373
CONTINENTAL FIRE & SAFETY	81365	STREAMLIGHT INC.	81329
DECATUR ELECTRONICS INC.	81314	SURVIVAL ARMOR INC.	81316
DRAEGER INC.	81301	TRIANGLE COMMUNICATIONS LLC	81343
EAGLE POINT GUN SHOP	81296	TROY PRODUCTS	81335
EAST COAST EMERGENCY LIGHTING	81338	VINELAND AUTO ELECTRIC INC	81339
EMERGENCY ACCESSORIES & INSTALATION INC.	81344	WEST TRENTON HARDWARE LLP	81353
ESI EQUIPMENT INC.	81377	WHELEN ENGINEER	81336
FIREFIGHTER ONE LLC	81363	ZODIAC OF NORTH AMERICA INC.	81374
GEN EL SAFETY & INDUSTRIAL	81356		
GENERAL SALES ADMINISTRATION	81330		
GOLD TYPE BUSINESS MACHINES	81341 and 81342		
ICOR TECHNOLOGY INC.	81358		
KALDOR EMERGENCY LIGHTS LLC	81333		
KDH DEFENSE SYSTEMS INC.	81309		
LAKELAND INDUSTRIES INC.	81302		

Vendor {Contractor} 13-X-22630	Blanket P.O. #	Vendor {Contractor} 13-X-22630	Blanket P.O. #
ATLANTIC NUCLEAR CORP.	82105	MPH INDUSTRIES INC.	82101
ATLANTIC TACTICAL INC.	82102	SMITHS DETECTION INC.	82106
BIOFIRE DIAGNOSTICS INC.	82104	TELEVERE SYSTEMS	82108
LAWMEN SUPPLY CO NJ INC.	82100	ZISTOS CORPORATION	82111

The following Master Blanket Purchase Orders (Blanket P.O.) {Contract}, awarded to the Vendors {Contractors} listed below, will be extended and set to a "pay only" status in MACSe pending the submittal of an executed Amendment to the Blanket P.O.:

Vendor {Contractor}	Blanket P.O. #
AMERICAN DIVING SUPPLY	82110
AMKUS INC.	81313
ARMORSHIELD USA INC.	82179
BATTLEWARE TECHNOLOGIES INC.	81312
GUARDIAN PROTECTIVE SERVICES	82099
PROTECTIVE PRODUCTS	81350
SIGNAL VEHICLE PRODUCTS INC.	81371

Vendor: EMERGENCY ACCESSORIES & INSTALLATION INC		Contract Number: 81344			
LINE#	DESCRIPTION/MFGR/BRAND	EST QUANTITY	UNIT	% DISCOUNT	UNIT PRICE
00107	COMM CODE: 680-97-021437 [POLICE, CORRECTIONAL FACILITY AND...]  ITEM DESCRIPTION: AUDIBLE & VISUAL EMERGENCY SIGNAL SYSTEM HOURLY LABOR RATE FOR INSTALLATION OF EQUIPMENT	1.000	EACH	N/A	\$79.00000
LINE#	DESCRIPTION/MFGR/BRAND	EST QUANTITY	UNIT	% DISCOUNT	UNIT PRICE
00239	COMM CODE: 680-97-021444 [POLICE, CORRECTIONAL FACILITY AND...]  ITEM DESCRIPTION: AUDIBLE & VISUAL EMERGENCY SIGNAL SYSTEM BRAND: HINT PERIPHERALS  P/L DATED: 1/1/12 - LIST	1.000	EACH	20.50%	N/A
LINE#	DESCRIPTION/MFGR/BRAND	EST QUANTITY	UNIT	% DISCOUNT	UNIT PRICE
00240	COMM CODE: 680-97-021444 [POLICE, CORRECTIONAL FACILITY AND...]  ITEM DESCRIPTION: AUDIBLE & VISUAL EMERGENCY SIGNAL SYSTEM BRAND: L3 MOBILE  P/L DATED: 1/11/11 - MASTER	1.000	EACH	8.45%	N/A
Vendor: ESI EQUIPMENT INC		Contract Number: 81377			
LINE#	DESCRIPTION/MFGR/BRAND	EST QUANTITY	UNIT	% DISCOUNT	UNIT PRICE
00211	COMM CODE: 257-72-082767 [DEFENSE SYSTEM AND HOMELAND SECURITY...]  ITEM DESCRIPTION: SERACH AND RESCUE BRAND: HALMATRO	1.000	EACH	2.00%	N/A



LINE#	DESCRIPTION/MFGR/BRAND	EST QUANTITY	UNIT	% DISCOUNT	UNIT PRICE
00118	COMM CODE: 680-08-082340 [POLICE, CORRECTIONAL FACILITY AND...]  ITEM DESCRIPTION: BODY ARMOR AND ACCESSORIES BRAND: PROTECTIVE APPAREL (PACA)  P/L DATED: 4/15/11 - RETAIL P/L #: PACA04152011	1.000	EACH	38.00%	N/A

**Vendor:** PRO GARD **Contract Number:** 81327

LINE#	DESCRIPTION/MFGR/BRAND	EST QUANTITY	UNIT	% DISCOUNT	UNIT PRICE
00094	COMM CODE: 680-92-082671 [POLICE, CORRECTIONAL FACILITY AND...]  ITEM DESCRIPTION: RIOT CONTROL EQUIPMENT & SUPPLIES BRAND: PROGUARD (SHIELDS)  P/L DATED: 1/1/12 - LIST PRICE	1.000	EACH	25.00%	N/A

**Vendor:** PROTECTIVE PRODUCTS **Contract Number:** 81350

LINE#	DESCRIPTION/MFGR/BRAND	EST QUANTITY	UNIT	% DISCOUNT	UNIT PRICE
00115	COMM CODE: 680-08-082345 [POLICE, CORRECTIONAL FACILITY AND...]  ITEM DESCRIPTION: BODY ARMOR AND ACCESSORIES BRAND: PARACLETE  P/L DATED: 1/1/12 - RETAIL	1.000	EACH	38.00%	N/A

LINE#	DESCRIPTION/MFGR/BRAND	EST QUANTITY	UNIT	% DISCOUNT	UNIT PRICE
00119	COMM CODE: 680-08-082341 [POLICE, CORRECTIONAL FACILITY AND...]  ITEM DESCRIPTION: BODY ARMOR AND ACCESSORIES BRAND: PROTECTIVE PRODUCTS  P/L DATED: 1/1/12 - RETAIL	1.000	EACH	45.00%	N/A

<b>Contract#:</b> 81319	<b>Title:</b> POLICE AND HOMELAND SECURITY EQUIPMENT
<b>Dealer/Distributor Name &amp; Address:</b>	ATLANTIC TACTICAL INC 763 CORPORATE CIRCLE NEW CUMBERLAND PA 17070
<b>Contact Person:</b>	SEAN CONNVILLE
<b>Contact Phone:</b>	717-774-3339
<b>Dealer/Distributor Name &amp; Address:</b>	EAGLE POINT GUN SHOP T J MORRIS & SON 1707 THIRD STREET THOROFARE NJ 08086
<b>Contact Person:</b>	THOMAS J MORRIS III
<b>Contact Phone:</b>	856-848-6945
<b>Dealer/Distributor Name &amp; Address:</b>	SIG SAUER INC 18 INDUSTRIAL DR EXETER NH 03833
<b>Contact Person:</b>	BETH O BRIEN
<b>Contact Phone:</b>	603-686-5612
<b>Contract#:</b> 81327	<b>Title:</b> POLICE AND HOMELAND SECURITY EQUIPMENT
<b>Dealer/Distributor Name &amp; Address:</b>	ATLANTIC TACTICAL INC 763 CORPORATE CIRCLE NEW CUMBERLAND PA 17070
<b>Contact Person:</b>	SEAN CONNVILLE
<b>Contact Phone:</b>	717-774-3339
<b>Dealer/Distributor Name &amp; Address:</b>	BEYER FORD LLC 31 WILLIAMS PARKWAY EAST HANOVER NJ 07936
<b>Contact Person:</b>	BARBARA M. BEYER
<b>Contact Phone:</b>	973-319-7011
<b>Dealer/Distributor Name &amp; Address:</b>	EAST COAST EMERGENCY LIGHTING 200 MECO DRIVE MILLSTONE TWP NJ 08535
<b>Contact Person:</b>	DAWN E BAZZURRO
<b>Contact Phone:</b>	732-940-2211
<b>Dealer/Distributor Name &amp; Address:</b>	EMERGENCY ACCESSORIES & INSTALLATION INC 250 HADDONFIELD-BERLIN RD CHERRY HILL NJ 08034
<b>Contact Person:</b>	DONALD J SLIPP
<b>Contact Phone:</b>	856-427-2726
<b>Dealer/Distributor Name &amp; Address:</b>	LAWMEN SUPPLY CO-NJ INC 7115 AIRPORT HIGHWAY PENNSAUKEN NJ 08109

*Luth.*

<b>Contact Phone:</b>	732-940-2211
<b>Dealer/Distributor Name &amp; Address:</b>	EMERGENCY ACCESSORIES & INSTALLATION INC 250 HADDONFIELD-BERLIN RD CHERRY HILL NJ 08034
<b>Contact Person:</b>	DONALD J SLIPP
<b>Contact Phone:</b>	856-427-2726
<b>Dealer/Distributor Name &amp; Address:</b>	EMERGENCY SERVICES SYSTEMS INC 781 HAMILTON STREET SOMERSET NJ 08873
<b>Contact Person:</b>	LISA KRUSHINSKI
<b>Contact Phone:</b>	908-910-4634
<b>Dealer/Distributor Name &amp; Address:</b>	MUNICIPAL EQUIPMENT ENTERPRISES LLC 2703 FIRE ROAD EGG HARBOR TWP NJ 08234
<b>Contact Person:</b>	LEN POLISTINA
<b>Contact Phone:</b>	609-484-0555
<b>Dealer/Distributor Name &amp; Address:</b>	TRIANGLE COMMUNICATIONS LLC 2362 WALDHEIM AVENUE SCOTCHS PLAINS NJ 07076
<b>Contact Person:</b>	BRENT J CHESHIRE
<b>Contact Phone:</b>	908-518-0911
<b>Dealer/Distributor Name &amp; Address:</b>	VINELAND AUTO ELECTRIC INC 382 SOUTH DELSEA DRIVE VINELAND NJ 08360-5397
<b>Contact Person:</b>	ERNEST M BERTINO
<b>Contact Phone:</b>	856-691-5845
<b>Contract#: 81336</b>	<b>Title: POLICE AND HOMELAND SECURITY EQUIPMENT</b>
<b>Dealer/Distributor Name &amp; Address:</b>	BEYER FORD LLC 31 WILLIAMS PARKWAY EAST HANOVER NJ 07936
<b>Contact Person:</b>	BARBARA M. BEYER
<b>Contact Phone:</b>	973-319-7011
<b>Dealer/Distributor Name &amp; Address:</b>	EAST COAST EMERGENCY LIGHTING 200 MECO DRIVE MILLSTONE TWP NJ 08535
<b>Contact Person:</b>	DAWN E BAZZURRO
<b>Contact Phone:</b>	732-940-2211
<b>Dealer/Distributor Name &amp; Address:</b>	EMERGENCY ACCESSORIES & INSTALLATION INC 250 HADDONFIELD-BERLIN RD CHERRY HILL NJ 08034

	DISCOUNT QUANTITIES OF 40 + ARE 42% DISCOUNT P/L DATED: 1/1/11 - LIST P/L #: CA2400				
LINE#	DESCRIPTION/MFGR/BRAND	EST QUANTITY	UNIT	% DISCOUNT	UNIT PRICE
00130	COMM CODE: 257-40-082686 [DEFENSE SYSTEM AND HOMELAND SECURITY...]  ITEM DESCRIPTION: AREA SECURITY ENCHANCEMENT EQUIPMENT BRAND: MI-T-M CORPORTION  P/L DATED: 2012 -LIST P/L #: 2012 INDUSTRIAL	1.000	EACH	36.00%	N/A
LINE#	DESCRIPTION/MFGR/BRAND	EST QUANTITY	UNIT	% DISCOUNT	UNIT PRICE
00132	COMM CODE: 257-40-082688 [DEFENSE SYSTEM AND HOMELAND SECURITY...]  ITEM DESCRIPTION: AREA SECURITY ENCHANCEMENT EQUIPMENT BRAND: ROBIN AMERICA  P/L DATED: 1/1/11 - LIST P/L #: LEQP-006	1.000	EACH	11.00%	N/A
LINE#	DESCRIPTION/MFGR/BRAND	EST QUANTITY	UNIT	% DISCOUNT	UNIT PRICE
00212	COMM CODE: 257-72-082768 [DEFENSE SYSTEM AND HOMELAND SECURITY...]  ITEM DESCRIPTION: SERACH AND RESCUE BRAND: ICS BLOUNT  P/L DATED: 1/1/12 - MSRP P/L #: 2012 PROD. GUIDE	1.000	EACH	11.00%	N/A
<b>Vendor:</b> WHELEN ENGINEER		<b>Contract Number:</b> 81336			
LINE#	DESCRIPTION/MFGR/BRAND	EST QUANTITY	UNIT	% DISCOUNT	UNIT PRICE
00106	COMM CODE: 680-97-021448 [POLICE, CORRECTIONAL FACILITY AND...]	1.000	EACH	46.00%	N/A

	ITEM DESCRIPTION: AUDIBLE & VISUAL EMERGENCY SIGNAL SYSTEM BRAND: WHELAN  P/L DATED: 12/22/11 - LIST				
--	---	--	--	--	--

LINE#	DESCRIPTION/MFGR/BRAND	EST QUANTITY	UNIT	% DISCOUNT	UNIT PRICE
00107	COMM CODE: 680-97-021437 [POLICE, CORRECTIONAL FACILITY AND...]  ITEM DESCRIPTION: AUDIBLE & VISUAL EMERGENCY SIGNAL SYSTEM HOURLY LABOR RATE FOR INSTALLATION OF EQUIPMENT	1.000	EACH	N/A	\$75.00000

**Vendor:** ZODIAC OF NORTH AMERICA INC      **Contract Number:** 81374

LINE#	DESCRIPTION/MFGR/BRAND	EST QUANTITY	UNIT	% DISCOUNT	UNIT PRICE
00223	COMM CODE: 257-72-082779 [DEFENSE SYSTEM AND HOMELAND SECURITY...]  ITEM DESCRIPTION: SERACH AND RESCUE BRAND: ZODIAK  DELIVERY: 30 DAYS ARO P/L DATED: 12/22/11 - RETAIL	1.000	EACH	5.00%	N/A

**Vendor:** 1075 EMERGENCY LIGHTING      **Contract Number:** 81347

LINE#	DESCRIPTION/MFGR/BRAND	EST QUANTITY	UNIT	% DISCOUNT	UNIT PRICE
00107	COMM CODE: 680-97-021437 [POLICE, CORRECTIONAL FACILITY AND...]  ITEM DESCRIPTION: AUDIBLE & VISUAL EMERGENCY SIGNAL SYSTEM HOURLY LABOR RATE FOR INSTALLATION OF EQUIPMENT	1.000	EACH	N/A	\$85.00000

LINE#	DESCRIPTION/MFGR/BRAND	EST QUANTITY	UNIT	% DISCOUNT	UNIT PRICE
-------	------------------------	--------------	------	------------	------------



## STATE OF NEW JERSEY BUSINESS REGISTRATION CERTIFICATE

**Taxpayer Name:** EMERGENCY ACCESSORIES & INSTALLATION, INC.  
**Trade Name:**  
**Address:** 250 HADDONFIELD-BERLIN RD  
CHERRY HILL, NJ 08034-3507  
**Certificate Number:** 0108831  
**Effective Date:** September 17, 1999  
**Date of Issuance:** October 18, 2018

**For Office Use Only:**  
20181018160000978

**Minority/Woman Business Enterprise (MWBE)  
Questionnaire for Bidders**

Jersey City Ordinance C-829 establishes a goal of awarding 20% of the dollar amount of total city procurement to minority and woman owned business enterprises.

To assist us in monitoring our achievement of this goal, please indicate below whether your company is or is not a minority owned and/or woman owned business, and return this form with your bid proposal.

Business Name: Emergency Accessories & Installations  
Address: 250 Berlin Rd, Edison Hill, N.J. 08034  
Telephone No: 856-214-0758  
Contact Name: Rich Coyle

Please check applicable category :

Minority Owned Business (MBE)       Minority & Woman Owned Business(MWBE)  
 Woman Owned business (WBE)       Neither

**Definitions**

**Minority Business Enterprise**

Minority Business Enterprise means a business which is a sole proprietorship, partnership or corporation at least 51% of which is owned and controlled by persons who are African American, Hispanic, Asian American, American Indian or Alaskan native, defined as follows:

**African American:** a person having origins in any of the black racial groups of Africa

**Hispanic:** a person of Mexican, Puerto Rican, Cuban or South American or other non-European Spanish culture or origin regardless of race.

**Asian:** a person having origins in any of the original peoples of the Far East, South East Asia, Indian subcontinent, Hawaii or the Pacific Islands.

**American-Indian or Alaskan Native:** a person having origins in any of the original peoples of North America and who maintains cultural identification through tribal affiliation or community recognition.

**Woman Business Enterprise**

Woman Business Enterprise means a business which is a sole proprietorship, partnership or corporation at least 51% of which is owned and controlled by a woman or women.

EXHIBIT A (Continuation)

The contractor or subcontractor agrees to inform in writing its appropriate recruitment agencies including, but not limited to, employment agencies, placement bureaus, colleges, universities, and labor unions, that it does not discriminate on the basis of age, race, creed, color, national origin, ancestry, marital status, affectional or sexual orientation, gender identity or expression, disability, nationality or sex, and that it will discontinue the use of any recruitment agency which engages in direct or indirect discriminatory practices.

The contractor or subcontractor agrees to revise any of its testing procedures, if necessary, to assure that all personnel testing conforms with the principles of job-related testing, as established by the statutes and court decisions of the State of New Jersey and as established by applicable Federal law and applicable Federal court decisions.

In conforming with the targeted employment goals, the contractor or subcontractor agrees to review all procedures relating to transfer, upgrading, downgrading and layoff to ensure that all such actions are taken without regard to age, race, creed, color, national origin, ancestry, marital status, affectional or sexual orientation, gender identity or expression, disability, nationality or sex, consistent with the statutes and court decisions of the State of New Jersey, and applicable Federal law and applicable Federal court decisions.

The contractor shall submit to the public agency, after notification of award but prior to execution of a goods and services contract, one of the following three documents:

Letter of Federal Affirmative Action Plan Approval

Certificate of Employee Information Report

Employee Information Report Form AA302 (electronically provided by the Division and distributed to the public agency through the Division's website at [www.state.nj.us/treasury/contract\\_compliance](http://www.state.nj.us/treasury/contract_compliance))

The contractor and its subcontractors shall furnish such reports or other documents to the Division of Purchase & Property, CCAU, EEO Monitoring Program as may be requested by the office from time to time in order to carry out the purposes of these regulations, and public agencies shall furnish such information as may be requested by the Division of Purchase & Property, CCAU, EEO Monitoring Program for conducting a compliance investigation pursuant to Subchapter 10 of the Administrative Code at N.J.A.C. 17:27.

The undersigned vendor certifies on their company's receipt, knowledge and commitment to comply with:

EXHIBIT A  
N.J.S.A. 10:5-31 and N.J.A.C. 17:27  
MANDATORY EQUAL EMPLOYMENT OPPORTUNITY LANGUAGE  
Goods, Professional Services and General Service Contracts  
(Mandatory Affirmative Action Language)

The undersigned vendor further agrees to furnish the required forms of evidence and

understands that their contract/company's bid shall be rejected as non-responsive if said contractor fails to comply with the requirements of N.J.S.A. 10:5-31 and N.J.A.C. 17:27.

Representative's Name/Title (Print): Richard Poyle, General Manager Govt Sales

Representative's Signature: [Signature]

Name of Company: EMERGENCY ACCESSORIES & INSTALLATIONS

Tel. No: 958 214 0758 Date: 10/19/12



**STATE OF NEW JERSEY**  
Division of Purchase & Property  
Contract Compliance Audit Unit  
EEO Monitoring Program

**EMPLOYEE INFORMATION REPORT**

IMPORTANT-READ INSTRUCTIONS CAREFULLY BEFORE COMPLETING FORM. FAILURE TO PROPERLY COMPLETE THE ENTIRE FORM AND TO SUBMIT THE REQUIRED \$150.00 FEE MAY DELAY ISSUANCE OF YOUR CERTIFICATE. DO NOT SUBMIT EEO-1 REPORT FOR SECTION B, ITEM 11. For Instructions on completing the form, go to: [http://www.state.nj.us/treasury/contract\\_compliance/pdf/aa302ins.pdf](http://www.state.nj.us/treasury/contract_compliance/pdf/aa302ins.pdf)

**SECTION A - COMPANY IDENTIFICATION**

1. FID. NO. OR SOCIAL SECURITY 223628434	2. TYPE OF BUSINESS <input checked="" type="checkbox"/> 1. MFG <input checked="" type="checkbox"/> 2. SERVICE <input checked="" type="checkbox"/> 3. WHOLESALE <input checked="" type="checkbox"/> 4. RETAIL <input checked="" type="checkbox"/> 5. OTHER	3. TOTAL NO. EMPLOYEES IN THE ENTIRE COMPANY 21		
4. COMPANY NAME Emergency Accessories & Installatons				
5. STREET 250 Berlin Rd.	CITY Cherry Hill	COUNTY Camden	STATE NJ	ZIP CODE 08034
6. NAME OF PARENT OR AFFILIATED COMPANY (IF NONE, SO INDICATE)		CITY	STATE	ZIP CODE
7. CHECK ONE: IS THE COMPANY: <input checked="" type="checkbox"/> SINGLE-ESTABLISHMENT EMPLOYER <input type="checkbox"/> MULTI-ESTABLISHMENT EMPLOYER				
8. IF MULTI-ESTABLISHMENT EMPLOYER, STATE THE NUMBER OF ESTABLISHMENTS IN NJ				
9. TOTAL NUMBER OF EMPLOYEES AT ESTABLISHMENT WHICH HAS BEEN AWARDED THE CONTRACT				21
10. PUBLIC AGENCY AWARDDING CONTRACT				
Official Use Only		DATE RECEIVED	INAUG. DATE	ASSIGNED CERTIFICATION NUMBER

**SECTION B - EMPLOYMENT DATA**

11. Report all permanent, temporary and part-time employees ON YOUR OWN PAYROLL. Enter the appropriate figures on all lines and in all columns. Where there are no employees in a particular category, enter a zero. Include ALL employees, not just those in minority/non-minority categories, in columns 1, 2, & 3. **DO NOT SUBMIT AN EEO-1 REPORT.**

JOB CATEGORIES	ALL EMPLOYEES			PERMANENT MINORITY/NON-MINORITY EMPLOYEE BREAKDOWN											
	COL. 1 TOTAL (Cols. 2 & 3)	COL. 2 MALE	COL. 3 FEMALE	***** MALE *****					***** FEMALE *****						
				BLACK	HISPANIC	AMER. INDIAN	ASIAN	NON MIN.	BLACK	HISPANIC	AMER. INDIAN	ASIAN	NON MIN.		
Officials/Managers	3	2	1						3						0
Professionals															
Technicians	16	16			4		8		4						
Sales Workers															
Office & Clerical	1		1						1						
Craftworkers (skilled)															
Operatives (Semi-skilled)	1	1							1						
Laborers (Unskilled)															
Service Workers															
TOTAL	21	19	2		4		8		9						
Total employment from previous Report (if any)	19	18	1		1		8		10						0
Temporary & Part-Time Employees	The data below shall NOT be included in the figures for the appropriate categories above.														
	0														

12. HOW WAS INFORMATION AS TO RACE OR ETHNIC GROUP IN SECTION B OBTAINED <input type="checkbox"/> 1. Visual Survey <input checked="" type="checkbox"/> 2. Employment Record <input type="checkbox"/> 3. Other (Specify)	14. IS THIS THE FIRST Employees Information Report Submitted? 1. YES <input type="checkbox"/> 2. NO <input checked="" type="checkbox"/>	15. IF NO, DATE LAST REPORT SUBMITTED MO.   DAY   YEAR 70   12   2011
13. DATES OF PAYROLL PERIOD USED From: 1/1/16 To: 5/6/16		

**SECTION C - SIGNATURE AND IDENTIFICATION**

16. NAME OF PERSON COMPLETING FORM (Print or Type) Richard Coyle	SIGNATURE 	TITLE G.M. Gov't Sales	DATE MO   DAY   YEAR 5   13   16		
17. ADDRESS NO. & STREET 250 Berlin Rd	CITY Cherry Hill	COUNTY Camden	STATE NJ	ZIP CODE 08034	PHONE (AREA CODE, NO., EXTENSION) 856 - 214 - 0758

# Resolution of the City of Jersey City, N.J.

City Clerk File No. Res. 18-991

Agenda No. 10.Z.6

Approved: NOV 07 2018

TITLE:



**RESOLUTION AUTHORIZING A CHANGE ORDER INCREASING THE AMOUNT OF A CONTRACT WITH CITY AUTO AND TRUCK PARTS LLC, DBA BAYONNE AUTO PARTS FOR THE PURCHASE AND DELIVERY OF PARTS FOR HEAVY DUTY VEHICLES UNDER STATE CONTRACT FOR THE DEPARTMENT OF PUBLIC WORKS / DIVISION OF AUTOMOTIVE MAINTENANCE**

**COUNCIL** offered and moved adoption of the following resolution:

**WHEREAS**, Resolution No. 18-077, approved on January 24, 2018, awarded a State contract in the amount of \$300,000.00 to **CITY AUTO AND TRUCK PARTS LLC, DBA BAYONNE AUTO PARTS** for various parts for heavy duty vehicles for the City of Jersey City (City), Department of Public Works; and

**WHEREAS**, **CITY AUTO AND TRUCK PARTS LLC, DBA BAYONNE AUTO PARTS** possesses State Contract number A42093; and

**WHEREAS**, this contract provides various parts to the City's fleet of 1,600 plus vehicles which includes fire apparatus, police cars, Public Works trucks, snow vehicles, etc; and

**WHEREAS**, the City exercised the 20% threshold on the original contract amount and increased it by an additional \$60,000.00 making the total contract amount \$360,000.00; and

**WHEREAS**, additional funding in the amount of \$100,000.00 is needed to keep the City's fleet of vehicles operational; and

**WHEREAS**, **CITY AUTO AND TRUCK PARTS LLC, DBA BAYONNE AUTO PARTS** agrees to provide additional parts and repairs for an amount not to exceed \$100,000.00; and

**WHEREAS**, N.J.A.C. 5:30-11.9 requires that any change order which increases the contract amount by more than 20% be authorized by resolution; and

**WHEREAS**, funds are available in Division of Automotive Maintenance Operating Account No. 01-201-26-315-310; and

**WHEREAS**, this contract is effective until December 31, 2018; and

**WHEREAS**, this change order increases the total contract amount from \$360,000.00 to \$460,000.00;

**NOW, THEREFORE BE IT RESOLVED**, by the Municipal Council of the City of Jersey City that:

1. A change order in the amount of \$100,000.00 is hereby approved increasing the Total contract amount from \$360,000.00 to \$460,000.00; and
2. A notice of this change order shall be published in a newspaper of general circulation in the City of Jersey City as required by law.

(Continued on page # 2)

City Clerk File No. Res. 18-991

Agenda No. 10.Z.6 NOV 07 2018

TITLE:

**RESOLUTION AUTHORIZING A CHANGE ORDER INCREASING THE AMOUNT OF A CONTRACT WITH CITY AUTO AND TRUCK PARTS LLC, DBA BAYONNE AUTO PARTS FOR THE PURCHASE AND DELIVERY OF PARTS FOR HEAVY DUTY VEHICLES UNDER STATE CONTRACT FOR THE DEPARTMENT OF PUBLIC WORKS / DIVISION OF AUTOMOTIVE MAINTENANCE**

I, Donna Mauer, Donna Mauer, as Chief Financial Officer hereby certify that these funds are available in Division of Automotive Maintenance Operating Account No. 01-201-26-315-310 for payment of this resolution.

PO # 127620

PS/sb  
October 18, 2018

*PAK*  
*10/18/18*

APPROVED: *[Signature]*  
Patrick G. Stamato, DPW Director

APPROVED AS TO LEGAL FORM

APPROVED: \_\_\_\_\_  
Business Administrator

*[Signature]*  
Corporation Counsel

Certification Required

Not Required

APPROVED 8-0

RECORD OF COUNCIL VOTE ON FINAL PASSAGE 11.7.18											
COUNCILPERSON	AYE	NAY	N.V.	COUNCILPERSON	AYE	NAY	N.V.	COUNCILPERSON	AYE	NAY	N.V.
RIDLEY	✓			YUN	✓			RIVERA	✓		
PRINZ-AREY	✓			SOLOMON	✓			WATTERMAN	ABSENT		
BOGGIANO	✓			ROBINSON	✓			LAVARRO, PRES	✓		

✓ Indicates Vote

N.V.-Not Voting (Abstain)

Adopted at a meeting of the Municipal Council of the City of Jersey City N.J.

*[Signature]*  
Rolando R. Lavarro, Jr., President of Council

*[Signature]*  
Robert Byrne, City Clerk

**RESOLUTION FACT SHEET - CONTRACT AWARD**

This summary sheet is to be attached to the front of any resolution that is submitted for Council consideration. Incomplete or vague fact sheets will be returned with the resolution.

**Full Title of Ordinance/Resolution**

**RESOLUTION AUTHORIZING A CHANGE ORDER INCREASING THE AMOUNT OF A CONTRACT WITH CITY AUTO AND TRUCK PARTS LLC, DBA BAYONNE AUTO PARTS FOR THE PURCHASE AND DELIVERY OF PARTS FOR HEAVY DUTY VEHICLES UNDER STATE CONTRACT FOR THE DEPARTMENT OF PUBLIC WORKS / DIVISION OF AUTOMOTIVE MAINTENANCE**

**Project Manager**

Department/Division	DPW	Automotive
Name/Title	Hector Ortiz Martin Valenti	Asst. DPW Director Automotive Director
Phone/email	201-547-4400 201-547-4422	<a href="mailto:ortizh@icnj.org">ortizh@icnj.org</a> <a href="mailto:mvalenti@icnj.org">mvalenti@icnj.org</a>

Note: Project Manager must be available by phone during agenda meeting (Wednesday prior to council meeting @ 4:00 p.m.)

- ✦ To supply various parts for the City's fleet.
- ✦ Provide parts for class 5 or over 15,000 LBS.
- ✦ The City's fleet is about 1,600.
- ✦ Local Jersey City vendor.
- ✦ DPW spent about \$300,000.00 in 2017.

**Cost (Identify all sources and amounts)**

01-201-26-315-310 (Automotive Operating)

Total amending amount = \$100,000.00

**Contract term (include all proposed renewals)**

Until 12/31/18.

**Type of award**

State Contract

**If "Other Exception", enter type**

**Additional Information**

I certify that all the facts presented herein are accurate.

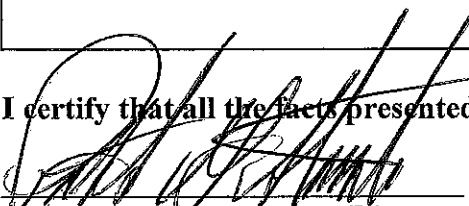

Signature of Department Director

10/26/18

Date

Signature of Purchasing Director

Date

# Resolution of the City of Jersey City, N.J.

City Clerk File No. Res- 18-077

Agenda No. 10-Z

Approved: JAN 24 2018

TITLE:



## RESOLUTION AUTHORIZING THE AWARD OF A CONTRACT TO CITY AUTO & TRUCK PARTS LLC D/B/A BAYONNE AUTO PARTS FOR THE PURCHASE AND DELIVERY OF PARTS FOR HEAVY DUTY VEHICLES UNDER STATE CONTRACT FOR THE DEPARTMENT OF PUBLIC WORKS, AUTOMOTIVE DIVISION

COUNCIL OFFERED AND MOVED ADOPTION OF THE FOLLOWING RESOLUTION:

WHEREAS, the City of Jersey City (City), Department of Public Works, Division of Automotive need parts for their heavy duty vehicles class or over 15,000 lbs; and

WHEREAS, N.J.S.A. 40A:11-12 of the Local Public Contracts Law authorizes municipalities to use a State Contract and N.J.A.C. 5:34-7.29 requires City Council authorization for contracts exceeding \$40,000.00; and

WHEREAS, City Auto & Truck Parts LLC D/B/A Bayonne Auto Parts, 1522 John F. Kennedy Boulevard, Jersey City, New Jersey 07305 is in possession of State Contract A42093, and will provide heavy duty parts for a total amount of three hundred thousand dollars (\$300,000.00); and

WHEREAS, funds are available for this contract in the Operating Account:

Acct #	P.O. #	State Contract	Total Contract	Temp Enc
01-201-26-315-310	127620	A42093	\$300,000.00	\$30,000.00

WHEREAS, the City Purchasing Agent has certified that he considers said proposal to be fair and reasonable;

NOW, THEREFORE, BE IT RESOLVED by the Municipal Council of the City of Jersey City that:

1. A contract in the amount of \$300,000.00 is awarded to City Auto & Truck Parts LLC DBA Bayonne Auto Parts for heavy duty parts.
2. The term of the contract shall be effective January 25, 2018 through December 31, 2018.
3. The contract is awarded without public bidding pursuant to N.J.S.A. 40A:11-12.
4. Upon certification by an official or employees of the City authorized to administer the contract, that the services have been provided and the requirements of the contract met, then payment to the contractor shall be made in accordance with the provisions of the Local Fiscal Affairs Law, N.J.S.A. 40A:5-1 et seq.
5. Pursuant to N.J.A.C. 5:30-5.5(a), the continuation of the contract after the expenditure of funds encumbered in the 2018 fiscal year temporary budget shall be subject to the availability and appropriation of sufficient funds in the 2018 fiscal year permanent budget.

(Continued to page 2)

Continuation of Resolution \_\_\_\_\_  
City Clerk File No. Res. 18-077  
Agenda No. 10.2 JAN 24 2018  
TITLE:

**RESOLUTION AUTHORIZING THE AWARD OF A CONTRACT TO CITY AUTO & TRUCK PARTS LLC D/B/A BAYONNE AUTO PARTS FOR THE PURCHASE AND DELIVERY OF PARTS FOR HEAVY DUTY VEHICLES UNDER STATE CONTRACT FOR THE DEPARTMENT OF PUBLIC WORKS, AUTOMOTIVE DIVISION**

Donna Mauer, Donna Mauer, Chief Financial Officer, certify that there are sufficient funds available for payment of this above resolution.

WHEREAS, funds are available for this contract in the Operating Account.

Acct.#	P.O. #	State Contract	Total Contract	Temp Enc
01-201-26-315-310	127620	A42093	\$300,000.00	\$30,000.00

Approved by: Peter Folgado for: January 17, 2018  
Peter Folgado, Director of Purchasing  
RPPO, QPA  
Date

PF/pv/RR  
1/17/18

R.R.  
1-17-18

APPROVED: \_\_\_\_\_  
APPROVED: \_\_\_\_\_  
Business Administrator  
APPROVED AS TO LEGAL FORM  
Joanne Morahan  
Corporation Counsel  
Certification Required   
Not Required   
APPROVED 9-0

RECORD OF COUNCIL VOTE ON FINAL PASSAGE 1.24.18											
COUNCILPERSON	AYE	NAY	N.V.	COUNCILPERSON	AYE	NAY	N.V.	COUNCILPERSON	AYE	NAY	N.V.
RIDLEY	✓			YUN	✓			RIVERA	✓		
PRINZ-AREY	✓			SOLOMON	✓			WATTERMAN	✓		
BOGGIANO	✓			ROBINSON	✓			LAVARRO, PRES	✓		

✓ Indicates Vote

N.V.-Not Voting (Abstain)

Adopted at a meeting of the Municipal Council of the City of Jersey City N.J.

Roberto R. Lavario, Jr.  
Roberto R. Lavario, Jr., President of Council

Robert Byrne  
Robert Byrne, City Clerk

307 23'19 AM 8:58

# **EEO/AFFIRMATIVE ACTION REQUIREMENTS**

## **Goods, Professional Services and General Service Contracts**

Questions in reference to EEO/AA Requirements For Goods, Professional Services and General Service Contracts should be directed to:

Jeana F. Abuan  
Spvg. Adm. Analyst, Public Agency Compliance Officer  
Department of Administration  
Office of Tax Abatement & Compliance  
13-15 Linden Avenue East  
Jersey City NJ 07305  
Tel. #201-547- 4538  
E-mail Address: [abuanJ@icnj.org](mailto:abuanJ@icnj.org)

**EXHIBIT A (Continuation)**

The contractor or subcontractor agrees to inform in writing its appropriate recruitment agencies including, but not limited to, employment agencies, placement bureaus, colleges, universities, and labor unions, that it does not discriminate on the basis of age, race, creed, color, national origin, ancestry, marital status, affectional or sexual orientation, gender identity or expression, disability, nationality or sex, and that it will discontinue the use of any recruitment agency which engages in direct or indirect discriminatory practices.

The contractor or subcontractor agrees to revise any of its testing procedures, if necessary, to assure that all personnel testing conforms with the principles of job-related testing, as established by the statutes and court decisions of the State of New Jersey and as established by applicable Federal law and applicable Federal court decisions.

In conforming with the targeted employment goals, the contractor or subcontractor agrees to review all procedures relating to transfer, upgrading, downgrading and layoff to ensure that all such actions are taken without regard to age, race, creed, color, national origin, ancestry, marital status, affectional or sexual orientation, gender identity or expression, disability, nationality or sex, consistent with the statutes and court decisions of the State of New Jersey, and applicable Federal law and applicable Federal court decisions.

The contractor shall submit to the public agency, after notification of award but prior to execution of a goods and services contract, one of the following three documents:

Letter of Federal Affirmative Action Plan Approval

Certificate of Employee Information Report

Employee Information Report Form AA302 (electronically provided by the Division and distributed to the public agency through the Division's website at [www.state.nj.us/treasury/contract\\_compliance](http://www.state.nj.us/treasury/contract_compliance))

The contractor and its subcontractors shall furnish such reports or other documents to the Division of Purchase & Property, CCAU, EEO Monitoring Program as may be requested by the office from time to time in order to carry out the purposes of these regulations, and public agencies shall furnish such information as may be requested by the Division of Purchase & Property, CCAU, EEO Monitoring Program for conducting a compliance investigation pursuant to Subchapter 10 of the Administrative Code at N.J.A.C. 17:27.

The undersigned vendor certifies on their company's receipt, knowledge and commitment to comply with:

**EXHIBIT A**  
N.J.S.A. 10:5-31 and N.J.A.C. 17:27  
**MANDATORY EQUAL EMPLOYMENT OPPORTUNITY LANGUAGE**  
Goods, Professional Services and General Service Contracts  
(Mandatory Affirmative Action Language)

The undersigned vendor further agrees to furnish the required forms of evidence and

understands that their contract/company's bid shall be rejected as non-responsive if said contractor fails to comply with the requirements of N.J.S.A. 10:5-31 and N.J.A.C. 17:27.

Representative's Name/Title (Print):

*Low Ponsford Lamida (owner)*

Representative's Signature:

*[Handwritten Signature]*

Name of Company:

*City Auto & Truck Parts LLC*

Tel. No.: *201-432-3321*

Date: *10/18/18*



APPENDIX A  
AMERICANS WITH DISABILITIES ACT OF 1990  
Equal Opportunity for Individuals with Disability

The contractor and the CITY of JERICHO (hereafter "owner") do hereby agree that the provisions of Title 11 of the Americans With Disabilities Act of 1990 (the "Act") (42 U.S.C. 5121 01 et seq.), which prohibits discrimination on the basis of disability by public entities in all services, programs, and activities provided or made available by public entities, and the rules and regulations promulgated pursuant there unto, are made a part of this contract. In providing any aid, benefit, or service on behalf of the owner pursuant to this contract, the contractor agrees that the performance shall be in strict compliance with the Act. In the event that the contractor, its agents, servants, employees, or subcontractors violate or are alleged to have violated the Act during the performance of this contract, the contractor shall defend the owner in any action or administrative proceeding commenced pursuant to this Act. The contractor shall indemnify, protect, and save harmless the owner, its agents, servants, and employees from and against any and all suits, claims, losses, demands, or damages, of whatever kind or nature arising out of or claimed to arise out of the alleged violation. The contractor shall, at its own expense, appear, defend, and pay any and all charges for legal services and any and all costs and other expenses arising from such action or administrative proceeding or incurred in connection therewith. In any and all complaints brought pursuant to the owner's grievance procedure, the contractor agrees to abide by any decision of the owner which is rendered pursuant to said grievance procedure. If any action or administrative proceeding results in an award of damages against the owner, or if the owner incurs any expense to cure a violation of the ADA which has been brought pursuant to its grievance procedure, the contractor shall satisfy and discharge the same at its own expense.

The owner shall, as soon as practicable after a claim has been made against it, give written notice thereof to the contractor along with full and complete particulars of the claim. If any action or administrative proceeding is brought against the owner or any of its agents, servants, and employees, the owner shall expeditiously forward or have forwarded to the contractor every demand, complaint, notice, summons, pleading, or other process received by the owner or its representatives.

It is expressly agreed and understood that any approval by the owner of the services provided by the contractor pursuant to this contract will not relieve the contractor of the obligation to comply with the Act and to defend, indemnify, protect, and save harmless the owner pursuant to this paragraph.

It is further agreed and understood that the owner assumes no obligation to indemnify or save harmless the contractor, its agents, servants, employees and subcontractors for any claim which may arise out of their performance of this Agreement. Furthermore, the contractor expressly understands and agrees that the provisions of this indemnification clause shall in no way limit the contractor's obligations assumed in this Agreement, nor shall they be construed to relieve the contractor from any liability, nor preclude the owner from taking any other actions available to it under any other provisions of the Agreement or otherwise at law.

Representative's Name/Title Print: SCOTT SKEED BAUDAT  
Representative's Signature: [Signature]  
Name of Company: CITY OF JERICHO  
Tel. No.: 201-432-3321 Date: 10/18/18

**Minority/Woman Business Enterprise (MWBE)  
Questionnaire for Bidders**

Jersey City Ordinance C-829 establishes a goal of awarding 20% of the dollar amount of total city procurement to minority and woman owned business enterprises.

To assist us in monitoring our achievement of this goal, please indicate below whether your company is or is not a minority owned and/or woman owned business, and return this form with your bid proposal.

Business Name : City Automobile Parts LLC  
Address : 1522 Kenway Blvd Jersey City NJ 07305  
Telephone No. : 201-432-3321  
Contact Name : Sheridan Raudat

Please check applicable category :

Minority Owned Business (MBE)       Minority & Woman Owned Business (MWBE)  
 Woman Owned business (WBE)       Neither

**Definitions**

**Minority Business Enterprise**

Minority Business Enterprise means a business which is a sole proprietorship, partnership or corporation at least 51% of which is owned and controlled by persons who are African American, Hispanic, Asian American, American Indian or Alaskan native, defined as follows:

**African American:** a person having origins in any of the black racial groups of Africa

**Hispanic:** a person of Mexican, Puerto Rican, Central or South American or other non-European Spanish culture or origin regardless of race.

**Asian:** a person having origins in any of the original peoples of the Far East, South East Asia, Indian subcontinent, Hawaii or the Pacific Islands.

**American Indian or Alaskan Native:** a person having origins in any of the original peoples of North America and who maintains cultural identification through tribal affiliation or community recognition.

**Woman Business Enterprise**

Woman Business Enterprise means a business which is a sole proprietorship, partnership or corporation at least 51% of which is owned and controlled by a woman or women.

Minority/Woman Business Enterprise (MWBE)  
Questionnaire for Bidders

Jersey City Ordinance C-829 establishes a goal of awarding 20% of the dollar amount of total city procurement to minority and woman owned business enterprises.

To assist us in monitoring our achievement of this goal, please indicate below whether your company is or is not a minority owned and/or woman owned business, and return this form with your bid proposal.

Business Name: CITY AUTO & TRUCK PARTS LLC  
Address: 1522 KENNEDY BLVD. JERSEY CITY NJ 07305  
Telephone No.: 201-432-3321  
Contact Name: SEWPERMAN RAMDAS

Please check applicable category:

Minority Owned Business (MBE)       Minority & Woman Owned Business (MWBE)  
 Woman Owned business (WBE)       Neither

**Definitions**

**Minority Business Enterprise**

Minority Business Enterprise means a business which is a sole proprietorship, partnership or corporation at least 51% of which is owned and controlled by persons who are African American, Hispanic, Asian American, American Indian or Alaskan native, defined as follows:

**African American:** a person having origins in any of the black racial groups of Africa

**Hispanic:** a person of Mexican, Puerto Rican, Central or South American or other non-European Spanish culture or origin regardless of race.

**Asian:** a person having origins in any of the original peoples of the Far East, South East Asia, Indian subcontinent, Hawaii or the Pacific Islands.

**American Indian or Alaskan Native:** a person having origins in any of the original peoples of North America and who maintains cultural identification through tribal affiliation or community recognition.

**Woman Business Enterprise**

Woman Business Enterprise means a business which is a sole proprietorship, partnership or corporation at least 51% of which is owned and controlled by a woman or women.

DIVISION OF PURCHASING COPY



CITY OF JERSEY CITY  
DIVISION OF PURCHASING

394 CENTRAL AVENUE, 2ND FLOOR | JERSEY CITY, NJ 07307  
P: 201 547 5155/5156 | F: 201 547 8585



STEVEN M. FULOP  
MAYOR OF JERSEY CITY

PETER FOLGADO  
DIRECTOR OF PURCHASING, O.P.A., R.P.P.O.

CERTIFICATION REGARDING SUSPENSION/DEBARMENT

I am Sebastian Rando of the firm of CITY AERO & TREE PARTS LLC

the Contractor who submitted the lowest responsible bid for the project known as

AUTO PARTS ETC.

I executed the Proposal submitted to the City of Jersey City with the full authority to do

so. As of the date of execution of this Certification on this 18 day of OCT,

2018, the firm of CITY AERO & TREE PARTS LLC has not been suspended or debarred

from submitting bid proposals by the United States of America, its departments,

divisions, and agencies or by the State of New Jersey, its departments, divisions, and

agencies.

I certify that the foregoing statements are true. I am aware that if any of the foregoing statements made by me are willfully false, I am subject to punishment.

CITY AERO & TREE PARTS LLC  
(Name of Contractor)

Signed By:

Dated:

Title:

Sworn and subscribed to before me  
This 18 day of OCT, 2018

Jennifer Malia  
JENNIFER MALIA  
NOTARY PUBLIC  
\*Must be returned with bid only if total bid amount exceeds \$100,000.00  
MY COMMISSION EXPIRES MAY 11, 2020

Certification 53046

# CERTIFICATE OF EMPLOYEE INFORMATION REPORT

## INITIAL

This is to certify that the contractor listed below has submitted an Employee Information Report pursuant to N.J.A.C. 17:27-1.1 et. seq. and the State Treasurer has approved said report. This approval will remain in effect for the period of 15 JUL 2014 to 15 JUL 2021.

CITY AUTO & TRUCK PARTS LLC  
1522 KENNEDY BLVD  
JERSEY CITY NJ 07305



Andrew P. Sidamon-Einstoff  
State Treasurer

Certification 53046

# CERTIFICATE OF EMPLOYEE INFORMATION REPORT

## INITIAL

This is to certify that the contractor listed below has submitted an Employee Information Report pursuant to N.J.A.C. 17:27-4.1 et seq and the State Treasurer has approved said report. This approval will remain in effect for the period of 15 months from 07/15/2021 to 10/15/2021.



CITY AUTO & TRUCK PARTS LLC  
1522 KENNEDY BLVD.  
JERSEY CITY NJ 07305

  
Andrew P. Sidamon-Eristoff  
State Treasurer



## STATE OF NEW JERSEY BUSINESS REGISTRATION CERTIFICATE

<b>Taxpayer Name:</b>	CITY AUTO & TRUCK PARTS, LIMITED LIABILITY COMPANY
<b>Trade Name:</b>	BAYONNE AUTO PARTS
<b>Address:</b>	1522 KENNEDY BOULEVARD JERSEY CITY, NJ 07305
<b>Certificate Number:</b>	1879851
<b>Effective Date:</b>	June 10, 2014
<b>Date of Issuance:</b>	October 23, 2018

**For Office Use Only:**

20181023091240867

OCT 18 '18 PM 2:46

**CERTIFICATION OF COMPLIANCE WITH THE CITY OF JERSEY CITY  
CONTRACTOR PAY-TO-PLAY REFORM ORDINANCE 08-128 ADOPTED  
ON SEPTEMBER 3, 2008**

**PART I - Vendor Affirmation**

The undersigned, being authorized and knowledgeable of the circumstances, does hereby certify that City Auto & Truck Parts LLC (name of business entity) has not made any reportable contributions in the \*\*one-year period preceding 10/18/18 (date City Council awards contract) that would be deemed to be violations of Section One of the City of Jersey City's Contractor Pay-to-Play Reform Ordinance 08-128 (attached hereto) and that would bar the award of this contract. I further certify that during the term of the contract City Auto & Truck Parts LLC (name of business entity) will not make any reportable contributions in violation of Ordinance 08-128.

**PART II - Signature and Attestation:**

The undersigned is fully aware that if I have misrepresented in whole or part this affirmation and certification, I and/or the business entity, will be liable for any penalty permitted under law.

Name of Business Entity: City Auto & Truck Parts LLC

Signed: [Signature] Title: Pres

Print Name: Sandra S. Boudry Date: 10/18/18

Subscribed and sworn before me  
this 18 day of October 2018.  
My Commission expires:

Jennifer Malia  
(Affiant)  
Jennifer Malia

(Print name & title of affiant) (Corporate Seal)



\*\*Pursuant to Section 2 of Ordinance 08-128, no contributions or solicitation of contributions made prior to the effective date Ordinance 08-128 (September 23, 2008) shall be deemed to be a violation of the Ordinance.



**BUSINESS ENTITY DISCLOSURE CERTIFICATION**  
**FOR NON-FAIR AND OPEN CONTRACTS**  
 Required Pursuant To N.J.S.A. 19:44A-20.8  
**CITY OF JERSEY CITY**

**Part I – Vendor Affirmation**

The undersigned, being authorized and knowledgeable of the circumstances, does hereby certify that the <name of business entity> has not made and will not make any reportable contributions pursuant to N.J.S.A. 19:44A-1 et seq. that, pursuant to P.L. 2004, c. 19 would bar the award of this contract in the one year period preceding (date of award scheduled for approval of the contract by the governing body) to any of the following named candidate committee, joint candidates committee; or political party committee representing the elected officials of the <name of entity of elected officials> as defined pursuant to N.J.S.A. 19:44A-3(p), (q) and (r).

Steven Fulop for Mayor 2017	Mira Prinz-Arey for Council
Lavarro for Councilman	Friends of Richard Boggiano
Friends of Joyce Watterman	Michael Yun for Council
Friends of Daniel Rivera	Solomon for Council
Ridley for Council	Friends of Jermaine Robinson

**Part II – Ownership Disclosure Certification**

I certify that the list below contains the names and home addresses of all owners holding 10% or more of the issued and outstanding stock of the undersigned.

Check the box that represents the type of business entity:

- Partnership     
  Corporation     
  Sole Proprietorship     
  Subchapter S Corporation  
 Limited Partnership     
  Limited Liability Corporation     
  Limited Liability Partnership

Name of Stock or Shareholder	Home Address
David Andrew Landis	1250.5TH STREET BRIDGE NJ 07002

**Part 3 – Signature and Attestation:**

The undersigned is fully aware that if I have misrepresented in whole or part this affirmation and certification, I and/or the business entity, will be liable for any penalty permitted under law.

Name of Business Entity: City of Jersey City LLC  
 Signature of Affiant: \_\_\_\_\_  
 Printed Name of Affiant: David Andrew Landis Date: 10/18/18

Subscribed and sworn before me this 18 day of October, 2018.

Jennifer Malia  
 (Witnessed or attested by)  
 \_\_\_\_\_  
 (Seal)

My Commission expires:  
**JENNIFER MALIA**  
**NOTARY PUBLIC**  
**STATE OF NEW JERSEY**  
**MY COMMISSION EXPIRES MAY 11, 2020**



Continuation Page

C. 271 POLITICAL CONTRIBUTION DISCLOSURE FORM

Required Pursuant To N.J.S.A. 19:44A-20.26

Page \_\_\_ of \_\_\_

Vendor Name:

Contributor Name	Recipient Name	Date	Dollar Amount \$

Check here if the information is continued on subsequent page(s)

# Resolution of the City of Jersey City, N.J.

City Clerk File No. Res. 18-992

Agenda No. 10.Z.7

Approved: NOV 07 2018

TITLE:

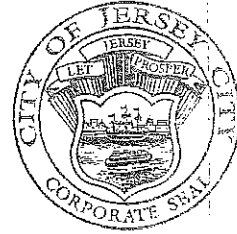

## RESOLUTION AUTHORIZING THE RENEWAL OF OPEN - END CONTRACTS WITH A&B UNDERCAR REPAIR INC; AGM TRANSMISSION LLC, DAVE'S TRANSMISSION AND ZOLAND CORPORATION FOR TRANSMISSION REPAIRS FOR THE DEPARTMENT OF PUBLIC WORKS / DIVISION OF AUTOMOTIVE MAINTENANCE

COUNCIL  
THE FOLLOWING RESOLUTION:

OFFERED AND MOVED ADOPTION OF

**WHEREAS**, Resolution No. 17-878, approved on November 16, 2017, awarded one-year contracts to **A&B Undercar Repair Inc**; for **\$287,000.00**; **AGM Transmission** for \$305,000.00, **Dave's Transmission** for \$320,000.00 and **Zoland Corporation**, for \$325,000.00 for transmission repairs for the City of Jersey City (City), Department of Public Works / Division of Automotive Maintenance; and

**WHEREAS**, the bid specifications provided the City with options to renew the contract for up to two additional one year periods with the renewal contract price being the preceding year's contract price as adjusted according to the Federal Consumer Price Index published by the Bureau of Labor Statistics; and

**WHEREAS**, pursuant to N.J.S.A. 40A:11-15, the City desires to exercise the first option and renew the contract for an additional one-year period effective as of **November 17, 2018 and ending on November 16, 2019**; and

**WHEREAS**, the contractor has been performing the services in an effective and efficient manner; and

**WHEREAS**, the total cost of the contract renewal to **A&B Undercar Repair Inc** for \$293,314.00; **AGM Transmission** for \$311,710.00 **Dave's Transmission** for \$327,040.00 and **Zoland Corporation**, for \$332,150.00; and

**WHEREAS**, funds are available in the **Division of Automotive Maintenance Operating Account No. 18-01-201-26-315-310**.

**NOW, THEREFORE BE IT RESOLVED** by the Municipal Council of the City of Jersey City that:

- 1) The Mayor or Business Administrator is authorized to renew the agreements with **A&B Undercar Repair Inc**; **AGM Transmission**, **Dave's Transmission**, and **Zoland Corporation** for transmission repairs for the City of Jersey City (City), Department of Public Works, Division of Automotive Maintenance;
- 2) The renewal contract is for a one-year period effective as of November 17, 2018, and the total cost of the contract shall not exceed with **A&B Undercar Repair Inc** for \$293,314.00; **AGM Transmission** for \$311,710.00 **Dave's Transmission** for \$327,040.00 and **Zoland Corporation**, for \$332,150.00;
- 3) Upon certification by an official or employee of the City authorized to attest that the contractor has complied with the specifications in all respects, and the requirements of the contract met, then payment to the contractor shall be made in accordance with the provisions of the Local Fiscal Affairs Law, N.J.S.A. 40A:5-1 et seq.;

(Continued on Page 2)

**TITLE: RESOLUTION AUTHORIZING THE RENEWAL OF OPEN - END CONTRACTS WITH A&B UNDERCAR REPAIR INC; AGM TRANSMISSION LLC, DAVE'S TRANSMISSION AND ZOLAND CORPORATION FOR TRANSMISSION REPAIRS FOR THE DEPARTMENT OF PUBLIC WORKS / DIVISION OF AUTOMOTIVE MAINTENANCE**

- 4) Pursuant to N.J.A.C. 5:30-5.5(c), the continuation of the contract after the expenditure of funds encumbered in 2018 fiscal year permanent budget shall be subject to the appropriation of sufficient funds in the 2019 fiscal year temporary budget and in the subsequent fiscal year budget; and
- 5) The award of this contract shall be subject to the condition that the vendor provides satisfactory evidence of compliance with the Affirmative Action Amendments to the Law Against Discrimination, N.J.S.A. 10-5-31 et seq.

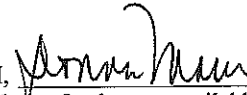
I,  Donna Mauer, as Chief Financial Officer, hereby certify that these funds are available for this expenditure in Automotive Maintenance Operating Account No. 18-01-201-26-315-310 for payment of the above resolution.

<u>VENDOR NAME</u>	<u>PURCHASE ORDER #</u>	<u>CONTRACT AMOUNT</u>	<u>TEMPORARY ENCUMBRANCY</u>
A&B	131113	\$293,314.00	\$20,000.00
AGM	131114	\$311,710.00	\$20,000.00
DAVE'S	131115	\$327,040.00	\$20,000.00
ZOLAND	131116	\$332,150.00	\$20,000.00

*JMcK*  
*10/26/18*

October 26, 2018

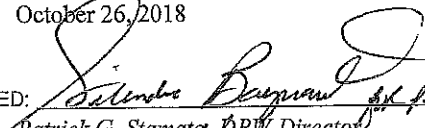
APPROVED:  10/26/18  
 Patrick G. Stamaty, DPW Director

APPROVED: \_\_\_\_\_  
 Business Administrator

APPROVED AS TO LEGAL FORM

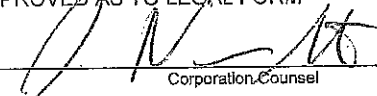
  
 Corporation Counsel

Certification Required

Not Required

APPROVED 8-0

<b>RECORD OF COUNCIL VOTE ON FINAL PASSAGE 11.7.18</b>											
COUNCILPERSON	AYE	NAY	N.V.	COUNCILPERSON	AYE	NAY	N.V.	COUNCILPERSON	AYE	NAY	N.V.
RIDLEY	✓			YUN	✓			RIVERA	✓		
PRINZ-AREY	✓			SOLOMON	✓			WATTERMAN	ABSENT		
BOGGIANO	✓			ROBINSON	✓			LAVARRO, PRES	✓		

✓ Indicates Vote

N.V.-Not Voting (Abstain)

Adopted at a meeting of the Municipal Council of the City of Jersey City N.J.

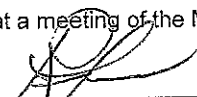
  
 Rolando R. Lavarro, Jr., President of Council

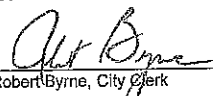
  
 Robert Byrne, City Clerk

**RESOLUTION FACT SHEET - CONTRACT AWARD**

This summary sheet is to be attached to the front of any resolution that is submitted for Council consideration. Incomplete or vague fact sheets will be returned with the resolution.

**Full Title of Ordinance/Resolution**

**RESOLUTION AUTHORIZING THE RENEWAL OF OPEN - END CONTRACTS WITH A&B UNDERCAR REPAIR INC; AGM TRANSMISSION LLC, DAVE'S TRANSMISSION AND ZOLAND CORPORATION FOR TRANSMISSION REPAIRS FOR THE DEPARTMENT OF PUBLIC WORKS / DIVISION OF AUTOMOTIVE MAINTENANCE**

**Project Manager**

Department/Division	DPW	Automotive
Name/Title	Hector Ortiz Martin Valenti	Asst. DPW Director Automotive Director
Phone/email	201-547-4400 201-547-4422	ortizh@icnj.org mvalenti@icnj.org

Note: Project Manager must be available by phone during agenda meeting (Wednesday prior to council meeting @ 4:00 p.m.)

**Contract Purpose**

- ✦ Provide transmission repairs to the City's fleet as needed.
- ✦ Contract awarded to four (4) vendors.
- ✦ They are all local Jersey City vendors.
- ✦ Open end contract.
- ✦ DPW spent about \$500,000.00.

**Cost (Identify all sources and amounts)**

01-201-26-315-310 (Automotive Operating)  
Total Contract amount=\$1,210,214.00  
Temporary Encumbrancy =\$80,000.00

**Contract term (include all proposed renewals)**

11/17/18 to 11/16/19.  
One (1) more option remaining.

**Type of award**

**Contract Renewal – Public Bid**

**If "Other Exception", enter type**

**Additional Information**

I certify that all the facts presented herein are accurate.

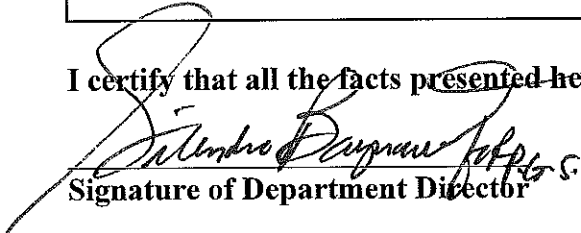
  
Signature of Department Director

10/26/18  
Date

Signature of Purchasing Director

Date

# Resolution of the City of Jersey City, N.J.

City Clerk File No. Res. 17-878

Agenda No. 10.Y

Approved: NOV 16 2017



**TITLE:**

**RESOLUTION AUTHORIZING THE AWARD OF OPEN-END CONTRACTS TO A&B UNDERCAR REPAIR INC., AGM TRANSMISSION LLC, DAVE'S TRANSMISSION AND ZOLAND CORP. FOR TRANSMISSION REPAIRS FOR THE DEPARTMENT OF PUBLIC WORKS/DIVISION OF AUTOMOTIVE MAINTENANCE**

**COUNCIL**

offered and moved adoption of the following Resolution:

WHEREAS, the City of Jersey City (City) advertised for the receipt of bids on September 28, 2017 for transmission repair services for the Department of Public Works/Division of Automotive Maintenance; and

WHEREAS, the City received bids from a total of four (4) vendors; and

WHEREAS, the vendors that submitted bids are A&B Undercar Repair Inc., AGM Transmission LLC, Dave's Transmission and Zoland Corp.; and

WHEREAS, because of the large number of vehicles that the City owns there will be times when the primary vendor will not have enough capacity at its facility to accept all of the vehicles that the City sends for transmission repairs services; and

WHEREAS, when the primary vendor is unable to accept a vehicle, the City will select alternate vendor no. 1 to perform the services, and if alternate vendor no. 1 is unable to perform the services, the City will select alternate vendor no. 2 to perform the services, and if alternate vendor no. 2 is unable to perform the services, the City will select alternate vendor no. 3 to perform the services; and

WHEREAS, the contracts were bid as one (1) year open-end contracts with the following minimum and maximum quantities specified:

	<u>Minimum</u>	<u>Maximum</u>
Transmission Repairs	0	3000 estimated hours
Parts and Materials	0	\$100,000 estimated cost

WHEREAS, the bidders submitted the following quotes:

	<u>Hourly Labor Rate</u>	<u>Materials Markup</u>	<u>Total Cost</u>
A&B (primary vendor)	\$59.00	10%	\$287,000.00
AGM (Alternate no. 1)	\$65.00	10%	\$305,000.00
Dave's (Alternate no. 2)	\$70.00	10%	\$320,000.00
Zoland (Alternate no. 3)	\$70.00	15%	\$325,000.00; and

WHEREAS, the Total Cost is calculated by multiplying the hourly labor rate by 3000 estimated hours and adding to that number the \$100,000 estimated cost for repair parts and materials plus the percentage markup; and

WHEREAS, the Purchasing Agent has certified that he considers the bids submitted by all the bidders to be fair and reasonable; and

WHEREAS, the sum of Forty Thousand (\$40,000.00) Dollars is available in Automotive Operating Account No. 01-201-26-315-310; and

WHEREAS, the balance of the contract funds will be made available as the City places orders for services.

(continued on Page 2)

Continuation of Resolution \_\_\_\_\_  
 City Clerk File No. Res. 17-878  
 Agenda No. 10.Y **NOV 16 2017**

**TITLE: RESOLUTION AUTHORIZING THE AWARD OF OPEN-END CONTRACTS TO A&B UNDERCAR REPAIR INC., AGM TRANSMISSION LLC, DAVE'S TRANSMISSION AND ZOLAND CORP. FOR TRANSMISSION REPAIRS FOR THE DEPARTMENT OF PUBLIC WORKS/DIVISION OF AUTOMOTIVE MAINTENANCE**

NOW, THEREFORE, be it resolved by the Municipal Council of the City of Jersey City that:

1. The Mayor or Business Administrator is authorized to execute agreements with A&B Undercar Repair Inc, AGM Transmission LLC, Dave's Transmission and Zoland Corp. for transmission repairs for the Department of Public Works/Division of Automotive Maintenance;
2. The contracts are awarded as one (1) year open-end contracts based on the hourly labor rates and parts and materials percentage markups set forth above and based on estimated quantities of 3000 hours for labor and \$100,000.00 for repair parts and materials;
3. The City reserves the right to extend the contracts for up to two (2) additional one (1) year terms pursuant to the terms and conditions of the bid specifications;
4. The Chief Financial Officer shall prepare and execute certificates of available funds as orders are made during the term of the contracts;
5. Upon certification by an official or employee of the City authorized to attest that the vendors have complied with specifications in all respects, and the requirements of the contracts met, then payment to the vendors shall be made in accordance with the provisions of the Local Fiscal Affairs Law, N.J.S.A. 40A:5-1 et seq.; and
6. The awards of these contracts shall be subject to the condition that the vendors provide satisfactory evidence of compliance with the Affirmative Action Amendments to the Law Against Discrimination, N.J.S.A. 10:5-31 et seq.

I, Donna Mauer (Donna Mauer), Chief Financial Officer, certify that there are sufficient funds available for the payment of the above resolution in Account shown below:

Department of Public Works/Division of Automotive Maintenance			Amount
Acct #	P.O#		
01-201-26-315-310	126843	Temp. Encumb. A&B Undercar	\$10,000.00
01-201-26-315-310	126844	Temp. Encumb. AGM	\$10,000.00
01-201-26-315-310	126845	Temp. Encumb. Dave's	\$10,000.00
01-201-26-315-210	126846	Temp. Encumb. Zoland	\$10,000.00
Total Temp. Encumb.			\$40,000.00

Approved by Peter Folgado 10/27/17  
 Director of Purchasing, QPA

APPROVED: [Signature]  
 Business Administrator

APPROVED AS TO LEGAL FORM  
[Signature]  
 Corporation Counsel

P.R.  
11-2-17

Certification Required   
 Not Required  APPROVED 7-0

RECORD OF COUNCIL VOTE ON FINAL PASSAGE 11.16.17											
COUNCILPERSON	AYE	NAY	N.V.	COUNCILPERSON	AYE	NAY	N.V.	COUNCILPERSON	AYE	NAY	N.V.
GAJEWSKI		ABSENT		YUN	✓			RIVERA	✓		
GADSDEN	✓			OSBORNE	ABSENT			WATTMAN	✓		
BOGGIANO	✓			ROBINSON	✓			LAVARRO, PRES	✓		

✓ Indicates Vote

N.V.-Not Voting (Abstain)

Adopted at a meeting of the Municipal Council of the City of Jersey City N.J.

[Signature]  
 Rolanda R. Lavarro, Jr., President of Council

[Signature]  
 Robert Byrne, City Clerk



## Mid-Atlantic Information Office

[Geographic Information](#) > [Mid-Atlantic](#) > News Release

### Consumer Price Index, Northeast Region – September 2018

**Regional prices increased 0.1 percent over the month, 2.2 percent over the year**

The Consumer Price Index for All Urban Consumers (CPI-U) in the Northeast inched up 0.1 percent in September, the U.S. Bureau of Labor Statistics reported today. Shella Watkins, the Bureau's regional commissioner, noted that this was mostly due to a 0.1-percent increase in the all items less food and energy index. The food index also increased over the month, up 0.2 percent, while the energy index was unchanged. (Data in this report are not seasonally adjusted. Accordingly, month-to-month changes may reflect the impact of seasonal influences.)

Over the last 12 months, the Northeast all items CPI-U increased 2.2 percent. (See [chart 1](#) and [table A](#).) The all items less food and energy index led the advance, rising 1.8 percent. The energy index and the food index also rose, up 5.9 and 2.4 percent, respectively, since September 2017. (See [table 1](#).)

#### News Release Information

18-1664-PHI  
Thursday, October 11, 2018

#### Contacts

**Technical information:**  
(215) 597-3282  
[BLSirtoPhiladelphia@bls.gov](mailto:BLSirtoPhiladelphia@bls.gov)  
[www.bls.gov/regions/mid-atlantic](http://www.bls.gov/regions/mid-atlantic)

**Media contact:**  
(215) 861-5600  
[BLSMediaPhiladelphia@bls.gov](mailto:BLSMediaPhiladelphia@bls.gov)

#### PDF

[PDF version](#)

**Chart 1. Over-the-year percent change in CPI-U, Northeast region, September 2015–September 2018**

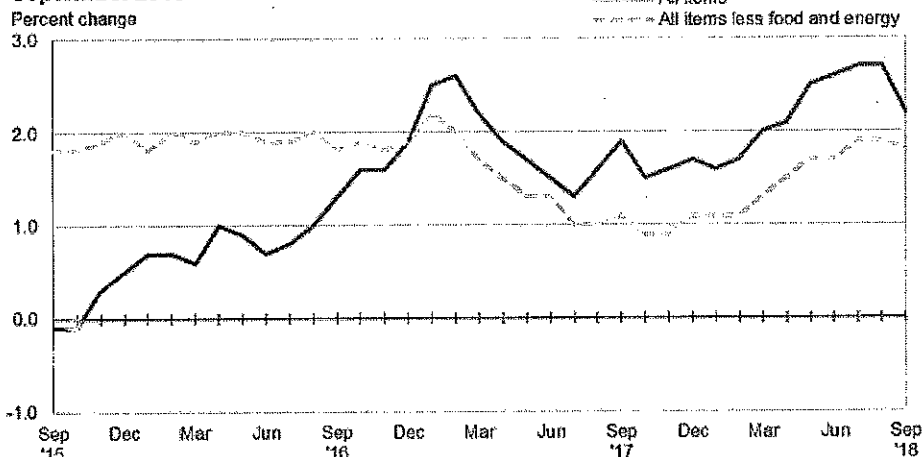

Source: U.S. Bureau of Labor Statistics.

#### Food

The food index edged up 0.2 percent since August as prices for food at home increased 0.3 percent. Food away from home prices also rose, inching up 0.1 percent.

From September 2017 to September 2018, the food index increased 2.4 percent. Prices for both food away from home and food at home increased over the year, up 2.8 and 2.1 percent, respectively.

#### Energy

The energy index, which includes prices for household and transportation fuels, was unchanged in September. Gasoline prices inched up 0.1 percent since August, while prices for utility (piped) gas service and electricity decreased, down 0.4 and 0.1 percent, respectively.

The energy index advanced 5.9 percent since September 2017. The increase reflected higher prices for gasoline, up 6.5 percent. Prices also increased over the year for utility (piped) gas service (5.8 percent) and electricity (2.1 percent).

## All items less food and energy

The index for all items less food and energy inched up 0.1 percent over the month. Higher prices for apparel (4.3 percent), among others, were moderated by lower prices for new and used motor vehicles (-1.8 percent) and shelter (-0.2 percent).

The index for all items less food and energy increased 1.8 percent since September 2017, led by higher prices for shelter, up 2.8 percent. Prices also rose over the year for medical care (2.1 percent) and education and communication (1.9 percent), but were lower for apparel (-1.9 percent), among others.

**Table A. Northeast region CPI-U 1-month and 12-month percent changes, all items index, not seasonally adjusted**

Month	2014		2015		2016		2017		2018	
	1-month	12-month	1-month	12-month	1-month	12-month	1-month	12-month	1-month	12-month
January	0.6	1.5	-0.2	-0.4	0.0	0.7	0.6	2.5	0.5	1.6
February	0.1	1.0	0.2	-0.2	0.2	0.7	0.3	2.6	0.4	1.7
March	0.5	1.5	0.3	-0.4	0.2	0.6	-0.1	2.2	0.1	2.0
April	0.0	1.6	0.1	-0.3	0.6	1.0	0.3	1.9	0.4	2.1
May	0.4	2.0	0.4	-0.3	0.3	0.9	0.1	1.7	0.4	2.5
June	0.0	1.9	0.3	0.0	0.2	0.7	0.0	1.5	0.0	2.6
July	0.1	1.8	-0.1	-0.2	0.0	0.8	-0.2	1.3	0.0	2.7
August	-0.3	1.3	-0.2	-0.1	0.1	1.0	0.3	1.6	0.2	2.7
September	0.0	1.2	0.0	-0.1	0.2	1.3	0.5	1.9	0.1	2.2
October	-0.2	1.4	-0.2	-0.1	0.2	1.6	-0.1	1.5		
November	-0.4	0.9	0.0	0.3	0.0	1.6	0.0	1.6		
December	-0.5	0.4	-0.4	0.5	0.0	1.9	0.1	1.7		

The Consumer Price Index for October 2018 is scheduled to be released Wednesday, November 14, 2018, at 8:30 a.m. (ET).

### Technical Note

The Consumer Price Index (CPI) is a measure of the average change in prices over time in a fixed market basket of goods and services. The Bureau of Labor Statistics publishes CPIs for two population groups: (1) a CPI for All Urban Consumers (CPI-U) which covers approximately 93 percent of the total population and (2) a CPI for Urban Wage Earners and Clerical Workers (CPI-W) which covers approximately 29 percent of the total population. The CPI-U includes, in addition to wage earners and clerical workers, groups such as professional, managerial, and technical workers, the self-employed, short-term workers, the unemployed, and retirees and others not in the labor force.

The CPI is based on prices of food, clothing, shelter, and fuels, transportation fares, charges for doctors' and dentists' services, drugs, and the other goods and services that people buy for day-to-day living. Each month, prices are collected in 75 urban areas across the country from about 5,000 housing units and approximately 22,000 retail establishments--department stores, supermarkets, hospitals, filling stations, and other types of stores and service establishments. All taxes directly associated with the purchase and use of items are included in the index.

The index measures price changes from a designated reference date (1982-84) that equals 100.0. An increase of 16.5 percent, for example, is shown as 116.5. This change can also be expressed in dollars as follows: the price of a base period "market basket" of goods and services in the CPI has risen from \$10 in 1982-84 to \$11.65. For further details see the CPI home page on the Internet at [www.bls.gov/cpi](http://www.bls.gov/cpi) and the BLS Handbook of Methods, Chapter 17, The Consumer Price Index, available on the Internet at [www.bls.gov/opub/hom/pdf/homch17.pdf](http://www.bls.gov/opub/hom/pdf/homch17.pdf).

In calculating the index, price changes for the various items in each location are averaged together with weights that represent their importance in the spending of the appropriate population group. Local data are then combined to obtain a U.S. city average. Because the sample size of a local area is smaller, the local area index is subject to substantially more sampling and other measurement error than the national index. In addition, local indexes are not adjusted for seasonal influences. As a result, local area indexes show greater volatility than the national index, although their long-term trends are quite similar. **Note: Area indexes do not measure differences in the level of prices between cities; they only measure the average change in prices for each area since the base period.**

The Northeast region is comprised of Connecticut, Maine, Massachusetts, New Hampshire, New Jersey, New York, Pennsylvania, Rhode Island, and Vermont.

Information in this release will be made available to sensory impaired individuals upon request. Voice phone: (202) 691-5200; Federal Relay Service: (800) 877-8339.

**Table 1. Consumer Price Index for All Urban Consumers (CPI-U): Indexes and percent changes for selected periods, Northeast Region, (1982-84=100 unless otherwise noted) (not seasonally adjusted)**

Expenditure category	Indexes				Percent change from		
	Historical data	Jul. 2018	Aug. 2018	Sep. 2018	Sep. 2017	Jul. 2018	Aug. 2018
All items	NY	265.830	266.425	266.709	2.2	0.3	0.1
All items (December 1977 = 100)	NY	418.601	419.537	419.984			
Food and beverages	NY	260.347	260.775	261.441	2.4	0.4	0.3
Food	NY	260.792	261.235	261.747	2.4	0.4	0.2
Food at home	NY	249.803	250.062	250.733	2.1	0.4	0.3
Cereals and bakery products	NY	293.679	295.222	297.692		1.4	0.8
Meats, poultry, fish, and eggs	NY	253.426	252.192	252.235		-0.5	0.0
Dairy and related products	NY	227.522	227.518	228.371		0.4	0.4
Fruits and vegetables	NY	311.877	314.739	314.943		1.0	0.1
Nonalcoholic beverages and beverage materials	NY	173.237	173.848	174.920		1.0	0.6
Other food at home	NY	224.812	224.101	224.313		-0.2	0.1
Food away from home	NY	280.675	281.392	281.681	2.8	0.4	0.1
Alcoholic beverages	NY	253.506	253.746	256.285	1.3	1.1	1.0
Housing	NY	283.331	284.496	284.068	2.8	0.3	-0.2
Shelter	NY	351.001	353.180	352.325	2.8	0.4	-0.2
Rent of primary residence	NY	351.404	352.801	352.964	2.4	0.4	0.0
Owners' equivalent rent of residences <sup>(1)</sup>	NY	362.176	363.229	363.828	2.8	0.5	0.2
Owners' equivalent rent of primary residence <sup>(1)</sup>	NY	361.919	362.959	363.548	2.7	0.5	0.2
Fuels and utilities	NY	230.350	228.798	228.782	4.7	-0.7	0.0
Household energy	NY	204.419	202.826	202.909	4.9	-0.7	0.0
Energy services	NY	201.014	198.979	198.649	2.7	-1.2	-0.2
Electricity	NY	208.488	205.791	206.649	2.1	-0.9	-0.1
Utility (piped) gas service	NY	173.183	170.756	170.144	5.8	-1.8	-0.4
Household furnishings and operations	NY	119.322	119.132	119.798	0.9	0.4	0.6
Apparel	NY	124.772	128.098	133.579	-1.9	7.1	4.3
Transportation	NY	210.687	209.626	208.790	2.5	-0.9	-0.4
Private transportation	NY	203.643	202.941	201.641	2.8	-1.0	-0.6
New and used motor vehicles <sup>(2)</sup>	NY	97.374	96.666	94.963	0.9	-2.5	-1.8
New vehicles	NY	143.208	142.147	142.888	0.2	-0.2	0.5
New cars and trucks <sup>(2)(3)</sup>	NY	99.247	98.528	99.039	0.3	-0.2	0.5
New cars <sup>(3)</sup>	NY	132.623	131.954	133.164	0.7	0.4	0.9
Used cars and trucks	NY	146.808	147.009	140.686	-1.1	-4.0	-4.3
Motor fuel	NY	250.214	250.129	250.269	6.6	0.0	0.1
Gasoline (all types)	NY	249.152	249.080	249.207	6.5	0.0	0.1
Gasoline, unleaded regular <sup>(4)</sup>	NY	246.882	246.777	246.887	6.5	0.0	0.0
Gasoline, unleaded midgrade <sup>(4)(5)</sup>	NY	261.981	262.230	262.527	7.4	0.2	0.1
Gasoline, unleaded premium <sup>(4)</sup>	NY	254.288	254.421	254.650	6.7	0.1	0.1
Motor vehicle insurance <sup>(5)</sup>	NY	615.988	615.044	618.684		0.4	0.6
Medical care	NY	504.541	505.303	506.476	2.1	0.4	0.2
Medical care commodities	NY	390.243	393.895	390.537	1.2	0.1	-0.9
Medical care services	NY	537.320	537.191	539.751	2.3	0.5	0.5
Professional services	NY	380.806	380.306	384.604	1.8	1.0	1.1
Recreation <sup>(2)</sup>	NY	123.961	123.684	124.007	-0.3	0.0	0.3
Education and communication <sup>(2)</sup>	NY	141.292	141.673	142.428	1.9	0.8	0.5
Tuition, other school fees, and child care <sup>(5)</sup>	NY	1,220.420	1,231.560	1,240.184		1.6	0.7
Other goods and services	NY	488.926	488.910	488.993	2.2	0.0	0.0
Commodity and service group							
Commodities	NY	191.270	191.740	192.297	1.8	0.5	0.3
Commodities less food and beverages	NY	153.618	154.078	154.560	1.4	0.6	0.3
Nondurables less food and beverages	NY	200.744	202.015	204.009	2.4	1.6	1.0
Durables	NY	102.233	102.019	101.285	0.0	-0.9	-0.7
Services	NY	337.754	338.472	338.521	2.4	0.2	0.0
Special aggregate indexes							
Footnotes							
(1) Indexes on a December 1982=100 base.							
(2) Indexes on a December 1997=100 base.							
(3) Special index based on a substantially smaller sample.							
(4) Indexes on a December 1993=100 base.							
(5) Indexes on a December 1977=100 base.							

Expenditure category	Indexes				Percent change from		
	Historical data	Jul. 2018	Aug. 2018	Sep. 2018	Sep. 2017	Jul. 2018	Aug. 2018
All items less shelter	236.513	236.525	237.234	2.0	0.3	0.3	
All items less medical care	255.352	255.940	256.183	2.3	0.3	0.1	
Commodities less food	157.267	157.722	158.267	1.4	0.6	0.3	
Nondurables	230.734	231.630	233.034	2.4	1.0	0.6	
Nondurables less food	203.805	205.013	207.039	2.4	1.6	1.0	
Services less rent of shelter(1)	335.164	334.326	335.352	2.1	0.1	0.3	
Services less medical care services	323.997	324.773	324.650	2.5	0.2	0.0	
Energy	223.343	222.382	222.488	5.9	-0.4	0.0	
All items less energy	272.843	273.607	273.913	1.9	0.4	0.1	
All items less food and energy	276.730	277.552	277.826	1.8	0.4	0.1	

**Footnotes**  
(1) Indexes on a December 1982=100 base.  
(2) Indexes on a December 1997=100 base.  
(3) Special index based on a substantially smaller sample.  
(4) Indexes on a December 1993=100 base.  
(5) Indexes on a December 1977=100 base.

Last Modified Date: Thursday, October 11, 2018

RECOMMEND THIS PAGE USING: Facebook Twitter LinkedIn

**TOOLS**

Areas at a Glance  
Industries at a Glance  
Economic Releases  
Databases & Tables  
Maps

**CALCULATORS**

Inflation  
Injury And Illness

**HELP**

Help & Tutorials  
FAQs  
Glossary  
About BLS  
Contact Us

**INFO**

What's New  
Careers @ BLS  
Find It! DOL  
Join our Mailing Lists  
Linking & Copyright Info

**RESOURCES**

Inspector General (OIG)  
Budget and Performance  
No Fear Act  
USA.gov  
Benefits.gov

[Freedom of Information Act](#) | [Privacy & Security Statement](#) | [Disclaimers](#) | [Customer Survey](#) | [Important Web Site Notices](#)

U.S. Bureau of Labor Statistics | Mid-Atlantic Information Office, Suite 610-E, 170 South Independence Mall West, Philadelphia, PA 19106-3305  
[www.bls.gov/regions/mid-atlantic](http://www.bls.gov/regions/mid-atlantic) | Telephone: 1-215-597-DATA (or 3282) | [Contact Mid-Atlantic Region](#)

A & B UNDERCAR

Labor : Transmission Repair ( I )

Description	Unit of Measure	Estimated Number of Hours Annually (A)	Unit Cost (B)	Extended Cost (C) = AxB	Total
Labor - Transmission Repair	Hourly Rate	3000	\$ 59.00	\$177000.	\$ 177,000.00

Repair Parts and Materials (II)

Description	Estimated Annual Materials Cost (A)	% Mark-Up (B)	Mark-up Cost (C)AxB	Total
Repair Parts and Materials	\$200,000	10	\$ 10,000.00	\$ 210,000.00

GRAND TOTAL: TOTAL LABOR COST (I) PLUS TOTAL PARTS AND MATERIALS (II)

\$ Two Hundred Eighty Seven Thousand 00/100  
(In Writing)

\$ 287,000.00  
(In Figures)

NOTE: A bid must be entered for all items. Award of contract shall be based on all items being provided by one Contractor. The Failure to bid any one item will result in the automatic

2018

# **EEO/AFFIRMATIVE ACTION REQUIREMENTS**

## **Goods, Professional Services and General Service Contracts**

Questions in reference to EEO/AA Requirements For Goods, Professional Services and General Service Contracts should be directed to:

Jeana F. Abuan  
Spvg. Adm. Analyst, Public Agency Compliance Officer  
Department of Administration  
Office of Tax Abatement & Compliance  
13-15 Linden Avenue East  
Jersey City NJ 07305  
Tel. #201-547- 4538  
E-mail Address: [abuanJ@jcnj.org](mailto:abuanJ@jcnj.org)

(REVISED 4/13)

**EXHIBIT A**  
**MANDATORY EQUAL EMPLOYMENT OPPORTUNITY LANGUAGE**  
N.J.S.A. 10:5-31 et seq. (P.L. 1975, C. 127)  
N.J.A.C. 17:27

**GOODS, PROFESSIONAL SERVICE AND GENERAL SERVICE CONTRACTS**

During the performance of this contract, the contractor agrees as follows:

The contractor or subcontractor, where applicable, will not discriminate against any employee or applicant for employment because of age, race, creed, color, national origin, ancestry, marital status, affectional or sexual orientation, gender identity or expression, disability, nationality or sex. Except with respect to affectional or sexual orientation and gender identity or expression, the contractor will ensure that equal employment opportunity is afforded to such applicants in recruitment and employment, and that employees are treated during employment, without regard to their age, race, creed, color, national origin, ancestry, marital status, affectional or sexual orientation, gender identity or expression, disability, nationality or sex. Such equal employment opportunity shall include, but not be limited to the following: employment, upgrading, demotion, or transfer; recruitment or recruitment advertising; layoff or termination; rates of pay or other forms of compensation; and selection for training, including apprenticeship. The contractor agrees to post in conspicuous places, available to employees and applicants for employment, notices to be provided by the Public Agency Compliance Officer setting forth provisions of this nondiscrimination clause.

The contractor or subcontractor, where applicable will, in all solicitations or advertisements for employees placed by or on behalf of the contractor, state that all qualified applicants will receive consideration for employment without regard to age, race, creed, color, national origin, ancestry, marital status, affectional or sexual orientation, gender identity or expression, disability, nationality or sex.

The contractor or subcontractor will send to each labor union, with which it has a collective bargaining agreement, a notice, to be provided by the agency contracting officer, advising the labor union of the contractor's commitments under this chapter and shall post copies of the notice in conspicuous places available to employees and applicants for employment.

The contractor or subcontractor, where applicable, agrees to comply with any regulations promulgated by the Treasurer pursuant to N.J.S.A. 10:5-31 et seq., as amended and supplemented from time to time and the Americans with Disabilities Act.

The contractor or subcontractor agrees to make good faith efforts to meet targeted county employment goals established in accordance with N.J.A.C. 17:27-5.2.

EXHIBIT A (Continuation)

The contractor or subcontractor agrees to inform in writing its appropriate recruitment agencies including, but not limited to, employment agencies, placement bureaus, colleges, universities, and labor unions, that it does not discriminate on the basis of age, race, creed, color, national origin, ancestry, marital status, affectional or sexual orientation, gender identity or expression, disability, nationality or sex, and that it will discontinue the use of any recruitment agency which engages in direct or indirect discriminatory practices.

The contractor or subcontractor agrees to revise any of its testing procedures, if necessary, to assure that all personnel testing conforms with the principles of job-related testing, as established by the statutes and court decisions of the State of New Jersey and as established by applicable Federal law and applicable Federal court decisions.

In conforming with the targeted employment goals, the contractor or subcontractor agrees to review all procedures relating to transfer, upgrading, downgrading and layoff to ensure that all such actions are taken without regard to age, race, creed, color, national origin, ancestry, marital status, affectional or sexual orientation, gender identity or expression, disability, nationality or sex, consistent with the statutes and court decisions of the State of New Jersey, and applicable Federal law and applicable Federal court decisions.

The contractor shall submit to the public agency, after notification of award but prior to execution of a goods and services contract, one of the following three documents:

Letter of Federal Affirmative Action Plan Approval

Certificate of Employee Information Report

Employee Information Report Form AA302 (electronically provided by the Division and distributed to the public agency through the Division's website at [www.state.nj.us/treasury/contract\\_compliance](http://www.state.nj.us/treasury/contract_compliance))

The contractor and its subcontractors shall furnish such reports or other documents to the Division of Purchase & Property, CCAU, EEO Monitoring Program as may be requested by the office from time to time in order to carry out the purposes of these regulations, and public agencies shall furnish such information as may be requested by the Division of Purchase & Property, CCAU, EEO Monitoring Program for conducting a compliance investigation pursuant to Subchapter 10 of the Administrative Code at N.J.A.C. 17:27.

The undersigned vendor certifies on their company's receipt, knowledge and commitment to comply with:

EXHIBIT A  
N.J.S.A. 10:5-31 and N.J.A.C. 17:27  
MANDATORY EQUAL EMPLOYMENT OPPORTUNITY LANGUAGE  
Goods, Professional Services and General Service Contracts  
(Mandatory Affirmative Action Language)

The undersigned vendor further agrees to furnish the required forms of evidence and

understands that their contract/company's bid shall be rejected as non-responsive if said contractor fails to comply with the requirements of N.J.S.A. 10:5-31 and N.J.A.C. 17:27.

Representative's Name/Title (Print): MASCAN (SAM) ABU BAKR

Representative's Signature: [Signature]

Name of Company: A B UNDERCAR REPAIR INC

Tel. No. 201-659-3551 Date: 10/10/18



**APPENDIX A**  
**AMERICANS WITH DISABILITIES ACT OF 1990**  
**Equal Opportunity for Individuals with Disability**

The contractor and the \_\_\_\_\_ of \_\_\_\_\_, (hereafter "owner") do hereby agree that the provisions of Title 11 of the Americans With Disabilities Act of 1990 (the "Act") (42 U.S.C. 5121 01 et seq.), which prohibits discrimination on the basis of disability by public entities in all services, programs, and activities provided or made available by public entities, and the rules and regulations promulgated pursuant thereto, are made a part of this contract. In providing any aid, benefit, or service on behalf of the owner pursuant to this contract, the contractor agrees that the performance shall be in strict compliance with the Act. In the event that the contractor, its agents, servants, employees, or subcontractors violate or are alleged to have violated the Act during the performance of this contract, the contractor shall defend the owner in any action or administrative proceeding commenced pursuant to this Act. The contractor shall indemnify, protect, and save harmless the owner, its agents, servants, and employees from and against any and all suits, claims, losses, demands, or damages, of whatever kind or nature arising out of or claimed to arise out of the alleged violation. The contractor shall, at its own expense, appear, defend, and pay any and all charges for legal services and any and all costs and other expenses arising from such action or administrative proceeding or incurred in connection therewith. In any and all complaints brought pursuant to the owner's grievance procedure, the contractor agrees to abide by any decision of the owner which is rendered pursuant to said grievance procedure. If any action or administrative proceeding results in an award of damages against the owner, or if the owner incurs any expense to cure a violation of the ADA which has been brought pursuant to its grievance procedure, the contractor shall satisfy and discharge the same at its own expense.

The owner shall, as soon as practicable after a claim has been made against it, give written notice thereof to the contractor along with full and complete particulars of the claim. If any action or administrative proceeding is brought against the owner or any of its agents, servants, and employees, the owner shall expeditiously forward or have forwarded to the contractor every demand, complaint, notice, summons, pleading, or other process received by the owner or its representatives.

It is expressly agreed and understood that any approval by the owner of the services provided by the contractor pursuant to this contract will not relieve the contractor of the obligation to comply with the Act and to defend, indemnify, protect, and save harmless the owner pursuant to this paragraph.

It is further agreed and understood that the owner assumes no obligation to indemnify or save harmless the contractor, its agents, servants, employees and subcontractors for any claim which may arise out of their performance of this Agreement. Furthermore, the contractor expressly understands and agrees that the provisions of this indemnification clause shall in no way limit the contractor's obligations assumed in this Agreement, nor shall they be construed to relieve the contractor from any liability, nor preclude the owner from taking any other actions available to it under any other provisions of the Agreement or otherwise at law.

Representative's Name/Title (Print): NASSAN (SAM) ABU BAKR  
Representative's Signature: [Signature]  
Name of Company: A B Undercar Repair Inc  
Tel. No.: 201-659-3351 Date: 10/10/15

**Minority/Woman Business Enterprise (MWBE)  
Questionnaire for Bidders**

Jersey City Ordinance C-829 establishes a goal of awarding 20% of the dollar amount of total city procurement to minority and woman owned business enterprises.

To assist us in monitoring our achievement of this goal, please indicate below whether your company is or is not a minority owned and/or woman owned business, and return this form with your bid proposal.

Business Name : ASB Undercar Repair INC  
Address : 700 Tannele Ave  
Telephone No. : 201-659-3551  
Contact Name : Hassan Abu Balla

Please check applicable category :

Minority Owned Business (MBE)       Minority & Woman Owned Business (MWBE)  
 Woman Owned business (WBE)       Neither

**Definitions  
Minority Business Enterprise**

Minority Business Enterprise means a business which is a sole proprietorship, partnership or corporation at least 51% of which is owned and controlled by persons who are African American, Hispanic, Asian American, American Indian or Alaskan native, defined as follows:

**African American:** a person having origins in any of the black racial groups of Africa

**Hispanic:** a person of Mexican, Puerto Rican, Central or South American or other non-European Spanish culture or origin regardless of race.

**Asian:** a person having origins in any of the original peoples of the Far East, South East Asia, Indian subcontinent, Hawaii or the Pacific Islands.

**American Indian or Alaskan Native:** a person having origins in any of the original peoples of North America and who maintains cultural identification through tribal affiliation or community recognition.

**Woman Business Enterprise**

Woman Business Enterprise means a business which is a sole proprietorship, partnership or corporation at least 51% of which is owned and controlled by a woman or women.

**Minority/Woman Business Enterprise (MWBE)  
Questionnaire for Bidders**

Jersey City Ordinance C-829 establishes a goal of awarding 20% of the dollar amount of total city procurement to minority and woman owned business enterprises.

To assist us in monitoring our achievement of this goal, please indicate below whether your company is or is not a minority owned and/or woman owned business, and return this form with your bid proposal.

Business Name: ASB Undercar Repair Inc  
Address: 700 Tannock Ave Jersey City, NJ 07307  
Telephone No.: 201-659-3551  
Contact Name: Hassan Abu Bakr

Please check applicable category:

Minority Owned Business (MBE)       Minority & Woman Owned Business (MWBE)  
 Woman Owned business (WBE)       Neither

**Definitions**

**Minority Business Enterprise**

Minority Business Enterprise means a business which is a sole proprietorship, partnership or corporation at least 51% of which is owned and controlled by persons who are African American, Hispanic, Asian American, American Indian or Alaskan native, defined as follows:

**African American:** a person having origins in any of the black racial groups of Africa

**Hispanic:** a person of Mexican, Puerto Rican, Central or South American or other non-European Spanish culture or origin regardless of race.

**Asian:** a person having origins in any of the original peoples of the Far East, South East Asia, Indian subcontinent, Hawaii or the Pacific Islands.

**American Indian or Alaskan Native:** a person having origins in any of the original peoples of North America and who maintains cultural identification through tribal affiliation or community recognition.

**Woman Business Enterprise**

Woman Business Enterprise means a business which is a sole proprietorship, partnership or corporation at least 51% of which is owned and controlled by a woman or women.

**DIVISION OF PURCHASING COPY**



STATE OF NEW JERSEY  
DEPARTMENT OF THE TREASURY  
Division of Public Contracts Equal Employment Opportunity Compliance

**DUPLICATE CERTIFICATE OF EMPLOYEE INFORMATION REPORT REQUEST**

IMPORTANT- FAILURE TO PROPERLY COMPLETE THE ENTIRE FORM AND SUBMIT THE REQUIRED \$75.00 FEE (Non-Refundable)  
MAY DELAY ISSUANCE OF YOUR DUPLICATE CERTIFICATE OF EMPLOYEE INFORMATION REPORT.

SECTION A - COMPANY IDENTIFICATION

1. FED. NO. OR SOCIAL SECURITY	2. ASSIGNED CERTIFICATION NUMBER	ISSUE DATE	EXPIRATION DATE
	31498	09-15-16	09-15-23

3. COMPANY NAME *A/B UNDERCAR REPAIR INC.*

4. STREET	CITY	COUNTY	STATE	ZIP CODE
<i>700 TENNELE AVE</i>	<i>JERSEY CITY</i>	<i>Hudson</i>	<i>NJ</i>	<i>07307</i>

5. REASON FOR REQUEST OF DUPLICATE CERTIFICATE

1. Lost Certificate    2. Damaged    3. Other (Specify)

SECTION B - SIGNATURE AND IDENTIFICATION

6. NAME OF PERSON COMPLETING FORM (Print or Type)	SIGNATURE	TITLE	DATE
<i>HASSAN ABU BAKR</i>	<i>[Signature]</i>	<i>Partner</i>	MO. DAY YEAR <i>10   10   18</i>

7. ADDRESS NO. & STREET	CITY	COUNTY	STATE	ZIP CODE	PHONE (AREA CODE, NO., EXTENSION)
-------------------------	------	--------	-------	----------	-----------------------------------

I certify that the information on this Form is true and correct.

SECTION C - OFFICIAL USE ONLY

RECEIVED DATE:	DIVISION OF REVENUE DLN #:
----------------	----------------------------

INSTRUCTIONS FOR COMPLETING DUPLICATE CERTIFICATE REQUEST

- ITEM 1 - Enter the Federal Identification Number assigned by the Internal Revenue Service, or if a Federal Employer Identification Number has been applied for, or if your business is such that you have not or will not receive a Federal Employer Identification Number, enter the Social Security Number of the owner or of one partner, in the case of a partnership.
- ITEM 2 - Enter the Certificate Number that was assigned to your company along with the Issue Date and Expiration Date (if available).
- ITEM 3 - Enter the name by which the company is identified.
- ITEM 4 - Enter the physical location of the company. Include City, County, State and Zip Code.
- ITEM 5 - Enter the reason for requesting a Duplicate Certificate of Employee Information Report.
- ITEM 6 - Print or type the name of the person completing the form. Include the signature, title and date.
- ITEM 7 - Enter the physical location where the form is being completed. Include City, State, Zip Code and Phone Number.

RETAIN A COPY OF THIS REQUEST FOR THE VENDOR'S OWN FILES AND FORWARD ONE COPY WITH A CHECK IN THE AMOUNT OF \$75.00 (Non-Refundable Fee) PAYABLE TO "THE TREASURER, STATE OF NEW JERSEY" TO:

NJ Department of the Treasury  
Division of Public Contracts  
Equal Employment Opportunity Compliance  
PO Box 206

Trenton, New Jersey 08625-0206      Telephone No. (609) 292-5473

PLEASE ALLOW 15 BUSINESS DAYS FOR PROCESSING THE DUPLICATE CERTIFICATE

STATE OF NEW JERSEY DEPARTMENT OF THE TREASURY  
 Division of Contract Compliance & Equal Employment Opportunity  
 VENDOR ACTIVITY SUMMARY REPORT

NEW HIRES  PROMOTIONS  TRANSFERS  TERMINATIONS (CHECK (X) APPROPRIATE ACTIVITY)

CERTIFICATE NO. 31498

DATES OF PAYROLL PERIOD USED: FROM First TO Fifteen

NAME OF FACILITY: A&B Undercar Repair Inc

Street 700 Tannele Ave City Jersey City County Hudson State NJ Zip Code 07307

JOB CATEGORIES	MALE						FEMALE					
	Total	Black	Hispanic	AM. Indian	Asian	Non-Min.	Total	Black	Hispanic	AM. Indian	Asian	Non-Min.
OFFICIALS & MANAGERS	1					1						
PROFESSIONALS												
TECHNICIANS	3		1			2						
SALES WORKERS												
OFFICE & CLERICAL							1		1			
CRAFTWORKERS												
OPERATIVES												
LABORERS												
SERVICE WORKERS												
TOTAL	4						1					

I certify that the information on this form is true and correct.

NAME OF PERSON COMPLETING FORM (Print or Type)

LAST ABUBARR FIRST HASSAN MI M

SIGNATURE A. B.

DATE SUBMITTED

ADDRESS (NO. & STREET) 700 Tannele Ave (CITY) Jersey City (STATE) NJ (ZIP) 07307

PHONE (AREA CODE, NO., EXTENSION) 201-659-3551

Certification 31498

**CERTIFICATE OF EMPLOYEE INFORMATION REPORT**  
**RENEWAL**

This is to certify that the contractor listed below has submitted an Employee Information Report pursuant to N.J.A.C. 17:27-1.1 et. seq. and the State Treasurer has approved said report. This approval will remain in effect for the period of ~~15-SEP-2016~~ to ~~15-SEP-2023~~

**A & B UNDERCARE REPAIR INC. DEA MEINEKE CAR**  
**700 TANNELE AVE.**  
**JERSEY CITY NJ 07307**



*Ford M. Scudder*  
**FORD M. SCUDDER**  
State Treasurer



## STATE OF NEW JERSEY BUSINESS REGISTRATION CERTIFICATE

**Taxpayer Name:** A & B UNDERCAR REPAIR INC.  
**Trade Name:** MEINEKE CAR CARE CENTER  
**Address:** 700 TONNELLE AVENUE  
JERSEY CITY, NJ 07307-4001  
**Certificate Number:** 0556399  
**Effective Date:** November 09, 1989.  
**Date of Issuance:** September 25, 2017

**For Office Use Only:**

20170925094340245

**CERTIFICATION OF COMPLIANCE WITH THE CITY OF JERSEY CITY  
CONTRACTOR PAY-TO-PLAY REFORM ORDINANCE 08-128 ADOPTED  
ON SEPTEMBER 3, 2008**

**PART I - Vendor Affirmation**

The undersigned, being authorized and knowledgeable of the circumstances, does hereby certify that A&B Vandalism Repair (name of business entity) has not made any reportable contributions in the \*\*one-year period preceding 11/20/2017 (date City Council awards contract) that would be deemed to be violations of Section One of the City of Jersey City's Contractor Pay-to-Play Reform Ordinance 08-128 (attached hereto) and that would bar the award of this contract. I further certify that during the term of the contract A&B Vandalism Repair (name of business entity) will not make any reportable contributions in violation of Ordinance 08-128.

**PART II - Signature and Attestation:**

The undersigned is fully aware that if I have misrepresented in whole or part this affirmation and certification, I and/or the business entity, will be liable for any penalty permitted under law.

Name of Business Entity: A&B Vandalism Repair Inc

Signed: [Signature] Title: Owner

Print Name Hassam A. B. Alor Date: 10/22/18

Subscribed and sworn before me  
this 23 day of October, 2018.

My Commission expires:

[Signature] (Affiant)  
(Print name & title of affiant) (Corporate Seal)

**ROBIN L. CAPUANO**  
NOTARY PUBLIC OF NEW JERSEY  
ID # 2207527  
My Commission Expires Dec. 08, 2022

\*\*Pursuant to Section 2 of Ordinance 08-128, no contributions or solicitation of contributions made prior to the effective date Ordinance 08-128 (September 23, 2008) shall be deemed to be a violation of the Ordinance.



**BUSINESS ENTITY DISCLOSURE CERTIFICATION  
FOR NON-FAIR AND OPEN CONTRACTS**  
Required Pursuant To N.J.S.A. 19:44A-20.8  
**CITY OF JERSEY CITY**

**Part I – Vendor Affirmation**

The undersigned, being authorized and knowledgeable of the circumstances, does hereby certify that the <name of business entity> has not made and will not make any reportable contributions pursuant to N.J.S.A. 19:44A-1 et seq. that, pursuant to P.L. 2004, c. 19 would bar the award of this contract in the one year period preceding (date of award scheduled for approval of the contract by the governing body) to any of the following named candidate committee, joint candidates committee; or political party committee representing the elected officials of the <name of entity of elected officials> as defined pursuant to N.J.S.A. 19:44A-3(p), (q) and (r).

Steven Fulop for Mayor 2017	Mira Prinz-Arey for Council
Lavatro for Councilman	Friends of Richard Boggiano
Friends of Joyce Watterman	Michael Yun for Council
Friends of Daniel Rivera	Solomon for Council
Ridley for Council	Friends of Jermaine Robinson

**Part II – Ownership Disclosure Certification**

I certify that the list below contains the names and home addresses of all owners holding 10% or more of the issued and outstanding stock of the undersigned.

Check the box that represents the type of business entity:

- Partnership     
  Corporation     
  Sole Proprietorship     
  Subchapter S Corporation  
 Limited Partnership     
  Limited Liability Corporation     
  Limited Liability Partnership

Name of Stock or Shareholder	Home Address
HASSAN ABU BAKR	2 Ledge Dr Government Heights, NJ 07035

**Part 3 – Signature and Attestation:**

The undersigned is fully aware that if I have misrepresented in whole or part this affirmation and certification, I and/or the business entity, will be liable for any penalty permitted under law.

Name of Business Entity: AB Underwear Repair INC  
 Signature of Affiant: [Signature] Title: Partner  
 Printed Name of Affiant: Hassan Abu Bakr Date: 11/22/18

Subscribed and sworn before me this 13 day of October, 2018

My Commission expires:

ROBIN L. CAPUANO  
NOTARY PUBLIC OF NEW JERSEY  
ID # 2207527  
My Commission Expires Dec. 08, 2022

[Signature]  
(Witnessed or attested by)  
(Seal)





Certification 31498

# CERTIFICATE OF EMPLOYEE INFORMATION REPORT

## RENEWAL

This is to certify that the contractor listed below has submitted an Employee Information Report pursuant to N.J.A.C. 17:27-1.1 et. seq. and the State Treasurer has approved said report. This approval will remain in effect for the period of **15-SEP-2016** to **15-SEP-2023**

**A & B UNDERCARE REPAIR INC. DBA MEINEKE CAR**  
**700 TANNELE AVE.**  
**JERSEY CITY NJ 07307**



*Ford M. Scudder*

FORD M. SCUDDER  
State Treasurer



## STATE OF NEW JERSEY BUSINESS REGISTRATION CERTIFICATE

**Taxpayer Name:** A & B UNDERCAR REPAIR INC.  
**Trade Name:** MEINEKE CAR CARE CENTER  
**Address:** 700 TONNELLE AVENUE  
JERSEY CITY, NJ 07307-4001  
**Certificate Number:** 0556399  
**Effective Date:** November 09, 1989  
**Date of Issuance:** October 23, 2018

**For Office Use Only:**

20181023103037981

AGM

Labor: Transmission Repair (I)

Description	Unit of Measure	Estimated Number of Hours Annually (A)	Unit Cost (B)	Extended Cost (C) = AxB	Total
Labor - Transmission Repair	Hourly Rate	3000	\$ 85.00	\$195,000	\$ 195,000.00

Repair Parts and Materials (II)

Description	Estimated Annual Materials Cost (A)	% Mark-Up (B)	Mark-up Cost (C) = AxB	Total
Repair Parts and Materials	\$100,000	10%	\$ 10,000	\$ 110,000.00

**GRAND TOTAL: TOTAL LABOR COST (I) PLUS TOTAL PARTS AND MATERIALS (II)**

\$ Three Hundred Five Thousand  
 (In Writing)

\$ 305,000.00  
 (In Figures)

**NOTE: A bid must be entered for all items. Award of contract shall be based on all items being provided by one Contractor. The Failure to bid any one item will result in the automatic**

2018

001 13 12 14 13 35

# **EEO/AFFIRMATIVE ACTION REQUIREMENTS**

## **Goods, Professional Services and General Service Contracts**

Questions in reference to EEO/AA Requirements For Goods, Professional Services and General Service Contracts should be directed to:

Jeana F. Abuan  
Spvg. Adm. Analyst, Public Agency Compliance Officer  
Department of Administration  
Office of Tax Abatement & Compliance  
13-15 Linden Avenue East  
Jersey City NJ 07305  
Tel. #201-547- 4538  
E-mail Address: [abuanJ@jcnj.org](mailto:abuanJ@jcnj.org)

(REVISED 4/13)

**EXHIBIT A**  
**MANDATORY EQUAL EMPLOYMENT OPPORTUNITY LANGUAGE**  
**N.J.S.A. 10:5-31 et seq. (P.L. 1975, C. 127)**  
**N.J.A.C. 17:27**

**GOODS, PROFESSIONAL SERVICE AND GENERAL SERVICE CONTRACTS**

During the performance of this contract, the contractor agrees as follows:

The contractor or subcontractor, where applicable, will not discriminate against any employee or applicant for employment because of age, race, creed, color, national origin, ancestry, marital status, affectional or sexual orientation, gender identity or expression, disability, nationality or sex. Except with respect to affectional or sexual orientation and gender identity or expression, the contractor will ensure that equal employment opportunity is afforded to such applicants in recruitment and employment, and that employees are treated during employment, without regard to their age, race, creed, color, national origin, ancestry, marital status, affectional or sexual orientation, gender identity or expression, disability, nationality or sex. Such equal employment opportunity shall include, but not be limited to the following: employment, upgrading, demotion, or transfer; recruitment or recruitment advertising; layoff or termination; rates of pay or other forms of compensation; and selection for training, including apprenticeship. The contractor agrees to post in conspicuous places, available to employees and applicants for employment, notices to be provided by the Public Agency Compliance Officer setting forth provisions of this nondiscrimination clause.

The contractor or subcontractor, where applicable will, in all solicitations or advertisements for employees placed by or on behalf of the contractor, state that all qualified applicants will receive consideration for employment without regard to age, race, creed, color, national origin, ancestry, marital status, affectional or sexual orientation, gender identity or expression, disability, nationality or sex.

The contractor or subcontractor will send to each labor union, with which it has a collective bargaining agreement, a notice, to be provided by the agency contracting officer, advising the labor union of the contractor's commitments under this chapter and shall post copies of the notice in conspicuous places available to employees and applicants for employment.

The contractor or subcontractor, where applicable, agrees to comply with any regulations promulgated by the Treasurer pursuant to N.J.S.A. 10:5-31 et seq., as amended and supplemented from time to time and the Americans with Disabilities Act.

The contractor or subcontractor agrees to make good faith efforts to meet targeted county employment goals established in accordance with N.J.A.C. 17:27-5.2.



100K +

**EXHIBIT A (Continuation)**

The contractor or subcontractor agrees to inform in writing its appropriate recruitment agencies including, but not limited to, employment agencies, placement bureaus, colleges, universities, and labor unions, that it does not discriminate on the basis of age, race, creed, color, national origin, ancestry, marital status, affectional or sexual orientation, gender identity or expression, disability, nationality or sex, and that it will discontinue the use of any recruitment agency which engages in direct or indirect discriminatory practices.

The contractor or subcontractor agrees to revise any of its testing procedures, if necessary, to assure that all personnel testing conforms with the principles of job-related testing, as established by the statutes and court decisions of the State of New Jersey and as established by applicable Federal law and applicable Federal court decisions.

In conforming with the targeted employment goals, the contractor or subcontractor agrees to review all procedures relating to transfer, upgrading, downgrading and layoff to ensure that all such actions are taken without regard to age, race, creed, color, national origin, ancestry, marital status, affectional or sexual orientation, gender identity or expression, disability, nationality or sex, consistent with the statutes and court decisions of the State of New Jersey, and applicable Federal law and applicable Federal court decisions.

The contractor shall submit to the public agency, after notification of award but prior to execution of a goods and services contract, one of the following three documents:

Letter of Federal Affirmative Action Plan Approval

Certificate of Employee Information Report

Employee Information Report Form AA302 (electronically provided by the Division and distributed to the public agency through the Division's website at [www.state.nj.us/treasury/contract\\_compliance](http://www.state.nj.us/treasury/contract_compliance))

The contractor and its subcontractors shall furnish such reports or other documents to the Division of Purchase & Property, CCAU, EEO Monitoring Program as may be requested by the office from time to time in order to carry out the purposes of these regulations, and public agencies shall furnish such information as may be requested by the Division of Purchase & Property, CCAU, EEO Monitoring Program for conducting a compliance investigation pursuant to Subchapter 10 of the Administrative Code at N.J.A.C. 17:27.

The undersigned vendor certifies on their company's receipt, knowledge and commitment to comply with:

**EXHIBIT A**  
N.J.S.A. 10:5-31 and N.J.A.C. 17:27  
**MANDATORY EQUAL EMPLOYMENT OPPORTUNITY LANGUAGE**  
Goods, Professional Services and General Service Contracts  
(Mandatory Affirmative Action Language)

The undersigned vendor further agrees to furnish the required forms of evidence and

understands that their contract/company's bid shall be rejected as non-responsive if said contractor fails to comply with the requirements of N.J.S.A. 10:5-31 and N.J.A.C. 17:27.

Representative's Name/Title (Print): Zariet Karas

Representative's Signature: [Handwritten Signature]

Name of Company: AGM Transmission LLC

Tel. No.: 201-451-2006 Date: 9/14/18

APPENDIX A  
AMERICANS WITH DISABILITIES ACT OF 1990  
Equal Opportunity for Individuals with Disability

The contractor and the Owner of AGM Transmission LLC (hereafter "owner") do hereby agree that the provisions of Title 11 of the Americans With Disabilities Act of 1990 (the "Act") (42 U.S.C. 5121 01 et seq.), which prohibits discrimination on the basis of disability by public entities in all services, programs, and activities provided or made available by public entities, and the rules and regulations promulgated pursuant thereto, are made a part of this contract. In providing any aid, benefit, or service on behalf of the owner pursuant to this contract, the contractor agrees that the performance shall be in strict compliance with the Act. In the event that the contractor, its agents, servants, employees, or subcontractors violate or are alleged to have violated the Act during the performance of this contract, the contractor shall defend the owner in any action or administrative proceeding commenced pursuant to this Act. The contractor shall indemnify, protect, and save harmless the owner, its agents, servants, and employees from and against any and all suits, claims, losses, demands, or damages, of whatever kind or nature, arising out of or claimed to arise out of the alleged violation. The contractor shall, at its own expense, appear, defend, and pay any and all charges for legal services and any and all costs and other expenses arising from such action or administrative proceeding or incurred in connection therewith. In any and all complaints brought pursuant to the owner's grievance procedure, the contractor agrees to abide by any decision of the owner which is rendered pursuant to said grievance procedure. If any action or administrative proceeding results in an award of damages against the owner, or if the owner incurs any expense to cure a violation of the ADA which has been brought pursuant to its grievance procedure, the contractor shall satisfy and discharge the same at its own expense.

The owner shall, as soon as practicable after a claim has been made against it, give written notice thereof to the contractor along with full and complete particulars of the claim. If any action or administrative proceeding is brought against the owner or any of its agents, servants, and employees, the owner shall expeditiously forward or have forwarded to the contractor every demand, complaint, notice, summons, pleading, or other process received by the owner or its representatives.

It is expressly agreed and understood that any approval by the owner of the services provided by the contractor pursuant to this contract will not relieve the contractor of the obligation to comply with the Act and to defend, indemnify, protect, and save harmless the owner pursuant to this paragraph.

It is further agreed and understood that the owner assumes no obligation to indemnify or save harmless the contractor, its agents, servants, employees and subcontractors for any claim which may arise out of their performance of this Agreement. Furthermore, the contractor expressly understands and agrees that the provisions of this indemnification clause shall in no way limit the contractor's obligations assumed in this Agreement, nor shall they be construed to relieve the contractor from any liability, nor preclude the owner from taking any other actions available to it under any other provisions of the Agreement or otherwise at law.

Representative's Name/Title Print: Zaref Keras  
Representative's Signature: Zaref Keras  
Name of Company: AGM Transmission LLC  
Tel No.: 201-451-2006 Date: 09/14/18

STATE OF NEW JERSEY DEPARTMENT OF THE TREASURY  
 Division of Contract Compliance & Equal Employment Opportunity  
 VENDOR ACTIVITY SUMMARY REPORT

NEW HIRES  PROMOTIONS  TRANSFERS  TERMINATIONS (CHECK (X) APPROPRIATE ACTIVITY)

CERTIFICATE NO. 58194

DATES OF PAYROLL PERIOD USED: FROM 8/31/17 TO 8/31/18

NAME OF FACILITY:

790 Communipaw Ave Jersey City Hudson NJ 07304  
 Street City County State Zip Code

JOB CATEGORIES	MALE						FEMALE					
	Total	Black	Hispanic	AM. Indian	Asian	Non-Min.	Total	Black	Hispanic	AM. Indian	Asian	Non-Min.
OFFICIALS & MANAGERS	1	1										
PROFESSIONALS												
TECHNICIANS	1	1										
SALES WORKERS												
OFFICE & CLERICAL												
CRAFTWORKERS												
OPERATIVES												
LABORERS												
SERVICE WORKERS												
TOTAL	2	2										

I certify that the information on this form is true and correct.

NAME OF PERSON COMPLETING FORM (Print or Type).

LAST Karas FIRST Zariet MI

SIGNATURE

*Zariet Karas*

DATE SUBMITTED 9/14/18

790 Communipaw Ave Jersey City N.J. 07304  
 ADDRESS (NO. & STREET) (CITY) (STATE) (ZIP)

201-451-2006  
 PHONE (AREA CODE, NO., EXTENSION)

Minority/Woman Business Enterprise (MWBE)  
Questionnaire for Bidders

Jersey City Ordinance C-829 establishes a goal of awarding 20% of the dollar amount of total city procurement to minority and woman owned business enterprises.

To assist us in monitoring our achievement of this goal, please indicate below whether your company is or is not a minority owned and/or woman owned business, and return this form with your bid proposal.

Business Name : AGM Transmission LLC  
Address : 790 Commonpaw Ave Jersey City N.J. 07304  
Telephone No. : 201-451-2006  
Contact Name : Zarief Karas

Please check applicable category :

Minority Owned Business (MBE)       Minority & Woman Owned Business (MWBE)  
 Woman Owned business (WBE)       Neither

**Definitions**

**Minority Business Enterprise**

Minority Business Enterprise means a business which is a sole proprietorship, partnership or corporation at least 51% of which is owned and controlled by persons who are African American, Hispanic, Asian American, American Indian or Alaskan native, defined as follows:

**African American:** a person having origins in any of the black racial groups of Africa

**Hispanic:** a person of Mexican, Puerto Rican, Central or South American or other non-European Spanish culture or origin regardless of race.

**Asian:** a person having origins in any of the original peoples of the Far East, South East Asia, Indian subcontinent, Hawaii or the Pacific Islands.

**American Indian or Alaskan Native:** a person having origins in any of the original peoples of North America and who maintains cultural identification through tribal affiliation or community recognition.

**Woman Business Enterprise**

Woman Business Enterprise means a business which is a sole proprietorship, partnership or corporation at least 51% of which is owned and controlled by a woman or women.

OFFICE OF EQUAL OPPORTUNITY COPY

Minority/Woman Business Enterprise (MWBE)  
Questionnaire for Bidders

Jersey City Ordinance C-829 establishes a goal of awarding 20% of the dollar amount of total city procurement to minority and woman owned business enterprises.

To assist us in monitoring our achievement of this goal, please indicate below whether your company is or is not a minority owned and/or woman owned business, and return this form with your bid proposal.

Business Name: AGM Transmission LLC  
Address: 790 Communipaw Ave Jersey City NJ 07304  
Telephone No.: 201-451-2006  
Contact Name: Zariet Karas

Please check applicable category:

Minority Owned Business (MBE)       Minority & Woman Owned Business (MWBE)  
 Woman Owned business (WBE)       Neither

**Definitions**

**Minority Business Enterprise**

Minority Business Enterprise means a business which is a sole proprietorship, partnership or corporation at least 51% of which is owned and controlled by persons who are African American, Hispanic, Asian American, American Indian or Alaskan native, defined as follows:

**African American:** a person having origins in any of the black racial groups of Africa

**Hispanic:** a person of Mexican, Puerto Rican, Central or South American or other non-European Spanish culture or origin regardless of race.

**Asian:** a person having origins in any of the original peoples of the Far East, South East Asia, Indian subcontinent, Hawaii or the Pacific Islands.

**American Indian or Alaskan Native:** a person having origins in any of the original peoples of North America and who maintains cultural identification through tribal affiliation or community recognition.

**Woman Business Enterprise**

Woman Business Enterprise means a business which is a sole proprietorship, partnership or corporation at least 51% of which is owned and controlled by a woman or women.

DIVISION OF PURCHASING COPY



CITY OF JERSEY CITY  
DIVISION OF PURCHASING

394 CENTRAL AVENUE, 2ND FLOOR | JERSEY CITY, NJ 07307  
P: 201 547 5155/5156 | F: 201 547 6585



STEVEN M. FULOP  
MAYOR OF JERSEY CITY

PETER FOLGADO  
DIRECTOR OF PURCHASING, O.P.A., R.PRO.

CERTIFICATION REGARDING SUSPENSION/DEBARMENT

I am Zariet Karas of the firm of AGM Transmission, LLC

the Contractor who submitted the lowest responsible bid for the project known as

Light Automotive Repairs

I executed the Proposal submitted to the City of Jersey City with the full authority to do

so. As of the date of execution of this Certification on this 14<sup>th</sup> day of June

2018 the firm of AGM Transmission LLC has not been suspended or debarred

from submitting bid proposals by the United States of America, its departments,

divisions, and agencies or by the State of New Jersey, its departments, divisions, and

agencies.

I certify that the foregoing statements are true. I am aware that if any of the foregoing statements made by me are willfully false, I am subject to punishment.

Zariet Karas

(Name of Contractor)

Signed By: Zariet Karas

Dated: 9/14/18

Title: Owner

Sworn and subscribed to before me  
This \_\_\_ day of \_\_\_, 20\_\_

\_\_\_\_\_

*Magda*  
MAGADA A. MARZOUK  
NOTARY PUBLIC OF NEW JERSEY  
ID#6006056  
My Commission Expires Oct. 23, 2019

09-21-2018

\*Must be notarized and returned with bid only if total bid amount exceeds \$100,000.00

Certification 58194

**CERTIFICATE OF EMPLOYEE INFORMATION REPORT  
INITIAL**

This is to certify that the contractor listed below has submitted an Employee Information Report pursuant to N.J.A.C. 17:27-1.1 et. seq. and the State Treasurer has approved said report. This approval will remain in effect for the period of **15-OCT-2017** to **15-OCT-2024**

**AGM TRANSMISSION, LLC  
790 COMMUNIPAW AVE.  
JERSEY CITY**

**NJ 07304**

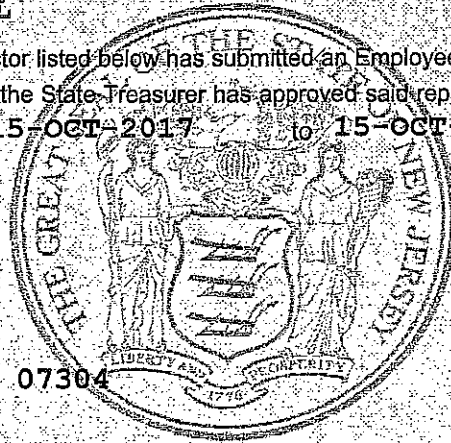

*Ford M. Scudder*

**FORD M. SCUDDER  
State Treasurer**

09/20/17

Taxpayer Identification#

Dear Business Representative:

Congratulations! You are now registered with the New Jersey Division of Revenue.

Use the Taxpayer Identification Number listed above on all correspondence with the Divisions of Revenue and Taxation, as well as with the Department of Labor (if the business is subject to unemployment withholdings). Your tax returns and payments will be filed under this number, and you will be able to access information about your account by referencing it.

Additionally, please note that State law requires all contractors and subcontractors with Public agencies to provide proof of their registration with the Division of Revenue. The law also amended Section 92 of the Casino Control Act, which deals with the casino service industry.

We have attached a Proof of Registration Certificate for your use. To comply with the law, if you are currently under contract or entering into a contract with a State agency, you must provide a copy of the certificate to the contracting agency.

If you have any questions or require more information, feel free to call our Registration Hotline at (609)292-9292.

I wish you continued success in your business endeavors.

Sincerely,

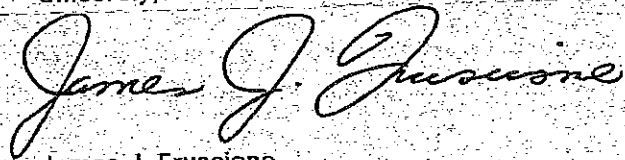

James J. Fruscione  
Director  
New Jersey Division of Revenue

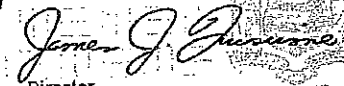
STATE OF NEW JERSEY BUSINESS REGISTRATION CERTIFICATE		DEPARTMENT OF TREASURY/ DIVISION OF REVENUE PO BOX 252 TRENTON, N.J. 08646-0252
TAXPAYER NAME: <b>A. G. M. TRANSMISSION LLC</b>	TRADE NAME:	
ADDRESS: <b>790 COMMUNIPAW AVE JESERY CITY NJ 07304</b>	SEQUENCE NUMBER: <b>1706506</b>	
EFFECTIVE DATE: <b>04/03/12</b>	ISSUANCE DATE: <b>09/20/17</b>	
FORM-BRC	 Director New Jersey Division of Revenue	
This Certificate is NOT assignable or transferable. It must be conspicuously displayed at above address.		

04-08-12205846V



**CERTIFICATION OF COMPLIANCE WITH THE CITY OF JERSEY CITY  
CONTRACTOR PAY-TO-PLAY REFORM ORDINANCE 08-128 ADOPTED  
ON SEPTEMBER 3, 2008**

**PART I - Vendor Affirmation**

The undersigned, being authorized and knowledgeable of the circumstances, does hereby certify that AGM Transmission LLC (name of business entity) has not made any reportable contributions in the \*\*one-year period preceding 10/23/18 (date City Council awards contract) that would be deemed to be violations of Section One of the City of Jersey City's Contractor Pay-to-Play Reform Ordinance 08-128 (attached hereto) and that would bar the award of this contract. I further certify that during the term of the contract AGM TRANSMISSION LLC (name of business entity) will not make any reportable contributions in violation of Ordinance 08-128.

**PART II - Signature and Attestation:**

The undersigned is fully aware that if I have misrepresented in whole or part this affirmation and certification, I and/or the business entity, will be liable for any penalty permitted under law.

Name of Business Entity: AGM Transmission LLC

Signed Zarriet Karas Title: Owner

Print Name Zarriet Karas Date: 10/22/18

Subscribed and sworn before me  
this 22 day of 2018  
My Commission expires:

\_\_\_\_\_  
(Affiant)

\_\_\_\_\_  
(Print name & title of affiant) (Corporate Seal)

**MAGADA A. MARZOUK  
NOTARY PUBLIC OF NEW JERSEY  
ID#50005058  
My Commission Expires Oct. 23, 2019**

*Magda Marzouk*

\*\*Pursuant to Section 2 of Ordinance 08-128, no contributions or solicitation of contributions made prior to the effective date Ordinance 08-128 (September 23, 2008) shall be deemed to be a violation of the Ordinance.

**CERTIFICATION OF COMPLIANCE WITH THE  
CONTRACTOR PAY-TO-PLAY REFORM ORDINANCE  
ON SEPTEMBER 3, 2008**

**PART I - Vendor Affirmation**

The undersigned, being authorized and knowledgeable of the circumstances, certifies that the undersigned and the business entity (name of business entity) AGM Transmission LLC (name of business entity) have not made any reportable contributions in the \*\*one-year period preceding 10/23/11 (name of business entity) (name of business entity) awards contract) that would be deemed to be violations of Section 2 of Contractor Pay-to-Play Reform Ordinance 08-128 (attached hereto) of this contract. I further certify that during the term of the contract (name of business entity) will not make any reportable contributions in violation of Section 2 of Ordinance 08-128.

**PART II - Signature and Attestation:**

The undersigned is fully aware that if I have misrepresented in this certification, I and/or the business entity, will be liable for any damages.

Name of Business Entity: AGM Transmission LLC

Signed [Signature] Title: Owner

Print Name: Zariet Karas Date: 10/2/11

Subscribed and sworn before me  
this 01 day of 22, 2011.  
My Commission expires: \_\_\_\_\_

(Print name of Notary Public)

**MAGADA A. MARZOUK  
NOTARY PUBLIC OF NEW JERSEY  
ID#50005056  
My Commission Expires Oct. 23, 2018**

[Signature]

\*\*Pursuant to Section 2 of Ordinance 08-128, no contributions made prior to the effective date of Ordinance 08-128 shall be deemed to be a violation of the Ordinance.

**CERTIFICATION OF COMPLIANCE WITH THE CITY OF JERSEY CITY  
CONTRACTOR PAY-TO-PLAY REFORM ORDINANCE 08-128 ADOPTED  
ON SEPTEMBER 3, 2008**

**PART I - Vendor Affirmation**

The undersigned, being authorized and knowledgeable of the circumstances, does hereby certify that AGM Transmission LLC (name of business entity) has not made any reportable contributions in the \*\*one-year period preceding 10/23/18 (date City Council awards contract) that would be deemed to be violations of Section One of the City of Jersey City's Contractor Pay-to-Play Reform Ordinance 08-128 (attached hereto) and that would bar the award of this contract. I further certify that during the term of the contract AGM Transmission LLC (name of business entity) will not make any reportable contributions in violation of Ordinance 08-128.

**PART II - Signature and Attestation:**

The undersigned is fully aware that if I have misrepresented in whole or part this affirmation and certification, I and/or the business entity, will be liable for any penalty permitted under law.

Name of Business Entity: AGM Transmission LLC

Signed Zariet Karas Title: Owner

Print Name Zariet Karas Date: 10/22/18

Subscribed and sworn before me  
this 22 day of 2018

My Commission expires: \_\_\_\_\_

(Print name & title of affiant) (Corporate Seal)

MAGADA A. MARZOUK  
NOTARY PUBLIC OF NEW JERSEY  
ID#50005056  
My Commission Expires Oct. 23, 2019

*Magda Marzouk*

\*\*Pursuant to Section 2 of Ordinance 08-128, no contributions or solicitation of contributions made prior to the effective date Ordinance 08-128 (September 23, 2008) shall be deemed to be a violation of the Ordinance.





**BUSINESS ENTITY DISCLOSURE CERTIFICATION  
FOR NON-FAIR AND OPEN CONTRACTS  
Required Pursuant To N.J.S.A. 19:44A-20.8  
CITY OF JERSEY CITY**

**Part I – Vendor Affirmation**

The undersigned, being authorized and knowledgeable of the circumstances, does hereby certify that the <name of business entity> has not made and will not make any reportable contributions pursuant to N.J.S.A. 19:44A-1 et seq. that, pursuant to P.L. 2004, c. 19 would bar the award of this contract in the one year period preceding (date of award scheduled for approval of the contract by the governing body) to any of the following named candidate committee, joint candidates committee; or political party committee representing the elected officials of the <name of entity of elected officials> as defined pursuant to N.J.S.A. 19:44A-3(p), (q) and (r).

Steven Fulop for Mayor 2017	Mira Prinz-Arey for Council
Lavarro for Councilman	Friends of Richard Boggiano
Friends of Joyce Watterman	Michael Yun for Council
Friends of Daniel Rivera	Solomon for Council
Ridley for Council	Friends of Jermaine Robinson

**Part II – Ownership Disclosure Certification**

I certify that the list below contains the names and home addresses of all owners holding 10% or more of the issued and outstanding stock of the undersigned.

Check the box that represents the type of business entity:

- Partnership     
  Corporation     
  Sole Proprietorship     
  Subchapter S Corporation  
 Limited Partnership     
 Limited Liability Corporation     
 Limited Liability Partnership

Name of Stock or Shareholder	Home Address

**Part 3 – Signature and Attestation:**

The undersigned is fully aware that if I have misrepresented in whole or part this affirmation and certification, I and/or the business entity, will be liable for any penalty permitted under law.

Name of Business Entity: AGM Transmission LLC  
 Signature of Affiant: [Signature] Title: Owner  
 Printed Name of Affiant: Zahed Karas Date: 10/22/18

Subscribed and sworn before me this 22 day of Oct, 2018  
 \_\_\_\_\_  
 (Witnessed or attested by)  
 My Commission expires: \_\_\_\_\_  
 \_\_\_\_\_  
 (Seal)

MAGADA A. MARZOUK  
 NOTARY PUBLIC OF NEW JERSEY  
 ID#50306058  
 My Commission Expires Oct. 23, 2019

Magda Marzouk

DAVES'S

Labor : Transmission Repair (I)

Description	Unit of Measure	Estimated Number of Hours Annually (A)	Unit Cost (B)	Extended Cost (C) = AxB	Total
Labor - Transmission Repair	Hourly Rate	3000	\$ 70.00	\$ 210,000	\$ 210,000

Repair Parts and Materials (II)

Description	Estimated Annual Materials Cost (A)	% Mark-Up (B)	Mark-up Cost (C) AxB	Total
Repair Parts and Materials	\$100,000	10 <sup>00</sup> / <sub>100</sub>	\$ 10,000	\$ 110,000

GRAND TOTAL: TOTAL LABOR COST (I) PLUS TOTAL PARTS AND MATERIALS (II)

\$ three hundred twenty thousand  
(In Writing)

\$ 320,000.<sup>00</sup>  
(In Figures)

NOTE: A bid must be entered for all items. Award of contract shall be based on all items being provided by one Contractor. The Failure to bid any one item will result in the automatic

2018

00110'10 011:04

# **EEO/AFFIRMATIVE ACTION REQUIREMENTS**

## **Goods, Professional Services and General Service Contracts**

Questions in reference to EEO/AA Requirements For Goods, Professional Services and General Service Contracts should be directed to:

Jeana F. Abuan  
Spvg. Adm. Analyst, Public Agency Compliance Officer  
Department of Administration  
Office of Tax Abatement & Compliance  
13-15 Linden Avenue East  
Jersey City NJ 07305  
Tel. #201-547- 4538  
E-mail Address: [abuanJ@jcnj.org](mailto:abuanJ@jcnj.org)



(REVISED 4/13)

**EXHIBIT A**  
**MANDATORY EQUAL EMPLOYMENT OPPORTUNITY LANGUAGE**  
N.J.S.A. 10:5-31 et seq. (P.L. 1975, C. 127)  
N.J.A.C. 17:27

**GOODS, PROFESSIONAL SERVICE AND GENERAL SERVICE CONTRACTS**

During the performance of this contract, the contractor agrees as follows:

The contractor or subcontractor, where applicable, will not discriminate against any employee or applicant for employment because of age, race, creed, color, national origin, ancestry, marital status, affectional or sexual orientation, gender identity or expression, disability, nationality or sex. Except with respect to affectional or sexual orientation and gender identity or expression, the contractor will ensure that equal employment opportunity is afforded to such applicants in recruitment and employment, and that employees are treated during employment, without regard to their age, race, creed, color, national origin, ancestry, marital status, affectional or sexual orientation, gender identity or expression, disability, nationality or sex. Such equal employment opportunity shall include, but not be limited to the following: employment, upgrading, demotion, or transfer; recruitment or recruitment advertising; layoff or termination; rates of pay or other forms of compensation; and selection for training, including apprenticeship. The contractor agrees to post in conspicuous places, available to employees and applicants for employment, notices to be provided by the Public Agency Compliance Officer setting forth provisions of this nondiscrimination clause.

The contractor or subcontractor, where applicable will, in all solicitations or advertisements for employees placed by or on behalf of the contractor, state that all qualified applicants will receive consideration for employment without regard to age, race, creed, color, national origin, ancestry, marital status, affectional or sexual orientation, gender identity or expression, disability, nationality or sex.

The contractor or subcontractor will send to each labor union, with which it has a collective bargaining agreement, a notice, to be provided by the agency contracting officer, advising the labor union of the contractor's commitments under this chapter and shall post copies of the notice in conspicuous places available to employees and applicants for employment.

The contractor or subcontractor, where applicable, agrees to comply with any regulations promulgated by the Treasurer pursuant to N.J.S.A. 10:5-31 et seq., as amended and supplemented from time to time and the Americans with Disabilities Act.

The contractor or subcontractor agrees to make good faith efforts to meet targeted county employment goals established in accordance with N.J.A.C. 17:27-5.2.

**EXHIBIT A (Continuation)**

The contractor or subcontractor agrees to inform in writing its appropriate recruitment agencies including, but not limited to, employment agencies, placement bureaus, colleges, universities, and labor unions, that it does not discriminate on the basis of age, race, creed, color, national origin, ancestry, marital status, affectional or sexual orientation, gender identity or expression, disability, nationality or sex, and that it will discontinue the use of any recruitment agency which engages in direct or indirect discriminatory practices.

The contractor or subcontractor agrees to revise any of its testing procedures, if necessary, to assure that all personnel testing conforms with the principles of job-related testing, as established by the statutes and court decisions of the State of New Jersey and as established by applicable Federal law and applicable Federal court decisions.

In conforming with the targeted employment goals, the contractor or subcontractor agrees to review all procedures relating to transfer, upgrading, downgrading and layoff to ensure that all such actions are taken without regard to age, race, creed, color, national origin, ancestry, marital status, affectional or sexual orientation, gender identity or expression, disability, nationality or sex, consistent with the statutes and court decisions of the State of New Jersey, and applicable Federal law and applicable Federal court decisions.

The contractor shall submit to the public agency, after notification of award but prior to execution of a goods and services contract, one of the following three documents:

Letter of Federal Affirmative Action Plan Approval

Certificate of Employee Information Report

Employee Information Report Form AA302 (electronically provided by the Division and distributed to the public agency through the Division's website at [www.state.nj.us/treasury/contract\\_compliance](http://www.state.nj.us/treasury/contract_compliance))

The contractor and its subcontractors shall furnish such reports or other documents to the Division of Purchase & Property, CCAU, EEO Monitoring Program as may be requested by the office from time to time in order to carry out the purposes of these regulations, and public agencies shall furnish such information as may be requested by the Division of Purchase & Property, CCAU, EEO Monitoring Program for conducting a compliance investigation pursuant to Subchapter 10 of the Administrative Code at N.J.A.C. 17:27.

The undersigned vendor certifies on their company's receipt, knowledge and commitment to comply with:

**EXHIBIT A**  
N.J.S.A. 10:5-31 and N.J.A.C. 17:27  
**MANDATORY EQUAL EMPLOYMENT OPPORTUNITY LANGUAGE**  
Goods, Professional Services and General Service Contracts  
(Mandatory Affirmative Action Language)

The undersigned vendor further agrees to furnish the required forms of evidence and

understands that their contract/company's bid shall be rejected as non-responsive if said contractor fails to comply with the requirements of N.J.S.A. 10:5-31 and N.J.A.C. 17:27.

Representative's Name/Title (Print): David DeLValle Owner

Representative's Signature: [Signature]

Name of Company: DAVE'S TRANSMISSION

Tel. No.: 201-656-0669 Date: 9-14-18

APPENDIX A  
AMERICANS WITH DISABILITIES ACT OF 1990  
Equal Opportunity for Individuals with Disability

The contractor and the Owner of Dave's Transmissions hereafter "owner") do hereby agree that the provisions of Title 11 of the Americans With Disabilities Act of 1990 (the "Act") (42 U.S.C. 5121 01 et seq.), which prohibits discrimination on the basis of disability by public entities in all services, programs, and activities provided or made available by public entities, and the rules and regulations promulgated pursuant thereto, are made a part of this contract. In providing any aid, benefit, or service on behalf of the owner pursuant to this contract, the contractor agrees that the performance shall be in strict compliance with the Act. In the event that the contractor, its agents, servants, employees, or sub-contractors violate or are alleged to have violated the Act during the performance of this contract, the contractor shall defend the owner in any action or administrative proceeding commenced pursuant to this Act. The contractor shall indemnify, protect, and save harmless the owner, its agents, servants, and employees from and against any and all suits, claims, losses, demands, or damages, of whatever kind or nature arising out of or claimed to arise out of the alleged violation. The contractor shall, at its own expense, appear, defend, and pay any and all charges for legal services and any and all costs and other expenses arising from such action or administrative proceeding or incurred in connection therewith. In any and all complaints brought pursuant to the owner's grievance procedure, the contractor agrees to abide by any decision of the owner which is rendered pursuant to said grievance procedure. If any action or administrative proceeding results in an award of damages against the owner, or if the owner incurs any expense to cure a violation of the ADA which has been brought pursuant to its grievance procedure, the contractor shall satisfy and discharge the same at its own expense.

The owner shall, as soon as practicable after a claim has been made against it, give written notice thereof to the contractor along with full and complete particulars of the claim. If any action or administrative proceeding is brought against the owner or any of its agents, servants, and employees, the owner shall expeditiously forward or have forwarded to the contractor every demand, complaint, notice, summons, pleading, or other process received by the owner or its representatives.

It is expressly agreed and understood that any approval by the owner of the services provided by the contractor pursuant to this contract will not relieve the contractor of the obligation to comply with the Act and to defend, indemnify, protect, and save harmless the owner pursuant to this paragraph.

It is further agreed and understood that the owner assumes no obligation to indemnify or save harmless the contractor, its agents, servants, employees and subcontractors for any claim which may arise out of their performance of this Agreement. Furthermore, the contractor expressly understands and agrees that the provisions of this indemnification clause shall in no way limit the contractor's obligations assumed in this Agreement, nor shall they be construed to relieve the contractor from any liability, nor preclude the owner from taking any other actions available to it under any other provisions of the Agreement or otherwise at law.

Representative's Name/Title Print: David Del Valle  
Representative's Signature: [Signature]  
Name of Company: Dave's Transmissions  
Tel. No.: 201-656-0669 Date: 9-14-18

**Minority/Woman Business Enterprise (MWBE)  
Questionnaire for Bidders**

Jersey City Ordinance C-829 establishes a goal of awarding 20% of the dollar amount of total city procurement to minority and woman owned business enterprises.

To assist us in monitoring our achievement of this goal, please indicate below whether your company is or is not a minority owned and/or woman owned business, and return this form with your bid proposal.

Business Name : DAVE'S Transmission  
Address : 146 Central Ave Jersey City, N.J. 07306  
Telephone No. : 201-656-0669  
Contact Name : David DeValle

Please check applicable category :

Minority Owned Business (MBE)       Minority & Woman Owned Business (MWBE)  
 Woman Owned business (WBE)       Neither

**Definitions**

**Minority Business Enterprise**

Minority Business Enterprise means a business which is a sole proprietorship, partnership or corporation at least 51% of which is owned and controlled by persons who are African American, Hispanic, Asian American, American Indian or Alaskan native, defined as follows:

**African American:** a person having origins in any of the black racial groups of Africa

**Hispanic:** a person of Mexican, Puerto Rican, Central or South American or other non-European Spanish culture or origin regardless of race.

**Asian:** a person having origins in any of the original peoples of the Far East, South East Asia, Indian subcontinent, Hawaii or the Pacific Islands.

**American Indian or Alaskan Native:** a person having origins in any of the original peoples of North America and who maintains cultural identification through tribal affiliation or community recognition.

**Woman Business Enterprise**

Woman Business Enterprise means a business which is a sole proprietorship, partnership or corporation at least 51% of which is owned and controlled by a woman or women.

Minority/Woman Business Enterprise (MWBE)  
Questionnaire for Bidders

Jersey City Ordinance C-829 establishes a goal of awarding 20% of the dollar amount of total city procurement to minority and woman owned business enterprises.

To assist us in monitoring our achievement of this goal, please indicate below whether your company is or is not a minority owned and/or woman owned business, and return this form with your bid proposal.

Business Name: DAVE'S TRANSMISSION  
Address: 146 Central Ave Jersey City, N.J. 07306  
Telephone No.: 201-656-0669  
Contact Name: DAVID DeWalle

Please check applicable category:

Minority Owned Business (MBE)       Minority & Woman Owned Business (MWBE)  
 Woman Owned business (WBE)       Neither

**Definitions**

**Minority Business Enterprise**

Minority Business Enterprise means a business which is a sole proprietorship, partnership or corporation at least 51% of which is owned and controlled by persons who are African American, Hispanic, Asian American, American Indian or Alaskan native, defined as follows:

**African American:** a person having origins in any of the black racial groups of Africa

**Hispanic:** a person of Mexican, Puerto Rican, Central or South American or other non-European Spanish culture or origin regardless of race.

**Asian:** a person having origins in any of the original peoples of the Far East, South East Asia, Indian subcontinent, Hawaii or the Pacific Islands.

**American Indian or Alaskan Native:** a person having origins in any of the original peoples of North America and who maintains cultural identification through tribal affiliation or community recognition.

**Woman Business Enterprise**

Woman Business Enterprise means a business which is a sole proprietorship, partnership or corporation at least 51% of which is owned and controlled by a woman or women.

DIVISION OF PURCHASING COPY

STATE OF NEW JERSEY DEPARTMENT OF THE TREASURY  
 Division of Contract Compliance & Equal Employment Opportunity  
 VENDOR ACTIVITY SUMMARY REPORT

NEW HIRES  PROMOTIONS  TRANSFERS  TERMINATIONS (CHECK (X) APPROPRIATE ACTIVITY)

CERTIFICATE NO. \_\_\_\_\_ DATES OF PAYROLL PERIOD USED: FROM 9-17-18 TO 9-23-18

NAME OF FACILITY: \_\_\_\_\_

Dave's Transmission  
 Street City County State Zip Code  
146 Central Ave Jersey City Hudson NJ 07306

JOB CATEGORIES	MALE						FEMALE					
	Total	Black	Hispanic	AM. Indian	Asian	Non-Min.	Total	Black	Hispanic	AM. Indian	Asian	Non-Min.
OFFICIALS & MANAGERS												
PROFESSIONALS												
TECHNICIANS	3		1									
SALES WORKERS												
OFFICE & CLERICAL	1		1									
CRAFTWORKERS												
OPERATIVES												
LABORERS												
SERVICE WORKERS												
TOTAL	4		2									

I certify that the information on this Form is true and correct.

NAME OF PERSON COMPLETING FORM (Print or Type) SIGNATURE DATE SUBMITTED  
 LAST FIRST MI  
DelValle David \_\_\_\_\_ 9-19-18

ADDRESS (NO. & STREET) (CITY) (STATE) (ZIP) PHONE (AREA CODE, NO., EXTENSION)  
146 Central Ave Jersey City NJ 07306 201-656-0669

\*\*\*\*\*



CITY OF JERSEY CITY  
DIVISION OF PURCHASING

394 CENTRAL AVENUE, 2ND FLOOR | JERSEY CITY, NJ 07307  
P: 201 547 5155/5156 | F: 201 547 6585



STEVEN M. FULOP  
MAYOR OF JERSEY CITY

PETER FOLGADO  
DIRECTOR OF PURCHASING, O.P.A., & P.D.

CERTIFICATION REGARDING SUSPENSION/DEBARMENT

I am David DeValle of the firm of DAVE'S TRANSMISSION

the Contractor who submitted the lowest responsible bid for the project known as

Transmission Repair

I executed the Proposal submitted to the City of Jersey City with the full authority to do

so. As of the date of execution of this Certification on this 14 day of September

2018 the firm of DAVE'S TRANSMISSION has not been suspended or debarred

from submitting bid proposals by the United States of America, its departments,

divisions, and agencies or by the State of New Jersey, its departments, divisions, and

agencies.

I certify that the foregoing statements are true. I am aware that if any of the foregoing statements made by me are willfully false, I am subject to punishment.

DAVE'S TRANSMISSION  
(Name of Contractor)

**Angel L Gonzalez**  
**Notary Public**  
**New Jersey**  
**My Commission Expires 9-27-22**  
**No. 2425561**

Signed By: [Signature]

Dated: 9-14-18

Title: Owner

Sworn and subscribed to before me  
This 14 day of Sept, 2018.

[Signature]

\*Must be notarized and returned with bid only if total bid amount exceeds \$100,000.00



STATE OF NEW JERSEY  
BUSINESS REGISTRATION CERTIFICATE

**Taxpayer Name:** DELVALLE, DAVID  
**Trade Name:** DAVE'S TRANSMISSION  
**Address:** 146 CENTRAL AVENUE  
JERSEY CITY, NJ 07306-2119  
**Certificate Number:** 1645346  
**Effective Date:** June 10, 2011  
**Date of Issuance:** May 21, 2018

**For Office Use Only:**  
20180521145822759



Certification 58158

**CERTIFICATE OF EMPLOYEE INFORMATION REPORT**  
**INITIAL**

This is to certify that the contractor listed below has submitted an Employee Information Report pursuant to N.J.A.C. 17:27-1.1 et. seq. and the State Treasurer has approved said report. This approval will remain in effect for the period of **15-OCT-2017** to **15-OCT-2024**

**DAVES TRANSMISSION**  
**143 CENTRAL AVE.**  
**JERSEY CITY**

**NJ 07307**

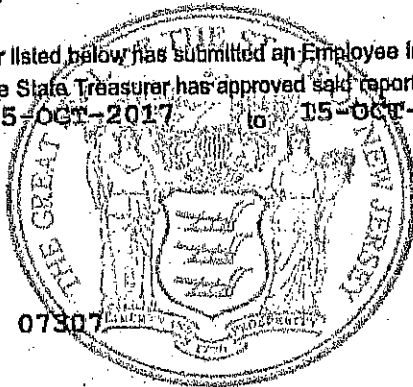

*Elizabeth Maher Muoio*  
**ELIZABETH MAHER MUOIO**  
State Treasurer

STATE OF NEW JERSEY  
Certificate of Authority

DIVISION OF TAXATION  
TRENTON, N.J. 08685

The person, partnership or corporation named below is hereby authorized to collect:  
**NEW JERSEY SALES & USE TAX**

pursuant to N.J.S.A. 54:32B-1 ET SEQ.

This authorization is good ONLY for the named person at the location specified herein.  
This authorization is null and void if any change of ownership or address is effected.

**DELVALLE, DAVID  
DAVE'S TRANSMISSION  
146 CENTRAL AVENUE  
JERSEY CITY, NJ 07306**

*Michael J. Boy*  
Acting Director, Division of Taxation

Tax Registration No.: **XXX-XXX-923/001**

Tax Effective Date **08-01-11**

Document Locator No.: **I0000604727**

Date Issued: **06-12-11**

This Certificate is NOT assignable or transferable. It must be conspicuously displayed at above address.

**CITY OF JERSEY CITY**  
**DEPT. OF HOUSING, ECONOMIC DEVELOPMENT & COMMERCE**  
**2016 - 2017 AUTO REPAIR NO AUTOBODY ALLOWED**

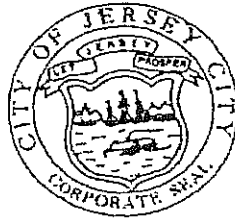

No: 470

DATE OF ISSUE: 11/01/16

Fee: \$ 200.00

DATE OF EXPIRATION: 10/31/17

LICENSE is hereby granted to: **DAVE'S TRANSMISSION**

Address: 146 CENTRAL AVENUE  
JERSEY CITY NJ 07307

Type of Business: AUTO REPAIR

Sq. Footage : 0  
# Seats/Rooms : 0

*This license shall be entitled to all the rights and privileges pertaining thereto under the terms, provisions, limitations, requirements and conditions of said Ordinance and any rules and regulations promulgated by the City of Jersey City relating thereto and in conformity with said Ordinance.*

POST IN A CONSPICUOUS  
PLACE

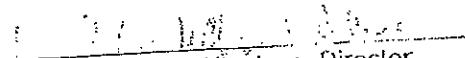
  
Maynard Woodson, Director  
Division of Commerce



**STATE OF NEW JERSEY  
BUSINESS REGISTRATION CERTIFICATE**

**Taxpayer Name:** DELVALLE,DAVID  
**Trade Name:** DAVE'S TRANSMISSION  
**Address:** 146 CENTRAL AVENUE  
JERSEY CITY, NJ 07306-2119  
**Certificate Number:** 1645346  
**Effective Date:** June 10, 2011  
**Date of Issuance:** May 21, 2018

**For Office Use Only:**  
20180521145822759

**CERTIFICATION OF COMPLIANCE WITH THE CITY OF JERSEY CITY  
CONTRACTOR PAY-TO-PLAY REFORM ORDINANCE 08-128 ADOPTED  
ON SEPTEMBER 3, 2008**

**PART I - Vendor Affirmation**

The undersigned, being authorized and knowledgeable of the circumstances, does hereby certify that DAVE'S TRANSMISSION (name of business entity) has not made any reportable contributions in the **\*\*one-year period preceding Nov 20 2017** (date City Council awards contract) that would be deemed to be violations of Section One of the City of Jersey City's Contractor Pay-to-Play Reform Ordinance 08-128 (attached hereto) and that would bar the award of this contract. I further certify that during the term of the contract DAVE'S TRANSMISSION (name of business entity) will not make any reportable contributions in violation of Ordinance 08-128.

**PART II - Signature and Attestation:**

The undersigned is fully aware that if I have misrepresented in whole or part this affirmation and certification, I and/or the business entity, will be liable for any penalty permitted under law.

Name of Business Entity: DAVE'S TRANSMISSION

Signed: [Signature] Title: OWNER

Print Name: David DeLuva Date: 10/22/18

Subscribed and sworn before me  
this 27 day of Sept, 2018

My Commission expires:

[Signature]  
(Affiant)

Angel L. Gonzalez  
(Print name & title of affiant) (Corporate Seal)

**Angel L. Gonzalez  
Notary Public  
New Jersey  
My Commission Expires 9-27-22  
No. 2425561**

\*\*Pursuant to Section 2 of Ordinance 08-128, no contributions or solicitation of contributions made prior to the effective date Ordinance 08-128 (September 23, 2008) shall be deemed to be a violation of the Ordinance.

**BUSINESS ENTITY DISCLOSURE CERTIFICATION**  
**FOR NON-FAIR AND OPEN CONTRACTS**  
 Required Pursuant To N.J.S.A. 19:44A-20.8  
**CITY OF JERSEY CITY**

**Part I – Vendor Affirmation**

The undersigned, being authorized and knowledgeable of the circumstances, does hereby certify that the <name of business entity> has not made and will not make any reportable contributions pursuant to N.J.S.A. 19:44A-1 et seq. that, pursuant to P.L. 2004, c. 19 would bar the award of this contract in the one year period preceding (date of award scheduled for approval of the contract by the governing body) to any of the following named candidate committee, joint candidates committee; or political party committee representing the elected officials of the <name of entity of elected officials> as defined pursuant to N.J.S.A. 19:44A-3(p), (q) and (r).

Steven Fulop for Mayor 2017	Mira Prinz-Arey for Council
Lavarro for Councilman	Friends of Richard Boggiano
Friends of Joyce Watterman	Michael Yun for Council
Friends of Daniel Rivera	Solomon for Council
Ridley for Council	Friends of Jermaine Robinson

**Part II – Ownership Disclosure Certification**

I certify that the list below contains the names and home addresses of all owners holding 10% or more of the issued and outstanding stock of the undersigned.

Check the box that represents the type of business entity:

- Partnership     
  Corporation     
  Sole Proprietorship     
  Subchapter S Corporation  
 Limited Partnership     
  Limited Liability Corporation     
  Limited Liability Partnership

Name of Stock or Shareholder	Home Address

**Part 3 – Signature and Attestation:**

The undersigned is fully aware that if I have misrepresented in whole or part this affirmation and certification, I and/or the business entity, will be liable for any penalty permitted under law.

Name of Business Entity: DAVE'S TRANSMISSION  
 Signature of Affiant: [Signature] Title: Owner  
 Printed Name of Affiant: DAVID DeLValle Date: 10/22-18

Subscribed and sworn before me this <u>22</u> day of <u>October</u> , 20 <u>18</u>  My Commission expires: <u>9-27-2022</u>	Angel L Gonzalez Notary Public New Jersey My Commission Expires 9-27-22 No. 2425561	<u>[Signature]</u> (Witnessed or attested by)  (Seal)
---	---	--







ZOLANI

Labor: Transmission Repair (I)

Description	Unit of Measure	Estimated Number of Hours Annually (A)	Unit Cost (B)	Extended Cost (C) = AxB	Total
Labor - transmission repair	Hourly Rate	3000	\$70. <sup>00</sup>	\$210,000	\$210,000. <sup>00</sup> /100

Repair Parts and Materials (II)

Description	Estimated Annual Materials Cost (A)	% Mark-Up (B)	Mark-up Cost (C)AxB	Total
Repair Parts and Materials	\$100,000	15 1/2%	\$15,000	\$115,000

GRAND TOTAL: TOTAL LABOR COST (I) PLUS TOTAL PARTS AND MATERIALS (II)

\$ Three hundred twenty-five thousand dollars and zero cents  
(In Writing)

\$ 325,000.<sup>00</sup>/100  
(In Figures)

NOTE: A bid must be entered for all items. Award of contract shall be based on all items being provided by one Contractor. The Failure to bid any one item will result in the automatic

2018

Zoland Corp.  
1742 John F. Kennedy Blvd.  
Jersey City, NJ 07305

007 15 13 #1 195

# **EEO/AFFIRMATIVE ACTION REQUIREMENTS**

## **Goods, Professional Services and General Service Contracts**

Questions in reference to EEO/AA Requirements For Goods, Professional Services and General Service Contracts should be directed to:

Jeana F. Abuan  
Spvg. Adm. Analyst, Public Agency Compliance Officer  
Department of Administration  
Office of Tax Abatement & Compliance  
13-15 Linden Avenue East  
Jersey City NJ 07305  
Tel. #201-547- 4538  
E-mail Address: [abuanJ@jcnj.org](mailto:abuanJ@jcnj.org)

(REVISED 4/13)

**EXHIBIT A**  
**MANDATORY EQUAL EMPLOYMENT OPPORTUNITY LANGUAGE**  
**N.J.S.A. 10:5-31 et seq. (P.L. 1975, C. 127)**  
**N.J.A.C. 17:27**

**GOODS, PROFESSIONAL SERVICE AND GENERAL SERVICE CONTRACTS**

During the performance of this contract, the contractor agrees as follows:

The contractor or subcontractor, where applicable, will not discriminate against any employee or applicant for employment because of age, race, creed, color, national origin, ancestry, marital status, affectional or sexual orientation, gender identity or expression, disability, nationality or sex. Except with respect to affectional or sexual orientation and gender identity or expression, the contractor will ensure that equal employment opportunity is afforded to such applicants in recruitment and employment, and that employees are treated during employment, without regard to their age, race, creed, color, national origin, ancestry, marital status, affectional or sexual orientation, gender identity or expression, disability, nationality or sex. Such equal employment opportunity shall include, but not be limited to the following: employment, upgrading, demotion, or transfer; recruitment or recruitment advertising; layoff or termination; rates of pay or other forms of compensation; and selection for training, including apprenticeship. The contractor agrees to post in conspicuous places, available to employees and applicants for employment, notices to be provided by the Public Agency Compliance Officer setting forth provisions of this nondiscrimination clause.

The contractor or subcontractor, where applicable will, in all solicitations or advertisements for employees placed by or on behalf of the contractor, state that all qualified applicants will receive consideration for employment without regard to age, race, creed, color, national origin, ancestry, marital status, affectional or sexual orientation, gender identity or expression, disability, nationality or sex.

The contractor or subcontractor will send to each labor union, with which it has a collective bargaining agreement, a notice, to be provided by the agency contracting officer, advising the labor union of the contractor's commitments under this chapter and shall post copies of the notice in conspicuous places available to employees and applicants for employment.

The contractor or subcontractor, where applicable, agrees to comply with any regulations promulgated by the Treasurer pursuant to N.J.S.A. 10:5-31 et seq., as amended and supplemented from time to time and the Americans with Disabilities Act.

The contractor or subcontractor agrees to make good faith efforts to meet targeted county employment goals established in accordance with N.J.A.C. 17:27-5.2.

100K +

Zoland Corp.  
1742 John F. Kennedy Blvd.  
Jersey City, NJ 07305

**EXHIBIT A (Continuation)**

The contractor or subcontractor agrees to inform in writing its appropriate recruitment agencies including, but not limited to, employment agencies, placement bureaus, colleges, universities, and labor unions, that it does not discriminate on the basis of age, race, creed, color, national origin, ancestry, marital status, affectional or sexual orientation, gender identity or expression, disability, nationality or sex, and that it will discontinue the use of any recruitment agency which engages in direct or indirect discriminatory practices.

The contractor or subcontractor agrees to revise any of its testing procedures, if necessary, to assure that all personnel testing conforms with the principles of job-related testing, as established by the statutes and court decisions of the State of New Jersey and as established by applicable Federal law and applicable Federal court decisions.

In conforming with the targeted employment goals, the contractor or subcontractor agrees to review all procedures relating to transfer, upgrading, downgrading and layoff to ensure that all such actions are taken without regard to age, race, creed, color, national origin, ancestry, marital status, affectional or sexual orientation, gender identity or expression, disability, nationality or sex, consistent with the statutes and court decisions of the State of New Jersey, and applicable Federal law and applicable Federal court decisions.

The contractor shall submit to the public agency, after notification of award but prior to execution of a goods and services contract, one of the following three documents:

Letter of Federal Affirmative Action Plan Approval

Certificate of Employee Information Report

Employee Information Report Form AA302 (electronically provided by the Division and distributed to the public agency through the Division's website at [www.state.nj.us/treasury/contract\\_compliance](http://www.state.nj.us/treasury/contract_compliance))

The contractor and its subcontractors shall furnish such reports or other documents to the Division of Purchase & Property, CCAU, EEO Monitoring Program as may be requested by the office from time to time in order to carry out the purposes of these regulations, and public agencies shall furnish such information as may be requested by the Division of Purchase & Property, CCAU, EEO Monitoring Program for conducting a compliance investigation pursuant to Subchapter 10 of the Administrative Code at N.J.A.C. 17:27.

The undersigned vendor certifies on their company's receipt, knowledge and commitment to comply with:

**EXHIBIT A**  
N.J.S.A. 10:5-31 and N.J.A.C. 17:27  
**MANDATORY EQUAL EMPLOYMENT OPPORTUNITY LANGUAGE**  
Goods, Professional Services and General Service Contracts  
(Mandatory Affirmative Action Language)

The undersigned vendor further agrees to furnish the required forms of evidence and

understands that their contract/company's bid shall be rejected as non-responsive if said contractor fails to comply with the requirements of N.J.S.A. 10:5-31 and N.J.A.C. 17:27.

Representative's Name/Title (Print): Luigi M. Fizzaratti, President

Representative's Signature: [Handwritten Signature]

Name of Company: Zoland Corp d/b/a Aarnco

Tel. No.: 201-433-5555

Date: 9/11/18

APPENDIX A  
AMERICANS WITH DISABILITIES ACT OF 1990  
Equal Opportunity for Individuals with Disability

The contractor and the City of Jersey City (hereafter "owner") do hereby agree that the provisions of Title 11 of the Americans With Disabilities Act of 1990 (the "Act") (42 U.S.C. 5121 01 et seq.), which prohibits discrimination on the basis of disability by public entities in all services, programs, and activities provided or made available by public entities, and the rules and regulations promulgated pursuant thereto, are made a part of this contract. In providing any aid, benefit, or service on behalf of the owner pursuant to this contract, the contractor agrees that the performance shall be in strict compliance with the Act. In the event that the contractor, its agents, servants, employees, or subcontractors violate or are alleged to have violated the Act during the performance of this contract, the contractor shall defend the owner in any action or administrative proceeding commenced pursuant to this Act. The contractor shall indemnify, protect, and save harmless the owner, its agents, servants, and employees from and against any and all suits, claims, losses, demands, or damages, of whatever kind or nature, arising out of or claimed to arise out of the alleged violation. The contractor shall, at its own expense, appear, defend, and pay any and all charges for legal services and any and all costs and other expenses arising from such action or administrative proceeding or incurred in connection therewith. In any and all complaints brought pursuant to the owner's grievance procedure, the contractor agrees to abide by any decision of the owner which is rendered pursuant to said grievance procedure. If any action or administrative proceeding results in an award of damages against the owner, or if the owner incurs any expense to cure a violation of the ADA which has been brought pursuant to its grievance procedure, the contractor shall satisfy and discharge the same at its own expense.

The owner shall, as soon as practicable after a claim has been made against it, give written notice thereof to the contractor along with full and complete particulars of the claim. If any action or administrative proceeding is brought against the owner or any of its agents, servants, and employees, the owner shall expeditiously forward or have forwarded to the contractor every demand, complaint, notice, summons, pleading, or other process received by the owner or its representatives.

It is expressly agreed and understood that any approval by the owner of the services provided by the contractor pursuant to this contract will not relieve the contractor of the obligation to comply with the Act and to defend, indemnify, protect, and save harmless the owner pursuant to this paragraph.

It is further agreed and understood that the owner assumes no obligation to indemnify or save harmless the contractor, its agents, servants, employees and subcontractors for any claim which may arise out of their performance of this Agreement. Furthermore, the contractor expressly understands and agrees that the provisions of this indemnification clause shall in no way limit the contractor's obligations assumed in this Agreement, nor shall they be construed to relieve the contractor from any liability, nor preclude the owner from taking any other actions available to it under any other provisions of the Agreement or otherwise at law.

Representative's Name/Title Print: Luca M. Pizzotti  
Representative's Signature: [Signature]  
Name of Company: Zoland Corp d/b/a Amco  
Tel. No.: 201-493-5555 Date: 9/11/18

**Minority/Woman Business Enterprise (MWBE)  
Questionnaire for Bidders**

Jersey City Ordinance C-829 establishes a goal of awarding 20% of the dollar amount of total city procurement to minority and woman owned business enterprises.

To assist us in monitoring our achievement of this goal, please indicate below whether your company is or is not a minority owned and/or woman owned business, and return this form with your bid proposal.

Business Name : Zoland Corp d/b/a Aames  
Address : 1742 John F. Kennedy Blvd Jersey City, N.J 07305  
Telephone No. : 201-433-5555  
Contact Name : Louis Fizzarotti

Please check applicable category :

<input type="checkbox"/> Minority Owned Business (MBE)	<input type="checkbox"/> Minority & Woman Owned Business (MWBE)
<input type="checkbox"/> Woman Owned business (WBE)	<input checked="" type="checkbox"/> Neither

**Definitions**

**Minority Business Enterprise**

Minority Business Enterprise means a business which is a sole proprietorship, partnership or corporation at least 51% of which is owned and controlled by persons who are African American, Hispanic, Asian American, American Indian or Alaskan native, defined as follows:

**African American:** a person having origins in any of the black racial groups of Africa

**Hispanic:** a person of Mexican, Puerto Rican, Central or South American or other non-European Spanish culture or origin regardless of race.

**Asian:** a person having origins in any of the original peoples of the Far East, South East Asia, Indian subcontinent, Hawaii or the Pacific Islands.

**American Indian or Alaskan Native:** a person having origins in any of the original peoples of North America and who maintains cultural identification through tribal affiliation or community recognition.

**Woman Business Enterprise**

Woman Business Enterprise means a business which is a sole proprietorship, partnership or corporation at least 51% of which is owned and controlled by a woman or women.

**Minority/Woman Business Enterprise (MWBE)  
Questionnaire for Bidders**

Jersey City Ordinance C-829 establishes a goal of awarding 20% of the dollar amount of total city procurement to minority and woman owned business enterprises.

To assist us in monitoring our achievement of this goal, please indicate below whether your company is or is not a minority owned and/or woman owned business, and return this form with your bid proposal.

Business Name: Zoland Corp d/b/a: Aamed  
Address: 1742 John F. Kennedy Blvd Jersey City, NJ 07305  
Telephone No.: 201-433-5558  
Contact Name: Louis Fizzarotti

Please check applicable category:

Minority Owned Business (MBE)       Minority & Woman Owned Business (MWBE)  
 Woman Owned business (WBE)       Neither

**Definitions**

**Minority Business Enterprise**

Minority Business Enterprise means a business which is a sole proprietorship, partnership or corporation at least 51% of which is owned and controlled by persons who are African American, Hispanic, Asian American, American Indian or Alaskan native, defined as follows:

**African American:** a person having origins in any of the black racial groups of Africa

**Hispanic:** a person of Mexican, Puerto Rican, Central or South American or other non-European Spanish culture or origin regardless of race.

**Asian:** a person having origins in any of the original peoples of the Far East, South East Asia, Indian subcontinent, Hawaii or the Pacific Islands.

**American Indian or Alaskan Native:** a person having origins in any of the original peoples of North America and who maintains cultural identification through tribal affiliation or community recognition.

**Woman Business Enterprise**

Woman Business Enterprise means a business which is a sole proprietorship, partnership or corporation at least 51% of which is owned and controlled by a woman or women.

DIVISION OF PURCHASING COPY



CITY OF JERSEY CITY  
DIVISION OF PURCHASING

394 CENTRAL AVENUE, 2ND FLOOR | JERSEY CITY, NJ 07307  
P: 201 547 5155/5156 | F: 201 547 6585



STEVEN M. FULOP  
MAYOR OF JERSEY CITY

PETER FOLGADO  
DIRECTOR OF PURCHASING, O.P.A., R.P.O.

CERTIFICATION REGARDING SUSPENSION/DEBARMENT

I am President of the firm of Zoland Corp d/b/a Aames  
the Contractor who submitted the lowest responsible bid for the project known as  
Transmission Repairs

I executed the Proposal submitted to the City of Jersey City with the full authority to do  
so. As of the date of execution of this Certification on this 11th day of September,  
2018, the firm of Zoland Corp d/b/a Aames has not been suspended or debarred  
from submitting bid proposals by the United States of America, its departments,  
divisions, and agencies or by the State of New Jersey, its departments, divisions, and  
agencies.

I certify that the foregoing statements are true. I am aware that if any of the  
foregoing statements made by me are willfully false, I am subject to punishment.

Zoland Corp.  
(Name of Contractor)

Signed By:

[Signature]

Dated:

9/11/18

Title:

President

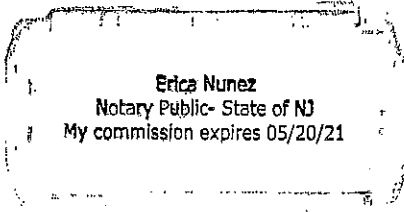

Sworn and subscribed to before me  
This 11th day of Sept, 2018

[Signature]

\*Must be notarized and returned with bid only if total bid amount exceeds \$100,000.00



Certification 28159

### CERTIFICATE OF EMPLOYEE INFORMATION REPORT RENEWAL

This is to certify that the contractor listed below has submitted an Employee Information Report pursuant to N.J.A.C. 17:27-1.1 et. seq. and the State Treasurer has approved said report. This approval will remain in effect for the period of **15-APR-2014** to **15-APR-2021**



**ZOLAND CORP DBA AAMCO TRANSMISSION & TOTAL**  
**1742 JOHN F. KENNEDY BLVD.**  
**JERSEY CITY NJ 07305**

  
Andrew P. Sidamon-Eristoff  
State Treasurer

<b>STATE OF NEW JERSEY</b>		<small>DEPARTMENT OF TREASURY/ DIVISION OF REVENUE PO BOX 252 TRENTON, N.J. 08646-0252</small>
<b>BUSINESS REGISTRATION CERTIFICATE</b>		
<b>FOR STATE AGENCY AND CASINO SERVICE CONTRACTORS</b>		
<b>TAXPAYER NAME:</b>	<b>TRADE NAME:</b>	
ZOLAND CORP.	AAMCO TRANSMISSIONS	
<b>TAXPAYER IDENTIFICATION#:</b>	<b>SEQUENCE NUMBER:</b>	
222-209-411/000	0068006	
<b>ADDRESS:</b>	<b>ISSUANCE DATE:</b>	
1742 KENNEDY BOULEVARD JERSEY CITY NJ 07305	03/24/04	
<b>EFFECTIVE DATE:</b>		
01/13/78		
<b>FORM-BRC(08-01)</b>		

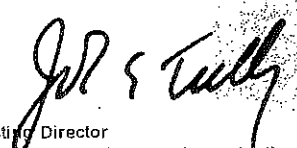
  
John S. Tully  
Acting Director

This Certificate is NOT assignable or transferable. It must be conspicuously displayed at above address.

STATE OF NEW JERSEY  
BUSINESS REGISTRATION CERTIFICATE  
FOR STATE AGENCY AND CASINO SERVICE CONTRACTORS

DEPARTMENT OF TREASURY  
DIVISION OF REVENUE  
PO-BOX 262  
TRENTON, N.J. 08646-0262

TAXPAYER NAME:

ZOLAND CORP.

TAXPAYER IDENTIFICATION#:

ADDRESS:

1742 KENNEDY BOULEVARD  
JERSEY CITY NJ 07305

EFFECTIVE DATE:

01/13/78

FORM-BRC(08-01)

TRADE NAME:

AAMCO TRANSMISSIONS

SEQUENCE NUMBER:

0058006

ISSUANCE DATE:

03/24/04

*J.P. & Tully*  
Acting Director

This Certificate is NOT assignable or transferable. It must be conspicuously displayed at above address.

Certification 28159

CERTIFICATE OF EMPLOYEE INFORMATION REPORT  
RENEWAL

This is to certify that the contractor listed below has submitted an Employee Information Report pursuant to N.J.A.C. 17:27-1.1 et. seq. and the State Treasurer has approved said report. This approval will remain in effect for the period of 15-APR-2014 to 15-APR-2021

ZOLAND CORP DBA AAMCO TRANSMISSIONS & TOTAL  
1742 JOHN F. KENNEDY BLVD.  
JERSEY CITY NJ 07305

  
  
Andrew P. Sldamon-Erlstoff  
State Treasurer

**CERTIFICATION OF COMPLIANCE WITH THE CITY OF JERSEY CITY  
CONTRACTOR PAY-TO-PLAY REFORM ORDINANCE 08-128 ADOPTED  
ON SEPTEMBER 3, 2008**

**PART I - Vendor Affirmation**

The undersigned, being authorized and knowledgeable of the circumstances, does hereby certify that Zoland Corp (name of business entity) has not made any reportable contributions in the \*\*one-year period preceding \_\_\_\_\_ (date City Council awards contract) that would be deemed to be violations of Section One of the City of Jersey City's Contractor Pay-to-Play Reform Ordinance 08-128 (attached hereto) and that would bar the award of this contract. I further certify that during the term of the contract \_\_\_\_\_ (name of business entity) will not make any reportable contributions in violation of Ordinance 08-128.

**PART II - Signature and Attestation:**

The undersigned is fully aware that if I have misrepresented in whole or part this affirmation and certification, I and/or the business entity, will be liable for any penalty permitted under law.

Name of Business Entity: Zoland Corp

Signed: [Signature] Title: President

Print Name: Louis M Fazzarotti Date: 10/22/18

Subscribed and sworn before me  
this 22 day of Oct, 2018  
My Commission expires:

Erica Nunez  
(Affiant)  
Notary of Hudson Co  
(Print name & title of affiant) (Corporate Seal)

[Signature]

Erica Nunez  
Notary Public- State of NJ  
My commission expires 05/20/21

\*\*Pursuant to Section 2 of Ordinance 08-128, no contributions or solicitation of contributions made prior to the effective date Ordinance 08-128 (September 23, 2008) shall be deemed to be a violation of the Ordinance.

**BUSINESS ENTITY DISCLOSURE CERTIFICATION**  
**FOR NON-FAIR AND OPEN CONTRACTS**  
 Required Pursuant To N.J.S.A. 19:44A-20.8  
**CITY OF JERSEY CITY**

**Part I – Vendor Affirmation**

The undersigned, being authorized and knowledgeable of the circumstances, does hereby certify that the <name of business entity> has not made and will not make any reportable contributions pursuant to N.J.S.A. 19:44A-1 et seq. that, pursuant to P.L. 2004, c. 19 would bar the award of this contract in the one year period preceding (date of award scheduled for approval of the contract by the governing body) to any of the following named candidate committee, joint candidates committee; or political party committee representing the elected officials of the <name of entity of elected officials> as defined pursuant to N.J.S.A. 19:44A-3(p), (q) and (r).

Steven Fulop for Mayor 2017	Mira Prinz-Arey for Council
Lavarro for Councilman	Friends of Richard Boggiano
Friends of Joyce Watterman	Michael Yun for Council
Friends of Daniel Rivera	Solomon for Council
Ridley for Council	Friends of Jermaine Robinson

**Part II – Ownership Disclosure Certification**

I certify that the list below contains the names and home addresses of all owners holding 10% or more of the issued and outstanding stock of the undersigned.

Check the box that represents the type of business entity:

- Partnership     
  Corporation     
  Sole Proprietorship     
  Subchapter S Corporation  
 Limited Partnership     
  Limited Liability Corporation     
  Limited Liability Partnership

Name of Stock or Shareholder	Home Address
Louis M Fazzarutti	1107 Egret Ct Forke

**Part 3 – Signature and Attestation:**

The undersigned is fully aware that if I have misrepresented in whole or part this affirmation and certification, I and/or the business entity, will be liable for any penalty permitted under law.

Name of Business Entity: Zeland Corp Title: President  
 Signature of Affiant: \_\_\_\_\_  
 Printed Name of Affiant: Louis M Fazzarutti Date: 10/22/18

Subscribed and sworn before me this 22 day of October, 2018  
 My Commission expires: \_\_\_\_\_  
 Erica Nunez  
 Notary Public- State of NJ  
 My commission expires 05/20/21  
Erica Nunez  
 (Witnessed or attested by)  
 \_\_\_\_\_  
 (Seal)

# C. 271 POLITICAL CONTRIBUTION DISCLOSURE FORM

Required Pursuant To N.J.S.A. 19:44A-20.26

This form or its permitted facsimile must be submitted to the local unit no-later than 10 days prior to the award of the contract.

## Part I - Vendor Information

Vendor Name:	Zoland Corp		
Address:	1742 John F Kennedy Blvd		
City:	Jc	State:	NJ Zip: 07306

The undersigned being authorized to certify, hereby certifies that the submission provided herein represents compliance with the provisions of N.J.S.A. 19:44A-20.26 and as represented by the Instructions accompanying this form.

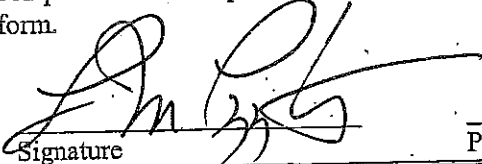
Louis M Fizzarotti
President  
 Signature Printed Name Title

## Part II - Contribution Disclosure

Disclosure requirement: Pursuant to N.J.S.A. 19:44A-20.26 this disclosure must include all reportable political contributions (more than \$300 per election cycle) over the 12 months prior to submission to the committees of the government entities listed on the form provided by the local unit.

Check here if disclosure is provided in electronic form.

Contributor Name	Recipient Name	Date	Dollar Amount
			\$
NONE			

Check here if the information is continued on subsequent page(s)



STATE OF NEW JERSEY  
BUSINESS REGISTRATION CERTIFICATE  
FOR STATE AGENCY AND CASINO SERVICE CONTRACTORS

DEPARTMENT OF TREASURY/  
DIVISION OF REVENUE  
PO BOX 252  
TRENTON, N. J. 08646-0252

TAXPAYER NAME:

ZOLAND CORP.

TAXPAYER IDENTIFICATION#:

ADDRESS:

1742 KENNEDY BOULEVARD  
JERSEY CITY NJ 07305

EFFECTIVE DATE

01/13/78

FORM-BRC(08-01)

TRADE NAME:

AAMCO TRANSMISSIONS

SEQUENCE NUMBER:

0068006

ISSUANCE DATE:

03/24/04

*J.P. Tully*  
Acting Director

This Certificate is NOT assignable or transferable. It must be conspicuously displayed at above address.

# Resolution of the City of Jersey City, N.J.

City Clerk File No. Res. 18-993

Agenda No. 10.Z.8

Approved: NOV 07 2018

TITLE:

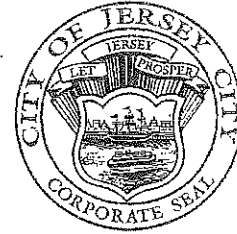

RESOLUTION AUTHORIZING THE AMENDMENT OF A PROFESSIONAL SERVICES AGREEMENT WITH NETCHERT DINEEN & HILLMAN TO REPRESENT THE CITY OF JERSEY CITY IN VARIOUS WORKER'S COMPENSATION MATTERS FILED AGAINST THE CITY OF JERSEY CITY

**COUNCIL** offered and moved adoption of the following resolution:

**WHEREAS**, the City of Jersey City (City) is required to provide defense attorneys in worker's compensation court; and

**WHEREAS**, Resolution 17,968, approved on December 13, 2017, awarded a one year professional services contract (PO #127625) effective (January 1, 2018) to Netchert Dineen & Hillman; and

**WHEREAS**, because all of the contract funds were expended it is necessary to amend the contract to increase the contract amount by an additional \$15,000.00; and

**WHEREAS**, funds in the amount of \$15,000.00 are available in Account No.: 01-201-23-210-312; and

**WHEREAS**, the resolution authorizing the award and the agreement itself must be available for public inspection.

**NOW, THEREFORE, BE IT RESOLVED** by the Municipal Council of the City of Jersey City that:

- The agreement with the law firm of Netchert Dineen & Hillman is amended and the contract amount is increased by an additional \$15,000.00; and
- The Mayor or Business Administrator is hereby authorized to execute the first amendment to the agreement attached hereto; and
- A copy of this resolution will be published in a newspaper of general circulation in the City of Jersey City as required by law within (10) days of the adoption of the resolution.

I, Donna Mauer, Donna Mauer, Chief Financial Officer, hereby certify that funds in the amount of \$15,000.00 are available in Account No.: 01-201-23-210-312.

MJH 10/02/18

APPROVED: \_\_\_\_\_

APPROVED AS TO LEGAL FORM

APPROVED: [Signature]

Business Administrator

[Signature]  
Corporation Counsel

Certification Required

Not Required

APPROVED 8-0

SMK  
10/24/18

RECORD OF COUNCIL VOTE ON FINAL PASSAGE 11.7.18											
COUNCILPERSON	AYE	NAY	N.V.	COUNCILPERSON	AYE	NAY	N.V.	COUNCILPERSON	AYE	NAY	N.V.
RIDLEY	✓			YUN	✓			RIVERA	✓		
PRINZ-AREY	✓			SOLOMON	✓			WATTERMAN	ABSENT		
BOGGIANO	✓			ROBINSON	✓			LAVARRO, PRES.	✓		

✓ Indicates Vote

N.V.-Not Voting (Abstain)

Adopted at a meeting of the Municipal Council of the City of Jersey City N.J.

[Signature]  
Roldando R. Lavarro, Jr., President of Council

[Signature]  
Robert Byrne, City Clerk



**RESOLUTION FACT SHEET - CONTRACT AWARD**

This summary sheet is to be attached to the front of any resolution that is submitted for Council consideration. Incomplete or vague fact sheets will be returned with the resolution.

**Full Title of Ordinance/Resolution**

RESOLUTION AUTHORIZING THE AMENDMENT OF A PROFESSIONAL SERVICES AGREEMENT WITH NETCHERT DINEEN & HILLMAN TO REPRESENT THE CITY OF JERSEY CITY IN VARIOUS WORKER'S COMPENSATION MATTERS FILED AGAINST THE CITY OF JERSEY CITY

**Project Manager**

<b>Department/Division</b>	ADMINISTRATION	RISK MANAGEMENT
<b>Name/Title</b>	MATT HOGAN	RISK MANAGER
<b>Phone/email</b>	201-547-5034	MATTHEW@ICNJ.ORG

Note: Project Manager must be available by phone during agenda meeting (Wednesday prior to council meeting @ 4:00 p.m.)

**Contract Purpose**

TO PROVIDE DEFENSE COUNSEL SERVICES FOR WORKER'S COMPENSATION CLAIMS FILED AGAINST THE CITY OF JERSEY CITY.

**Cost (Identify all sources and amounts)**

\$15,000.00  
INSURANCE ALL DEPARTMENTS:  
01-201-23-210-312

**Contract term (include all proposed renewals)**

ONE (1) YEAR  
EFFECTIVE: 01/01/2018 TO 12/31/2018

**Type of award**

FAIR & OPEN (PROFESSIONAL SERVICES)

If "Other Exception", enter type

**Additional Information**

THIS IS AN AMENDMENT ADDING \$15,000.00 TO THE CONTRACT, EFFECTIVE 1/1/18 TO 12/31/18, WITH NETCHERT DINEEN & HILLMAN WHO CONTINUE TO PROVIDE DEFENSE COUNSEL SERVICES RELATED TO WORKER'S COMPENSATION CLAIMS FILED AGAINST THE CITY.

I certify that all the facts presented herein are accurate.

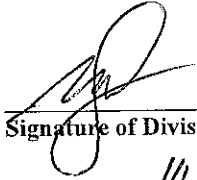
  
\_\_\_\_\_  
Signature of Division Director

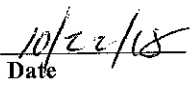
  
\_\_\_\_\_  
Date

  
\_\_\_\_\_  
Signature of Department Director

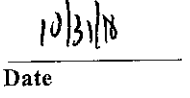
  
\_\_\_\_\_  
Date

**FIRST AMENDMENT TO A PROFESSIONAL SERVICES AGREEMENT WITH NETCHERT DINEEN & HILLMAN TO REPRESENT THE CITY IN VARIOUS WORKER'S COMPENSATION MATTERS FILED AGAINST THE CITY**

This First Amendment of Agreement made this \_\_\_\_\_ day of \_\_\_\_\_, 2018 between the City of Jersey City (City) and Netchert Dineen & Hillman.

WHEREAS, Resolution 17-968, approved on December 13, 2017, authorized a professional services agreement with Netchert Dineen & Hillman to represent the City in various worker's compensation matters filed against the City; and

WHEREAS, Resolution 17-968 authorized a professional services contract in an amount not to exceed \$50,000.00 and for a term of 1 year; and

WHEREAS Netchert Dineen & Hillman settled worker's compensation cases filed against the City exhausting the contract funds; and

WHEREAS, Netchert Dineen & Hillman continues to handle additional worker's compensation claims filed against the City; and

WHEREAS it is necessary to increase the contract amount by an additional \$15,000.00 for performing the legal services associated with representing the City in various worker's compensation claims filed against the City.

NOW, THEREFORE, in consideration of the mutual promises and covenants set forth herein the parties agree as follows:

1. The contract with Netchert Dineen & Hillman authorized by Resolution 17-968, approved on December 13, 2017, is amended to increase the sum by the amount of \$15,000.00 for the services associated with representing the City in worker's compensation claims filed against the City.
2. All other terms, covenants, conditions, rights and liabilities of the parties is set forth in the Professional Services Agreement with Netchert Dineen & Hillman dated January 1, 2018 shall remain in full force and effect.

**IN WITNESS WHEREOF**, the City of Jersey City by its Mayor or Business Administrator and Netchert Dineen & Hillman, have executed this First Amendment to the Agreement and affixed their corporate seals thereto the day, month and year first above written.

**ATTEST:**

**CITY OF JERSEY CITY**

\_\_\_\_\_  
**ROBERT BYRNE**  
City Clerk

\_\_\_\_\_  
**BRIAN PLATT**  
Business Administrator

**ATTEST:**

**NETCHERT DINEEN & HILLMAN**

# Resolution of the City of Jersey City, N.J.

City Clerk File No. Res. 18-994

Agenda No. 10.Z.9

Approved: NOV 07 2018

TITLE:



## RESOLUTION AWARDING A PROFESSIONAL SERVICES AGREEMENT WITH DESHA JACKSON LAW GROUP, LLC TO REPRESENT THE CITY OF JERSEY CITY IN VARIOUS EEO INDEPENDENT INVESTIGATIONS

**COUNCIL** offered and moved adoption of the following resolution:

**WHEREAS**, the City of Jersey City (City) requires the services of special counsel to represent the City in various EEO Independent Investigations; and

**WHEREAS**, the Corporation Counsel recommended the appointment of special counsel Desha Jackson Law Group, LLC; and

**WHEREAS**, Desha Jackson Law Group, LLC agrees to provide these services at an hourly rate of **\$150.00**, including expenses, for a total contract amount not to exceed **\$25,000**; and

**WHEREAS**, Desha Jackson Law Group, LLC, 100 Willow Brook Road, Suite 250, Freehold, New Jersey 07728; are attorneys on the State of New Jersey and are qualified to perform these services; and

**WHEREAS**, in October 2017, the City publicly advertised a Request for Qualifications (RFQ) using the "fair and open process" as described under the Pay-to-Play Law; and

**WHEREAS**, Desha Jackson Law Group LLC submitted a Qualification Statement in response to the City's RFQ; and

**WHEREAS**, this contract award is made for a term of one year and is in accordance with the "fair and open process" of the Pay-to-Play Law N.J.S.A. 19:44A-20.4 et seq.; and

**WHEREAS**, Desha Jackson Law Group LLC has submitted its Certification of Compliance with the City's Contractor Pay-to-Play Reform Ordinance 08-128 adopted on September 3, 2008; and

**WHEREAS**, the resolution authorizing the award and the agreement itself must be available for public inspection; and

**WHEREAS**, funds for \$25,000 are available in **Account No. 18-01-201-20-155-312**.

**NOW, THEREFORE, BE IT RESOLVED** by the Municipal Council of the City of Jersey City that:

1. A one year contract effective as of October 10, 2018 with Desha Jackson Law Group LLC is hereby awarded for a total contract amount not to exceed **\$25,000**, including expenses;
2. The award of this contract shall be subject to the condition that the vendor provides satisfactory evidence of compliance with the Affirmative Action Amendments to the Law against Discrimination, N.J.S.A. 10:5-31 et seq.;

City Clerk File No. Res. 18-994  
Agenda No. 10.Z.9 NOV 07 2018

TITLE:

**RESOLUTION AWARDING A PROFESSIONAL SERVICES AGREEMENT WITH DESHA JACKSON LAW GROUP, LLC TO REPRESENT THE CITY OF JERSEY CITY IN VARIOUS EEO INDEPENDENT INVESTIGATIONS**

- 3. Subject to such modification as the Corporation Counsel deems appropriate or necessary, the Mayor or Business Administrator is authorized to execute the professional services agreement attached hereto;
- 4. A copy of this resolution will be published in a newspaper of general circulation in the City of Jersey City as required by law within (10) days of the adoption of the resolution;
- 5. This agreement is awarded without competitive bidding as a professional services agreement under the Local Public Contracts Law, N.J.S.A. 40A:11-1 et seq.;
- 6. The Certification of Compliance with the City's Contractor Pay-to-Play Reform Ordinance, attached hereto, shall be placed on file with this Resolution; and

I hereby certify that there are sufficient funds available in **Account No.: 18-01-201-20-155-312** for payment of this resolution. P.O. No. 130685.

  
Donna Mauer, Chief Financial Officer

JMcK  
10/29/18

10/29/2018

APPROVED: \_\_\_\_\_

APPROVED AS TO LEGAL FORM

APPROVED:  \_\_\_\_\_  
Business Administrator

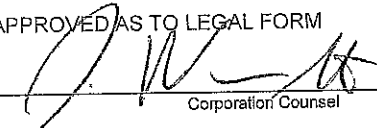
 \_\_\_\_\_  
Corporation Counsel

Certification Required

Not Required

APPROVED 8-0

RECORD OF COUNCIL VOTE ON FINAL PASSAGE 11-7-18											
COUNCILPERSON	AYE	NAY	N.V.	COUNCILPERSON	AYE	NAY	N.V.	COUNCILPERSON	AYE	NAY	N.V.
RIDLEY	✓			YUN	✓			RIVERA	✓		
PRINZ-AREY	✓			SOLOMON	✓			WATTERMAN	ABSENT		
BOGGIANO	✓			ROBINSON	✓			LAVARRO, PRES.	✓		

✓ Indicates Vote

N.V.-Not Voting (Abstain)

Adopted at a meeting of the Municipal Council of the City of Jersey City N.J.

  
\_\_\_\_\_  
Rolando R. Lavarro, Jr., President of Council

  
\_\_\_\_\_  
Robert Byrne, City Clerk

**RESOLUTION FACT SHEET - CONTRACT AWARD**

This summary sheet is to be attached to the front of any resolution that is submitted for Council consideration. Incomplete or vague fact sheets will be returned with the resolution.

**Full Title of Ordinance/Resolution**

**RESOLUTION AWARDING A PROFESSIONAL SERVICES AGREEMENT WITH DESHA JACKSON LAW GROUP LLC TO REPRESENT THE CITY OF JERSEY CITY IN VARIOUS EEO INDEPENDENT INVESTIGATIONS**

**Project Manager**

Department/Division	Law	Law
Name/Title	Peter Baker	Corporation Counsel
Phone/email	201-547-4667	PBaker@jcnj.org

Note: Project Manager must be available by phone during agenda meeting (Wednesday prior to council meeting @ 4:00 p.m.)

**Contract Purpose**

To represent the City of Jersey City in various EEO independent investigations.

**Cost (Identify all sources and amounts)**

**Contract term (include all proposed renewals)**

Law Department Funds  
18-01-201-20-155-312  
(\$25,000)

One Year

**Type of award**

Fair/Open

If "Other Exception", enter type

**Additional Information**

I certify that all the facts presented herein are accurate.

  
Signature of Department Director

10/30/18  
Date

## Outside Counsel Agreement

This Agreement dated the \_\_\_\_ day of \_\_\_\_\_, 2018 between the City of Jersey City, a municipal corporation, with offices at 280 Grove Street, Jersey City, New Jersey 07302 ("City") and, Desha Jackson Law Group, LLC 100 Willow Brook Road, Suite 250, Freehold, NJ 07728 ("Special Counsel"). The Corporation Counsel of the City of Jersey City has selected Special Counsel to represent the City of Jersey City in Various EEO Independent Investigations.

In consideration of the mutual promises and covenants set forth herein, the parties agree as follows:

### I. CONFLICTS OF INTEREST

#### **A. Initial Conflicts Check.**

Outside Counsel must be sensitive both to direct conflicts of interest that representation of the City and other clients poses, and to the less direct, but nevertheless serious, conflicts that may arise from the same firm's advocacy, on behalf of other clients, of positions conflicting with important City interests. Prior to Outside Counsel's engagement, Outside Counsel shall carefully review whether any conflicts of either type exist and, if so, bring those conflicts to the attention of the Corporation Counsel. The City shall be promptly informed of and consulted with respect to all potential conflicts. Although issue conflicts may not necessarily result in a disqualification of Outside Counsel, the City shall be consulted before Outside Counsel accepts an engagement that will require the firm to advocate a position that may be adverse to a City legal interest or otherwise prejudicial to the interests of the City. The City in its sole discretion shall, after consultation with Outside Counsel, determine whether an impermissible conflict exists, or whether other circumstances exist that would undermine the public's confidence if representation by Outside Counsel continued.

Outside Counsel's acceptance of an engagement on a matter without written disclosure of any conflicts constitutes Outside Counsel's representation that it has conducted an appropriate conflict check and no conflict exists.

#### **B. City Conflicts.**

The City has a duty to protect the public interest. As part of this responsibility, the City sets policies to ensure that the legal system operates in a manner that safeguards the public's confidence in the integrity and impartiality of its administration. For this reason, in addition to insisting that its attorneys follow the Rules of Professional Conduct, the City prohibits Outside Counsel that represent the City, while such matter is pending, from:

- (1) Representing private parties before the City or any of its boards, proceedings, commissions or autonomous agencies in adversarial, transactional or non-adversarial proceedings. Outside Counsel also may not, on behalf of a private client, lobby the City or any City department.
- (2) Representing private parties in any matter in which the City also is a party, if the private party has interests adverse to the City.
- (3) Representing a private client with interests adverse to the City.
- (4) Representing another client if that representation would present a substantial risk that Outside Counsel's responsibilities to the City would limit its ability to provide independent advice or diligent and competent representation either to the City or the other client.
- (5) Representing another client where the Outside Counsel's knowledge of the City's legal positions or strategy, derived from its representation or prospective representation of the City, could be used to the advantage of the other client or the disadvantage of the City.

**C. Continuing Obligation.**

The obligation to disclose conflicts continues throughout the course of the representation. Outside Counsel must review conflicts of interest on an ongoing basis as new matters are opened. Any new attorney/client relationships that potentially create a conflict shall be reported to the Corporation Counsel immediately.

**D. Attorney-Client Privilege Group/No Representation of Other Persons/Entities Absent Approval.**

Outside attorneys engaged to represent the City (as opposed to a named person) shall consider themselves to have formed an attorney-client relationship *only* with the City, and not any of its individual employees. When speaking with current or former employees of the City, Outside Counsel shall, as appropriate, advise those employees that although their dialogue will be considered attorney-client communications to the fullest possible extent, counsel's responsibility is to the City and they do not represent those employees in their individual capacities. As a matter proceeds, if employees of the City will be examined under oath or interviewed in other adverse contexts, and if Outside Counsel believe it advisable for them to represent the employees in their individual capacities at such events, Outside Counsel must obtain the Corporation Counsel's advance consent before agreeing to represent such persons in their individual capacities. The Corporation Counsel, in consultation with other City personnel, will determine if it is appropriate for the individual to receive representation and, if so, by whom.

Outside Counsel who are engaged to represent both an entity and employees of that entity simultaneously shall take all necessary steps to ensure the continuing absence of conflicts, and to preserve their ability to continue representing the entity in the event that conflicts develop between the entity and individual clients.

## **II. WORKING RELATIONSHIP**

### **A. Identification of Objectives/Relationship Attorney.**

The Corporation Counsel or his designee will be Outside Counsel's principal and regular point of contact for financial and strategic decisions. Only the Corporation Counsel or his designee has authority to direct Outside Counsel in the handling of the matter. If a City employee other than the Corporation Counsel or his designee asks Outside Counsel to proceed in a certain fashion or to perform certain activities with respect to a specific legal matter, Outside Counsel shall report the request to the Corporation Counsel and obtain direction prior to proceeding.

Outside counsel shall designate an Attorney to be the Corporation Counsel's principal contact. In all matters, the City remains ultimately responsible for making all substantive decisions and determining the costs and benefits of contemplated legal activity. In many matters, City attorneys will act as full co-counsel and be engaged with Outside Counsel in the day-to-day conduct of the case. In matters where Outside Counsel is handling that day-to-day conduct without City personnel as co-counsel, the City shall be consulted on a regular basis throughout the course of Outside Counsel's engagement and to be kept fully informed of the current status and proposed course of the matters assigned to Outside Counsel's firm. All strategic, tactical, staffing (including any proposed staffing changes) and significant resource allocation decisions about City legal matters must be made in collaboration with the Corporation Counsel.

### **B. Early Case Assessment/Cost Assessment.**

Each complex matter is to be thoroughly evaluated at its outset. The same applies to actions in which the City is the plaintiff, except that the analysis will be performed before the case is filed. In any matter, Outside Counsel shall provide an early case assessment that includes analysis of (1) likely costs to the City from the process, (2) possible outcomes, indicating the likelihood of each, and (3) strategy and tactics for termination or resolution. The format of the early case assessment may vary from a formal written document to a verbal briefing or a combination of a written budget with a verbal briefing on other aspects of the case.

Please note that time spent preparing a budget is not billable, but counsel may bill for time spent preparing an early case assessment or a recommended discovery plan.

The City places significant reliance on cost estimates and Outside Counsel shall prepare them with care. Although the City understands that unanticipated events may have an impact on costs,



the City shall be consulted promptly if Outside Counsel believes that the most recent cost estimate provided is no longer accurate. Should total fees or costs exceed the agreed budget, or should fees or costs for a phase of the case exceed the agreed estimate for that phase, without adequate explanation in advance that the increased expense will be necessary, the City may require that an increased discount be applied to unanticipated fees or costs and reserves the right not to pay Outside Counsel for any amounts incurred or expended in excess of the approved budget or estimate.

For bond matters and other transactional engagements, counsel may be expected to provide a fee cap for the transaction, approved by the City, prior to commencing work. Only where a transaction materially changes in scope will the City consider revisions to an agreed fee cap. No payments above the agreed fee cap shall be made unless and until a revised fee cap has been approved in writing by the Director of the City or his/her designee.

**C. Staffing.**

Unless otherwise agreed, the senior attorney retained shall be directly and ultimately responsible for the entire assignment. The day-to-day involvement of that senior attorney, however, shall be appropriate to the magnitude of the matter and the efficiency required for a timely, cost effective, quality work product. When a senior attorney can handle an assignment most efficiently (based on skill and experience), that senior attorney shall complete the assignment.

The City shall be billed for only one attorney to attend events such as depositions, witness meetings, settlement conferences, negotiations and meetings with other parties' counsel. The City recognizes that in more complex matters and those with multiple work-streams, it may occasionally be appropriate for multiple attorneys to attend significant events and for members of the team to consult with each other. The City insists, however, that no more than the minimum number of attorneys necessary to an event attend, that billable internal conferences and charges for drafting and reading internal email correspondence occur only when absolutely required, and that the Corporation Counsel be regularly informed both of the number of attorneys who will attend significant events and the reason for the attendance of each billing timekeeper.

The City believes that it is most efficient for a single attorney or group of attorneys to handle a matter from beginning to end and Outside Counsel shall strive for such continuity. The City will not pay for learning time that may result from staffing changes at Outside Counsel's firm. In addition, the City will not reimburse Outside Counsel for any routine training or supervisory time, including time spent at seminars, unless specifically approved in advance and included as part of the budget. The City will not ordinarily pay for summer associate time unless such time has been identified as part of the approved staffing plan for appropriate work. The City will not pay for time submitted by librarians; secretaries; billing, filing, docketing or document clerks; internal messengers/couriers; temporary or clerical support staff; word processors; and IT professionals other than electronic discovery specialists serving a function similar to that of paralegals/case managers. The City also will not pay for time billed by attorneys or paralegals to

perform tasks (filing, indexing, etc.) that could and should have been handled by support personnel.

**D. Settlement.**

Outside Counsel shall have no settlement authority unless and until such authority is explicitly conferred on them by the Corporation Counsel. If Outside Counsel believes that settlement should be pursued, Outside Counsel must seek instructions in this regard from the Corporation Counsel, and not pursue formal or informal settlement discussions without the Corporation Counsel's approval. Outside Counsel shall immediately inform the Corporation Counsel of any settlement proposal or overture, formal or informal, by the opposing party or counsel. Please note that under no circumstances can the City agree to designate a settlement agreement as confidential. All City settlement records are, by definition, public documents.

**E. Media Relations/Law Firm Advertising.**

**The City does not authorize outside counsel or vendors to comment publicly in any manner on any aspect of the City's legal matters.** All media inquiries relating to the City shall be referred promptly to the Corporation Counsel and discussed with the Corporation Counsel before responding to the media contact in any manner. This includes even "no comment" or other non-substantive responses. If time is of the essence and Outside Counsel cannot reach the Corporation Counsel, the Press Secretary in the Office of the Mayor shall be contacted.

The City does not permit Outside Counsel to advertise or promote their relationship with the City, other than by listing the City as a representative client.

**F. Engagement of E-Discovery and Other Vendors, Including Experts.**

Before engaging any vendor, including electronic discovery firms and experts, lobbyists or other consultants (in each case, a "vendor"), Outside Counsel must pre-clear that engagement with the Corporation Counsel, unless the Corporation Counsel has explicitly granted exceptions to this preclearance requirement. The City will not be responsible for vendor fees or costs unless that vendor's engagement was pre-approved by the City. The City may require Outside Counsel to engage vendors with which the City has master contracts or preferred pricing arrangements, and always will insist on engagement of the lowest-cost vendor qualified to handle a task (understanding that complex tasks may require vendors with specialized expertise).

Outside Counsel will pay all third-party service providers directly and will bill the City for those services' detailed disbursements included in monthly invoices. This City will not accept separate invoices from service providers directly to the City for payment.

Outside Counsel has the responsibility to ensure that there are no conflicts between any vendor and the City. In addition, all vendors must execute the confidentiality agreement attached as

Appendix A. The fee and disbursement policies as outlined in this Agreement shall be made available to, and followed by vendors. It is Outside Counsel's responsibility to confirm that all third party billings comply with this Agreement.

Vendor payment arrangements shall be discussed in advance with the Corporation Counsel. In general, Outside Counsel shall contract with vendors themselves and pay the third party invoices directly, incorporating those invoices into their own bills to the City and including appropriate detail for reasonable review by City personnel. The City may request Outside Counsel to provide full copies of vendor invoices; Outside Counsel therefore shall retain those invoices in accordance with IRS guidelines. The Corporation Counsel may approve other payment arrangements, including (in rare cases) direct contracting with and payment by the City.

When engaging court reporting services, Outside Counsel shall request only one transcript (electronic or hard copy). The City will not reimburse charges for additional transcripts.

**G. Adherence to Ethical Standards.**

The City conducts itself in accordance with the highest ethical standards and expects the same of its Outside Counsel. No City employee ever has authority to instruct Outside Counsel to act in an unethical manner. If Outside Counsel believes that a City employee has engaged or will engage in illegal or unethical activity, Outside Counsel must immediately advise the Corporation Counsel. The City will terminate its relationship with any Outside Counsel who, in the City's sole discretion, fails to adhere to the foregoing ethical standards.

At all times, Outside Counsel will remain aware of and in compliance with each of the City's "Pay-to-Play" ordinances and any amendments thereto.

**H. Gratuities.**

City officers and employees are prohibited from accepting any gift, favor, service or other thing of value related in any way to the City officer's or employee's public duties. In addition, any vendor to the City is prohibited from offering a gift or other thing of value to a City officer or employee with whom the vendor transacts business or offers to transact business. Any City officer or employee is prohibited from soliciting a gift or thing of value from a City vendor. This includes charitable donations made in the name of a City employee.

The City reserves the right to amend this Agreement from time to time, providing written notification to Outside Counsel within thirty (30) days of the effective date of any substantive changes. Failure to accept amendments may result in the termination of services from the City.

**I. Malpractice Insurance.**

Outside Counsel representing the City shall maintain malpractice insurance coverage that is reasonable and prudent in relation to the types and sizes of matters handled. Outside Counsel shall, upon request, promptly provide the Corporation Counsel with copies of any applicable policies required under this section, and/or a certificate of insurance. Each policy provided must be certified by the agent or underwriter to be a true copy. If Outside Counsel does not have coverage or if coverage is cancelled and not immediately replaced with comparable coverage, Outside Counsel must immediately report this to the Corporation Counsel.

**J. File Retention.**

For Litigated Matters: Outside Counsel shall retain pleadings, correspondence, discovery materials, deposition transcripts and similar documents and work product for a period of no less than seven (7) years from the date the matter is concluded or for the time period specified by rule or law in the jurisdiction in which the matter was pending, whichever is longer. Beyond this period, Outside Counsel shall notify the City in writing no less than sixty (60) days prior to destroying any file. Along with the written notification, Outside Counsel shall submit an inventory of any original City documents contained in the file to be destroyed and a representation that any electronic version of the file will also be destroyed or deleted.

For Bond and Other Transactions, and Advice Matters: Documents shall be retained in accordance with the same policies applicable to litigated matters unless applicable law mandates any longer retention schedule. However, bond counsel and transactional/advice counsel shall retain all transcripts of transactions and memoranda of advice indefinitely unless otherwise directed by the Corporation Counsel.

**III. Billing**

**A. Rates.**

Outside Counsel shall be compensated at the rate of \$150.00 per hour, including expenses. The total amount of this agreement shall not exceed \$25,000.

The City will pay for actual services rendered at rates established in Requests for Qualifications or otherwise agreed to in advance. At the time of Outside Counsel's initial engagement, Outside Counsel shall furnish the Corporation Counsel with a schedule of billing rates for partners, associates and all other timekeepers expected to bill time against the matter for review and approval prior to billing time to the City. Because of City procurement rules, the rates applicable at the inception of each specific matter must remain in effect for the duration of that matter.

Hourly rates shall include all overhead costs (*see* Acceptable Fees/Charges, below), none of which shall be included in disbursements.

Time must be billed in 0.1 hour increments and on a per-task basis. The time entry description must be specific, detailing the action taken and the subject matter. Absent prior consent, the City will not pay for more than ten (10) hours of time by a single timekeeper in a single day, but the Corporation Counsel may increase that number of permissible hours in matters of special urgency or where cases are in or approaching trial.

Outside Counsel shall bear in mind that invoices may be disclosed pursuant to the City's open records laws and that courts may not sustain assertions of privilege by the City. Although the City will endeavor to redact privileged information before releasing bills for public consumption, Outside Counsel shall, to the extent practicable and consistent with the need to fully inform the City of its activities and to allow the City to evaluate the reasonableness of billing narratives, avoid the inclusion of privileged matter in invoices.

**B. Invoicing Policy.**

All invoices must be submitted to the Corporation Counsel.

For litigation, advice, and non-bond transactional matters, Outside Counsel generally are expected to submit monthly invoices within thirty days of the conclusion of the billing period, absent the City's prior consent to a longer delay. All charges must reflect the work performed within the billing period or a reasonable time before the billing period. Absent good cause, as defined by the City, the City will not pay for services or expenses incurred more than 90 days prior to the date the invoice is submitted. For bond matters, Outside Counsel are expected to submit their invoice within thirty days of the conclusion of the transaction.

Absent a specific agreement to an alternative fee arrangement, Outside Counsel fees shall be computed by applying the negotiated hourly rate to the time for the services expended. Hours shown must accurately reflect the time spent on the described activity and must either be the exact amount of time or the exact time rounded down to the nearest one-tenth of an hour. Block billing—grouping multiple activities under a single time charge—will not be accepted, and the City will not pay for any time recorded in a block fashion unless this requirement is waived by the Director of the City of Law or his or her designee.

Every bill from Outside Counsel is deemed to be a certification by the firm and billing partner that all legal services and disbursements reflected on the bill are reasonable for the legal matter involved and necessary for the proper provision of legal services to the City. The City may deduct certain fees and charges that are inconsistent with this Agreement.

The City reserves the right to audit all fee and disbursement details that Outside Counsel submit, as well as the corresponding legal file. The City will promptly terminate the services of any Outside Counsel who's billing practices raise questions about the Outside Counsel's integrity, honesty or compliance with the applicable rules of professional conduct or this Agreement.

**C. Invoice Format.**

Each invoice will include the following minimum requirements:

- Unique invoice number
- Invoice date
- Matter name
- Outside Counsel's matter number
- Date(s) services were performed
- Timekeeper name or ID
- Timekeeper title or level
- A narrative description of the services provided or tasks performed for each specific task. The description shall clearly state the nature of the task performed sufficient to allow the City to determine why it was necessary. Incomplete or vague charge descriptions are unacceptable. Examples of incomplete or vague charges include, but are not limited to: 'analysis', 'review file,' 'conference', 'attention to matter'; 'worked on discovery', 'work on file', 'prepare for meeting', 'misc.', and 'other'
- Time entry to the nearest tenth (.10) of an hour
- Timekeeper rate
- Charge total
- Detail of reimbursable expenses and disbursements at actual cost

The detailed billing report from Outside Counsel's system will provide this information. If Outside Counsel provides services on more than one matter during a billing period, a separate invoice for each matter is required.

**D. Acceptable Fees/Charges.**

**Overhead charges may not be billed.** The City will not reimburse Outside Counsel for basic support services, which the City deems to be part of Outside Counsel's overhead and built into its rates. The City will not pay for any of the following items under any circumstances:

- Billing inquiries
- Opening and closing files
- Internal filing
- Secretarial services (including overtime charges)
- Word processing or proofreading
- Maintenance of a calendar or tickler system
- Investigating potential conflicts
- Preparing budgets
- Library usage (including book purchases or subscriptions) or library staff time
- Office supplies
- Conference room charges

**E. Basic legal research may not be billed.**

Outside Counsel shall be familiar with the basic substantive law at issue in the matter for which the firm was retained, and the City shall not be charged for this type of research. If legal research benefits other clients, only the proportionate share of that cost shall be billed to the City. The City shall also benefit from previously prepared briefs and memoranda, and when such briefs or memoranda exist, will pay only for actual time spent updating or tailoring the same. All other anticipated legal research shall be addressed in Outside Counsel's proposed budget. Legal research projects necessary in a particular litigation assignment must be approved in advance by the Corporation Counsel before the research is commenced.

The City will pay only for the actual time spent by Outside Counsel or other approved timekeeper conducting the research. As explained *infra*, fees charged by electronic or other research services, including library fees, Westlaw, Lexis and other online services are considered general overhead and are not reimbursable.

**F. Out-of-pocket costs must be itemized and passed through with no markup.**

The City will reimburse Outside Counsel for reasonable, documented and itemized out-of-pocket disbursements and costs incurred on behalf of the City, with the exceptions and limitations set forth in this Agreement. Outside Counsel's invoices to the City shall reflect the actual cost and shall not include any markup. All disbursements must be fully itemized with a description sufficient for review, identifying the number of units, price per unit and total cost. The City may refuse to pay for disbursements billed as 'miscellaneous,' billed in a group (e.g., Travel Expenses - \$4,000.00) or disbursements without descriptions.

**G. Prohibited disbursements.**

The City considers certain disbursements to be part of a law firm's overhead and will not pay such charges. These items include:

- Rent (including temporary office space)
- Westlaw, Lexis and other legal database services
- Cost or usage of computers or mobile devices or internet service charges
- Equipment rental
- Storage charges
- Catering for internal meetings
- Meals (except during business travel, and then limited to \$70 per day)
- Mileage for short trips (<30 miles one way)
- Travel costs exceeding discounted, non-refundable coach fares except where excess costs have been approved in advance
- Telephone charges

- Facsimile charges
- Allocated charges from a firm's blanket service agreements with outside vendors

**H. Copying/scanning.**

Copying charges may be billed to the City at the lesser of the most favorable rate applied by Outside Counsel or five cents per page. The City will reimburse for document scanning at Outside Counsel firm's regular rate, up to a maximum of five cents per page, for document productions, but the City will not pay time charges associated with scanning, and there shall be no charges associated with the scanning and filing of court papers and correspondence. Every effort shall be made to minimize scanning expenses by working with documents in electronic format whenever possible.

**I. Couriers and Overnight Mail.**

The City will reimburse for actual charges billed to Outside Counsel for deliveries (including overnight express) that are necessary in the interest of speed and reliability. Outside Counsel shall use the lowest cost service consistent with need and reliability, and to arrange schedules, whenever practicable, to avoid the need for premium-priced couriers. Outside Counsel shall use less expensive means, such as email (encrypted, when necessary) or regular mail where it is practical to do so.

**J. Travel Expenses.**

All air and rail travel must be first approved by the Corporation Counsel, ideally as part of the case budget. Outside Counsel shall use good judgment in selecting hotels and restaurants and incurring expenses for which the taxpayers are to be charged. Outside Counsel shall use alternatives to travel such as conference calls or videoconferences whenever practicable. If the travel involves another client, the City may be billed only for its proportionate share of both time and related expenses. **Non-working travel time is not billable without the Corporation Counsel's prior approval.**

**K. Reimbursement of Meals for Overnight Travel.**

The City will reimburse for meals consumed while traveling overnight on City business, but limited (absent prior approval) to no more than seventy dollars (\$70) per person, per day. Under no circumstances will the City reimburse costs for alcoholic beverages.

**L. Maintenance of Expense Records.**



To ensure compliance with the City's reimbursement policies, Outside Counsel shall require itemization of out-of-pocket expenses such as airline tickets, meals and hotel bills before making reimbursement to any attorney, employee or third party, and maintain original receipts. Travel and meal expenses and receipts may be audited and shall be retained by Outside Counsel in accordance with applicable IRS guidelines. Unless requested to do so by the City, Outside Counsel shall not forward copies of travel and meal expense receipts to the City with the firm's invoices.

**M. Personal Expenses Not Reimbursable.**

Please take care to distinguish between personal expenses and properly chargeable business expenses. The City will not reimburse for, among other things, recreation fees, salon or spa charges, pay-per-view movies or other personal entertainment charges, airline baggage charges, travel agency expenses, shoe shines, toiletries, dry cleaning or laundry (except in the unlikely event travel of more than seven days' duration is required), or luggage.

**N. Vendor discounts must be passed through.**

If Outside Counsel receives a discount or rebate from a vendor based on the aggregate level of business with that vendor, such discount shall be disclosed and the City shall receive the benefit on a proportionate basis. This does not include frequent-flyer miles or similar perquisites allocated to individual travelers.

**IV. COMPLIANCE WITH AFFIRMATIVE ACTION PLAN**

(a) If the Agreement exceeds \$40,000.00, it shall be subject to the Affirmative Action Amendments to the Law against Discrimination, N.J.S.A. 10:5-31 et seq.

(b) This Agreement shall not become effective and Contractor shall provide no services under this Agreement until it has executed the following documents:

1. A supplemental Affirmative Action Agreement pursuant to N.J.S.A. 10:5-31 et seq. (for contracts which exceed \$40,000.00). The Affirmative Action Agreement is attached hereto as Exhibit "B" and is incorporated herein by reference.

2. An Affirmative Action Employee Information Report (form AA-302) (for contracts which exceed \$40,000.00).

**V. CITY OF JERSEY CITY LOBBYIST DISCLOSURE ORDINANCE**

This contract was awarded in accordance with the provisions of the City's Disclosure of Lobbyist Representative Status Ordinance §3-9.1 et seq. adopted on June 12, 2002. As such the

undersigned does hereby attest that Contractor either did not retain the services of a lobbyist to lobby on behalf of the Contractor for the award of this contract, or if a lobbyist was retained by the Contractor for such purposes, the Contractor's lobbyist, prior to commencing his/her lobbying activities, filed a notice of lobbyist representative status form with the City Clerk. Any Contractor whose lobbyist failed to comply with the provisions of Ordinance §3-9.1 et seq., following notice and an opportunity to be heard, shall be disqualified from entering into contracts with the City for a period of two (2) years for each violation.

## **VI. CONFIDENTIALITY**

In the course of representing the City, Outside Counsel will frequently gain access to nonpublic and confidential information. The City requires Outside Counsel to maintain the confidentiality of such information both during and after the course of Outside Counsel's representation of the City. Outside Counsel must have in place appropriate procedures to ensure the protection of all such information. In the event the representation requires Outside Counsel to become privy to protected personally-identifiable information about any person, such as health or financial records, Social Security numbers or other such information, then this information must be handled with the utmost care both within facilities in Outside Counsel's control, and certainly when that information is being transported. Under no circumstances shall such confidential information be transported outside Counsel's offices--either physically or over the public internet--unless the information is appropriately encrypted. In the event information is compromised or potentially compromised, Outside Counsel must notify the City immediately.

Outside Counsel must follow all statutory, regulatory, and ethical provisions relating to privacy, confidentiality and nondisclosure of all privileged, proprietary and confidential information. Outside Counsel must take appropriate measures to ensure that all legal and non-legal personnel are familiar with this requirement and are effectively supervised in this regard.

Vendors to whom Outside Counsel gives access to confidential or proprietary material of the City (including work product) must sign the confidentiality agreement attached as Appendix A. It is the responsibility of Outside Counsel to obtain a signed confidentiality agreement from each vendor and to retain those agreements.

This Confidentiality Section and the corresponding Confidentiality Agreement attached as Appendix A, is above and beyond any relationships or privileges held or created separate and apart from this Agreement.

## **VII. NEW JERSEY BUSINESS REGISTRATION REQUIREMENTS**

Outside Counsel shall provide written notice to its subcontractors of the responsibility to submit proof of business registration to the contractor.

Before final payment on the contract is made by the contracting agency, the contractor shall submit an accurate list and the proof of business registration of each subcontractor or supplier used in the fulfillment of the contract, or shall attest that no subcontractors were used.

For the term of the contract, the contractor and each of its affiliates and a subcontractor and each of its affiliates [N.J.S.A. 52:32-44(g)(3)] shall collect and remit to the Director, New Jersey Division of Taxation, the use tax due pursuant to the Sales and Use Tax Act on all sales of tangible personal property delivered into this State, regardless of whether the tangible personal property is intended for a contract with a contracting agency.

A business organization that fails to provide a copy of a business registration as required pursuant to section 1 of P.L.2001, c.134 (C.52:32-44 et al.) or subsection e. or f. of section 92 of P.L.1977, c.110 (C.5:12-92), or that provides false business registration information under the requirements of either of those sections, shall be liable for a penalty of \$25 for each day of violation, not to exceed \$50,000 for each business registration copy not properly provided under a contract with a contracting agency.

#### **VIII. CITY OF JERSEY CITY CONTRACTOR PAY-TO-PLAY REFORM ORDINANCE**

The contract is awarded in accordance with the City of Jersey City's Contractor Pay-to-Play Reform Ordinance 08-128 adopted on September 23, 2008. The Contractor, its subsidiaries, assigns or principals have certified that they have neither made a reportable contribution in the one year period preceding the date that the City Council awarded the contract that would be deemed to be a violation of Ordinance 08-128, nor will Contractor, its subsidiaries, assigns or principals make a reportable contribution during the term of the contract that would be in violation of Ordinance 08-128.

#### **IX. TERMINATION**

The City reserves the right to terminate the within Agreement at any time for any reason whatsoever, in which event Outside Counsel shall be paid for services due up to the date of termination. Thereafter, this Agreement shall be considered null and void with no further rights or obligations emanating therefrom. Unless sooner terminated or renewed, this contract shall be for a term of one (1) year commencing on the date the contract is executed by City officials.

#### **X. GENERAL TERMS**

##### **A. Governing Law/Jurisdiction.**

This Agreement will be interpreted in accordance with, and governed by, the laws of the State of New Jersey. The courts of the State of New Jersey will have exclusive jurisdiction and the parties irrevocably attorney to the jurisdiction of such courts.

**B. Counterparts Clause.**

This Agreement may be executed by e-mail in counterparts all of which will be deemed originals and legally binding once delivered to each of the other parties' authorized e-mail addresses and such delivery is acknowledged by reply e-mail. Although not necessary to legally bind the parties, each party agrees to promptly circulate signed originals in sufficient number to the other parties for record-keeping purposes after completing the e-mail execution and delivery. All counterparts when executed and delivered (by e-mail or in paper form) will be construed together to be an original and will constitute one and the same agreement.

By accepting an engagement by the City, law firms will be deemed to have familiarized themselves with this agreement and to have agreed to adhere to it in all respects, now and as they may be amended from time to time upon written notice and acceptance. This acceptance is a matter both of contract and professional responsibility.

Attest:

City of Jersey City

\_\_\_\_\_  
Robert Byrne  
City Clerk

\_\_\_\_\_  
Brian Platt  
Business Administrator

WITNESS:

Desha Jackson Law Group, LLC

\_\_\_\_\_  
By:  
Firm:

**APPENDIX A**

**CONFIDENTIALITY AGREEMENT**

\_\_\_\_\_  
(Subcontractor), as a contractor of Outside Counsel retained by the City of Jersey City (the "City") pursuant to an "Outside Counsel Agreement" dated \_\_\_\_\_, hereby acknowledges and agrees as follows:

1. All documents and data, including but not limited to financial, statistical, personnel, customer and/or technical documents, owned or supplied by the City to the Subcontractor, shall be treated as confidential (Documents and Data). The Subcontractor shall take all necessary and reasonable precautions to ensure that the City's Documents and Data are safeguarded. Use of the Documents and Data is strictly limited to that use necessary to complete the scope of work agreed upon, which may include disclosure to employees, officers or agents of any subcontractor assisting with the scope of work. Any other use, and any sale or offering of the Documents and Data in any form by the Subcontractor, or any individual or entity in the Subcontractor's charge or employ, will be considered a violation of this Confidentiality Agreement and may result in termination of the agreement between Subcontractor and the law firm retained by the City, and the Subcontractor's suspension or debarment from City contracting. In addition, such conduct may be reported to the appropriate authorities for possible criminal prosecution.

2. Subcontractor shall be responsible to ensure that all agents and individuals or entities in the Subcontractor's charge or employ adhere to this Confidentiality Agreement. A breach of confidentiality by any individual or entity in the Subcontractor's charge or employ will be considered a violation of this Confidentiality Agreement by the Subcontractor.

3. In the event that Subcontractor, its agent or any individual or entity in the Subcontractor's charge or employ receives a subpoena, demand, or other request for any of the City's documents or data, Subcontractor shall promptly notify the City and shall not turn over any of the City's documents or data.

4. The Subcontractor shall comply with all applicable City and Federal laws that require the notification of individuals in the event of unauthorized release of personally-identifiable information or other event requiring notification. In the event of a breach of any of the Subcontractor's confidentiality obligations or other event requiring notification under applicable law ("Notification Event"), the Subcontractor agrees to assume responsibility for informing all such individuals in accordance with applicable law and to indemnify, hold harmless and defend the City and its trustees, officers, and employees from and against any claims, damages, or other harm related to such Notification Event.

5. Upon termination of this Confidentiality Agreement the Subcontractor shall return or erase, destroy, and render unreadable all Subcontractor copies of City Documents and Data, both physical and electronic, and certify in writing that these actions have been completed within 30 days of the termination of this Confidentiality Agreement or within 14 days of the request of an agent of the City, whichever shall come first.

6. This Confidentiality Agreement shall survive the Subcontractor's termination of the contract between the law firm retained by the City and Subcontractor or upon completion of the scope of work related to the City.

Subcontractor/Firm: \_\_\_\_\_

By: \_\_\_\_\_

Title: \_\_\_\_\_

Date: \_\_\_\_\_

**APPENDIX A**  
**AMERICANS WITH DISABILITIES ACT OF 1990**  
Equal Opportunity for Individuals with Disability

The contractor and the \_\_\_\_\_ of \_\_\_\_\_ (hereafter "owner") do hereby agree that the provisions of Title II of the Americans With Disabilities Act of 1990 (the "Act") (42 U.S.C. 5121 et seq.), which prohibits discrimination on the basis of disability by public entities in all services, programs, and activities provided or made available by public entities, and the rules and regulations promulgated pursuant thereto, are made a part of this contract. In providing any aid, benefit, or service on behalf of the owner pursuant to this contract, the contractor agrees that the performance shall be in strict compliance with the Act. In the event that the contractor, its agents, servants, employees, or subcontractors violate or are alleged to have violated the Act during the performance of this contract, the contractor shall defend the owner in any action or administrative proceeding commenced pursuant to this Act. The contractor shall indemnify, protect, and save harmless the owner, its agents, servants, and employees from and against any and all suits, claims, losses, demands, or damages, of whatever kind or nature, arising out of or claimed to arise out of the alleged violation. The contractor shall, at its own expense, appear, defend, and pay any and all charges for legal services and any and all costs and other expenses arising from such action or administrative proceeding or incurred in connection therewith. In any and all complaints brought pursuant to the owner's grievance procedure, the contractor agrees to abide by any decision of the owner which is rendered pursuant to said grievance procedure. If any action or administrative proceeding results in an award of damages against the owner, or if the owner incurs any expense to cure a violation of the ADA which has been brought pursuant to its grievance procedure, the contractor shall satisfy and discharge the same at its own expense.

The owner shall, as soon as practicable after a claim has been made against it, give written notice thereof to the contractor along with full and complete particulars of the claim. If any action or administrative proceeding is brought against the owner or any of its agents, servants, and employees, the owner shall expeditiously forward or have forwarded to the contractor every demand, complaint, notice, summons, pleading, or other process received by the owner or its representatives.

It is expressly agreed and understood that any approval by the owner of the services provided by the contractor pursuant to this contract will not relieve the contractor of the obligation to comply with the Act and to defend, indemnify, protect, and save harmless the owner pursuant to this paragraph.

It is further agreed and understood that the owner assumes no obligation to indemnify or save harmless the contractor, its agents, servants, employees and subcontractors for any claim which may arise out of their performance of this Agreement. Furthermore, the contractor expressly understands and agrees that the provisions of this indemnification clause shall in no way limit the contractor's obligations assumed in this Agreement, nor shall they be construed to relieve the contractor from any liability, nor preclude the owner from taking any other actions available to it under any other provisions of the Agreement or otherwise at law.

Representative's Name/Title: Debra Jackson Owner/Sole Proprietor  
Representative's Signature: [Signature]  
Name of Company: Debra Jackson Law Group LLC  
Tel. No.: 732-414-6663 Date: 4/5/18

EXHIBIT A (Continuation)

The contractor or subcontractor agrees to inform in writing its appropriate recruitment agencies including, but not limited to, employment agencies, placement bureaus, colleges, universities, and labor unions, that it does not discriminate on the basis of age, race, creed, color, national origin, ancestry, marital status, affectional or sexual orientation, gender identity or expression, disability, nationality or sex, and that it will discontinue the use of any recruitment agency which engages in direct or indirect discriminatory practices.

The contractor or subcontractor agrees to revise any of its testing procedures, if necessary, to assure that all personnel testing conforms with the principles of job-related testing, as established by the statutes and court decisions of the State of New Jersey and as established by applicable Federal law and applicable Federal court decisions.

In conforming with the targeted employment goals, the contractor or subcontractor agrees to review all procedures relating to transfer, upgrading, downgrading and layoff to ensure that all such actions are taken without regard to age, race, creed, color, national origin, ancestry, marital status, affectional or sexual orientation, gender identity or expression, disability, nationality or sex, consistent with the statutes and court decisions of the State of New Jersey, and applicable Federal law and applicable Federal court decisions.

The contractor shall submit to the public agency, after notification of award but prior to execution of a goods and services contract, one of the following three documents:

Letter of Federal Affirmative Action Plan Approval

Certificate of Employee Information Report

Employee Information Report Form AA302 (electronically provided by the Division and distributed to the public agency through the Division's website at [www.state.nj.us/treasury/contract\\_compliance](http://www.state.nj.us/treasury/contract_compliance))

The contractor and its subcontractors shall furnish such reports or other documents to the Division of Purchase & Property, CCAU, EEO Monitoring Program as may be requested by the office from time to time in order to carry out the purposes of these regulations, and public agencies shall furnish such information as may be requested by the Division of Purchase & Property, CCAU, EEO Monitoring Program for conducting a compliance investigation pursuant to Subchapter 10 of the Administrative Code of N.J.A.C. 17:27.

The undersigned vendor certifies on their company's receipt, knowledge and commitment to comply with:

EXHIBIT A  
N.J.S.A. 10:5-31 and N.J.A.C. 17:27  
MANDATORY EQUAL EMPLOYMENT OPPORTUNITY LANGUAGE  
Goods, Professional Services and General Service Contracts  
(Mandatory Affirmative Action Language)

The undersigned vendor further agrees to furnish the required forms of evidence and

understands that their contract/company's bid shall be rejected as non-responsive if said contractor fails to comply with the requirements of N.J.S.A. 10:5-31 and N.J.A.C. 17:27.

Representative's Name/Title (Print): Debra Jackson Owner/Sole Proprietor

Representative's Signature: [Signature]

Name of Company: Debra Jackson CAW Group LLC

Tel. No.: 732-414-6663

Date: 7/5/18



Minority/Woman Business Enterprise (MWBE)  
Questionnaire for Bidders

Jersey City Ordinance C-829 establishes a goal of awarding 20% of the dollar amount of total city procurement to minority and woman owned business enterprises.

To assist us in monitoring our achievement of this goal, please indicate below whether your company is or is not a minority owned and/or woman owned business, and return this form with your bid proposal.

Business Name : Debra Jackson / AWG Group LLC  
Address : 120 Willow Brook Rd, Ste 250, Freshkill, NJ 07728  
Telephone No : 732-414-6663  
Contact Name : Debra Jackson

Please check applicable category:

Minority Owned Business (MBE)

Minority & Woman Owned Business (MWBE)

Woman Owned business (WBE)

Neither

Definitions

Minority Business Enterprise

Minority Business Enterprise means a business which is a sole proprietorship, partnership or corporation at least 51% of which is owned and controlled by persons who are African American, Hispanic, Asian American, American Indian or Alaskan native, defined as follows:

**African American:** a person having origins in any of the black racial groups of Africa

**Hispanic:** a person of Mexican, Puerto Rican, Central or South American or other non-European Spanish culture or origin regardless of race.

**Asian:** a person having origins in any of the original peoples of the Far East, South East Asia, Indian subcontinent, Hawaii or the Pacific Islands.

**American Indian or Alaskan Native:** a person having origins in any of the original peoples of North America and who maintains cultural identification through tribal affiliation or community recognition.

Woman Business Enterprise

Woman Business Enterprise means a business which is a sole proprietorship, partnership or corporation at least 51% of which is owned and controlled by a woman or women.

OFFICE OF EQUAL OPPORTUNITY COPY

Minority/Woman Business Enterprise (MWBE)  
Questionnaire for Bidders

Jersey City Ordinance C-829 establishes a goal of awarding 20% of the dollar amount of total city procurement to minority and woman owned business enterprises.

To assist us in monitoring our achievement of this goal, please indicate below whether your company is or is not a minority owned and/or woman owned business; and return this form with your bid proposal.

Business Name:

Debra Jackson LAW Group LLC

Address:

10 Willow Brook Rd, Ste 250, Freehold, NJ 07728

Telephone No.:

732-414-6663

Contact Name:

Debra Jackson

Please check applicable category:

Minority Owned Business (MBE)

Minority & Woman Owned Business (MWBE)

Woman Owned business (WBE)

Neither

Definitions

Minority Business Enterprise

Minority Business Enterprise means a business which is a sole proprietorship, partnership or corporation at least 51% of which is owned and controlled by persons who are African American, Hispanic, Asian American, American Indian or Alaskan native, defined as follows:

African American: a person having origins in any of the black racial groups of Africa

Hispanic: a person of Mexican, Puerto Rican, Central or South American or other non-European Spanish culture or origin regardless of race.

Asian: a person having origins in any of the original peoples of the Far East, South East Asia, Indian subcontinent, Hawaii or the Pacific Islands.

American Indian or Alaskan Native: a person having origins in any of the original peoples of North America and who maintains cultural identification through tribal affiliation or community recognition.

Woman Business Enterprise

Woman Business Enterprise means a business which is a sole proprietorship, partnership or corporation at least 51% of which is owned and controlled by a woman or women.

DIVISION OF PURCHASING COPY

STATE OF NEW JERSEY DEPARTMENT OF THE TREASURY  
 DIVISION OF CONTRACT COMPLIANCE & EQUAL EMPLOYMENT OPPORTUNITY  
 VENDOR ACTIVITY SUMMARY REPORT

NEW HIRING  PROMOTIONS  TRANSFERS  REASSIGNATIONS (CHECK  APPLICABLE ACTIVITIES)  
 DATES OF PAYROLL PERIOD USED: FROM 8/20/08 TO 8/20/08

CONTRACTS NO. 100 Willow Brook Road Suite 200  
 NAME OF FACILITY: 100 Willow Brook Road Suite 200  
 ADDRESS: 100 Willow Brook Road Suite 200  
 CITY: North Plainfield  
 COUNTY: Essex  
 STATE: NJ ZIP CODE: 07063

JOB	COMPARISONS				OFFICIALS & MANAGERS				PROFESSORIALS	TECHNICIANS	SALES WORKERS	OFFICE & SERVICE	CRAFTSMEN	OPERATIVES	LABORERS	SERVICE WORKERS	TOTAL	
	White	Black	Hispanic	AM. Indian	Asian	Non-Hispanic	Latinal	Black										Hispanic

I certify that the information on this form is true and correct.  
 NAME OF PERSON COMPLETING FORM (PRINT OR TYPE): [Signature]  
 TITLE: [Signature]  
 ADDRESS NO. & STREET: 100 Willow Brook Road Suite 200  
 CITY: North Plainfield STATE: NJ ZIP CODE: 07063  
 PHONE (AREA CODE, NO., EXTENSION): 973-416-6163  
 DATE SUBMITTED: 4/15/18

STATE OF NEW JERSEY DEPARTMENT OF THE TREASURY  
 DIVISION OF CONTRACT COMPLIANCE & EQUAL EMPLOYMENT OPPORTUNITY  
 VENDOR ACTIVITY SUMMARY REPORT

NEW HIRE  PROMOTIONS  TRANSFERS  TERMINATIONS (CHECK (X) APPROPRIATE ACTIVITY)

CERTIFICATE NO. \_\_\_\_\_  
 NAME OF FACILITY: 208th Salsdon LHM Group LLC  
100 William Brook Suite 250 Freehold, Monmouth  
 ADDRESS OF PAYROLL PERIOD USED: FROM 2/18 NO. 2018  
 TO 2/28 ZIP CODE 07728

JOB CATEGORIES	MALE					FEMALE						
	Total	Black	Hispanic	Am. Indian	Asian	New-Wha.	Total	Black	Hispanic	Am. Indian	Asian	New-Wha.
EXECUTIVES & MANAGERS												
PROFESSIONALS												
TECHNICIANS												
SKILLED WORKERS												
OFFICE & CLERICAL												
CHAFTEWORKERS												
OPERATIVES												
LABORERS												
SERVICE WORKERS												
UNEMPLOYED												

I certify that the information on this form is true and correct.  
 NAME OF PERSON COMPLETING FORM (Print or Type) Salsdon Design  
 FIRST Salsdon LAST Design  
 ADDRESS (NO. & STREET) 100 William Brook Suite 250  
 CITY (PRINT) Freehold STATE (STANDARD) NJ ZIP (ZIP) 07728  
 PHONE (AREA CODE, NO., EXTENSION) 732-414-6663  
 DATE SUBMITTED 4/5/18

STATE OF NEW JERSEY DEPARTMENT OF TREASURY  
 DIVISION OF CONTRACT COMPLIANCE & EQUAL EMPLOYMENT OPPORTUNITY  
 YEAR-END ACTIVITY SUMMARY REPORT

These firms:  PROMOTERS  MEMBERS  PARTICIPATIONS (CHECK (X) APPROPRIATE ACTIVITY)

REGISTRATION NO. 557 AN Group LLC  
 NAME OF FIRM: 557 AN Group LLC  
 ADDRESS: Million Book Holdings Suite Fresh Meadows, NY  
 CITY: Fresh Meadows STATE: NY ZIP CODE: 11722  
 PHONE: 732-410-6663  
 DATE SUBMITTED: 4/5/18

CATEGORIES	RACE					ETHNICITY					
	Total	Black	Hispanic	Am. Indian	Asian	Non-Wh.	Black	Hispanic	Am. Indian	Asian	Non-Wh.
OFFICIALS & MANAGERS											
PROFESSIONALS											
TECHNICIANS											
SALES WORKERS											
OFFICE & GENERAL											
CRAFTSMEN											
OPERATIVES											
LABORERS											
SERVICE WORKERS											
TOTAL	<u>N/A</u>										

I certify that the information on this Form is true and correct.  
 NAME OF PERSON COMPLETING FORM (Print or Type):  
 SIGNATURE: [Signature]

NAME: Million Book Holdings Suite  
 ADDRESS (NO. & STREET): Million Book Holdings Suite  
 CITY: Fresh Meadows STATE: NY ZIP: 11722  
 PHONE AREA CODE, NO., EXTENSION: 732-410-6663

STATE OF NEW JERSEY DEPARTMENT OF THE TREASURY  
 DIVISION OF CONTRACT COMPLIANCE, & EQUAL EMPLOYMENT OPPORTUNITY  
 VENDOR ACTIVITY SUMMARY REPORT

NEW HIRES  PROMOTIONS  TRANSFERS  REASSIGNMENTS (CHECK (X) APPROPRIATE ACTIVITY)

CERTIFICATE NO. \_\_\_\_\_ NAMES OF EMPLOYER PERIOD USED: FROM 2018 TO 2019

NAME OF EMPLOYER: VSLAVE GROUP LLC COUNTY: NEW JERSEY ZIP CODE: 07128

100 William Brook Rd Suite 200 Freshfield Monmouth NJ

JOB	TITLE					SERIES						
	Formal	Alloc	Temp	Rel. Admin	Admin	Non-Adm.	Hotel	Black	Temp	Int. Transfer	Adm.	Non-Adm.
MANAGERS												
OFFICIALS & MANAGERS												
PROFESSIONALS												
TECHNICIANS												
SALES WORKERS												
OFFICE & CLERICAL												
CRAFTWORKERS												
OPERATORS												
LABORERS												
SERVICE WORKERS												
TOTAL	N/A											N/A

I certify that the information on this form is true and correct.  
 NAME OF PERSON COMPLETING FORM (Print or Type): Jackson Debra

ADDRESS (NO. & STREET): 100 William Brook Rd Suite 200  
 (CITY): Freshfield (STATE): NJ (ZIP): 07128

PHONE (AREA CODE, NO., EXTENSION): 732-410-6663

DATE SUBMITTED: 4/5/18

Certification 58119

### CERTIFICATE OF EMPLOYEE INFORMATION REPORT INITIAL

This is to certify that the contractor listed below has submitted an Employee Information Report pursuant to N.J.A.C. 17-27-1.1 3rd seq. and the State Treasurer has approved said report. This approval will remain in effect for the period of 15-SEP-2017 to 15-SEP-2024.

DESHA JACKSON LAW GROUP, LLC  
100 WILLOW BROOK ROAD  
FREEHOLD NJ 07728

*Ford M. Scudder*  
FORD M. SCUDDER  
State Treasurer





**STATE OF NEW JERSEY  
BUSINESS REGISTRATION CERTIFICATE**

**Taxpayer Name:** DESHA JACKSON LAW GROUP LIMITED LIABILITY  
COMPANY

**Trade Name:**

**Address:** 100 WILLOWBROOK RD. STE 250  
FREEHOLD, NJ 07728

**Certificate Number:** 1798200

**Effective Date:** May 24, 2013

**Date of Issuance:** August 14, 2017

**For Office Use Only:**  
20170814150047550





**BUSINESS ENTITY DISCLOSURE CERTIFICATION  
FOR NON-FAIR AND OPEN CONTRACTS**  
Required Pursuant To N.J.S.A. 19:44A-20.8  
**CITY OF JERSEY CITY**

**Part I – Vendor Affirmation**

The undersigned, being authorized and knowledgeable of the circumstances, does hereby certify that the <name of business entity> has not made and will not make any reportable contributions pursuant to N.J.S.A. 19:44A-1 et seq. that, pursuant to P.L. 2004, c. 19 would bar the award of this contract in the one year period preceding (date of award scheduled for approval of the contract by the governing body) to any of the following named candidate committee, joint candidates committee; or political party committee representing the elected officials of the <name of entity of elected officials> as defined pursuant to N.J.S.A. 19:44A-3(p), (q) and (r).

Steven Fulop for Mayor 2017	Mira Prinz-Arey for Council
Lavarro for Councilman	Friends of Richard Boggiano
Friends of Joyce Waterman	Michael Yun for Council
Friends of Daniel Rivera	Solomon for Council
Ridley for Council	Friends of Jermaine Robinson

**Part II – Ownership Disclosure Certification**

I certify that the list below contains the names and home addresses of all owners holding 10% or more of the issued and outstanding stock of the undersigned.

Check the box that represents the type of business entity?

- Partnership    
  Corporation    
  Sole Proprietorship    
  Subchapter S Corporation  
 Limited Partnership    
  Limited Liability Corporation    
  Limited Liability Partnership

Name of Stock or Shareholder	Home Address
N/A	

**Part 3 – Signature and Attestation:**

The undersigned is fully aware that if I have misrepresented in whole or part this affirmation and certification, I and/or the business entity will be liable for any penalty permitted under law.

Name of Business Entity: DeSha Jackson Landscaping LLC  
 Signature of Affiant: [Signature] Title: Owner  
 Printed Name of Affiant: DeSha Jackson Date: 4/5/18

Subscribed and sworn before me this 5th day of April, 2018

My Commission expires: December 23, 2021

[Signature]  
 (Witnessed or attested by)  
**KATHERINE ALBARRAN**  
 NOTARY PUBLIC OF NEW JERSEY  
 My Commission Expires December 23, 2021

**CERTIFICATION OF COMPLIANCE WITH THE CITY OF JERSEY CITY  
CONTRACTOR PAY-TO-PLAY REFORM ORDINANCE 08-128 ADOPTED  
ON SEPTEMBER 3, 2008**

**PART I - Vendor Affirmation**

The undersigned, being authorized and knowledgeable of the circumstances, does hereby certify that Debra Jackson LLC (name of business entity) has not made any reportable contributions in the \*\*one-year period preceding 2017-2018 (date City Council awards contract) that would be deemed to be violations of Section One of the City of Jersey City's Contractor Pay-to-Play Reform Ordinance 08-128 (attached hereto) and that would bar the award of this contract. I further certify that during the term of the contract Debra Jackson LLC (name of business entity) will not make any reportable contributions in violation of Ordinance 08-128.

**PART II - Signature and Attestation:**

The undersigned is fully aware that if I have misrepresented in whole or part this affirmation and certification, I and/or the business entity, will be liable for any penalty permitted under law.

Name of Business Entity: Debra Jackson LLC

Signed: [Signature] Title: OWNER

Print Name: Debra Jackson Date: 4/5/18

Subscribed and sworn before me  
this 5<sup>th</sup> day of April, 2018.

My Commission expires

(Affiant)

(Print name & title of affiant) (Corporate Seal)

[Signature]

**KATHERINE ALBARRAN  
NOTARY PUBLIC OF NEW JERSEY  
My Commission Expires December 23, 2021**

**\*\*Pursuant to Section 2 of Ordinance 08-128, no contributions or solicitation of contributions made prior to the effective date Ordinance 08-128 (September 23, 2008) shall be deemed to be a violation of the Ordinance.**

# Resolution of the City of Jersey City, N.J.

City Clerk File No. Res - 18-995

Agenda No. 10.Z.10

Approved: NOV 07 2018

TITLE:



**RESOLUTION RATIFYING A PROFESSIONAL SERVICES AGREEMENT WITH THE LAW FIRM OF GOLDENBERG, MACKLER, SAYEGH, MINTZ, PFEFFER, BONCHI & GILL TO REPRESENT THE CITY OF JERSEY CITY IN THE BANKRUPTCY MATTER, IN RE: JEAN GASKINS**

**COUNCIL**

offered and moved adoption of the following resolution:

**WHEREAS**, on or about September 29, 1995, G&H Development and Construction Company executed a Second Repayment Mortgage and Note with the City of Jersey City in the amount of \$255,000 for the property, a residential building with commercial space located at 327-329 Martin Luther King, also known as Block 22503, Lot 43 and Lot 48; and

**WHEREAS**, the Property is also subject to an Affordable Housing Development Agreement recorded on October 2, 1995 in the Office of the Register of the County of Hudson in Deed Book 4910 at page 190; and

**WHEREAS**, on December 6, 1999 Jean Gaskins executed an Assumption Agreement of Mortgage, Note and Affordable Housing Agreement with the City; and

**WHEREAS**, on or about June 4, 2015, Jean Gaskins filed a Chapter 7 bankruptcy petition under Case No. 15-20530; and

**WHEREAS**, pursuant to an Order entered on July 14, 2016, the Bankruptcy Trustee was authorized to sell the property to BH Ventures, LLC subject to the City's affordable housing restrictions and to distribute the proceeds from the sale of the property to satisfy in full any pre-petition municipal taxes or other municipal liens or tax sale certificate holder; and

**WHEREAS**, at the time of the bankruptcy, there existed three (3) third party tax sale certificates; and

**WHEREAS**, when the Trustee issued payment of the tax sale certificates to the City's Tax Collector, the tax office did not accept partial payments; and

**WHEREAS**, the Trustee filed a Motion with the Bankruptcy court to determine the estate's tax liability and cap the redemption amounts for the Tax Sale Certificates No. 2012-1782 held by Gregory Judge and No. 2014-2421 held by Blue Virgo; and

**WHEREAS**, pursuant to a Consent Order entered on May 23, 2018, the bankruptcy estate paid the taxes and charges it was liable for up to September 7, 2016 on the two tax sale certificates; and

**WHEREAS**, a dispute remains with the lien holder Blue Virgo with respect to discharging its tax Sale Certificate upon payment from the Trustee; and

**WHEREAS**, it was in the City's best interest to appoint outside counsel with knowledge of Bankruptcy matters to represent the City of Jersey City; and

**WHEREAS**, the City is acquiring these services directly and openly as a statutorily permitted contract pursuant to the provisions of N.J.S.A. 19:44A-20.4 et seq. (the Pay-to-Play Law); and

**WHEREAS**, the law firm of Goldenberg, Mackler, Sayeh, Mintz, Pfeffer, Bonchi & Gill submitted a Qualification Statement in response to the City's RFQ; and

**WHEREAS**, the law firm of Goldenberg, Mackler, Sayeh, Mintz, Pfeffer, Bonchi & Gill has completed and submitted a Business Entity Disclosure Certification which certifies that he has not made any reportable contributions to the political or candidate committees listed in the Business Entity Disclosure Certification in the previous one year, and that the contract will prohibit Goldenberg, Mackler, Sayeh, Mintz, Pfeffer, Bonchi & Gill from making any reportable contributions during the term of the contract; and

**WHEREAS**, the law firm of Goldenberg, Mackler, Sayeh, Mintz, Pfeffer, Bonchi & Gill has submitted a Chapter 271 Political Contribution Disclosure Certification at least 10 days prior to the award of this contract; and

City Clerk File No. Res. 18-995  
Agenda No. 10.Z.10 NOV 07 2018

TITLE:

**RESOLUTION RATIFYING A PROFESSIONAL SERVICES AGREEMENT WITH THE LAW FIRM OF GOLDENBERG, MACKLER, SAYEGH, MINTZ, PFEFFER, BONCHI & GILL TO REPRESENT THE CITY OF JERSEY CITY IN THE BANKRUPTCY MATTER OF CITY OF JERSEY CITY V. JEAN GASKINS**

WHEREAS, the law firm of Goldenberg, Mackler, Sayeh, Mintz, Pfeffer, Bonchi & Gill has submitted its Certification of Compliance with the City's Contractor Pay-to-Play Reform Ordinance 08-128 adopted on September 3, 2008; and

WHEREAS, funds in the amount of \$7,500.00 are available in Account No. 18-01-201-20-155-312; and

WHEREAS, the resolution authorizing the award and the agreement itself must be available for public inspection.

NOW, THEREFORE, BE IT RESOLVED by the Municipal Council of the City of Jersey City that:

1. The agreement with the law firm of Goldenberg, Mackler, Sayegh, Mintz, Pfeffer, Bonchi & Gill is hereby ratified and authorized for one year effective May 1, 2018 for a total contract amount of \$7,500.00; and
2. This contract shall be subject to the condition that the vendor provides satisfactory evidence of compliance with the Affirmative Action Amendments to the Law against Discrimination, N.J.S.A. 10:5-31 et seq.
3. The Mayor or Business Administrator is hereby authorized to execute an agreement in substantially the form attached subject to such modification, as the Corporation Counsel deems appropriate or necessary.
4. A copy of this resolution will be published in a newspaper of general circulation in the City of Jersey City as required by law within (10) days of the adoption of the resolution.
5. The Business Entity Disclosure Certification, Chapter 271 Political Contribution Disclosure Certification, Certification of Compliance with the City's Contractor Pay-to-Play Reform Ordinance, and the Determination of Value Certification, attached hereto, shall be placed on file with this Resolution.
6. This agreement is awarded without competitive bidding as a professional services agreement under the Local Public Contracts Law, N.J.S.A. 40A:11-1 et seq.
7. Pursuant to N.J.A.C. 5:30-5.5(c), the continuation of the contract after the expenditure of funds encumbered in the 2018 fiscal year budget shall be subject the encumbrance of funds in the 2019 fiscal year budget.

I, Donna Mauer, Chief Financial Officer, hereby certify that there are sufficient funds available in Account No.: 18-01-201-20-155-312 for payment of this resolution. P.O. No. 131217

JMK  
10/26/18

10/26/2018

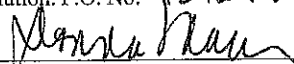
  
Donna Mauer, Chief Financial Officer

APPROVED: \_\_\_\_\_

APPROVED AS TO LEGAL FORM

APPROVED:  \_\_\_\_\_  
Business Administrator

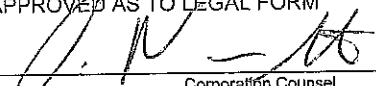
 \_\_\_\_\_  
Corporation Counsel

Certification Required

Not Required

APPROVED 8-0

RECORD OF COUNCIL VOTE ON FINAL PASSAGE 11.7.18											
COUNCILPERSON	AYE	NAY	N.V.	COUNCILPERSON	AYE	NAY	N.V.	COUNCILPERSON	AYE	NAY	N.V.
RIDLEY	✓			YUN	✓			RIVERA	✓		
PRINZ-AREY	✓			SOLOMON	✓			WATTERMANN	ABSENT		
BOGGIANO	✓			ROBINSON	✓			LAVARRO, PRES	✓		

✓ Indicates Vote

N.V.-Not Voting (Abstain)

Adopted at a meeting of the Municipal Council of the City of Jersey City N.J.

  
Rolando R. Lavarro, Jr., President of Council

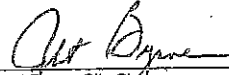
  
Robert Byrne, City Clerk

**RESOLUTION FACT SHEET - CONTRACT AWARD**

This summary sheet is to be attached to the front of any resolution that is submitted for Council consideration. Incomplete or vague fact sheets will be returned with the resolution.

**Full Title of Ordinance/Resolution**

**RESOLUTION RATIFYING A PROFESSIONAL SERVICES AGREEMENT WITH THE LAW FIRM OF GOLDENBERG, MACKLER, SAYEGH, MINTZ, PFEFFER, BONCHI & GILL TO REPRESENT THE CITY OF JERSEY CITY IN THE BANKRUPTCY MATTER OF CITY OF JERSEY CITY V. JEAN GASKINS**

**Project Manager**

Department/Division	Law	Law
Name/Title	Peter Baker	Corporation Counsel
Phone/email	201-547-4667	PBaker@icnj.org

Note: Project Manager must be available by phone during agenda meeting (Wednesday prior to council meeting @ 4:00 p.m.)

**Contract Purpose**

This is a continuation of a professional consultant to represent the City in a pending foreclosure matter involving the property located at 227 Clinton Avenue.

**Cost (Identify all sources and amounts)**

Law Department Funds  
01-201-20-155-312  
(\$7,500.00)

**Contract term (include all proposed renewals)**

One Year

Type of award

If "Other Exception", enter type

**Additional Information**

I certify that all the facts presented herein are accurate.

  
\_\_\_\_\_  
Signature of Department Director

10/30/18  
\_\_\_\_\_  
Date

(REVISED 4/13)

**EXHIBIT A**  
**MANDATORY EQUAL EMPLOYMENT OPPORTUNITY LANGUAGE**  
N.J.S.A. 10:5-31 et seq. (P.L. 1975, C. 127)  
N.J.A.C. 17:27

**GOODS, PROFESSIONAL SERVICE AND GENERAL SERVICE CONTRACTS**

During the performance of this contract, the contractor agrees as follows:

The contractor or subcontractor, where applicable, will not discriminate against any employee or applicant for employment because of age, race, creed, color, national origin, ancestry, marital status, affectional or sexual orientation, gender identity or expression, disability, nationality or sex. Except with respect to affectional or sexual orientation and gender identity or expression, the contractor will ensure that equal employment opportunity is afforded to such applicants in recruitment and employment, and that employees are treated during employment, without regard to their age, race, creed, color, national origin, ancestry, marital status, affectional or sexual orientation, gender identity or expression, disability, nationality or sex. Such equal employment opportunity shall include, but not be limited to the following: employment, upgrading, demotion, or transfer; recruitment or recruitment advertising; layoff or termination; rates of pay or other forms of compensation; and selection for training, including apprenticeship. The contractor agrees to post in conspicuous places, available to employees and applicants for employment, notices to be provided by the Public Agency Compliance Officer setting forth provisions of this nondiscrimination clause.

The contractor or subcontractor, where applicable will, in all solicitations or advertisements for employees placed by or on behalf of the contractor, state that all qualified applicants will receive consideration for employment without regard to age, race, creed, color, national origin, ancestry, marital status, affectional or sexual orientation, gender identity or expression, disability, nationality or sex.

The contractor or subcontractor will send to each labor union, with which it has a collective bargaining agreement, a notice, to be provided by the agency contracting officer, advising the labor union of the contractor's commitments under this chapter and shall post copies of the notice in conspicuous places available to employees and applicants for employment.

The contractor or subcontractor, where applicable, agrees to comply with any regulations promulgated by the Treasurer pursuant to N.J.S.A. 10:5-31 et seq., as amended and supplemented from time to time and the Americans with Disabilities Act.

The contractor or subcontractor agrees to make good faith efforts to meet targeted county employment goals established in accordance with N.J.A.C. 17:27-5.2.

**EXHIBIT A (Continuation)**

The contractor or subcontractor agrees to inform in writing its appropriate recruitment agencies, including, but not limited to, employment agencies, placement bureaus, colleges, universities, and labor unions, that it does not discriminate on the basis of age, race, creed, color, national origin, ancestry, marital status, affectional or sexual orientation, gender identity or expression, disability, national origin or sex, and that it will discontinue the use of any recruitment agency which engages in direct or indirect discriminatory practices.

The contractor or subcontractor agrees to revise any of its testing procedures, if necessary, to assure that all personnel testing conforms with the principles of job-related testing, as established by the statutes and court decisions of the State of New Jersey and as established by applicable Federal law and applicable Federal court decisions.

In conforming with the targeted employment goals, the contractor or subcontractor agrees to review all procedures relating to transfer, upgrading, downgrading and layoff to ensure that all such actions are taken without regard to age, race, creed, color, national origin, ancestry, marital status, affectional or sexual orientation, gender identity or expression, disability, national origin or sex, consistent with the statutes and court decisions of the State of New Jersey, and applicable Federal law and applicable Federal court decisions.

The contractor shall submit to the public agency, after notification of award but prior to execution of a goods and services contract, one of the following three documents:

Letter of Federal Affirmative Action Plan Approval

Certificate of Employee Information Report

Employee Information Report Form AA302 (electronically provided by the Division and distributed to the public agency through the Division's website at [www.state.nj.us/treasury/contract\\_compliance](http://www.state.nj.us/treasury/contract_compliance))

The contractor and its subcontractors shall furnish such reports or other documents to the Division of Purchase & Property, CCAU, EEO Monitoring Program as may be requested by the office from time to time in order to carry out the purposes of these regulations, and public agencies shall furnish such information as may be requested by the Division of Purchase & Property, CCAU, EEO Monitoring Program for conducting a compliance investigation pursuant to Subchapter 10 of the Administrative Code at N.J.A.C. 17:27.

The undersigned vendor certifies on their company's receipt, knowledge and commitment to comply with:

**EXHIBIT A**  
N.J.S.A. 10:8-31 and N.J.A.C. 17:27  
**MANDATORY EQUAL EMPLOYMENT OPPORTUNITY LANGUAGE**  
Goods, Professional Services and General Service Contracts  
(Mandatory Affirmative Action Language)

The undersigned vendor further agrees to furnish the required forms of evidence and

understands that their contract/company's bid shall be rejected as non-responsive if said contractor fails to comply with the requirements of N.J.S.A. 10:8-31 and N.J.A.C. 17:27.

Representative's Name/Title (Print): Keith A. Bonchi, Esq., Partner

Representative's Signature: \_\_\_\_\_

Name of Company: Goldenberg, Mackler, Sayegh, Mintz, Pfeffer, Bonchi & Gill

Tel. No.: 609-646-0222

Date: 10/12/18



**APPENDIX A**  
**AMERICANS WITH DISABILITIES ACT OF 1990**  
**Equal Opportunity for Individuals with Disability**

The contractor and the City of Jersey City (hereafter "owner") do hereby agree that the provisions of Title II of the Americans With Disabilities Act of 1990 (the "Act") (42 U.S.C. §12101 et seq.), which prohibits discrimination on the basis of disability by public entities in all services, programs, and activities provided or made available by public entities, and the rules and regulations promulgated pursuant thereto, are made a part of this contract. In providing any aid, benefit, or service on behalf of the owner pursuant to this contract, the contractor agrees that the performance shall be in strict compliance with the Act. In the event that the contractor, its agents, servants, employees, or subcontractors violate or are alleged to have violated the Act during the performance of this contract, the contractor shall defend the owner in any action or administrative proceeding commenced pursuant to this Act. The contractor shall indemnify, protect, and save harmless the owner, its agents, servants, and employees from and against any and all suits, claims, losses, demands, or damages, of whatever kind or nature arising out of or claimed to arise out of the alleged violation. The contractor shall, at its own expense, appear, defend, and pay any and all charges for legal services and any and all costs and other expenses arising from such action or administrative proceeding or incurred in connection therewith. In any and all complaints brought pursuant to the owner's grievance procedure, the contractor agrees to abide by any decision of the owner which is rendered pursuant to said grievance procedure. If any action or administrative proceeding results in an award of damages against the owner, or if the owner incurs any expense to cure a violation of the ADA which has been brought pursuant to the grievance procedure, the contractor shall satisfy and discharge the same at its own expense.

The owner shall, as soon as practicable after a claim has been made against it, give written notice thereof to the contractor along with full and complete particulars of the claim. If any action or administrative proceeding is brought against the owner or any of its agents, servants, and employees, the owner shall expeditiously forward or have forwarded to the contractor every demand, complaint, notice, summons, pleading, or other process received by the owner or its representative.

It is expressly agreed and understood that any approval by the owner of the services provided by the contractor pursuant to this contract will not relieve the contractor of the obligation to comply with the Act and to defend, indemnify, protect, and save harmless the owner pursuant to this paragraph.

It is further agreed and understood that the owner assumes no obligation to indemnify or save harmless the contractor, its agents, servants, employees and subcontractors for any claim which may arise out of the performance of this Agreement. Furthermore, the contractor expressly understands and agrees that the provisions of this indemnification clause shall in no way limit the contractor's obligations assumed in this Agreement, nor shall they be construed to relieve the contractor from any liability, nor preclude the owner from taking any other actions available to it under any other provisions of the Agreement or otherwise at law.

Representative's Name/Title/Print: Keith A. Bonchi, Esq., Partner

Representative's Signature: \_\_\_\_\_

Name of Company: Goldenberg, Mackler, Sayegh, Mintz, Pfeffer, Bonchi & Gill

Tel. No.: 609-646-0222

Date: 10/12/18

**Minority/Woman Business Enterprise (MWBE)  
Questionnaire for Bidders**

Jersey City Ordinance C-829 establishes a goal of awarding 20% of the dollar amount of total city procurement to minority and woman owned business enterprises.

To assist us in monitoring our achievement of this goal, please indicate below whether your company is or is not a minority owned and/or woman owned business, and return this form with your bid proposal.

Business Name: Goldenberg, Mackler, Sayegh, Mintz, Pfeffer, Bonchi & Gill  
Address: 660 New Road, Suite 1A, Northfield, NJ 08225  
Telephone No.: (609) 646-0222  
Contact Name: Keith A. Bonchi, Esq.

Please check applicable category:

Minority Owned Business (MBE)       Minority & Woman Owned Business (MWBE)  
 Woman Owned business (WBE)       Neither

**Definitions**

**Minority Business Enterprise**

Minority Business Enterprise means a business which is a sole proprietorship, partnership or corporation at least 51% of which is owned and controlled by persons who are African American, Hispanic, Asian American, American Indian or Alaskan native, defined as follows:

**African American:** a person having origins in any of the black racial groups of Africa

**Hispanic:** a person of Mexican, Puerto Rican, Central or South American or other non-European Spanish culture or origin regardless of race.

**Asian:** a person having origins in any of the original peoples of the Far East, South East Asia, Indian subcontinent, Hawaii or the Pacific Islands.

**American Indian or Alaskan Native:** a person having origins in any of the original peoples of North America and who maintains cultural identification through tribal affiliation or community recognition.

**Woman Business Enterprise**

Woman Business Enterprise means a business which is a sole proprietorship, partnership or corporation at least 51% of which is owned and controlled by a woman or women.

**OFFICE OF EQUAL OPPORTUNITY COPY**

**CERTIFICATION OF COMPLIANCE WITH THE CITY OF JERSEY CITY  
CONTRACTOR PAY-TO-PLAY REFORM ORDINANCE 08-128 ADOPTED  
ON SEPTEMBER 23, 2008**

**PART I - Vendor Affirmation**

The undersigned, being authorized and knowledgeable of the circumstances, does hereby certify that the Goldenberg, Mackler, law firm (name of business entity) has not made any reportable contributions in the one year period preceding (date City Council awards contract) that would be deemed to be violations of Section One of the City of Jersey City's Contractor Pay-to-Play Reform Ordinance 08-128 (attached hereto) and that would bar the award of this contract. I further certify that during the term of the contract, the Goldenberg Mackler law firm (name of business entity) will not make any reportable contributions in violation of Ordinance 08-128.

**PART II - Signature and Attestation**

The undersigned is fully aware that if I have misrepresented in whole or part this affirmation and certification, I and/or the business entity, will be liable for any penalty permitted under law.

Name of Business Entity: Goldenberg, Mackler, Sayegh, Mintz, Pfeffer, Bonchi & Gill

Signed: [Signature] Title: Partner

Print Name: Keith A. Bonchi, Esq. Date: 10/12/18

Subscribed and sworn before me  
this 12th day of October, 2018.  
My Commission expires:

[Signature]

**JANET A. BROWN**  
A Notary Public of New Jersey  
My Commission Expires April 28, 2019

[Signature]  
Keith A. Bonchi, Esq., Partner  
(Print name & title of affiant) (Corporate Seal)

\*\*Pursuant to Section 2 of Ordinance 08-128, no contributions or solicitation of contributions made prior to the effective date Ordinance 08-128 (September 23, 2008) shall be deemed to be a violation of the Ordinance.

**BUSINESS ENTITY DISCLOSURE CERTIFICATION  
FOR NON-PAID AND OPEN CONTRACTS  
Required Pursuant To N.J.S.A. 19:44A-20.8  
CITY OF JERSEY CITY**

**Part I - Vendor Affirmation**

The undersigned, being authorized and knowledgeable of the circumstances, does hereby certify that the <name of business entity> has not made and will not make any reportable contributions pursuant to N.J.S.A. 19:44A-1 et seq. that, pursuant to P.L. 2004, c. 19 would bar the award of this contract in the one year period preceding (date of award scheduled for approval of the contract by the governing body) to any of the following named candidate committee, joint candidates committee, or political party committee representing the elected officials of the <name of entity of elected officials> as defined pursuant to N.J.S.A. 19:44A-3(p), (q) and (r).

Steven Fulop for Mayor 2017	Mira Prinz Arzy for Council
Lavotto for Councilman	Friends of Richard Boggiano
Friends of Joyce Watterman	Michael Yun for Council
Friends of Daniel Rivera	Solomon for Council
Ridley for Council	Friends of Jermaine Robinson

**Part II - Ownership Disclosure Certification**

I certify that the list below contains the names and home addresses of all owners holding 10% or more of the issued and outstanding stock of the undersigned.

Check the box that represents the type of business entity:

- Partnership    
 Prof. Corporation    
 Sole Proprietorship    
 Subchapter S Corporation  
 Limited Partnership    
 Limited Liability Corporation    
 Limited Liability Partnership

Name of Stock or Shareholder	Home Address
Kenneth D. Mackler	412 N. Douglass Ave., Margate, NJ 08402
Joseph Bran Sayegh	20 N. Nassau Ave., Margate, NJ 08402
Lawrence A. Mintz	211 Schoolhouse Dr., Linwood, NJ 08221
Mark Pfeffer	604 Zion Road, Egg Harbor Twp., NJ 08234
Keith A. Bonchi	2027 Cedarbridge Road, Northfield, NJ 08225
Michael A. Gill	306 Steven Drive, Linwood, NJ 08221
Michael J. Mackler	18 Harbour Lane, Margate, NJ 08402
Joel M. Chipkin	7802 Marshall Ave., Margate, NJ 08402
Francis J. Ballak	13 Tansgate Blvd., Berlin, NJ 08009
Daniel G. Tracy	60 La Costa Drive, Egg Harbor Twp., NJ 08234

**Part 3 - Signature and Attestation:**

The undersigned is fully aware that if I have misrepresented in whole or part this affirmation and certification, I and/or the business entity, will be liable for any penalty permitted under law.

Name of Business Entity: Goldenberg, Mackler, Sayegh, Mintz, Pfeffer, Bonchi & Gill

Signature of Affiant: [Signature] Title: Partner

Printed Name of Affiant: Keith A. Bonchi, Esq. Date: 10/12/18

Subscribed and sworn before me this 12<sup>th</sup> day of

October, 2018.

JANET A. BROWN

A Notary Public of New Jersey

My Commission expires: My Commission Expires April 28, 2019

[Signature]  
(Witnessed or attested by)

(Seal)





## STATE OF NEW JERSEY BUSINESS REGISTRATION CERTIFICATE

<b>Taxpayer Name:</b>	GOLDENBERG, MACKLER & SAYEGH, PROFESSIONAL ASSOCIATION
<b>Trade Name:</b>	PROFESSIONAL ASSOCIATION
<b>Address:</b>	1030 ATLANTIC AVE ATLANTIC CITY, NJ 08401-7427
<b>Certificate Number:</b>	0115867
<b>Effective Date:</b>	May 02, 2002
<b>Date of Issuance:</b>	October 19, 2015

**For Office Use Only:**  
20151019131436562

Certification 14694

# CERTIFICATE OF EMPLOYEE INFORMATION REPORT

## RENEWAL

This is to certify that the contractor listed below has submitted an Employee Information Report pursuant to N.J.A.C. 17:27-1.1 et. seq. and the State Treasurer has approved said report. This approval will remain in effect for the period of 15-001-2017 to 15-001-2020

GOLDENBERG, MACKLER, SAYEGH, P.A.  
1030 ATLANTIC AVE.  
ATLANTIC CITY NJ 08409

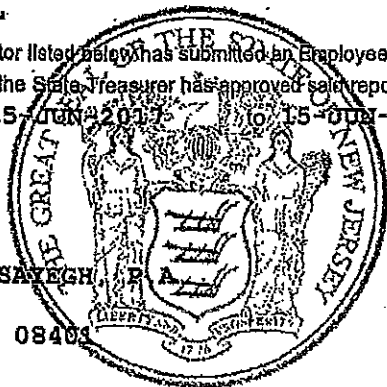

*Ford M. Scudder*

FORD M. SCUDDER  
State Treasurer

## Outside Counsel Agreement

This Agreement dated the \_\_\_\_ day of \_\_\_\_\_, 2018 between the City of Jersey City, a municipal corporation, with offices at 280 Grove Street, Jersey City, New Jersey 07302 ("City") and, **Goldenberg, Mackler, Sayegh, Mintz, Pfeffer, Bonchi & Gill, PC**, 660 New Road, Suite 1A, Northfield, New Jersey 08225("Special Counsel"). The Corporation Counsel of the City of Jersey City has selected Special Counsel to serve as Outside Counsel in connection with the matter *City of Jersey City v. Jean Gaskins*

In consideration of the mutual promises and covenants set forth herein, the parties agree as follows:

### I. CONFLICTS OF INTEREST

#### **A. Initial Conflicts Check.**

Outside Counsel must be sensitive both to direct conflicts of interest that representation of the City and other clients poses, and to the less direct, but nevertheless serious, conflicts that may arise from the same firm's advocacy, on behalf of other clients, of positions conflicting with important City interests. Prior to Outside Counsel's engagement, Outside Counsel shall carefully review whether any conflicts of either type exist and, if so, bring those conflicts to the attention of the Corporation Counsel. The City shall be promptly informed of and consulted with respect to all potential conflicts. Although issue conflicts may not necessarily result in a disqualification of Outside Counsel, the City shall be consulted before Outside Counsel accepts an engagement that will require the firm to advocate a position that may be adverse to a City legal interest or otherwise prejudicial to the interests of the City. The City in its sole discretion shall, after consultation with Outside Counsel, determine whether an impermissible conflict exists, or whether other circumstances exist that would undermine the public's confidence if representation by Outside Counsel continued.

Outside Counsel's acceptance of an engagement on a matter without written disclosure of any conflicts constitutes Outside Counsel's representation that it has conducted an appropriate conflict check and no conflict exists.

#### **B. City Conflicts.**

The City has a duty to protect the public interest. As part of this responsibility, the City sets policies to ensure that the legal system operates in a manner that safeguards the public's confidence in the integrity and impartiality of its administration. For this reason, in addition to



insisting that its attorneys follow the Rules of Professional Conduct, the City prohibits Outside Counsel that represent the City, while such matter is pending, from:

- (1) Representing private parties before the City or any of its boards, proceedings, commissions or autonomous agencies in adversarial, transactional or non-adversarial proceedings. Outside Counsel also may not, on behalf of a private client, lobby the City or any City department.
- (2) Representing private parties in any matter in which the City also is a party, if the private party has interests adverse to the City.
- (3) Representing a private client with interests adverse to the City.
- (4) Representing another client if that representation would present a substantial risk that Outside Counsel's responsibilities to the City would limit its ability to provide independent advice or diligent and competent representation either to the City or the other client.
- (5) Representing another client where the Outside Counsel's knowledge of the City's legal positions or strategy, derived from its representation or prospective representation of the City, could be used to the advantage of the other client or the disadvantage of the City.

**C. Continuing Obligation.**

The obligation to disclose conflicts continues throughout the course of the representation. Outside Counsel must review conflicts of interest on an ongoing basis as new matters are opened. Any new attorney/client relationships that potentially create a conflict shall be reported to the Corporation Counsel immediately.

**D. Attorney-Client Privilege Group/No Representation of Other Persons/Entities Absent Approval.**

Outside attorneys engaged to represent the City (as opposed to a named person) shall consider themselves to have formed an attorney-client relationship *only* with the City, and not any of its individual employees. When speaking with current or former employees of the City, Outside Counsel shall, as appropriate, advise those employees that although their dialogue will be considered attorney-client communications to the fullest possible extent, counsel's responsibility is to the City and they do not represent those employees in their individual capacities. As a matter proceeds, if employees of the City will be examined under oath or interviewed in other adverse contexts, and if Outside Counsel believe it advisable for them to represent the employees in their individual capacities at such events, Outside Counsel must obtain the Corporation Counsel's advance consent before agreeing to represent such persons in their individual capacities. The Corporation Counsel, in consultation with other City personnel, will determine if it is appropriate for the individual to receive representation and, if so, by whom.

Outside Counsel who are engaged to represent both an entity and employees of that entity simultaneously shall take all necessary steps to ensure the continuing absence of conflicts, and to preserve their ability to continue representing the entity in the event that conflicts develop between the entity and individual clients.

## **II. WORKING RELATIONSHIP**

### **A. Identification of Objectives/Relationship Attorney.**

The Corporation Counsel or his designee will be Outside Counsel's principal and regular point of contact for financial and strategic decisions. Only the Corporation Counsel or his designee has authority to direct Outside Counsel in the handling of the matter. If a City employee other than the Corporation Counsel or his designee asks Outside Counsel to proceed in a certain fashion or to perform certain activities with respect to a specific legal matter, Outside Counsel shall report the request to the Corporation Counsel and obtain direction prior to proceeding.

Outside counsel shall designate an Attorney to be the Corporation Counsel's principal contact. In all matters, the City remains ultimately responsible for making all substantive decisions and determining the costs and benefits of contemplated legal activity. In many matters, City attorneys will act as full co-counsel and be engaged with Outside Counsel in the day-to-day conduct of the case. In matters where Outside Counsel is handling that day-to-day conduct without City personnel as co-counsel, the City shall be consulted on a regular basis throughout the course of Outside Counsel's engagement and to be kept fully informed of the current status and proposed course of the matters assigned to Outside Counsel's firm. All strategic, tactical, staffing (including any proposed staffing changes) and significant resource allocation decisions about City legal matters must be made in collaboration with the Corporation Counsel.

### **B. Early Case Assessment/Cost Assessment.**

Each complex matter is to be thoroughly evaluated at its outset. The same applies to actions in which the City is the plaintiff, except that the analysis will be performed before the case is filed. In any matter, Outside Counsel shall provide an early case assessment that includes analysis of (1) likely costs to the City from the process, (2) possible outcomes, indicating the likelihood of each, and (3) strategy and tactics for termination or resolution. The format of the early case assessment may vary from a formal written document to a verbal briefing or a combination of a written budget with a verbal briefing on other aspects of the case.

Please note that time spent preparing a budget is not billable, but counsel may bill for time spent preparing an early case assessment or a recommended discovery plan.

The City places significant reliance on cost estimates and Outside Counsel shall prepare them with care. Although the City understands that unanticipated events may have an impact on costs, the City shall be consulted promptly if Outside Counsel believes that the most recent cost estimate provided is no longer accurate. Should total fees or costs exceed the agreed budget, or should fees or costs for a phase of the case exceed the agreed estimate for that phase, without adequate explanation in advance that the increased expense will be necessary, the City may require that an increased discount be applied to unanticipated fees or costs and reserves the right not to pay Outside Counsel for any amounts incurred or expended in excess of the approved budget or estimate.

For bond matters and other transactional engagements, counsel may be expected to provide a fee cap for the transaction, approved by the City, prior to commencing work. Only where a transaction materially changes in scope will the City consider revisions to an agreed fee cap. No payments above the agreed fee cap shall be made unless and until a revised fee cap has been approved in writing by the Director of the City or his/her designee.

**C. Staffing.**

Unless otherwise agreed, the senior attorney retained shall be directly and ultimately responsible for the entire assignment. The day-to-day involvement of that senior attorney, however, shall be appropriate to the magnitude of the matter and the efficiency required for a timely, cost effective, quality work product. When a senior attorney can handle an assignment most efficiently (based on skill and experience), that senior attorney shall complete the assignment.

The City shall be billed for only one attorney to attend events such as depositions, witness meetings, settlement conferences, negotiations and meetings with other parties' counsel. The City recognizes that in more complex matters and those with multiple work-streams, it may occasionally be appropriate for multiple attorneys to attend significant events and for members of the team to consult with each other. The City insists, however, that no more than the minimum number of attorneys necessary to an event attend, that billable internal conferences and charges for drafting and reading internal email correspondence occur only when absolutely required, and that the Corporation Counsel be regularly informed both of the number of attorneys who will attend significant events and the reason for the attendance of each billing timekeeper.

The City believes that it is most efficient for a single attorney or group of attorneys to handle a matter from beginning to end and Outside Counsel shall strive for such continuity. The City will not pay for learning time that may result from staffing changes at Outside Counsel's firm. In addition, the City will not reimburse Outside Counsel for any routine training or supervisory time, including time spent at seminars, unless specifically approved in advance and included as part of the budget. The City will not ordinarily pay for summer associate time unless such time has been identified as part of the approved staffing plan for appropriate work. The City will not pay for time submitted by librarians; secretaries; billing, filing, docketing or document clerks; internal messengers/couriers; temporary or clerical support staff; word processors; and IT

professionals other than electronic discovery specialists serving a function similar to that of paralegals/case managers. The City also will not pay for time billed by attorneys or paralegals to perform tasks (filing, indexing, etc.) that could and should have been handled by support personnel.

**D. Settlement.**

Outside Counsel shall have no settlement authority unless and until such authority is explicitly conferred on them by the Corporation Counsel. If Outside Counsel believes that settlement should be pursued, Outside Counsel must seek instructions in this regard from the Corporation Counsel, and not pursue formal or informal settlement discussions without the Corporation Counsel's approval. Outside Counsel shall immediately inform the Corporation Counsel of any settlement proposal or overture, formal or informal, by the opposing party or counsel. Please note that under no circumstances can the City agree to designate a settlement agreement as confidential. All City settlement records are, by definition, public documents.

**E. Media Relations/Law Firm Advertising.**

**The City does not authorize outside counsel or vendors to comment publicly in any manner on any aspect of the City's legal matters.** All media inquiries relating to the City shall be referred promptly to the Corporation Counsel and discussed with the Corporation Counsel before responding to the media contact in any manner. This includes even "no comment" or other non-substantive responses. If time is of the essence and Outside Counsel cannot reach the Corporation Counsel, the Press Secretary in the Office of the Mayor shall be contacted.

The City does not permit Outside Counsel to advertise or promote their relationship with the City, other than by listing the City as a representative client.

**F. Engagement of E-Discovery and Other Vendors, Including Experts.**

Before engaging any vendor, including electronic discovery firms and experts, lobbyists or other consultants (in each case, a "vendor"), Outside Counsel must pre-clear that engagement with the Corporation Counsel, unless the Corporation Counsel has explicitly granted exceptions to this preclearance requirement. The City will not be responsible for vendor fees or costs unless that vendor's engagement was pre-approved by the City. The City may require Outside Counsel to engage vendors with which the City has master contracts or preferred pricing arrangements, and always will insist on engagement of the lowest-cost vendor qualified to handle a task (understanding that complex tasks may require vendors with specialized expertise).

Outside Counsel will pay all third-party service providers directly and will bill the City for those services' detailed disbursements included in monthly invoices. This City will not accept separate invoices from service providers directly to the City for payment.

Outside Counsel has the responsibility to ensure that there are no conflicts between any vendor and the City. In addition, all vendors must execute the confidentiality agreement attached as Appendix A. The fee and disbursement policies as outlined in this Agreement shall be made available to, and followed by vendors. It is Outside Counsel's responsibility to confirm that all third party billings comply with this Agreement.

Vendor payment arrangements shall be discussed in advance with the Corporation Counsel. In general, Outside Counsel shall contract with vendors themselves and pay the third party invoices directly, incorporating those invoices into their own bills to the City and including appropriate detail for reasonable review by City personnel. The City may request Outside Counsel to provide full copies of vendor invoices; Outside Counsel therefore shall retain those invoices in accordance with IRS guidelines. The Corporation Counsel may approve other payment arrangements, including (in rare cases) direct contracting with and payment by the City.

When engaging court reporting services, Outside Counsel shall request only one transcript (electronic or hard copy). The City will not reimburse charges for additional transcripts.

**G. Adherence to Ethical Standards.**

The City conducts itself in accordance with the highest ethical standards and expects the same of its Outside Counsel. No City employee ever has authority to instruct Outside Counsel to act in an unethical manner. If Outside Counsel believes that a City employee has engaged or will engage in illegal or unethical activity, Outside Counsel must immediately advise the Corporation Counsel. The City will terminate its relationship with any Outside Counsel who, in the City's sole discretion, fails to adhere to the foregoing ethical standards.

At all times, Outside Counsel will remain aware of and in compliance with each of the City's "Pay-to-Play" ordinances and any amendments thereto.

**H. Gratuities.**

City officers and employees are prohibited from accepting any gift, favor, service or other thing of value related in any way to the City officer's or employee's public duties. In addition, any vendor to the City is prohibited from offering a gift or other thing of value to a City officer or employee with which the vendor transacts business or offers to transact business. Any City officer or employee is prohibited from soliciting a gift or thing of value from a City vendor. This includes charitable donations made in the name of a City employee.

The City reserves the right to amend this Agreement from time to time, providing written notification to Outside Counsel within thirty (30) days of the effective date of any substantive changes. Failure to accept amendments may result in the termination of services from the City.

**I. Malpractice Insurance.**

Outside Counsel representing the City shall maintain malpractice insurance coverage that is reasonable and prudent in relation to the types and sizes of matters handled. Outside Counsel shall, upon request, promptly provide the Corporation Counsel with copies of any applicable policies required under this section, and/or a certificate of insurance. Each policy provided must be certified by the agent or underwriter to be a true copy. If Outside Counsel does not have coverage or if coverage is cancelled and not immediately replaced with comparable coverage, Outside Counsel must immediately report this to the Corporation Counsel.

**J. File Retention.**

For Litigated Matters: Outside Counsel shall retain pleadings, correspondence, discovery materials, deposition transcripts and similar documents and work product for a period of no less than seven (7) years from the date the matter is concluded or for the time period specified by rule or law in the jurisdiction in which the matter was pending, whichever is longer. Beyond this period, Outside Counsel shall notify the City in writing no less than sixty (60) days prior to destroying any file. Along with the written notification, Outside Counsel shall submit an inventory of any original City documents contained in the file to be destroyed and a representation that any electronic version of the file will also be destroyed or deleted.

For Bond and Other Transactions, and Advice Matters: Documents shall be retained in accordance with the same policies applicable to litigated matters unless applicable law mandates any longer retention schedule. However, bond counsel and transactional/advice counsel shall retain all transcripts of transactions and memoranda of advice indefinitely unless otherwise directed by the Corporation Counsel.

**III. Billing**

**A. Rates.**

Outside Counsel shall be compensated at the rate of \$150.00 per hour, including expenses. The total amount of this agreement shall not exceed \$7,500.00

The City will pay for actual services rendered at rates established in Requests for Qualifications or otherwise agreed to in advance. At the time of Outside Counsel's initial engagement, Outside Counsel shall furnish the Corporation Counsel with a schedule of billing rates for partners, associates and all other timekeepers expected to bill time against the matter for review and approval prior to billing time to the City. Because of City procurement rules, the rates applicable at the inception of each specific matter must remain in effect for the duration of that matter.

Hourly rates shall include all overhead costs (*see* Acceptable Fees/Charges, below), none of which shall be included in disbursements.

Time must be billed in 0.1 hour increments and on a per-task basis. The time entry description must be specific, detailing the action taken and the subject matter. Absent prior consent, the City will not pay for more than ten (10) hours of time by a single timekeeper in a single day, but the Corporation Counsel may increase that number of permissible hours in matters of special urgency or where cases are in or approaching trial.

Outside Counsel shall bear in mind that invoices may be disclosed pursuant to the City's open records laws and that courts may not sustain assertions of privilege by the City. Although the City will endeavor to redact privileged information before releasing bills for public consumption, Outside Counsel shall, to the extent practicable and consistent with the need to fully inform the City of its activities and to allow the City to evaluate the reasonableness of billing narratives, avoid the inclusion of privileged matter in invoices.

**B. Invoicing Policy.**

All invoices must be submitted to the Corporation Counsel.

For litigation, advice, and non-bond transactional matters, Outside Counsel generally are expected to submit monthly invoices within thirty days of the conclusion of the billing period, absent the City's prior consent to a longer delay. All charges must reflect the work performed within the billing period or a reasonable time before the billing period. Absent good cause, as defined by the City, the City will not pay for services or expenses incurred more than 90 days prior to the date the invoice is submitted. For bond matters, Outside Counsel are expected to submit their invoice within thirty days of the conclusion of the transaction.

Absent a specific agreement to an alternative fee arrangement, Outside Counsel fees shall be computed by applying the negotiated hourly rate to the time for the services expended. Hours shown must accurately reflect the time spent on the described activity and must either be the exact amount of time or the exact time rounded down to the nearest one-tenth of an hour. Block billing—grouping multiple activities under a single time charge—will not be accepted, and the City will not pay for any time recorded in a block fashion unless this requirement is waived by the Director of the City of Law or his or her designee.

Every bill from Outside Counsel is deemed to be a certification by the firm and billing partner that all legal services and disbursements reflected on the bill are reasonable for the legal matter involved and necessary for the proper provision of legal services to the City. The City may deduct certain fees and charges that are inconsistent with this Agreement.

The City reserves the right to audit all fee and disbursement details that Outside Counsel submit, as well as the corresponding legal file. The City will promptly terminate the services of any

Outside Counsel whose billing practices raise questions about the Outside Counsel's integrity, honesty or compliance with the applicable rules of professional conduct or this Agreement.

**C. Invoice Format.**

Each invoice will include the following minimum requirements:

- Unique invoice number
- Invoice date
- Matter name
- Outside Counsel's matter number
- Date(s) services were performed
- Timekeeper name or ID
- Timekeeper title or level
- A narrative description of the services provided or tasks performed for each specific task. The description shall clearly state the nature of the task performed sufficient to allow the City to determine why it was necessary. Incomplete or vague charge descriptions are unacceptable. Examples of incomplete or vague charges include, but are not limited to: 'analysis', 'review file,' 'conference', 'attention to matter'; 'worked on discovery', 'work on file', 'prepare for meeting', 'misc.', and 'other'
- Time entry to the nearest tenth (.10) of an hour
- Timekeeper rate
- Charge total
- Detail of reimbursable expenses and disbursements at actual cost

The detailed billing report from Outside Counsel's system will provide this information. If Outside Counsel provides services on more than one matter during a billing period, a separate invoice for each matter is required.

**D. Acceptable Fees/Charges.**

**Overhead charges may not be billed.** The City will not reimburse Outside Counsel for basic support services, which the City deems to be part of Outside Counsel's overhead and built into its rates. The City will not pay for any of the following items under any circumstances:

- Billing inquiries
- Opening and closing files
- Internal filing
- Secretarial services (including overtime charges)
- Word processing or proofreading
- Maintenance of a calendar or tickler system
- Investigating potential conflicts
- Preparing budgets



- Library usage (including book purchases or subscriptions) or library staff time
- Office supplies
- Conference room charges

**E. Basic legal research may not be billed.**

Outside Counsel shall be familiar with the basic substantive law at issue in the matter for which the firm was retained, and the City shall not be charged for this type of research. If legal research benefits other clients, only the proportionate share of that cost shall be billed to the City. The City shall also benefit from previously prepared briefs and memoranda, and when such briefs or memoranda exist, will pay only for actual time spent updating or tailoring the same. All other anticipated legal research shall be addressed in Outside Counsel's proposed budget. Legal research projects necessary in a particular litigation assignment must be approved in advance by the Corporation Counsel before the research is commenced.

The City will pay only for the actual time spent by Outside Counsel or other approved timekeeper conducting the research. As explained *infra*, fees charged by electronic or other research services, including library fees, Westlaw, Lexis and other online services are considered general overhead and are not reimbursable.

**F. Out-of-pocket costs must be itemized and passed through with no markup.**

The City will reimburse Outside Counsel for reasonable, documented and itemized out-of-pocket disbursements and costs incurred on behalf of the City, with the exceptions and limitations set forth in this Agreement. Outside Counsel's invoices to the City shall reflect the actual cost and shall not include any markup. All disbursements must be fully itemized with a description sufficient for review, identifying the number of units, price per unit and total cost. The City may refuse to pay for disbursements billed as 'miscellaneous,' billed in a group (e.g., Travel Expenses - \$4,000.00) or disbursements without descriptions.

**G. Prohibited disbursements.**

The City considers certain disbursements to be part of a law firm's overhead and will not pay such charges. These items include:

- Rent (including temporary office space)
- Westlaw, Lexis and other legal database services
- Cost or usage of computers or mobile devices or internet service charges
- Equipment rental
- Storage charges
- Catering for internal meetings
- Meals (except during business travel, and then limited to \$70 per day)
- Mileage for short trips (<30 miles one way)

- Travel costs exceeding discounted, non-refundable coach fares except where excess costs have been approved in advance
- Telephone charges
- Facsimile charges
- Allocated charges from a firm's blanket service agreements with outside vendors

**H. Copying/scanning.**

Copying charges may be billed to the City at the lesser of the most favorable rate applied by Outside Counsel or five cents per page. The City will reimburse for document scanning at Outside Counsel firm's regular rate, up to a maximum of five cents per page, for document productions, but the City will not pay time charges associated with scanning, and there shall be no charges associated with the scanning and filing of court papers and correspondence. Every effort shall be made to minimize scanning expenses by working with documents in electronic format whenever possible.

**I. Couriers and Overnight Mail.**

The City will reimburse for actual charges billed to Outside Counsel for deliveries (including overnight express) that are necessary in the interest of speed and reliability. Outside Counsel shall use the lowest cost service consistent with need and reliability, and to arrange schedules, whenever practicable, to avoid the need for premium-priced couriers. Outside Counsel shall use less expensive means, such as email (encrypted, when necessary) or regular mail where it is practical to do so.

**J. Travel Expenses.**

All air and rail travel must be first approved by the Corporation Counsel, ideally as part of the case budget. Outside Counsel shall use good judgment in selecting hotels and restaurants and incurring expenses for which the taxpayers are to be charged. Outside Counsel shall use alternatives to travel such as conference calls or videoconferences whenever practicable. If the travel involves another client, the City may be billed only for its proportionate share of both time and related expenses. **Non-working travel time is not billable without the Corporation Counsel's prior approval.**

**K. Reimbursement of Meals for Overnight Travel.**

The City will reimburse for meals consumed while traveling overnight on City business, but limited (absent prior approval) to no more than seventy dollars (\$70) per person, per day. Under no circumstances will the City reimburse costs for alcoholic beverages.

**L. Maintenance of Expense Records.**

To ensure compliance with the City's reimbursement policies, Outside Counsel shall require itemization of out-of-pocket expenses such as airline tickets, meals and hotel bills before making reimbursement to any attorney, employee or third party, and maintain original receipts. Travel and meal expenses and receipts may be audited and shall be retained by Outside Counsel in accordance with applicable IRS guidelines. Unless requested to do so by the City, Outside Counsel shall not forward copies of travel and meal expense receipts to the City with the firm's invoices.

**M. Personal Expenses Not Reimbursable.**

Please take care to distinguish between personal expenses and properly chargeable business expenses. The City will not reimburse for, among other things, recreation fees, salon or spa charges, pay-per-view movies or other personal entertainment charges, airline baggage charges, travel agency expenses, shoe shines, toiletries, dry cleaning or laundry (except in the unlikely event travel of more than seven days' duration is required), or luggage.

**N. Vendor discounts must be passed through.**

If Outside Counsel receives a discount or rebate from a vendor based on the aggregate level of business with that vendor, such discount shall be disclosed and the City shall receive the benefit on a proportionate basis. This does not include frequent-flyer miles or similar perquisites allocated to individual travelers.

**IV. COMPLIANCE WITH AFFIRMATIVE ACTION PLAN**

(a) If the Agreement exceeds \$40,000.00, it shall be subject to the Affirmative Action Amendments to the Law Against Discrimination, N.J.S.A. 10:5-31 et seq.

(b) This Agreement shall not become effective and Contractor shall provide no services under this Agreement until it has executed the following documents:

1. A supplemental Affirmative Action Agreement pursuant to N.J.S.A. 10:5-31 et seq. (for contracts which exceed \$40,000.00). The Affirmative Action Agreement is attached hereto as Exhibit "B" and is incorporated herein by reference.

2. An Affirmative Action Employee Information Report (form AA-302) (for contracts which exceed \$40,000.00).

**V. CITY OF JERSEY CITY LOBBYIST DISCLOSURE ORDINANCE**

This contract was awarded in accordance with the provisions of the City's Disclosure of Lobbyist Representative Status Ordinance §3-9.1 et seq. adopted on June 12, 2002. As such the

undersigned does hereby attest that Contractor either did not retain the services of a lobbyist to lobby on behalf of the Contractor for the award of this contract, or if a lobbyist was retained by the Contractor for such purposes, the Contractor's lobbyist, prior to commencing his/her lobbying activities, filed a notice of lobbyist representative status form with the City Clerk. Any Contractor whose lobbyist failed to comply with the provisions of Ordinance §3-9.1 et seq., following notice and an opportunity to be heard, shall be disqualified from entering into contracts with the City for a period of two (2) years for each violation.

## **VI. CONFIDENTIALITY**

In the course of representing the City, Outside Counsel will frequently gain access to nonpublic and confidential information. The City requires Outside Counsel to maintain the confidentiality of such information both during and after the course of Outside Counsel's representation of the City. Outside Counsel must have in place appropriate procedures to ensure the protection of all such information. In the event the representation requires Outside Counsel to become privy to protected personally-identifiable information about any person, such as health or financial records, Social Security numbers or other such information, then this information must be handled with the utmost care both within facilities in Outside Counsel's control, and certainly when that information is being transported. Under no circumstances shall such confidential information be transported outside Outside Counsel's offices--either physically or over the public internet--unless the information is appropriately encrypted. In the event information is compromised or potentially compromised, Outside Counsel must notify the City immediately.

Outside Counsel must follow all statutory, regulatory, and ethical provisions relating to privacy, confidentiality and nondisclosure of all privileged, proprietary and confidential information. Outside Counsel must take appropriate measures to ensure that all legal and nonlegal personnel are familiar with this requirement and are effectively supervised in this regard.

Vendors to whom Outside Counsel gives access to confidential or proprietary material of the City (including work product) must sign the confidentiality agreement attached as Appendix A. It is the responsibility of Outside Counsel to obtain a signed confidentiality agreement from each vendor and to retain those agreements.

This Confidentiality Section, and the corresponding Confidentiality Agreement attached as Appendix A, is above and beyond any relationships or privileges held or created separate and apart from this Agreement.

## **VII. NEW JERSEY BUSINESS REGISTRATION REQUIREMENTS**

Outside Counsel shall provide written notice to its subcontractors of the responsibility to submit proof of business registration to the contractor.

Before final payment on the contract is made by the contracting agency, the contractor shall submit an accurate list and the proof of business registration of each subcontractor or supplier used in the fulfillment of the contract, or shall attest that no subcontractors were used.

For the term of the contract, the contractor and each of its affiliates and a subcontractor and each of its affiliates [N.J.S.A. 52:32-44(g)(3)] shall collect and remit to the Director, New Jersey Division of Taxation, the use tax due pursuant to the Sales and Use Tax Act on all sales of tangible personal property delivered into this State, regardless of whether the tangible personal property is intended for a contract with a contracting agency.

A business organization that fails to provide a copy of a business registration as required pursuant to section 1 of P.L.2001, c.134 (C.52:32-44 et al.) or subsection e. or f. of section 92 of P.L.1977, c.110 (C.5:12-92), or that provides false business registration information under the requirements of either of those sections, shall be liable for a penalty of \$25 for each day of violation, not to exceed \$50,000 for each business registration copy not properly provided under a contract with a contracting agency.

#### **VIII. CITY OF JERSEY CITY CONTRACTOR PAY-TO-PLAY REFORM ORDINANCE**

The contract is awarded in accordance with the City of Jersey City's Contractor Pay-to-Play Reform Ordinance 08-128 adopted on September 23, 2008. The Contractor, its subsidiaries, assigns or principals have certified that they have neither made a reportable contribution in the one year period preceding the date that the City Council awarded the contract that would be deemed to be a violation of Ordinance 08-128, nor will Contractor, its subsidiaries, assigns or principals make a reportable contribution during the term of the contract that would be in violation of Ordinance 08-128.

#### **IX. TERMINATION**

The City reserves the right to terminate the within Agreement at any time for any reason whatsoever, in which event Outside Counsel shall be paid for services due up to the date of termination. Thereafter, this Agreement shall be considered null and void with no further rights or obligations emanating therefrom. Unless sooner terminated or renewed, this contract shall be for a term of one (1) year commencing on the date the contract is executed by City officials.

#### **X. GENERAL TERMS**

##### **A. Governing Law/Jurisdiction.**

This Agreement will be interpreted in accordance with, and governed by, the laws of the State of New Jersey. The courts of the State of New Jersey will have exclusive jurisdiction and the parties irrevocably attorney to the jurisdiction of such courts.

**B. Counterparts Clause.**

This Agreement may be executed by e-mail in counterparts all of which will be deemed originals and legally binding once delivered to each of the other parties' authorized e-mail addresses and such delivery is acknowledged by reply e-mail. Although not necessary to legally bind the parties, each party agrees to promptly circulate signed originals in sufficient number to the other parties for record-keeping purposes after completing the e-mail execution and delivery. All counterparts when executed and delivered (by e-mail or in paper form) will be construed together to be an original and will constitute one and the same agreement.

By accepting an engagement by the City, law firms will be deemed to have familiarized themselves with this agreement and to have agreed to adhere to it in all respects, now and as they may be amended from time to time upon written notice and acceptance. This acceptance is a matter both of contract and professional responsibility.

**Attest:**

**City of Jersey City**

\_\_\_\_\_  
**Robert Byrne**  
**City Clerk**

\_\_\_\_\_  
**Brian D. Platt**  
**Business Administrator**

**WITNESS:**

**Goldenberg, Mackler, Sayegh,  
Mintz, Pfeffer, Bonchi & Gill**

\_\_\_\_\_  
**By:**  
**Firm:**

## APPENDIX A

### CONFIDENTIALITY AGREEMENT

\_\_\_\_\_ (Subcontractor), as a contractor of Outside Counsel retained by the City of Jersey City (the "City") pursuant to an "Outside Counsel Agreement" dated \_\_\_\_\_, hereby acknowledges and agrees as follows:

1. All documents and data, including but not limited to financial, statistical, personnel, customer and/or technical documents, owned or supplied by the City to the Subcontractor, shall be treated as confidential (Documents and Data). The Subcontractor shall take all necessary and reasonable precautions to ensure that the City's Documents and Data are safeguarded. Use of the Documents and Data is strictly limited to that use necessary to complete the scope of work agreed upon, which may include disclosure to employees, officers or agents of any subcontractor assisting with the scope of work. Any other use, and any sale or offering of the Documents and Data in any form by the Subcontractor, or any individual or entity in the Subcontractor's charge or employ, will be considered a violation of this Confidentiality Agreement and may result in termination of the agreement between Subcontractor and the law firm retained by the City, and the Subcontractor's suspension or debarment from City contracting. In addition, such conduct may be reported to the appropriate authorities for possible criminal prosecution.
2. Subcontractor shall be responsible to ensure that all agents and individuals or entities in the Subcontractor's charge or employ adhere to this Confidentiality Agreement. A breach of confidentiality by any individual or entity in the Subcontractor's charge or employ will be considered a violation of this Confidentiality Agreement by the Subcontractor.
3. In the event that Subcontractor, its agent or any individual or entity in the Subcontractor's charge or employ receives a subpoena, demand, or other request for any of the City's documents or data, Subcontractor shall promptly notify the City and shall not turn over any of the City's documents or data.
4. The Subcontractor shall comply with all applicable City and Federal laws that require the notification of individuals in the event of unauthorized release of personally-identifiable information or other event requiring notification. In the event of a breach of any of the Subcontractor's confidentiality obligations or other event requiring notification under applicable law ("Notification Event"), the Subcontractor agrees to assume responsibility for informing all such individuals in accordance with applicable law and to indemnify, hold harmless and defend the City and its trustees, officers, and employees from and against any claims, damages, or other harm related to such Notification Event.
5. Upon termination of this Confidentiality Agreement the Subcontractor shall return or erase, destroy, and render unreadable all Subcontractor copies of City Documents and Data, both physical and electronic, and certify in writing that these actions have been completed within 30 days of the termination of this Confidentiality Agreement or within 14 days of the request of an agent of the City, whichever shall come first.

6. This Confidentiality Agreement shall survive the Subcontractor's termination of the contract between the law firm retained by the City and Subcontractor or upon completion of the scope of work related to the City.

Subcontractor/Firm: \_\_\_\_\_

By: \_\_\_\_\_

Title: \_\_\_\_\_

Date: \_\_\_\_\_



# Resolution of the City of Jersey City, N.J.

City Clerk File No. \_\_\_\_\_ Res. 18-996 \_\_\_\_\_

Agenda No. \_\_\_\_\_ 10.Z.11 \_\_\_\_\_

Approved: \_\_\_\_\_ NOV 07 2018 \_\_\_\_\_

TITLE:



## **RESOLUTION RATIFYING THE AWARD OF A PROFESSIONAL SERVICES AGREEMENT WITH THE LAW OFFICE OF CALCAGNI & KANEFISKY LLP FOR GENERAL LEGAL SERVICES RELATED TO EMPLOYMENT ORGANIZATIONAL PRACTICES**

**COUNCIL**  
resolution:

offered and moved adoption of the following

**WHEREAS**, it has been determined that an independent review of issues raised in employment organizational practices is required; and

**WHEREAS**, the Corporation Counsel has recommended the appointment of outside counsel to handle these matters; and

**WHEREAS**, outside counsel agreed to provide these services at an hourly rate of **\$150.00** per hour, including expenses, for a total amount not to exceed **\$50,000**; and

**WHEREAS**, Calcagni & Kanefsky LLP, 1085 Raymond Blvd., 14<sup>th</sup> Floor, Newark, NJ 07102, are attorneys in the State of New Jersey and are qualified to perform these services; and

**WHEREAS**, N.J.S.A. 19:44A-20-4 et seq. (Pay-to-Play) took effect on January 1, 2006; and

**WHEREAS**, the City is acquiring these services directly and openly as a statutorily permitted contract pursuant to the provision of N.J.S.A. 109:44A-20.5 (Pay-to-Play Law); and

**WHEREAS**, the law firm of Calcagni & Kanefsky LLP has completed and submitted a Business Entity Disclosure Certificate which certified that they have not made any reportable contributions to the political or candidate committees listed in the Business Entity Disclosure Certification in the previous one year, and that the contract will prohibit Calcagni & Kanefsky LLP from making any reportable contributions during the term of the contract; and

**WHEREAS**, Calcagni & Kanefsky LLP has submitted a Chapter 271 Political Contribution Disclosure Certification at least 10 days prior to the award of this contract; and

**WHEREAS**, in addition Calcagni & Kanefsky LLP have signed the Pay-to-Play Certification required by the adoption Ordinance 08-128; and

**WHEREAS**, the resolution reauthorizing the award and the agreement itself much be available for public inspection; and

**WHEREAS**, an encumbrance of \$10,000 is available in **Account No. 18-01-201-20-155-312**.

**NOW, THEREFORE, BE IT RESOLVED** by the Municipal Council of the City of Jersey City that:

1. A contract is awarded to Calcagni & Kanefsky LLP, 1085 Raymond Blvd., 14<sup>th</sup> Floor, Newark, NJ 07102 to review employment organizational practices for a one-year period effective October 1, 2018 for a total amount of **\$50,000**, including expenses.

2. This contract shall be subject to the condition that the vendor provides satisfactory evidence of compliance with the Affirmative Action Amendments to the Law against Discrimination, N.J.S.A. 10:5-31 et seq.

TITLE:

**RESOLUTION RATIFYING THE AWARD OF A PROFESSIONAL SERVICES AGREEMENT WITH THE LAW OFFICE OF CALCAGNI & KANEFSKY LLP FOR GENERAL LEGAL SERVICES RELATED TO EMPLOYMENT ORGANIZATIONAL PRACTICES**

- 3. This contract is awarded without competitive bidding, as a professional services contract under the Local Public Contracts Law, N.J.S.A. 40A:11-1 et seq.
- 4. A copy of the resolution will be published in a newspaper of general circulation in the City of Jersey City as required by law within (10) days of the adoption of the resolution.
- 5. The Mayor or Business Administrator is hereby authorized to execute a contract in substantially the form attached subject to such modification as the Corporation Counsel deems appropriate or necessary.
- 6. The Certification of Compliance with the City's Contractor Pay-To-Play Reform Ordinance attached hereto and incorporated herein by reference shall be placed on file with this resolution.
- 7. Pursuant to N.J.A.C. 5:30-5.5(c), the continuation of the contract after the expenditure of funds encumbered in the 2018 fiscal year budget shall be subject the encumberancy of funds in the 2019 fiscal year budget.

I, Donna Mauer hereby certify that there is sufficient funds to pay this contract in **Account No. 01-201-20-155-312, P.O. No. 131216**

  
\_\_\_\_\_  
Donna Mauer, Chief Financial Officer

10/22/2018  
JMK  
10/26/18

APPROVED: \_\_\_\_\_  
APPROVED:  \_\_\_\_\_  
Business Administrator

APPROVED AS TO LEGAL FORM  
 \_\_\_\_\_  
Corporation Counsel

Certification Required

Not Required

APPROVED 8-0

RECORD OF COUNCIL VOTE ON FINAL PASSAGE 11.7.18											
COUNCILPERSON	AYE	NAY	N.V.	COUNCILPERSON	AYE	NAY	N.V.	COUNCILPERSON	AYE	NAY	N.V.
RIDLEY	✓			YUN	✓			RIVERA	✓		
PRINZ-AREY	✓			SOLOMON	✓			WATTERMAN	ABSENT		
BOGGIANO	✓			ROBINSON	✓			LAVARRO, PRES.	✓		

✓ indicates Vote

N.V.-Not Voting (Abstain)

Adopted at a meeting of the Municipal Council of the City of Jersey City N.J.

  
\_\_\_\_\_  
Rolando R. Lavarro, Jr., President of Council

  
\_\_\_\_\_  
Robert Byrne, City Clerk

**RESOLUTION FACT SHEET - CONTRACT AWARD**

This summary sheet is to be attached to the front of any resolution that is submitted for Council consideration. Incomplete or vague fact sheets will be returned with the resolution.

**Full Title of Ordinance/Resolution**

**RESOLUTION RATIFYING THE AWARD OF A PROFESSIONAL SERVICES AGREEMENT WITH THE LAW OFFICE OF CALCAGNI & KANEFKY LLP FOR GENERAL LEGAL SERVICES RELATED TO EMPLOYMENT ORGANIZATIONAL PRACTICES**

**Project Manager**

Department/Division	Law	Law
Name/Title	Peter Baker	Corporation Counsel
Phone/email	201-547-4667	Pbaker@jcnj.org

Note: Project Manager must be available by phone during agenda meeting (Wednesday prior to council meeting @ 4:00 p.m.)

**Contract Purpose**

As best practice in employment matters, the City needs to retain third-party counsel to review and provide guidance pertaining to employment issues.

**Cost (Identify all sources and amounts)**

Account No. 18-01-201-20-155-312

**Contract term (include all proposed renewals)**

One Year

Type of award

If "Other Exception", enter type

**Additional Information**

I certify that all the facts presented herein are accurate.

  
Signature of Department Director

10/30/18  
Date

## Outside Counsel Agreement

This Agreement dated the \_\_\_\_ day of \_\_\_\_\_, 2018 between the City of Jersey City, a municipal corporation, with offices at 280 Grove Street, Jersey City, New Jersey 07302 ("City") and, Calcagni & Kanefksy LLP, 1085 Raymond Blvd., 14<sup>th</sup> Floor, Newark, NJ 07102 ("Special Counsel"). The Corporation Counsel of the City of Jersey City has selected Special Counsel to serve as Outside Counsel for general legal services related to employment organizational practices.

In consideration of the mutual promises and covenants set forth herein, the parties agree as follows:

### I. CONFLICTS OF INTEREST

#### **A. Initial Conflicts Check.**

Outside Counsel must be sensitive both to direct conflicts of interest that representation of the City and other clients poses, and to the less direct, but nevertheless serious, conflicts that may arise from the same firm's advocacy, on behalf of other clients, of positions conflicting with important City interests. Prior to Outside Counsel's engagement, Outside Counsel shall carefully review whether any conflicts of either type exist and, if so, bring those conflicts to the attention of the Corporation Counsel. The City shall be promptly informed of and consulted with respect to all potential conflicts. Although issue conflicts may not necessarily result in a disqualification of Outside Counsel, the City shall be consulted before Outside Counsel accepts an engagement that will require the firm to advocate a position that may be adverse to a City legal interest or otherwise prejudicial to the interests of the City. The City in its sole discretion shall, after consultation with Outside Counsel, determine whether an impermissible conflict exists, or whether other circumstances exist that would undermine the public's confidence if representation by Outside Counsel continued.

Outside Counsel's acceptance of an engagement on a matter without written disclosure of any conflicts constitutes Outside Counsel's representation that it has conducted an appropriate conflict check and no conflict exists.

#### **B. City Conflicts.**

The City has a duty to protect the public interest. As part of this responsibility, the City sets policies to ensure that the legal system operates in a manner that safeguards the public's confidence in the integrity and impartiality of its administration. For this reason, in addition to

insisting that its attorneys follow the Rules of Professional Conduct, the City prohibits Outside Counsel that represent the City, while such matter is pending, from:

- (1) Representing private parties before the City or any of its boards, proceedings, commissions or autonomous agencies in adversarial, transactional or non-adversarial proceedings. Outside Counsel also may not, on behalf of a private client, lobby the City or any City department.
- (2) Representing private parties in any matter in which the City also is a party, if the private party has interests adverse to the City.
- (3) Representing a private client with interests adverse to the City.
- (4) Representing another client if that representation would present a substantial risk that Outside Counsel's responsibilities to the City would limit its ability to provide independent advice or diligent and competent representation either to the City or the other client.
- (5) Representing another client where the Outside Counsel's knowledge of the City's legal positions or strategy, derived from its representation or prospective representation of the City, could be used to the advantage of the other client or the disadvantage of the City.

**C. Continuing Obligation.**

The obligation to disclose conflicts continues throughout the course of the representation. Outside Counsel must review conflicts of interest on an ongoing basis as new matters are opened. Any new attorney/client relationships that potentially create a conflict shall be reported to the Corporation Counsel immediately.

**D. Attorney-Client Privilege Group/No Representation of Other Persons/Entities Absent Approval.**

Outside attorneys engaged to represent the City (as opposed to a named person) shall consider themselves to have formed an attorney-client relationship *only* with the City, and not any of its individual employees. When speaking with current or former employees of the City, Outside Counsel shall, as appropriate, advise those employees that although their dialogue will be considered attorney-client communications to the fullest possible extent, counsel's responsibility is to the City and they do not represent those employees in their individual capacities. As a matter proceeds, if employees of the City will be examined under oath or interviewed in other adverse contexts, and if Outside Counsel believe it advisable for them to represent the employees in their individual capacities at such events, Outside Counsel must obtain the Corporation Counsel's advance consent before agreeing to represent such persons in their individual capacities. The Corporation Counsel, in consultation with other City personnel, will determine if it is appropriate for the individual to receive representation and, if so, by whom.

Outside Counsel who are engaged to represent both an entity and employees of that entity simultaneously shall take all necessary steps to ensure the continuing absence of conflicts, and to preserve their ability to continue representing the entity in the event that conflicts develop between the entity and individual clients.

## **II. WORKING RELATIONSHIP**

### **A. Identification of Objectives/Relationship Attorney.**

The Corporation Counsel or his designee will be Outside Counsel's principal and regular point of contact for financial and strategic decisions. Only the Corporation Counsel or his designee has authority to direct Outside Counsel in the handling of the matter. If a City employee other than the Corporation Counsel or his designee asks Outside Counsel to proceed in a certain fashion or to perform certain activities with respect to a specific legal matter, Outside Counsel shall report the request to the Corporation Counsel and obtain direction prior to proceeding.

Outside counsel shall designate an Attorney to be the Corporation Counsel's principal contact. In all matters, the City remains ultimately responsible for making all substantive decisions and determining the costs and benefits of contemplated legal activity. In many matters, City attorneys will act as full co-counsel and be engaged with Outside Counsel in the day-to-day conduct of the case. In matters where Outside Counsel is handling that day-to-day conduct without City personnel as co-counsel, the City shall be consulted on a regular basis throughout the course of Outside Counsel's engagement and to be kept fully informed of the current status and proposed course of the matters assigned to Outside Counsel's firm. All strategic, tactical, staffing (including any proposed staffing changes) and significant resource allocation decisions about City legal matters must be made in collaboration with the Corporation Counsel.

### **B. Early Case Assessment/Cost Assessment.**

Each complex matter is to be thoroughly evaluated at its outset. The same applies to actions in which the City is the plaintiff, except that the analysis will be performed before the case is filed. In any matter, Outside Counsel shall provide an early case assessment that includes analysis of (1) likely costs to the City from the process, (2) possible outcomes, indicating the likelihood of each, and (3) strategy and tactics for termination or resolution. The format of the early case assessment may vary from a formal written document to a verbal briefing or a combination of a written budget with a verbal briefing on other aspects of the case.

Please note that time spent preparing a budget is not billable, but counsel may bill for time spent preparing an early case assessment or a recommended discovery plan.

The City places significant reliance on cost estimates and Outside Counsel shall prepare them with care. Although the City understands that unanticipated events may have an impact on costs, the City shall be consulted promptly if Outside Counsel believes that the most recent cost estimate provided is no longer accurate. Should total fees or costs exceed the agreed budget, or should fees or costs for a phase of the case exceed the agreed estimate for that phase, without adequate explanation in advance that the increased expense will be necessary, the City may require that an increased discount be applied to unanticipated fees or costs and reserves the right not to pay Outside Counsel for any amounts incurred or expended in excess of the approved budget or estimate.

For bond matters and other transactional engagements, counsel may be expected to provide a fee cap for the transaction, approved by the City, prior to commencing work. Only where a transaction materially changes in scope will the City consider revisions to an agreed fee cap. No payments above the agreed fee cap shall be made unless and until a revised fee cap has been approved in writing by the Director of the City or his/her designee.

**C. Staffing.**

Unless otherwise agreed, the senior attorney retained shall be directly and ultimately responsible for the entire assignment. The day-to-day involvement of that senior attorney, however, shall be appropriate to the magnitude of the matter and the efficiency required for a timely, cost effective, quality work product. When a senior attorney can handle an assignment most efficiently (based on skill and experience), that senior attorney shall complete the assignment.

The City shall be billed for only one attorney to attend events such as depositions, witness meetings, settlement conferences, negotiations and meetings with other parties' counsel. The City recognizes that in more complex matters and those with multiple work-streams, it may occasionally be appropriate for multiple attorneys to attend significant events and for members of the team to consult with each other. The City insists, however, that no more than the minimum number of attorneys necessary to an event attend, that billable internal conferences and charges for drafting and reading internal email correspondence occur only when absolutely required, and that the Corporation Counsel be regularly informed both of the number of attorneys who will attend significant events and the reason for the attendance of each billing timekeeper.

The City believes that it is most efficient for a single attorney or group of attorneys to handle a matter from beginning to end and Outside Counsel shall strive for such continuity. The City will not pay for learning time that may result from staffing changes at Outside Counsel's firm. In addition, the City will not reimburse Outside Counsel for any routine training or supervisory time, including time spent at seminars, unless specifically approved in advance and included as part of the budget. The City will not ordinarily pay for summer associate time unless such time has been identified as part of the approved staffing plan for appropriate work. The City will not pay for time submitted by librarians; secretaries; billing, filing, docketing or document clerks; internal messengers/couriers; temporary or clerical support staff; word processors; and IT

professionals other than electronic discovery specialists serving a function similar to that of paralegals/case managers. The City also will not pay for time billed by attorneys or paralegals to perform tasks (filing, indexing, etc.) that could and should have been handled by support personnel.

**D. Settlement.**

Outside Counsel shall have no settlement authority unless and until such authority is explicitly conferred on them by the Corporation Counsel. If Outside Counsel believes that settlement should be pursued, Outside Counsel must seek instructions in this regard from the Corporation Counsel, and not pursue formal or informal settlement discussions without the Corporation Counsel's approval. Outside Counsel shall immediately inform the Corporation Counsel of any settlement proposal or overture, formal or informal, by the opposing party or counsel. Please note that under no circumstances can the City agree to designate a settlement agreement as confidential. All City settlement records are, by definition, public documents.

**E. Media Relations/Law Firm Advertising.**

The City does not authorize outside counsel or vendors to comment publicly in any manner on any aspect of the City's legal matters. All media inquiries relating to the City shall be referred promptly to the Corporation Counsel and discussed with the Corporation Counsel before responding to the media contact in any manner. This includes even "no comment" or other non-substantive responses. If time is of the essence and Outside Counsel cannot reach the Corporation Counsel, the Press Secretary in the Office of the Mayor shall be contacted.

The City does not permit Outside Counsel to advertise or promote their relationship with the City, other than by listing the City as a representative client.

**F. Engagement of E-Discovery and Other Vendors, Including Experts.**

Before engaging any vendor, including electronic discovery firms and experts, lobbyists or other consultants (in each case, a "vendor"), Outside Counsel must pre-clear that engagement with the Corporation Counsel, unless the Corporation Counsel has explicitly granted exceptions to this preclearance requirement. The City will not be responsible for vendor fees or costs unless that vendor's engagement was pre-approved by the City. The City may require Outside Counsel to engage vendors with which the City has master contracts or preferred pricing arrangements, and always will insist on engagement of the lowest-cost vendor qualified to handle a task (understanding that complex tasks may require vendors with specialized expertise).

Outside Counsel will pay all third-party service providers directly and will bill the City for those services' detailed disbursements included in monthly invoices. This City will not accept separate invoices from service providers directly to the City for payment.



Outside Counsel has the responsibility to ensure that there are no conflicts between any vendor and the City. In addition, all vendors must execute the confidentiality agreement attached as Appendix A. The fee and disbursement policies as outlined in this Agreement shall be made available to, and followed by vendors. It is Outside Counsel's responsibility to confirm that all third party billings comply with this Agreement.

Vendor payment arrangements shall be discussed in advance with the Corporation Counsel. In general, Outside Counsel shall contract with vendors themselves and pay the third party invoices directly, incorporating those invoices into their own bills to the City and including appropriate detail for reasonable review by City personnel. The City may request Outside Counsel to provide full copies of vendor invoices; Outside Counsel therefore shall retain those invoices in accordance with IRS guidelines. The Corporation Counsel may approve other payment arrangements, including (in rare cases) direct contracting with and payment by the City.

When engaging court reporting services, Outside Counsel shall request only one transcript (electronic or hard copy). The City will not reimburse charges for additional transcripts.

**G. Adherence to Ethical Standards.**

The City conducts itself in accordance with the highest ethical standards and expects the same of its Outside Counsel. No City employee ever has authority to instruct Outside Counsel to act in an unethical manner. If Outside Counsel believes that a City employee has engaged or will engage in illegal or unethical activity, Outside Counsel must immediately advise the Corporation Counsel. The City will terminate its relationship with any Outside Counsel who, in the City's sole discretion, fails to adhere to the foregoing ethical standards.

At all times, Outside Counsel will remain aware of and in compliance with each of the City's "Pay-to-Play" ordinances and any amendments thereto.

**H. Gratuities.**

City officers and employees are prohibited from accepting any gift, favor, service or other thing of value related in any way to the City officer's or employee's public duties. In addition, any vendor to the City is prohibited from offering a gift or other thing of value to a City officer or employee with whom the vendor transacts business or offers to transact business. Any City officer or employee is prohibited from soliciting a gift or thing of value from a City vendor. This includes charitable donations made in the name of a City employee.

The City reserves the right to amend this Agreement from time to time, providing written notification to Outside Counsel within thirty (30) days of the effective date of any substantive changes. Failure to accept amendments may result in the termination of services from the City.

**I. Malpractice Insurance.**

Outside Counsel representing the City shall maintain malpractice insurance coverage that is reasonable and prudent in relation to the types and sizes of matters handled. Outside Counsel shall, upon request, promptly provide the Corporation Counsel with copies of any applicable policies required under this section, and/or a certificate of insurance. Each policy provided must be certified by the agent or underwriter to be a true copy. If Outside Counsel does not have coverage or if coverage is cancelled and not immediately replaced with comparable coverage, Outside Counsel must immediately report this to the Corporation Counsel.

**J. File Retention.**

For Litigated Matters: Outside Counsel shall retain pleadings, correspondence, discovery materials, deposition transcripts and similar documents and work product for a period of no less than seven (7) years from the date the matter is concluded or for the time period specified by rule or law in the jurisdiction in which the matter was pending, whichever is longer. Beyond this period, Outside Counsel shall notify the City in writing no less than sixty (60) days prior to destroying any file. Along with the written notification, Outside Counsel shall submit an inventory of any original City documents contained in the file to be destroyed and a representation that any electronic version of the file will also be destroyed or deleted.

For Bond and Other Transactions, and Advice Matters: Documents shall be retained in accordance with the same policies applicable to litigated matters unless applicable law mandates any longer retention schedule. However, bond counsel and transactional/advice counsel shall retain all transcripts of transactions and memoranda of advice indefinitely unless otherwise directed by the Corporation Counsel.

**III. Billing**

**A. Rates.**

Outside Counsel shall be compensated at the rate of \$150.00 per hour, including expenses. The total amount of this agreement shall not exceed \$50,000.

The City will pay for actual services rendered at rates established in Requests for Qualifications or otherwise agreed to in advance. At the time of Outside Counsel's initial engagement, Outside Counsel shall furnish the Corporation Counsel with a schedule of billing rates for partners, associates and all other timekeepers expected to bill time against the matter for review and approval prior to billing time to the City. Because of City procurement rules, the rates applicable at the inception of each specific matter must remain in effect for the duration of that matter.

Hourly rates shall include all overhead costs (*see* Acceptable Fees/Charges, below), none of which shall be included in disbursements.

Time must be billed in 0.1 hour increments and on a per-task basis. The time entry description must be specific, detailing the action taken and the subject matter. Absent prior consent, the City will not pay for more than ten (10) hours of time by a single timekeeper in a single day, but the Corporation Counsel may increase that number of permissible hours in matters of special urgency or where cases are in or approaching trial.

Outside Counsel shall bear in mind that invoices may be disclosed pursuant to the City's open records laws and that courts may not sustain assertions of privilege by the City. Although the City will endeavor to redact privileged information before releasing bills for public consumption, Outside Counsel shall, to the extent practicable and consistent with the need to fully inform the City of its activities and to allow the City to evaluate the reasonableness of billing narratives, avoid the inclusion of privileged matter in invoices.

**B. Invoicing Policy.**

All invoices must be submitted to the Corporation Counsel.

For litigation, advice, and non-bond transactional matters, Outside Counsel generally are expected to submit monthly invoices within thirty days of the conclusion of the billing period, absent the City's prior consent to a longer delay. All charges must reflect the work performed within the billing period or a reasonable time before the billing period. Absent good cause, as defined by the City, the City will not pay for services or expenses incurred more than 90 days prior to the date the invoice is submitted. For bond matters, Outside Counsel are expected to submit their invoice within thirty days of the conclusion of the transaction.

Absent a specific agreement to an alternative fee arrangement, Outside Counsel fees shall be computed by applying the negotiated hourly rate to the time for the services expended. Hours shown must accurately reflect the time spent on the described activity and must either be the exact amount of time or the exact time rounded down to the nearest one-tenth of an hour. Block billing—grouping multiple activities under a single time charge—will not be accepted, and the City will not pay for any time recorded in a block fashion unless this requirement is waived by the Director of the City of Law or his or her designee.

Every bill from Outside Counsel is deemed to be a certification by the firm and billing partner that all legal services and disbursements reflected on the bill are reasonable for the legal matter involved and necessary for the proper provision of legal services to the City. The City may deduct certain fees and charges that are inconsistent with this Agreement.

The City reserves the right to audit all fee and disbursement details that Outside Counsel submit, as well as the corresponding legal file. The City will promptly terminate the services of any

Outside Counsel who's billing practices raise questions about the Outside Counsel's integrity, honesty or compliance with the applicable rules of professional conduct or this Agreement.

**C. Invoice Format.**

Each invoice will include the following minimum requirements:

- Unique invoice number
- Invoice date
- Matter name
- Outside Counsel's matter number
- Date(s) services were performed
- Timekeeper name or ID
- Timekeeper title or level
- A narrative description of the services provided or tasks performed for each specific task. The description shall clearly state the nature of the task performed sufficient to allow the City to determine why it was necessary. Incomplete or vague charge descriptions are unacceptable. Examples of incomplete or vague charges include, but are not limited to: 'analysis', 'review file', 'conference', 'attention to matter'; 'worked on discovery', 'work on file', 'prepare for meeting', 'misc.', and 'other'
- Time entry to the nearest tenth (.10) of an hour
- Timekeeper rate
- Charge total
- Detail of reimbursable expenses and disbursements at actual cost

The detailed billing report from Outside Counsel's system will provide this information. If Outside Counsel provides services on more than one matter during a billing period, a separate invoice for each matter is required.

**D. Acceptable Fees/Charges.**

**Overhead charges may not be billed.** The City will not reimburse Outside Counsel for basic support services, which the City deems to be part of Outside Counsel's overhead and built into its rates. The City will not pay for any of the following items under any circumstances:

- Billing inquiries
- Opening and closing files
- Internal filing
- Secretarial services (including overtime charges)
- Word processing or proofreading
- Maintenance of a calendar or tickler system
- Investigating potential conflicts
- Preparing budgets

- Library usage (including book purchases or subscriptions) or library staff time
- Office supplies
- Conference room charges

**E. Basic legal research may not be billed.**

Outside Counsel shall be familiar with the basic substantive law at issue in the matter for which the firm was retained, and the City shall not be charged for this type of research. If legal research benefits other clients, only the proportionate share of that cost shall be billed to the City. The City shall also benefit from previously prepared briefs and memoranda, and when such briefs or memoranda exist, will pay only for actual time spent updating or tailoring the same. All other anticipated legal research shall be addressed in Outside Counsel's proposed budget. Legal research projects necessary in a particular litigation assignment must be approved in advance by the Corporation Counsel before the research is commenced.

The City will pay only for the actual time spent by Outside Counsel or other approved timekeeper conducting the research. As explained *infra*, fees charged by electronic or other research services, including library fees, Westlaw, Lexis and other online services are considered general overhead and are not reimbursable.

**F. Out-of-pocket costs must be itemized and passed through with no markup.**

The City will reimburse Outside Counsel for reasonable, documented and itemized out-of-pocket disbursements and costs incurred on behalf of the City, with the exceptions and limitations set forth in this Agreement. Outside Counsel's invoices to the City shall reflect the actual cost and shall not include any markup. All disbursements must be fully itemized with a description sufficient for review, identifying the number of units, price per unit and total cost. The City may refuse to pay for disbursements billed as 'miscellaneous,' billed in a group (e.g., Travel Expenses - \$4,000.00) or disbursements without descriptions.

**G. Prohibited disbursements.**

The City considers certain disbursements to be part of a law firm's overhead and will not pay such charges. These items include:

- Rent (including temporary office space)
- Westlaw, Lexis and other legal database services
- Cost or usage of computers or mobile devices or internet service charges
- Equipment rental
- Storage charges
- Catering for internal meetings
- Meals (except during business travel, and then limited to \$70 per day)
- Mileage for short trips (<30 miles one way)

- Travel costs exceeding discounted, non-refundable coach fares except where excess costs have been approved in advance
- Telephone charges
- Facsimile charges
- Allocated charges from a firm's blanket service agreements with outside vendors

**H. Copying/scanning.**

Copying charges may be billed to the City at the lesser of the most favorable rate applied by Outside Counsel or five cents per page. The City will reimburse for document scanning at Outside Counsel firm's regular rate, up to a maximum of five cents per page, for document productions, but the City will not pay time charges associated with scanning, and there shall be no charges associated with the scanning and filing of court papers and correspondence. Every effort shall be made to minimize scanning expenses by working with documents in electronic format whenever possible.

**I. Couriers and Overnight Mail.**

The City will reimburse for actual charges billed to Outside Counsel for deliveries (including overnight express) that are necessary in the interest of speed and reliability. Outside Counsel shall use the lowest cost service consistent with need and reliability, and to arrange schedules, whenever practicable, to avoid the need for premium-priced couriers. Outside Counsel shall use less expensive means, such as email (encrypted, when necessary) or regular mail where it is practical to do so.

**J. Travel Expenses.**

All air and rail travel must be first approved by the Corporation Counsel, ideally as part of the case budget. Outside Counsel shall use good judgment in selecting hotels and restaurants and incurring expenses for which the taxpayers are to be charged. Outside Counsel shall use alternatives to travel such as conference calls or videoconferences whenever practicable. If the travel involves another client, the City may be billed only for its proportionate share of both time and related expenses. **Non-working travel time is not billable without the Corporation Counsel's prior approval.**

**K. Reimbursement of Meals for Overnight Travel.**

The City will reimburse for meals consumed while traveling overnight on City business, but limited (absent prior approval) to no more than seventy dollars (\$70) per person, per day. Under no circumstances will the City reimburse costs for alcoholic beverages.

**L. Maintenance of Expense Records.**

To ensure compliance with the City's reimbursement policies, Outside Counsel shall require itemization of out-of-pocket expenses such as airline tickets, meals and hotel bills before making reimbursement to any attorney, employee or third party, and maintain original receipts. Travel and meal expenses and receipts may be audited and shall be retained by Outside Counsel in accordance with applicable IRS guidelines. Unless requested to do so by the City, Outside Counsel shall not forward copies of travel and meal expense receipts to the City with the firm's invoices.

**M. Personal Expenses Not Reimbursable.**

Please take care to distinguish between personal expenses and properly chargeable business expenses. The City will not reimburse for, among other things, recreation fees, salon or spa charges, pay-per-view movies or other personal entertainment charges, airline baggage charges, travel agency expenses, shoe shines, toiletries, dry cleaning or laundry (except in the unlikely event travel of more than seven days' duration is required), or luggage.

**N. Vendor discounts must be passed through.**

If Outside Counsel receives a discount or rebate from a vendor based on the aggregate level of business with that vendor, such discount shall be disclosed and the City shall receive the benefit on a proportionate basis. This does not include frequent-flyer miles or similar perquisites allocated to individual travelers.

**IV. COMPLIANCE WITH AFFIRMATIVE ACTION PLAN**

(a) If the Agreement exceeds \$40,000.00, it shall be subject to the Affirmative Action Amendments to the Law against Discrimination, N.J.S.A. 10:5-31 et seq.

(b) This Agreement shall not become effective and Contractor shall provide no services under this Agreement until it has executed the following documents:

1. A supplemental Affirmative Action Agreement pursuant to N.J.S.A. 10:5-31 et seq. (for contracts which exceed \$40,000.00). The Affirmative Action Agreement is attached hereto as Exhibit "B" and is incorporated herein by reference.

2. An Affirmative Action Employee Information Report (form AA-302) (for contracts which exceed \$40,000.00).

## V. CITY OF JERSEY CITY LOBBYIST DISCLOSURE ORDINANCE

This contract was awarded in accordance with the provisions of the City's Disclosure of Lobbyist Representative Status Ordinance §3-9.1 *et seq.* adopted on June 12, 2002. As such the undersigned does hereby attest that Contractor either did not retain the services of a lobbyist to lobby on behalf of the Contractor for the award of this contract, or if a lobbyist was retained by the Contractor for such purposes, the Contractor's lobbyist, prior to commencing his/her lobbying activities, filed a notice of lobbyist representative status form with the City Clerk. Any Contractor whose lobbyist failed to comply with the provisions of Ordinance §3-9.1 *et seq.*, following notice and an opportunity to be heard, shall be disqualified from entering into contracts with the City for a period of two (2) years for each violation.

## VI. CONFIDENTIALITY

In the course of representing the City, Outside Counsel will frequently gain access to nonpublic and confidential information. The City requires Outside Counsel to maintain the confidentiality of such information both during and after the course of Outside Counsel's representation of the City. Outside Counsel must have in place appropriate procedures to ensure the protection of all such information. In the event the representation requires Outside Counsel to become privy to protected personally-identifiable information about any person, such as health or financial records, Social Security numbers or other such information, then this information must be handled with the utmost care both within facilities in Outside Counsel's control, and certainly when that information is being transported. Under no circumstances shall such confidential information be transported outside Counsel's offices--either physically or over the public internet--unless the information is appropriately encrypted. In the event information is compromised or potentially compromised, Outside Counsel must notify the City immediately.

Outside Counsel must follow all statutory, regulatory, and ethical provisions relating to privacy, confidentiality and nondisclosure of all privileged, proprietary and confidential information. Outside Counsel must take appropriate measures to ensure that all legal and non-legal personnel are familiar with this requirement and are effectively supervised in this regard.

Vendors to whom Outside Counsel gives access to confidential or proprietary material of the City (including work product) must sign the confidentiality agreement attached as Appendix A. It is the responsibility of Outside Counsel to obtain a signed confidentiality agreement from each vendor and to retain those agreements.

This Confidentiality Section and the corresponding Confidentiality Agreement attached as Appendix A, is above and beyond any relationships or privileges held or created separate and apart from this Agreement.



## **VII. NEW JERSEY BUSINESS REGISTRATION REQUIREMENTS**

Outside Counsel shall provide written notice to its subcontractors of the responsibility to submit proof of business registration to the contractor.

Before final payment on the contract is made by the contracting agency, the contractor shall submit an accurate list and the proof of business registration of each subcontractor or supplier used in the fulfillment of the contract, or shall attest that no subcontractors were used.

For the term of the contract, the contractor and each of its affiliates and a subcontractor and each of its affiliates [N.J.S.A. 52:32-44(g)(3)] shall collect and remit to the Director, New Jersey Division of Taxation, the use tax due pursuant to the Sales and Use Tax Act on all sales of tangible personal property delivered into this State, regardless of whether the tangible personal property is intended for a contract with a contracting agency.

A business organization that fails to provide a copy of a business registration as required pursuant to section 1 of P.L.2001, c.134 (C.52:32-44 et al.) or subsection e. or f. of section 92 of P.L.1977, c.110 (C.5:12-92), or that provides false business registration information under the requirements of either of those sections, shall be liable for a penalty of \$25 for each day of violation, not to exceed \$50,000 for each business registration copy not properly provided under a contract with a contracting agency.

## **VIII. CITY OF JERSEY CITY CONTRACTOR PAY-TO-PLAY REFORM ORDINANCE**

The contract is awarded in accordance with the City of Jersey City's Contractor Pay-to-Play Reform Ordinance 08-128 adopted on September 23, 2008. The Contractor, its subsidiaries, assigns or principals have certified that they have neither made a reportable contribution in the one year period preceding the date that the City Council awarded the contract that would be deemed to be a violation of Ordinance 08-128, nor will Contractor, its subsidiaries, assigns or principals make a reportable contribution during the term of the contract that would be in violation of Ordinance 08-128.

## **IX. TERMINATION**

The City reserves the right to terminate the within Agreement at any time for any reason whatsoever, in which event Outside Counsel shall be paid for services due up to the date of termination. Thereafter, this Agreement shall be considered null and void with no further rights or obligations emanating therefrom. Unless sooner terminated or renewed, this contract shall be for a term of one (1) year commencing on the date the contract is executed by City officials.

**X. GENERAL TERMS**

**A. Governing Law/Jurisdiction.**

This Agreement will be interpreted in accordance with, and governed by, the laws of the State of New Jersey. The courts of the State of New Jersey will have exclusive jurisdiction and the parties irrevocably attorney to the jurisdiction of such courts.

**B. Counterparts Clause.**

This Agreement may be executed by e-mail in counterparts all of which will be deemed originals and legally binding once delivered to each of the other parties' authorized e-mail addresses and such delivery is acknowledged by reply e-mail. Although not necessary to legally bind the parties, each party agrees to promptly circulate signed originals in sufficient number to the other parties for record-keeping purposes after completing the e-mail execution and delivery. All counterparts when executed and delivered (by e-mail or in paper form) will be construed together to be an original and will constitute one and the same agreement.

By accepting an engagement by the City, law firms will be deemed to have familiarized themselves with this agreement and to have agreed to adhere to it in all respects, now and as they may be amended from time to time upon written notice and acceptance. This acceptance is a matter both of contract and professional responsibility.

**Attest:**

**City of Jersey City**

\_\_\_\_\_  
**Robert Byrne**  
**City Clerk**

\_\_\_\_\_  
**Brian Platt**  
**Business Administrator**

**WITNESS:**

**Calcagni & Kanefksy, LLP**

\_\_\_\_\_  
**By:**  
**Firm:**

## APPENDIX A

### CONFIDENTIALITY AGREEMENT

\_\_\_\_\_ (Subcontractor), as a contractor of Outside Counsel retained by the City of Jersey City (the "City") pursuant to an "Outside Counsel Agreement" dated \_\_\_\_\_, hereby acknowledges and agrees as follows:

1. All documents and data, including but not limited to financial, statistical, personnel, customer and/or technical documents, owned or supplied by the City to the Subcontractor, shall be treated as confidential (Documents and Data). The Subcontractor shall take all necessary and reasonable precautions to ensure that the City's Documents and Data are safeguarded. Use of the Documents and Data is strictly limited to that use necessary to complete the scope of work agreed upon, which may include disclosure to employees, officers or agents of any subcontractor assisting with the scope of work. Any other use, and any sale or offering of the Documents and Data in any form by the Subcontractor, or any individual or entity in the Subcontractor's charge or employ, will be considered a violation of this Confidentiality Agreement and may result in termination of the agreement between Subcontractor and the law firm retained by the City, and the Subcontractor's suspension or debarment from City contracting. In addition, such conduct may be reported to the appropriate authorities for possible criminal prosecution.
2. Subcontractor shall be responsible to ensure that all agents and individuals or entities in the Subcontractor's charge or employ adhere to this Confidentiality Agreement. A breach of confidentiality by any individual or entity in the Subcontractor's charge or employ will be considered a violation of this Confidentiality Agreement by the Subcontractor.
3. In the event that Subcontractor, its agent or any individual or entity in the Subcontractor's charge or employ receives a subpoena, demand, or other request for any of the City's documents or data, Subcontractor shall promptly notify the City and shall not turn over any of the City's documents or data.
4. The Subcontractor shall comply with all applicable City and Federal laws that require the notification of individuals in the event of unauthorized release of personally-identifiable information or other event requiring notification. In the event of a breach of any of the Subcontractor's confidentiality obligations or other event requiring notification under applicable law ("Notification Event"), the Subcontractor agrees to assume responsibility for informing all such individuals in accordance with applicable law and to indemnify, hold harmless and defend the City and its trustees, officers, and employees from and against any claims, damages, or other harm related to such Notification Event.
5. Upon termination of this Confidentiality Agreement the Subcontractor shall return or erase, destroy, and render unreadable all Subcontractor copies of City Documents and Data, both physical and electronic, and certify in writing that these actions have been completed within 30 days of the termination of this Confidentiality Agreement or within 14 days of the request of an agent of the City, whichever shall come first.

6. This Confidentiality Agreement shall survive the Subcontractor's termination of the contract between the law firm retained by the City and Subcontractor or upon completion of the scope of work related to the City.

Subcontractor/Firm: \_\_\_\_\_

By: \_\_\_\_\_

Title: \_\_\_\_\_

Date: \_\_\_\_\_

# **EEO/AFFIRMATIVE ACTION REQUIREMENTS**

## **Goods, Professional Services and General Service Contracts**

Questions in reference to EEO/AA Requirements For Goods, Professional Services and General Service Contracts should be directed to:

Jeana F. Abuan  
Affirmative Action Officer, Public Agency Compliance Officer  
Department of Administration  
Office of Equal Opportunity/Affirmative action  
280 Grove Street Room-103  
Jersey City NJ 07302  
Tel. #201-547-4533  
Fax# 201-547-5088  
E-mail Address: [abuanJ@jonj.org](mailto:abuanJ@jonj.org)

(REVISED 4/13)

**EXHIBIT A**  
**MANDATORY EQUAL EMPLOYMENT OPPORTUNITY LANGUAGE**  
**N.J.S.A. 10:5-31 et seq. (P.L. 1975, C. 127)**  
**N.J.A.C. 17:27**

**GOODS, PROFESSIONAL SERVICE AND GENERAL SERVICE CONTRACTS**

During the performance of this contract, the contractor agrees as follows:

The contractor or subcontractor, where applicable, will not discriminate against any employee or applicant for employment because of age, race, creed, color, national origin, ancestry, marital status, affectional or sexual orientation, gender identity or expression, disability, nationality or sex. Except with respect to affectional or sexual orientation and gender identity or expression, the contractor will ensure that equal employment opportunity is afforded to such applicants in recruitment and employment, and that employees are treated during employment, without regard to their age, race, creed, color, national origin, ancestry, marital status, affectional or sexual orientation, gender identity or expression, disability, nationality or sex. Such equal employment opportunity shall include, but not be limited to the following: employment, upgrading, demotion, or transfer; recruitment or recruitment advertising; layoff or termination; rates of pay or other forms of compensation; and selection for training, including apprenticeship. The contractor agrees to post in conspicuous places, available to employees and applicants for employment, notices to be provided by the Public Agency Compliance Officer setting forth provisions of this nondiscrimination clause.

The contractor or subcontractor, where applicable will, in all solicitations or advertisements for employees placed by or on behalf of the contractor, state that all qualified applicants will receive consideration for employment without regard to age, race, creed, color, national origin, ancestry, marital status, affectional or sexual orientation, gender identity or expression, disability, nationality or sex.

The contractor or subcontractor will send to each labor union, with which it has a collective bargaining agreement, a notice, to be provided by the agency contracting officer, advising the labor union of the contractor's commitments under this chapter and shall post copies of the notice in conspicuous places available to employees and applicants for employment.

The contractor or subcontractor, where applicable, agrees to comply with any regulations promulgated by the Treasurer pursuant to N.J.S.A. 10:5-31 et seq., as amended and supplemented from time to time and the Americans with Disabilities Act.

The contractor or subcontractor agrees to make good faith efforts to meet targeted county employment goals established in accordance with N.J.A.C. 17:27-5.2.

**EXHIBIT A (Continuation)**

The contractor or subcontractor agrees to inform in writing its appropriate recruitment agencies including, but not limited to, employment agencies, placement bureaus, colleges, universities, and labor unions, that it does not discriminate on the basis of age, race, creed, color, national origin, ancestry, marital status, affectional or sexual orientation, gender identity or expression, disability, nationality or sex, and that it will discontinue the use of any recruitment agency which engages in direct or indirect discriminatory practices.

The contractor or subcontractor agrees to revise any of its testing procedures, if necessary, to assure that all personnel testing conforms with the principles of job-related testing, as established by the statutes and court decisions of the State of New Jersey and as established by applicable Federal law and applicable Federal court decisions.

In conforming with the targeted employment goals, the contractor or subcontractor agrees to review all procedures relating to transfer, upgrading, downgrading and layoff to ensure that all such actions are taken without regard to age, race, creed, color, national origin, ancestry, marital status, affectional or sexual orientation, gender identity or expression, disability, nationality or sex, consistent with the statutes and court decisions of the State of New Jersey, and applicable Federal law and applicable Federal court decisions.

The contractor shall submit to the public agency, after notification of award but prior to execution of a goods and services contract, one of the following three documents:

Letter of Federal Affirmative Action Plan Approval

Certificate of Employee Information Report

Employee Information Report Form AA302 (electronically provided by the Division and distributed to the public agency through the Division's website at [www.state.nj.us/treasury/contract\\_compliance](http://www.state.nj.us/treasury/contract_compliance))

The contractor and its subcontractors shall furnish such reports or other documents to the Division of Purchase & Property, CCAU, EEO Monitoring Program as may be requested by the office from time to time in order to carry out the purposes of these regulations, and public agencies shall furnish such information as may be requested by the Division of Purchase & Property, CCAU, EEO Monitoring Program for conducting a compliance investigation pursuant to Subchapter 10 of the Administrative Code at N.J.A.C. 17:27.

The undersigned vendor certifies on their company's receipt, knowledge and commitment to comply with:

**EXHIBIT A**  
N.J.S.A. 10:5-31 and N.J.A.C. 17:27  
**MANDATORY EQUAL EMPLOYMENT OPPORTUNITY LANGUAGE**  
Goods, Professional Services and General Service Contracts  
(Mandatory Affirmative Action Language)

The undersigned vendor further agrees to furnish the required forms of evidence and

understands that their contract/company's bid shall be rejected as non-responsive if said contractor fails to comply with the requirements of N.J.S.A. 10:5-31 and N.J.A.C. 17:27.

Eric T. Kanefsky, Esq.

Representative's Name/Title (Print):

Representative's Signature:

Calcagni & Kanefsky, LLP

Name of Company:

862-902-5455

Tei. No.:

Date: 10/30/18

Certification 56689

### CERTIFICATE OF EMPLOYEE INFORMATION REPORT

**INITIAL**

This is to certify that the contractor listed below has submitted an Employee Information Report pursuant to N.J.A.C. 17:27-1.1 et. seq. and the State Treasurer has approved said report. This approval will remain in effect for the period of 15/08/2021 to 15/08/2023

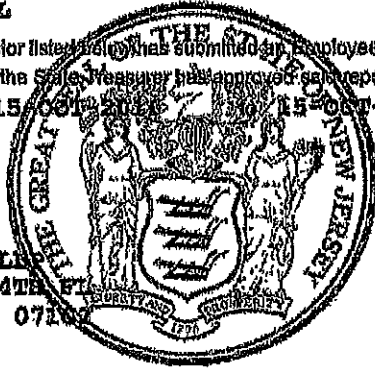

CALCAGNI & KANEFSKY, LLP  
1088 RAYMOND BLVD., 14TH FL.  
NEWARK NJ 07102



*Ford M. Scudder*

FORD M. SCUDDER  
State Treasurer



**STATE OF NEW JERSEY**  
Division of Purchase & Property  
Contract Compliance Audit Unit  
BSO Monitoring Program

**EMPLOYEE INFORMATION REPORT**

IMPORTANT-READ INSTRUCTIONS CAREFULLY BEFORE COMPLETING FORM. FAILURE TO PROPERLY COMPLETE THE ENTIRE FORM AND TO SUBMIT THE REQUIRED ELSDO PFE MAY DELAY ISSUANCE OF YOUR CERTIFICATE. DO NOT SUBMIT SEC-1 REPORT FOR SECTION B (ITEM 11). For instructions on completing the form, go to <http://www.treasury.state.nj.gov/contracts/compliance/pdfforms302m.pdf>

**SECTION A - COMPANY IDENTIFICATION**

1. FID NO OR SOCIAL SECURITY \_\_\_\_\_ 2. TYPE OF BUSINESS  
 1. MFG  2. SERVICE  3. WHOLESALE  
 4. RETAIL  5. OTHER \_\_\_\_\_ 3. TOTAL NO. EMPLOYEES IN THE ENTIRE COMPANY **15**

4. COMPANY NAME  
**Galcanri & Kanefsky LLP**

5. STREET CITY COUNTY STATE ZIP CODE  
**1085 Raymond Blvd, 14th Fl Newark Essex NJ 07102**

6. NAME OF PARENT OR AFFILIATED COMPANY (IF NONE, SO INDICATE) CITY STATE ZIP CODE  
**NONE**

7. CHECK ONE: IS THE COMPANY  SINGLE ESTABLISHMENT EMPLOYER  MULTI-ESTABLISHMENT EMPLOYER

8. IF MULTI-ESTABLISHMENT EMPLOYER, STATE THE NUMBER OF ESTABLISHMENTS IN NJ \_\_\_\_\_

9. TOTAL NUMBER OF EMPLOYEES AT ESTABLISHMENT WHICH HAS BEEN AWARDED THE CONTRACT **14**

10. PUBLIC AGENCY AWARDING CONTRACT: CITY COUNTY STATE ZIP CODE  
**City of Jersey City Jersey City Hudson NJ 07307**

11. ORIGINAL ONLY DATE RECEIVED INAUD DATE ASSIGNED CERTIFICATION NUMBER

**SECTION B - EMPLOYMENT DATA**

11. Report all permanent, temporary and part-time employees ON YOUR OWN PAYROLL. Enter the appropriate figure on all lines and in all columns. Where there are no employees in a particular category, enter a zero. Include ALL employees, not just those in minority/non-minority categories, in columns 1, 2, & 3. **DO NOT SUBMIT REPORT TO TREASURY**

JOB CATEGORIES	ALL EMPLOYEES			PERMANENT MINORITY/WHITE MAJORITY EMPLOYEE BREAKDOWN													
	COL. 1 TOTAL (COL. 1 & 2)	COL. 2 MALE	COL. 3 FEMALE	MALE					FEMALE								
				BLACK	HISPANIC	AMER INDIAN	ASIAN	NON MIN.	BLACK	HISPANIC	AMER INDIAN	ASIAN	NON MIN.				
Officials/Managers	2	2															
Professionals	9	7	2														2
Technicians																	
Sales Workers																	
Office & Clerical	4	2	2				1		1								2
Craftworkers (skilled)																	
Operatives (Semi-skilled)																	
Laborers (Unskilled)																	
Service Workers																	
<b>TOTAL</b>																	
Total employment Permanent/Temporary Reported (if any)	15	11	4				1		10								4

12. HOW WAS INFORMATION AS TO RACE OR ETHNIC GROUP IN SECTION B OBTAINED?  
 1. Visual Survey  2. Employment Record  3. Other (Specify) **discussed**

13. DAYS OF PAYROLL PERIOD USED  
 From **10/15/18** to **10/31/18**

14. IS THIS THE FIRST Employee Information Report Submitted? Yes  No

15. (IF NO, DATE LAST REPORT SUBMITTED)  
 O. OR. VS. H. **1/17/18**

**SECTION C - SIGNATURE AND IDENTIFICATION**

16. NAME OF PERSON COMPLETING FORM (Print or Type) SIGNATURE TITLE DATE  
**Diana Giordano** *[Signature]* Office Manager **10/30/18**

17. ADDRESS NO. & STREET CITY COUNTY STATE ZIP CODE PHONE (AREA CODE, NO. & EXTENSION)  
**1085 Raymond Blvd, 14 Fl Newark Essex NJ 07102 862 \* 002 \* 6455**

**APPENDIX A**  
**AMERICANS WITH DISABILITIES ACT OF 1990**  
**Equal Opportunity for Individuals with Disability**

The contractor and the City of Jersey City, (hereafter "owner") do hereby agree that the provisions of Title 11 of the Americans With Disabilities Act of 1990 (the "Act") (42 U.S.C. 5121 et seq.), which prohibits discrimination on the basis of disability by public entities in all services, programs, and activities provided or made available by public entities, and the rules and regulations promulgated pursuant thereto, are made a part of this contract. In providing any aid, benefit, or service on behalf of the owner pursuant to this contract, the contractor agrees that the performance shall be in strict compliance with the Act. In the event that the contractor, its agents, servants, employees, or subcontractors violate or are alleged to have violated the Act during the performance of this contract, the contractor shall defend the owner in any action or administrative proceeding commenced pursuant to this Act. The contractor shall indemnify, protect, and save harmless the owner, its agents, servants, and employees from and against any and all suits, claims, losses, demands, or damages, of whatever kind or nature, arising out of or claimed to arise out of the alleged violation. The contractor shall, at its own expense, appear, defend, and pay any and all charges for legal services and any and all costs and other expenses arising from such action or administrative proceeding or incurred in connection therewith. In any and all complaints brought pursuant to the owner's grievance procedure, the contractor agrees to abide by any decision of the owner which is rendered pursuant to said grievance procedure. If any action or administrative proceeding results in an award of damages against the owner, or if the owner incurs any expense to cure a violation of the ADA which has been brought pursuant to its grievance procedure, the contractor shall satisfy and discharge the same at its own expense.

The owner shall, as soon as practicable after a claim has been made against it, give written notice thereof to the contractor along with full and complete particulars of the claim, if any action or administrative proceeding is brought against the owner or any of its agents, servants, and employees, the owner shall expeditiously forward or have forwarded to the contractor every demand, complaint, notice, summons, pleading, or other process received by the owner or its representatives.

It is expressly agreed and understood that any approval by the owner of the services provided by the contractor pursuant to this contract will not relieve the contractor of the obligation to comply with the Act and to defend, indemnify, protect, and save harmless the owner pursuant to this paragraph.

It is further agreed and understood that the owner assumes no obligation to indemnify or save harmless the contractor, its agents, servants, employees and subcontractors for any claim which may arise out of their performance of this Agreement. Furthermore, the contractor expressly understands and agrees that the provisions of this indemnification clause shall in no way limit the contractor's obligations assumed in this Agreement, nor shall they be construed to relieve the contractor from any liability, nor preclude the owner from taking any other actions available to it under any other provisions of the Agreement or otherwise at law.

Eric T. Kanefsky, Esq.  
Representative's Name/Title (Print): \_\_\_\_\_  
Representative's Signature: Eric T. Kanefsky  
Name of Company: Calcagni & Kanefsky, LLP  
Tel. No.: 862-902-5455 Date: 10/30/18

**Minority/Woman Business Enterprise (M/WBE)  
Questionnaire for Bidders**

Jersey City Ordinance C-829 establishes a goal of awarding 20% of the dollar amount of total city procurement to minority and woman owned business enterprises.

To assist us in monitoring our achievement of this goal, please indicate below whether your company is or is not a minority owned and/or woman owned business, and return this form with your bid proposal.

Business Name : Calceagni & Kanefsky LLP  
Address : 1085 Raymond Blvd., 14th Floor; Newark, NJ 07102  
Telephone No. : 862-902-5455  
Contact Name : Eric T. Kanefsky, Esq.

Please check applicable category :

Minority Owned Business (MBE)       Minority & Woman Owned Business (M/WBE)  
 Woman Owned business (WBE)       Neither

**Definitions**  
**Minority Business Enterprise**

Minority Business Enterprise means a business which is a sole proprietorship, partnership or corporation at least 51% of which is owned and controlled by persons who are African American, Hispanic, Asian American, American Indian or Alaskan native, defined as follows:

**African American:** a person having origins in any of the black racial groups of Africa

**Hispanic:** a person of Mexican, Puerto Rican, Central or South American or other non-European Spanish culture or origin regardless of race.

**Asian:** a person having origins in any of the original peoples of the Far East, South East Asia, Indian subcontinent, Hawaii or the Pacific Islands.

**American Indian or Alaskan Native:** a person having origins in any of the original peoples of North America and who maintains cultural identification through tribal affiliation or community recognition.

**Woman Business Enterprise**

Woman Business Enterprise means a business which is a sole proprietorship, partnership or corporation at least 51% of which is owned and controlled by a woman or women.

**OFFICE OF EQUAL OPPORTUNITY COPY**

Minority/Woman Business Enterprise (MWBE)  
Questionnaire for Bidders

Jersey City Ordinance C-829 establishes a goal of awarding 20% of the dollar amount of total city procurement to minority and woman owned business enterprises.

To assist us in monitoring our achievement of this goal, please indicate below whether your company is or is not a minority owned and/or woman owned business, and return this form with your bid proposal.

Business Name: Calagani & Kanefsky LLP  
Address: 1085 Raymond Blvd., 14th Floor, Newark, NJ 07102  
Telephone No.: 862-902-5455  
Contact Name: Eric T. Kanefsky, Esq.

Please check applicable category:

Minority Owned Business (MBE)       Minority & Woman Owned Business (MWBE)  
 Woman Owned business (WBE)       Neither

Definitions  
Minority Business Enterprises

Minority Business Enterprise means a business which is a sole proprietorship, partnership or corporation at least 51% of which is owned and controlled by persons who are African American, Hispanic, Asian American, American Indian or Alaskan native, defined as follows:

African American: a person having origins in any of the black racial groups of Africa

Hispanic: a person of Mexican, Puerto Rican, Central or South American or other non-European Spanish culture or origin regardless of race.

Asian: a person having origins in any of the original peoples of the Far East, South East Asia, Indian subcontinent, Hawaii or the Pacific Islands.

American Indian or Alaskan Native: a person having origins in any of the original peoples of North America and who maintains cultural identification through tribal affiliation or community recognition.

Woman Business Enterprises

Woman Business Enterprise means a business which is a sole proprietorship, partnership or corporation at least 51% of which is owned and controlled by a woman or women.

DIVISION OF PURCHASING COPY

03/02/17

Taxpayer Identification# 812-712-035/000

Dear Business Representative:

Congratulations! You are now registered with the New Jersey Division of Revenue.

Use the Taxpayer Identification Number listed above on all correspondence with the Divisions of Revenue and Taxation, as well as with the Department of Labor (if the business is subject to unemployment withholdings). Your tax returns and payments will be filed under this number, and you will be able to access information about your account by referencing it.

Additionally, please note that State law requires all contractors and subcontractors with Public agencies to provide proof of their registration with the Division of Revenue. The law also amended Section 92 of the Casino Control Act, which deals with the casino service industry.

We have attached a Proof of Registration Certificate for your use. To comply with the law, if you are currently under contract or entering into a contract with a State agency, you must provide a copy of the certificate to the contracting agency.

If you have any questions or require more information, feel free to call our Registration Hotline at (609)292-9292.

I wish you continued success in your business endeavors.

Sincerely,



James J. Fruscione  
Director  
New Jersey Division of Revenue

<b>STATE OF NEW JERSEY</b> <b>BUSINESS REGISTRATION CERTIFICATE</b>		DEPARTMENT OF TREASURY/ DIVISION OF REVENUE PO BOX 252 TRENTON, N J 08646-0252
<b>TAXPAYER NAME:</b> CALCAGNI & KANEFSKY LLP	<b>TRADE NAME:</b>	
<b>ADDRESS:</b> 1085 RAYMOND BLVD 14TH FL NEWARK NJ 07102	<b>SEQUENCE NUMBER:</b> 2116117	
<b>EFFECTIVE DATE:</b> 03/02/17	<b>ISSUANCE DATE:</b> 03/02/17	
		 Director New Jersey Division of Revenue

(04-08), D205848V

**CERTIFICATION OF COMPLIANCE WITH THE CITY OF JERSEY CITY  
CONTRACTOR PAY-TO-PLAY REFORM ORDINANCE 08-128 ADOPTED  
ON SEPTEMBER 3, 2008**

**PART I - Vendor Affirmation**

The undersigned, being authorized and knowledgeable of the circumstances, does hereby certify that Calcagni & Kanefsky LLP (name of business entity) has not made any reportable contributions in the \*\*one-year period preceding January 8, 2018 (date City Council awards contract) that would be deemed to be violations of Section One of the City of Jersey City's Contractor Pay-to-Play Reform Ordinance 08-128 (attached hereto) and that would bar the award of this contract. I further certify that during the term of the contract Calcagni & Kanefsky LLP (name of business entity) will not make any reportable contributions in violation of Ordinance 08-128.

**PART II - Signature and Attestation:**

The undersigned is fully aware that if I have misrepresented in whole or part this affirmation and certification, I and/or the business entity, will be liable for any penalty permitted under law.

Calcagni & Kanefsky LLP

Name of Business Entity: \_\_\_\_\_

Signed: 

Title: Owner

Print Name: Eric Kanefsky, Esq.

Date: 10/30/2018

Subscribed and sworn before me  
this 30 day of Oct, 2018  
My Commission expires:

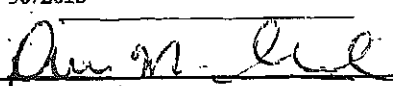
  
(Affiant)  
DIANA M. GIORDANO  
(Print name & title of affiant) (Corporate Seal)

**DIANA M. GIORDANO**  
NOTARY PUBLIC OF NEW JERSEY  
Comm. # 50067495  
My Commission Expires September 2022

\*\*Pursuant to Section 2 of Ordinance 08-128, no contributions or solicitation of contributions made prior to the effective date Ordinance 08-128 (September 23, 2008) shall be deemed to be a violation of the Ordinance.

**BUSINESS ENTITY DISCLOSURE CERTIFICATION**  
**FOR NON-FAIR AND OPEN CONTRACTS**  
 Required Pursuant To N.J.S.A. 19:44A-20.8  
**CITY OF JERSEY CITY**

**Part I – Vendor Affirmation**

The undersigned, being authorized and knowledgeable of the circumstances, does hereby certify that the <name of business entity> has not made and will not make any reportable contributions pursuant to N.J.S.A. 19:44A-1 et seq. that, pursuant to P.L. 2004, c. 19 would bar the award of this contract in the one year period preceding (date of award scheduled for approval of the contract by the governing body) to any of the following named candidate committee, joint candidates committee; or political party committee representing the elected officials of the <name of entity of elected officials> as defined pursuant to N.J.S.A. 19:44A-3(p), (q) and (r).

Steven Fulop for Mayor 2017	Friends of Chris L. Gadsden
Lavarro for Councilman	Friends of Richard Boggiano
Friends of Joyce Watterman	Michael Yun
Friends of Daniel Rivera	Osborne for Council
Gajewski for Council	Friends of Jermaine D. Robinson

**Part II – Ownership Disclosure Certification**

I certify that the list below contains the names and home addresses of all owners holding 10% or more of the issued and outstanding stock of the undersigned.

Check the box that represents the type of business entity:

- Partnership     
  Corporation     
  Sole Proprietorship     
  Subchapter S Corporation  
 Limited Partnership     
  Limited Liability Corporation     
  Limited Liability Partnership

Name of Stock or Shareholder	Home Address
Eric T. Kanefsky, Esq.	13 Coppell Drive; Tenafly, NJ 07670
Thomas R. Calcagni, Esq.	24 Miller Road; New Vernon, NJ 07976

**Part 3 – Signature and Attestation:**

The undersigned is fully aware that if I have misrepresented in whole or part this affirmation and certification, I and/or the business entity, will be liable for any penalty permitted under law.

Name of Business Entity: Calcagni & Kanefsky, LLP

Signed: [Signature] Title: Owner

Print Name: Eric T. Kanefsky, Esq. Date: 10/30/2018

Subscribed and sworn before me this <u>30</u> day of <u>October</u> , 2018 My Commission expires: _____ My Commission Expires September 2022	DIANA M. GIORDANO NOTARY PUBLIC OF NEW JERSEY Comm. # 50067495 My Commission Expires September 2022	<u>[Signature]</u> (Affiant) <u>DIANA M. GIORDANO</u> (Print name & title of affiant) (Corporate Seal)
--	--	---





# Resolution of the City of Jersey City, N.J.

City Clerk File No. Res. 18-997

Agenda No. 10.Z.12

Approved: NOV 07 2018

TITLE:



**RESOLUTION RATIFYING THE AWARD OF A PROFESSIONAL SERVICES AGREEMENT WITH PAWAR, GILGALLON & RUDY, LLC TO REPRESENT CITY OF JERSEY CITY, ROBERT KAKOLESKI, STACEY FLANAGAN & PAUL BELLAN-BOYER IN THE MATTER OF JOSE MARTINEZ V. CITY OF JERSEY CITY, ET AL.**

**WHEREAS**, a complaint was filed on December 13, 2017 in Superior Court of New Jersey under Docket No. HUD-L-5069-17 by Jose Martinez alleging violation of law against discrimination and Conscientious Employee Protection Act; and

**WHEREAS**, Corporation Counsel determined that it was necessary to appoint special counsel to represent City of Jersey City; and

**WHEREAS**, the law firm of Pawar, Gilgallon & Rudy, LLC is qualified to perform these services; and

**WHEREAS**, special counsel agreed to provide its services at an hourly rate of **\$150.00** per hour, including expenses, for a total contract amount not to exceed **\$75,000.00**; and

**WHEREAS**, these services qualify as professional services exempt from public bidding under the Local Public Contracts Law, N.J.S.A. 40A: 11-1 et seq.; and

**WHEREAS**, in October 2018, the City publicly advertised a Request for Qualifications (RFQ) using the "fair and open process" as described under the Pay-to-Play Law; and

**WHEREAS**, Pawar, Gilgallon & Rudy, LLC submitted a Qualification Statement in response to the City's RFQ; and

**WHEREAS**, the City is awarding this contract under the Fair and Open provisions of the New Jersey Local Unit Pay-to-Play Law, N.J.S.A. 19:44A-20.4 et seq.; and

**WHEREAS**, Pawar, Gilgallon & Rudy, LLC has submitted its Certification of Compliance with the City's Contractor Pay-to-Play Reform Ordinance 08-128 adopted on September 3, 2008; and

**WHEREAS**, an encumbrance in the amount of \$10,000.00 is available in **Account No. 18-01-201-23-210-312**.

**WHEREAS**, the resolution authorizing the award and the agreement itself must be available for public inspection.

**NOW, THEREFORE, BE IT RESOLVED** by the Municipal Council of the City of Jersey City that:

1. The award of an agreement with the law firm of Pawar, Gilgallon & Rudy, LLC to represent the City of Jersey City, Robert Kakoleski, Stacey Flanagan & Paul Bellan-Boyer in the Jose Martinez litigation is hereby ratified for one year effective **October 10, 2018**, for a total contract amount of **\$75,000.00**, including expenses;
2. The award of this contract shall be subject to the condition that the vendor provides satisfactory evidence of compliance with the Affirmative Action Amendments to the Law against Discrimination, N.J.S.A. 10:5-31 et seq.;

City Clerk File No. Res. 18-997  
Agenda No. 10.Z.12 NOV 07 2018

TITLE:

**RESOLUTION RATIFYING THE AWARD OF A PROFESSIONAL SERVICES AGREEMENT WITH PAWAR, GILGALLON & RUDY, LLC TO REPRESENT CITY OF JERSEY CITY, ROBERT KAKOLESKI, STACEY FLANAGAN & PAUL BELLANBOYER IN THE MATTER OF JOSE MARTINEZ V. CITY OF JERSEY CITY, ET AL.**

- 3. Subject to such modification as the Corporation Counsel deems appropriate or necessary, the Mayor or Business Administrator is authorized to execute the professional services agreement attached hereto;
- 4. A copy of this resolution will be published in a newspaper of general circulation in the City of Jersey City as required by law within (10) days of the adoption of the resolution;
- 5. This agreement is awarded without competitive bidding as a professional services agreement under the Local Public Contracts Law, N.J.S.A. 40A:11-1 et seq.;
- 6. The Certification of Compliance with the City's Contractor Pay-to-Play Reform Ordinance, attached hereto, shall be placed on file with this Resolution; and
- 7. Pursuant to N.J.A.C. 5:30-5.5(c), the continuation of the contract after the expenditure of funds encumbered in the 2018 fiscal year budget shall be subject the encumberancy of funds in the 2019 fiscal year budget.

I, Donna Mauer hereby certifies that there are sufficient funds available in **Account No.: 18-01-201-23-210-312** for payment of this resolution.

PO# 131229

  
Donna Mauer, Chief Financial Officer

DM  
10/30/2018

JMcK  
10/30/18

APPROVED: \_\_\_\_\_

APPROVED AS TO LEGAL FORM

APPROVED:  \_\_\_\_\_  
Business Administrator

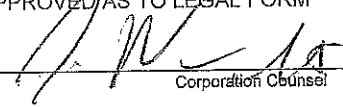
 \_\_\_\_\_  
Corporation Counsel

Certification Required

Not Required

APPROVED 8-0

RECORD OF COUNCIL VOTE ON FINAL PASSAGE 11.7.18											
COUNCILPERSON	AYE	NAY	N.V.	COUNCILPERSON	AYE	NAY	N.V.	COUNCILPERSON	AYE	NAY	N.V.
RIDLEY	✓			YUN	✓			RIVERA	✓		
PRINZ-AREY	✓			SOLOMON	✓			WATTERMAN	ABSENT		
BOGGIANO	✓			ROBINSON	✓			LAVARRO, PRES.	✓		

✓ Indicates Vote

N.V.-Not Voting (Abstain)

Adopted at a meeting of the Municipal Council of the City of Jersey City N.J.

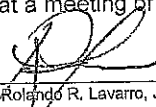
  
Rolando R. Lavarro, Jr., President of Council

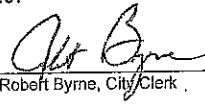
  
Robert Byrne, City Clerk

# Resolution of the City of Jersey City, N.J.

City Clerk File No. Res. 18-998

Agenda No. 10.Z.13

Approved: \_\_\_\_\_

TITLE:



**RESOLUTION RATIFYING AND RENEWING A PROFESSIONAL SERVICES AGREEMENT WITH PAWAR GILGALLON & RUDY, LLC TO REPRESENT THE CITY OF JERSEY CITY IN THE MATTER OF MEPT JOURNAL SQUARE URBAN RENEWAL LLC, MEPT JOURNAL SQUARE TOWER NORTH URBAN RENEWAL LLC, MEPT JOURNAL SQUARE TOWER SOUTH URBAN RENEWAL LLC V. CITY OF JERSEY CITY ET AL.**

**COUNCIL**  
following resolution:

offered and moved adoption of the

**WHEREAS** on or about May 9, 2009 the City of Jersey City (City) and MEPT Journal Square Urban Renewal LLC, MEPT Journal Square Tower North Urban Renewal, LLC, MEPT Journal Square Tower South Urban Renewal, LLC (collectively "MEPT") entered into certain financial agreements for tax abatements on certain properties to be developed by MEPT; and

**WHEREAS**, upon execution of the financial agreements, the City required MEPT to make a lump sum prepayment of \$2,000,000 based on the estimated calculation of one year of the annual service charges for the subject properties; and

**WHEREAS**, MEPT paid the City \$2,000,000; and

**WHEREAS**, MEPT also paid \$710,769 towards the Affordable Housing Trust Fund contribution; and

**WHEREAS**, in April 2015, MEPT requested that the City refund the monies previously paid that are identified above in an amount totaling \$2,710,769 to MEPT; and

**WHEREAS**, by Order dated October 4, 2016, the court granted MEPT's motion for a declaratory judgment and ordered the City to pay the total sum of \$2,710,769 to MEPT; and

**WHEREAS**, Corporation Counsel recommended the appointment of outside counsel to represent the City of Jersey City; and

**WHEREAS**, Resolution 17-234, approved on March 8, 2017, awarded a one year professional services contract in the amount of \$50,000, effective August 24, 2016 to Pawar Gilgallon & Rudy, LLC; and

**WHEREAS**, Resolution 17-687, approved on August 16, 2017, reauthorized a one year professional services contract with no additional funds, effective August 24, 2017 to Pawar Gilgallon & Rudy, LLC; and

**WHEREAS**, Resolution 18-357, approved on April 11, 2018, amended a professional services contract in the amount of \$25,000.00; and

**WHEREAS**, the City awarded the contract to Pawar Gilgallon & Rudy, LLC under the "fair and open process" of the Pay-to-Play Law, N.J.S.A. 19:44A-20.4 et. seq. (Pay-to-Play Law); and

**WHEREAS**, Pawar Gilgallon & Rudy, LLC has submitted its Certification of Compliance with the City's Contractor Pay-to-Play Reform Ordinance 08-128 adopted on September 3, 2008; and

**WHEREAS**, N.J.S.A. 40A:11-15 limits the term of a professional services contract to twelve months and requires professional services contracts to be renewed on an annual basis; and

**WHEREAS**, the lawsuit is still ongoing and it is necessary to ratify the renewal of the contract effective August 24, 2018 and to increase the contract amount by an additional \$75,000.00; and

**WHEREAS**, an encumbrance in the amount of \$10,000 is available in **Account No. 18-01-201-23-210-312**; and

**WHEREAS**, the resolution authorizing the award and the agreement itself must be available for public inspection.

TITLE:

**RESOLUTION RATIFYING AND RENEWING A PROFESSIONAL SERVICES AGREEMENT WITH PAWAR GILGALLON & RUDY, LLC TO REPRESENT THE CITY OF JERSEY CITY IN THE MATTER OF MEPT JOURNAL SQUARE URBAN RENEWAL LLC, MEPT JOURNAL SQUARE TOWER NORTH URBAN RENEWAL LLC, MEPT JOURNAL SQUARE TOWER SOUTH URBAN RENEWAL LLC V. CITY OF JERSEY CITY ET AL.**

**NOW, THEREFORE, BE IT RESOLVED** by the Municipal Council of the City of Jersey City that:

1. The agreement with the law firm of Pawar Gilgallon & Rudy, LLC is hereby ratified and reauthorized for one year effective August 24, 2018 for a total amount not to exceed \$75,000.00; for a total contract amount of \$150,000.00; and
2. This agreement is awarded without competitive bidding as a professional services agreement under the Local Public Contracts Law, N.J.S.A. 40A:11-5 (1)(a)(i) et seq.;
3. The award of this contract shall be subject to the condition that Pawar Gilgallon & Rudy, LLC provides satisfactory evidence of compliance with the Affirmative Action Amendments to the Law against Discrimination, N.J.S.A. 10:5-31 et seq.;
4. The Mayor or Business Administrator is hereby authorized to execute the renewal agreement in substantially the form attached subject to such modification as the Corporation Counsel deems appropriate or necessary.
5. A copy of this resolution will be published in a newspaper of general circulation in the City of Jersey City as required by law within (10) days of the adoption of the resolution; and
6. The Certification of Compliance with the City's Contractor Pay-to-Play Reform Ordinance, attached hereto, and shall be placed on file with this resolution.
7. Pursuant to N.J.A.C. 5:30-5.5(c), the continuation of the contract after the expenditure of funds encumbered in the 2018 fiscal year budget shall be subject the encumbrancy of funds in the 2019 fiscal year budget.

I, Donna Mauer, Chief Financial Officer, hereby certify that there are sufficient funds available in Account No.: 18-01-201-23-210-312 for payment of this resolution. P.O. No. 131248

  
 Donna Mauer, Chief Financial Officer

APPROVED: 11/5/18  
  
 Business Administrator

APPROVED AS TO LEGAL FORM  
  
 Corporation Counsel

Certification Required

Not Required

APPROVED 8-0

JMcK  
 11/5/18

RECORD OF COUNCIL VOTE ON FINAL PASSAGE 11.7.18											
COUNCILPERSON	AYE	NAY	N.V.	COUNCILPERSON	AYE	NAY	N.V.	COUNCILPERSON	AYE	NAY	N.V.
RIDLEY	✓			YUN	✓			RIVERA	✓		
PRINZ-AREY	✓			SOLOMON	✓			WATTERMAN	ABSENT		
BOGGIANO	✓			ROBINSON	✓			LAVARRO, PRES.	✓		

✓ Indicates Vote

N.V.-Not Voting (Abstain)

Adopted at a meeting of the Municipal Council of the City of Jersey City N.J.

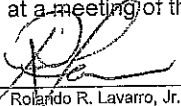
  
 Rolando R. Lavarro, Jr., President of Council

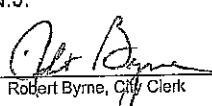
  
 Robert Byrne, City Clerk

**RESOLUTION FACT SHEET - CONTRACT AWARD**

This summary sheet is to be attached to the front of any resolution that is submitted for Council consideration. Incomplete or vague fact sheets will be returned with the resolution.

**Full Title of Ordinance/Resolution**

**RESOLUTION RATIFYING THE AWARD OF A PROFESSIONAL SERVICES AGREEMENT WITH PAWAR, GILGALLON & RUDY, LLC TO REPRESENT CITY OF JERSEY CITY, ROBERT KAKOLESKI, STACEY FLANAGAN & PAUL BELLAN-BOYER IN THE MATTER OF JOSE MARTINEZ V. CITY OF JERSEY CITY, ET AL.**

**Project Manager**

Department/Division	Law	Law
Name/Title	Peter Baker	Corporation Counsel
Phone/email	201-547-4667	Pbaker@jcnj.org

Note: Project Manager must be available by phone during agenda meeting (Wednesday prior to council meeting @ 4:00 p.m.)

**Contract Purpose**

It was necessary to hire outside counsel to represent the City of Jersey City, Robert Kakoleski, Stacey Flanagan & Paul Bellan – Boyer who were named in a complaint filed in the US District Court by Jose Martinez alleging violation of law against discrimination and Conscientious Employee Protection Act.

**Cost (Identify all sources and amounts)**

**Contract term (include all proposed renewals)**

Risk Management  
01-201-23-210-312

One year effective October 10, 2018.

Type of award Fair/Open

If "Other Exception", enter type

**Additional Information**

I certify that all the facts presented herein are accurate.

  
Signature of Department Director

10/30/18  
Date

## Outside Counsel Agreement

This Agreement dated the \_\_\_\_ day of \_\_\_\_\_, 2018 between the City of Jersey City, a municipal corporation, with offices at 280 Grove Street, Jersey City, New Jersey 07302 ("City") and, Pawar, Gilgallon & Rudy, 6 South Street, Suite 201, Morristown, NJ 07960 ("Special Counsel"). The Corporation Counsel of the City of Jersey City has selected Special Counsel to serve as Outside Counsel in connection with *Jose Martinez v. City of Jersey City, et al.*

In consideration of the mutual promises and covenants set forth herein, the parties agree as follows:

### I. CONFLICTS OF INTEREST

#### **A. Initial Conflicts Check.**

Outside Counsel must be sensitive both to direct conflicts of interest that representation of the City and other clients poses, and to the less direct, but nevertheless serious, conflicts that may arise from the same firm's advocacy, on behalf of other clients, of positions conflicting with important City interests. Prior to Outside Counsel's engagement, Outside Counsel shall carefully review whether any conflicts of either type exist and, if so, bring those conflicts to the attention of the Corporation Counsel. The City shall be promptly informed of and consulted with respect to all potential conflicts. Although issue conflicts may not necessarily result in a disqualification of Outside Counsel, the City shall be consulted before Outside Counsel accepts an engagement that will require the firm to advocate a position that may be adverse to a City legal interest or otherwise prejudicial to the interests of the City. The City in its sole discretion shall, after consultation with Outside Counsel, determine whether an impermissible conflict exists, or whether other circumstances exist that would undermine the public's confidence if representation by Outside Counsel continued.

Outside Counsel's acceptance of an engagement on a matter without written disclosure of any conflicts constitutes Outside Counsel's representation that it has conducted an appropriate conflict check and no conflict exists.

#### **B. City Conflicts.**

The City has a duty to protect the public interest. As part of this responsibility, the City sets policies to ensure that the legal system operates in a manner that safeguards the public's confidence in the integrity and impartiality of its administration. For this reason, in addition to insisting that its attorneys follow the Rules of Professional Conduct, the City prohibits Outside Counsel that represent the City, while such matter is pending, from:

- (1) Representing private parties before the City or any of its boards, proceedings, commissions or autonomous agencies in adversarial, transactional or non-adversarial proceedings. Outside Counsel also may not, on behalf of a private client, lobby the City or any City department.
- (2) Representing private parties in any matter in which the City also is a party, if the private party has interests adverse to the City.
- (3) Representing a private client with interests adverse to the City.
- (4) Representing another client if that representation would present a substantial risk that Outside Counsel's responsibilities to the City would limit its ability to provide independent advice or diligent and competent representation either to the City or the other client.
- (5) Representing another client where the Outside Counsel's knowledge of the City's legal positions or strategy, derived from its representation or prospective representation of the City, could be used to the advantage of the other client or the disadvantage of the City.

**C. Continuing Obligation.**

The obligation to disclose conflicts continues throughout the course of the representation. Outside Counsel must review conflicts of interest on an ongoing basis as new matters are opened. Any new attorney/client relationships that potentially create a conflict shall be reported to the Corporation Counsel immediately.

**D. Attorney-Client Privilege Group/No Representation of Other Persons/Entities Absent Approval.**

Outside attorneys engaged to represent the City (as opposed to a named person) shall consider themselves to have formed an attorney-client relationship *only* with the City, and not any of its individual employees. When speaking with current or former employees of the City, Outside Counsel shall, as appropriate, advise those employees that although their dialogue will be considered attorney-client communications to the fullest possible extent, counsel's responsibility is to the City and they do not represent those employees in their individual capacities. As a matter proceeds, if employees of the City will be examined under oath or interviewed in other adverse contexts, and if Outside Counsel believe it advisable for them to represent the employees in their individual capacities at such events, Outside Counsel must obtain the Corporation Counsel's advance consent before agreeing to represent such persons in their individual capacities. The Corporation Counsel, in consultation with other City personnel, will determine if it is appropriate for the individual to receive representation and, if so, by whom.

Outside Counsel who are engaged to represent both an entity and employees of that entity simultaneously shall take all necessary steps to ensure the continuing absence of conflicts, and to preserve their ability to continue representing the entity in the event that conflicts develop between the entity and individual clients.

## **II. WORKING RELATIONSHIP**

### **A. Identification of Objectives/Relationship Attorney.**

The Corporation Counsel or his designee will be Outside Counsel's principal and regular point of contact for financial and strategic decisions. Only the Corporation Counsel or his designee has authority to direct Outside Counsel in the handling of the matter. If a City employee other than the Corporation Counsel or his designee asks Outside Counsel to proceed in a certain fashion or to perform certain activities with respect to a specific legal matter, Outside Counsel shall report the request to the Corporation Counsel and obtain direction prior to proceeding.

Outside counsel shall designate an Attorney to be the Corporation Counsel's principal contact. In all matters, the City remains ultimately responsible for making all substantive decisions and determining the costs and benefits of contemplated legal activity. In many matters, City attorneys will act as full co-counsel and be engaged with Outside Counsel in the day-to-day conduct of the case. In matters where Outside Counsel is handling that day-to-day conduct without City personnel as co-counsel, the City shall be consulted on a regular basis throughout the course of Outside Counsel's engagement and to be kept fully informed of the current status and proposed course of the matters assigned to Outside Counsel's firm. All strategic, tactical, staffing (including any proposed staffing changes) and significant resource allocation decisions about City legal matters must be made in collaboration with the Corporation Counsel.

### **B. Early Case Assessment/Cost Assessment.**

Each complex matter is to be thoroughly evaluated at its outset. The same applies to actions in which the City is the plaintiff, except that the analysis will be performed before the case is filed. In any matter, Outside Counsel shall provide an early case assessment that includes analysis of (1) likely costs to the City from the process, (2) possible outcomes, indicating the likelihood of each, and (3) strategy and tactics for termination or resolution. The format of the early case assessment may vary from a formal written document to a verbal briefing or a combination of a written budget with a verbal briefing on other aspects of the case.

Please note that time spent preparing a budget is not billable, but counsel may bill for time spent preparing an early case assessment or a recommended discovery plan.

The City places significant reliance on cost estimates and Outside Counsel shall prepare them with care. Although the City understands that unanticipated events may have an impact on costs,



the City shall be consulted promptly if Outside Counsel believes that the most recent cost estimate provided is no longer accurate. Should total fees or costs exceed the agreed budget, or should fees or costs for a phase of the case exceed the agreed estimate for that phase, without adequate explanation in advance that the increased expense will be necessary, the City may require that an increased discount be applied to unanticipated fees or costs and reserves the right not to pay Outside Counsel for any amounts incurred or expended in excess of the approved budget or estimate.

For bond matters and other transactional engagements, counsel may be expected to provide a fee cap for the transaction, approved by the City, prior to commencing work. Only where a transaction materially changes in scope will the City consider revisions to an agreed fee cap. No payments above the agreed fee cap shall be made unless and until a revised fee cap has been approved in writing by the Director of the City or his/her designee.

**C. Staffing.**

Unless otherwise agreed, the senior attorney retained shall be directly and ultimately responsible for the entire assignment. The day-to-day involvement of that senior attorney, however, shall be appropriate to the magnitude of the matter and the efficiency required for a timely, cost effective, quality work product. When a senior attorney can handle an assignment most efficiently (based on skill and experience), that senior attorney shall complete the assignment.

The City shall be billed for only one attorney to attend events such as depositions, witness meetings, settlement conferences, negotiations and meetings with other parties' counsel. The City recognizes that in more complex matters and those with multiple work-streams, it may occasionally be appropriate for multiple attorneys to attend significant events and for members of the team to consult with each other. The City insists, however, that no more than the minimum number of attorneys necessary to an event attend, that billable internal conferences and charges for drafting and reading internal email correspondence occur only when absolutely required, and that the Corporation Counsel be regularly informed both of the number of attorneys who will attend significant events and the reason for the attendance of each billing timekeeper.

The City believes that it is most efficient for a single attorney or group of attorneys to handle a matter from beginning to end and Outside Counsel shall strive for such continuity. The City will not pay for learning time that may result from staffing changes at Outside Counsel's firm. In addition, the City will not reimburse Outside Counsel for any routine training or supervisory time, including time spent at seminars, unless specifically approved in advance and included as part of the budget. The City will not ordinarily pay for summer associate time unless such time has been identified as part of the approved staffing plan for appropriate work. The City will not pay for time submitted by librarians; secretaries; billing, filing, docketing or document clerks; internal messengers/couriers; temporary or clerical support staff; word processors; and IT professionals other than electronic discovery specialists serving a function similar to that of paralegals/case managers. The City also will not pay for time billed by attorneys or paralegals to

perform tasks (filing, indexing, etc.) that could and should have been handled by support personnel.

**D. Settlement.**

Outside Counsel shall have no settlement authority unless and until such authority is explicitly conferred on them by the Corporation Counsel. If Outside Counsel believes that settlement should be pursued, Outside Counsel must seek instructions in this regard from the Corporation Counsel, and not pursue formal or informal settlement discussions without the Corporation Counsel's approval. Outside Counsel shall immediately inform the Corporation Counsel of any settlement proposal or overture, formal or informal, by the opposing party or counsel. Please note that under no circumstances can the City agree to designate a settlement agreement as confidential. All City settlement records are, by definition, public documents.

**E. Media Relations/Law Firm Advertising.**

**The City does not authorize outside counsel or vendors to comment publicly in any manner on any aspect of the City's legal matters.** All media inquiries relating to the City shall be referred promptly to the Corporation Counsel and discussed with the Corporation Counsel before responding to the media contact in any manner. This includes even "no comment" or other non-substantive responses. If time is of the essence and Outside Counsel cannot reach the Corporation Counsel, the Press Secretary in the Office of the Mayor shall be contacted.

The City does not permit Outside Counsel to advertise or promote their relationship with the City, other than by listing the City as a representative client.

**F. Engagement of E-Discovery and Other Vendors, Including Experts.**

Before engaging any vendor, including electronic discovery firms and experts, lobbyists or other consultants (in each case, a "vendor"), Outside Counsel must pre-clear that engagement with the Corporation Counsel, unless the Corporation Counsel has explicitly granted exceptions to this preclearance requirement. The City will not be responsible for vendor fees or costs unless that vendor's engagement was pre-approved by the City. The City may require Outside Counsel to engage vendors with which the City has master contracts or preferred pricing arrangements, and always will insist on engagement of the lowest-cost vendor qualified to handle a task (understanding that complex tasks may require vendors with specialized expertise).

Outside Counsel will pay all third-party service providers directly and will bill the City for those services' detailed disbursements included in monthly invoices. This City will not accept separate invoices from service providers directly to the City for payment.

Outside Counsel has the responsibility to ensure that there are no conflicts between any vendor and the City. In addition, all vendors must execute the confidentiality agreement attached as

Appendix A. The fee and disbursement policies as outlined in this Agreement shall be made available to, and followed by vendors. It is Outside Counsel's responsibility to confirm that all third party billings comply with this Agreement.

Vendor payment arrangements shall be discussed in advance with the Corporation Counsel. In general, Outside Counsel shall contract with vendors themselves and pay the third party invoices directly, incorporating those invoices into their own bills to the City and including appropriate detail for reasonable review by City personnel. The City may request Outside Counsel to provide full copies of vendor invoices; Outside Counsel therefore shall retain those invoices in accordance with IRS guidelines. The Corporation Counsel may approve other payment arrangements, including (in rare cases) direct contracting with and payment by the City.

When engaging court reporting services, Outside Counsel shall request only one transcript (electronic or hard copy). The City will not reimburse charges for additional transcripts.

**G. Adherence to Ethical Standards.**

The City conducts itself in accordance with the highest ethical standards and expects the same of its Outside Counsel. No City employee ever has authority to instruct Outside Counsel to act in an unethical manner. If Outside Counsel believes that a City employee has engaged or will engage in illegal or unethical activity, Outside Counsel must immediately advise the Corporation Counsel. The City will terminate its relationship with any Outside Counsel who, in the City's sole discretion, fails to adhere to the foregoing ethical standards.

At all times, Outside Counsel will remain aware of and in compliance with each of the City's "Pay-to-Play" ordinances and any amendments thereto.

**H. Gratuities.**

City officers and employees are prohibited from accepting any gift, favor, service or other thing of value related in any way to the City officer's or employee's public duties. In addition, any vendor to the City is prohibited from offering a gift or other thing of value to a City officer or employee with which the vendor transacts business or offers to transact business. Any City officer or employee is prohibited from soliciting a gift or thing of value from a City vendor. This includes charitable donations made in the name of a City employee.

The City reserves the right to amend this Agreement from time to time, providing written notification to Outside Counsel within thirty (30) days of the effective date of any substantive changes. Failure to accept amendments may result in the termination of services from the City.

**I. Malpractice Insurance.**

Outside Counsel representing the City shall maintain malpractice insurance coverage that is reasonable and prudent in relation to the types and sizes of matters handled. Outside Counsel shall, upon request, promptly provide the Corporation Counsel with copies of any applicable policies required under this section, and/or a certificate of insurance. Each policy provided must be certified by the agent or underwriter to be a true copy. If Outside Counsel does not have coverage or if coverage is cancelled and not immediately replaced with comparable coverage, Outside Counsel must immediately report this to the Corporation Counsel.

**J. File Retention.**

For Litigated Matters: Outside Counsel shall retain pleadings, correspondence, discovery materials, deposition transcripts and similar documents and work product for a period of no less than seven (7) years from the date the matter is concluded or for the time period specified by rule or law in the jurisdiction in which the matter was pending, whichever is longer. Beyond this period, Outside Counsel shall notify the City in writing no less than sixty (60) days prior to destroying any file. Along with the written notification, Outside Counsel shall submit an inventory of any original City documents contained in the file to be destroyed and a representation that any electronic version of the file will also be destroyed or deleted.

For Bond and Other Transactions, and Advice Matters: Documents shall be retained in accordance with the same policies applicable to litigated matters unless applicable law mandates any longer retention schedule. However, bond counsel and transactional/advice counsel shall retain all transcripts of transactions and memoranda of advice indefinitely unless otherwise directed by the Corporation Counsel.

**III. Billing**

**A. Rates.**

Outside Counsel shall be compensated at the rate of \$150.00 per hour, including expenses. The total amount of this agreement shall not exceed \$75,000.

The City will pay for actual services rendered at rates established in Requests for Qualifications or otherwise agreed to in advance. At the time of Outside Counsel's initial engagement, Outside Counsel shall furnish the Corporation Counsel with a schedule of billing rates for partners, associates and all other timekeepers expected to bill time against the matter for review and approval prior to billing time to the City. Because of City procurement rules, the rates applicable at the inception of each specific matter must remain in effect for the duration of that matter.

Hourly rates shall include all overhead costs (*see* Acceptable Fees/Charges, below), none of which shall be included in disbursements.

Time must be billed in 0.1 hour increments and on a per-task basis. The time entry description must be specific, detailing the action taken and the subject matter. Absent prior consent, the City will not pay for more than ten (10) hours of time by a single timekeeper in a single day, but the Corporation Counsel may increase that number of permissible hours in matters of special urgency or where cases are in or approaching trial.

Outside Counsel shall bear in mind that invoices may be disclosed pursuant to the City's open records laws and that courts may not sustain assertions of privilege by the City. Although the City will endeavor to redact privileged information before releasing bills for public consumption, Outside Counsel shall, to the extent practicable and consistent with the need to fully inform the City of its activities and to allow the City to evaluate the reasonableness of billing narratives, avoid the inclusion of privileged matter in invoices.

**B. Invoicing Policy.**

All invoices must be submitted to the Corporation Counsel.

For litigation, advice, and non-bond transactional matters, Outside Counsel generally are expected to submit monthly invoices within thirty days of the conclusion of the billing period, absent the City's prior consent to a longer delay. All charges must reflect the work performed within the billing period or a reasonable time before the billing period. Absent good cause, as defined by the City, the City will not pay for services or expenses incurred more than 90 days prior to the date the invoice is submitted. For bond matters, Outside Counsel are expected to submit their invoice within thirty days of the conclusion of the transaction.

Absent a specific agreement to an alternative fee arrangement, Outside Counsel fees shall be computed by applying the negotiated hourly rate to the time for the services expended. Hours shown must accurately reflect the time spent on the described activity and must either be the exact amount of time or the exact time rounded down to the nearest one-tenth of an hour. Block billing—grouping multiple activities under a single time charge—will not be accepted, and the City will not pay for any time recorded in a block fashion unless this requirement is waived by the Director of the City of Law or his or her designee.

Every bill from Outside Counsel is deemed to be a certification by the firm and billing partner that all legal services and disbursements reflected on the bill are reasonable for the legal matter involved and necessary for the proper provision of legal services to the City. The City may deduct certain fees and charges that are inconsistent with this Agreement.

The City reserves the right to audit all fee and disbursement details that Outside Counsel submit, as well as the corresponding legal file. The City will promptly terminate the services of any Outside Counsel whose billing practices raise questions about the Outside Counsel's integrity, honesty or compliance with the applicable rules of professional conduct or this Agreement.

**C. Invoice Format.**

Each invoice will include the following minimum requirements:

- Unique invoice number
- Invoice date
- Matter name
- Outside Counsel's matter number
- Date(s) services were performed
- Timekeeper name or ID
- Timekeeper title or level
- A narrative description of the services provided or tasks performed for each specific task. The description shall clearly state the nature of the task performed sufficient to allow the City to determine why it was necessary. Incomplete or vague charge descriptions are unacceptable. Examples of incomplete or vague charges include, but are not limited to: 'analysis', 'review file,' 'conference', 'attention to matter'; 'worked on discovery', 'work on file', 'prepare for meeting', 'misc.', and 'other'
- Time entry to the nearest tenth (.10) of an hour
- Timekeeper rate
- Charge total
- Detail of reimbursable expenses and disbursements at actual cost

The detailed billing report from Outside Counsel's system will provide this information. If Outside Counsel provides services on more than one matter during a billing period, a separate invoice for each matter is required.

**D. Acceptable Fees/Charges.**

**Overhead charges may not be billed.** The City will not reimburse Outside Counsel for basic support services, which the City deems to be part of Outside Counsel's overhead and built into its rates. The City will not pay for any of the following items under any circumstances:

- Billing inquiries
- Opening and closing files
- Internal filing
- Secretarial services (including overtime charges)
- Word processing or proofreading
- Maintenance of a calendar or tickler system
- Investigating potential conflicts
- Preparing budgets
- Library usage (including book purchases or subscriptions) or library staff time
- Office supplies
- Conference room charges

**E. Basic legal research may not be billed.**

Outside Counsel shall be familiar with the basic substantive law at issue in the matter for which the firm was retained, and the City shall not be charged for this type of research. If legal research benefits other clients, only the proportionate share of that cost shall be billed to the City. The City shall also benefit from previously prepared briefs and memoranda, and when such briefs or memoranda exist, will pay only for actual time spent updating or tailoring the same. All other anticipated legal research shall be addressed in Outside Counsel's proposed budget. Legal research projects necessary in a particular litigation assignment must be approved in advance by the Corporation Counsel before the research is commenced.

The City will pay only for the actual time spent by Outside Counsel or other approved timekeeper conducting the research. As explained *infra*, fees charged by electronic or other research services, including library fees, Westlaw, Lexis and other online services are considered general overhead and are not reimbursable.

**F. Out-of-pocket costs must be itemized and passed through with no markup.**

The City will reimburse Outside Counsel for reasonable, documented and itemized out-of-pocket disbursements and costs incurred on behalf of the City, with the exceptions and limitations set forth in this Agreement. Outside Counsel's invoices to the City shall reflect the actual cost and shall not include any markup. All disbursements must be fully itemized with a description sufficient for review, identifying the number of units, price per unit and total cost. The City may refuse to pay for disbursements billed as 'miscellaneous,' billed in a group (e.g., Travel Expenses - \$4,000.00) or disbursements without descriptions.

**G. Prohibited disbursements.**

The City considers certain disbursements to be part of a law firm's overhead and will not pay such charges. These items include:

- Rent (including temporary office space)
- Westlaw, Lexis and other legal database services
- Cost or usage of computers or mobile devices or internet service charges
- Equipment rental
- Storage charges
- Catering for internal meetings
- Meals (except during business travel, and then limited to \$70 per day)
- Mileage for short trips (<30 miles one way)
- Travel costs exceeding discounted, non-refundable coach fares except where excess costs have been approved in advance
- Telephone charges

- Facsimile charges
- Allocated charges from a firm's blanket service agreements with outside vendors

**H. Copying/scanning.**

Copying charges may be billed to the City at the lesser of the most favorable rate applied by Outside Counsel or five cents per page. The City will reimburse for document scanning at Outside Counsel firm's regular rate, up to a maximum of five cents per page, for document productions, but the City will not pay time charges associated with scanning, and there shall be no charges associated with the scanning and filing of court papers and correspondence. Every effort shall be made to minimize scanning expenses by working with documents in electronic format whenever possible.

**I. Couriers and Overnight Mail.**

The City will reimburse for actual charges billed to Outside Counsel for deliveries (including overnight express) that are necessary in the interest of speed and reliability. Outside Counsel shall use the lowest cost service consistent with need and reliability, and to arrange schedules, whenever practicable, to avoid the need for premium-priced couriers. Outside Counsel shall use less expensive means, such as email (encrypted, when necessary) or regular mail where it is practical to do so.

**J. Travel Expenses.**

All air and rail travel must be first approved by the Corporation Counsel, ideally as part of the case budget. Outside Counsel shall use good judgment in selecting hotels and restaurants and incurring expenses for which the taxpayers are to be charged. Outside Counsel shall use alternatives to travel such as conference calls or videoconferences whenever practicable. If the travel involves another client, the City may be billed only for its proportionate share of both time and related expenses. **Non-working travel time is not billable without the Corporation Counsel's prior approval.**

**K. Reimbursement of Meals for Overnight Travel.**

The City will reimburse for meals consumed while traveling overnight on City business, but limited (absent prior approval) to no more than seventy dollars (\$70) per person, per day. Under no circumstances will the City reimburse costs for alcoholic beverages.

**L. Maintenance of Expense Records.**

To ensure compliance with the City's reimbursement policies, Outside Counsel shall require itemization of out-of-pocket expenses such as airline tickets, meals and hotel bills before making reimbursement to any attorney, employee or third party, and maintain original receipts. Travel



and meal expenses and receipts may be audited and shall be retained by Outside Counsel in accordance with applicable IRS guidelines. Unless requested to do so by the City, Outside Counsel shall not forward copies of travel and meal expense receipts to the City with the firm's invoices.

**M. Personal Expenses Not Reimbursable.**

Please take care to distinguish between personal expenses and properly chargeable business expenses. The City will not reimburse for, among other things, recreation fees, salon or spa charges, pay-per-view movies or other personal entertainment charges, airline baggage charges, travel agency expenses, shoe shines, toiletries, dry cleaning or laundry (except in the unlikely event travel of more than seven days' duration is required), or luggage.

**N. Vendor discounts must be passed through.**

If Outside Counsel receives a discount or rebate from a vendor based on the aggregate level of business with that vendor, such discount shall be disclosed and the City shall receive the benefit on a proportionate basis. This does not include frequent-flyer miles or similar perquisites allocated to individual travelers.

**IV. COMPLIANCE WITH AFFIRMATIVE ACTION PLAN**

(a) If the Agreement exceeds \$40,000.00, it shall be subject to the Affirmative Action Amendments to the Law Against Discrimination, N.J.S.A. 10:5-31 et seq.

(b) This Agreement shall not become effective and Contractor shall provide no services under this Agreement until it has executed the following documents:

1. A supplemental Affirmative Action Agreement pursuant to N.J.S.A. 10:5-31 et seq. (for contracts which exceed \$40,000.00). The Affirmative Action Agreement is attached hereto as Exhibit "B" and is incorporated herein by reference.

2. An Affirmative Action Employee Information Report (form AA-302) (for contracts which exceed \$40,000.00).

**V. CITY OF JERSEY CITY LOBBYIST DISCLOSURE ORDINANCE**

This contract was awarded in accordance with the provisions of the City's Disclosure of Lobbyist Representative Status Ordinance §3-9.1 et seq. adopted on June 12, 2002. As such the undersigned does hereby attest that Contractor either did not retain the services of a lobbyist to lobby on behalf of the Contractor for the award of this contract, or if a lobbyist was retained by the Contractor for such purposes, the Contractor's lobbyist, prior to commencing his/her lobbying activities, filed a notice of lobbyist representative status form with the City Clerk. Any Contractor

whose lobbyist failed to comply with the provisions of Ordinance §3-9.1 *et seq.*, following notice and an opportunity to be heard, shall be disqualified from entering into contracts with the City for a period of two (2) years for each violation.

## **VI. CONFIDENTIALITY**

In the course of representing the City, Outside Counsel will frequently gain access to nonpublic and confidential information. The City requires Outside Counsel to maintain the confidentiality of such information both during and after the course of Outside Counsel's representation of the City. Outside Counsel must have in place appropriate procedures to ensure the protection of all such information. In the event the representation requires Outside Counsel to become privy to protected personally-identifiable information about any person, such as health or financial records, Social Security numbers or other such information, then this information must be handled with the utmost care both within facilities in Outside Counsel's control, and certainly when that information is being transported. Under no circumstances shall such confidential information be transported outside Outside Counsel's offices--either physically or over the public internet--unless the information is appropriately encrypted. In the event information is compromised or potentially compromised, Outside Counsel must notify the City immediately.

Outside Counsel must follow all statutory, regulatory, and ethical provisions relating to privacy, confidentiality and nondisclosure of all privileged, proprietary and confidential information. Outside Counsel must take appropriate measures to ensure that all legal and nonlegal personnel are familiar with this requirement and are effectively supervised in this regard.

Vendors to whom Outside Counsel gives access to confidential or proprietary material of the City (including work product) must sign the confidentiality agreement attached as Appendix A. It is the responsibility of Outside Counsel to obtain a signed confidentiality agreement from each vendor and to retain those agreements.

This Confidentiality Section, and the corresponding Confidentiality Agreement attached as Appendix A, is above and beyond any relationships or privileges held or created separate and apart from this Agreement.

## **VII. NEW JERSEY BUSINESS REGISTRATION REQUIREMENTS**

Outside Counsel shall provide written notice to its subcontractors of the responsibility to submit proof of business registration to the contractor.

Before final payment on the contract is made by the contracting agency, the contractor shall submit an accurate list and the proof of business registration of each subcontractor or supplier used in the fulfillment of the contract, or shall attest that no subcontractors were used.

For the term of the contract, the contractor and each of its affiliates and a subcontractor and each of its affiliates [N.J.S.A. 52:32-44(g)(3)] shall collect and remit to the Director, New Jersey Division of Taxation, the use tax due pursuant to the Sales and Use Tax Act on all sales of tangible personal property delivered into this State, regardless of whether the tangible personal property is intended for a contract with a contracting agency.

A business organization that fails to provide a copy of a business registration as required pursuant to section 1 of P.L.2001, c.134 (C.52:32-44 et al.) or subsection e. or f. of section 92 of P.L.1977, c.110 (C.5:12-92), or that provides false business registration information under the requirements of either of those sections, shall be liable for a penalty of \$25 for each day of violation, not to exceed \$50,000 for each business registration copy not properly provided under a contract with a contracting agency.

### **VIII. TERMINATION**

The City reserves the right to terminate the within Agreement at any time for any reason whatsoever, in which event Outside Counsel shall be paid for services due up to the date of termination. Thereafter, this Agreement shall be considered null and void with no further rights or obligations emanating therefrom. Unless sooner terminated or renewed, this contract shall be for a term of one (1) year commencing on the date the contract is executed by City officials.

### **IX. GENERAL TERMS**

#### **A. Governing Law/Jurisdiction.**

This Agreement will be interpreted in accordance with, and governed by, the laws of the State of New Jersey. The courts of the State of New Jersey will have exclusive jurisdiction and the parties irrevocably attorney to the jurisdiction of such courts.

#### **B. Counterparts Clause.**

This Agreement may be executed by e-mail in counterparts all of which will be deemed originals and legally binding once delivered to each of the other parties' authorized e-mail addresses and such delivery is acknowledged by reply e-mail. Although not necessary to legally bind the parties, each party agrees to promptly circulate signed originals in sufficient number to the other parties for record-keeping purposes after completing the e-mail execution and delivery. All counterparts when executed and delivered (by e-mail or in paper form) will be construed together to be an original and will constitute one and the same agreement.

By accepting an engagement by the City, law firms will be deemed to have familiarized themselves with this agreement and to have agreed to adhere to it in all respects, now and as they may be amended from time to time upon written notice and acceptance. This acceptance is a matter both of contract and professional responsibility.

**Attest:**

**City of Jersey City**

\_\_\_\_\_  
**Robert Byrne**  
**City Clerk**

\_\_\_\_\_  
**Brian Platt**  
**Business Administrator**

**WITNESS:**

**Pawar Gilgallon & Rudy, LLC**

\_\_\_\_\_

\_\_\_\_\_  
**By:**  
**Firm:**

## APPENDIX A

### CONFIDENTIALITY AGREEMENT

\_\_\_\_\_ (Subcontractor), as a contractor of Outside Counsel retained by the City of Jersey City (the "City") pursuant to an "Outside Counsel Agreement" dated \_\_\_\_\_, hereby acknowledges and agrees as follows:

1. All documents and data, including but not limited to financial, statistical, personnel, customer and/or technical documents, owned or supplied by the City to the Subcontractor, shall be treated as confidential (Documents and Data). The Subcontractor shall take all necessary and reasonable precautions to ensure that the City's Documents and Data are safeguarded. Use of the Documents and Data is strictly limited to that use necessary to complete the scope of work agreed upon, which may include disclosure to employees, officers or agents of any subcontractor assisting with the scope of work. Any other use, and any sale or offering of the Documents and Data in any form by the Subcontractor, or any individual or entity in the Subcontractor's charge or employ, will be considered a violation of this Confidentiality Agreement and may result in termination of the agreement between Subcontractor and the law firm retained by the City, and the Subcontractor's suspension or debarment from City contracting. In addition, such conduct may be reported to the appropriate authorities for possible criminal prosecution.
2. Subcontractor shall be responsible to ensure that all agents and individuals or entities in the Subcontractor's charge or employ adhere to this Confidentiality Agreement. A breach of confidentiality by any individual or entity in the Subcontractor's charge or employ will be considered a violation of this Confidentiality Agreement by the Subcontractor.
3. In the event that Subcontractor, its agent or any individual or entity in the Subcontractor's charge or employ receives a subpoena, demand, or other request for any of the City's documents or data, Subcontractor shall promptly notify the City and shall not turn over any of the City's documents or data.
4. The Subcontractor shall comply with all applicable City and Federal laws that require the notification of individuals in the event of unauthorized release of personally-identifiable information or other event requiring notification. In the event of a breach of any of the Subcontractor's confidentiality obligations or other event requiring notification under applicable law ("Notification Event"), the Subcontractor agrees to assume responsibility for informing all such individuals in accordance with applicable law and to indemnify, hold harmless and defend the City and its trustees, officers, and employees from and against any claims, damages, or other harm related to such Notification Event.
5. Upon termination of this Confidentiality Agreement the Subcontractor shall return or erase, destroy, and render unreadable all Subcontractor copies of City Documents and Data, both physical and electronic, and certify in writing that these actions have been completed within 30 days of the termination of this Confidentiality Agreement or within 14 days of the request of an agent of the City, whichever shall come first.

6. This Confidentiality Agreement shall survive the Subcontractor's termination of the contract between the law firm retained by the City and Subcontractor or upon completion of the scope of work related to the City.

Subcontractor/Firm: \_\_\_\_\_

By: \_\_\_\_\_

Title: \_\_\_\_\_

Date: \_\_\_\_\_

**CERTIFICATION OF COMPLIANCE WITH THE CITY OF JERSEY CITY  
CONTRACTOR PAY-TO-PLAY REFORM ORDINANCE 08-128 ADOPTED  
ON SEPTEMBER 3, 2008**

**PART I - Vendor Affirmation**

The undersigned, being authorized and knowledgeable of the circumstances, does hereby certify that Pauer, Gilgallon & Rudy, LLC (name of business entity) has not made any reportable contributions in the \*\*one-year period preceding \_\_\_\_\_ (date City Council awards contract) that would be deemed to be violations of Section One of the City of Jersey City's Contractor Pay-to-Play Reform Ordinance 08-128 (attached hereto) and that would bar the award of this contract. I further certify that during the term of the contract Pauer, Gilgallon & Rudy, LLC (name of business entity) will not make any reportable contributions in violation of Ordinance 08-128.

**PART II - Signature and Attestation:**

The undersigned is fully aware that if I have misrepresented in whole or part this affirmation and certification, I and/or the business entity, will be liable for any penalty permitted under law.

Name of Business Entity: Pauer, Gilgallon & Rudy, LLC

Signed: [Signature] Title: Managing Member

Print Name: Vijayant Pauer, Esq. Date: Oct 26, 2018

Subscribed and sworn before me  
this 26 day of October, 2018.  
My Commission expires:

[Signature]  
MARIA APGAR  
NOTARY PUBLIC  
STATE OF NEW JERSEY  
MY COMMISSION EXPIRES FEB. 22, 2021

(Affiant)  
Marla Apgar  
(Print name & title of affiant) (Corporate Seal)

\*\*Pursuant to Section 2 of Ordinance 08-128, no contributions or solicitation of contributions made prior to the effective date Ordinance 08-128 (September 23, 2008) shall be deemed to be a violation of the Ordinance.

**APPENDIX A**  
**AMERICANS WITH DISABILITIES ACT OF 1990**  
Equal Opportunity for Individuals with Disability

The contractor and the Managing Member of Pawar, Gilgallon & Rudy, LLC (hereafter "owner") do hereby agree that the provisions of Title I of the Americans With Disabilities Act of 1990 (the "Act") (42 U.S.C. 5121 01 et seq.), which prohibits discrimination on the basis of disability by public entities in all services, programs, and activities provided or made available by public entities, and the rules and regulations promulgated pursuant thereto, are made a part of this contract. In providing any aid, benefit, or service on behalf of the owner pursuant to this contract, the contractor agrees that the performance shall be in strict compliance with the Act. In the event that the contractor, its agents, servants, employees, or subcontractors violate or are alleged to have violated the Act during the performance of this contract, the contractor shall defend the owner in any action or administrative proceeding commenced pursuant to this Act. The contractor shall indemnify, protect, and save harmless the owner, its agents, servants, and employees from and against any and all suits, claims, losses, demands, or damages, of whatever kind or nature, arising out of or claimed to arise out of the alleged violation. The contractor shall, at its own expense, appear, defend, and pay any and all charges for legal services and any and all costs and other expenses arising from such action or administrative proceeding or incurred in connection therewith. In any and all complaints brought pursuant to the owner's grievance procedure, the contractor agrees to abide by any decision of the owner which is rendered pursuant to said grievance procedure. If any action or administrative proceeding results in an award of damages against the owner, or if the owner incurs any expense to cure a violation of the ADA which has been brought pursuant to its grievance procedure, the contractor shall satisfy and discharge the same at its own expense.

The owner shall, as soon as practicable after a claim has been made against it, give written notice thereof to the contractor along with full and complete particulars of the claim. If any action or administrative proceeding is brought against the owner or any of its agents, servants, and employees, the owner shall expeditiously forward or have forwarded to the contractor every demand, complaint, notice, summons, pleading, or other process received by the owner or its representatives.

It is expressly agreed and understood that any approval by the owner of the services provided by the contractor pursuant to this contract will not relieve the contractor of the obligation to comply with the Act and to defend, indemnify, protect, and save harmless the owner pursuant to this paragraph.

It is further agreed and understood that the owner assumes no obligation to indemnify or save harmless the contractor, its agents, servants, employees and subcontractors for any claim which may arise out of their performance of this Agreement. Furthermore, the contractor expressly understands and agrees that the provisions of this indemnification clause shall in no way limit the contractor's obligations assumed in this Agreement, nor shall they be construed to relieve the contractor from any liability, nor preclude the owner from taking any other actions available to it under any other provisions of the Agreement or otherwise at law.

Representative's Name/Title Print: Vijayant Pawar, Managing MEMBER  
Representative's Signature: \_\_\_\_\_  
Name of Company: Pawar, Gilgallon & Rudy  
Tel. No.: 978-605-8800 Date: Oct. 26, 2018



Minority/Woman Business Enterprise (MWBE)  
Questionnaire for Bidders

Jersey City Ordinance C-829 establishes a goal of awarding 20% of the dollar amount of total city procurement to minority and woman owned business enterprises.

To assist us in monitoring our achievement of this goal, please indicate below whether your company is or is not a minority owned and/or woman owned business, and return this form with your bid proposal.

Business Name: Pawar, Gilgallon & Rudy, LLC  
Address: 6 South Street, Suite 201  
MORRISTOWN, NJ 07960  
Telephone No.: 973-605-8800  
Contact Name: Vijayant Pawar, Esq.

Please check applicable category:

- Minority Owned Business (MBE)       Minority & Woman Owned Business (MWBE)  
 Woman Owned business (WBE)       Neither

Definitions  
Minority Business Enterprise

Minority Business Enterprise means a business which is a sole proprietorship, partnership or corporation at least 51% of which is owned and controlled by persons who are African American, Hispanic, Asian American, American Indian or Alaskan native, defined as follows:

- African American: a person having origins in any of the black racial groups of Africa
- Hispanic: a person of Mexican, Puerto Rican, Central or South American or other non-European Spanish culture or origin regardless of race.
- Asian: a person having origins in any of the original peoples of the Far East, South East Asia, Indian subcontinent, Hawaii or the Pacific Islands.
- American Indian or Alaskan Native: a person having origins in any of the original peoples of North America and who maintains cultural identification through tribal affiliation or community recognition.

Woman Business Enterprise

Woman Business Enterprise means a business which is a sole proprietorship, partnership or corporation at least 51% of which is owned and controlled by a woman or women.

**Minority/Woman Business Enterprise (MWBE)  
Questionnaire for Bidders**

Jersey City Ordinance C-829 establishes a goal of awarding 20% of the dollar amount of total city procurement to minority and woman owned business enterprises.

To assist us in monitoring our achievement of this goal, please indicate below whether your company is or is not a minority owned and/or woman owned business, and return this form with your bid proposal.

Business Name : Pawar, Gilgallon & Rudy, LLC  
Address : 6 South Street, Suite 201  
MORRISTOWN, NJ 07960  
Telephone No. : 973-605-8800  
Contact Name : Vijayant Pawar, Esq.

Please check applicable category :

Minority Owned Business (MBE)       Minority & Woman Owned Business (MWBE)  
 Woman Owned business (WBE)       Neither

**Definitions**

**Minority Business Enterprise**

Minority Business Enterprise means a business which is a sole proprietorship, partnership or corporation at least 51% of which is owned and controlled by persons who are African American, Hispanic, Asian American, American Indian or Alaskan native, defined as follows:

**African American:** a person having origins in any of the black racial groups of Africa

**Hispanic:** a person of Mexican, Puerto Rican, Central or South American or other non-European Spanish culture or origin regardless of race.

**Asian:** a person having origins in any of the original peoples of the Far East, South East Asia, Indian subcontinent, Hawaii or the Pacific Islands.

**American Indian or Alaskan Native:** a person having origins in any of the original peoples of North America and who maintains cultural identification through tribal affiliation or community recognition.

**Woman Business Enterprise**

Woman Business Enterprise means a business which is a sole proprietorship, partnership or corporation at least 51% of which is owned and controlled by a woman or women.

**OFFICE OF EQUAL OPPORTUNITY COPY**

**BUSINESS ENTITY DISCLOSURE CERTIFICATION  
FOR NON-FAIR AND OPEN CONTRACTS  
Required Pursuant To N.J.S.A. 19:44A-20.8  
CITY OF JERSEY CITY**

**Part I - Vendor Affirmation**

The undersigned, being authorized and knowledgeable of the circumstances, does hereby certify that the <name of business entity> has not made and will not make any reportable contributions pursuant to N.J.S.A. 19:44A-1 et seq. that, pursuant to P.L. 2004, c. 19 would bar the award of this contract in the one year period preceding (date of award scheduled for approval of the contract by the governing body) to any of the following named candidate committee, joint candidates committee; or political party committee representing the elected officials of the <name of entity of elected officials> as defined pursuant to N.J.S.A. 19:44A-3(p), (q) and (r).

Steven Fulop for Mayor 2017	Mira Prinz-Arey for Council
Lavatto for Councilman	Friends of Richard Boggiano
Friends of Joyce Watterman	Michael Ynn for Council
Friends of Daniel Rivera	Solomon for Council
Ridley for Council	Friends of Jermaine Robinson

**Part II - Ownership Disclosure Certification**

I certify that the list below contains the names and home addresses of all owners holding 10% or more of the issued and outstanding stock of the undersigned.

Check the box that represents the type of business entity:

- Partnership   
 Corporation   
 Sole Proprietorship   
 Subchapter S Corporation  
 Limited Partnership   
 Limited Liability Corporation   
 Limited Liability Partnership

Name of Stock or Shareholder	Home Address
Vijayant Pawar, Esq.	7 Randolph Drive, Morristown, NJ
Craig S. Gilgallon, Esq.	64 Spring Brook Road, Morristown, NJ
Robert S. Rudy, Esq.	41 MT. REMBLE AVENUE, MORRISTOWN, NJ

**Part 3 - Signature and Attestation:**

The undersigned is fully aware that if I have misrepresented in whole or part this affirmation and certification, I and/or the business entity, will be liable for any penalty permitted under law.

Name of Business Entity: Pawar, Gilgallon & Rudy, LLC  
Signature of Affiant: [Signature] Title: Managing MEMBER  
Printed Name of Affiant: Vijayant Pawar, Esq. Date: Oct. 26, 2018

Subscribed and sworn before me this <u>26</u> day of <u>October</u> , 2018.	<u>[Signature]</u> (Witnessed or attested by)
My Commission expires:	(Seal)
<b>MARIA APGAR NOTARY PUBLIC STATE OF NEW JERSEY MY COMMISSION EXPIRES FEB. 22, 2021</b>	

Certification 50189

### CERTIFICATE OF EMPLOYEE INFORMATION REPORT

**INITIAL**

This is to certify that the contractor listed below has submitted an Employee Information Report pursuant to N.J.A.C. 17:27-1.1 et. seq. and the State Treasurer has approved said report. This approval will remain in effect for the period of ~~15 FEB-2019~~ to ~~15 FEB-2020~~

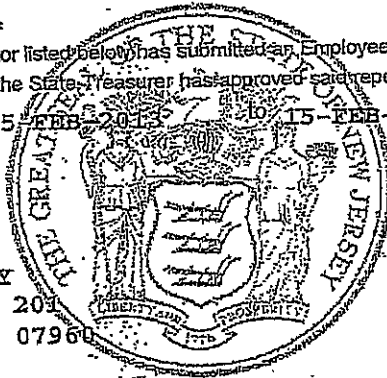

PAWAR GILGALLON & RUDY  
6 SOUTH STREET, SUITE 201  
MORRISTOWN NJ 07960

A handwritten signature in black ink, appearing to read "Andrew P. Sidamon-Eristoff".

Andrew P. Sidamon-Eristoff  
State Treasurer



## STATE OF NEW JERSEY BUSINESS REGISTRATION CERTIFICATE

<b>Taxpayer Name:</b>	PAWAR GILGALLON & RUDY, LLC
<b>Trade Name:</b>	
<b>Address:</b>	6 SOUTH STREET, SUITE 201 MORRISTOWN, NJ 07960
<b>Certificate Number:</b>	1740913
<b>Effective Date:</b>	September 06, 2012
<b>Date of Issuance:</b>	November 27, 2012

**For Office Use Only:**  
20121127124333717

# C. 271 POLITICAL CONTRIBUTION DISCLOSURE FORM

## Contractor Instructions

Business entities (contractors) receiving contracts from a public agency that are NOT awarded pursuant to a "fair and open" process (defined at N.J.S.A. 19:44A-20.7) are subject to the provisions of P.L. 2005, c. 271, s.2 (N.J.S.A. 19:44A-20.26). This law provides that 10 days prior to the award of such a contract, the contractor shall disclose contributions to:

- any State, county, or municipal committee of a political party
- any legislative leadership committee
- any continuing political committee (a.k.a., political action committee)
- any candidate committee of a candidate for, or holder of, an elective office:
  - of the public entity awarding the contract
  - of that county in which that public entity is located
  - of another public entity within that county
  - or of a legislative district in which that public entity is located or, when the public entity is a county, of any legislative district which includes all or part of the county

The disclosure must list reportable contributions to any of the committees that exceed \$300 per election cycle that were made during the 12 months prior to award of the contract. See N.J.S.A. 19:44A-8 and 19:44A-16 for more details on reportable contributions.

N.J.S.A. 19:44A-20.26 itemizes the parties from whom contributions must be disclosed when a business entity is not a natural person. This includes the following:

- individuals with an "interest" ownership or control of more than 10% of the profits or assets of a business entity or 10% of the stock in the case of a business entity that is a corporation for profit
- all principals, partners, officers, or directors of the business entity or their spouses
- any subsidiaries directly or indirectly controlled by the business entity
- IRS Code Section 527 New Jersey based organizations, directly or indirectly controlled by the business entity and filing as continuing political committees, (PACs).

When the business entity is a natural person, "a contribution by that person's spouse or child, residing therewith, shall be deemed to be a contribution by the business entity." [N.J.S.A. 19:44A-20.26(b)] The contributor must be listed on the disclosure.

Any business entity that fails to comply with the disclosure provisions shall be subject to a fine imposed by ELEC in an amount to be determined by the Commission which may be based upon the amount that the business entity failed to report.

The enclosed list of agencies is provided to assist the contractor in identifying those public agencies whose elected official and/or candidate campaign committees are affected by the disclosure requirement. It is the contractor's responsibility to identify the specific committees to which contributions may have been made and need to be disclosed. The disclosed information may exceed the minimum requirement.

The enclosed form, a content-consistent facsimile, or an electronic data file containing the required details (along with a signed cover sheet) may be used as the contractor's submission and is disclosable to the public under the Open Public Records Act.

The contractor must also complete the attached Stockholder Disclosure Certification. This will assist the agency in meeting its obligations under the law. **NOTE: This section does not apply to Board of Education contracts.**

<sup>1</sup> N.J.S.A. 19:44A-3(s): "The term "legislative leadership committee" means a committee established, authorized to be established, or designated by the President of the Senate, the Minority Leader of the Senate, the Speaker of the General Assembly or the Minority Leader of the General Assembly pursuant to section 16 of P.L.1993, c.65 (C.19:44A-10.1) for the purpose of receiving contributions and making expenditures."



(REVISED 4/13)

**EXHIBIT A**  
**MANDATORY EQUAL EMPLOYMENT OPPORTUNITY LANGUAGE**  
N.J.S.A. 10:5-31 et seq. (P.L. 1975, C. 127)  
N.J.A.C. 17:27

**GOODS, PROFESSIONAL SERVICE AND GENERAL SERVICE CONTRACTS**

During the performance of this contract, the contractor agrees as follows:

The contractor or subcontractor, where applicable, will not discriminate against any employee or applicant for employment because of age, race, creed, color, national origin, ancestry, marital status, affectional or sexual orientation, gender identity or expression, disability, nationality or sex. Except with respect to affectional or sexual orientation and gender identity or expression, the contractor will ensure that equal employment opportunity is afforded to such applicants in recruitment and employment, and that employees are treated during employment, without regard to their age, race, creed, color, national origin, ancestry, marital status, affectional or sexual orientation, gender identity or expression, disability, nationality or sex. Such equal employment opportunity shall include, but not be limited to the following: employment, upgrading, demotion, or transfer; recruitment or recruitment advertising; layoff or termination; rates of pay or other forms of compensation; and selection for training, including apprenticeship. The contractor agrees to post in conspicuous places, available to employees and applicants for employment, notices to be provided by the Public Agency Compliance Officer setting forth provisions of this nondiscrimination clause.

The contractor or subcontractor, where applicable will, in all solicitations or advertisements for employees placed by or on behalf of the contractor, state that all qualified applicants will receive consideration for employment without regard to age, race, creed, color, national origin, ancestry, marital status, affectional or sexual orientation, gender identity or expression, disability, nationality or sex.

The contractor or subcontractor will send to each labor union, with which it has a collective bargaining agreement, a notice, to be provided by the agency contracting officer, advising the labor union of the contractor's commitments under this chapter and shall post copies of the notice in conspicuous places available to employees and applicants for employment.

The contractor or subcontractor, where applicable, agrees to comply with any regulations promulgated by the Treasurer pursuant to N.J.S.A. 10:5-31 et seq., as amended and supplemented from time to time and the Americans with Disabilities Act.

The contractor or subcontractor agrees to make good faith efforts to meet targeted county employment goals established in accordance with N.J.A.C. 17:27-5.2.



**EXHIBIT A (Continuation)**

The contractor or subcontractor agrees to inform in writing its appropriate recruitment agencies including, but not limited to, employment agencies, placement bureaus, colleges, universities, and labor unions, that it does not discriminate on the basis of age, race, creed, color, national origin, ancestry, marital status, affectional or sexual orientation, gender identity or expression, disability, nationality or sex, and that it will discontinue the use of any recruitment agency which engages in direct or indirect discriminatory practices.

The contractor or subcontractor agrees to revise any of its testing procedures, if necessary, to assure that all personnel testing conforms with the principles of job-related testing, as established by the statutes and court decisions of the State of New Jersey and as established by applicable Federal law and applicable Federal court decisions.

In conforming with the targeted employment goals, the contractor or subcontractor agrees to review all procedures relating to transfer, upgrading, downgrading and layoff to ensure that all such actions are taken without regard to age, race, creed, color, national origin, ancestry, marital status, affectional or sexual orientation, gender identity or expression, disability, nationality or sex, consistent with the statutes and court decisions of the State of New Jersey, and applicable Federal law and applicable Federal court decisions.

The contractor shall submit to the public agency, after notification of award but prior to execution of a goods and services contract, one of the following three documents:

Letter of Federal Affirmative Action Plan Approval

Certificate of Employee Information Report

Employee Information Report Form AA302 (electronically provided by the Division and distributed to the public agency through the Division's website at [www.state.nj.us/treasury/contract\\_compliance](http://www.state.nj.us/treasury/contract_compliance))

The contractor and its subcontractors shall furnish such reports or other documents to the Division of Purchase & Property, CCAU, EEO Monitoring Program as may be requested by the office from time to time in order to carry out the purposes of these regulations, and public agencies shall furnish such information as may be requested by the Division of Purchase & Property, CCAU, EEO Monitoring Program for conducting a compliance investigation pursuant to Subchapter 10 of the Administrative Code at N.J.A.C. 17:27.

The undersigned vendor certifies on their company's receipt, knowledge and commitment to comply with:

**EXHIBIT A**  
N.J.S.A. 10:5-31 and N.J.A.C. 17:27  
**MANDATORY EQUAL EMPLOYMENT OPPORTUNITY LANGUAGE**  
Goods, Professional Services and General Service Contracts  
(Mandatory Affirmative Action Language)

The undersigned vendor further agrees to furnish the required forms of evidence and

understands that their contract/company's bid shall be rejected as non-responsive if said contractor fails to comply with the requirements of N.J.S.A. 10:5-31 and N.J.A.C. 17:27.

Representative's Name/Title (Print): Vijayant Pawar, Esq. Managing Director

Representative's Signature: \_\_\_\_\_

Name of Company: Pawar, Gilgallon & Rudy, LLC

Tel. No. 973-605-8800 Date: Oct. 26, 2018

# Resolution of the City of Jersey City, N.J.

City Clerk File No. Res. 18-998

Agenda No. 10.Z.13

Approved: \_\_\_\_\_

TITLE:



**RESOLUTION RATIFYING AND RENEWING A PROFESSIONAL SERVICES AGREEMENT WITH PAWAR GILGALLON & RUDY, LLC TO REPRESENT THE CITY OF JERSEY CITY IN THE MATTER OF MEPT JOURNAL SQUARE URBAN RENEWAL LLC, MEPT JOURNAL SQUARE TOWER NORTH URBAN RENEWAL LLC, MEPT JOURNAL SQUARE TOWER SOUTH URBAN RENEWAL LLC V. CITY OF JERSEY CITY ET AL.**

**COUNCIL**  
following resolution:

offered and moved adoption of the

**WHEREAS** on or about May 9, 2009 the City of Jersey City (City) and MEPT Journal Square Urban Renewal LLC, MEPT Journal Square Tower North Urban Renewal, LLC, MEPT Journal Square Tower South Urban Renewal, LLC (collectively "MEPT") entered into certain financial agreements for tax abatements on certain properties to be developed by MEPT; and

**WHEREAS**, upon execution of the financial agreements, the City required MEPT to make a lump sum prepayment of \$2,000,000 based on the estimated calculation of one year of the annual service charges for the subject properties; and

**WHEREAS**, MEPT paid the City \$2,000,000; and

**WHEREAS**, MEPT also paid \$710,769 towards the Affordable Housing Trust Fund contribution; and

**WHEREAS**, in April 2015, MEPT requested that the City refund the monies previously paid that are identified above in an amount totaling \$2,710,769 to MEPT; and

**WHEREAS**, by Order dated October 4, 2016, the court granted MEPT's motion for a declaratory judgment and ordered the City to pay the total sum of \$2,710,769 to MEPT; and

**WHEREAS**, Corporation Counsel recommended the appointment of outside counsel to represent the City of Jersey City; and

**WHEREAS**, Resolution 17-234, approved on March 8, 2017, awarded a one year professional services contract in the amount of \$50,000 effective August 24, 2016 to Pawar Gilgallon & Rudy, LLC; and

**WHEREAS**, Resolution 17-687, approved on August 16, 2017, awarded a one year professional services contract in the amount of \$50,000 effective August 24, 2017 to Pawar Gilgallon & Rudy, LLC; and

**WHEREAS**, Resolution 18-357, approved on April 11, 2018, awarded an increase in funds of \$25,000, increasing funds to for a total contract amount of \$75,000.00; and

**WHEREAS**, the City awarded the contract to Pawar Gilgallon & Rudy, LLC under the "fair and open process" of the Pay-to-Play Law, N.J.S.A. 19:44A-20.4 et. seq. (Pay-to-Play Law); and

**WHEREAS**, Pawar Gilgallon & Rudy, LLC has submitted its Certification of Compliance with the City's Contractor Pay-to-Play Reform Ordinance 08-128 adopted on September 3, 2008; and

**WHEREAS**, N.J.S.A. 40A:11-15 limits the term of a professional services contract to twelve months and requires professional services contracts to be renewed on an annual basis; and

**WHEREAS**, the lawsuit is still ongoing and it is necessary to ratify the renewal of the contract effective August 24, 2018 and to increase the contract amount by an additional \$75,000.00; and

**WHEREAS**, an encumbrance in the amount of \$10,000 is available in **Account No. 18-01-201-23-210-312**; and

**WHEREAS**, the resolution authorizing the award and the agreement itself must be available for public inspection.

TITLE:

**RESOLUTION RATIFYING AND RENEWING A PROFESSIONAL SERVICES AGREEMENT WITH PAWAR GILGALLON & RUDY, LLC TO REPRESENT THE CITY OF JERSEY CITY IN THE MATTER OF MEPT JOURNAL SQUARE URBAN RENEWAL LLC, MEPT JOURNAL SQUARE TOWER NORTH URBAN RENEWAL LLC, MEPT JOURNAL SQUARE TOWER SOUTH URBAN RENEWAL LLC V. CITY OF JERSEY CITY ET AL.**

**NOW, THEREFORE, BE IT RESOLVED** by the Municipal Council of the City of Jersey City that:

1. The agreement with the law firm of Pawar Gilgallon & Rudy, LLC is hereby ratified and reauthorized for one year effective August 24, 2018 for a total contract amount of \$75,000.00; and
2. This agreement is awarded without competitive bidding as a professional services agreement under the Local Public Contracts Law, N.J.S.A. 40A:11-5 (1)(a)(i) et seq.;
3. The award of this contract shall be subject to the condition that Pawar Gilgallon & Rudy, LLC provides satisfactory evidence of compliance with the Affirmative Action Amendments to the Law against Discrimination, N.J.S.A. 10:5-31 et seq.;
4. The Mayor or Business Administrator is hereby authorized to execute the renewal agreement in substantially the form attached subject to such modification as the Corporation Counsel deems appropriate or necessary.
5. A copy of this resolution will be published in a newspaper of general circulation in the City of Jersey City as required by law within (10) days of the adoption of the resolution; and
6. The Certification of Compliance with the City's Contractor Pay-to-Play Reform Ordinance, attached hereto, and shall be placed on file with this resolution.
7. Pursuant to N.J.A.C. 5:30-5.5(c), the continuation of the contract after the expenditure of funds encumbered in the 2018 fiscal year budget shall be subject the encumbrancy of funds in the 2019 fiscal year budget.

I, Donna Mauer, Chief Financial Officer, hereby certify that there are sufficient funds available in Account No.: 18-01-201-23-210-312 for payment of this resolution. P.O. No.

*JMcK  
10/24/18*

\_\_\_\_\_  
Donna Mauer, Chief Financial Officer

*DP  
10/05/2018*

APPROVED: \_\_\_\_\_

APPROVED AS TO LEGAL FORM

APPROVED: \_\_\_\_\_

Business Administrator

\_\_\_\_\_  
Corporation Counsel

Certification Required

Not Required

**APPROVED**

RECORD OF COUNCIL VOTE ON FINAL PASSAGE <b>11-7-18</b>											
COUNCILPERSON	AYE	NAY	N.V.	COUNCILPERSON	AYE	NAY	N.V.	COUNCILPERSON	AYE	NAY	N.V.
RIDLEY				YUN				RIVERA			
PRINZ-AREY				SOLOMON				WATTERMAN			
BOGGIANO				ROBINSON				LAVARRO, PRES.			

✓ Indicates Vote

N.V.-Not Voting (Abstain)

Adopted at a meeting of the Municipal Council of the City of Jersey City N.J.

**RESOLUTION FACT SHEET - CONTRACT AWARD**

This summary sheet is to be attached to the front of any resolution that is submitted for Council consideration. Incomplete or vague fact sheets will be returned with the resolution.

**Full Title of Ordinance/Resolution**

**RESOLUTION RATIFYING AND RENEWING A PROFESSIONAL SERVICES AGREEMENT WITH PAWAR GILGALLON & RUDY, LLC TO REPRESENT THE CITY OF JERSEY CITY IN THE MATTER OF MEPT JOURNAL SQUARE URBAN RENEWAL LLC, MEPT JOURNAL SQUARE TOWER NORTH URBAN RENEWAL LLC, MEPT JOURNAL SQUARE TOWER SOUTH URBAN RENEWAL LLC V. CITY OF JERSEY CITY ET AL.**

**Project Manager**

Department/Division	Law	Law
Name/Title	Peter Baker	Corporation Counsel
Phone/email	201-547-4667	Pbaker@jcnj.org

Note: Project Manager must be available by phone during agenda meeting (Wednesday prior to council meeting @ 4:00 p.m.)

**Contract Purpose**

Renewal of a professional services agreement for an additional twelve (12) months.

**Cost (Identify all sources and amounts)**

Risk Management  
01-201-23-210-312

**Contract term (include all proposed renewals)**

One year effective August 24, 2018.

**Type of award**

Fair/Open

**If "Other Exception", enter type**

**Additional Information**

**I certify that all the facts presented herein are accurate.**

  
Signature of Department Director

10/30/18  
Date

## Outside Counsel Agreement

This Agreement dated the \_\_\_\_ day of \_\_\_\_\_, 2018 between the City of Jersey City, a municipal corporation, with offices at 280 Grove Street, Jersey City, New Jersey 07302 ("City") and, Pawar, Gilgallon & Rudy, 6 South Street, Suite 201, Morristown, NJ 07960 ("Special Counsel"). The Corporation Counsel of the City of Jersey City has selected Special Counsel to serve as Outside Counsel in connection with *MEPT Journal Square Urban Renewal LLC, et al. v. City of Jersey City, et al.*

In consideration of the mutual promises and covenants set forth herein, the parties agree as follows:

### I. CONFLICTS OF INTEREST

#### **A. Initial Conflicts Check.**

Outside Counsel must be sensitive both to direct conflicts of interest that representation of the City and other clients poses, and to the less direct, but nevertheless serious, conflicts that may arise from the same firm's advocacy, on behalf of other clients, of positions conflicting with important City interests. Prior to Outside Counsel's engagement, Outside Counsel shall carefully review whether any conflicts of either type exist and, if so, bring those conflicts to the attention of the Corporation Counsel. The City shall be promptly informed of and consulted with respect to all potential conflicts. Although issue conflicts may not necessarily result in a disqualification of Outside Counsel, the City shall be consulted before Outside Counsel accepts an engagement that will require the firm to advocate a position that may be adverse to a City legal interest or otherwise prejudicial to the interests of the City. The City in its sole discretion shall, after consultation with Outside Counsel, determine whether an impermissible conflict exists, or whether other circumstances exist that would undermine the public's confidence in representation by Outside Counsel continued.

Outside Counsel's acceptance of an engagement on a matter without written disclosure of any conflicts constitutes Outside Counsel's representation that it has conducted an appropriate conflict check and no conflict exists.

#### **B. City Conflicts.**

The City has a duty to protect the public interest. As part of this responsibility, the City sets policies to ensure that the legal system operates in a manner that safeguards the public's confidence in the integrity and impartiality of its administration. For this reason, in addition to

insisting that its attorneys follow the Rules of Professional Conduct, the City prohibits Outside Counsel that represent the City, while such matter is pending, from:

- (1) Representing private parties before the City or any of its boards, proceedings, commissions or autonomous agencies in adversarial, transactional or non-adversarial proceedings. Outside Counsel also may not, on behalf of a private client, lobby the City or any City department.
- (2) Representing private parties in any matter in which the City also is a party, if the private party has interests adverse to the City.
- (3) Representing a private client with interests adverse to the City.
- (4) Representing another client if that representation would present a substantial risk that Outside Counsel's responsibilities to the City would limit its ability to provide independent advice or diligent and competent representation either to the City or the other client.
- (5) Representing another client where the Outside Counsel's knowledge of the City's legal positions or strategy, derived from its representation or prospective representation of the City, could be used to the advantage of the other client or the disadvantage of the City.

**C. Continuing Obligation.**

The obligation to disclose conflicts continues throughout the course of the representation. Outside Counsel must review conflicts of interest on an ongoing basis as new matters are opened. Any new attorney/client relationships that potentially create a conflict shall be reported to the Corporation Counsel immediately.

**D. Attorney-Client Privilege Group/No Representation of Other Persons/Entities Absent Approval.**

Outside attorneys engaged to represent the City (as opposed to a named person) shall consider themselves to have formed an attorney-client relationship *only* with the City, and not any of its individual employees. When speaking with current or former employees of the City, Outside Counsel shall, as appropriate, advise those employees that although their dialogue will be considered attorney-client communications to the fullest possible extent, counsel's responsibility is to the City and they do not represent those employees in their individual capacities. As a matter proceeds, if employees of the City will be examined under oath or interviewed in other adverse contexts, and if Outside Counsel believe it advisable for them to represent the employees in their individual capacities at such events, Outside Counsel must obtain the Corporation Counsel's advance consent before agreeing to represent such persons in their individual capacities. The Corporation Counsel, in consultation with other City personnel, will determine if it is appropriate for the individual to receive representation and, if so, by whom.

Outside Counsel who are engaged to represent both an entity and employees of that entity simultaneously shall take all necessary steps to ensure the continuing absence of conflicts, and to preserve their ability to continue representing the entity in the event that conflicts develop between the entity and individual clients.

## **II. WORKING RELATIONSHIP**

### **A. Identification of Objectives/Relationship Attorney.**

The Corporation Counsel or his designee will be Outside Counsel's principal and regular point of contact for financial and strategic decisions. Only the Corporation Counsel or his designee has authority to direct Outside Counsel in the handling of the matter. If a City employee other than the Corporation Counsel or his designee asks Outside Counsel to proceed in a certain fashion or to perform certain activities with respect to a specific legal matter, Outside Counsel shall report the request to the Corporation Counsel and obtain direction prior to proceeding.

Outside counsel shall designate an Attorney to be the Corporation Counsel's principal contact. In all matters, the City remains ultimately responsible for making all substantive decisions and determining the costs and benefits of contemplated legal activity. In many matters, City attorneys will act as full co-counsel and be engaged with Outside Counsel in the day-to-day conduct of the case. In matters where Outside Counsel is handling that day-to-day conduct without City personnel as co-counsel, the City shall be consulted on a regular basis throughout the course of Outside Counsel's engagement and to be kept fully informed of the current status and proposed course of the matters assigned to Outside Counsel's firm. All strategic, tactical, staffing (including any proposed staffing changes) and significant resource allocation decisions about City legal matters must be made in collaboration with the Corporation Counsel.

### **B. Early Case Assessment/Cost Assessment.**

Each complex matter is to be thoroughly evaluated at its outset. The same applies to actions in which the City is the plaintiff, except that the analysis will be performed before the case is filed. In any matter, Outside Counsel shall provide an early case assessment that includes analysis of (1) likely costs to the City from the process, (2) possible outcomes, indicating the likelihood of each, and (3) strategy and tactics for termination or resolution. The format of the early case assessment may vary from a formal written document to a verbal briefing or a combination of a written budget with a verbal briefing on other aspects of the case.

Please note that time spent preparing a budget is not billable, but counsel may bill for time spent preparing an early case assessment or a recommended discovery plan.

The City places significant reliance on cost estimates and Outside Counsel shall prepare them with care. Although the City understands that unanticipated events may have an impact on costs, the City shall be consulted promptly if Outside Counsel believes that the most recent cost estimate provided is no longer accurate. Should total fees or costs exceed the agreed budget, or should fees or costs for a phase of the case exceed the agreed estimate for that phase, without adequate explanation in advance that the increased expense will be necessary, the City may require that an increased discount be applied to unanticipated fees or costs and reserves the right not to pay Outside Counsel for any amounts incurred or expended in excess of the approved budget or estimate.

For bond matters and other transactional engagements, counsel may be expected to provide a fee cap for the transaction, approved by the City, prior to commencing work. Only where a transaction materially changes in scope will the City consider revisions to an agreed fee cap. No payments above the agreed fee cap shall be made unless and until a revised fee cap has been approved in writing by the Director of the City or his/her designee.

**C. Staffing.**

Unless otherwise agreed, the senior attorney retained shall be directly and ultimately responsible for the entire assignment. The day-to-day involvement of that senior attorney, however, shall be appropriate to the magnitude of the matter and the efficiency required for a timely, cost effective, quality work product. When a senior attorney can handle an assignment most efficiently (based on skill and experience), that senior attorney shall complete the assignment.

The City shall be billed for only one attorney to attend events such as depositions, witness meetings, settlement conferences, negotiations and meetings with other parties' counsel. The City recognizes that in more complex matters and those with multiple work-streams, it may occasionally be appropriate for multiple attorneys to attend significant events and for members of the team to consult with each other. The City insists, however, that no more than the minimum number of attorneys necessary to an event attend, that billable internal conferences and charges for drafting and reading internal email correspondence occur only when absolutely required, and that the Corporation Counsel be regularly informed both of the number of attorneys who will attend significant events and the reason for the attendance of each billing timekeeper.

The City believes that it is most efficient for a single attorney or group of attorneys to handle a matter from beginning to end and Outside Counsel shall strive for such continuity. The City will not pay for learning time that may result from staffing changes at Outside Counsel's firm. In addition, the City will not reimburse Outside Counsel for any routine training or supervisory time, including time spent at seminars, unless specifically approved in advance and included as part of the budget. The City will not ordinarily pay for summer associate time unless such time has been identified as part of the approved staffing plan for appropriate work. The City will not pay for time submitted by librarians; secretaries; billing, filing, docketing or document clerks; internal messengers/couriers; temporary or clerical support staff; word processors; and IT



professionals other than electronic discovery specialists serving a function similar to that of paralegals/case managers. The City also will not pay for time billed by attorneys or paralegals to perform tasks (filing, indexing, etc.) that could and should have been handled by support personnel.

**D. Settlement.**

Outside Counsel shall have no settlement authority unless and until such authority is explicitly conferred on them by the Corporation Counsel. If Outside Counsel believes that settlement should be pursued, Outside Counsel must seek instructions in this regard from the Corporation Counsel, and not pursue formal or informal settlement discussions without the Corporation Counsel's approval. Outside Counsel shall immediately inform the Corporation Counsel of any settlement proposal or overture, formal or informal, by the opposing party or counsel. Please note that under no circumstances can the City agree to designate a settlement agreement as confidential. All City settlement records are, by definition, public documents.

**E. Media Relations/Law Firm Advertising.**

The City does not authorize outside counsel or vendors to comment publicly in any manner on any aspect of the City's legal matters. All media inquiries relating to the City shall be referred promptly to the Corporation Counsel and discussed with the Corporation Counsel before responding to the media contact in any manner. This includes even "no comment" or other non-substantive responses. If time is of the essence and Outside Counsel cannot reach the Corporation Counsel, the Press Secretary in the Office of the Mayor shall be contacted.

The City does not permit Outside Counsel to advertise or promote their relationship with the City, other than by listing the City as a representative client.

**F. Engagement of E-Discovery and Other Vendors, Including Experts.**

Before engaging any vendor, including electronic discovery firms and experts, lobbyists or other consultants (in each case, a "vendor"), Outside Counsel must pre-clear that engagement with the Corporation Counsel, unless the Corporation Counsel has explicitly granted exceptions to this preclearance requirement. The City will not be responsible for vendor fees or costs unless that vendor's engagement was pre-approved by the City. The City may require Outside Counsel to engage vendors with which the City has master contracts or preferred pricing arrangements, and always will insist on engagement of the lowest-cost vendor qualified to handle a task (understanding that complex tasks may require vendors with specialized expertise).

Outside Counsel will pay all third-party service providers directly and will bill the City for those services' detailed disbursements included in monthly invoices. This City will not accept separate invoices from service providers directly to the City for payment.

Outside Counsel has the responsibility to ensure that there are no conflicts between any vendor and the City. In addition, all vendors must execute the confidentiality agreement attached as Appendix A. The fee and disbursement policies as outlined in this Agreement shall be made available to, and followed by vendors. It is Outside Counsel's responsibility to confirm that all third party billings comply with this Agreement.

Vendor payment arrangements shall be discussed in advance with the Corporation Counsel. In general, Outside Counsel shall contract with vendors themselves and pay the third party invoices directly, incorporating those invoices into their own bills to the City and including appropriate detail for reasonable review by City personnel. The City may request Outside Counsel to provide full copies of vendor invoices; Outside Counsel therefore shall retain those invoices in accordance with IRS guidelines. The Corporation Counsel may approve other payment arrangements, including (in rare cases) direct contracting with and payment by the City.

When engaging court reporting services, Outside Counsel shall request only one transcript (electronic or hard copy). The City will not reimburse charges for additional transcripts.

**G. Adherence to Ethical Standards.**

The City conducts itself in accordance with the highest ethical standards and expects the same of its Outside Counsel. No City employee ever has authority to instruct Outside Counsel to act in an unethical manner. If Outside Counsel believes that a City employee has engaged or will engage in illegal or unethical activity, Outside Counsel must immediately advise the Corporation Counsel. The City will terminate its relationship with any Outside Counsel who, in the City's sole discretion, fails to adhere to the foregoing ethical standards.

At all times, Outside Counsel will remain aware of and in compliance with each of the City's "Pay-to-Play" ordinances and any amendments thereto.

**H. Gratuities.**

City officers and employees are prohibited from accepting any gift, favor, service or other thing of value related in any way to the City officer's or employee's public duties. In addition, any vendor to the City is prohibited from offering a gift or other thing of value to a City officer or employee with which the vendor transacts business or offers to transact business. Any City officer or employee is prohibited from soliciting a gift or thing of value from a City vendor. This includes charitable donations made in the name of a City employee.

The City reserves the right to amend this Agreement from time to time, providing written notification to Outside Counsel within thirty (30) days of the effective date of any substantive changes. Failure to accept amendments may result in the termination of services from the City.

**I. Malpractice Insurance.**

Outside Counsel representing the City shall maintain malpractice insurance coverage that is reasonable and prudent in relation to the types and sizes of matters handled. Outside Counsel shall, upon request, promptly provide the Corporation Counsel with copies of any applicable policies required under this section, and/or a certificate of insurance. Each policy provided must be certified by the agent or underwriter to be a true copy. If Outside Counsel does not have coverage or if coverage is cancelled and not immediately replaced with comparable coverage, Outside Counsel must immediately report this to the Corporation Counsel.

**J. File Retention.**

For Litigated Matters: Outside Counsel shall retain pleadings, correspondence, discovery materials, deposition transcripts and similar documents and work product for a period of no less than seven (7) years from the date the matter is concluded or for the time period specified by rule or law in the jurisdiction in which the matter was pending, whichever is longer. Beyond this period, Outside Counsel shall notify the City in writing no less than sixty (60) days prior to destroying any file. Along with the written notification, Outside Counsel shall submit an inventory of any original City documents contained in the file to be destroyed and a representation that any electronic version of the file will also be destroyed or deleted.

For Bond and Other Transactions, and Advice Matters: Documents shall be retained in accordance with the same policies applicable to litigated matters unless applicable law mandates any longer retention schedule. However, bond counsel and transactional/advice counsel shall retain all transcripts of transactions and memoranda of advice indefinitely unless otherwise directed by the Corporation Counsel.

**III. Billing**

**A. Rates.**

Outside Counsel shall be compensated at the rate of \$150.00 per hour, including expenses. The total amount of this agreement shall not exceed \$75,000.

The City will pay for actual services rendered at rates established in Requests for Qualifications or otherwise agreed to in advance. At the time of Outside Counsel's initial engagement, Outside Counsel shall furnish the Corporation Counsel with a schedule of billing rates for partners, associates and all other timekeepers expected to bill time against the matter for review and approval prior to billing time to the City. Because of City procurement rules, the rates applicable at the inception of each specific matter must remain in effect for the duration of that matter.

Hourly rates shall include all overhead costs (*see* Acceptable Fees/Charges, below), none of which shall be included in disbursements.

Time must be billed in 0.1 hour increments and on a per-task basis. The time entry description must be specific, detailing the action taken and the subject matter. Absent prior consent, the City will not pay for more than ten (10) hours of time by a single timekeeper in a single day, but the Corporation Counsel may increase that number of permissible hours in matters of special urgency or where cases are in or approaching trial.

Outside Counsel shall bear in mind that invoices may be disclosed pursuant to the City's open records laws and that courts may not sustain assertions of privilege by the City. Although the City will endeavor to redact privileged information before releasing bills for public consumption, Outside Counsel shall, to the extent practicable and consistent with the need to fully inform the City of its activities and to allow the City to evaluate the reasonableness of billing narratives, avoid the inclusion of privileged matter in invoices.

**B. Invoicing Policy.**

All invoices must be submitted to the Corporation Counsel.

For litigation, advice, and non-bond transactional matters, Outside Counsel generally are expected to submit monthly invoices within thirty days of the conclusion of the billing period, absent the City's prior consent to a longer delay. All charges must reflect the work performed within the billing period or a reasonable time before the billing period. Absent good cause, as defined by the City, the City will not pay for services or expenses incurred more than 90 days prior to the date the invoice is submitted. For bond matters, Outside Counsel are expected to submit their invoice within thirty days of the conclusion of the transaction.

Absent a specific agreement to an alternative fee arrangement, Outside Counsel fees shall be computed by applying the negotiated hourly rate to the time for the services expended. Hours shown must accurately reflect the time spent on the described activity and must either be the exact amount of time or the exact time rounded down to the nearest one-tenth of an hour. Block billing—grouping multiple activities under a single time charge—will not be accepted, and the City will not pay for any time recorded in a block fashion unless this requirement is waived by the Director of the City of Law or his or her designee.

Every bill from Outside Counsel is deemed to be a certification by the firm and billing partner that all legal services and disbursements reflected on the bill are reasonable for the legal matter involved and necessary for the proper provision of legal services to the City. The City may deduct certain fees and charges that are inconsistent with this Agreement.

The City reserves the right to audit all fee and disbursement details that Outside Counsel submit, as well as the corresponding legal file. The City will promptly terminate the services of any

Outside Counsel whose billing practices raise questions about the Outside Counsel's integrity, honesty or compliance with the applicable rules of professional conduct or this Agreement.

**C. Invoice Format.**

Each invoice will include the following minimum requirements:

- Unique invoice number
- Invoice date
- Matter name
- Outside Counsel's matter number
- Date(s) services were performed
- Timekeeper name or ID
- Timekeeper title or level
- A narrative description of the services provided or tasks performed for each specific task. The description shall clearly state the nature of the task performed sufficient to allow the City to determine why it was necessary. Incomplete or vague charge descriptions are unacceptable. Examples of incomplete or vague charges include, but are not limited to: 'analysis', 'review file,' 'conference', 'attention to matter'; 'worked on discovery', 'work on file', 'prepare for meeting', 'misc.', and 'other'
- Time entry to the nearest tenth (.10) of an hour
- Timekeeper rate
- Charge total
- Detail of reimbursable expenses and disbursements at actual cost

The detailed billing report from Outside Counsel's system will provide this information. If Outside Counsel provides services on more than one matter during a billing period, a separate invoice for each matter is required.

**D. Acceptable Fees/Charges.**

**Overhead charges may not be billed.** The City will not reimburse Outside Counsel for basic support services, which the City deems to be part of Outside Counsel's overhead and built into its rates. The City will not pay for any of the following items under any circumstances:

- Billing inquiries
- Opening and closing files
- Internal filing
- Secretarial services (including overtime charges)
- Word processing or proofreading
- Maintenance of a calendar or tickler system
- Investigating potential conflicts
- Preparing budgets

- Library usage (including book purchases or subscriptions) or library staff time
- Office supplies
- Conference room charges

**E. Basic legal research may not be billed.**

Outside Counsel shall be familiar with the basic substantive law at issue in the matter for which the firm was retained, and the City shall not be charged for this type of research. If legal research benefits other clients, only the proportionate share of that cost shall be billed to the City. The City shall also benefit from previously prepared briefs and memoranda, and when such briefs or memoranda exist, will pay only for actual time spent updating or tailoring the same. All other anticipated legal research shall be addressed in Outside Counsel's proposed budget. Legal research projects necessary in a particular litigation assignment must be approved in advance by the Corporation Counsel before the research is commenced.

The City will pay only for the actual time spent by Outside Counsel or other approved timekeeper conducting the research. As explained *infra*, fees charged by electronic or other research services, including library fees, Westlaw, Lexis and other online services are considered general overhead and are not reimbursable.

**F. Out-of-pocket costs must be itemized and passed through with no markup.**

The City will reimburse Outside Counsel for reasonable, documented and itemized out-of-pocket disbursements and costs incurred on behalf of the City, with the exceptions and limitations set forth in this Agreement. Outside Counsel's invoices to the City shall reflect the actual cost and shall not include any markup. All disbursements must be fully itemized with a description sufficient for review, identifying the number of units, price per unit and total cost. The City may refuse to pay for disbursements billed as 'miscellaneous,' billed in a group (e.g., Travel Expenses - \$4,000.00) or disbursements without descriptions.

**G. Prohibited disbursements.**

The City considers certain disbursements to be part of a law firm's overhead and will not pay such charges. These items include:

- Rent (including temporary office space)
- Westlaw, Lexis and other legal database services
- Cost or usage of computers or mobile devices or internet service charges
- Equipment rental
- Storage charges
- Catering for internal meetings
- Meals (except during business travel, and then limited to \$70 per day)
- Mileage for short trips (<30 miles one way)

- Travel costs exceeding discounted, non-refundable coach fares except where excess costs have been approved in advance
- Telephone charges
- Facsimile charges
- Allocated charges from a firm's blanket service agreements with outside vendors

**H. Copying/scanning.**

Copying charges may be billed to the City at the lesser of the most favorable rate applied by Outside Counsel or five cents per page. The City will reimburse for document scanning at Outside Counsel firm's regular rate, up to a maximum of five cents per page, for document productions, but the City will not pay time charges associated with scanning, and there shall be no charges associated with the scanning and filing of court papers and correspondence. Every effort shall be made to minimize scanning expenses by working with documents in electronic format whenever possible.

**I. Couriers and Overnight Mail.**

The City will reimburse for actual charges billed to Outside Counsel for deliveries (including overnight express) that are necessary in the interest of speed and reliability. Outside Counsel shall use the lowest cost service consistent with need and reliability, and to arrange schedules, whenever practicable, to avoid the need for premium-priced couriers. Outside Counsel shall use less expensive means, such as email (encrypted, when necessary) or regular mail where it is practical to do so.

**J. Travel Expenses.**

All air and rail travel must be first approved by the Corporation Counsel, ideally as part of the case budget. Outside Counsel shall use good judgment in selecting hotels and restaurants and incurring expenses for which the taxpayers are to be charged. Outside Counsel shall use alternatives to travel such as conference calls or videoconferences whenever practicable. If the travel involves another client, the City may be billed only for its proportionate share of both time and related expenses. **Non-working travel time is not billable without the Corporation Counsel's prior approval.**

**K. Reimbursement of Meals for Overnight Travel.**

The City will reimburse for meals consumed while traveling overnight on City business, but limited (absent prior approval) to no more than seventy dollars (\$70) per person, per day. Under no circumstances will the City reimburse costs for alcoholic beverages.

**L. Maintenance of Expense Records.**

To ensure compliance with the City's reimbursement policies, Outside Counsel shall require itemization of out-of-pocket expenses such as airline tickets, meals and hotel bills before making reimbursement to any attorney, employee or third party, and maintain original receipts. Travel and meal expenses and receipts may be audited and shall be retained by Outside Counsel in accordance with applicable IRS guidelines. Unless requested to do so by the City, Outside Counsel shall not forward copies of travel and meal expense receipts to the City with the firm's invoices.

**M. Personal Expenses Not Reimbursable.**

Please take care to distinguish between personal expenses and properly chargeable business expenses. The City will not reimburse for, among other things, recreation fees, salon or spa charges, pay-per-view movies or other personal entertainment charges, airline baggage charges, travel agency expenses, shoe shines, toiletries, dry cleaning or laundry (except in the unlikely event travel of more than seven days' duration is required), or luggage.

**N. Vendor discounts must be passed through.**

If Outside Counsel receives a discount or rebate from a vendor based on the aggregate level of business with that vendor, such discount shall be disclosed and the City shall receive the benefit on a proportionate basis. This does not include frequent-flyer miles or similar perquisites allocated to individual travelers.

**IV. COMPLIANCE WITH AFFIRMATIVE ACTION PLAN**

(a) If the Agreement exceeds \$40,000.00, it shall be subject to the Affirmative Action Amendments to the Law Against Discrimination, N.J.S.A. 10:5-31 et seq.

(b) This Agreement shall not become effective and Contractor shall provide no services under this Agreement until it has executed the following documents:

1. A supplemental Affirmative Action Agreement pursuant to N.J.S.A. 10:5-31 et seq. (for contracts which exceed \$40,000.00). The Affirmative Action Agreement is attached hereto as Exhibit "B" and is incorporated herein by reference.

2. An Affirmative Action Employee Information Report (form AA-302) (for contracts which exceed \$40,000.00).



## **V. CITY OF JERSEY CITY LOBBYIST DISCLOSURE ORDINANCE**

This contract was awarded in accordance with the provisions of the City's Disclosure of Lobbyist Representative Status Ordinance §3-9.1 *et seq.* adopted on June 12, 2002. As such the undersigned does hereby attest that Contractor either did not retain the services of a lobbyist to lobby on behalf of the Contractor for the award of this contract, or if a lobbyist was retained by the Contractor for such purposes, the Contractor's lobbyist, prior to commencing his/her lobbying activities, filed a notice of lobbyist representative status form with the City Clerk. Any Contractor whose lobbyist failed to comply with the provisions of Ordinance §3-9.1 *et seq.*, following notice and an opportunity to be heard, shall be disqualified from entering into contracts with the City for a period of two (2) years for each violation.

## **VI. CONFIDENTIALITY**

In the course of representing the City, Outside Counsel will frequently gain access to nonpublic and confidential information. The City requires Outside Counsel to maintain the confidentiality of such information both during and after the course of Outside Counsel's representation of the City. Outside Counsel must have in place appropriate procedures to ensure the protection of all such information. In the event the representation requires Outside Counsel to become privy to protected personally-identifiable information about any person, such as health or financial records, Social Security numbers or other such information, then this information must be handled with the utmost care both within facilities in Outside Counsel's control, and certainly when that information is being transported. Under no circumstances shall such confidential information be transported outside Outside Counsel's offices--either physically or over the public internet--unless the information is appropriately encrypted. In the event information is compromised or potentially compromised, Outside Counsel must notify the City immediately.

Outside Counsel must follow all statutory, regulatory, and ethical provisions relating to privacy, confidentiality and nondisclosure of all privileged, proprietary and confidential information. Outside Counsel must take appropriate measures to ensure that all legal and nonlegal personnel are familiar with this requirement and are effectively supervised in this regard.

Vendors to whom Outside Counsel gives access to confidential or proprietary material of the City (including work product) must sign the confidentiality agreement attached as Appendix A. It is the responsibility of Outside Counsel to obtain a signed confidentiality agreement from each vendor and to retain those agreements.

This Confidentiality Section, and the corresponding Confidentiality Agreement attached as Appendix A, is above and beyond any relationships or privileges held or created separate and apart from this Agreement.

## **VII. NEW JERSEY BUSINESS REGISTRATION REQUIREMENTS**

Outside Counsel shall provide written notice to its subcontractors of the responsibility to submit proof of business registration to the contractor.

Before final payment on the contract is made by the contracting agency, the contractor shall submit an accurate list and the proof of business registration of each subcontractor or supplier used in the fulfillment of the contract, or shall attest that no subcontractors were used.

For the term of the contract, the contractor and each of its affiliates and a subcontractor and each of its affiliates [N.J.S.A. 52:32-44(g)(3)] shall collect and remit to the Director, New Jersey Division of Taxation, the use tax due pursuant to the Sales and Use Tax Act on all sales of tangible personal property delivered into this State, regardless of whether the tangible personal property is intended for a contract with a contracting agency.

A business organization that fails to provide a copy of a business registration as required pursuant to section 1 of P.L.2001, c.134 (C.52:32-44 et al.) or subsection e. or f. of section 92 of P.L.1977, c.110 (C.5:12-92), or that provides false business registration information under the requirements of either of those sections, shall be liable for a penalty of \$25 for each day of violation, not to exceed \$50,000 for each business registration copy not properly provided under a contract with a contracting agency.

#### **VIII. TERMINATION**

The City reserves the right to terminate the within Agreement at any time for any reason whatsoever, in which event Outside Counsel shall be paid for services due up to the date of termination. Thereafter, this Agreement shall be considered null and void with no further rights or obligations emanating therefrom. Unless sooner terminated or renewed, this contract shall be for a term of one (1) year commencing on the date the contract is executed by City officials.

#### **IX. GENERAL TERMS**

##### **A. Governing Law/Jurisdiction.**

This Agreement will be interpreted in accordance with, and governed by, the laws of the State of New Jersey. The courts of the State of New Jersey will have exclusive jurisdiction and the parties irrevocably attorney to the jurisdiction of such courts.

##### **B. Counterparts Clause.**

This Agreement may be executed by e-mail in counterparts all of which will be deemed originals and legally binding once delivered to each of the other parties' authorized e-mail addresses and such delivery is acknowledged by reply e-mail. Although not necessary to legally bind the parties, each party agrees to promptly circulate signed originals in sufficient number to the other parties for record-keeping

purposes after completing the e-mail execution and delivery. All counterparts when executed and delivered (by e-mail or in paper form) will be construed together to be an original and will constitute one and the same agreement.

By accepting an engagement by the City, law firms will be deemed to have familiarized themselves with this agreement and to have agreed to adhere to it in all respects, now and as they may be amended from time to time upon written notice and acceptance. This acceptance is a matter both of contract and professional responsibility.

**Attest:**

**City of Jersey City**

\_\_\_\_\_  
**Robert Byrne**  
**City Clerk**

\_\_\_\_\_  
**Brian Platt**  
**Business Administrator**

**WITNESS:**

**Pawar Gilgallon & Rudy, LLC**

\_\_\_\_\_

\_\_\_\_\_  
By:  
Firm:

## APPENDIX A

### CONFIDENTIALITY AGREEMENT

\_\_\_\_\_ (Subcontractor), as a contractor of Outside Counsel retained by the City of Jersey City (the "City") pursuant to an "Outside Counsel Agreement" dated \_\_\_\_\_, hereby acknowledges and agrees as follows:

1. All documents and data, including but not limited to financial, statistical, personnel, customer and/or technical documents, owned or supplied by the City to the Subcontractor, shall be treated as confidential (Documents and Data). The Subcontractor shall take all necessary and reasonable precautions to ensure that the City's Documents and Data are safeguarded. Use of the Documents and Data is strictly limited to that use necessary to complete the scope of work agreed upon, which may include disclosure to employees, officers or agents of any subcontractor assisting with the scope of work. Any other use, and any sale or offering of the Documents and Data in any form by the Subcontractor, or any individual or entity in the Subcontractor's charge or employ, will be considered a violation of this Confidentiality Agreement and may result in termination of the agreement between Subcontractor and the law firm retained by the City, and the Subcontractor's suspension or debarment from City contracting. In addition, such conduct may be reported to the appropriate authorities for possible criminal prosecution.
2. Subcontractor shall be responsible to ensure that all agents and individuals or entities in the Subcontractor's charge or employ adhere to this Confidentiality Agreement. A breach of confidentiality by any individual or entity in the Subcontractor's charge or employ will be considered a violation of this Confidentiality Agreement by the Subcontractor.
3. In the event that Subcontractor, its agent or any individual or entity in the Subcontractor's charge or employ receives a subpoena, demand, or other request for any of the City's documents or data, Subcontractor shall promptly notify the City and shall not turn over any of the City's documents or data.
4. The Subcontractor shall comply with all applicable City and Federal laws that require the notification of individuals in the event of unauthorized release of personally-identifiable information or other event requiring notification. In the event of a breach of any of the Subcontractor's confidentiality obligations or other event requiring notification under applicable law ("Notification Event"), the Subcontractor agrees to assume responsibility for informing all such individuals in accordance with applicable law and to indemnify, hold harmless and defend the City and its trustees, officers, and employees from and against any claims, damages, or other harm related to such Notification Event.
5. Upon termination of this Confidentiality Agreement the Subcontractor shall return or erase, destroy, and render unreadable all Subcontractor copies of City Documents and Data, both physical and electronic, and certify in writing that these actions have been completed within 30 days of the termination of this Confidentiality Agreement or within 14 days of the request of an agent of the City, whichever shall come first.

6. This Confidentiality Agreement shall survive the Subcontractor's termination of the contract between the law firm retained by the City and Subcontractor or upon completion of the scope of work related to the City.

Subcontractor/Firm: \_\_\_\_\_

By: \_\_\_\_\_

Title: \_\_\_\_\_

Date: \_\_\_\_\_

(REVISED 4/13)

**EXHIBIT A**  
**MANDATORY EQUAL EMPLOYMENT OPPORTUNITY LANGUAGE**  
**N.J.S.A. 10:5-31 et seq. (P.L. 1975, C. 127)**  
**N.J.A.C. 17:27**

**GOODS, PROFESSIONAL SERVICE AND GENERAL SERVICE CONTRACTS**

During the performance of this contract, the contractor agrees as follows:

The contractor or subcontractor, where applicable, will not discriminate against any employee or applicant for employment because of age, race, creed, color, national origin, ancestry, marital status, affectional or sexual orientation, gender identity or expression, disability, nationality or sex. Except with respect to affectional or sexual orientation and gender identity or expression, the contractor will ensure that equal employment opportunity is afforded to such applicants in recruitment and employment, and that employees are treated during employment, without regard to their age, race, creed, color, national origin, ancestry, marital status, affectional or sexual orientation, gender identity or expression, disability, nationality or sex. Such equal employment opportunity shall include, but not be limited to the following: employment, upgrading, demotion, or transfer; recruitment or recruitment advertising; layoff or termination; rates of pay or other forms of compensation; and selection for training, including apprenticeship. The contractor agrees to post in conspicuous places, available to employees and applicants for employment, notices to be provided by the Public Agency Compliance Officer setting forth provisions of this nondiscrimination clause.

The contractor or subcontractor, where applicable will, in all solicitations or advertisements for employees placed by or on behalf of the contractor, state that all qualified applicants will receive consideration for employment without regard to age, race, creed, color, national origin, ancestry, marital status, affectional or sexual orientation, gender identity or expression, disability, nationality or sex.

The contractor or subcontractor will send to each labor union, with which it has a collective bargaining agreement, a notice, to be provided by the agency contracting officer, advising the labor union of the contractor's commitments under this chapter and shall post copies of the notice in conspicuous places available to employees and applicants for employment.

The contractor or subcontractor, where applicable, agrees to comply with any regulations promulgated by the Treasurer pursuant to N.J.S.A. 10:5-31 et seq., as amended and supplemented from time to time and the Americans with Disabilities Act.

The contractor or subcontractor agrees to make good faith efforts to meet targeted county employment goals established in accordance with N.J.A.C. 17:27-5.2.

**EXHIBIT A (Continuation)**

The contractor or subcontractor agrees to inform in writing its appropriate recruitment agencies including, but not limited to, employment agencies, placement bureaus, colleges, universities, and labor unions, that it does not discriminate on the basis of age, race, creed, color, national origin, ancestry, marital status, affectional or sexual orientation, gender identity or expression, disability, nationality or sex, and that it will discontinue the use of any recruitment agency which engages in direct or indirect discriminatory practices.

The contractor or subcontractor agrees to revise any of its testing procedures, if necessary, to assure that all personnel testing conforms with the principles of job-related testing, as established by the statutes and court decisions of the State of New Jersey and as established by applicable Federal law and applicable Federal court decisions.

In conforming with the targeted employment goals, the contractor or subcontractor agrees to review all procedures relating to transfer, upgrading, downgrading and layoff to ensure that all such actions are taken without regard to age, race, creed, color, national origin, ancestry, marital status, affectional or sexual orientation, gender identity or expression, disability, nationality or sex, consistent with the statutes and court decisions of the State of New Jersey, and applicable Federal law and applicable Federal court decisions.

The contractor shall submit to the public agency, after notification of award but prior to execution of a goods and services contract, one of the following three documents:

Letter of Federal Affirmative Action Plan Approval

Certificate of Employee Information Report

Employee Information Report Form AA302 (electronically provided by the Division and distributed to the public agency through the Division's website at [www.state.nj.us/treasury/contract\\_compliance](http://www.state.nj.us/treasury/contract_compliance))

The contractor and its subcontractors shall furnish such reports or other documents to the Division of Purchase & Property, CCAU, EEO Monitoring Program as may be requested by the office from time to time in order to carry out the purposes of these regulations, and public agencies shall furnish such information as may be requested by the Division of Purchase & Property, CCAU, EEO Monitoring Program for conducting a compliance investigation pursuant to Subchapter 10 of the Administrative Code at N.J.A.C. 17:27.

The undersigned vendor certifies on their company's receipt, knowledge and commitment to comply with:

**EXHIBIT A**  
N.J.S.A. 10:5-31 and N.J.A.C. 17:27  
**MANDATORY EQUAL EMPLOYMENT OPPORTUNITY LANGUAGE**  
Goods, Professional Services and General Services Contracts  
(Mandatory Affirmative Action Language)

The undersigned vendor further agrees to furnish the required forms of evidence and

understands that their contract/company's bid shall be rejected as non-responsive if said contractor fails to comply with the requirements of N.J.S.A. 10:5-31 and N.J.A.C. 17:27.

Representative's Name/Title (Print): Vijayant Pawar, Esq. Managing Director

Representative's Signature: 

Name of Company: Pawar, Critgallon & Rudy, LLC

Tel. No. 973-605-8800

Date: Oct. 26, 2018

**APPENDIX A**  
**AMERICANS WITH DISABILITIES ACT OF 1990**  
Equal Opportunity for Individuals with Disability

The contractor and the Managing Member of Pawar, Gilgallon & Rudy, LLC (hereafter "owner") do hereby agree that the provisions of Title I of the Americans With Disabilities Act of 1990 (the "Act") (42 U.S.C. 5121 01 et seq.), which prohibits discrimination on the basis of disability by public entities in all services, programs, and activities provided or made available by public entities, and the rules and regulations promulgated pursuant thereto, are made a part of this contract. In providing any aid, benefit, or service on behalf of the owner pursuant to this contract, the contractor agrees that the performance shall be in strict compliance with the Act. In the event that the contractor, its agents, servants, employees, or subcontractors violate or are alleged to have violated the Act during the performance of this contract, the contractor shall defend the owner in any action or administrative proceeding commenced pursuant to this Act. The contractor shall indemnify, protect, and save harmless the owner, its agents, servants, and employees from and against any and all suits, claims, losses, demands, or damages, of whatever kind or nature, arising out of or claimed to arise out of the alleged violation. The contractor shall, at its own expense, appear, defend, and pay any and all charges for legal services and any and all costs and other expenses arising from such action or administrative proceeding or incurred in connection therewith. In any and all complaints brought pursuant to the owner's grievance procedure, the contractor agrees to abide by any decision of the owner which is rendered pursuant to said grievance procedure. If any action or administrative proceeding results in an award of damages against the owner, or if the owner incurs any expense to cure a violation of the ADA which has been brought pursuant to its grievance procedure, the contractor shall satisfy and discharge the same at its own expense.

The owner shall, as soon as practicable after a claim has been made against it, give written notice thereof to the contractor along with full and complete particulars of the claim. If any action or administrative proceeding is brought against the owner or any of its agents, servants, and employees, the owner shall expeditiously forward or have forwarded to the contractor every demand, complaint, notice, summons, pleading, or other process received by the owner or its representatives.

It is expressly agreed and understood that any approval by the owner of the services provided by the contractor pursuant to this contract will not relieve the contractor of the obligation to comply with the Act and to defend, indemnify, protect, and save harmless the owner pursuant to this paragraph.

It is further agreed and understood that the owner assumes no obligation to indemnify or save harmless the contractor, its agents, servants, employees and subcontractors for any claim which may arise out of their performance of this Agreement. Furthermore, the contractor expressly understands and agrees that the provisions of this indemnification clause shall in no way limit the contractor's obligations assumed in this Agreement, nor shall they be construed to relieve the contractor from any liability, nor preclude the owner from taking any other actions available to it under any other provisions of the Agreement or otherwise at law.

Representative's Name/Title Print: Vijayant Pawar, Managing MEMBER  
Representative's Signature: \_\_\_\_\_  
Name of Company: Pawar, Gilgallon & Rudy  
Tel. No.: 973-605-8800 Date: Oct. 26, 2018



**CERTIFICATION OF COMPLIANCE WITH THE CITY OF JERSEY CITY  
CONTRACTOR PAY-TO-PLAY REFORM ORDINANCE 08-128 ADOPTED  
ON SEPTEMBER 3, 2008**

**PART I - Vendor Affirmation:**

The undersigned, being authorized and knowledgeable of the circumstances, does hereby certify that Pawar, Gilgallon & Rudy, LLC (name of business entity) has not made any reportable contributions in the \*\*one-year period preceding \_\_\_\_\_ (date City Council awards contract) that would be deemed to be violations of Section One of the City of Jersey City's Contractor Pay-to-Play Reform Ordinance 08-128 (attached hereto) and that would bar the award of this contract. I further certify that during the term of the contract Pawar, Gilgallon & Rudy, LLC (name of business entity) will not make any reportable contributions in violation of Ordinance 08-128.

**PART II - Signature and Attestation:**

The undersigned is fully aware that if I have misrepresented in whole or part this affirmation and certification, I and/or the business entity, will be liable for any penalty permitted under law.

Name of Business Entity: Pawar, Gilgallon & Rudy, LLC

Signed: [Signature] Title: Managing Member

Print Name: Vijayant Pawar, Esq. Date: Oct 26, 2018

Subscribed and sworn before me  
this 26 day of October, 2018.  
My Commission expires:

[Signature]

\_\_\_\_\_  
(Affiant)  
Maria Apgar  
(Print name & title of affiant) (Corporate Seal)

MARIA APGAR  
NOTARY PUBLIC  
STATE OF NEW JERSEY  
MY COMMISSION EXPIRES FEB. 22, 2021

**\*\*Pursuant to Section 2 of Ordinance 08-128, no contributions or solicitation of contributions made prior to the effective date Ordinance 08-128 (September 23, 2008) shall be deemed to be a violation of the Ordinance.**

Minority/Woman Business Enterprise (MWBE)  
Questionnaire for Bidders.

Jersey City Ordinance C-829 establishes a goal of awarding 20% of the dollar amount of total city procurement to minority and woman owned business enterprises.

To assist us in monitoring our achievement of this goal, please indicate below whether your company is or is not a minority owned and/or woman owned business, and return this form with your bid proposal.

Business Name: Pawar, Gilgallon & Rudy, LLC.  
Address: 6 South Street, Suite 201  
MORRISTOWN, NJ 07960  
Telephone No.: 973-605-8800  
Contact Name: Vijayant Pawar, Esq.

Please check applicable category:

Minority Owned Business (MBE)

Minority & Woman Owned Business (MWBE)

Woman Owned business (WBE)

Neither

**Definitions**

**Minority Business Enterprise**

Minority Business Enterprise means a business which is a sole proprietorship, partnership or corporation at least 51% of which is owned and controlled by persons who are African American, Hispanic, Asian American, American Indian or Alaskan native, defined as follows:

**African American:** a person having origins in any of the black racial groups of Africa

**Hispanic:** a person of Mexican, Puerto Rican, Central or South American or other non-European Spanish culture or origin regardless of race.

**Asian:** a person having origins in any of the original peoples of the Far East, South East Asia, Indian subcontinent, Hawaii or the Pacific Islands.

**American Indian or Alaskan Native:** a person having origins in any of the original peoples of North America and who maintains cultural identification through tribal affiliation or community recognition.

**Woman Business Enterprise**

Woman Business Enterprise means a business which is a sole proprietorship, partnership or corporation at least 51% of which is owned and controlled by a woman or women.

DIVISION OF PURCHASING COPY

Minority/Woman Business Enterprise (MWBE)  
Questionnaire for Bidders

Jersey City Ordinance C-829 establishes a goal of awarding 20% of the dollar amount of total city procurement to minority and woman owned business enterprises.

To assist us in monitoring our achievement of this goal, please indicate below whether your company is or is not a minority owned and/or woman owned business, and return this form with your bid proposal.

Business Name : Pawar, Gilgallon & Rudy, LLC  
Address : 6 South Street, Suite 201  
MORRISTOWN, NJ 07960  
Telephone No. : 973-605-8800  
Contact Name : Vijayant Pawar, Esq.

Please check applicable category :

Minority Owned Business (MBE)       Minority & Woman Owned Business (MWBE)  
 Woman Owned business (WBE)       Neither

**Definitions**

**Minority Business Enterprise**

Minority Business Enterprise means a business which is a sole proprietorship, partnership or corporation at least 51% of which is owned and controlled by persons who are African American, Hispanic, Asian American, American Indian or Alaskan native, defined as follows:

**African American:** a person having origins in any of the black racial groups of Africa

**Hispanic:** a person of Mexican, Puerto Rican, Central or South American or other non-European Spanish culture or origin regardless of race.

**Asian:** a person having origins in any of the original peoples of the Far East, South East Asia, Indian subcontinent, Hawaii or the Pacific Islands.

**American Indian or Alaskan Native:** a person having origins in any of the original peoples of North America and who maintains cultural identification through tribal affiliation or community recognition.

**Woman Business Enterprise**

Woman Business Enterprise means a business which is a sole proprietorship, partnership or corporation at least 51% of which is owned and controlled by a woman or women.

OFFICE OF EQUAL OPPORTUNITY COPY

**BUSINESS ENTITY DISCLOSURE CERTIFICATION  
FOR NON-FAIR AND OPEN CONTRACTS  
Required Pursuant To N.J.S.A. 19:44A-20.8  
CITY OF JERSEY CITY**

**Part I - Vendor Affirmation**

The undersigned, being authorized and knowledgeable of the circumstances, does hereby certify that the <name of business entity> has not made and will not make any reportable contributions pursuant to N.J.S.A. 19:44A-1 et seq. that, pursuant to P.L. 2004, c. 19 would bar the award of this contract in the one year period preceding (date of award scheduled for approval of the contract by the governing body) to any of the following named candidate committee, joint candidates committee, or political party committee representing the elected officials of the <name of entity of elected officials> as defined pursuant to N.J.S.A. 19:44A-3(p), (q) and (r).

Steven Fulop for Mayor 2017	Mira Prinz-Arey for Council
Lavatto for Councilman	Friends of Richard Boggiano
Friends of Joyce Watterman	Michael Yum for Council
Friends of Daniel Rivera	Solomon for Council
Ridley for Council	Friends of Jermaine Robinson

**Part II - Ownership Disclosure Certification**

I certify that the list below contains the names and home addresses of all owners holding 10% or more of the issued and outstanding stock of the undersigned.

Check the box that represents the type of business entity:

- Partnership   
  Corporation   
  Sole Proprietorship   
  Subchapter S Corporation  
 Limited Partnership   
 Limited Liability Corporation   
 Limited Liability Partnership

Name of Stock or Shareholder	Home Address
Vijayant Pawar, Esq.	7 Randolph Drive, MORRISTOWN, NJ
Craig S. Gilgallon, Esq.	64 Spring Brook Road, MORRISTOWN, NJ
Robert S. Rudy, Esq.	41 MT. REMBLE AVENUE, MORRISTOWN, NJ

**Part 3 - Signature and Attestation:**

The undersigned is fully aware that if I have misrepresented in whole or part this affirmation and certification, I and/or the business entity, will be liable for any penalty permitted under law.

Name of Business Entity: Pawar, Gilgallon & Rudy, LLC  
 Signature of Affiant: [Signature] Title: Managing MEMBER  
 Printed Name of Affiant: Vijayant Pawar, Esq. Date: Oct. 26, 2018

Subscribed and sworn before me this 26 day of October, 2018.

My Commission expires:

MARIA APGAR  
 NOTARY PUBLIC  
 STATE OF NEW JERSEY  
 MY COMMISSION EXPIRES FEB. 22, 2021

[Signature]  
 (Witnessed or attested by)  
 \_\_\_\_\_  
 (Seal)

Certification 50189

### CERTIFICATE OF EMPLOYEE INFORMATION REPORT

**INITIAL**

This is to certify that the contractor listed below has submitted an Employee Information Report pursuant to N.J.A.C. 17:27-1.1 et. seq. and the State Treasurer has approved said report. This approval will remain in effect for the period of ~~15 FEB 2019~~ ~~10~~ ~~15 FEB 2020~~

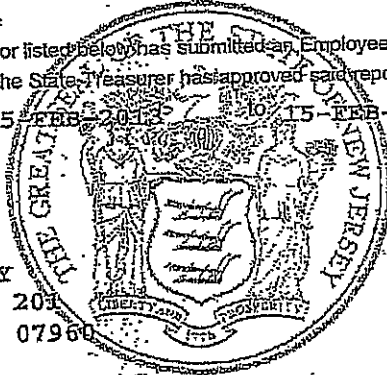

PAWAR GILGALLON & RUDY  
6 SOUTH STREET, SUITE 201  
MORRISTOWN NJ 07960

A handwritten signature in black ink, appearing to read "Andrew P. Sidamon-Eristoff".

Andrew P. Sidamon-Eristoff  
State Treasurer



## STATE OF NEW JERSEY BUSINESS REGISTRATION CERTIFICATE

<b>Taxpayer Name:</b>	PAWAR GILGALLON & RUDY, LLC
<b>Trade Name:</b>	
<b>Address:</b>	6 SOUTH STREET, SUITE 201 MORRISTOWN, NJ 07960
<b>Certificate Number:</b>	1740913
<b>Effective Date:</b>	September 06, 2012
<b>Date of Issuance:</b>	November 27, 2012

**For Office Use Only:**  
20121127124333717

# C. 271 POLITICAL CONTRIBUTION DISCLOSURE FORM

## Contractor Instructions

Business entities (contractors) receiving contracts from a public agency that are NOT awarded pursuant to a "fair and open" process (defined at N.J.S.A. 19:44A-20.7) are subject to the provisions of P.L. 2005, c. 271, s.2 (N.J.S.A. 19:44A-20.26). This law provides that 10 days prior to the award of such a contract, the contractor shall disclose contributions to:

- any State, county, or municipal committee of a political party
- any legislative leadership committee
- any continuing political committee (a.k.a., political action committee)
- any candidate committee of a candidate for, or holder of, an elective office:
  - of the public entity awarding the contract
  - of that county in which that public entity is located
  - of another public entity within that county
  - or of a legislative district in which that public entity is located or, when the public entity is a county, of any legislative district which includes all or part of the county

The disclosure must list reportable contributions to any of the committees that exceed \$300 per election cycle that were made during the 12 months prior to award of the contract. See N.J.S.A. 19:44A-8 and 19:44A-16 for more details on reportable contributions.

N.J.S.A. 19:44A-20.26 itemizes the parties from whom contributions must be disclosed when a business entity is not a natural person. This includes the following:

- individuals with an "interest" ownership or control of more than 10% of the profits or assets of a business entity or 10% of the stock in the case of a business entity that is a corporation for profit
- all principals, partners, officers, or directors of the business entity or their spouses
- any subsidiaries directly or indirectly controlled by the business entity
- IRS Code Section 527 New Jersey based organizations, directly or indirectly controlled by the business entity and filing as continuing political committees, (PACs).

When the business entity is a natural person, "a contribution by that person's spouse or child, residing therewith, shall be deemed to be a contribution by the business entity." [N.J.S.A. 19:44A-20.26(b)] The contributor must be listed on the disclosure.

Any business entity that fails to comply with the disclosure provisions shall be subject to a fine imposed by ELBC in an amount to be determined by the Commission which may be based upon the amount that the business entity failed to report.

The enclosed list of agencies is provided to assist the contractor in identifying those public agencies whose elected official and/or candidate campaign committees are affected by the disclosure requirement. It is the contractor's responsibility to identify the specific committees to which contributions may have been made and need to be disclosed. The disclosed information may exceed the minimum requirement.

The enclosed form, a content-consistent facsimile, or an electronic data file containing the required details (along with a signed cover sheet) may be used as the contractor's submission and is disclosable to the public under the Open Public Records Act.

The contractor must also complete the attached Stockholder Disclosure Certification. This will assist the agency in meeting its obligations under the law. **NOTE: This section does not apply to Board of Education contracts.**

<sup>1</sup> N.J.S.A. 19:44A-3(s): "The term "legislative leadership committee" means a committee established, authorized to be established, or designated by the President of the Senate, the Minority Leader of the Senate, the Speaker of the General Assembly or the Minority Leader of the General Assembly pursuant to section 16 of P.L.1993, c.65 (C.19:44A-10.1) for the purpose of receiving contributions and making expenditures."





# Resolution of the City of Jersey City, N.J.

City Clerk File No. Res. 18-999  
 Agenda No. 10.Z.14  
 Approved: NOV 07 2018



**TITLE:** RESOLUTION OF THE MUNICIPAL COUNCIL OF THE CITY OF JERSEY CITY AUTHORIZING PROGRAM CONTRACTS FOR SUMMER YOUTH PROGRAMS UNDER THE COMMUNITY DEVELOPMENT BLOCK GRANT - PUBLIC SERVICES (CDBG) FOR PROGRAM YEAR APRIL 1, 2017 THROUGH MARCH 31, 2018

COUNCIL offered and moved adoption of the following resolution:

WHEREAS, the United States Department of Housing and Urban Development (HUD) has awarded the City of Jersey City \$5,034,144 in Community Development Block Grant (CDBG) funds for Fiscal Year 2017; and

WHEREAS, as noted in resolution number 17-800 approved on October 11, 2017, the City reserved \$100,000 in CDBG - Public Services funds for summer youth programs; and

WHEREAS, the Division of Community Development (DCD) issued a request for proposals (RFPs) for summer youth programs that are designed to address summer youth recreation and youth development programs; and

WHEREAS, the DCD received proposals in response to the RFP and has recommended projects for funding based on need and capacity of the organization to expend funds by the October 31, 2018 deadline.

NOW, THEREFORE, BE IT RESOLVED, by the Municipal Council of the City of Jersey City, that the Mayor or Business Administrator is hereby authorized to enter into contracts under the Community Development Block Grant - Public Services program as noted below.

Vendor	Project	Amount	Account No.	P.O. No.
Educational Arts Team	Camp Liberty Safe Summer Scholarship Program	\$ 10,000.00	59-200-56-851-519	130582
Haven Adolescent Community Respite Center	Cook. Eat. Talk. Program	\$ 3,000.00	59-200-56-851-519	130583
Jersey Art Exchange	Youth Development Summer Program	\$ 5,000.00	59-200-56-851-519	130584
Jersey City DPW	Mural Program	\$ 14,000.00	59200-56-851-519	130585
New City Kids, Inc.	City Sail	\$ 12,000.00	59-200-56-851-519	130586
Nimbus Dance Works	Youth Summer Programs & Performance	\$ 10,000.00	59-200-56-851-519	130587
P.A.C.O	Summer Arts Program	\$ 9,000.00	59-200-56-851-519	130588
Team Wilderness, Inc.	Team Wilderness Summer Excursion	\$ 5,000.00	59-200-56-851-519	130589
The Kennedy Dancers	Inner City Youth Summer Dance Camp	\$ 10,000.00	59-200-56-851-519	130590
The Salvation Army	Salvation Army's Summer STEAM Program	\$ 12,000.00	59-200-56-851-519	130591
Urban League of Hudson County	ULOHC Youth Summer Recreation Program	\$ 10,000.00	59-200-56-851-519	130592
<b>TOTAL</b>		<b>\$ 100,000.00</b>		

I, Donna Mauer, hereby certify that sufficient funds in the amount of \$100,000.00 are available in accounts noted above.

Donna Mauer  
 Chief Financial Officer

APPROVED: \_\_\_\_\_

APPROVED AS TO LEGAL FORM \_\_\_\_\_

APPROVED:   
 Business Administrator

Corporation Counsel

JMK  
 10/17/18

Certification Required

Not Required  APPROVED 8-0

RECORD OF COUNCIL VOTE ON FINAL PASSAGE 11.7.18											
COUNCILPERSON	AYE	NAY	N.V.	COUNCILPERSON	AYE	NAY	N.V.	COUNCILPERSON	AYE	NAY	N.V.
RIDLEY	✓			YUN	✓			RIVERA	✓		
PRINZ-AREY	✓			SOLOMON	✓			WATTERMAN		ABSENT	
BOGGIANO	✓			ROBINSON	✓			LAVARRO, PRES.	✓		

✓ Indicates Vote

N.V.-Not Voting (Abstain)

Adopted at a meeting of the Municipal Council of the City of Jersey City N.J.

Bolanjo R. Lavarro, Jr., President of Council

Robert Byrne, City Clerk

**RESOLUTION FACT SHEET - CONTRACT AWARD**

This summary sheet is to be attached to the front of any resolution that is submitted for Council consideration. Incomplete or vague fact sheets will be returned with the resolution.

**Full Title of Ordinance/Resolution**

**RESOLUTION OF THE MUNICIPAL COUNCIL OF THE CITY OF JERSEY CITY  
AUTHORIZING PROGRAM CONTRACTS FOR SUMMER YOUTH PROGRAMS UNDER THE  
COMMUNITY DEVELOPMENT BLOCK GRANT – PUBLIC SERVICES (CDBG) FOR PROGRAM  
YEAR APRIL 1, 2017 THROUGH MARCH 31, 2018**

**Project Manager**

Department/Division	HEDC	COMMUNITY DEVELOPMENT
Name/Title	CARMEN GANDULLA	DIRECTOR
Phone/email	x5304	CGandulla@cnj.org

Note: Project Manager must be available by phone during agenda meeting (Wednesday prior to council meeting @ 4:00 p.m.)

**Contract Purpose**

A portion of the City’s Community Development Block Grant- Public Services (CDBG-PS) funding have been allocated specifically for summer youth programs that will provide summer youth recreation and youth development programs to Jersey City youth. Funded agencies are required to operate from July 1, 2018 through September 30, 2018.

**Cost (Identify all sources and amounts)**

\$100,000.00

**Contract term (include all proposed renewals)**

Grant Term is from April 1, 2017 – March 31, 2018. Summer youth program must operate program from July 1, 2018- Sept. 30, 2018.

Type of award

If “Other Exception”, enter type

**Additional Information**

I certify that all the facts presented herein are accurate.

Signature of Department Director

Date

# Memorandum

**To:** Council President Lavarro, Jr. & Members of the Municipal Council  
**From:** Carmen Gandulla, Director – Division of Community Development  
**Date:** October 9, 2018  
**Subject:** Resolution of the Municipal Council of the City of Jersey City Authorizing Program Contracts for Summer Youth Programs Under The Community Development Block Grant – Public Services (CDBG) For Program Year April 1, 2017 Through March 31, 2018

---

**Synopsis:** The United States Department of Housing and Urban Development (HUD) has awarded the City of Jersey City \$5,034,144 in Community Development Block Grant (CDBG) funds for Fiscal Year 2017. The City reserved \$100,000 in Community Development funds for summer youth programs for the July 1, 2018 through September 30, 2018 Fiscal Year.

**Background:** The Community Development Block Grant – Public Services (CDBG-PS) grant strives to meet a national objective of LMI benefit through the provision of services for low and moderate-income (LMI) persons residing in the City of Jersey City. The CDBG-PS grant covers a wide range of eligible activities including but not limited to employment, educational services, health care services, fair housing services, senior services and summer youth recreational programs.

The summer youth grant is designed for programs that will have a measureable impact on youth during the summer months. Eligible Activities are listed below:

Eligible Activity	Use
Summer Youth Recreation	Projects that involve low-income youth in summer recreational activities (i.e., summer camp, soccer, basketball, dance and music programs...) that will expose youth to experiences that expand beyond the horizons of urban youth, including scholarships for eligible youth.
Youth Development Program	Projects that provide academic enrichment, work and career training and support, including Science, Technology, Engineering, Arts & Mathematics (STEAM) educational programs, and activities that enable young people to develop communication and interpersonal skills.  Projects that demonstrate strong collaborations with educational and cultural assets.

**Recommendation Process:**

1. April 2, 2018, a Request for Proposals (RFP) was published soliciting competitive proposals for services under the CDBG-PS grant. Approximately eighteen (18) applicants submitted proposals
2. A full committee review consisting of site visitation and threshold evaluation of all submitted applications including review of financial audits was completed. The proposal selection process also incorporated Director Reviews and Mayor's Office review.

The Division of Community Development is providing eleven (11) grant recommendations for our Community Development Block Grant Summer Youth allocation.

- Nimbus, Jersey Art Exchange, Jersey City's Department of Public Works, The Kennedy Dancers and PACO are receiving funding for programs which will provide development for youth interested in the study of performing arts through dance, theater and visual creativity;

- Team Wilderness, a new outward bound style program, New City Kids, a sailing program and ULOHC will provide recreational enrichment to students enrolled in Summer Fun camp.
- Haven Adolescent Community Respite Center, a new pilot program will launch a summer enrichment culinary series;
- Educational Arts Team and the Salvation Army will provide academic enrichment for youth during the summer months.

If the Division of Community Development could not make a recommendation for any organization, it was because there were some deficiencies or compliance issues in their applications.



# City Council Replacement Cover Sheet

Submitted By	Maneza M. Ali
Department	Department of Law
Date Submitted	11/05/2018
Pls. note Revisions and Page Number	Added/Modified: modified Term and Honorarium from one year to "two years" term.

# Resolution of the City of Jersey City, N.J.

City Clerk File No. Res. 18-1000

Agenda No. 10.Z.15

Approved: NOV 07 2018

TITLE:



## RESOLUTION CREATING THE FIRST POET LAUREATE OF THE CITY OF JERSEY CITY

**COUNCIL** offered and moved adoption of the following Resolution:

**WHEREAS**, poetry is a powerful form of literature that honors self-expression and promotes understanding within communities; and

**WHEREAS**, poetry has long been used to elicit a range of emotions and sentiments about place and time, culture and society; and

**WHEREAS**, the City of Jersey City has an interest in supporting the vibrant and growing community of poets and expanding opportunities for young writers throughout the region; and

**WHEREAS**, one means of supporting such writers is to create the position of Poet Laureate to serve as a public voice of Jersey City, creating city-specific original work and participating in literary outreach and education; and

**WHEREAS**, the Poet Laureate will serve as Jersey City's literary ambassador at events that promote the literary arts and will nurture appreciation of poetry and literature; and

**WHEREAS**, the Jersey City Arts Council, working through its Literary Arts Committee, evaluates nominations for Poet Laureate for creative excellence and community impact. The Jersey City Arts Council then sends the finalist names and supporting recommendations to the Mayor, who appoint the Poet Laureate with the advice and consent of the Council.

### **NOW, THEREFORE, BE IT RESOLVED,**

1. **Term and Honorarium:** The full terms of service for the Poet Laureate will be memorialized in an agreement between the City and the Poet Laureate.

The term of service will be two years, with an annual honorarium of \$3,000 per year.

2. **Intellectual Property:** All writing, notes and original materials produced during the tenure of the Poet Laureate remain the property of the individual, however, the City shall retain the right to record, publish, compile and display works produced by the Poet Laureate in his or her official capacity during his or her term, but the Poet shall retain all other rights to the work.
3. **Eligibility:** Poet Laureate candidates must be legal residents of Jersey City and at least 21 years old. Nominated poets must have produced work of the highest caliber and must have contributed substantial service to the development of the literary arts.
4. A poet who has served as Poet laureate may not be re-nominated.

City Clerk File No. Res. 18-1000

Agenda No. 10.7.15 NOV 07 2018

TITLE: **RESOLUTION CREATING THE FIRST POET LAUREATE OF THE CITY OF JERSEY CITY**

- 5. The nominee may not be an employee or officeholder for Jersey City, the Jersey City Arts Council, or from the immediate family or household of such employees or officeholders.
- 6. The Mayor may with the approval of the City Council remove the Poet Laureate for misconduct or neglect of duty.

NG/mma  
11/05/2018

APPROVED: \_\_\_\_\_

APPROVED AS TO LEGAL FORM

APPROVED: \_\_\_\_\_

Business Administrator

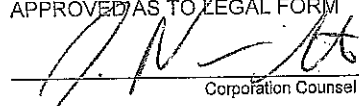

Corporation Counsel

Certification Required

Not Required

**APPROVED 5-3**

RECORD OF COUNCIL VOTE ON FINAL PASSAGE <b>11.7.18</b>											
COUNCILPERSON	AYE	NAY	N.V.	COUNCILPERSON	AYE	NAY	N.V.	COUNCILPERSON	AYE	NAY	N.V.
RIDLEY	✓			YUN	✓			RIVERA	✓		
PRINZ-AREY		✓		SOLOMON		✓		WATTERMAN	ABSENT		
BOGGIANO	✓			ROBINSON		✓		LAVARRO, PRES.	✓		

✓ Indicates Vote

N.V.-Not Voting (Abstain)

Adopted at a meeting of the Municipal Council of the City of Jersey City N.J.

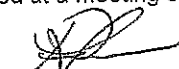
  
\_\_\_\_\_  
Rolando R. Lavarro, Jr., President of Council

  
\_\_\_\_\_  
Robert Byrne, City Clerk



**RESOLUTION FACT SHEET**

This summary sheet is to be attached to the front of any resolution that is submitted for Council consideration. Incomplete or vague fact sheets will be returned with the resolution.

**Full Title of Ordinance/Resolution**

**RESOLUTION CREATING THE FIRST POET LAUREATE OF THE CITY OF JERSEY CITY**

**Initiator**

Department/Division	Business Administration	
Name/Title	Brian Platt	Business Administrator
Phone/email	<a href="mailto:BPlatt@jcnj.org">BPlatt@jcnj.org</a>	201- 547-5147

Note: Initiator must be available by phone during agenda meeting (Wednesday prior to council meeting @ 4:00 p.m.)

**Resolution Purpose**

The purpose of this resolution is to create a position for Poet Laureate of the City of Jersey City.

I certify that all the facts presented herein are accurate.

  
\_\_\_\_\_  
Signature of Department Director

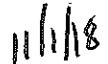
  
\_\_\_\_\_  
Date

# Resolution of the City of Jersey City, N.J.

City Clerk File No. Res. 18-1001  
 Agenda No. 10.7.16  
 Approved: NOV 07 2018  
 TITLE:



**RESOLUTION AUTHORIZING THE DEPARTMENT OF PUBLIC SAFETY, DIVISION OF POLICE TO UTILIZE PROPERTY OWNED BY THE CITY OF JERSEY CITY LOCATED AT 605 MONMOUTH STREET TO CONSTRUCT A FACILITY TO HOUSE THE JERSEY CITY POLICE DEPARTMENT MOUNTED UNIT**

**WHEREAS**, the City of Jersey City owns property located at 605 Monmouth Street Monmouth listed as Block 6902, Lot 24 on the City of Jersey City tax maps; and

**WHEREAS**, the Department of Public Safety, Division of Police wishes to re-establish the Jersey City Police Department Mounted Unit and propose to construct modular facility to house horses and police division personnel; and

**WHEREAS**, the Jersey City Police Department Mounted Police Unit is an efficient and effective method of patrol and will play a vital part in the Jersey City Police Departments modern crime prevention units will be utilized at city sponsored events, park patrols, and other community-oriented events greatly enhancing the City's Community Oriented Policing Program; and

**WHEREAS**, the City of Newark re-established their Mounted Police Unit in 2011 and has offered to assist in the procurement of horses and related training for police officers assigned to this unit at no cost to the City; and

**WHEREAS**, Mounted Unit horses are available free of charge through a program for retired horses.

**NOW, THEREFORE BE IT RESOLVED**, by the Mayor Municipal Council of the City of Jersey City, County of Hudson, New Jersey that the Jersey City Department of Public Safety, Division of Police is authorized to utilize the afore described property to house the Jersey City Police Mounted Unit.

10/18/2018

APPROVED: \_\_\_\_\_ APPROVED AS TO LEGAL FORM  
 \_\_\_\_\_  
 Business Administrator Corporation Counsel

Certification Required   
 Not Required   
**APPROVED 5-3**

RECORD OF COUNCIL VOTE ON FINAL PASSAGE 11.7.18											
COUNCILPERSON	AYE	NAY	N.V.	COUNCILPERSON	AYE	NAY	N.V.	COUNCILPERSON	AYE	NAY	N.V.
RIDLEY	✓			YUN		✓		RIVERA	✓		
PRINZ-AREY	✓			SOLOMON	✓			WATTERMAN	ABSENT		
BOGGIANO	✓			ROBINSON		✓		LAVARRO, PRES.		✓	

✓ Indicates Vote N.V.-Not Voting (Abstain)

Adopted at a meeting of the Municipal Council of the City of Jersey City N.J.  
 \_\_\_\_\_  
 Rolando R. Lavarro, Jr., President of Council Robert Byrne, City Clerk

**RESOLUTION FACT SHEET**

This summary sheet is to be attached to the front of any resolution that is submitted for Council consideration. Incomplete or vague fact sheets will be returned with the resolution.

**Full Title of Ordinance/Resolution**

**RESOLUTION AUTHORIZING THE DEPARTMENT OF PUBLIC SAFETY, DIVISION OF POLICE TO UTILIZE PROPERTY OWNED BY THE CITY OF JERSEY CITY LOCATED AT 605 MONMOUTH STREET TO CONSTRUCT A FACILITY TO HOUSE THE JERSEY CITY POLICE DEPARTMENT MOUNTED UNIT**

**Initiator**

Department/Division	Police	
Name/Title	Tawana Moody	Director
Phone/email	201-547-4239	Tmoody@njeps.org

Note: Initiator must be available by phone during agenda meeting (Wednesday prior to council meeting @ 4:00 p.m.)

**Resolution Purpose**

The purpose of this resolution is to allow Division of Police to utilize property owned by the City of Jersey City.

**I certify that all the facts presented herein are accurate.**

\_\_\_\_\_  
**Signature of Department Director**

\_\_\_\_\_  
**Date**

# Resolution of the City of Jersey City, N.J.

City Clerk File No. Res. 18-1002  
 Agenda No. 10.Z.17  
 Approved: NOV 07 2018  
 TITLE:



## RESOLUTION RE-APPOINTING MARK C. CURTIS AS A PART-TIME JUDGE OF THE JERSEY CITY MUNICIPAL COURT

**COUNCIL OFFERED AND MOVED ADOPTION OF THE FOLLOWING RESOLUTION:**

**WHEREAS**, the Honorable Steven M. Fulop, Mayor of the City of Jersey City, has advised the Municipal Council by letter dated October 31, 2018, that he has re-appointed **Mark C. Curtis** as a **Part-Time Judge of the Municipal Court of the City of Jersey City**, for a term to commence upon adoption of this resolution and expire on November 7, 2021.

**NOW, THEREFORE, BE IT RESOLVED**, that the Municipal Council of the City of Jersey City, hereby consents to the re-appointment of **Mark C. Curtis** as a **Part-Time Judge of the Municipal Court of the City of Jersey City** for the above mentioned term pursuant to N.J.S.A. 2B:12-4(b).

RB:sjg

APPROVED: \_\_\_\_\_

APPROVED AS TO LEGAL FORM

APPROVED: [Signature]  
 Business Administrator

[Signature]  
 Corporation Counsel

Certification Required

Not Required

APPROVED 8-0

RECORD OF COUNCIL VOTE ON FINAL PASSAGE 11.7.18											
COUNCILPERSON	AYE	NAY	N.V.	COUNCILPERSON	AYE	NAY	N.V.	COUNCILPERSON	AYE	NAY	N.V.
RIDLEY	✓			YUN	✓			RIVERA	✓		
PRINZ-AREY	✓			SOLOMON	✓			WATTERMAN	ABSENT		
BOGGIANO	✓			ROBINSON	✓			LAVARRO, PRES.	✓		

✓ Indicates Vote

N.V.-Not Voting (Abstain)

Adopted at a meeting of the Municipal Council of the City of Jersey City N.J.

[Signature]  
 Rolando R. Lavarro, Jr., President of Council

[Signature]  
 Robert Byrne, City Clerk



STEVEN M. FULOP  
MAYOR OF JERSEY CITY

# CITY OF JERSEY CITY

## OFFICE OF THE MAYOR

CITY HALL | 280 GROVE STREET | JERSEY CITY, NJ 07302  
P: 201 547 5500 | F: 201 547 5442



STEVEN M. FULOP  
MAYOR OF JERSEY CITY

October 31, 2018

President and Members of the Municipal Council  
City of Jersey City  
280 Grove Street  
Jersey City, New Jersey 07302

Report of Directors  
8.a  
Meeting 11.07.18

Dear Council President and Members:

Kindly be advised that I have reappointed **Mark C. Curtis**, a resident of Jersey City, New Jersey, to serve as a **Part-Time Judge** of the **Jersey City Municipal Court** pursuant to N.J.S.A 2B:12-4(b). Mr. Curtis's term will commence upon adoption of a resolution and expire on November 7, 2021.

I respectfully request your advice and consent to this appointment.

Sincerely,

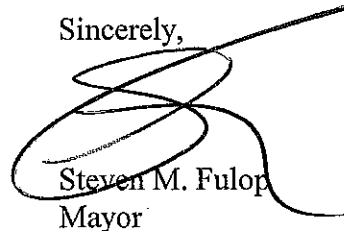

Steven M. Fulop  
Mayor

c: Peter J. Baker, Corporation Counsel  
Brian D. Platt, Business Administrator  
Robert Byrne, City Clerk  
Carlo Abad, Chief Judge, J.C. Municipal Court  
Wendy Razzoli, J.C. Municipal Court  
Allison N. Solowsky, Deputy Chief of Staff  
Nancy Warlikowski, Mayor's Office  
Mark C. Curtis

# Resolution of the City of Jersey City, N.J.

City Clerk File No. Res. 18-1003

Agenda No. 10.Z.18

Approved: NOV 07 2018

TITLE:



## RESOLUTION AUTHORIZING THE AWARD OF A COMPETITIVELY BID CONTRACT TO REMEDY ANALYTICS, INC. FOR AUDITING OF THE PRESCRIPTION DRUG PLAN

### COUNCIL OFFERED AND MOVED ADOPTION OF THE FOLLOWING RESOLUTION

**WHEREAS**, the City of Jersey City ("City") has a need for the auditing of the prescription drug plans; and

**WHEREAS**, the City may acquire these services pursuant to the competitive contracting provisions of N.J.S.A. 40A:11-4.1 et seq; and

**WHEREAS**, a Request for Proposals (RFP) was issued by the Department of Human Resources on July 25, 2018; and

**WHEREAS**, on August 21, 2018, the City received 3 proposals in response to its RFP; and

**WHEREAS**, the evaluation committee appointed by the Business Administrator pursuant to N.J.A.C. 5:34-4.3 reviewed the proposals and prepared the report attached hereto recommending that the contract be awarded to Remedy Analytics, Inc., located at 1011 North Mayfair Road, Suite 307, Milwaukee, WI, 53226; and

**WHEREAS**, the contract term is two (2) years beginning November 1, 2018 and ending October 31, 2020 with an option to renew for one (1) additional year; and

**WHEREAS**, the total amount of the two (2) year contract is \$950,000.00 and the annual amounts of the contract are: year one (1): \$500,000; year two (2): \$450,000 and the one (1) year option would be \$400,000; and

**WHEREAS**, the funds in the amount of \$500,000.00 are available in Account 01-201-23-220-805; and

**NOW, THEREFORE, BE IT RESOLVED**, by the Municipal Council of the City of Jersey City that:

1. Pursuant to N.J.S.A. 40A: 11-4.1 et seq., a contract is awarded to Remedy Analytics, Inc. to audit the City's prescription drug plan;
2. The term of the contract is two (2) years effective November 1, 2018 with the option to renew for one (1) additional year;
3. The total amount of the two (2) year contract is \$950,000.00 and the annual amounts of the contract are: year one (1): \$500,000; year two (2): \$450,000 and the one (1) year option would be \$400,000;
4. Subject to such modifications as deemed necessary or appropriate by Corporation Counsel, the Mayor or Business Administrator is authorized to execute a contract in substantially the form of the attached;

TITLE:

**RESOLUTION AUTHORIZING THE AWARD OF A COMPETITIVELY BID CONTRACT TO REMEDY ANALYTICS, INC. FOR AUDITING OF THE PRESCRIPTION DRUG PLAN**

- 5. The resolution authorizing the award of this contract and contract itself shall be available for public inspection;
- 6. Notice of this action shall be published in a newspaper of general circulation within the municipality within 10 days of this award;
- 7. The award of this contract shall be subject to the condition that Remedy Analytics, Inc. provides satisfactory evidence of compliance with the Affirmative Action Amendments to the Law Against Discrimination, N.J.S.A. 10:5-31 et seq.;
- 8. Upon certification by an official or employee of the City authorized to accept the services pursuant to the contract, that the services have been provided and that the requirements of the contract met, then; payment to the consultant shall be made in accordance with the provisions of the Local Fiscal Affairs Law, N.J.S.A. 40A:5-1 et seq.; and
- 9. Pursuant to N.J.A.C. 5:30-5.5(d)(2), the continuation of the contract after the expenditure of funds encumbered in the 2018 fiscal year budget shall be subject to the availability and appropriation of sufficient funds in subsequent fiscal year budgets.

I, Donna Mauer Donna Mauer, Chief Financial Officer, certify that funds in the amount of \$500,000.00 are available in Account No. 01-201-23-220-805. P.O. # 131257

\_\_\_\_\_  
Peter Folgado, Purchasing Agent  
QPA, RPPO

\_\_\_\_\_  
Date

APPROVED: \_\_\_\_\_

APPROVED AS TO LEGAL FORM

APPROVED: [Signature]  
Business Administrator

[Signature]  
Corporation Counsel

Certification Required

Not Required

**APPROVED 8-0**

RECORD OF COUNCIL VOTE ON FINAL PASSAGE <span style="float: right;">11.7.18</span>											
COUNCILPERSON	AYE	NAY	N.V.	COUNCILPERSON	AYE	NAY	N.V.	COUNCILPERSON	AYE	NAY	N.V.
RIDLEY	✓			YUN	✓			RIVERA	✓		
PRINZ-AREY	✓			SOLOMON	✓			WATTERMAN	ABSENT		
BOGGIANO	✓			ROBINSON	✓			LAVARRO, PRES.	✓		

✓ Indicates Vote

N.V.-Not Voting (Abstain)

Adopted at a meeting of the Municipal Council of the City of Jersey City N.J.

\_\_\_\_\_  
Rolando R. Lavarro, Jr., President of Council

\_\_\_\_\_  
Robert Byrne, City Clerk

**RESOLUTION FACT SHEET - CONTRACT AWARD**

This summary sheet is to be attached to the front of any resolution that is submitted for Council consideration. Incomplete or vague fact sheets will be returned with the resolution.

**Full Title of Ordinance/Resolution**

RESOLUTION AUTHORIZING THE AWARD OF A COMPETITIVELY BID CONTRACT TO REMEDY ANALYTICS, INC. FOR AUDITING OF THE PRESCRIPTION DRUG PLAN

**Project Manager**

Department/Division	HUMAN RESOURCES	HEALTH BENEFITS
Name/Title	MICHALINE YURCIK	SUPERVISING ADMINSTRATIVE ANALYST
Phone/email	547-5515	Myurcik@jcnj.org

Note: Project Manager must be available by phone during agenda meeting (Wednesday prior to council meeting @ 4:00 p.m.)

**Contract Purpose**

To have the contract with the present and future pharmacy benefit managers (PBM), reviewed, audited and monitored for compliance and find any additional savings on claims that would be reimbursed back to the City.

**Cost (Identify all sources and amounts)**

**Contract term (include all proposed renewals)**

Account: 01-201-23-220-805  
\$950,000.00; additional year option:  
\$400,000.00

Two years (November 1, 2018 - October 31, 2020). With an option to renew for an additional year.

Type of award

If "Other Exception", enter type

I certify that all the facts presented herein are accurate.

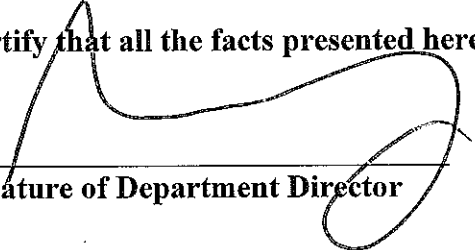
  
Signature of Department Director

11/2/18  
Date



# CITY OF JERSEY CITY

Requisition #

0185818

Assigned PO #

## Requisition

Vendor

**Dept. Bill To**  
HEALTH BENEFITS  
CITY HALL  
280 GROVE ST. ROOM 107  
JERSEY CITY NJ 07302

**Dept. Ship To**  
HEALTH BENEFITS  
CITY HALL  
280 GROVE ST. ROOM 107  
JERSEY CITY NJ 07302

**Contact Info**

Quantity	UOM	Description	Account	Unit Price	Total
1.00	1	AUDITOR OF RX PLAN	01-201-23-220-805	500,000.00	500,000.00
		CONTRACT FOR THE AUDITING OF THE PRESCRIPTION DRUG PLAN TWO (2) YEAR CONTRACT FROM: NOVEMBER 1, 2018 TO OCTOBER 31, 2020; WITH ONE (1) YEAR OPTION TO RENEW FOR: \$400,000.00 TOTAL CONTRACT AMOUNT: \$950,000.00 AMOUNT TO BE ENCUMBERED: \$500,000.00			
		PPV			

**Requisition Total 500,000.00**

Req. Date: 10/29/2018

Requested By: MICHALNE

Buyer Id:

Approved By: \_\_\_\_\_

**This Is Not A Purchase Order**

## Executive Summary

On August 21, 2018, the City received three proposals in response to its RFP for Auditing and Analytics Consulting for the City's Prescription Drug Plans. The actual rankings of the proposals appear below:

The proposals were scored by an evaluation Committee consisting of two City of Jersey City Division of Human Resources employees and one outside consultant using criteria established by the evaluation Committee.

Vendor	Ranking
Remedy Analytics	1
Milliman	2
PillarRx	3

The proposal submitted by Remedy Analytics was ranked highest by the evaluation Committee. The cost of services proposed is fifteen percent of savings resulting from audits of 100% of prescription drug claims in contract years one, two and three. Total fees paid to the vendor are a percentage of documented savings and may not exceed \$500,000 in year one, \$450,000 in year two, and \$400,000 in year three.

In accordance with the statutes for competitive contracting (N.J.S.A. 40A:11 - 4.1 et seq), it is recommended that a contract be awarded to Remedy Analytics to provide prescription drug plan auditing and analytics services to the City.

## **Background**

Competitive contracting (N.J.S.A. 40A:11- 4.1 et seq) was employed to solicit proposals that would attract the best qualified solutions. On August 17, 2018 the City received three responses to the original Request for Proposals and the initial evaluation process was started.

The RFP as issued on July 30, 2018 is contained in Appendix A.

## **PROJECT OBJECTIVES**

The City of Jersey City, NJ (the “City”) requested proposals from qualified technology audit firms reduce its pharmacy benefit costs for the City employees and retirees through electronic audit and analysis of 100% of the City’s prescription drug claims

## **SCOPE OF SERVICES**

The successful respondent will audit every prescription drug claim incurred by individuals covered under the City’s employee and retiree prescription drug plan to ensure compliance with pharmacy benefit manager (PBM) contract definitions and will collect recoveries from the contracted PBM of any overpayments made by the City to the PBM.

The successful Consultant will develop and implement PBM contract terms and definitions along with general contract language.

The successful consultant will employ their technology to optimize the performance of the City's PBM.

The chosen firm must be able to provide consulting services which analyze and audit 100% of plan’s claims data to provide the City with data-driven solutions to reduce costs, create efficiencies and improve clinical outcomes – all measured for accountability and fiduciary compliance.

## **Evaluation Criteria and Evaluation Process**

As indicated above, competitive contracting was used in order to produce an RFP which would provide the City with exactly (or nearly exactly) the services required. In addition, given the expected complexity of the responses, a consistent evaluation format was developed to ensure that a balance comparison of proposals could be conducted.

Thirteen criteria listed below were established by which proposals were evaluated. Each criterion was worth between 0 and 5 points. The extent to which the criterion is met or exceeded by each respondent was determined by the evaluation Committee’s analysis of each respondent’s submission and the appropriate scoring between zero and five was applied to each criterion for each respondent. Total maximum of 65 points could be awarded.

## Criteria

1. Does respondent understand the project requirements?
2. Does response include 100% claims audit utilizing claims repricing at a prescription level?
3. Does response include audit of average whole price (AWP) and ingredient cost guarantees (including specialty medications) in accordance with contract terms?
4. Does response include 100% rebate guarantee audit in accordance with contract terms?
5. Does response include complete audit recovery negotiation with PBM?
6. Does response include PBM contract development and language negotiation?
7. Does response include analysis of PBM RFP responses?
8. Is respondent pricing for services based on a percentage of savings as requested?
9. Additional Audit compliance tests?
10. Does response include comprehensive utilization analytics?
11. Staffing - Actuarial?
12. Qualifications and Experience
13. Client References

## Evaluation Committee

The evaluation Committee consisted of 2 employees and one outside consultant with experience in employee benefits and prescription drug plans. The members of the Committee included:

- Mark A. Bunbury, Esq., Director of Human Resources, City of Jersey City
- Michaline Yurcik, Director of Health Benefits, City of Jersey City
- Jay McManus, Benefits Consultant

Appendix B contains each Committee member's Certification of Non-Conflict of Interest, as required by the competitive contracting statutes.

## Proposals Received

A total of three proposals were received in response to the City's RFP. They are listed alphabetically below with the proposed costs over the three-year contract period:

Milliman – Cost proposal: Year 1 - \$265,000, Year 2- \$125,000, Year 3-\$118,000. Respondent did not price audit services as a percentage of savings. The costs above are fixed costs.

RillarRx - Cost proposal: Year 1 - \$106,000. Respondent did not price as a percentage of savings. The costs above are fixed costs. Respondent did not specify a price for year 2 and year 3.

Remedy Analytics – Cost proposal: Year 1 - 15% of savings, Year 2 - 15% of savings, Year 3 - 15% of savings, not to exceed \$500,000 Year 1, \$450,000 Year 2, and \$400,000 Year 3.

## Evaluation Process

The evaluation process consisted of the following steps:

- Committee meeting to discuss preliminary impressions and to address technical questions
- Final review of proposals and submission of evaluation matrix

## Evaluation Results

The rankings and total scores out of a maximum 65 assigned by the Committee appear below:

Vendor	Score	Ranking
Remedy Analytics	57	1
Milliman	51	2
PillarRx	47	3

The detailed evaluation spreadsheets prepared by the Committee appear in Appendix C.

## Appendix A: RFP



CITY OF JERSEY CITY  
REQUEST FOR PROPOSALS:

Audit Analytics Consulting  
Prescription Drug Plan

SUBMISSION DEADLINE:  
11:00 AM  
Thursday, August 21, 2018

ADDRESS ALL PROPOSALS TO:  
Peter Folgado  
Director of Purchasing,  
Department of Administration  
Division of Purchasing  
394 Central Avenue, 3<sup>rd</sup> Fl.  
Jersey City, New Jersey 07306

## SECTION 1: GENERAL INFORMATION & SUMMARY

1.1 Organization Requesting Proposal  
City of Jersey City/Dept. of Human Resources  
Division of Health Benefits  
City Hall  
280 Grove Street  
Jersey City, NJ 07302

1.2 Contact Person  
Peter Folgado  
Director of Purchasing, QPA  
Department of Administration  
Division of Purchasing  
394 Central Avenue, 3<sup>rd</sup> Fl.  
Jersey City, New Jersey  
(201) 547-5156  
(201) 547-6586 (fax)  
[PeterF@icnj.org](mailto:PeterF@icnj.org)

### 1.3 Procurement Process

This contract will be awarded using the competitive contracting provision of the Local Public Contracts Law (N.J.S.A. 40A:11-4.1 *et seq.*) which is considered a "fair and open" process under the "New Jersey Local Unit Pay-to-Play" Law, N.J.S.A. 19:44A-20.4 *et seq.*

Proposals will be evaluated in accordance with the criteria set forth in this Request for Proposals (RFP). The governing body will approve a resolution awarding a contract to the successful Respondent.

### 1.4 Contract Form

If selected to provide services, it is agreed and understood that the successful Respondent shall be bound by the requirements and terms contained in this RFP with regard to services performed, payments, indemnification, insurance, termination, and applicable licensing provisions.

It is also agreed and understood that the acceptance of the final payment by Contractor shall be considered a release in full of all claims against the City of Jersey City (City) arising out of, or by reason of, the work done and materials furnished under this Contract.



1.5 Informational meeting

There will not be an informational meeting for this RFP.

1.6 Submission deadline

Proposals must be submitted to, and be received by the Division of Purchasing, via mail or hand delivery, by 11:00 a.m. prevailing time on Thursday, August 21, 2018. Proposals will not be accepted by facsimile transmission or e-mail.

1.7 Opening of proposals

Proposals shall be opened in public at 11:00 a.m. prevailing time on Tuesday, August 21, 2018 in the Division of Purchasing Conference Room, located on the 3rd floor of 394 Central Avenue, Jersey City, NJ.

1.8 Definitions

The following definitions shall apply to and are used in this Request for Proposal (RFP):

"City"- refers to the City of Jersey City.

"RFP" - refers to this Request for Proposals, including any amendments thereof or supplements thereto.

"Respondent" or "Respondents"- refers to the interested persons and/or firm(s) that submit a Proposal.

"Competitive Contracting" - refers to the process by which proposals are evaluated and contracts awarded, pursuant to N.J.S.A. 40A:11-4.1 et seq.

"Consultant" or "Consultants"- refers to the interested persons and/or firm(s) that submit a Proposal.

1.9 Submission address

All proposals should be sent to:

Peter Folgado  
Director of Purchasing, QPA  
Jersey City Department of Administration  
Division of Purchasing  
394 Central Avenue, 3<sup>rd</sup> Fl.  
Jersey City, New Jersey 07306

## SECTION 2: INTRODUCTION AND GENERAL INFORMATION

### 2.1 Introduction and Purpose

The City is seeking proposals from qualified Consultants for services as described herein.

### 2.2 Competitive Contracting

This contract will be awarded using the competitive contracting provisions of the Local Public Contracts Law (N.J.S.A. 40A:11-4.1 *et seq.*) which is considered a "fair and open" process under the "New Jersey Local Unit Pay-to-Play" Law, N.J.S.A. 19:44A-20.4 *et seq.*

The City has structured a procurement process that seeks to obtain the desired services, while establishing a competitive environment to assure that each person and/or firm is provided an equal opportunity to submit a proposal in response to the RFP. Proposals will be evaluated in accordance with the criteria set forth in Section 7 of this RFP, which will be applied in the same manner to each proposal received.

### 2.3 Evaluation Committee

Proposals will be reviewed and evaluated by a committee appointed by the City's Business Administrator. The proposals will be reviewed to determine if the Respondent has met the professional, administrative and subject area requirements described in this RFP. Pursuant to N.J.A.C. 5:34-4.3 (c)(2)(i), "the names of the individuals who serve as committee members shall not be publicly disclosed until the evaluation report is presented to the governing body".

### 2.4 Procurement Schedule

The steps involved in the process and the anticipated completion dates are set forth in the Procurement Schedule below. The City reserves the right to, among other things, amend, modify or alter the Procurement Schedule upon notice to all potential Respondents.

#### Activity

- |  |                    |
|--|--------------------|
| 1. City Council approval of resolution authorizing use of competitive contracting for this project | July 18, 2018      |
| 2. Issuance of Request for Proposals   | July 30, 2018      |
| 3. Receipt of Proposals  | August 21, 2018    |
| 4. Completion of evaluation of Proposals   | September 18, 2018 |
| 5. Award of contract   | October 10, 2018   |

## 2.5 Addenda or Amendments to RFP

During the period provided for the preparation of responses to the RFP, the City may issue addenda, amendments or answers to written inquiries. Those addenda will be noticed by the City and will constitute a part of the RFP. All responses to the RFP shall be prepared with full consideration of the addenda issued prior to the proposal submission date.

All communications concerning this RFP or the RFP process shall be directed to the City's Purchasing Agent, in writing, via fax, or via e-mail. Responses to all questions will be forwarded as addenda to all prospective respondents who have provided accurate and current contact information (mailing address, fax number, e-mail address) to the Division of Purchasing.

Subsequent to issuance of this RFP, the City (through the issuance of addenda to all persons and/or firms that have received a copy of the RFP) may modify, supplement or amend the provisions of this RFP in order to respond to inquiries received from prospective Respondents or as otherwise deemed necessary or appropriate by (and in the sole judgment of) the City.

## 2.6 Rights of the City

The City reserves, holds and may exercise, at its sole discretion, the following rights and options with regard to this RFP and the procurement process in accordance with the provisions of applicable law:

- To conduct investigations of any or all of the Respondents, as the City deems necessary or convenient, to clarify the information provided as part of the Proposal and to request additional information to support the information included in any Proposal.
- To suspend or terminate the procurement process described in this RFP at any time (in its sole discretion.) If terminated, the City may determine to commence a new procurement process or exercise any other rights provided under applicable law without any obligation to the Respondents.

## 2.7 Cost of Proposal Preparation

Each Proposal and all information required to be submitted pursuant to the RFP shall be prepared at the sole cost and expense of the Respondent. There shall be no claims whatsoever against the City, its officers, officials or employees for reimbursement for the payment of costs or expenses incurred in the preparation of the Proposal or other information required by the RFP.

## 2.8 Proposal evaluation

Proposals will be evaluated on the basis of the written response to the RFP.

Each evaluator will rank the written proposals. The proposal ranked highest among the greatest number of evaluators will be selected for the project.

## 2.9 Written Proposal

Prospective Consultants must submit a written proposal in a format specified by the City. The required format is detailed in Section 3.

## 2.10 Equal Employment Opportunity/Affirmative Action

Consultant is required to comply with requirements of P.L. 1975, c. 127, the Law Against Discrimination and with N.J.A.C. 17:27-1.1 *et seq.* and N.J.S.A. 10:5-31, the Affirmative Action Rules.

A party responding to this RFP must indicate what type of business organization it is e.g., corporation, partnership, sole proprietorship, or non-profit organization. If a party is a subsidiary or direct or indirect affiliate of any other organization, it must indicate in its proposal the name of the related organization and the relationship. If a party responding to this RFP is a corporation or partnership, it shall list the names of those stockholders holding 10% or more of the outstanding stock or of all individual partners in the partnership who own a 10% or greater interest in the partnership.

Section 8 of this document describes general terms and conditions. Section 9 of this document contains required administrative forms which must accompany all proposals. Exclusion of any required form is grounds for rejection of proposals.

## 2.11 Disposition of RFP

Upon submission of a Proposal in response to this RFP, the Respondent acknowledges and consents to the following conditions relative to the submission and review and consideration of its Proposal:

- All Proposals shall become the property of the City and will not be returned.
- All Proposals will become public information at the appropriate time, as determined by the City (in the exercise of its sole discretion) in accordance with law. With respect to the Open Public Records Act (OPRA) and Proprietary Information- although the RFP indicates that all proposals will become public information, it is understood that OPRA contains exceptions for "Trade secrets and proprietary commercial or financial information obtained from any source" and "Information which, if disclosed, would give an advantage to competitors or bidders". Therefore, prospective Respondents shall submit two (2) clearly marked versions of their proposals. One version is to be a complete version to be used by the City for evaluation. The second version should contain redactions of legitimate "trade secrets and proprietary commercial or financial information" and/or "information which...would give an advantage to competitors or bidders".

This second version will be provided to persons submitting Open Public Records Act (OPRA) requests for information relating to this solicitation.

Failure to provide two clearly marked proposals will mean that the Respondent agrees that

the single version provided does not contain trade secrets or proprietary information and may be released pursuant to OPRA requests.

## 2.12 Softcopy version of RFP

Prospective respondents who have obtained printed copies of this RFP and who have provided accurate and current contact information (mailing address, fax number, e-mail address) to the Division of Purchasing, may request a softcopy version of this RFP. Softcopy versions will be provided as a PDF file only.

## SECTION 3: WRITTEN PROPOSAL FORMAT

Proposals must address all information requested in this RFP. Proposals which in the judgment of the City fail to meet the requirements of the RFP or which are in any way conditional, incomplete, obscure, contain additions or deletions from requested information, or contain errors may be rejected.

### 3.1 Mandatory content

Each proposal submitted must contain the ten (10) sections described below:

- Title Page
- Table of Contents
- Executive Summary
- Scope
- Objectives
- Project Workplan (including project organization, critical success factors)
- Assumptions/City of Jersey City Responsibilities
- Staffing
- Timing & Fees
- Appendices/Other

The information requested by the sectional format described above is further defined.

### 3.2 Title Page

The Proposal should include a title page, which identifies the project; the Respondent's Firm, name of the Respondent's primary contact, address, telephone number, fax number and email address.

### 3.3 Table of Contents

The Respondent's Proposal should include a Table of Contents, which lists the titles and page numbers for each major topic and sub-topic contained in the proposal.

### 3.4 Executive Summary

This section should include a summary of the key points and highlights of the Respondent's

response and should discuss the pricing contained in the Proposal.

### 3.5 Scope

In this section of the proposal, the Respondent should state what it believes to be the scope of the intended strategy within the City. If there are any gaps between what the Respondent believes should be the proper scope of the solution given all information known at the time of this RFP, the Respondent should clearly state these gaps in this section and clearly mark these concerns as such.

### 3.6 Objectives

In this section of the Proposal, the Respondent should state what it believes to be primary objectives for each element of the plan. Respondents may choose to offer suggestions to the City on how objectives for this type and size of a phased project should be measured throughout the life of the implementation, to ensure success in delivery of every business priority.

### 3.7 Project Work Plan

In addition to providing a high-level project work plan, this section should describe each of the proposed phases, activities and tasks that the City should execute to achieve success. In addition to the tasks, it is assumed that the Respondent will identify the resources needed to complete the associated task, and that the resource identified will have been included in the project organizational structure. All assumptions that were made to complete the project plan should be documented in this section.

### 3.8 Assumptions/Jersey City Responsibilities

In this section, the Respondent should clearly describe any assumptions relating to the responsibilities and/or commitments the Respondent is expecting of the City throughout the life of this project.

### 3.9 Staffing

A discussion of the project team that will be utilized should be contained in this section. The City requests that as part of the discussion here, the Respondent state exactly the role the proposed Respondent team member will assume, and detail the qualifications for the role that the team member possesses.

### 3.10 Timing and Fees

In this section, please describe the timing and associated fees the Respondent is proposing for the services described. Respondents should be sure to include all expenses associated with delivery, in addition to fees. The Respondent should be prepared to begin work upon Council approval.

It is important to note that pursuant to N.J.S.A 40A:5-16, the City is prohibited from paying for goods or services before they have been provided. Therefore, any proposal which specify payment upon contract signing will be deemed unresponsive and rejected.

### 3.11 Appendices/Other

This section should include at minimum: Consultant qualifications, references and resumes. If respondents feel that other materials are necessary (such as promotional literature, white papers, etc.) they should provide them in a separate document clearly labeled "Additional Materials" in order to adhere to the 30 page maximum guideline for proposal length. Note that these materials may or may not be reviewed by all evaluators and will not be part of the official evaluation. Finally, any out-of-scope services not covered in other sections should be included here. A description of the personnel likely to be involved, and the resources brought to bear (including costs and/or hourly rates) must be provided.

## SECTION 4: PROJECT OBJECTIVES

The City of Jersey City, NJ (the "City") is requesting proposals from qualified technology consulting firms reduce its pharmacy benefit costs for the City employees and retirees through electronic audit and analysis of 100% of the City's prescription drug claims.

## SECTION 5: SCOPE OF SERVICES

The successful consultant will audit every prescription drug claim incurred by individuals covered under the City's employee and retiree prescription drug plan to ensure compliance with PBM contract definitions and will collect recoveries from the contracted PBM of any overpayments made by the City to the PBM. The successful Consultant will develop and implement PBM contract terms and definitions along with general contract language. The successful consultant will employ their technology to optimize the performance of the City's pharmacy benefit manager (PBM). The chosen firm must be able to provide consulting services which analyze and audit 100% of plan claims' data to provide the City with, data-driven solutions to reduce costs, create efficiencies and improve clinical outcomes – all measured for accountability and fiduciary compliance.

Pursuant to N.J.S.A. 40A:11-4.2, the City intends to award a three year contract. Beginning October 10, 2018 and ending October 9, 2021

## SECTION 6: PROPOSAL SUBMISSION REQUIREMENTS

To be responsive, Proposals must provide all requested information, and must be in strict conformance with the instructions set forth herein. Proposals and all related information must be bound, and signed and acknowledged by the Respondent

### 6.1 Number of copies

Respondents must submit one signed original and at least 3 copies of their proposal, of which 1 must be

unbound (for photocopying purposes), along with a copy of their proposal on a thumb drive.

As previously described in 2.12, with respect to the Open Public Records Act (OPRA) and Proprietary Information - although the RFP indicates that all proposals will become public information, it is understood that OPRA contains exceptions for "Trade secrets and proprietary commercial or financial information obtained from any source" and "Information which, if disclosed, would give an advantage to competitors or bidders". Therefore, in addition to the 7 copies above, prospective Respondents shall submit two (2) clearly marked versions of their proposals for OPRA use. One version is to be a complete version to be used by the City for evaluation. The second version should contain redactions of legitimate "trade secrets and proprietary commercial or financial information" and/or "information which... would give an advantage to competitors or bidders". This second version will be provided to persons submitting Open Public Records Act (OPRA) requests for information relating to this solicitation. Failure to provide two clearly marked proposals will mean that the Respondent agrees that the single version provided does not contain trade secrets or proprietary information and may be released pursuant to OPRA requests.

#### 6.2 Proposal media

Proposals forwarded by facsimile, e-mail, CD, DVD will not be accepted.

#### 6.3 Proposal format

To facilitate a timely and comprehensive evaluation of all submitted Proposals, it is essential that all Respondents adhere to the required response format. The City requires a standard format for all Proposals submitted to ensure that clear, concise and complete statements are available from each Respondent in response to requirements. The required format is detailed in Section 3.

The City is not under any obligation to search for clarification through additional information submitted as a supplement to the formatted response. Where a proposal contains conflicting information, the City at its option may either request clarification of the information or consider the information unresponsive.

#### 6.4 Proposal length

The exact presentation and layout format of Proposals is up to the discretion of the Respondent, however a maximum length of 30 pages is strongly suggested.

#### 6.5 Submission deadline

Proposals must be received by the City no later than 11:00 a.m. prevailing time on Tuesday, August 21, 2018 and must be mailed or hand-delivered.

### SECTION 7: PROPOSAL EVALUATION

The City's objective in soliciting Proposals is to enable it to select a Respondent that will provide high quality and cost effective services to the citizens of Jersey City. The City will consider Proposals only from Respondents that, in the City's sole judgment, have demonstrated the capability and willingness to provide high quality services to the citizens of the City in the manner described in this RFP.



## 7.1 Evaluation methodology

Proposals will be evaluated on written responses. The finalists may be asked to give an oral presentation by representatives of the Respondent.

## 7.2 Written response evaluation

There are seven criteria by which proposals will be evaluated. Each criterion will bear a certain weight, and the extent to which the criterion is met or exceeded will be determined by the committee.

- a. **Required Format: 10 points**  
The committee will determine the extent to which the proposal includes the required sections (Title page, Table of contents, etc.).
- b. **Audit Process: 20 points**  
Vendor should demonstrate ability to electronically audit 100% of all prescription drug claims for compliance to PBM contract terms, and collect recoveries for the City of overpayments made by the City to the PBM.
- c. **Prior experience with similar projects: 10 points**  
The City does not wish to overly educate its consultants as to the workings (both operational and statutory) of New Jersey municipal government. As a result, proposals which include documentation (including references) of successful projects in municipalities will be viewed more favorably. Experience in the State of New Jersey is also desirable. This section should include (5 points each):
  - Client references (including contact information)
  - Details of project size
- d. **Technical: 20 points**  
Vendor should demonstrate ability to provide: detailed reporting of audit results, analysis and development of PBM contract language and definitions, analysis of PBM's contract compliance with actual prescription drug claims payments and provide strong technical and analytical data about prescription drug clinical cost reduction solutions. Vendor should demonstrate proper security protocol in compliance with the Health Insurance Portability and Accountability Act of 1996 (HIPAA). Vendor should demonstrate systems redundancy and disaster recovery protocol and procedures.
- e. **Personnel assigned: 10 points**  
Through this project, Jersey City will expect exceptional credentials and experience from the consultants which it employs. Resumes of consultant personnel will be scrutinized to ensure this requirement is met. Proposals which provide detailed accounts of team members' applicable experience and their anticipated roles in this project will be viewed more favorably.

f. Cost:35 points

Cost proposal should be based on a percentage of documented prescription drug savings achieved through PBM contract language implementation, contract compliance analysis and ongoing prescription drug claim auditing. Savings must be specifically defined in all responses. A calculation of how savings are derived and how compensation is calculated must be included in your response (see sample below). Include any cap on fee structure that you are willing to assign. Specifically define how and when charges are billed to the City. Specifically define any additional costs beyond a percent of savings compensation.

Sample Savings Summary		
1	Date of Report	April 30,2019
2	Period of Audit	January 1, 2019 - March 30,2019
3	Number current period Claims Processed under PBM prior Contract terms	25000
4	Value of current period Claims Processed under PBM prior Contract terms	\$6,000,000
5	Number current period Claims Processed under PBM current Contract terms	25000
6	Value of current period Claims Processed under PBM current Contract terms	\$5,000,000
7	Savings for current period (4-6)	\$1,000,000
<p><i>Value is the plan cost of claims</i>  <i>Calculation of savings must not include value of plan design modifications.</i>  <i>Calculations must include verifiable back up of all claims processed.</i></p>		

In order for vendors to estimate the potential volume of the City's transactions, the City provides the following information for the most recent 12 months available:

Commercial Prescription Drug Plans 8797 average covered lives  
 EGWP Plans – 1500 average covered lives

Commercial Plan Prescriptions filled – 104,000  
 EGWP Plan Prescriptions filled – 50,000

A prescription claim data file is available for analysis upon request to:

Peter Folgado  
 Director of Purchasing, QPA  
 Department of Administration  
 Division of Purchasing  
 394 Central Avenue, 3<sup>rd</sup> Fl.  
 Jersey City, New Jersey  
 (201) 547-5156

(201) 547-6586 (fax)

PeterF@jcnj.org

- g. Commitment to diversity: 5 points  
Support of, and utilization of Minority and Women Owned Business Enterprises (MBE/WBE), consistent with the City's policies, should be described.

7.3 Response weights

For each of the above written response criteria, the committee will determine the extent to which the requirements are fulfilled. This will be scored from 0 to 2, as follows:

- 0 No requirements met
- 1 Some or most requirements met
- 2 All requirements met or exceeded

Each criterion will be weighted by the extent to which the requirements are met and the resultant scores totaled, with 220 being the highest possible score. Each evaluator will then rank the Respondents by total score and the top three respondents identified.

7.4 Final evaluation and report of committee

Based on the written proposal responses each evaluator will rank the Respondents. The Respondent whose proposal is ranked highest will be selected for the project. The highest possible score is 220.

The Committee will prepare a report listing of all Respondents that submitted proposals, ranking Respondents in order of evaluation, and recommending the selection of a Consultant, indicating the reasons why the Consultant was selected and detailing the terms, conditions, scope of services, fees and other matters to be incorporated into the contract.

7.5 Contract award

A contract will be awarded pursuant to N.J.S.A. 40A:11-4.1 *et seq.* and N.J.A.C. 5:34-4.1 *et seq.*, and N.J.A.C. 5:34-9.4 (Competitive Contracting Law and Regulations) and is intended for a term of two years. If the City exercises all three renewal options, the term of the contract will be five years. The Municipal Council will vote to accept the proposal of a Consultant within 30 days of the receipt of proposals, except that the proposals of any Consultants who consent thereto, may, at the request of the City, be held for consideration for such longer period as may be agreed.

## SECTION 8: GENERAL TERMS AND CONDITIONS

The following are general terms and conditions which may or may not be explained elsewhere in this RFP.

### 8.1 City's right to reject

The City reserves the right to reject any or all Proposals, if necessary, or to waive any informalities in the

Proposals, and, unless otherwise specified by the Respondent, to accept any item, items or services in the Proposal should it be deemed in the best interest of the City.

## 8.2 Original/Authorized signatures

Each proposal and all required forms must be signed in ink by a person authorized to do so and/or notarized as indicated.

## 8.3 Delivery of proposals

Proposals may be hand delivered or mailed consistent with the provisions of the legal notice to Respondents. In the case of mailed Proposals, the City assumes no responsibility for Proposals received after the designated date and time and will return late Proposals unopened. Proposals will not be accepted by facsimile or e-mail.

## 8.4 Equal Employment Opportunity/Affirmative Action requirements

Consultants are required to comply with the provisions of N.J.S.A. 10:5-31 and N.J.A.C. 17:27 et seq. No firm may be issued a contract unless it complies with these affirmative action provisions. The Mandatory Equal Employment Opportunity/Affirmative Action Language for Goods, Professional Services and General Service Contracts, Exhibit A summarizes the full required regulatory text.

Goods and Services (including professional services) consultants/contractors shall submit to the public agency, after notification of award but prior to execution of a goods and services contract, one of the following three documents:

- a. A photo copy of a valid letter that the contractor is operating under an existing Federally approved or sanctioned affirmative action programs (good for one year from the date of the letter); or
- b. A photocopy of a Certificate of Employee Information Report approval, issued in accordance with N.J.A.C. 17:27-4; or
- c. A photocopy of an Employee Information Report (Form AA302) provided by the Division and distributed to the public agency to be completed by the contractor, in accordance with N.J.A.C. 17:27-4.

The Respondent's attention is also called to Section 9 of this document which contains the required information and forms. For information on EEO/AA requirements and forms only, please contact:

Jeana F. Abuan  
Affirmative Action Officer/Public Agency Compliance Officer  
Department of Administration Office of Compliance  
13 Linden Avenue  
Jersey City NJ 07305  
Tel. #201-547-4533

Fax# 201-547-5088

E-mail Address: [AbuanJ@jcni.org](mailto:AbuanJ@jcni.org)

### 8.5 Business Registration Certificate

P.L. 2004, c. 57 (Chapter 57) amends and supplements the business registration provisions of N.J.S.A. 52:32-44 which impose certain requirements upon a business competing for or entering into a contract with a local contracting agency whose contracting activities are subject to the requirements of the Local Public Contracts Law (N.J.S.A. 40A:11-1 *et seq.*).

Consultants are required to comply with the requirements of P.L. 2004, c. 57 (Chapter 57) which include submitting a copy of their Business Registration Certificate (BRC), issued by the NJ Department of the Treasury. For more information on obtaining a BRC, see Section 9.

### 8.6 Clarification of RFP

Should any difference arise as to the meaning or intent of this RFP, the City's Business Administrator's decision shall be final and conclusive.

### 8.7 Indemnification

The Respondent, if awarded the contract, agrees to protect, defend and save harmless the City against damage for payment for the use of any patented material process, article or devise that may enter into the manufacture, construction or form a part of the work covered by either order or contract, and further agrees to indemnify and save harmless the City from suits or actions of every nature and description brought against it for, or on account of, any injuries or damages received or sustained by any party or parties by, or from, any of the acts of the contractor, its servants or agents.

### 8.8 Insurance requirements

The Consultant shall maintain sufficient insurance to protect against all claims under Workmen's Compensation, General and Automobile Liability, and shall be subject to approval for adequacy of protection. Certificates of such insurance shall be provided the City when required. Insurance requirements are as follows:

- Comprehensive General Liability in the amount of \$2,000,000 per occurrence and in aggregate; including Products & Completed Operations coverage.
- Workers Compensation with NJ statutory limits and Employer's Liability in the amount of \$1,000,000.
- Automobile Liability in the amount of \$1,000,000 combined single limit.
- Professional Liability in the amount of \$1,000,000 per occurrence and in aggregate.
- Cyber Liability in the amount of \$2,000,000 each incident and in aggregate.

### 8.9 Termination

In the event the performance by the Consultant of the services provided for under the agreement awarded through this RFP process is unsatisfactory to the City, the City agrees to notify the Consultant, and the Consultant agrees to within thirty (30) days rectify the unsatisfactory condition

or performance. Should the unsatisfactory performance or condition not be rectified within thirty (30) days of notice being given, the City shall at its sole option be entitled to terminate the agreement awarded through this RFP process immediately upon written notice to the Consultant unless rectification of such unsatisfactory performance or condition cannot reasonably be completed with such thirty (30) day period but the Consultant shall have commenced to rectify such unsatisfactory condition or performance within such thirty (30) day period and shall be diligently pursuing such cure; provided, that such unsatisfactory performance or condition shall be cured no later than ninety (90) days after the date on which the Consultant was first notified thereof.

**SECTION 9: REQUIRED ADMINISTRATIVE FORMS**

Please place the checklist and the required forms which follow at the front of your proposal to facilitate Purchasing's review.

PROJECT: Prescription Drug Plan Audit and Analytics Consulting

RESPONDENT: \_\_\_\_\_

Item	Respondent Initials	Purchasing Review
A. Non-Collusion Affidavit properly notarized		
B. Statement of Ownership Disclosure*		
C. Mandatory Affirmative Action Language		
D. Americans with Disabilities Act		
E. MWBE Questionnaire		
F. With Proposal or after notification of award, but prior to signing a Contract, submit photo copy of one of the following three documents: <ul style="list-style-type: none"> <li>a. A valid letter that the contractor is operating under an existing Federally approved or sanctioned affirmative action program (good for one year from the date of the letter); or</li> <li>b. Unexpired Certificate of Employee Information Report; or</li> <li>c. Employee Information Report (Form 302AA) if first time doing business with Jersey City.</li> </ul>		
G. Business Registration Certificate		
H. Original Signature(s) on all required forms.		
I. Acknowledgment of Receipt of Addenda.*		
J. Disclosure of Activities in Iran Form.		

CITY OF JERSEY CITY ss:

**NON COLLUSION AFFIDAVIT  
STATE OF NEW JERSEY**

CITY OF JERSEY CITY ss:

I certify that I am \_\_\_\_\_  
of the firm of \_\_\_\_\_

the bidder making the proposal for the above named project, and that I executed the said proposal with full authority so to do; that said bidder has not, directly or indirectly entered into any agreement, participated in any collusion, or otherwise taken any action in restraint of free, competitive bidding in connection with the above named project; and that all statements contained in said proposal and in this affidavit are true and correct, and made with full knowledge that the City of Jersey City relies upon the truth of the statements contained in said proposal and in the statements contained in this affidavit in awarding the contract for the said project.

I further warrant that no person or selling agency has been employed to solicit or secure such contract upon an agreement or understanding for a commission, percentage, brokerage or contingent fee, except bona fide employees or bona fide established commercial or selling agencies maintained by (N.J.S.A. 52: 34-25)

(Signature of respondent) \_\_\_\_\_

SUBSCRIBED AND SWORN TO  
BEFORE ME THIS DAY \_\_\_\_\_ OF 20 \_\_\_\_\_

(TYPE OR PRINT NAME OF AFFIANT UNDER SIGNATURE)

NOTARY PUBLIC OF  
MY COMMISSION EXPIRES: \_\_\_\_\_

**(NOTE: THIS FORM MUST BE COMPLETED, NOTARIZED AND RETURNED WITH THIS PROPOSAL).**



## **Appendix B: Certifications of Non-Conflict of Interest**



City of Jersey City  
Certification of No Conflict of Interest  
Competitive Contracting Evaluation: Comprehensive Animal Control Services

I hereby certify that I have reviewed the conflict of interest standards in the Local Government Ethics Law or the School Ethics Act, as appropriate, and that I do not have a conflict of interest with respect to the evaluation of this proposal (these proposals). I further certify that I am not engaged in any negotiations or arrangements for prospective employment or association with any of those submitting proposals or their parent or subsidiary organization.

John B. McManis

Print Name

[Signature]  
Signature

10/23/2018  
Date

Note: The Local Government Ethics Law is N.J.S.A 40A:9-22.1 *et seq* and can be reviewed on the State of NJ Legislative Website at <http://www.njleg.state.nj.us/>. Click on "Statutes" and enter "40A:9-22.1" in the Search Box.



**City of Jersey City  
Certification of No Conflict of Interest  
Competitive Contracting Evaluation: Audit Analytics Consulting Prescription  
Benefits Plan**

I hereby certify that I have reviewed the conflict of interest standards in the Local Government Ethics Law or the School Ethics Act, as appropriate, and that I do not have a conflict of interest with respect to the evaluation of this proposal (these proposals). I further certify that I am not engaged in any negotiations or arrangements for prospective employment or association with any of those submitting proposals or their parent or subsidiary organization.

Micheline Yurcik  
\_\_\_\_\_  
Print Name

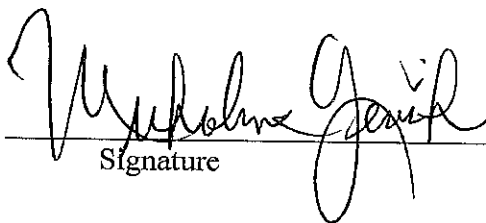
  
\_\_\_\_\_  
Signature

10/24/18  
\_\_\_\_\_  
Date

Note: The Local Government Ethics Law is N.J.S.A 40A:9-22.1 *et seq* and can be reviewed on the State of NJ Legislative Website at <http://www.njleg.state.nj.us/>. Click on "Statutes" and enter "40A:9-22.1" in the Search Box.



**City of Jersey City  
Certification of No Conflict of Interest  
Competitive Contracting Evaluation: Audit Analytics Consulting Prescription  
Benefits Plan**

I hereby certify that I have reviewed the conflict of interest standards in the Local Government Ethics Law or the School Ethics Act, as appropriate, and that I do not have a conflict of interest with respect to the evaluation of this proposal (these proposals). I further certify that I am not engaged in any negotiations or arrangements for prospective employment or association with any of those submitting proposals or their parent or subsidiary organization.

**Mark Bunbury Jr.**

Print Name

**Mark Bunbury Jr.**

Signature

Digitally signed by Mark Bunbury Jr.  
DN: cn=Mark Bunbury Jr., o=City of Jersey City, ou=Dept.  
of Human Resources, email=mbunbury@cnj.org, c=US  
Date: 2018.10.23 12:16:43 -04'00'

**10/23/18**

Date

Note: The Local Government Ethics Law is N.J.S.A 40A:9-22.1 *et seq* and can be reviewed on the State of NJ Legislative Website at <http://www.njleg.state.nj.us/>. Click on "Statutes" and enter "40A:9-22.1" in the Search Box.

## **Appendix C: Detailed Evaluation Spreadsheets**

Jersey City Bid # 1 807 - 003 Request for Proposals for Audit Analytics Consulting for Prescription Drug Plan		
	Milliman	
	Detail	Score
Location	Corporate Office: Seattle Washington, Local Office Windsor, CT	
Does respondent understand the project requirements?	Respondent provided a comprehensive response. Did not price as a percent of savings. Did not provide PBM contract development as part of response.	3
Does response include 100% claims audit utilizing claims repricing at a prescription level?	Yes	5
Does response include audit of AWP and ingredient cost guarantees (including specialty medications) in accordance with contract terms?	Yes	5
Does response include 100% rebate guarantee audit in accordance with contract terms?	Yes	5
Does response include complete audit recovery negotiation with PBM?	Yes, respondent commits to facilitate recovery negotiation between client and PBM.	4
Does response include PBM contract development and language negotiation?	Yes	5
Does response include analysis of PBM RFP responses?	Yes	5
Is respondent pricing for services based on a percentage of savings as requested?	No	0
Additional Audit compliance Tests	Yes	5
Does response include comprehensive utilization analytics?	Yes. Provides some utilization feedback	4
Staffing - Actuarial	Yes	5
Qualifications and Experience	Qualified	5
Client References	Response includes out of state municipal clients. Includes no New Jersey municipal client.	3
Total Score		51

Fees Structure (based on 5 respondents). Fee Year 1 - \$265,000, Year 2 - \$125,000, Year 3 - \$118,000 (not to exceed costs assume no more than five PBM respondents). Fee may be higher if more than 5 respondents.

Scoring Criteria: Each section is ranked using a score of 0 to 5.

Jersey City Bid # 1 807 - 003 Request for Proposals for Audit Analytics Consulting for Prescription Drug Plan

	PillarRx Consulting	
	Detail	Score
Location	Corporate Office: Milwaukee, WI	
Does respondent understand the project requirements?	Respondent provided a comprehensive response. Did not price as a percent of savings. Provided some reference to PBM contract development as part of response.	4
Does response include 100% claims audit utilizing claims repricing at a prescription level?	Yes	5
Does response include audit of AWP and ingredient cost guarantees (including specialty medications) in accordance with contract terms?	Yes	5
Does response include 100% rebate guarantee audit in accordance with contract terms?	Yes	5
Does response include complete audit recovery negotiation with PBM?	Yes, respondent commits to advocate for the City in its negotiation between client and PBM.	4
Does response include PBM contract development and language negotiation?	Yes. Respondent indicates it will review the contract to identify future opportunities for savings.	4
Does response include analysis of PBM RFP responses?	No	0
Is respondent pricing for services based on a percentage of savings as requested?	No	0
Additional Audit compliance Tests	Yes	5
Does response include comprehensive utilization analytics?	Yes	5
Staffing - Actuarial	Actuary not on staff but Respondent commits to having access to actuarial services	4
Qualifications and Experience	Qualified	5
Client References	Response includes out of state municipal clients. Includes no New Jersey municipal client.	3
Total Score		45

Fees Structure Year 1 - \$106,000. Respondent did not specify a price for year 2 and year 3.

Scoring Criteria: Each section is ranked using a score of 0 to 5.

**Jersey City Bid # 1 807 - 003 Request for Proposals for Audit Analytics Consulting for Prescription Drug Plan**

	Remedy Analytics	
	Detail	Score
Location	Corporate Office: Milwaukee, WI	
Does respondent understand the project requirements?	Respondent provided a comprehensive response. Respondent addressed all requirements.	5
Does response include 100% claims audit utilizing claims repricing at a prescription level?	Yes	5
Does response include audit of AWP and ingredient cost guarantees (including specialty medications) in accordance with contract terms?	Yes	5
Does response include 100% rebate guarantee audit in accordance with contract terms?	Yes	5
Does response include complete audit recovery negotiation with PBM?	Yes, respondent commits to assist in recovery negotiation between client and PBM.	4
Does response include PBM contract development and language negotiation?	Yes, Respondent indicates it will integrate itself in the development of PBM language to identify inappropriate PBM pricing strategies	5
Does response include analysis of PBM RFP responses?	Yes	5
Is respondent pricing for services based on a percentage of savings as requested?	Yes	5
Additional Audit compliance Tests	Yes	4
Does response include comprehensive utilization analytics?	Yes. Provides utilization analytics	5
Staffing - Actuarial	Yes	5
Qualifications and Experience	Qualified	5
Client References	Response includes Out of state governmental clients and references 7 New Jersey municipal clients generally and will provide more specifics upon award	4
<b>Total Score</b>		<b>57</b>

Fees Structure

Yr 1 - 15% of savings, Yr 2 - 15% of savings, Yr 3 - 15% of savings,  
not to exceed \$500,000 Yr 1, \$450,000 Yr 2, \$400,000 Yr 3.

Scoring Criteria: Each section is ranked using a score of 0 to 5.



# Resolution of the City of Jersey City, N.J.

City Clerk File No. Res. 18-1004

Agenda No. 10.Z.19

Approved: NOV 07 2018

TITLE:



**RESOLUTION AUTHORIZING THE AWARD OF A PROFESSIONAL SERVICES CONTRACT TO FC3 ARCHITECTURE + DESIGN LLC TO PREPARE A FORMAL COST ESTIMATE FOR SUBMITTAL TO THE UNITED STATES DEPARTMENT OF HOMELAND SECURITY FEDERAL EMERGENCY MANAGEMENT AGENCY, FOR THE DEPARTMENT OF ADMINISTRATION, DIVISION OF ENGINEERING, TRAFFIC AND TRANSPORTATION**

COUNCIL AS A WHOLE OFFERED AND MOVED ADOPTION OF  
THE FOLLOWING RESOLUTION:

**WHEREAS**, the City of Jersey City (City), City Hall located at 280 Grove Street sustained damage to the lower level as a result of Superstorm Sandy; and

**WHEREAS**, the United States Department of Homeland Security Federal Emergency Management Agency (FEMA) requires a formal cost estimate to be submitted for potential funding; and

**WHEREAS**, the City is interested in the potential conversion of the existing, vacant fourth floor into approximately 20,000 SF of office space; and

**WHEREAS**, FEMA has expressed potential funding is available for such a conversion; and

**WHEREAS**, FC3 Architecture + Design LLC (FC3LLC) submitted the attached proposal dated August 3, 2018 in the amount of Sixteen Thousand Nine Hundred Fifty Dollars and Zero Cents (\$16,950.00); and

**WHEREAS**, funding in the amount of Sixteen Thousand Nine Hundred Fifty Dollars and Zero Cents (\$16,950.00) is available for this expenditure from:

Account # 04-215-55-116-990 Requisition # 0184881 P.O. # 131215 Amount \$16,950.00

**WHEREAS**, these services qualify as professional services exempt from public bidding under the Local Public Contracts Law, N.J.S.A. 40A:11-5 (1)(a)(i); and

**WHEREAS**, the resolution authorizing the award and the agreement itself must be available for public inspection; and

**WHEREAS**, this contract is awarded pursuant to the fair and open process of the Pay-To-Play Law, N.J.S.A. 19:44A-20.4 et seq.; and

**WHEREAS**, FC3LLC has submitted its Certification of Compliance with the City's Contractor Pay-to-Play Reform Ordinance 08-128 adopted on September 3, 2008.

JRC:db

TITLE:

**RESOLUTION AUTHORIZING THE AWARD OF A PROFESSIONAL SERVICES CONTRACT TO FC3 ARCHITECTURE + DESIGN LLC TO PREPARE A FORMAL COST ESTIMATE FOR SUBMITTAL TO THE UNITED STATES DEPARTMENT OF HOMELAND SECURITY FEDERAL EMERGENCY MANAGEMENT AGENCY, FOR THE DEPARTMENT OF ADMINISTRATION, DIVISION OF ENGINEERING, TRAFFIC AND TRANSPORTATION**

NOW, THEREFORE, Be It Resolved by the Municipal Council of the City of Jersey City that:

1. The Mayor or Business Administrator is authorized to execute a professional services agreement, in substantially the form of the attached, with FC3LLC, to provide professional services for a total contract amount not to exceed Sixteen Thousand Nine Hundred Fifty Dollars and Zero Cents (\$16,950.00);
2. The term of the contract shall be twelve (12) months effective upon the execution of the Contract by City Officials;
3. This Agreement is awarded without competitive bidding as a Professional Services Agreement under the Local Public Contracts Law, N.J.S.A. 40A:11-5(1)(a)(i);
4. A copy of this Resolution shall be published in a newspaper of general circulation in the City of Jersey City as required by law within 10 days of its adoption;
5. This contract is awarded using the Fair and Open Process of the Pay-to-Play Law, N.J.S.A. 19:44A-20.4 et seq.;
6. The Certification of Compliance with the City's Contractor Pay-to-Play Reform Ordinance, attached hereto and incorporated herein by reference, shall be placed on file with this resolution.

I Donna Mauer (Donna Mauer), as Chief Financial Officer, hereby certify that these funds are available for this expenditure in accordance with the Local Budget Law, N.J.S.A. 40A:4-1 et seq.

S/MCK  
10/31/18

JRC:db

APPROVED: Jose R. Cumber

APPROVED AS TO LEGAL FORM

APPROVED: [Signature]  
Business Administrator

[Signature]  
Corporation Counsel

Certification Required

Not Required

APPROVED 8-0

RECORD OF COUNCIL VOTE ON FINAL PASSAGE 11.7.18											
COUNCILPERSON	AYE	NAY	N.V.	COUNCILPERSON	AYE	NAY	N.V.	COUNCILPERSON	AYE	NAY	N.V.
RIDLEY	✓			YUN	✓			RIVERA	✓		
PRINZ-AREY	✓			SOLOMON	✓			WATTERMAN	ABSENT		
BOGGIANO	✓			ROBINSON	✓			LAVARRO, PRES.	✓		

✓ Indicates Vote

N.V.-Not Voting (Abstain)

Adopted at a meeting of the Municipal Council of the City of Jersey City N.J.

[Signature]  
Rolando R. Lavarro, Jr., President of Council

[Signature]  
Robert Byrne, City Clerk

**RESOLUTION FACT SHEET - CONTRACT AWARD**

This summary sheet is to be attached to the front of any resolution that is submitted for Council consideration. Incomplete or vague fact sheets will be returned with the resolution.

**Full Title of Ordinance/Resolution**

**RESOLUTION AUTHORIZING THE AWARD OF A PROFESSIONAL SERVICES CONTRACT TO FC3 ARCHITECTURE + DESIGN LLC TO PREPARE A FORMAL COST ESTIMATE FOR SUBMITTAL TO THE UNITED STATES DEPARTMENT OF HOMELAND SECURITY FEDERAL EMERGENCY MANAGEMENT AGENCY, FOR THE DEPARTMENT OF ADMINISTRATION, DIVISION OF ENGINEERING, TRAFFIC AND TRANSPORTATION**

**Project Manager**

Department/Division	Administration	Engineering, Traffic & Transportation
Name/Title	Joe Cunha	Chief Engineer
Phone/email	201-547-4411	jcunha@jcnj.org

Note: Project Manager must be available by phone during agenda meeting (Wednesday prior to council meeting @ 4:00 p.m.)

**Contract Purpose**

The purpose of this resolution is to award a Professional Services Contract to FC3 Architecture + Design LLC to prepare a formal cost estimate for submittal to FEMA in order to qualify for potential funding. The cost estimate will detail necessary repairs following damage incurred during Superstorm Sandy. The cost estimate will also incorporate the conversion of the vacant fourth floor into approximately 20,000 SF of new office space.

**Cost (Identify all sources and amounts)**

04-215-55-116-990: \$16,950.00

**Contract term (include all proposed renewals)**

Twelve (12) months

Type of award Fair and Open

If "Other Exception", enter type

**Additional Information**

FEMA has expressed the availability of funding for the conversion of the fourth floor in order to protect infrastructure from future damage.

I certify that all the facts presented herein are accurate.

*Joe R. Cunha*  
Signature of Division Director

10/29/18  
Date

*[Signature]*  
Signature of Department Director

10/29/18  
Date



STEVEN M. FULOP  
MAYOR OF JERSEY CITY

CITY OF JERSEY CITY  
DEPARTMENT OF ADMINISTRATION  
DIVISION OF ENGINEERING, TRAFFIC & TRANSPORTATION

Municipal Services Complex  
13-15 Linden Avenue East | Jersey City, NJ 07305  
Engineering Desk: 201-547-4411 | Traffic Desk: 201-547-4470



BRIAN D. PLATT  
BUSINESS ADMINISTRATOR

MEMORANDUM

**DATE:** October 29, 2018  
**TO:** Rolando L. Lavarro Jr., Council President and Council Members  
**FROM:** Jose R. Cunha, Director of Engineering, Traffic and Transportation  
**SUBJECT:** City Hall Flood Mitigation FEMA Estimate  
City of Jersey City  
Project No. 18-015-E  
Resolution to Award Professional Services Agreement with FC3 Architecture + Design

The purpose of this resolution is to award a Professional Services Contract to FC3 Architecture + Design LLC to prepare a formal cost estimate for submittal to FEMA in order to qualify for potential funding. The cost estimate will detail necessary repairs following damage incurred during Superstorm Sandy. The cost estimate will also incorporate the conversion of the vacant fourth floor into approximately 20,000 SF of new office space.

FEMA has expressed the availability of funding for the conversion of the fourth floor in order to protect infrastructure from future damage.

Following are the sources of funding for this project:

- |   |             |
|---|-------------|
| 1. Account No. <u>04-215-55-116-990</u> | \$16,950.00 |
|---|-------------|

Attached for your consideration is the Resolution authorizing the Professional Services Agreement to FC3 Architecture + Design LLC in the amount of Sixteen Thousand Nine Hundred Fifty Dollars and Zero Cents (\$16,950.00) for the subject project.

\_\_\_\_\_  
Jose R. Cunha, P.E., C.M.E.  
Director of Engineering, Traffic and Transportation

G:\MP\_MUNICIPAL PROJECTS\PROJECT by NUMBERS\18-015-E - City Hall FEMA Cost Estimate\1. Project Coordination & Correspondence\Award Resolution Documents\20181029 PS FC3 City Hall Estimate Letter to Council FINAL.docx

# AGREEMENT

Agreement made this \_\_\_\_\_ day of \_\_\_\_\_, 2018 between the CITY OF JERSEY CITY, a municipal corporation of the State of New Jersey ("CITY") and FC3 ARCHITECTURE + DESIGN LLC, 9 KRISTEN COURT, HAMBURG, NJ 07419, hereinafter referred to as CONSULTANT.

**WHEREAS**, the City of Jersey City (City), City Hall located at 280 Grove Street sustained damage to the lower level as a result of Superstorm Sandy; and

**WHEREAS**, the United States Department of Homeland Security Federal Emergency Management Agency (FEMA) requires a formal cost estimate to be submitted for potential funding; and

**WHEREAS**, the City is interested in the potential conversion of the existing, vacant fourth floor into approximately 20,000 SF of office space; and

**WHEREAS**, FEMA has expressed potential funding is available for such a conversion; and

**WHEREAS**, FC3 Architecture + Design LLC (FC3LLC) submitted the attached proposal dated August 3, 2018 in the amount of Sixteen Thousand Nine Hundred Fifty Dollars and Zero Cents (\$16,950.00); and

**WHEREAS**, this Agreement was authorized by Resolution \_\_\_\_\_ approved on \_\_\_\_\_, 2018.

NOW, THEREFORE, in consideration of the mutual promises and covenants set forth herein, the parties agree as follows:

## ARTICLE I

### Purpose of Agreement

The purpose of this agreement is for CONSULTANT to provide the CITY with Professional Services at the Jersey City – City Hall, 280 Grove Street, Project No. 18-015-E.

## ARTICLE II

### Scope of Services

1. CONSULTANT shall perform for the CITY all of the required professional services in accordance with this Agreement and the Proposal prepared by the CONSULTANT dated August 3, 2018 which is attached hereto and incorporated herein by reference. This Agreement and the Proposal are intended to complement and supplement each other. In the event that there is a conflict or discrepancy between the provisions of this Agreement and the provisions of the Proposal, the provisions of this Agreement shall govern over the provisions of the Proposal.

2. Such described services shall be performed during a period of twelve (12) months commencing upon the execution of this Agreement by City officials.

3. The scope of services to be performed shall not be materially different from, or more or less extensive, than those specified above unless such modifications are

reduced to writing and signed by authorized representatives of the CITY and CONSULTANT. Any modifications which increase the compensation of CONSULTANT shall require the prior authorization of the governing body of the CITY.

### **ARTICLE III**

#### **Contractual Relationship**

1. In performing the services under this Agreement, CONSULTANT shall operate and have status of an independent contractor and shall not act as an agent or employee of CITY. As an independent contractor, CONSULTANT shall be solely responsible for determining the means and methods of performing the consulting services described in the Scope of Services.

2. CONSULTANT shall perform the services to be furnished under this Agreement with the degree of skill and care that is required by customarily accepted competent professional practices to assure that all work is correct and appropriate for the purposes intended.

### **ARTICLE IV**

#### **Compensation and Payment**

1. Compensation for the performance of the professional services described in this Agreement will be in accordance with the attached CONSULTANT'S proposal dated August 3, 2018 in the amount of Sixteen Thousand Nine Hundred Fifty Dollars and Zero Cents (\$16,950.00);

2. CONSULTANT shall submit to CITY invoices showing the services performed and the charges therefore in proportion to the work completed as described in the attached proposal prepared by CONSULTANT. Monthly reports (including but not limited to narrative description of the work performed, sample analysis report, photograph, etc.) must be attached to each invoice. CONSULTANT understands that said invoices must be submitted to the governing body of CITY for approval prior to payment.

## ARTICLE V

### Insurance

1. CONSULTANT shall purchase and maintain the following insurance during the terms of this Agreement.

A. Comprehensive General Liability: including Premises Operations, Products and Completed Operations, and Independent Contractor Coverage - covering as insured the CONSULTANT with not less than ONE MILLION (\$1,000,000.00) DOLLARS per occurrence and TWO MILLION (\$2,000,000.00) DOLLARS in aggregate for Bodily Injury and Property Damage Liability. The CITY of Jersey City, its agents, servants shall be named as additional named insured.

B. Automobile Liability Coverage: naming as insured the CONSULTANT with not less than ONE MILLION (\$1,000,000.00) DOLLARS combined single limit for Bodily Injury and Property Damage Liability, including non-owned Automobile Liability Coverage

C. Workmen's Compensation Insurance: benefit securing compensation for the benefit of the employees of the CONSULTANT with NJ statutory



limits and Employer's Liability in the amount of ONE MILLION (\$1,000,000.00) DOLLARS.

D. Professional Liability Insurance: covering as insured the CONSULTANT with not less than TWO MILLION (\$2,000,000.00) DOLLARS limit of liability.

E. Errors & Omissions Liability Insurance: covering as insured the CONSULTANT with not less than TWO MILLION (\$2,000,000.00) DOLLARS per occurrence and in aggregate.

Before commencing the work, the CONSULTANT shall furnish the CITY certificates of such insurance upon execution of this Contract. Except for workers' compensation and professional liability, all certificates shall name the City of Jersey City as an additional insured. All certificates shall bear said City Project Name and Number – Project No. 18-015-E.

2. The insurance policies described in this Article shall be kept in force for a period specified below.

A. Comprehensive General Liability, Automobile Liability Coverage, Workmen's Compensation Insurance, and Owner's Protective Liability and Property Damage Insurance, shall be kept in force until submission of the CONSULTANT'S final invoice.

B. Professional Liability Insurance should be kept in force until at least one (1) year after completion of this Agreement.

## ARTICLE VI

### Personnel of the Consultant

1. The CONSULTANT shall engage in his sole expense and be responsible for, all engineers, architects, cost estimators and experts as may be required for the proper performance of the Contract, including maintenance of schedules, correlation of their work and resolution of all differences between them. The CONSULTANT shall pay to any such architects, engineers, cost estimators and experts employed on the project, monies commensurate with the professional engineering services rendered by them. It is understood that all such personnel shall be engaged by the CONSULTANT and not the CITY, and the CONSULTANT alone is responsible for their work.

2. All personnel assigned to the Project by the CONSULTANT shall be required to cooperate fully with personnel assigned to the Project by the CITY and in the event the CONSULTANT'S personnel fails to cooperate, the CONSULTANT shall relieve them of their duties on the Project when mutually agreed by both, the CITY and the CONSULTANT.

## ARTICLE VII

### Indemnity

1. CONSULTANT shall indemnify and holds harmless the CITY, its respective employees and all claims against any of them for personal injury or death or property damage arising solely out of the negligent performance of professional service or caused by error, omission or negligent act of the CONSULTANT or any one employed by the CONSULTANT.

## ARTICLE VIII

### Progress Report

The CONSULTANT shall prepare and send to the CITY on a monthly basis a Consulting Progress Monthly Payment Schedule Report giving the status of the Project. If progress is delayed for any reason, the CONSULTANT shall state the reason for such delay in this report.

## ARTICLE IX

### Suspension or Termination

1. Termination: CITY shall have the right to terminate this Agreement in whole or in part upon seven (7) days written notice. Upon receipt of termination notice, CONSULTANT shall immediately discontinue services. CONSULTANT shall be paid the amount earned by or reimbursable to it hereunder to the time specified in said notice, including all reasonable costs incurred by CONSULTANT in connection with discontinuing the work hereunder, and shall have no further claim against CITY with respect thereto.

2. Suspension: CITY shall have the right to suspend this Agreement at any time, and for any reason, direct the CONSULTANT to stop work under this contract for a period of time, upon seven (7) days written notice. The CONSULTANT shall resume work as directed by the CITY, in writing. The period during which work shall have been suspended shall be deemed added to the time of performance of this Contract. Stoppage of work shall not give rise to any claim against the CITY for damages or extra

remuneration except reasonable costs incurred by CONSULTANT in connection with the suspension of work, and shall have no further claim against CITY with respect thereto.

## **ARTICLE X**

### **Arbitration**

1. Any disputes or claims arising out of this Agreement, or breach thereof, shall be decided by a mutually agreed upon single arbitrator appointed in accordance with the rules of the American Arbitration Association. The arbitrator shall be bound by the terms of this Agreement and shall issue a written opinion explaining the reasons for his award.

2. A demand for arbitration shall be in writing no later than five (5) days after the written decision of the Director of the Division of Engineering, Traffic and Transportation of the CITY or any claim or dispute covered by this Article.

## **ARTICLE XI**

### **Nondiscrimination**

In connection with the performance of work under this contract, the CONSULTANT agrees not to discriminate against any employee or applicant because of race, creed, color, or national origin; and further agrees to insert the forthcoming provisions in all subcontracts for standard commercial supplies or for raw materials.

## ARTICLE XII

### Compliance With Equal Employment Opportunity/Affirmative Action Plan

1. If the Agreement exceeds \$40,000.00, it shall also be subject to the provisions of N.J.S.A. 10:5-31 et seq. and N.J.S.A. 17:27 et seq. (Equal Employment Opportunity/Affirmative Action Provisions).

2. This Agreement shall not become effective and CONSULTANT shall provide no services under this Agreement until it has complied with the Equal Employment Opportunity/Affirmative Action Provisions. The Mandatory Equal Employment Opportunity/Affirmative Action Language, Exhibit A summarizes the full, required regulatory text (Exhibit A and additional EEO/AA mandatory languages and forms are attached hereto and incorporated herein).

3. CONSULTANT shall submit to the public agency, after notification of award but prior to execution of a goods and services contract, one of the following three documents:

- A. A photocopy of a valid letter that the contractor is operating under an existing federally approved or sanctioned affirmative action program (good for one year from the date of the letter); or
- B. A photocopy of a Certificate of Employee Information Report Approval, issued in accordance with N.J.A.C. 17:27-4; or
- C. A photocopy of an Employee Information Report (Form AA 302) provided by the Division and distributed to the public agency to be completed by the contractor, in accordance with N.J.A.C. 17:27-4.

### ARTICLE XIII

#### Compliance With Americans With Disabilities Act of 1990

Discrimination on the basis of disability in contracting for the purchase of goods and services is prohibited. CONSULTANT is required to read Americans with Disabilities language that is included as Appendix A of this proposal and agree that the provisions of Title II of the Act are made a part of the contract. The CONSULTANT is obligated to comply with the Act and to hold the owner harmless.

### ARTICLE XIV

#### Indemnity

The CONSULTANT shall be liable to and hereby agrees to indemnify and hold harmless the CITY and employees of the CITY from any damages and from costs and expenses to which the CITY and its respective employees may be subjected, or which they may suffer or incur by reason of any loss, property damage, bodily injury, or death resulting solely from an error, omission or negligent act of the CONSULTANT or anyone employed by the CONSULTANT in the performance of this contract. Said agreement shall indemnify and defend the CITY and their respective employees and shall continue in full force for ten (10) years, which is the applicable statute of limitations.

## ARTICLE XV

### Entire Agreement

1. This Agreement constitutes the entire agreement between CITY and CONSULTANT. It supersedes all prior or contemporaneous communications, representations of agreement, whether oral or written with respect to the subject matter thereof and has been induced by no representations, statements or agreements other than those herein expressed. No Agreement hereafter made between the parties shall be binding on either party unless produced in writing and signed by an authorized officer of the party sought to be bound thereby.

2. This Agreement shall in all respects be interpreted and construed and the rights of the parties thereto shall be governed by the laws of the State of New Jersey.

## ARTICLE XVI

### P.L. 2004, c.57 (N.J.S.A. 52:32-44)

### MANDATORY BUSINESS REGISTRATION REQUIREMENTS

#### Non Construction Contracts

P.L. 2004, c57 (Chapter 57) amends and supplements the business registration provisions of N.J.S.A. 52:32-44 which impose certain requirements upon a business competing for, or entering into a contract with a local contracting agency whose contracting activities are subject to the requirements of the Local Public Contracts Law (N.J.S.A. 40::11-2).

The CONSULTANT shall provide written notice to its subcontractors of the responsibility to submit proof of business registration to the CONSULTANT.

Before final payment on the contract is made by the contracting agency, the CONSULTANT shall submit an accurate list and the proof of business registration of each subcontractor or supplier used in the fulfillment of the contract, or shall attest that no subcontractors were used.

For the term of the contract, the CONSULTANT and each of its affiliates, and a subcontractor and each of its affiliates (N.J.S.A. 52:32-44 (g) (3)) shall collect and remit to the Director, New Jersey Division of Taxation, the use tax due pursuant to the Sales and Use Tax Act on all sales of tangible personal property delivered into this state, regardless of whether the tangible personal property is intended for a contract with a contracting agency.

A business organization that fails to provide a copy of a business registration as required pursuant to Section 1 of P.L. 2001, c. 134 (C.52:32-44 et seq.) or subsection e. or f. of Section 92 of P.L. 1977, c. 110 (C.5:12-92), or that provides false business registration information under the requirements of either of those sections, shall be liable for a penalty of \$25 for each day of violation, not to exceed \$50,000 for each business registration copy not properly provided under a contract with a contracting agency.

## **ARTICLE XVII**

### **City of Jersey City Contractor Pay-to-Play Reform Ordinance**

This contract was awarded in accordance with the City of Jersey City's Contractor Pay-to-Play Reform Ordinance 08-128 adopted on September 23, 2008. As such the undersigned does hereby attest that CONSULTANT, its subsidiaries, assigns or principals have neither made a reportable contribution in the one year period preceding



the date that the City Council awards the contract that would be deemed to be a violation of Ordinance 08-128, nor will CONSULTANT, its subsidiaries, assigns or principals make a reportable contribution during the term of the contract that would be in violation of Ordinance 08-128.

### **ARTICLE XVIII**

#### **City of Jersey City Lobbyist Disclosure Ordinance**

This contract was awarded in accordance with the provisions of the City's Disclosure of Lobbyist Representative Status Ordinance §3-9.1 et seq. adopted on June 12, 2002. As such the undersigned does hereby attest that CONSULTANT either did not retain the services of a lobbyist to lobby on behalf of the CONSULTANT for the award of this contract, or if a lobbyist was retained by the CONSULTANT for such purposes, the CONSULTANT'S lobbyist, prior to commencing his/her lobbying activities, filed a notice of lobbyist representative status form with the City Clerk. Any CONSULTANT whose lobbyist failed to comply with the provisions of Ordinance §3-9.1 et seq., following notice and an opportunity to be heard, shall be disqualified from entering into contracts with the City for a period of two (2) years for each violation.

IN WITNESS WHEREOF, the parties hereto have duly executed this Agreement  
on the date set forth above.

**CITY OF JERSEY CITY**

**ATTEST:**

\_\_\_\_\_  
BRIAN D. PLATT  
Business Administrator

\_\_\_\_\_  
ROBERT BYRNE  
City Clerk

Date: \_\_\_\_\_

Date: \_\_\_\_\_

**ATTEST:**

**FC3 ARCHITECTURE + DESIGN**

\_\_\_\_\_

BY: \_\_\_\_\_  
[NAME]  
[TITLE]

**APPROVED AS TO LEGAL FORM**

\_\_\_\_\_  
RAYMOND REDDINGTON  
Supervisory Assistant Corporation Counsel

**APPROVED FOR INSURANCE REQUIREMENTS**

\_\_\_\_\_  
MATTHEW HOGAN  
Risk Manager

10/29/2018

Requisition #
0184881

# CITY OF JERSEY CITY

394 CENTRAL AVE.  
2ND FLOOR  
JERSEY CITY NJ 07307

## Requisition

Assigned PO #

**Vendor**  
FC3 ARCHITECTURE + DESIGN, LLC  
9 KRISTEN COURT  
HAMBURG NJ 07419

**Dept. Bill To**  
ENG, TRAFF & TRANS  
13-15 LINDEN AVE. EAST  
JERSEY CITY NJ 07305

**Dept. Ship To**  
ENG, TRAFF & TRANS  
13-15 LINDEN AVE. EAST  
JERSEY CITY NJ 07305

FC873056

**Contact Info**  
Joe Cunha, Municipal Engineer  
2015474411

Quantity	UOM	Description	Account	Unit Price	Total
1.00	Q	18-015-E CITY HALL	04-215-55-116-990	16,950.00	16,950.00

ENCUMBERANCE FOR ENGINEERING CONSULTING SERVICES

PROPOSAL DATE: AUG. 3, 2018  
FOR FORMAL COST ESTIMATE TO SUBMIT TO FEMA AS A  
RESULT OF THE SUPERSTORM WHICH DAMAGED THE  
LOWER LEVEL OF THE HISTORIC JC CITY HALL

SCOPE OF BASIC SERVICES - NOT TO EXCEED \$16,950.00

AMOUNT OF THIS REQUISITION - \$16,950.00  
FUNDING SOURCE: 2016 ENGINEERING / PROF SERVICES

Requisition Total 16,950.00

Req. Date: 08/23/2018  
Requested By:   
Buyer Id:

Approved By: 

**This Is Not A Purchase Order**

*[Handwritten signature]*

Print Account

PO#	Vendor	Date	Reg#	Invoice/PO#	PO#	PO#	PO#
12470	WESTON	4/20/2018	00	31-57243	00	00	12470
12470	WESTON	5/17/2018	00	189-10-00	00	00	12470

4215-22-110-200

Print Account

DATE	DESCRIPTION	AMOUNT	DEBIT	CREDIT
1/24/2018	132727 HAZARDOUS WASTE	1,000.00		1,000.00
1/24/2018	132727 HAZARDOUS WASTE	1,000.00		1,000.00
1/24/2018	132727 HAZARDOUS WASTE	1,000.00		1,000.00

Budget Account

Account	Balance	Encumbrance	Total
2018	221,229.10	241,229.00	462,458.10
2017	2,728.70	1,877.70	4,606.40
2016	500,000.00	424,100.00	924,100.00

R-0184881-1695202

**SENT VIA EMAIL**

August 3, 2018

**Jose R. Cunha, P.E.,  
C.M.E., C.P.W.M., C.R.P.  
Director of Engineering  
Division of Engineering,  
Traffic and Transportation  
Department of Administration  
City of Jersey City  
Municipal Services Complex  
13-15 Linden Avenue East  
Jersey City, NJ 07305**

**RE: City Hall - 280 Grove Street  
Jersey City, NJ 07302**

**FC3 Project #1863**

Dear Mr. Jose R. Cunha, P.E.,

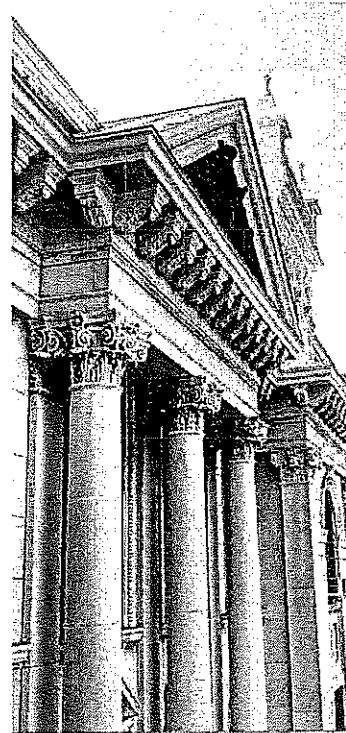

As you are aware my team and I have extensive experience with public projects and are very excited to work with you and other city officials on this important project. We are pleased to have the opportunity to prepare the following proposal for your consideration.

Once an NTP and/or Purchase Order is issued, FC3 Architecture+Design, LLC (FC3LLC), shall assist you by providing the following professional consulting services at the above-referenced location:

## **SCOPE OF BASIC SERVICES**

The Department of Administration requires a formal cost estimate to submit to FEMA officials as a result of a recent superstorm which damaged the lower level of the historic city hall facility located at the above-referenced address; FC3LLC will provide the following services associated with the relocation of approximately 20,000 SF of office space to the fourth-floor level of the building which is currently vacant:

1. Preliminary descriptive narrative of program and scope of work based on a conceptual design prepared by Others and based on our initial conversations and site visit meeting.
2. Preliminary building code review (excluding MEP) including barrier-free and fire protection.
3. Preliminary cost estimate based on program, scope of work, and building code review with detailed break-down by trade.

**EXCLUSIONS:**

Architectural/engineering design, working drawings, environmental, historical feasibility report, resilience report, site engineering, interior design, and/or any other scope of services on listed in "Scope of Basic Services" above.

**FEE**

Based on our experience with projects of similar size and scope we are anticipating the following allotment of hours to complete the services listed above:

	Rate	Hours	Proposed Fee
Registered Architect	200	5	\$ 1,000.00
Project Manager	150	26	\$ 3,900.00
Code Consultant	150	37	\$ 5,550.00
Construction Manager – Principal	150	10	\$ 1,500.00
Construction Manager – Scheduler	125	32	\$ 4,000.00
CAD/Production	125	5	\$ 625.00
Administrative Support	75	5	\$ 375.00

**Not to Exceed Fee \$16,950**

**PROPOSED PROJECT SCHEDULE:**

Week 1	City issues Purchase Order and/or Notice to Proceed to FC3LLC
Week 2	FC3LLC prepares narrative of scope of work and preliminary code analysis
Week 3	FC3LLC prepares preliminary cost estimate
Week 4	FC3LLC internal review of draft report (scope of work, code and cost estimate)
Week 5	FC3LLC meets with city officials to discuss first draft
Week 6	FC3LLC updates and finalizes report based on meeting
Week 7	FC3LLC meets with city officials to review report; Submit final report (electronic)

**BILLABLE RATES & REIMBURSABLE EXPENSES**

Registered Architect	\$ 200 / hour
Project Manager	\$ 150 / hour
Code Consultant	\$ 150 / hour
Construction Manager – Principal	\$ 150 / hour
Construction Manager – Scheduler	\$ 125 / hour
CAD/Production	\$ 125 / hour
Administrative Support	\$ 75 / hour
Outside Engineers / Consultants	Actual Cost x 1.25
Printing / Reproductions	Actual Cost x 1.5
Regular Mail / Overnight Mail	Actual Cost x 1.5

City Hall - 280 Grove Street  
Jersey City, NJ 07302  
FC3 Project #1863  
Page 3 of 3

**PROPOSED PAYMENT SCHEDULE:**

Invoices will be provided for your review and acceptance as the services are provided (assume 25%, 50%, 75% and 100% completion). Payment is due within 30 calendar days.

Please Note: Reimbursable expenses and additional time for services not included above will be billed hourly unless other arrangements are made.

Please note:

This proposal is valid for (10) business days and if accepted by the Owner shall be the only Agreement between the Owner and the Architect, FC3LLC. Any amendments to this Agreement shall be in writing and signed by both parties. In the event of a dispute between the Owner and the Architect, any claims for damages against the Architect related to the services provided by the Architect shall be limited to the payment received by FC3LLC pursuant to this Agreement.

We will begin promptly with the issuance of an NTP and/or Purchase Order.

Thank you for the opportunity to work with you on this important project!

Respectfully Submitted,  
**FC3 ARCHITECTURE+DESIGN, LLC**  
Certificate of Authorization NJ # AC-581

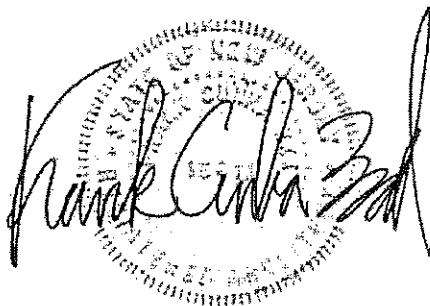
A handwritten signature in black ink, appearing to read "Frank Cunha III", is written over a circular professional seal. The seal contains text around its perimeter, including "NEW JERSEY ARCHITECTS" and "STATE OF NEW JERSEY".

Frank Cunha III, AIA, NCARB  
Principal, Registered Architect

ENCL

CC: 1863 Project File



**STATE OF NEW JERSEY  
BUSINESS REGISTRATION  
CERTIFICATE**

**Taxpayer Name:** FC3 ARCHITECTURE+DESIGN, LLC

**Trade Name:**

**Address:** 9 KRISTEN COURT  
HAMBURG, NJ 07419-9630

**Certificate Number:** 2261456

**Effective Date:** August 17, 2018

**Date of Issuance:** August 20, 2018

**For Office Use Only:**

20180820105005542



**STATE OF NEW JERSEY  
DEPARTMENT OF THE TREASURY  
DIVISION OF REVENUE AND ENTERPRISE SERVICES  
ANNUAL REPORT CERTIFICATE**

**FC3 ARCHITECTURE+DESIGN, LLC  
0600254921**

The Division of Revenue and Enterprise Services hereby affirms that the following annual report for FC3 ARCHITECTURE+DESIGN, LLC was submitted on 12/31/2017 for the year: 2017

**Registered Agent and Office**

FRANK CUNHA III  
9 KRISTEN COURT  
HAMBURG, NJ 07419-9630

**Main Business Address**

9 KRISTEN COURT  
HAMBURG, NJ 07419-9630

**Principal Business Address**

9 KRISTEN COURT  
HAMBURG, NJ 07419-9630

**Officers and Directors**

CHIEF EXEC. OFFICER (CEO)  
FRANK CUNHA  
9 KRISTEN COURT  
HAMBURG, NJ 07419



Certificate Number : 2305351853  
Verify this certificate online at  
[https://www1.state.nj.us/TYTR\\_StandingCert/JSP/Verify\\_Cert.jsp](https://www1.state.nj.us/TYTR_StandingCert/JSP/Verify_Cert.jsp)

*IN TESTIMONY WHEREOF, I have  
hereunto set my hand and affixed  
my Official Seal, this  
31st day of December, 2017*

A handwritten signature in black ink, appearing to read "Elizabeth Maher Muoio".

**Elizabeth Maher Muoio  
Acting State Treasurer**

State Of New Jersey  
 New Jersey Office of the Attorney General  
 Division of Consumer Affairs

THIS IS TO CERTIFY THAT THE  
 Board of Architects

HAS LICENSED

Frank Cunha III  
 9 Kristan Court  
 Hamburg, NJ 07419

FOR PRACTICE IN NEW JERSEY AS A(N): Registered Architect

05/30/2017 TO 07/31/2019  
 VALID

21A101641100  
 LICENSE/REGISTRATION/CERTIFICATION #

*Frank Cunha III*  
 DIRECTOR

Signature of Licensee/Registered/Qualifying Holder

PLEASE DETACH HERE  
 IF YOUR LICENSE/REGISTRATION/  
 CERTIFICATE ID CARD IS LOST  
 PLEASE NOTIFY:  
 Board of Architects  
 P.O. Box 45901  
 Newark, NJ 07101

THIS IS TO CERTIFY THAT THE  
 Board of Architects  
 HAS LICENSED  
 Frank Cunha III  
 9 Kristan Court  
 Hamburg, NJ 07419  
 FOR PRACTICE IN NEW JERSEY AS A(N): Registered Architect

05/30/2017 TO 07/31/2019  
 VALID

21A101641100  
 LICENSE/REGISTRATION/CERTIFICATION #

*Frank Cunha III*  
 DIRECTOR

Signature of Licensee/Registered/Qualifying Holder

PLEASE DETACH HERE  
 IF YOUR LICENSE/REGISTRATION/  
 CERTIFICATE ID CARD IS LOST  
 PLEASE NOTIFY:  
 Board of Architects  
 P.O. Box 45901  
 Newark, NJ 07101

THIS IS TO CERTIFY THAT THE  
 Board of Architects  
 HAS LICENSED  
 Frank Cunha III  
 9 Kristan Court  
 Hamburg, NJ 07419  
 FOR PRACTICE IN NEW JERSEY AS A(N): Registered Architect

05/30/2017 TO 07/31/2019  
 VALID

21A101641100  
 LICENSE/REGISTRATION/CERTIFICATION #

*Frank Cunha III*  
 DIRECTOR

Signature of Licensee/Registered/Qualifying Holder

PLEASE DETACH HERE  
 IF YOUR LICENSE/REGISTRATION/  
 CERTIFICATE ID CARD IS LOST  
 PLEASE NOTIFY:  
 Board of Architects  
 P.O. Box 45901  
 Newark, NJ 07101

THIS IS TO CERTIFY THAT THE  
 Board of Architects  
 HAS LICENSED  
 Frank Cunha III  
 9 Kristan Court  
 Hamburg, NJ 07419  
 FOR PRACTICE IN NEW JERSEY AS A(N): Registered Architect

05/30/2017 TO 07/31/2019  
 VALID

21A101641100  
 LICENSE/REGISTRATION/CERTIFICATION #

*Frank Cunha III*  
 DIRECTOR

Signature of Licensee/Registered/Qualifying Holder

State Of New Jersey  
 New Jersey Office of the Attorney General  
 Division of Consumer Affairs

THIS IS TO CERTIFY THAT THE  
 Board of Architects

HAS LICENSED

FC3 ARCHITECTURE+DESIGN LLC  
 FRANK CUNHA III  
 900 ALAM PLACE  
 RIDGEFIELD NJ 07657

FOR PRACTICE IN NEW JERSEY AS A(N): Certificate of Authorization

01/30/2018 TO 01/31/2020  
 VALID

21AC00058100  
 LICENSE/REGISTRATION/CERTIFICATION #

*Frank Cunha III*  
 ACTING DIRECTOR

Signature of Licensee/Registered/Qualifying Holder

PLEASE DETACH HERE  
 IF YOUR LICENSE/REGISTRATION/  
 CERTIFICATE ID CARD IS LOST  
 PLEASE NOTIFY:  
 Board of Architects  
 P.O. Box 45901  
 Newark, NJ 07101

THIS IS TO CERTIFY THAT THE  
 Board of Architects  
 HAS LICENSED  
 FC3 ARCHITECTURE+DESIGN LLC  
 FRANK CUNHA III  
 900 ALAM PLACE  
 RIDGEFIELD NJ 07657  
 FOR PRACTICE IN NEW JERSEY AS A(N): Certificate of Authorization

01/30/2018 TO 01/31/2020  
 VALID

21AC00058100  
 LICENSE/REGISTRATION/CERTIFICATION #

*Frank Cunha III*  
 ACTING DIRECTOR

Signature of Licensee/Registered/Qualifying Holder

PLEASE DETACH HERE  
 IF YOUR LICENSE/REGISTRATION/  
 CERTIFICATE ID CARD IS LOST  
 PLEASE NOTIFY:  
 Board of Architects  
 P.O. Box 45901  
 Newark, NJ 07101

THIS IS TO CERTIFY THAT THE  
 Board of Architects  
 HAS LICENSED  
 FC3 ARCHITECTURE+DESIGN LLC  
 FRANK CUNHA III  
 900 ALAM PLACE  
 RIDGEFIELD NJ 07657  
 FOR PRACTICE IN NEW JERSEY AS A(N): Certificate of Authorization

01/30/2018 TO 01/31/2020  
 VALID

21AC00058100  
 LICENSE/REGISTRATION/CERTIFICATION #

*Frank Cunha III*  
 ACTING DIRECTOR

Signature of Licensee/Registered/Qualifying Holder

PLEASE DETACH HERE  
 IF YOUR LICENSE/REGISTRATION/  
 CERTIFICATE ID CARD IS LOST  
 PLEASE NOTIFY:  
 Board of Architects  
 P.O. Box 45901  
 Newark, NJ 07101

THIS IS TO CERTIFY THAT THE  
 Board of Architects  
 HAS LICENSED  
 FC3 ARCHITECTURE+DESIGN LLC  
 FRANK CUNHA III  
 900 ALAM PLACE  
 RIDGEFIELD NJ 07657  
 FOR PRACTICE IN NEW JERSEY AS A(N): Certificate of Authorization

01/30/2018 TO 01/31/2020  
 VALID

21AC00058100  
 LICENSE/REGISTRATION/CERTIFICATION #

*Frank Cunha III*  
 ACTING DIRECTOR

Signature of Licensee/Registered/Qualifying Holder

PLEASE DETACH HERE  
 IF YOUR LICENSE/REGISTRATION/  
 CERTIFICATE ID CARD IS LOST  
 PLEASE NOTIFY:  
 Board of Architects  
 P.O. Box 45901  
 Newark, NJ 07101

THIS IS TO CERTIFY THAT THE  
 Board of Architects  
 HAS LICENSED  
 FC3 ARCHITECTURE+DESIGN LLC  
 FRANK CUNHA III  
 900 ALAM PLACE  
 RIDGEFIELD NJ 07657  
 FOR PRACTICE IN NEW JERSEY AS A(N): Certificate of Authorization

01/30/2018 TO 01/31/2020  
 VALID

21AC00058100  
 LICENSE/REGISTRATION/CERTIFICATION #

*Frank Cunha III*  
 ACTING DIRECTOR

Signature of Licensee/Registered/Qualifying Holder

PLEASE DETACH HERE  
 IF YOUR LICENSE/REGISTRATION/  
 CERTIFICATE ID CARD IS LOST  
 PLEASE NOTIFY:  
 Board of Architects  
 P.O. Box 45901  
 Newark, NJ 07101

THIS IS TO CERTIFY THAT THE  
 Board of Architects  
 HAS LICENSED  
 FC3 ARCHITECTURE+DESIGN LLC  
 FRANK CUNHA III  
 900 ALAM PLACE  
 RIDGEFIELD NJ 07657  
 FOR PRACTICE IN NEW JERSEY AS A(N): Certificate of Authorization

01/30/2018 TO 01/31/2020  
 VALID

21AC00058100  
 LICENSE/REGISTRATION/CERTIFICATION #

*Frank Cunha III*  
 ACTING DIRECTOR

Signature of Licensee/Registered/Qualifying Holder

PLEASE DETACH HERE  
 IF YOUR LICENSE/REGISTRATION/  
 CERTIFICATE ID CARD IS LOST  
 PLEASE NOTIFY:  
 Board of Architects  
 P.O. Box 45901  
 Newark, NJ 07101

THIS IS TO CERTIFY THAT THE  
 Board of Architects  
 HAS LICENSED  
 FC3 ARCHITECTURE+DESIGN LLC  
 FRANK CUNHA III  
 900 ALAM PLACE  
 RIDGEFIELD NJ 07657  
 FOR PRACTICE IN NEW JERSEY AS A(N): Certificate of Authorization

01/30/2018 TO 01/31/2020  
 VALID

21AC00058100  
 LICENSE/REGISTRATION/CERTIFICATION #

*Frank Cunha III*  
 ACTING DIRECTOR

Signature of Licensee/Registered/Qualifying Holder

PRINT YOUR NEW MAILING ADDRESS BELOW  
 YOUR MAILING ADDRESS IS THE ADDRESS THAT WILL BE USED BY  
 THE DIVISION OF CONSUMER AFFAIRS TO SEND YOU ALL  
 CORRESPONDENCE

HOME  BUSINESS

TELEPHONE  
 INCLUDE AREA CODE

If the law governing your profession requires the current license/registration/certificate to be displayed, it should be within reasonable proximity of your original license/registration/certificate at your principal office or place of business.

PRINT YOUR NEW MAILING ADDRESS BELOW  
 YOUR MAILING ADDRESS IS THE ADDRESS THAT WILL BE USED BY  
 THE DIVISION OF CONSUMER AFFAIRS TO SEND YOU ALL  
 CORRESPONDENCE

HOME  BUSINESS

TELEPHONE  
 INCLUDE AREA CODE

If the law governing your profession requires the current license/registration/certificate to be displayed, it should be within reasonable proximity of your original license/registration/certificate at your principal office or place of business.

**STATE OF NEW JERSEY  
DEPARTMENT OF THE TREASURY  
DIVISION OF REVENUE AND ENTERPRISE SERVICES  
SHORT FORM STANDING**

**FC3 ARCHITECTURE+DESIGN, LLC**

0600254921

*I, the Treasurer of the State of New Jersey, do hereby certify that the above-named New Jersey Domestic Limited Liability Company was registered by this office on December 9, 2005.*

*As of the date of this certificate, said business continues as an active business in good standing in the State of New Jersey, and its Annual Reports are current.*

*I further certify that the registered agent and registered office are:*

*Frank Cunha Iii  
9 Kristen Court  
Hamburg, NJ 07419 9630*



Certification# 131768015

*IN TESTIMONY WHEREOF, I have  
hereunto set my hand and affixed my  
Official Seal at Trenton, this  
2nd day of April, 2014*

A handwritten signature in black ink, appearing to read "Andrew P. Sidamon-Eristoff".

*Andrew P. Sidamon-Eristoff  
State Treasurer*

Verify this certificate at  
[https://www1.state.nj.us/TYTR\\_StandingCert/JSP/Verify\\_Cert.jsp](https://www1.state.nj.us/TYTR_StandingCert/JSP/Verify_Cert.jsp)

158

APPLICATION FOR AUTHORITY  
OF  
FC3 ARCHITECTURE+DESIGN, LLC

(Insert name of Foreign Professional Services Limited Liability Company)

Under Section 1306 of the Limited Liability Company Law

Filed by: FRANK CUNHA, III  
(Name)  
9 KRISTEN COURT  
(Mailing address)  
HAMBURG, NJ 07419  
(City, State and ZIP code)

NOTE: This form was prepared by the New York State Department of State for filing an application for authority by a foreign professional service limited liability company. It does not contain all optional provisions under the law. You are not required to use this form. You may draft your own form or use forms available at legal supply stores. The Department of State recommends that legal documents be prepared under the guidance of an attorney. The certificate must be submitted with a \$200 filing fee made payable to the Department of State.

STATE OF NEW YORK  
DEPARTMENT OF STATE  
APR 14 2014

FILED

2014 APR 14 AM 10:16  
For office use only

RECEIVED  
2014 APR 14 AM 10:05

TAX \$ \_\_\_\_\_  
BY: \_\_\_\_\_  
RECEIVED  
CORPORATION UNIT  
APR 26 2014 11:35

168

**NON COLLUSION AFFIDAVIT**  
STATE OF NEW JERSEY  
CITY OF JERSEY CITY ss:

I certify that I am CEO / Principal

of the firm of FC3 Architecture + Design, LLC

the bidder making the proposal for the above named project, and that I executed the said proposal with full authority so to do; that said bidder has not, directly or indirectly entered into any agreement, participated in any collusion, or otherwise taken any action in restraint of free, competitive bidding in connection with the above named project; and that all statements contained in said proposal and in this affidavit are true and correct, and made with full knowledge that the City of Jersey City relies upon the truth of the statements contained in said proposal and in the statements contained in this affidavit in awarding the contract for the said project.

I further warrant that no person or selling agency has been employed to solicit or secure such contract upon an agreement or understanding for a commission, percentage, brokerage or contingent fee, except bona fide employees or bona fide established commercial or selling agencies maintained by (N.J.S.A.52: 34-25).

(Signature of respondent)

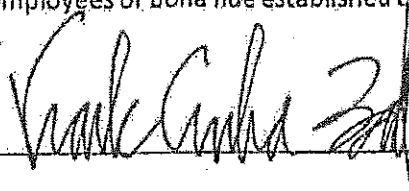

SUBSCRIBED AND SWORN TO  
BEFORE ME THIS DAY Aug 8th OF 20 18  
(TYPE OR PRINT NAME OF AFFIANT UNDER SIGNATURE)

NOTARY PUBLIC OF  
MY COMMISSION EXPIRES: 2020 Dec 22

Nina Razzak

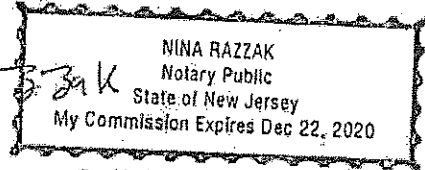

(NOTE: THIS FORM MUST BE COMPLETED, NOTARIZED AND RETURNED WITH THIS PROPOSAL)

**NEW VENDOR INFORMATION FORM**

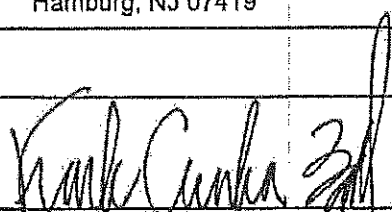
VENDOR NAME: FC3 Architecture + Design, LLC		FEDERAL IDENTIFICATION NO. (FEIN) 20-4349256	
STREET ADDRESS: 9 Kristen Court		CITY/STATE/ZIP: Hamburg, NJ 07419	
TEL/EXT #: (201) 681-3551		FAX #: N/A	
VENDOR CONTACT/AUTHORIZED REP NAME:			
PRINT NAME: Frank Cunha III		SIGNATURE: 	
CONTACT #: (201) 681-3551		FAX #: N/A	EMAIL: fcunha@fc3arch.com
<b>PAYMENT/REMITTANCE ADDRESS:</b>			
NAME/ATTN TO: Frank Cunha III		STREET ADDRESS: 9 Kristen Court	
CITY/STATE/ZIP: Hamburg, NJ 07419			
TEL #: (201) 681-3551		FAX #: N/A	EMAIL: fcunha@fc3arch.com
DESCRIPTION OF GOODS/SERVICES TO BE RENDERED:  Professional Services Architectural Design and Consulting Code Review Construction Management Project Management			Are you related to any City Employee? <input type="checkbox"/> Yes <input checked="" type="checkbox"/> No
			Are you employed by the City of Jersey City? <input type="checkbox"/> Yes <input checked="" type="checkbox"/> No
			Form 1099 Required? <input type="checkbox"/> Yes <input type="checkbox"/> No
EEO/AFFIRMATIVE ACTION (Please select and provide the state's certification):			
<input type="checkbox"/> MBE (Minority-Owned) <input type="checkbox"/> LGBTQ <input type="checkbox"/> VBE (Veteran) <input checked="" type="checkbox"/> Caucasian/White <input type="checkbox"/> African American/Black <input type="checkbox"/> PWD (Disabled) <input type="checkbox"/> Hispanic/Latino <input type="checkbox"/> SBE (Small Business) <input type="checkbox"/> Asian/Pacific Islands <input type="checkbox"/> MWBE (Women-Owned) <input type="checkbox"/> Native American/Indian			
NON-PROFIT? <input type="checkbox"/> Yes (include non-profit certification) <input checked="" type="checkbox"/> No			
<b>PLEASE SELECT IF ACTIVELY PARTICIPATING IN ANY CONTRACTS BELOW</b>			
<input type="checkbox"/> State Contract	<input type="checkbox"/> WSCA/NASPO	<input type="checkbox"/> GSA	<input type="checkbox"/> US Communities
<input type="checkbox"/> NCPA	<input type="checkbox"/> PEPPM	<input type="checkbox"/> TIPS	<input type="checkbox"/> NPP Gov
<input type="checkbox"/> MRESC/ESCNJ	<input type="checkbox"/> KPN	<input type="checkbox"/> HGAC-Buy	<input type="checkbox"/> Other
<input type="checkbox"/> NIPA/TCPN			
<input type="checkbox"/> NJPA Contract #			
CITY EMPLOYEE REQUESTING VENDOR NUMBER:			
PRINT NAME:		SIGNATURE:	EXT.:
<b>PURCHASING DIVISION USE ONLY</b>			
VENDOR NO. ISSUED BY:		TITLE:	DATE: ___/___/___
VENDOR NUMBER ASSIGNED:		BRC (Business Registration Certificate) #:	

**(THE W9 FORM & BUSINESS REGISTRATION CERTIFICATE MUST BE INCLUDED WITH THIS FORM. TO APPLY FOR A BUSINESS REGISTRATION CERTIFICATE, CALL 609-292-9292 OR GO TO [HTTP://WWW.NJ.GOV/TREASURY/REVENUE/BUSREGCERT.SHTML](http://www.nj.gov/treasury/revenue/busregcert.shtml))**

EXHIBIT A (Continuation)

The contractor or subcontractor agrees to inform in writing its appropriate recruitment agencies including, but not limited to, employment agencies, placement bureaus, colleges, universities, and labor unions, that it does not discriminate on the basis of age, race, creed, color, national origin, ancestry, marital status, affectional or sexual orientation, gender identity or expression, disability, nationality or sex, and that it will discontinue the use of any recruitment agency which engages in direct or indirect discriminatory practices.

The contractor or subcontractor agrees to revise any of its testing procedures, if necessary, to assure that all personnel testing conforms with the principles of job-related testing, as established by the statutes and court decisions of the State of New Jersey and as established by applicable Federal law and applicable Federal court decisions.

In conforming with the targeted employment goals, the contractor or subcontractor agrees to review all procedures relating to transfer, upgrading, downgrading and layoff to ensure that all such actions are taken without regard to age, race, creed, color, national origin, ancestry, marital status, affectional or sexual orientation, gender identity or expression, disability, nationality or sex, consistent with the statutes and court decisions of the State of New Jersey, and applicable Federal law and applicable Federal court decisions.

The contractor shall submit to the public agency, after notification of award but prior to execution of a goods and services contract, one of the following three documents:

Letter of Federal Affirmative Action Plan Approval

Certificate of Employee Information Report

Employee Information Report Form AA302 (electronically provided by the Division and distributed to the public agency through the Division's website at [www.state.nj.us/treasury/contract/compliance/](http://www.state.nj.us/treasury/contract/compliance/))

The contractor and its subcontractors shall furnish such reports or other documents to the Division of Purchase & Property, CCAU, EEO Monitoring Program as may be requested by the office from time to time in order to carry out the purposes of these regulations, and public agencies shall furnish such information as may be requested by the Division of Purchase & Property, CCAU, EEO Monitoring Program for conducting a compliance investigation pursuant to Subchapter 10 of the Administrative Code at N.J.A.C. 17:27.

The undersigned vendor certifies on their company's receipt, knowledge and commitment to comply with:

EXHIBIT A  
N.J.S.A. 10:5-31 and N.J.A.C. 17:27  
MANDATORY EQUAL EMPLOYMENT OPPORTUNITY LANGUAGE  
Goods, Professional Services and General Service Contracts  
(Mandatory Affirmative Action Language)

The undersigned vendor further agrees to furnish the required forms of evidence and understands that their contract/company's bid shall be rejected as non-responsive if said contractor fails to comply with the requirements of N.J.S.A. 10:5-31 and N.J.A.C. 17:27.

Representative's Name/Title (Print) Frank Cunha III / Principal

Representative's Signature: 

Name of Company: FC3 Architecture + Design, LLC

Tel. No.: (201) 881-3551

Date: August 8, 2018

**APPENDIX A**  
**AMERICANS WITH DISABILITIES ACT OF 1990**  
**Equal Opportunity for Individuals with Disability**

The contractor and the \_\_\_\_\_ of \_\_\_\_\_ (hereafter "owner") do hereby agree that the provisions of Title II of the Americans With Disabilities Act of 1990 (the "Act") (42 U.S.C. 5121 01 et seq.), which prohibits discrimination on the basis of disability by public entities in all services, programs, and activities provided or made available by public entities, and the rules and regulations promulgated pursuant thereto, are made a part of this contract. In providing any aid, benefit, or service on behalf of the owner pursuant to this contract, the contractor agrees that the performance shall be in strict compliance with the Act. In the event that the contractor, its agents, servants, employees, or subcontractors violate or are alleged to have violated the Act during the performance of this contract, the contractor shall defend the owner in any action or administrative proceeding commenced pursuant to this Act. The contractor shall indemnify, protect, and save harmless the owner, its agents, servants, and employees from and against any and all suits, claims, losses, demands, or damages, of whatever kind or nature arising out of or claimed to arise out of the alleged violation. The contractor shall, at its own expense, appear, defend, and pay any and all charges for legal services and any and all costs and other expenses arising from such action or administrative proceeding or incurred in connection therewith. In any and all complaints brought pursuant to the owner's grievance procedure, the contractor agrees to abide by any decision of the owner which is rendered pursuant to said grievance procedure. If any action or administrative proceeding results in an award of damages against the owner, or if the owner incurs any expense to cure a violation of the ADA which has been brought pursuant to its grievance procedure, the contractor shall satisfy and discharge the same at its own expense.

The owner shall, as soon as practicable after a claim has been made against it, give written notice thereof to the contractor along with full and complete particulars of the claim. If any action or administrative proceeding is brought against the owner or any of its agents, servants, and employees, the owner shall expeditiously forward or have forwarded to the contractor every demand, complaint, notice, summons, pleading, or other process received by the owner or its representatives.

It is expressly agreed and understood that any approval by the owner of the services provided by the contractor pursuant to this contract will not relieve the contractor of the obligation to comply with the Act and to defend, indemnify, protect, and save harmless the owner pursuant to this paragraph.

It is further agreed and understood that the owner assumes no obligation to indemnify or save harmless the contractor, its agents, servants, employees and subcontractors for any claim which may arise out of their performance of this Agreement. Furthermore, the contractor expressly understands and agrees that the provisions of this indemnification clause shall in no way limit the contractor's obligations assumed in this Agreement, nor shall they be construed to relieve the contractor from any liability, nor preclude the owner from taking any other actions available to it under any other provisions of the Agreement or otherwise at law.

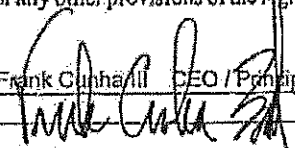
Representative's Name/Title Print): Frank Cunha III CEO / Principal  
Representative's Signature:   
Name of Company: Frank Cunha III  
Tel. No.: (201) 681-3551 Date: August 8, 2018



**Minority/Woman Business Enterprise (MWBE)  
Questionnaire for Bidders**

Jersey City Ordinance C-829 establishes a goal of awarding 20% of the dollar amount of total city procurement to minority and woman owned business enterprises.

To assist us in monitoring our achievement of this goal, please indicate below whether your company is or is not a minority owned and/or woman owned business, and return this form with your bid proposal.

Business Name : FC3 Architecture + Design, LLC  
Address : 9 Kristen Court, Hamburg, NJ 07419  
Telephone No. : (201) 681-3551  
Contact Name : Frank Cunha III

Please check applicable category :

Minority Owned Business (MBE)       Minority & Woman Owned Business (MWBE)  
 Woman Owned business (WBE)       Neither

**Definitions**

**Minority Business Enterprise**

Minority Business Enterprise means a business which is a sole proprietorship, partnership or corporation at least 51% of which is owned and controlled by persons who are African American, Hispanic, Asian American, American Indian or Alaskan native, defined as follows:

**African American:** a person having origins in any of the black racial groups of Africa

**Hispanic:** a person of Mexican, Puerto Rican, Central or South American or other non-European Spanish culture or origin regardless of race.

**Asian:** a person having origins in any of the original peoples of the Far East, South East Asia, Indian subcontinent, Hawaii or the Pacific Islands.

**American Indian or Alaskan Native:** a person having origins in any of the original peoples of North America and who maintains cultural identification through tribal affiliation or community recognition.

**Woman Business Enterprise**

Woman Business Enterprise means a business which is a sole proprietorship, partnership or corporation at least 51% of which is owned and controlled by a woman or women.

**OFFICE OF EQUAL OPPORTUNITY COPY**

**Minority/Woman Business Enterprise (MWBE)  
Questionnaire for Bidders**

Jersey City Ordinance C-829 establishes a goal of awarding 20% of the dollar amount of total city procurement to minority and woman owned business enterprises.

To assist us in monitoring our achievement of this goal, please indicate below whether your company is or is not a minority owned and/or woman owned business, and return this form with your bid proposal.

Business Name: FC3 Architecture + Design, LLC

Address: 9 Kristen Court, Hanburg, NJ 07419

Telephone No.: (201) 681-3551

Contact Name: Frank Cunha III

Please check applicable category:

Minority Owned Business (MBE)

Minority & Woman Owned Business (MWBE)

Woman Owned business (WBE)

Neither

**Definitions**

**Minority Business Enterprise**

Minority Business Enterprise means a business which is a sole proprietorship, partnership or corporation at least 51% of which is owned and controlled by persons who are African American, Hispanic, Asian American, American Indian or Alaskan native, defined as follows:

**African American:** a person having origins in any of the black racial groups of Africa

**Hispanic:** a person of Mexican, Puerto Rican, Central or South American or other non-European Spanish culture or origin regardless of race.

**Asian:** a person having origins in any of the original peoples of the Far East, South East Asia, Indian subcontinent, Hawaii or the Pacific Islands.

**American Indian or Alaskan Native:** a person having origins in any of the original peoples of North America and who maintains cultural identification through tribal affiliation or community recognition.

**Woman Business Enterprise**

Woman Business Enterprise means a business which is a sole proprietorship, partnership or corporation at least 51% of which is owned and controlled by a woman or women.

**DIVISION OF PURCHASING COPY**



**Part IV CERTIFICATION**

I, being duly sworn upon my oath, hereby represent that the foregoing information and any attachments thereto to the best of my knowledge are true and complete. I acknowledge: that I am authorized to execute this certification on behalf of the bidder/proposer; that the City of Jersey City is relying on the information contained herein and that I am under a continuing obligation from the date of this certification through the completion of any contracts with the City of Jersey City to notify the City of Jersey City in writing of any changes to the information contained herein; that I am aware that it is a criminal offense to make a false statement or misrepresentation of this certification, and if I do so, I am subject to criminal prosecution under law and that it will constitute a material breach of my agreement(s) with the, permitting the City of Jersey City to declare any contract(s) resulting from this certification void and unenforceable.

Full Name (Print):	Frank Cunha III	Title:	CEO / Principal
Signature:		Date:	August 8, 2018

SIGNATURE: \_\_\_\_\_

TITLE: CEO / Principal

SUBSCRIBED AND SWORN TO Aug 8th OF 20 18  
BEFORE ME THIS DAY

(TYPE OR PRINT NAME OF AFFIANT UNDER SIGNATURE)

*Nina Razzak*

NOTARY PUBLIC OF NINA RAZZAK  
MY COMMISSION EXPIRES: 2020

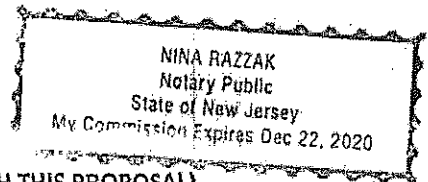

(NOTE: THIS FORM MUST BE COMPLETED, NOTARIZED AND RETURNED WITH THIS PROPOSAL).

STATEMENT OF OWNERSHIP DISCLOSURE

N.J.S.A. 52:25-24.2 (P.L. 1977, c33, as amended by P.L. 2016, c43)

This statement shall be completed, certified to, and included with all bid and proposal submissions. Failure to submit the required information is cause for automatic rejection of the bid or proposal.

Name of Organization:

FC3 Architecture + Design, LLC

Organization Address:

9 Kristen Court Hamburg NJ 07419

Part I Check the box that represents the type of business organization:

- Sole Proprietorship (skip Parts II and III, execute certification in Part IV)
- Non-Profit Corporation (skip Parts II and III, execute certification in Part IV)
- For-Profit Corporation (any type)       Limited Liability Company (LLC)
- Partnership       Limited Partnership       Limited Liability Partnership (LLP)

Part II

- The list below contains the names and addresses of all stockholders in the corporation who own 10 percent or more of its stock, of any class, or all individual partners in the partnership who own a 10 percent or greater interest therein, or of all members in the limited liability company who own a 10 percent or greater interest therein, as the case may be. **(COMPLETE THE LIST BELOW IN THIS SECTION)**

OR

- No one stockholder in the corporation owns 10 percent or more of its stock, of any class, or no individual partner in the partnership owns a 10 percent or greater interest therein, or no member in the limited liability company owns a 10 percent or greater interest therein, as the case may be. **(SKIP TO PART IV)**

**Part III DISCLOSURE OF 10% OR GREATER OWNERSHIP IN THE STOCKHOLDERS, PARTNERS OR LLC MEMBERS LISTED IN PART II**

If a bidder has a direct or indirect parent entity which is publicly traded, and any person holds a 10 percent or greater beneficial interest in the publically traded parent entity as of the last annual federal Security and Exchange Commission (SEC) or foreign equivalent filing, ownership disclosure can be met by providing links to the website(s) containing the last annual filing(s) with the federal Securities and Exchange Commission (or foreign equivalent) that contain the name and address of each person holding a 10% or greater beneficial interest in the publicly traded parent entity, along with the relevant page numbers of the filing(s) that contain the information on each such person. Attach additional sheets if more space is needed.

Website (URL) containing the last annual SEC (or foreign equivalent) filing	Page #'s
N/A	

Please list the names and addresses of each stockholder, partner or member owning a 10 percent or greater interest in any corresponding corporation, partnership and/or limited liability company (LLC) listed in Part II other than for any publicly traded parent entities referenced above. The disclosure shall be continued until names and addresses of every noncorporate stockholder, and individual partner, and member exceeding the 10 percent ownership criteria established pursuant to N.J.S.A. 52:25-24.2 has been listed. Attach additional sheets if more space is needed.

Stockholder/Partner/Member and Corresponding Entity Listed in Part II	Home Address (for Individuals) or Business Address
N/A	

**(Please attach additional sheets if more space is needed):**

<b>Name of Individual or Business Entity</b>	<b>Home Address (for Individuals) or Business Address</b>
Frank Cunha III	9 Kristen Court Hamburg, NJ 07419

**CERTIFICATION OF COMPLIANCE WITH THE CITY OF JERSEY CITY  
CONTRACTOR PAY-TO-PLAY REFORM ORDINANCE 08-128 ADOPTED  
ON SEPTEMBER 3, 2008**

**PART I - Vendor Affirmation**

The undersigned, being authorized and knowledgeable of the circumstances, does hereby certify that FC3 Architecture + Design, LLC (name of business entity) has not made any reportable contributions in the \*\*one-year period preceding 2018 (date City Council awards contract) that would be deemed to be violations of Section One of the City of Jersey City's Contractor Pay-to-Play Reform Ordinance 08-128 (attached hereto) and that would bar the award of this contract. I further certify that during the term of the contract FC3 Architecture + Design, LLC (name of business entity) will not make any reportable contributions in violation of Ordinance 08-128.

**PART II - Signature and Attestation:**

The undersigned is fully aware that if I have misrepresented in whole or part this affirmation and certification, I and/or the business entity, will be liable for any penalty permitted under law.

Name of Business Entity: FC3 Architecture + Design, LLC  
Signed: [Signature] Title: CEO / Principal  
Print Name: Frank Cunha III Date: August 8, 2018

Subscribed and sworn before me  
this 8<sup>th</sup> day of Aug, 2018.  
My Commission expires: Dec 22 2020  
Nina Bazzak (Affiant)  
(Print name & title of affiant) (Corporate Seal)

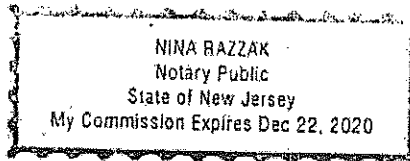

\*\*Pursuant to Section 2 of Ordinance 08-128, no contributions or solicitation of contributions made prior to the effective date Ordinance 08-128 (September 23, 2008) shall be deemed to be a violation of the Ordinance.



## "New Jersey Business Registration Requirements" For Goods, Professional Service and General Service Contracts

The contractor shall provide written notice to its subcontractors of the responsibility to submit proof of business registration to the contractor.

Before final payment on the contract is made by the contracting agency, the contractor shall submit an accurate list and the proof of business registration of each subcontractor or supplier used in the fulfillment of the contract, or shall attest that no subcontractors were used.

For the term of the contract, the contractor and each of its affiliates and a subcontractor and each of its affiliates [N.J.S.A. 52:32-44(g)(3)] shall collect and remit to the Director, New Jersey Division of Taxation, the use tax due pursuant to the Sales and Use Tax Act on all sales of tangible personal property delivered into this State, regardless of whether the tangible personal property is intended for a contract with a contracting agency.

A business organization that fails to provide a copy of a business registration as required pursuant to section 1 of P.L.2001, c.134 (C.52:32-44 et al.) or subsection e. or f. of section 92 of P.L.1977, c.110 (C.5:12-92), or that provides false business registration information under the requirements of either of those sections, shall be liable for a penalty of \$25 for each day of violation, not to exceed \$50,000 for each business registration copy not properly provided under a contract with a contracting agency."

STATE OF NEW JERSEY  
BUSINESS REGISTRATION CERTIFICATE  
FOR STATE AGENCY AND GENERAL SERVICE CONTRACTS

TAXPAYER NAME: TAX REGISTRATION TEST ACCOUNT  
TAXPAYER IDENTIFICATION: [illegible]  
ADDRESS: [illegible]  
ISSUANCE DATE: [illegible]

Signature: J.P. S. [illegible]

STATE OF NEW JERSEY  
BUSINESS REGISTRATION CERTIFICATE

Taxpayer Name: TAX REG TEST ACCOUNT  
Trade Name: [illegible]  
Address: 847 ROBINSON AVE  
TRENTON, NJ 08611  
Certificate Number: 1043907  
Date of Issuance: October 14, 2004

For Office Use Only:  
202-219-4113/2623032

**BUSINESS ENTITY DISCLOSURE CERTIFICATION  
FOR NON FAIR AND OPEN CONTRACTS  
Required Pursuant To N.J.S.A. 19:44A-20.8  
CITY OF JERSEY CITY**

**Part I - Vendor Affirmation**

The undersigned, being authorized and knowledgeable of the circumstances, does hereby certify that the *<name of business entity>* has not made and will not make any reportable contributions pursuant to N.J.S.A. 19:44A-1 et seq. that pursuant to P.L. 2004, c. 19 would bar the award of this contract in the one year period preceding *(date of award scheduled for approval of the contract by the governing body)* to any of the following named candidate committee, joint candidates committee, or political party committee representing the elected officials of the *<name of entity of elected officials>* as defined pursuant to N.J.S.A. 19:44A-3(p), (q) and (r).

Steven Fulop for Mayor 2017	Mira Prinz-Arey for Council
Lavario for Councilman	Friends of Richard Boggiano
Friends of Joyce Watterman	Michael Ynn for Council
Friends of Daniel Rivera	Salomon for Council
Ridley for Council	Friends of Jermaine Robinson

**Part II - Ownership Disclosure Certification**

I certify that the list below contains the names and home addresses of all owners holding 10% or more of the issued and outstanding stock of the undersigned.

Check the box that represents the type of business entity:

- Partnership   
  Corporation   
  Sole Proprietorship   
  Subchapter S Corporation  
 Limited Partnership   
 Limited Liability Corporation   
 Limited Liability Partnership

Name of Stock or Shareholder	Home Address
Frank Cunha III	9 Kristen Court, Hamburg, NJ 07419

**Part 3 - Signature and Attestation:**

The undersigned is fully aware that if I have misrepresented in whole or part this affirmation and certification, I and/or the business entity will be liable for any penalty permitted under law.

Name of Business Entity: FCB Architecture + Design, LLC

Signature of Affiant: *Frank Cunha III*

Title: CEO / Principal

Printed Name of Affiant: Frank Cunha III

Date: August 8, 2018

Subscribed and sworn before me this Aug 8<sup>th</sup> day of 2018

My Commission expires: Dec 22 2020

Nina Razzak

(Witnessed or attested by)

(Seal) NINA RAZZAK  
Notary Public

State of New Jersey  
My Commission Expires Dec 22, 2020

**STATE OF NEW JERSEY**  
Division of Purchase & Property  
Contract Compliance Audit Unit  
EEO Monitoring Program

**EMPLOYEE INFORMATION REPORT**

IMPORTANT-READ INSTRUCTIONS CAREFULLY BEFORE COMPLETING FORM. FAILURE TO PROPERLY COMPLETE THE ENTIRE FORM AND TO SIGNOFF THE REQUIRED SECTIONS MAY DELAY RESPONSE OF YOUR CONTRACT. DO NOT SIGNOFF EEO REPORT FOR SECTION 8, ITEM 14, FOR FAILURE TO DISCLOSE ANY INFORMATION. DO NOT SIGNOFF EEO REPORT FOR SECTION 8, ITEM 14, FOR FAILURE TO DISCLOSE ANY INFORMATION.

**SECTION A - COMPANY IDENTIFICATION**

1. EEO NO. OR SOCIAL SECURITY: **20-4349256**

2. TYPE OF BUSINESS:  
 1. MFG.  2. SERVICE  3. WHOLESALE  
 4. RETAIL  5. OTHER

3. TOTAL NO. EMPLOYEES IN THE ENTIRE COMPANY: **1**

4. COMPANY NAME: **FC3 Architecture + Design, LLC**

5. STREET: **9 Kristen Court** CITY: **Hamburg** COUNTY: **Sussex** STATE: **NJ** ZIP CODE: **07419**

6. NAME OF PARENT OR AFFILIATED COMPANY (IF NONE, SO INDICATE): **None** CITY: STATE: ZIP CODE:

7. A. IS THE COMPANY:  SINGLE ESTABLISHMENT EMPLOYER  MULTIPLE ESTABLISHMENT EMPLOYER

8. IF MULTIPLE ESTABLISHMENT EMPLOYER, STATE THE NUMBER OF ESTABLISHMENTS: **1**

9. TOTAL NUMBER OF EMPLOYEES AT ESTABLISHMENT WHICH HAS BEEN AWARDED THE CONTRACT: **1**

10. ADDRESS OF ESTABLISHMENT: CITY: COUNTY: STATE: ZIP CODE:

Official Use Only: DATE RECEIVED: RECEIVED BY: ASSIGNED TO: DATE APPROVED:

**SECTION B - EMPLOYMENT DATA**

11. Report all permanent, temporary and part-time employees ON YOUR CHECK PAYROLL. List the appropriate figures in all boxes and in all columns. Where there are no employees in a particular category, enter a zero. Include ALL employees, not just those in minority/non-minority categories, in columns 1, 2, & 3. **DO NOT SUMMIT AVOID REPORT**

JOB CATEGORIES	ALL EMPLOYEES			PERMANENT MINORITY/WHOLE MINORITY EMPLOYEE BREAKDOWN										
	COL 1 TOTAL (COL 2 & 3)	COL 2 MALE	COL 3 FEMALE	MALE					FEMALE					
				BLACK	HISPANIC	AMER. INDIAN	ASIAN	NON-MIN.	BLACK	HISPANIC	AMER. INDIAN	ASIAN	NON-MIN.	
Officials/Managers														
Professionals		1							1					
Technicians														
Sales Workers														
Office & Clerical														
Craftworkers (Skilled)														
Operatives (Semi-skilled)														
Laborers (Unskilled)														
Service Workers														
TOTAL														
Total employment from previous Report (if any)														
Temporary & Part-Time Employees	The data below shall NOT be included in the figures for the appropriate categories above													

12. HOW WAS INFORMATION AS TO RACE OR ETHNIC GROUP INFORMATION OBTAINED?  
 1. Visual Survey  2. Employment Record  3. Other (Specify):

14. IS THIS THE FIRST Employee Information Report Submitted? YES  NO

13. IF NO DATE LAST REPORT SUBMITTED: MO. DAY YEAR

15. DATES OF PAYROLL PERIOD USED: From: To:

SECTION C SIGNATURE AND IDENTIFICATION

16. NAME OF PERSON COMPLETING FORM: **Frank Cunha III** TITLE: **CEO / Principal** DATE: **08 / 08 / 2018**

17. ADDRESS NO. & STREET: **9 Kristen Court** CITY: **Hamburg** COUNTY: **Sussex** STATE: **NJ** ZIP CODE: **07419** PHONE (AREA CODE, NO. EXTENSION): **201 - 681 - 3551**

# Sample Certificate of Employee Information Report



**VOID**

Certification \_\_\_\_\_  
**CERTIFICATE OF EMPLOYEE INFORMATION REPORT**

This is to certify that the contractor herein has made known to the State of New Jersey the information required by the provisions of the Act, and that the State of New Jersey has approved this report. This approval will remain in effect for the period of \_\_\_\_\_.

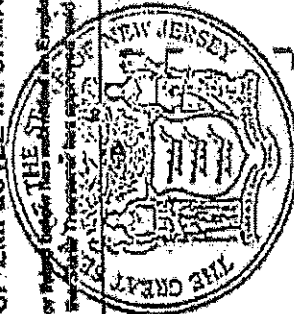

State Treasurer

**VOID**

## Request for Taxpayer Identification Number and Certification

Give Form to the  
requester. Do not  
send to the IRS.

▶ Go to [www.irs.gov/FormW9](http://www.irs.gov/FormW9) for instructions and the latest information.

Print or type. See Specific Instructions on page 3.	1 Name (as shown on your income tax return). Name is required on this line; do not leave this line blank. <b>FC3 Architecture + Design</b>	
	2 Business name/disregarded entity name, if different from above	
	3 Check appropriate box for federal tax classification of the person whose name is entered on line 1. Check only one of the following seven boxes. <input checked="" type="checkbox"/> Individual/sole proprietor or single-member LLC <input type="checkbox"/> C Corporation <input type="checkbox"/> S Corporation <input type="checkbox"/> Partnership <input type="checkbox"/> Trust/estate <input type="checkbox"/> Limited liability company. Enter the tax classification (C=C corporation, S=S corporation, P=Partnership) ▶ _____ Note: Check the appropriate box in the line above for the tax classification of the single-member owner. Do not check LLC if the LLC is classified as a single-member LLC that is disregarded from the owner unless the owner of the LLC is another LLC that is not disregarded from the owner for U.S. federal tax purposes. Otherwise, a single-member LLC that is disregarded from the owner should check the appropriate box for the tax classification of its owner. <input type="checkbox"/> Other (see instructions) ▶ _____	
	4 Exemptions (codes apply only to certain entities, not individuals; see instructions on page 3): Exempt payee code (if any) _____ Exemption from FATCA reporting code (if any) _____ <small>Applies to accounts maintained outside the U.S.</small>	
	5 Address (number, street, and apt. or suite no.) See instructions. <b>9 Kristen Court</b>	Requester's name and address (optional)
	6 City, state, and ZIP code <b>Hamburg NJ 07419</b>	
	7 List account number(s) here (optional)	

**Part I Taxpayer Identification Number (TIN)**

Enter your TIN in the appropriate box. The TIN provided must match the name given on line 1 to avoid backup withholding. For individuals, this is generally your social security number (SSN). However, for a resident alien, sole proprietor, or disregarded entity, see the instructions for Part I, later. For other entities, it is your employer identification number (EIN). If you do not have a number, see *How to get a TIN*, later.

**Note:** If the account is in more than one name, see the instructions for line 1. Also see *What Name and Number To Give the Requester* for guidelines on whose number to enter.

<b>Social security number</b>	
[ ] - [ ] - [ ] [ ] [ ] [ ]	
or	
<b>Employer identification number</b>	
20 - 43-9256	

**Part II Certification**

Under penalties of perjury, I certify that:

- The number shown on this form is my correct taxpayer identification number (or I am waiting for a number to be issued to me); and
- I am not subject to backup withholding because: (a) I am exempt from backup withholding, or (b) I have not been notified by the Internal Revenue Service (IRS) that I am subject to backup withholding as a result of a failure to report all interest or dividends, or (c) the IRS has notified me that I am no longer subject to backup withholding; and
- I am a U.S. citizen or other U.S. person (defined below); and
- The FATCA code(s) entered on this form (if any) indicating that I am exempt from FATCA reporting is correct.

**Certification instructions.** You must cross out item 2 above if you have been notified by the IRS that you are currently subject to backup withholding because you have failed to report all interest and dividends on your tax return. For real estate transactions, item 2 does not apply. For mortgage interest paid, acquisition or abandonment of secured property, cancellation of debt, contributions to an individual retirement arrangement (IRA), and generally, payments other than interest and dividends, you are not required to sign the certification, but you must provide your correct TIN. See the instructions for Part II, later.

<b>Sign Here</b>	Signature of U.S. person ▶	Date ▶ <b>1/30/2018</b>
------------------	----------------------------	-------------------------

**General Instructions**

Section references are to the Internal Revenue Code unless otherwise noted.

**Future developments.** For the latest information about developments related to Form W-9 and its instructions, such as legislation enacted after they were published, go to [www.irs.gov/FormW9](http://www.irs.gov/FormW9).

**Purpose of Form**

An individual or entity (Form W-9 requester) who is required to file an information return with the IRS must obtain your correct taxpayer identification number (TIN) which may be your social security number (SSN), individual taxpayer identification number (ITIN), adoption taxpayer identification number (ATIN), or employer identification number (EIN), to report on an information return the amount paid to you, or other amount reportable on an information return. Examples of information returns include, but are not limited to, the following.

- Form 1099-INT (interest earned or paid)
- Form 1099-DIV (dividends, including those from stocks or mutual funds)
- Form 1099-MISC (various types of income, prizes, awards, or gross proceeds)
- Form 1099-B (stock or mutual fund sales and certain other transactions by brokers)
- Form 1099-S (proceeds from real estate transactions)
- Form 1099-K (merchant card and third party network transactions)
- Form 1098 (home mortgage interest), 1098-E (student loan interest), 1098-T (tuition)
- Form 1099-C (canceled debt)
- Form 1099-A (acquisition or abandonment of secured property)

Use Form W-9 only if you are a U.S. person (including a resident alien), to provide your correct TIN.

If you do not return Form W-9 to the requester with a TIN, you might be subject to backup withholding. See What is backup withholding, later.



## Certificate Validation

The certificate number you entered is valid. ANNUAL REPORT FILED ON NIC SYSTEM for FC3 ARCHITECTURE+DESIGN, LLC NJ 10-digit ID 0600254921 was issued on 12/31/2017 using the NICUSA system under certificate number 2305351853. At this date, the entity's status was: ACTIVE

You may validate any certificate that is issued by the Division and that contains a validation number under the printed seal of the State of New Jersey. For validation of a Certificate of Authority you will need to use the Document Locator Number. This application is not available for any certificate which contains a gold embossed seal.

\* Enter the Validation Number shown on the bottom left of the Certificate you are seeking to validate.

[njbgs](#) | [privacy notice](#) | [legal statement](#) | [contact us](#)